

Ergebnis: **207.5** (199)
 Serien: 103.1 104.4
 Zähler: 19 1 0 0 0 0 0 0 0 0
 Innenzehner: 16
 weiteste: 353 (10), 214 (12), 212 (1)
 beste Teiler 41.7 (5.) 54.0 (6.) 66.8 (15.)
 Trefferlage 0.20 mm rechts, 0.09 mm hoch
 Streuwert 1.15, horizontal: 1.34, vertikal: 0.92

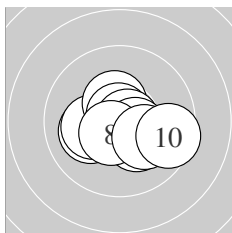

Serie 1:
 10.1 ← 10.2 * 10.4 * 10.3 * 10.8 *
 10.7 * 10.5 * 10.5 * 10.1 ↘ 9.5 →
 beste Teiler 41.7 (5.) 54.0 (6.) 101.0 (8.)
 Trefferlage 0.30 mm rechts, 0.42 mm tief
 Streuwert 1.28, horizontal: 1.64, vertikal: 0.78

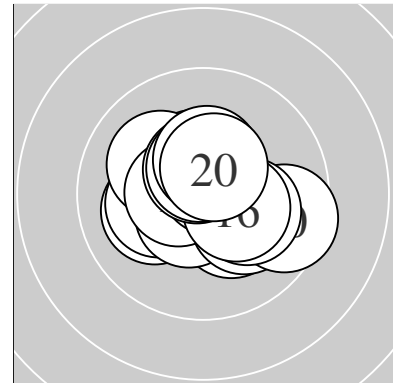
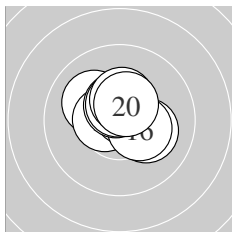

Serie 2:
 10.2 * 10.1 ↖ 10.6 * 10.5 * 10.7 *
 10.4 * 10.5 * 10.5 * 10.4 * 10.5 *
 beste Teiler 66.8 (15.) 95.0 (13.) 103.1 (14.)
 Trefferlage 0.10 mm rechts, 0.60 mm hoch
 Streuwert 0.92, horizontal: 1.05, vertikal: 0.76

Unterschrift des Schützen

Ergebnis: **211.5** (200)
 Serien: 105.5 106.0
 Zähler: 20 0 0 0 0 0 0 0 0 0
 Innenzehner: 18
 weiteste: 226 (19), 212 (9), 181 (16)
 beste Teiler 6.0 (17.) 7.6 (8.) 13.6 (12.)
 Trefferlage 0.30 mm links, 0.18 mm tief
 Streuwert 0.77, horizontal: 0.64, vertikal: 0.89

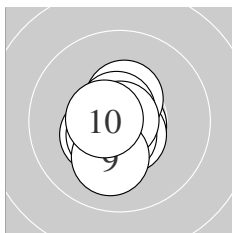
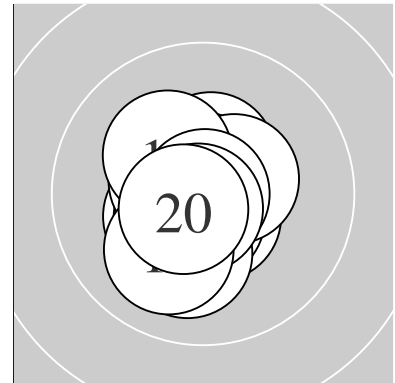

Serie 1:
 10.7 * 10.6 * 10.6 * 10.4 * 10.7 *
 10.4 * 10.5 * 10.9 * 10.1 ↓ 10.6 *
 beste Teiler 7.6 (8.) 53.2 (1.) 65.5 (5.)
 Trefferlage 0.25 mm links, 0.33 mm tief
 Streuwert 0.78, horizontal: 0.59, vertikal: 0.93

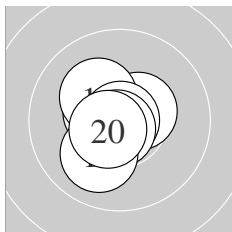

Serie 2:
 10.8 * 10.9 * 10.5 * 10.5 * 10.9 *
 10.2 * 10.9 * 10.7 * 10.0 ✓ 10.6 *
 beste Teiler 6.0 (17.) 13.6 (12.) 25.5 (15.)
 Trefferlage 0.35 mm links, 0.03 mm tief
 Streuwert 0.79, horizontal: 0.70, vertikal: 0.87

Unterschrift des Schützen

Ergebnis: **208.4** (199)
 Serien: 104.8 103.6
 Zähler: 19 1 0 0 0 0 0 0 0 0
 Innenzehner: 18
 weiteste: 293 (13), 232 (11), 194 (19)
 beste Teiler 7.2 (7.) 12.6 (15.) 72.0 (2.)
 Trefferlage 0.10 mm links, 0.58 mm hoch
 Streuwert 1.01, horizontal: 0.82, vertikal: 1.16

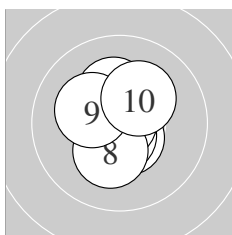
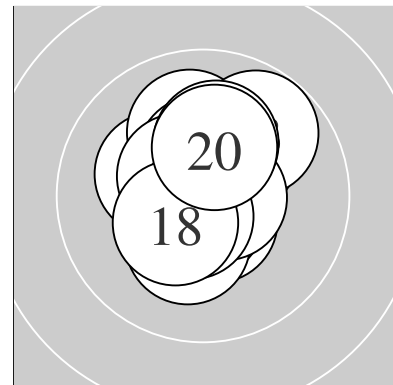

Serie 1:
 10.5 * 10.7 * 10.4 * 10.3 * 10.6 *
 10.7 * 10.9 * 10.3 * 10.2 * 10.2 *
 beste Teiler 7.2 (7.) 72.0 (2.) 73.1 (6.)
 Trefferlage 0.28 mm links, 0.32 mm hoch
 Streuwert 0.95, horizontal: 0.79, vertikal: 1.09

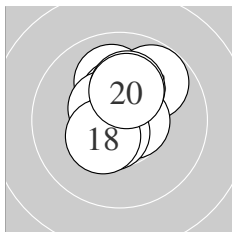

Serie 2:
 10.0 † 10.4 * 9.8 ↗ 10.5 * 10.9 *
 10.6 * 10.6 * 10.4 * 10.2 * 10.2 *
 beste Teiler 12.6 (15.) 76.2 (16.) 86.0 (17.)
 Trefferlage 0.07 mm rechts, 0.84 mm hoch
 Streuwert 1.06, horizontal: 0.86, vertikal: 1.23

Unterschrift des Schützen

Ergebnis: **207.0** (199)
 Serien: 103.7 103.3
 Zähler: 19 1 0 0 0 0 0 0 0 0
 Innenzehner: 16
 weiteste: 288 (20), 232 (1), 211 (11)
 beste Teiler 51.0 (6.) 63.1 (9.) 64.8 (13.)
 Trefferlage 0.24 mm rechts, 0.29 mm hoch
 Streuwert 1.13, horizontal: 0.99, vertikal: 1.26

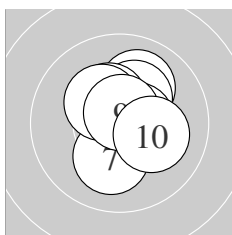
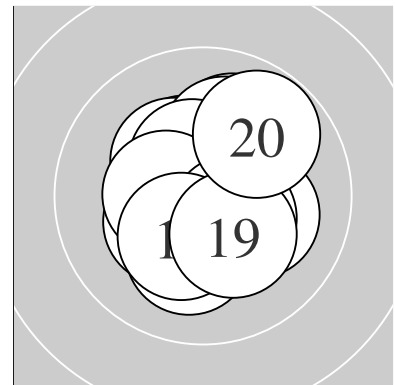

Serie 1:
 10.0 ↗ 10.4 * 10.3 * 10.6 * 10.4 *
 10.7 * 10.1 ↘ 10.3 * 10.7 * 10.2 *
 beste Teiler 51.0 (6.) 63.1 (9.) 97.3 (4.)
 Trefferlage 0.38 mm rechts, 0.55 mm hoch
 Streuwert 1.05, horizontal: 0.89, vertikal: 1.20

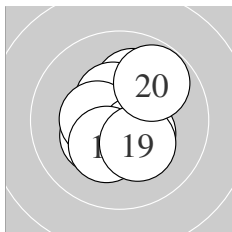

Serie 2:
 10.1 ↗ 10.3 * 10.7 * 10.5 * 10.5 *
 10.4 * 10.4 * 10.3 * 10.3 * 9.8 ↗
 beste Teiler 64.8 (13.) 102.5 (15.) 123.3 (14.)
 Trefferlage 0.11 mm rechts, 0.03 mm hoch
 Streuwert 1.23, horizontal: 1.12, vertikal: 1.33

Unterschrift des Schützen

Ergebnis: **207.1** (197)
 Serien: 104.3 102.8
 Zähler: 17 3 0 0 0 0 0 0 0 0
 Innenzehner: 16
 weiteste: 322 (13), 281 (3), 280 (19)
 beste Teiler 3.1 (8.) 47.0 (16.) 54.0 (11.)
 Trefferlage 0.28 mm links, 0.21 mm hoch
 Streuwert 1.19, horizontal: 1.30, vertikal: 1.08

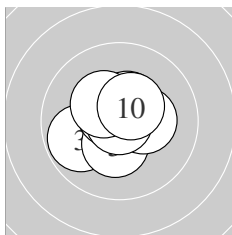
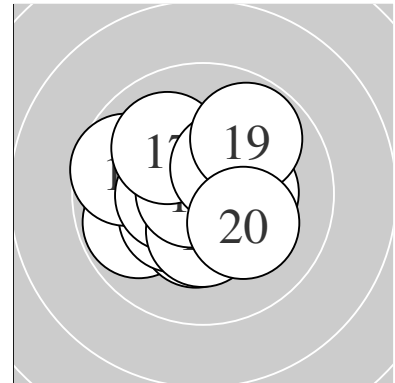

Serie 1:
 10.5 * 10.6 * 9.8 ↙ 10.5 * 10.3 *
 10.3 * 10.6 * 10.9 * 10.3 * 10.5 *
 beste Teiler 3.1 (8.) 79.3 (7.) 79.4 (2.)
 Trefferlage 0.29 mm links, 0.21 mm hoch
 Streuwert 1.03, horizontal: 1.13, vertikal: 0.92

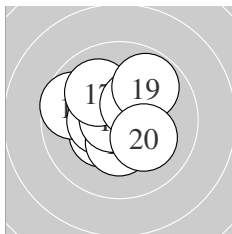

Serie 2:
 10.7 * 10.4 * 9.7 ↖ 10.4 * 10.4 *
 10.8 * 10.0 ↘ 10.4 * 9.8 ↗ 10.2 *
 beste Teiler 47.0 (16.) 54.0 (11.) 128.1 (14.)
 Trefferlage 0.28 mm links, 0.21 mm hoch
 Streuwert 1.39, horizontal: 1.51, vertikal: 1.27

Unterschrift des Schützen

Ergebnis: **208.5** (198)
 Serien: 103.8 104.7
 Zähler: 18 2 0 0 0 0 0 0 0 0
 Innenzehner: 18
 weiteste: 421 (10), 289 (15), 188 (13)
 beste Teiler 23.2 (11.) 50.2 (19.) 57.4 (1.)
 Trefferlage 0.18 mm links, 0.13 mm tief
 Streuwert 1.14, horizontal: 1.38, vertikal: 0.84

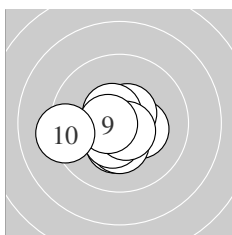
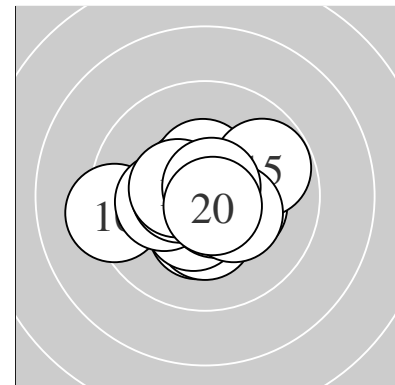

Serie 1:
 10.7 * 10.3 * 10.3 * 10.3 * 10.6 *
 10.4 * 10.6 * 10.7 * 10.6 * 9.3 ←
 beste Teiler 57.4 (1.) 75.9 (8.) 88.2 (9.)
 Trefferlage 0.43 mm links, 0.49 mm tief
 Streuwert 1.20, horizontal: 1.48, vertikal: 0.84

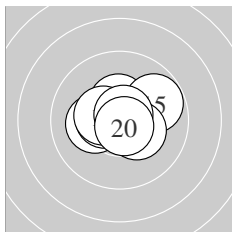

Serie 2:
 10.9 * 10.7 * 10.2 * 10.4 * 9.8 ↗
 10.5 * 10.3 * 10.4 * 10.8 * 10.7 *
 beste Teiler 23.2 (11.) 50.2 (19.) 57.8 (20.)
 Trefferlage 0.05 mm rechts, 0.23 mm hoch
 Streuwert 1.03, horizontal: 1.29, vertikal: 0.68

Unterschrift des Schützen

Ergebnis: **208.7** (198)
 Serien: 104.5 104.2
 Zähler: 18 2 0 0 0 0 0 0 0 0
 Innenzehner: 15
 weiteste: 306 (18), 284 (12), 248 (14)
 beste Teiler 7.0 (20.) 21.0 (17.) 29.0 (2.)
 Trefferlage 0.37 mm links, 0.39 mm hoch
 Streuwert 1.04, horizontal: 1.14, vertikal: 0.92

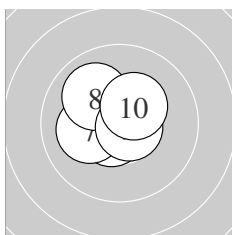
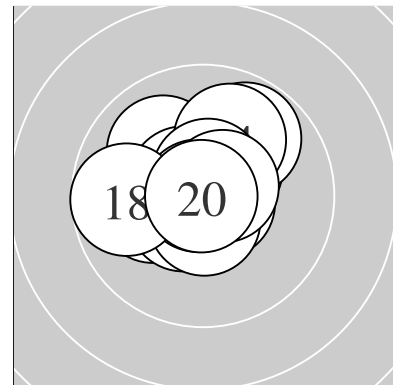

Serie 1:
 10.6 * 10.8 * 10.6 * 10.5 * 10.4 *
 10.4 * 10.1 ← 10.0 ↘ 10.7 * 10.4 *
 beste Teiler 29.0 (2.) 68.5 (9.) 79.5 (3.)
 Trefferlage 0.63 mm links, 0.35 mm hoch
 Streuwert 0.87, horizontal: 0.97, vertikal: 0.76

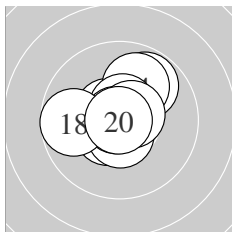

Serie 2:
 10.5 * 9.8 ↗ 10.6 * 10.0 ↗ 10.6 *
 10.6 * 10.9 * 9.7 ← 10.6 * 10.9 *
 beste Teiler 7.0 (20.) 21.0 (17.) 86.3 (16.)
 Trefferlage 0.10 mm links, 0.44 mm hoch
 Streuwert 1.20, horizontal: 1.29, vertikal: 1.10

Unterschrift des Schützen

Ergebnis: **209.0** (199)
 Serien: 104.4 104.6
 Zähler: 19 1 0 0 0 0 0 0 0 0
 Innenzehner: 17
 weiteste: 256 (4), 250 (16), 211 (2)
 beste Teiler 28.8 (1.) 33.3 (19.) 53.8 (6.)
 Trefferlage 0.51 mm links, 0.05 mm hoch
 Streuwert 0.96, horizontal: 1.01, vertikal: 0.91

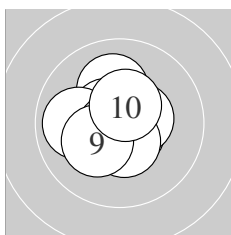
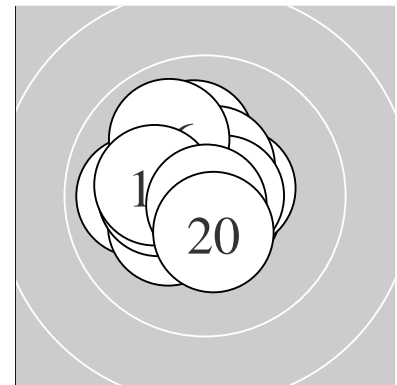

Serie 1:
 10.8 * 10.1 ↑ 10.6 * 9.9 ← 10.6 *
 10.7 * 10.5 * 10.5 * 10.2 * 10.5 *
 beste Teiler 28.8 (1.) 53.8 (6.) 79.2 (5.)
 Trefferlage 0.34 mm links, 0.09 mm hoch
 Streuwert 1.02, horizontal: 1.06, vertikal: 0.98

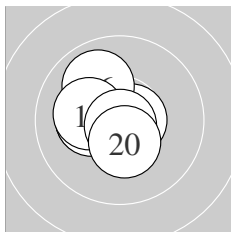

Serie 2:
 10.7 * 10.2 * 10.7 * 10.6 * 10.7 *
 10.0 ↘ 10.3 * 10.2 * 10.8 * 10.4 *
 beste Teiler 33.3 (19.) 63.5 (11.) 67.9 (13.)
 Trefferlage 0.67 mm links, 0.02 mm hoch
 Streuwert 0.93, horizontal: 0.99, vertikal: 0.88

Unterschrift des Schützen

Ergebnis: **206.8** (198)
 Serien: 104.7 102.1
 Zähler: 18 2 0 0 0 0 0 0 0 0
 Innenzehner: 17
 weiteste: 422 (20), 309 (12), 220 (17)
 beste Teiler 33.7 (5.) 70.8 (18.) 74.0 (8.)
 Trefferlage 0.25 mm rechts, 0.21 mm tief
 Streuwert 1.26, horizontal: 1.32, vertikal: 1.21

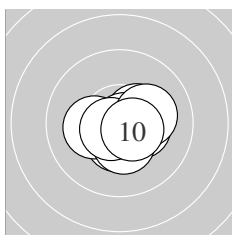
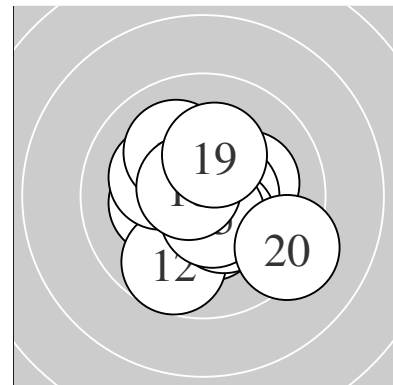

Serie 1:
 10.5 * 10.4 * 10.6 * 10.2 * 10.8 *
 10.4 * 10.4 * 10.7 * 10.2 * 10.5 *
 beste Teiler 33.7 (5.) 74.0 (8.) 82.0 (3.)
 Trefferlage 0.41 mm rechts, 0.34 mm tief
 Streuwert 0.88, horizontal: 1.08, vertikal: 0.63

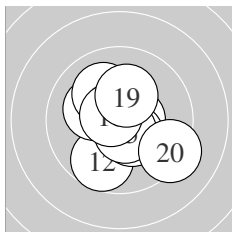

Serie 2:
 10.5 * 9.7 ↙ 10.2 * 10.4 * 10.6 *
 10.4 * 10.1 ↘ 10.7 * 10.2 * 9.3 ↘
 beste Teiler 70.8 (18.) 92.1 (15.) 102.0 (11.)
 Trefferlage 0.09 mm rechts, 0.07 mm tief
 Streuwert 1.60, horizontal: 1.57, vertikal: 1.62

Unterschrift des Schützen

Ergebnis: **208.0** (197)
 Serien: 103.4 104.6
 Zähler: 17 3 0 0 0 0 0 0 0 0
 Innenzehner: 16
 weiteste: 319 (6), 291 (16), 257 (10)
 beste Teiler 40.1 (15.) 41.0 (14.) 42.4 (12.)
 Trefferlage 0.41 mm rechts, 0.09 mm tief
 Streuwert 1.12, horizontal: 1.28, vertikal: 0.92

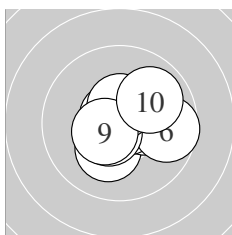
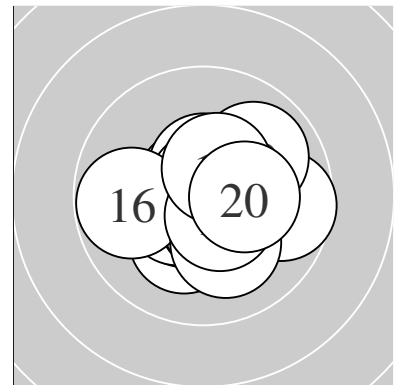

Serie 1:
 10.3 * 10.2 * 10.7 * 10.3 * 10.7 *
 9.7 → 10.6 * 10.5 * 10.5 * 9.9 ↗
 beste Teiler 52.9 (5.) 65.0 (3.) 97.0 (7.)
 Trefferlage 0.57 mm rechts, 0.10 mm hoch
 Streuwert 1.22, horizontal: 1.41, vertikal: 0.98

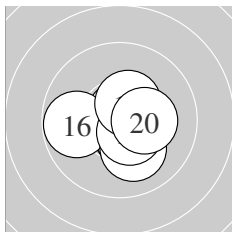

Serie 2:
 10.5 * 10.8 * 10.5 * 10.8 * 10.8 *
 9.8 ← 10.1 ↘ 10.5 * 10.5 * 10.3 *
 beste Teiler 40.1 (15.) 41.0 (14.) 42.4 (12.)
 Trefferlage 0.26 mm rechts, 0.30 mm tief
 Streuwert 1.05, horizontal: 1.20, vertikal: 0.87

Unterschrift des Schützen

Ergebnis: **207.8** (199)
 Serien: 104.1 103.7
 Zähler: 19 1 0 0 0 0 0 0 0 0
 Innenzehner: 18
 weiteste: 301 (12), 225 (16), 198 (3)
 beste Teiler 45.1 (15.) 72.8 (5.) 79.2 (11.)
 Trefferlage 0.02 mm rechts, 0.46 mm hoch
 Streuwert 1.06, horizontal: 1.05, vertikal: 1.06

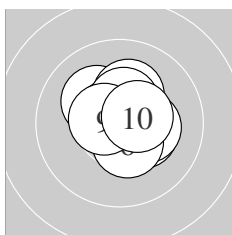
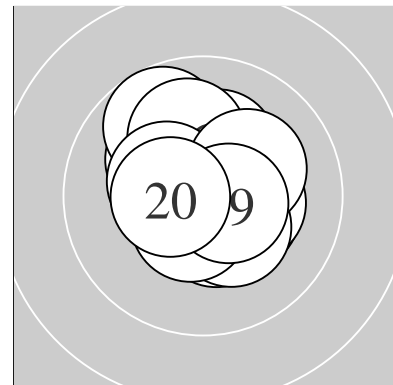

Serie 1:
 10.3 * 10.3 * 10.2 * 10.5 * 10.7 *
 10.4 * 10.2 * 10.4 * 10.6 * 10.5 *
 beste Teiler 72.8 (5.) 99.2 (9.) 103.1 (4.)
 Trefferlage 0.28 mm rechts, 0.45 mm hoch
 Streuwert 0.96, horizontal: 1.00, vertikal: 0.93

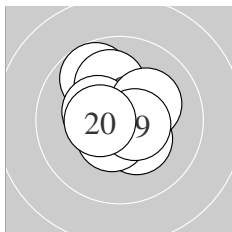

Serie 2:
 10.6 * 9.7 ↘ 10.3 * 10.5 * 10.8 *
 10.1 ↗ 10.4 * 10.2 * 10.6 * 10.5 *
 beste Teiler 45.1 (15.) 79.2 (11.) 100.0 (19.)
 Trefferlage 0.22 mm links, 0.48 mm hoch
 Streuwert 1.16, horizontal: 1.10, vertikal: 1.22

Unterschrift des Schützen

Ergebnis: **209.5** (199)
 Serien: 103.4 106.1
 Zähler: 19 1 0 0 0 0 0 0 0 0
 Innenzehner: 18
 weiteste: 254 (1), 234 (3), 187 (19)
 beste Teiler 7.6 (12.) 41.1 (20.) 46.0 (13.)
 Trefferlage 0.07 mm rechts, 0.12 mm hoch
 Streuwert 0.97, horizontal: 0.91, vertikal: 1.04

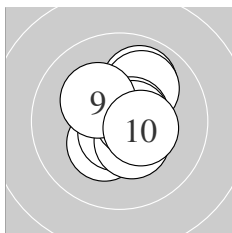
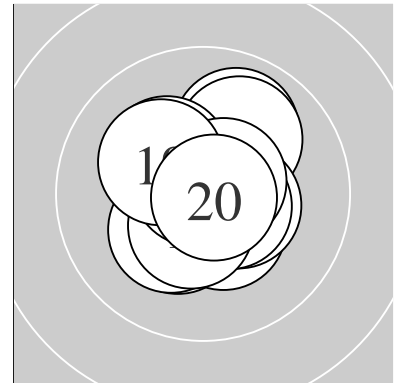

Serie 1:
 9.9 ↗ 10.3 * 10.0 ↗ 10.6 * 10.3 *
 10.7 * 10.4 * 10.6 * 10.2 * 10.4 *
 beste Teiler 74.0 (6.) 76.9 (8.) 79.2 (4.)
 Trefferlage 0.22 mm rechts, 0.35 mm hoch
 Streuwert 1.16, horizontal: 1.04, vertikal: 1.27

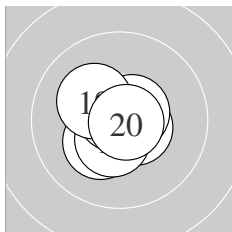

Serie 2:
 10.5 * 10.9 * 10.8 * 10.3 * 10.5 *
 10.7 * 10.8 * 10.6 * 10.2 * 10.8 *
 beste Teiler 7.6 (12.) 41.1 (20.) 46.0 (13.)
 Trefferlage 0.08 mm links, 0.10 mm tief
 Streuwert 0.76, horizontal: 0.78, vertikal: 0.75

Unterschrift des Schützen

Ergebnis: **210.0** (198)
 Serien: 105.6 104.4
 Zähler: 18 2 0 0 0 0 0 0 0 0
 Innenzehner: 18
 weiteste: 270 (14), 254 (4), 169 (17)
 beste Teiler 54.7 (9.) 55.0 (16.) 61.8 (5.)
 Trefferlage 0.22 mm rechts, 0.16 mm hoch
 Streuwert 0.89, horizontal: 0.78, vertikal: 0.99

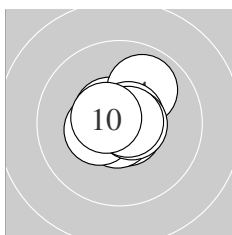
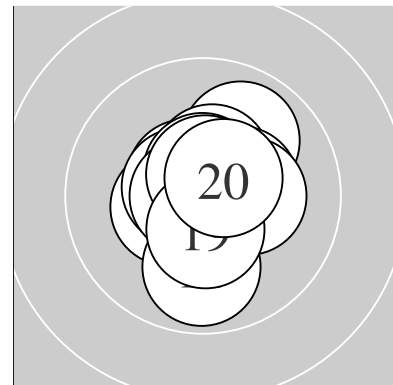

Serie 1:
 10.7 * 10.7 * 10.6 * 9.9 ↗ 10.7 *
 10.7 * 10.4 * 10.6 * 10.7 * 10.6 *
 beste Teiler 54.7 (9.) 61.8 (5.) 65.0 (1.)
 Trefferlage 0.02 mm rechts, 0.25 mm hoch
 Streuwert 0.82, horizontal: 0.85, vertikal: 0.78

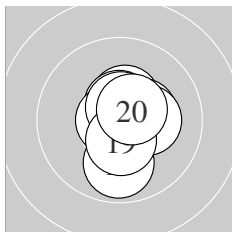

Serie 2:
 10.4 * 10.4 * 10.6 * 9.9 ↓ 10.6 *
 10.7 * 10.3 * 10.6 * 10.4 * 10.5 *
 beste Teiler 55.0 (16.) 80.6 (15.) 82.3 (18.)
 Trefferlage 0.42 mm rechts, 0.07 mm hoch
 Streuwert 0.98, horizontal: 0.69, vertikal: 1.20

Unterschrift des Schützen

Ergebnis: **209.6** (200)
 Serien: 104.5 105.1
 Zähler: 20 0 0 0 0 0 0 0 0 0
 Innenzehner: 18
 weiteste: 222 (4), 207 (6), 200 (12)
 beste Teiler 44.5 (9.) 54.0 (16.) 54.5 (5.)
 Trefferlage 0.03 mm rechts, 0.02 mm tief
 Streuwert 0.93, horizontal: 0.90, vertikal: 0.96

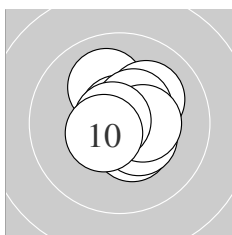
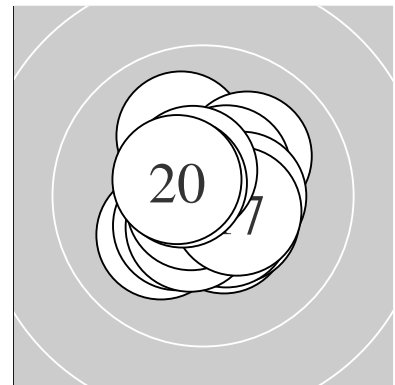

Serie 1:
 10.4 * 10.4 * 10.6 * 10.1 † 10.7 *
 10.1 † 10.5 * 10.4 * 10.8 * 10.5 *
 beste Teiler 44.5 (9.) 54.5 (5.) 91.4 (3.)
 Trefferlage 0.34 mm rechts, 0.34 mm hoch
 Streuwert 0.95, horizontal: 0.88, vertikal: 1.02

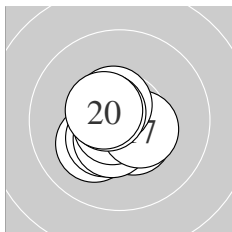

Serie 2:
 10.7 * 10.2 * 10.4 * 10.5 * 10.5 *
 10.7 * 10.4 * 10.6 * 10.6 * 10.5 *
 beste Teiler 54.0 (16.) 72.6 (11.) 84.9 (19.)
 Trefferlage 0.28 mm links, 0.39 mm tief
 Streuwert 0.81, horizontal: 0.83, vertikal: 0.78

Unterschrift des Schützen

Ergebnis: **208.7** (200)
 Serien: 104.2 104.5
 Zähler: 20 0 0 0 0 0 0 0 0 0
 Innenzehner: 17
 weiteste: 245 (11), 239 (10), 221 (5)
 beste Teiler 37.1 (9.) 41.2 (13.) 67.0 (6.)
 Trefferlage 0.32 mm rechts, 0.38 mm hoch
 Streuwert 0.98, horizontal: 1.09, vertikal: 0.86

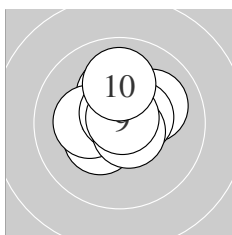
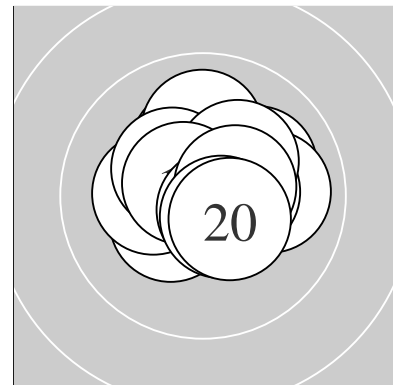

Serie 1:
 10.4 * 10.2 * 10.6 * 10.2 * 10.1 ↗
 10.7 * 10.5 * 10.7 * 10.8 * 10.0 ↑
 beste Teiler 37.1 (9.) 67.0 (6.) 75.7 (8.)
 Trefferlage 0.01 mm links, 0.60 mm hoch
 Streuwert 1.03, horizontal: 1.07, vertikal: 0.98

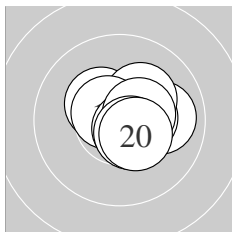

Serie 2:
 10.0 → 10.4 * 10.8 * 10.4 * 10.2 *
 10.6 * 10.7 * 10.5 * 10.5 * 10.4 *
 beste Teiler 41.2 (13.) 74.2 (17.) 86.8 (16.)
 Trefferlage 0.67 mm rechts, 0.16 mm hoch
 Streuwert 0.89, horizontal: 1.04, vertikal: 0.71

Unterschrift des Schützen

Ergebnis: **209.0** (199)
 Serien: 105.3 103.7
 Zähler: 19 1 0 0 0 0 0 0 0 0
 Innenzehner: 18
 weiteste: 266 (1), 240 (12), 198 (20)
 beste Teiler 18.4 (7.) 35.4 (3.) 42.0 (19.)
 Trefferlage 0.01 mm rechts, 0.09 mm tief
 Streuwert 1.05, horizontal: 1.03, vertikal: 1.06

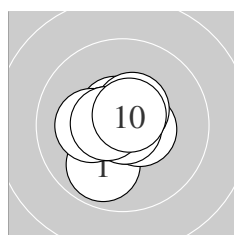
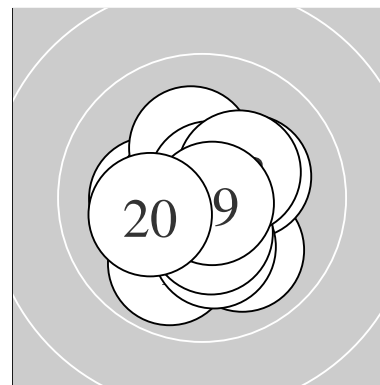

Serie 1:
 9.9 ↙ 10.6 * 10.8 * 10.5 * 10.6 *
 10.2 * 10.9 * 10.5 * 10.6 * 10.7 *
 beste Teiler 18.4 (7.) 35.4 (3.) 72.9 (10.)
 Trefferlage 0.29 mm links, 0.04 mm tief
 Streuwert 0.92, horizontal: 0.93, vertikal: 0.92

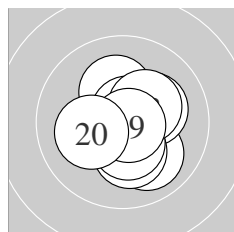

Serie 2:
 10.7 * 10.0 ↘ 10.2 * 10.2 * 10.2 *
 10.4 * 10.7 * 10.3 * 10.8 * 10.2 *
 beste Teiler 42.0 (19.) 62.0 (11.) 62.6 (17.)
 Trefferlage 0.31 mm rechts, 0.14 mm tief
 Streuwert 1.16, horizontal: 1.09, vertikal: 1.24

Unterschrift des Schützen