

Ergebnis: **405.7** (390)
 Serien: 99.4 103.2 101.0 102.1
 Zähler: 30 10 0 0 0 0 0 0 0 0
 Innenzehner: 24
 weiteste: 470 (8), 391 (2), 377 (29)
 beste Teiler 75.1 (24.) 90.8 (33.) 97.0 (17.)
 Trefferlage 0.30 mm links, 0.42 mm hoch
 Streuwert 1.55, horizontal: 1.84, vertikal: 1.20

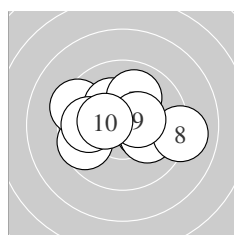

Serie 1:
 9.6 ↙ 9.4 ↖ 10.3 * 10.1 ↘ 10.2 *
 9.9 ← 10.0 ↑ 9.1 → 10.4 * 10.4 *
 beste Teiler 131.9 (9.) 146.5 (10.) 173.6 (3.)
 Trefferlage 0.12 mm links, 0.28 mm hoch
 Streuwert 2.05, horizontal: 2.65, vertikal: 1.16

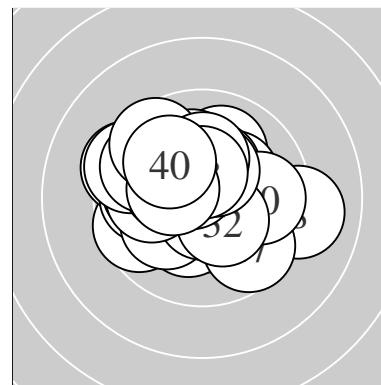
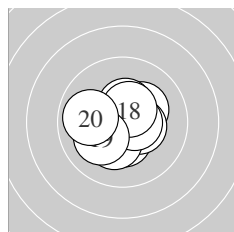

Serie 2:
 10.2 * 10.4 * 10.4 * 10.4 * 10.4 *
 10.3 * 10.6 * 10.5 * 10.1 ↙ 9.9 ←
 beste Teiler 97.0 (17.) 115.3 (18.) 130.8 (14.)
 Trefferlage 0.12 mm links, 0.17 mm tief
 Streuwert 1.21, horizontal: 1.33, vertikal: 1.08

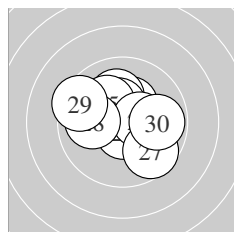

Serie 3:
 10.3 * 10.1 ↑ 10.4 * 10.7 * 10.2 *
 10.4 * 9.7 ↘ 10.0 ← 9.4 ↖ 9.8 →
 beste Teiler 75.1 (24.) 136.3 (23.) 138.1 (26.)
 Trefferlage 0.09 mm links, 0.50 mm hoch
 Streuwert 1.68, horizontal: 1.96, vertikal: 1.33

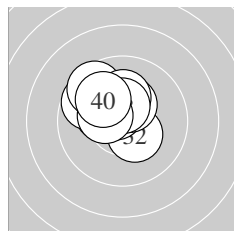

Serie 4:
 10.3 * 10.4 * 10.6 * 10.4 * 9.7 ↖
 9.6 ↘ 10.2 * 10.5 * 10.4 * 10.0 ↘
 beste Teiler 90.8 (33.) 123.0 (38.) 143.5 (34.)
 Trefferlage 0.85 mm links, 1.10 mm hoch
 Streuwert 1.12, horizontal: 1.23, vertikal: 1.00

Unterschrift des Schützen

Meyton Elektronik

Ergebnis: **404.3** (387)
 Serien: 100.2 102.1 100.9 101.1
 Zähler: 28 11 1 0 0 0 0 0 0 0
 Innenzehner: 21
 weiteste: 501 (34), 462 (9), 458 (23)
 beste Teiler 12.0 (39.) 37.0 (32.) 39.0 (24.)
 Trefferlage 0.18 mm links, 0.10 mm tief
 Streuwert 1.80, horizontal: 2.09, vertikal: 1.45

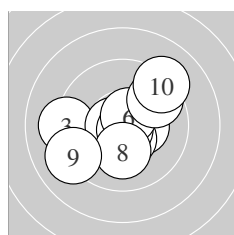
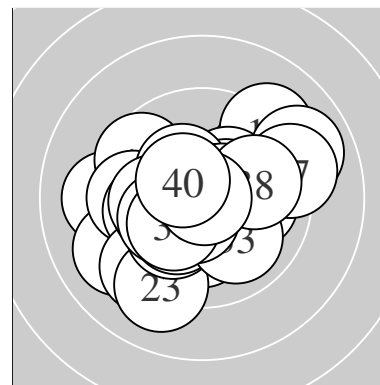

Serie 1:
 10.4 * 10.5 * 9.2 ← 10.7 * 10.8 *
 10.6 * 9.6 ↗ 10.1 ↓ 9.1 ↙ 9.2 ↗
 beste Teiler 40.7 (5.) 74.0 (4.) 87.3 (6.)
 Trefferlage 0.08 mm links, 0.00 mm
 Streuwert 2.12, horizontal: 2.46, vertikal: 1.72

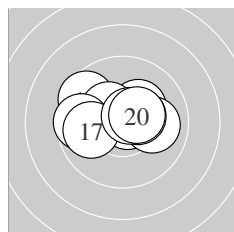

Serie 2:
 9.6 ↘ 10.8 * 10.3 * 10.4 * 10.0 →
 9.6 ← 9.9 ← 10.4 * 10.7 * 10.4 *
 beste Teiler 40.6 (12.) 74.3 (19.) 127.0 (20.)
 Trefferlage 0.28 mm links, 0.47 mm hoch
 Streuwert 1.50, horizontal: 2.00, vertikal: 0.71

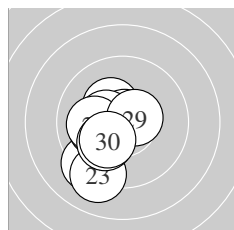

Serie 3:
 10.3 * 9.3 ↙ 9.1 ↙ 10.8 * 10.1 ←
 10.4 * 10.1 ← 10.1 ↙ 10.5 * 10.2 *
 beste Teiler 39.0 (24.) 103.1 (29.) 135.3 (26.)
 Trefferlage 1.26 mm links, 0.88 mm tief
 Streuwert 1.45, horizontal: 1.11, vertikal: 1.73

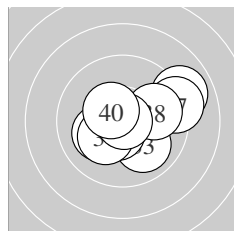

Serie 4:
 10.1 ↙ 10.8 * 10.0 ↘ 8.9 → 10.6 *
 10.2 * 9.2 → 9.9 → 10.9 * 10.5 *
 beste Teiler 12.0 (39.) 37.0 (32.) 99.2 (35.)
 Trefferlage 0.88 mm rechts, 0.00 mm
 Streuwert 1.82, horizontal: 2.25, vertikal: 1.26

Unterschrift des Schützen

Meyton Elektronik

Ergebnis: **414.1** (395)
 Serien: 102.5 103.3 103.0 105.3
 Zähler: 35 5 0 0 0 0 0 0 0 0
 Innenzehner: 30
 weiteste: 340 (26), 302 (7), 291 (17)
 beste Teiler 5.8 (35.) 48.3 (32.) 50.3 (2.)
 Trefferlage 0.06 mm rechts, 0.23 mm hoch
 Streuwert 1.20, horizontal: 1.16, vertikal: 1.24

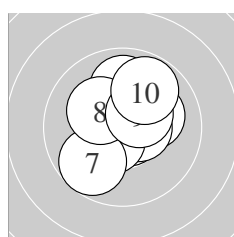
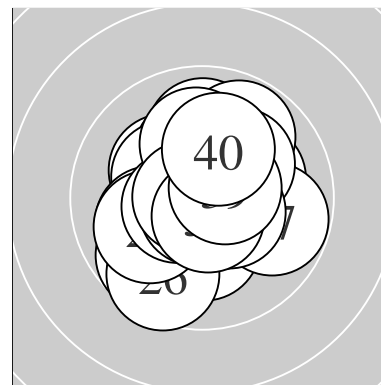

Serie 1:
 10.1 → 10.8 * 10.6 * 10.5 * 10.5 *
 9.9 ↑ 9.7 ↙ 10.2 * 10.4 * 9.8 ↗
 beste Teiler 50.3 (2.) 87.0 (3.) 104.0 (4.)
 Trefferlage 0.08 mm rechts, 0.41 mm hoch
 Streuwert 1.39, horizontal: 1.31, vertikal: 1.46

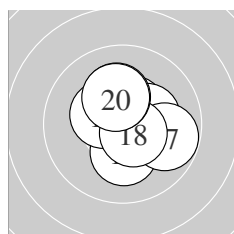

Serie 2:
 10.5 * 10.7 * 10.4 * 10.3 * 10.2 *
 10.4 * 9.8 → 10.6 * 10.2 * 10.2 *
 beste Teiler 55.6 (12.) 92.3 (18.) 115.6 (11.)
 Trefferlage 0.47 mm rechts, 0.32 mm hoch
 Streuwert 1.17, horizontal: 1.20, vertikal: 1.14

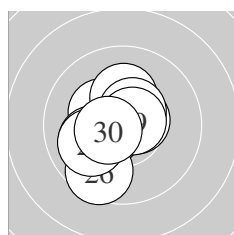

Serie 3:
 10.3 * 10.2 * 10.6 * 10.5 * 10.5 *
 9.6 ↙ 10.1 ← 10.0 ↙ 10.7 * 10.5 *
 beste Teiler 70.3 (29.) 95.8 (23.) 101.8 (30.)
 Trefferlage 0.67 mm links, 0.18 mm tief
 Streuwert 1.26, horizontal: 1.14, vertikal: 1.36

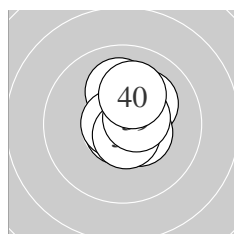

Serie 4:
 10.1 ↑ 10.8 * 10.2 * 10.7 * 10.9 *
 10.5 * 10.7 * 10.7 * 10.6 * 10.1 ↗
 beste Teiler 5.8 (35.) 48.3 (32.) 51.4 (34.)
 Trefferlage 0.36 mm rechts, 0.39 mm hoch
 Streuwert 0.87, horizontal: 0.65, vertikal: 1.05

Unterschrift des Schützen

Meyton Elektronik

Ergebnis: **390.7** (371)
 Serien: 99.7 96.3 98.9 95.8
 Zähler: 19 15 4 2 0 0 0 0 0 0
 Innenzehner: 12
 weiteste: 818 (38), 805 (32), 722 (11)
 beste Teiler 61.0 (37.) 92.3 (33.) 101.5 (3.)
 Trefferlage 0.16 mm links, 0.39 mm hoch
 Streuwert 2.46, horizontal: 2.90, vertikal: 1.92

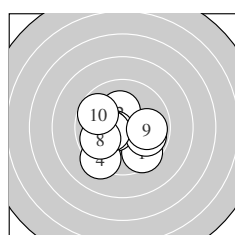
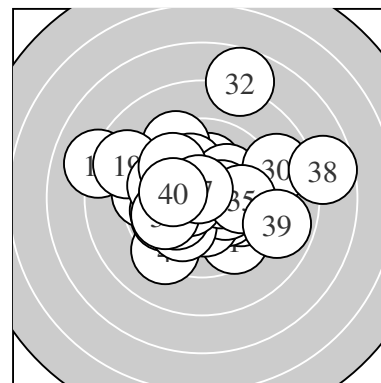

Serie 1:
 9.6 ↘ 10.2 * 10.5 * 9.3 ↙ 9.9 →
 10.3 * 10.4 * 9.9 ↙ 9.9 → 9.7 ↖
 beste Teiler 101.5 (3.) 146.7 (7.) 165.6 (6.)
 Trefferlage 0.44 mm links, 0.65 mm tief
 Streuwert 1.89, horizontal: 2.14, vertikal: 1.61

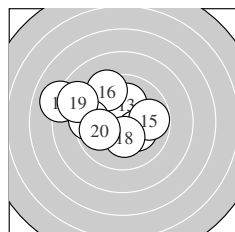

Serie 2:
 8.1 ↖ 10.2 * 10.1 ↑ 10.2 * 9.8 →
 9.4 ↘ 9.5 ← 10.3 * 8.8 ↖ 9.9 ←
 beste Teiler 163.2 (18.) 181.7 (14.) 183.0 (12.)
 Trefferlage 1.53 mm links, 0.88 mm hoch
 Streuwert 2.45, horizontal: 3.03, vertikal: 1.69

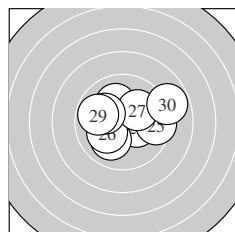

Serie 3:
 10.3 * 10.0 ↙ 10.1 ↘ 10.1 ↖ 9.5 →
 10.1 ↙ 10.1 ↗ 10.1 ↖ 9.8 ↖ 8.8 →
 beste Teiler 162.5 (21.) 206.6 (26.) 209.1 (27.)
 Trefferlage 0.13 mm rechts, 0.40 mm hoch
 Streuwert 2.09, horizontal: 2.64, vertikal: 1.32

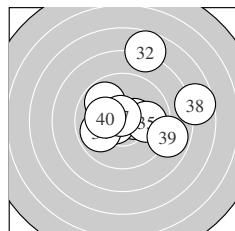

Serie 4:
 10.4 * 7.7 ↑ 10.6 * 9.9 ↙ 9.9 →
 9.8 ↘ 10.7 * 7.7 → 8.9 → 10.2 *
 beste Teiler 61.0 (37.) 92.3 (33.) 129.2 (31.)
 Trefferlage 1.19 mm rechts, 0.95 mm hoch
 Streuwert 3.02, horizontal: 3.38, vertikal: 2.62

Unterschrift des Schützen

Meyton Elektronik

Ergebnis: **406.2** (387)
 Serien: 100.3 101.8 101.7 102.4
 Zähler: 28 11 1 0 0 0 0 0 0 0
 Innenzehner: 25
 weiteste: 513 (3), 499 (35), 331 (5)
 beste Teiler 50.8 (2.) 60.8 (14.) 64.0 (39.)
 Trefferlage 0.08 mm links, 0.72 mm hoch
 Streuwert 1.52, horizontal: 1.61, vertikal: 1.43

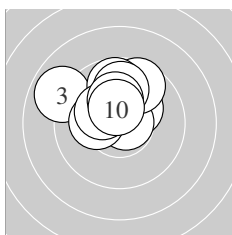
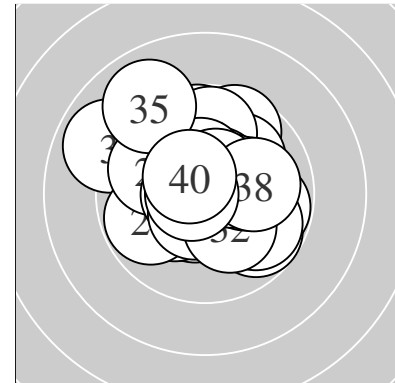

Serie 1:
 10.3 * 10.8 * 8.9 ↘ 10.2 * 9.6 ↗
 9.7 ↑ 10.3 * 9.9 ↑ 10.2 * 10.4 *
 beste Teiler 50.8 (2.) 128.8 (10.) 165.8 (7.)
 Trefferlage 0.55 mm links, 1.64 mm hoch
 Streuwert 1.46, horizontal: 1.75, vertikal: 1.10

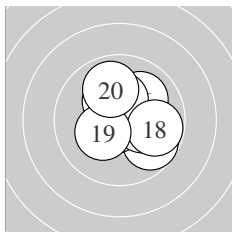

Serie 2:
 9.7 ↘ 10.3 * 10.6 * 10.7 * 10.2 *
 10.0 ↗ 10.3 * 9.8 → 10.3 * 9.9 ↑
 beste Teiler 60.8 (14.) 93.9 (13.) 162.0 (17.)
 Trefferlage 0.64 mm rechts, 0.32 mm hoch
 Streuwert 1.44, horizontal: 1.48, vertikal: 1.39

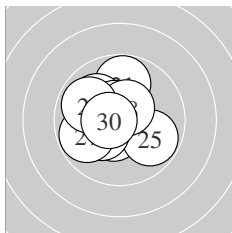

Serie 3:
 9.8 ↑ 10.5 * 10.0 ↘ 10.5 * 9.8 ↘
 10.3 * 9.8 ← 10.5 * 9.9 ↘ 10.6 *
 beste Teiler 85.0 (30.) 101.2 (24.) 112.3 (28.)
 Trefferlage 0.67 mm links, 0.28 mm hoch
 Streuwert 1.48, horizontal: 1.52, vertikal: 1.43

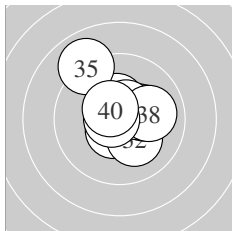

Serie 4:
 10.5 * 10.2 * 10.2 * 10.4 * 9.0 ↘
 10.4 * 10.5 * 10.0 → 10.7 * 10.5 *
 beste Teiler 64.0 (39.) 102.5 (37.) 103.8 (31.)
 Trefferlage 0.24 mm rechts, 0.64 mm hoch
 Streuwert 1.52, horizontal: 1.50, vertikal: 1.53

Unterschrift des Schützen

Meyton Elektronik

Ergebnis: **415.5** (395)
 Serien: 104.7 102.9 104.4 103.5
 Zähler: 35 5 0 0 0 0 0 0 0 0
 Innenzehner: 29
 weiteste: 297 (5), 279 (31), 278 (33)
 beste Teiler 0.0 (8.) 11.4 (40.) 31.5 (36.)
 Trefferlage 0.29 mm rechts, 0.13 mm hoch
 Streuwert 1.15, horizontal: 1.32, vertikal: 0.95

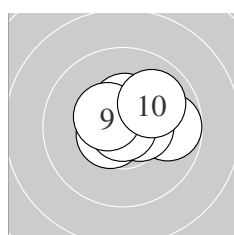
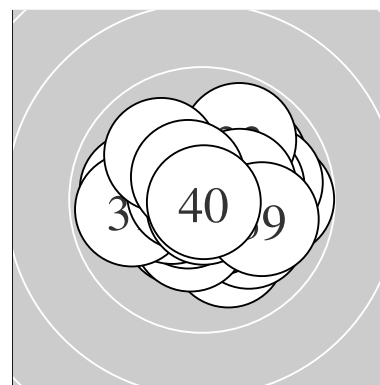

Serie 1:
 10.6 * 10.4 * 10.8 * 10.6 * 9.8 →
 10.6 * 10.5 * 10.9 * 10.5 * 10.0 ↗
 beste Teiler 0.0 (8.) 43.2 (3.) 89.3 (6.)
 Trefferlage 0.62 mm rechts, 0.39 mm hoch
 Streuwert 0.96, horizontal: 1.21, vertikal: 0.63

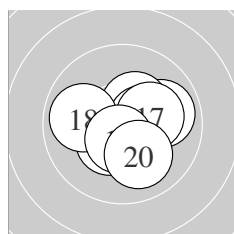

Serie 2:
 10.5 * 9.9 → 10.4 * 10.4 * 10.6 *
 10.4 * 10.2 * 9.9 ← 10.5 * 10.1 ↓
 beste Teiler 82.2 (15.) 101.8 (19.) 121.6 (11.)
 Trefferlage 0.54 mm rechts, 0.20 mm tief
 Streuwert 1.25, horizontal: 1.45, vertikal: 1.01

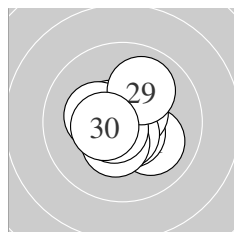

Serie 3:
 10.1 ↘ 10.6 * 10.6 * 10.6 * 10.6 *
 10.4 * 10.7 * 10.3 * 10.0 ↗ 10.5 *
 beste Teiler 71.7 (27.) 81.0 (25.) 92.6 (23.)
 Trefferlage 0.00 mm , 0.13 mm tief
 Streuwert 1.08, horizontal: 1.11, vertikal: 1.04

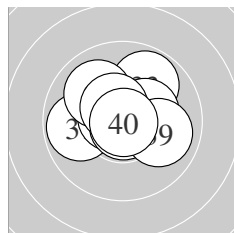

Serie 4:
 9.8 ← 10.6 * 9.8 ↗ 10.8 * 10.0 ↖
 10.8 * 10.3 * 10.5 * 10.0 → 10.9 *
 beste Teiler 11.4 (40.) 31.5 (36.) 50.9 (34.)
 Trefferlage 0.01 mm rechts, 0.47 mm hoch
 Streuwert 1.29, horizontal: 1.53, vertikal: 0.99

Unterschrift des Schützen

Ergebnis: **374.8** (355)
 Serien: 91.2 97.3 93.2 93.1
 Zähler: 7 23 8 2 0 0 0 0 0 0
 Innenzehner: 5
 weiteste: 902 (21), 840 (10), 677 (5)
 beste Teiler 34.0 (36.) 95.0 (18.) 112.9 (12.)
 Trefferlage 0.63 mm links, 0.17 mm tief
 Streuwert 3.08, horizontal: 3.68, vertikal: 2.33

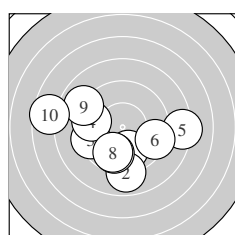
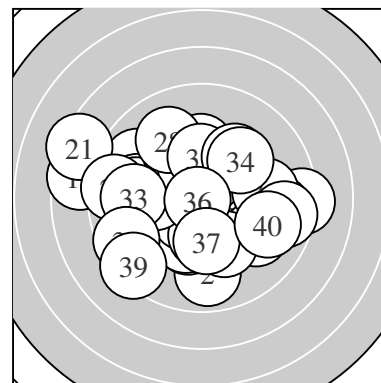

Serie 1:
 9.9 ↓ 8.9 ↓ 9.4 ← 9.5 ← 8.2 →
 9.4 → 9.7 ↓ 9.7 ↓ 8.9 ↖ 7.6 ←
 beste Teiler 267.7 (1.) 304.9 (8.) 310.5 (7.)
 Trefferlage 1.04 mm links, 1.18 mm tief
 Streuwert 3.43, horizontal: 4.28, vertikal: 2.30

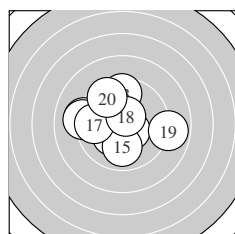

Serie 2:
 9.2 ← 10.5 * 9.6 ↑ 10.2 * 9.9 ↓
 9.1 ← 9.7 ← 10.6 * 8.9 → 9.6 ↘
 beste Teiler 95.0 (18.) 112.9 (12.) 177.0 (14.)
 Trefferlage 0.87 mm links, 0.33 mm hoch
 Streuwert 2.41, horizontal: 2.87, vertikal: 1.85

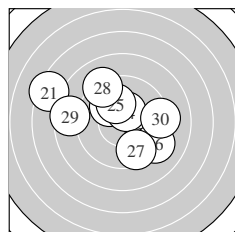

Serie 3:
 7.3 ↖ 10.0 ↘ 9.8 → 10.4 * 10.1 ↗
 9.2 ↘ 9.6 ↓ 9.1 ↘ 8.5 ← 9.2 →
 beste Teiler 126.1 (24.) 221.4 (25.) 230.4 (22.)
 Trefferlage 0.63 mm links, 0.68 mm hoch
 Streuwert 3.33, horizontal: 4.08, vertikal: 2.34

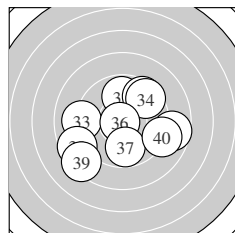

Serie 4:
 9.8 ↑ 9.5 ↗ 9.1 ← 9.5 ↗ 8.7 →
 10.8 * 9.8 ↓ 8.6 ← 8.3 ↘ 9.0 →
 beste Teiler 34.0 (36.) 279.1 (31.) 294.5 (37.)
 Trefferlage 0.03 mm rechts, 0.52 mm tief
 Streuwert 3.29, horizontal: 3.84, vertikal: 2.62

Unterschrift des Schützen

Meyton Elektronik

Ergebnis: **387.6** (372)
 Serien: 96.5 94.1 96.3 100.7
 Zähler: 19 16 3 2 0 0 0 0 0 0
 Innenzehner: 12
 weiteste: 896 (24), 818 (16), 717 (3)
 beste Teiler 47.4 (9.) 90.2 (40.) 98.0 (34.)
 Trefferlage 0.53 mm rechts, 0.02 mm hoch
 Streuwert 2.67, horizontal: 3.02, vertikal: 2.27

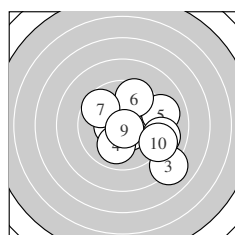
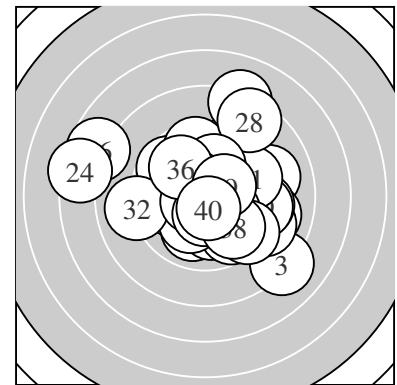

Serie 1:
 10.5 * 10.5 * 8.1 ↘ 10.0 ↓ 9.1 →
 9.6 ↗ 9.7 ↖ 9.1 → 10.8 * 9.1 →
 beste Teiler 47.4 (9.) 106.1 (2.) 112.7 (1.)
 Trefferlage 1.64 mm rechts, 0.51 mm tief
 Streuwert 2.56, horizontal: 2.80, vertikal: 2.29

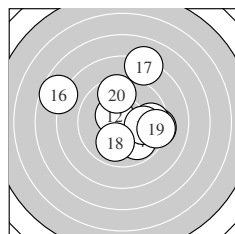

Serie 2:
 9.3 → 10.5 * 9.6 → 9.9 ↘ 10.0 →
 7.7 ↖ 8.1 ↗ 10.0 ↓ 9.4 → 9.6 ↑
 beste Teiler 124.3 (12.) 246.7 (15.) 248.7 (18.)
 Trefferlage 0.78 mm rechts, 0.77 mm hoch
 Streuwert 3.17, horizontal: 3.50, vertikal: 2.81

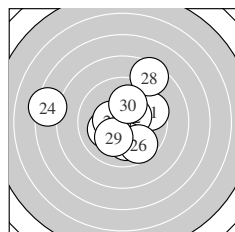

Serie 3:
 9.6 → 10.4 * 10.1 ← 7.4 ← 10.0 ↓
 9.7 ↘ 10.4 * 8.5 ↗ 10.1 ↓ 10.1 ↑
 beste Teiler 130.0 (27.) 134.9 (22.) 205.2 (29.)
 Trefferlage 0.26 mm links, 0.39 mm hoch
 Streuwert 2.98, horizontal: 3.47, vertikal: 2.40

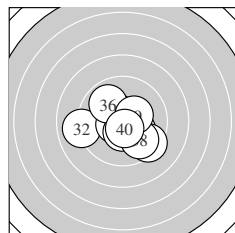

Serie 4:
 10.2 * 9.0 ← 10.4 * 10.6 * 10.4 *
 9.9 ↘ 9.4 ↘ 9.8 ↘ 10.4 * 10.6 *
 beste Teiler 90.2 (40.) 98.0 (34.) 128.0 (35.)
 Trefferlage 0.01 mm links, 0.54 mm tief
 Streuwert 1.87, horizontal: 2.23, vertikal: 1.42

Unterschrift des Schützen

Meyton Elektronik

Ergebnis: **397.6** (380)
 Serien: 98.2 99.6 100.7 99.1
 Zähler: 22 16 2 0 0 0 0 0 0 0
 Innenzehner: 13
 weiteste: 604 (39), 537 (6), 450 (17)
 beste Teiler 48.0 (31.) 59.3 (29.) 90.9 (27.)
 Trefferlage 0.16 mm rechts, 0.03 mm hoch
 Streuwert 2.00, horizontal: 2.45, vertikal: 1.41

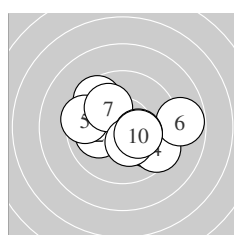
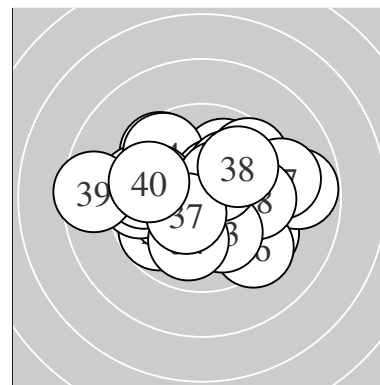

Serie 1:
 9.8 ↘ 10.0 ← 9.6 ↘ 9.5 ↘ 9.5 ←
 8.8 → 10.1 ↘ 10.3 * 10.3 * 10.3 *
 beste Teiler 151.7 (9.) 155.4 (8.) 158.4 (10.)
 Trefferlage 0.50 mm rechts, 0.10 mm tief
 Streuwert 2.24, horizontal: 2.80, vertikal: 1.47

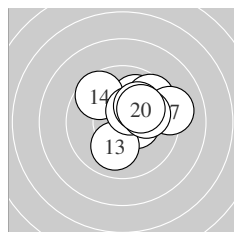

Serie 2:
 10.0 ↗ 10.5 * 10.0 ↓ 9.6 ↘ 10.5 *
 9.6 ↗ 9.2 → 10.1 ↗ 10.0 → 10.1 ↗
 beste Teiler 122.9 (12.) 125.0 (15.) 205.1 (18.)
 Trefferlage 1.24 mm rechts, 1.00 mm hoch
 Streuwert 1.59, horizontal: 1.78, vertikal: 1.38

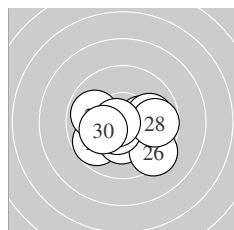

Serie 3:
 9.8 ↙ 10.2 * 9.9 → 9.9 ← 10.3 *
 9.4 ↘ 10.6 * 9.7 → 10.7 * 10.2 *
 beste Teiler 59.3 (29.) 90.9 (27.) 164.1 (25.)
 Trefferlage 0.21 mm rechts, 0.64 mm tief
 Streuwert 1.73, horizontal: 2.17, vertikal: 1.11

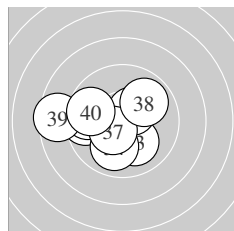

Serie 4:
 10.8 * 9.6 ← 10.1 ↘ 10.0 ↓ 9.6 ←
 10.4 * 10.5 * 9.9 ↗ 8.5 ← 9.7 ←
 beste Teiler 48.0 (31.) 124.4 (37.) 126.6 (36.)
 Trefferlage 1.33 mm links, 0.12 mm tief
 Streuwert 2.00, horizontal: 2.52, vertikal: 1.29

Unterschrift des Schützen

Ergebnis: **393.0** (374)
 Serien: 98.8 98.1 99.5 96.6
 Zähler: 17 20 3 0 0 0 0 0 0 0
 Innenzehner: 12
 weiteste: 543 (39), 538 (15), 529 (26)
 beste Teiler 66.4 (18.) 72.9 (5.) 89.3 (19.)
 Trefferlage 1.11 mm rechts, 0.44 mm hoch
 Streuwert 2.06, horizontal: 2.63, vertikal: 1.27

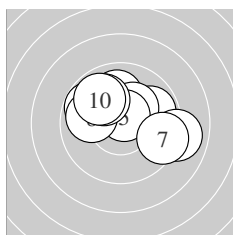
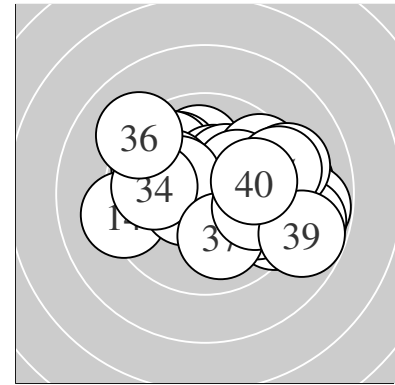

Serie 1:
 10.0 ↑ 9.9 → 9.0 → 10.3 * 10.7 *
 9.8 ↖ 9.4 → 9.9 ← 10.0 ↖ 9.8 ↖
 beste Teiler 72.9 (5.) 168.5 (4.) 239.1 (1.)
 Trefferlage 0.37 mm rechts, 0.90 mm hoch
 Streuwert 2.05, horizontal: 2.62, vertikal: 1.25

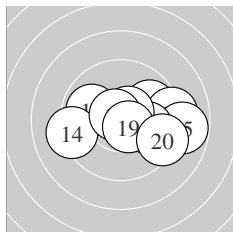

Serie 2:
 9.8 → 9.2 → 9.9 ↖ 9.2 ← 8.8 →
 10.0 → 10.6 * 10.7 * 10.6 * 9.3 →
 beste Teiler 66.4 (18.) 89.3 (19.) 95.5 (17.)
 Trefferlage 1.23 mm rechts, 0.08 mm tief
 Streuwert 2.25, horizontal: 3.03, vertikal: 0.98

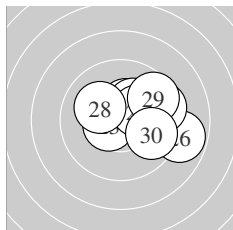

Serie 3:
 10.3 * 10.4 * 10.5 * 10.2 * 10.3 *
 8.8 → 9.5 → 10.1 ↖ 9.6 → 9.8 →
 beste Teiler 112.0 (23.) 141.9 (22.) 161.0 (21.)
 Trefferlage 1.53 mm rechts, 0.58 mm hoch
 Streuwert 1.68, horizontal: 2.08, vertikal: 1.16

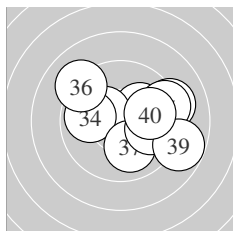

Serie 4:
 10.2 * 10.3 * 9.2 → 9.9 ← 9.3 →
 9.1 ↖ 10.0 ↓ 9.9 → 8.8 → 9.9 →
 beste Teiler 159.7 (32.) 199.4 (31.) 233.4 (37.)
 Trefferlage 1.32 mm rechts, 0.37 mm hoch
 Streuwert 2.37, horizontal: 2.94, vertikal: 1.62

Unterschrift des Schützen

Meyton Elektronik

Ergebnis: **396.1** (378)
 Serien: 98.2 97.7 98.1 102.1
 Zähler: 23 12 5 0 0 0 0 0 0 0
 Innenzehner: 18
 weiteste: 658 (13), 555 (17), 533 (30)
 beste Teiler 36.0 (34.) 70.7 (38.) 75.0 (19.)
 Trefferlage 0.10 mm rechts, 0.43 mm hoch
 Streuwert 2.15, horizontal: 1.75, vertikal: 2.49

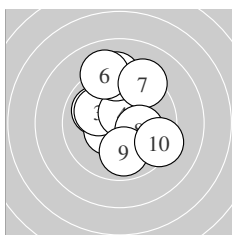
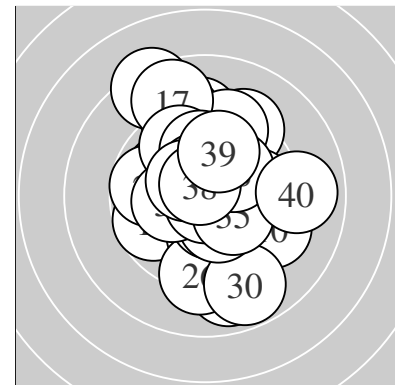

Serie 1:
 10.0 ↘ 10.5 * 10.1 ↘ 10.6 * 9.2 ↑
 9.1 ↑ 9.3 ↗ 10.2 * 9.9 ↓ 9.3 ↘
 beste Teiler 98.0 (4.) 123.1 (2.) 191.6 (8.)
 Trefferlage 0.13 mm rechts, 0.99 mm hoch
 Streuwert 2.21, horizontal: 1.90, vertikal: 2.48

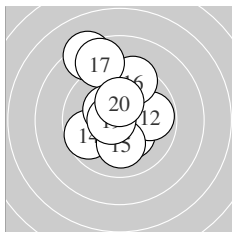

Serie 2:
 10.3 * 9.8 → 8.3 ↖ 9.7 ↙ 10.1 ↓
 9.4 ↗ 8.7 ↖ 10.4 * 10.7 * 10.3 *
 beste Teiler 75.0 (19.) 148.2 (18.) 164.4 (11.)
 Trefferlage 0.43 mm links, 1.30 mm hoch
 Streuwert 2.36, horizontal: 1.83, vertikal: 2.79

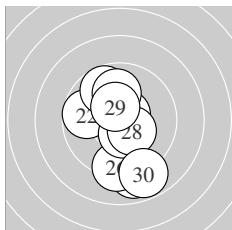

Serie 3:
 8.9 ↓ 9.7 ← 9.7 ↖ 10.6 * 10.0 ↑
 9.2 ↓ 10.4 * 10.4 * 10.4 * 8.8 ↓
 beste Teiler 77.8 (24.) 126.6 (27.) 128.3 (29.)
 Trefferlage 0.01 mm rechts, 0.87 mm tief
 Streuwert 2.31, horizontal: 1.47, vertikal: 2.91

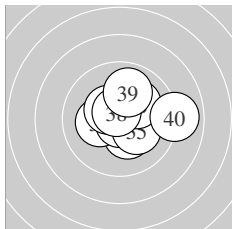

Serie 4:
 10.6 * 10.3 * 10.2 * 10.8 * 10.2 *
 10.1 ↗ 10.4 * 10.7 * 9.9 ↑ 8.9 →
 beste Teiler 36.0 (34.) 70.7 (38.) 90.2 (31.)
 Trefferlage 0.71 mm rechts, 0.31 mm hoch
 Streuwert 1.54, horizontal: 1.86, vertikal: 1.14

Unterschrift des Schützen

Ergebnis: **415.9** (396)
 Serien: 104.3 104.3 103.2 104.1
 Zähler: 36 4 0 0 0 0 0 0 0 0
 Innenzehner: 32
 weiteste: 353 (11), 339 (2), 294 (28)
 beste Teiler 4.1 (30.) 9.0 (14.) 34.4 (1.)
 Trefferlage 0.14 mm links, 0.27 mm tief
 Streuwert 1.14, horizontal: 1.28, vertikal: 0.98

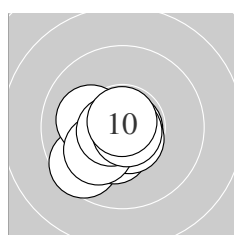
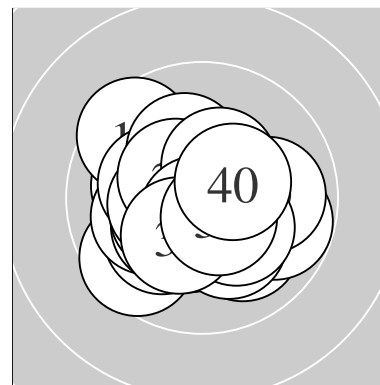

Serie 1:
 10.8 * 9.6 ↙ 10.5 * 10.4 * 10.1 ↖
 10.6 * 10.1 ↙ 10.6 * 10.8 * 10.8 *
 beste Teiler 34.4 (1.) 36.2 (10.) 41.0 (9.)
 Trefferlage 0.75 mm links, 0.60 mm tief
 Streuwert 0.96, horizontal: 1.04, vertikal: 0.88

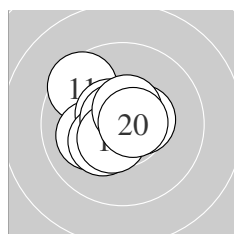

Serie 2:
 9.5 ↘ 10.1 ↖ 10.5 * 10.9 * 10.3 *
 10.7 * 10.5 * 10.5 * 10.6 * 10.7 *
 beste Teiler 9.0 (14.) 60.4 (16.) 67.8 (20.)
 Trefferlage 0.58 mm links, 0.19 mm hoch
 Streuwert 1.10, horizontal: 1.17, vertikal: 1.02

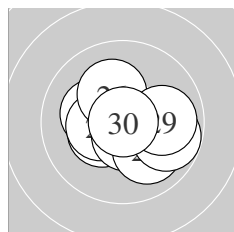

Serie 3:
 10.4 * 10.2 * 10.4 * 10.8 * 10.6 *
 10.2 * 10.0 ↘ 9.8 ↘ 9.9 → 10.9 *
 beste Teiler 4.1 (30.) 41.1 (24.) 93.4 (25.)
 Trefferlage 0.24 mm rechts, 0.20 mm tief
 Streuwert 1.33, horizontal: 1.62, vertikal: 0.96

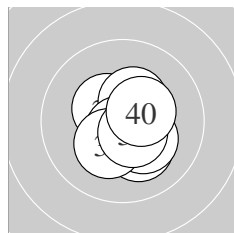

Serie 4:
 10.4 * 10.2 * 10.4 * 10.4 * 10.3 *
 10.4 * 10.7 * 10.3 * 10.6 * 10.4 *
 beste Teiler 65.2 (37.) 98.4 (39.) 130.2 (34.)
 Trefferlage 0.50 mm rechts, 0.46 mm tief
 Streuwert 0.94, horizontal: 0.88, vertikal: 1.00

Unterschrift des Schützen

Meyton Elektronik

Ergebnis: **410.1** (393)
 Serien: 103.5 102.2 102.6 101.8
 Zähler: 33 7 0 0 0 0 0 0 0 0
 Innenzehner: 27
 weiteste: 493 (14), 483 (3), 355 (35)
 beste Teiler 38.9 (7.) 41.1 (2.) 48.8 (39.)
 Trefferlage 0.21 mm links, 0.11 mm hoch
 Streuwert 1.46, horizontal: 1.67, vertikal: 1.21

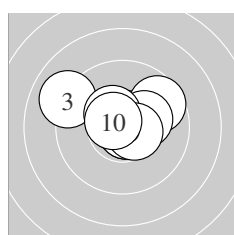
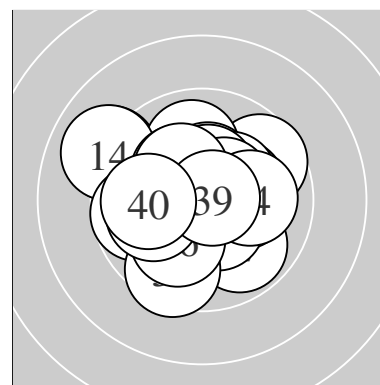

Serie 1:
 10.7 * 10.8 * 9.0 ↘ 10.7 * 9.7 ↗
 10.2 * 10.8 * 10.4 * 10.6 * 10.6 *
 beste Teiler 38.9 (7.) 41.1 (2.) 66.4 (4.)
 Trefferlage 0.04 mm links, 0.63 mm hoch
 Streuwert 1.45, horizontal: 1.86, vertikal: 0.85

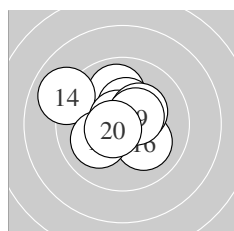

Serie 2:
 10.5 * 10.0 ↑ 10.4 * 9.0 ↘ 10.7 *
 10.1 ↘ 10.3 * 10.1 ↗ 10.5 * 10.6 *
 beste Teiler 56.6 (15.) 85.4 (20.) 107.8 (11.)
 Trefferlage 0.45 mm links, 0.57 mm hoch
 Streuwert 1.55, horizontal: 1.77, vertikal: 1.29

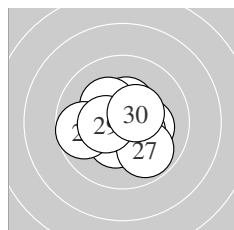

Serie 3:
 10.4 * 10.2 * 10.4 * 10.3 * 10.4 *
 10.4 * 9.9 ↘ 9.7 ← 10.4 * 10.5 *
 beste Teiler 124.5 (30.) 132.0 (29.) 132.9 (23.)
 Trefferlage 0.12 mm links, 0.16 mm tief
 Streuwert 1.38, horizontal: 1.60, vertikal: 1.12

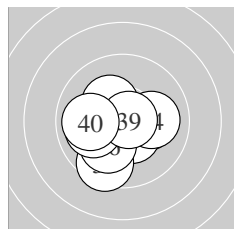

Serie 4:
 10.6 * 10.2 * 10.4 * 10.0 → 9.5 ↓
 10.1 ↗ 10.0 ← 10.3 * 10.8 * 9.9 ←
 beste Teiler 48.8 (39.) 94.9 (31.) 129.7 (33.)
 Trefferlage 0.21 mm links, 0.57 mm tief
 Streuwert 1.49, horizontal: 1.69, vertikal: 1.26

Unterschrift des Schützen

Ergebnis: **409.2** (389)
 Serien: 101.2 105.0 103.4 99.6
 Zähler: 29 11 0 0 0 0 0 0 0 0
 Innenzehner: 24
 weiteste: 408 (37), 360 (32), 358 (4)
 beste Teiler 39.2 (18.) 42.3 (2.) 46.0 (22.)
 Trefferlage 0.28 mm links, 0.27 mm hoch
 Streuwert 1.45, horizontal: 1.33, vertikal: 1.55

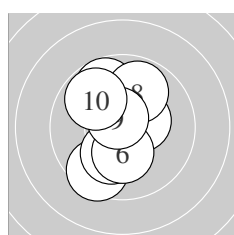
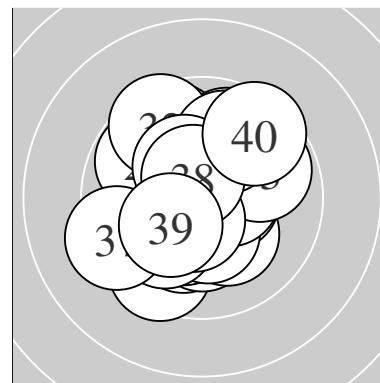

Serie 1:
 10.1 ↑ 10.8 * 10.4 * 9.5 ✓ 10.1 ✓
 10.2 * 9.7 ↘ 9.9 ↑ 10.7 * 9.8 ↘
 beste Teiler 42.3 (2.) 75.6 (9.) 135.4 (3.)
 Trefferlage 0.30 mm links, 0.37 mm hoch
 Streuwert 1.67, horizontal: 1.13, vertikal: 2.07

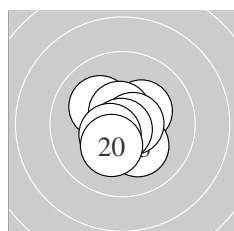

Serie 2:
 10.7 * 10.3 * 10.2 * 10.1 ↘ 10.8 *
 10.6 * 10.7 * 10.8 * 10.5 * 10.3 *
 beste Teiler 39.2 (18.) 46.5 (15.) 68.8 (11.)
 Trefferlage 0.08 mm links, 0.19 mm tief
 Streuwert 0.97, horizontal: 0.94, vertikal: 0.99

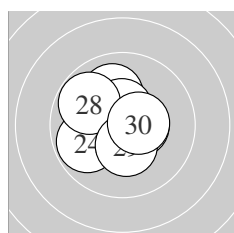

Serie 3:
 10.6 * 10.8 * 10.5 * 9.8 ✓ 10.0 ↗
 10.5 * 10.5 * 9.8 ↘ 10.4 * 10.5 *
 beste Teiler 46.0 (22.) 92.1 (21.) 107.2 (23.)
 Trefferlage 0.34 mm links, 0.27 mm hoch
 Streuwert 1.24, horizontal: 1.35, vertikal: 1.13

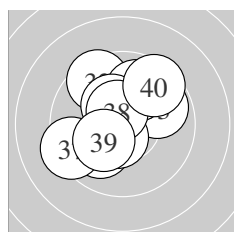

Serie 4:
 10.0 ✓ 9.5 ↘ 9.8 ↗ 9.9 ↑ 10.3 *
 10.5 * 9.3 ✓ 10.6 * 10.2 * 9.5 ↗
 beste Teiler 99.9 (38.) 103.2 (36.) 156.2 (35.)
 Trefferlage 0.42 mm links, 0.62 mm hoch
 Streuwert 1.89, horizontal: 1.91, vertikal: 1.88

Unterschrift des Schützen

Ergebnis: **408.5** (390)
 Serien: 102.9 102.4 101.5 101.7
 Zähler: 30 10 0 0 0 0 0 0 0 0
 Innenzehner: 23
 weiteste: 376 (24), 334 (34), 324 (14)
 beste Teiler 24.1 (10.) 38.6 (20.) 44.9 (29.)
 Trefferlage 0.20 mm links, 0.00 mm
 Streuwert 1.46, horizontal: 1.64, vertikal: 1.26

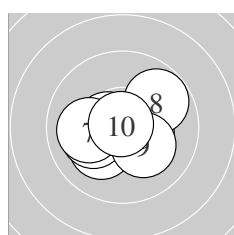
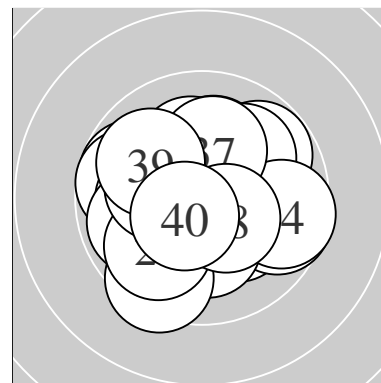

Serie 1:
 10.3 * 10.2 * 10.4 * 10.5 * 10.5 *
 10.1 ← 10.0 ← 9.8 ↗ 10.2 * 10.9 *
 beste Teiler 24.1 (10.) 105.7 (5.) 110.0 (4.)
 Trefferlage 0.42 mm links, 0.26 mm tief
 Streuwert 1.30, horizontal: 1.59, vertikal: 0.92

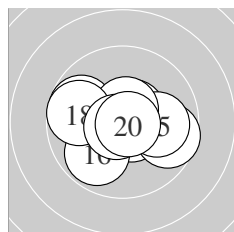

Serie 2:
 9.8 ↖ 10.6 * 10.6 * 9.7 → 10.0 →
 9.9 ↘ 10.6 * 9.7 ← 10.7 * 10.8 *
 beste Teiler 38.6 (20.) 54.2 (19.) 78.8 (12.)
 Trefferlage 0.06 mm links, 0.09 mm tief
 Streuwert 1.58, horizontal: 2.02, vertikal: 0.96

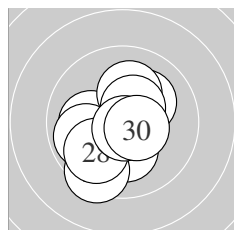

Serie 3:
 10.2 * 10.1 ↗ 10.1 ← 9.4 ↘ 10.1 ↑
 10.5 * 9.9 ← 9.9 ↘ 10.8 * 10.5 *
 beste Teiler 44.9 (29.) 105.3 (30.) 121.8 (26.)
 Trefferlage 0.43 mm links, 0.47 mm tief
 Streuwert 1.56, horizontal: 1.47, vertikal: 1.65

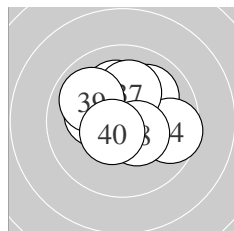

Serie 4:
 10.3 * 10.4 * 10.0 ↗ 9.6 → 10.2 *
 10.2 * 10.2 * 10.4 * 9.9 ↖ 10.5 *
 beste Teiler 103.9 (40.) 129.8 (38.) 146.4 (32.)
 Trefferlage 0.10 mm rechts, 0.80 mm hoch
 Streuwert 1.40, horizontal: 1.62, vertikal: 1.15

Unterschrift des Schützen

Meyton Elektronik

Ergebnis: **401.4** (382)
 Serien: 98.9 102.0 104.3 96.2
 Zähler: 26 10 4 0 0 0 0 0 0 0
 Innenzehner: 20
 weiteste: 699 (9), 582 (33), 550 (36)
 beste Teiler 16.0 (7.) 17.4 (30.) 27.0 (29.)
 Trefferlage 0.69 mm links, 0.11 mm tief
 Streuwert 1.92, horizontal: 2.22, vertikal: 1.56

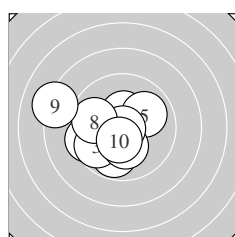
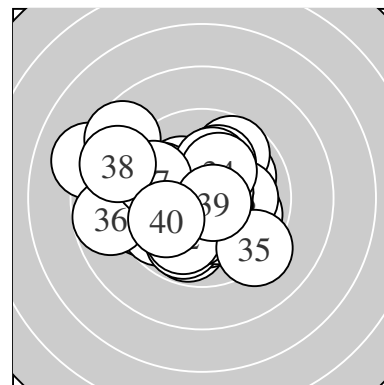

Serie 1:
 9.5 ← 9.8 ↓ 9.7 ↙ 10.4 * 10.0 ↗
 10.2 * 10.9 * 9.8 ← 8.2 ↖ 10.4 *
 beste Teiler 16.0 (7.) 130.2 (10.) 132.3 (4.)
 Trefferlage 1.39 mm links, 0.35 mm tief
 Streuwert 2.11, horizontal: 2.49, vertikal: 1.64

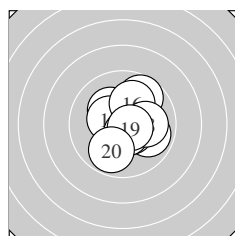

Serie 2:
 9.9 ↘ 9.7 ↗ 10.2 * 10.5 * 10.4 *
 10.1 ↗ 10.6 * 10.1 → 10.6 * 9.9 ↓
 beste Teiler 82.2 (19.) 95.8 (17.) 109.1 (14.)
 Trefferlage 0.57 mm rechts, 0.10 mm hoch
 Streuwert 1.47, horizontal: 1.39, vertikal: 1.55

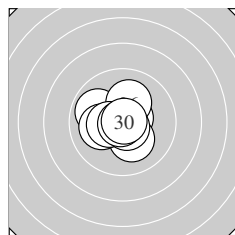

Serie 3:
 10.5 * 10.6 * 10.2 * 9.9 ↖ 10.1 ←
 10.2 * 10.4 * 10.7 * 10.8 * 10.9 *
 beste Teiler 17.4 (30.) 27.0 (29.) 67.0 (28.)
 Trefferlage 0.26 mm links, 0.05 mm tief
 Streuwert 1.11, horizontal: 1.22, vertikal: 1.00

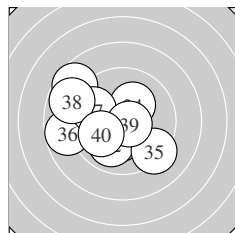

Serie 4:
 10.2 * 10.0 ↓ 8.6 ↘ 10.2 * 9.2 ↘
 8.8 ← 9.7 ↖ 8.8 ↖ 10.7 * 10.0 ←
 beste Teiler 71.1 (39.) 183.9 (31.) 186.7 (34.)
 Trefferlage 1.67 mm links, 0.14 mm tief
 Streuwert 2.49, horizontal: 2.84, vertikal: 2.09

Unterschrift des Schützen

Ergebnis: **402.1** (387)
 Serien: 101.6 97.8 100.2 102.5
 Zähler: 27 13 0 0 0 0 0 0 0 0
 Innenzehner: 16
 weiteste: 460 (24), 443 (22), 426 (32)
 beste Teiler 46.8 (34.) 60.5 (29.) 72.4 (25.)
 Trefferlage 0.14 mm links, 0.23 mm tief
 Streuwert 1.79, horizontal: 1.92, vertikal: 1.66

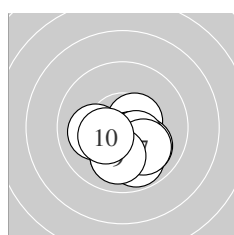
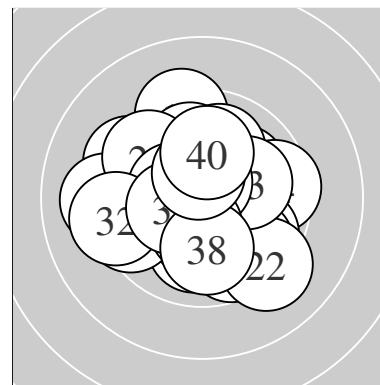

Serie 1:
 9.8 ↘ 10.5 * 10.0 ↘ 10.0 ↓ 10.5 *
 10.4 * 10.0 ↘ 10.1 ← 10.0 ↓ 10.3 *
 beste Teiler 107.7 (2.) 118.1 (5.) 141.8 (6.)
 Trefferlage 0.28 mm rechts, 1.26 mm tief
 Streuwert 1.15, horizontal: 1.31, vertikal: 0.95

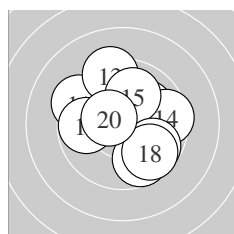

Serie 2:
 9.4 ↖ 10.1 ↗ 9.3 ↑ 9.5 → 10.0 ↑
 9.8 ↘ 9.7 ↓ 9.7 ↘ 9.8 ← 10.5 *
 beste Teiler 119.5 (20.) 225.7 (12.) 242.2 (15.)
 Trefferlage 0.37 mm rechts, 0.33 mm hoch
 Streuwert 2.25, horizontal: 2.36, vertikal: 2.13

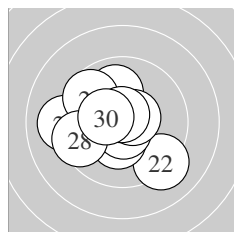

Serie 3:
 10.0 ↑ 9.2 ↘ 10.3 * 9.1 ← 10.7 *
 9.7 ↖ 10.6 * 9.5 ← 10.7 * 10.4 *
 beste Teiler 60.5 (29.) 72.4 (25.) 89.9 (27.)
 Trefferlage 0.89 mm links, 0.11 mm tief
 Streuwert 1.95, horizontal: 2.21, vertikal: 1.66

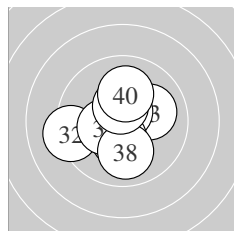

Serie 4:
 10.4 * 9.2 ← 10.1 → 10.8 * 10.6 *
 10.4 * 10.4 * 10.0 ↓ 10.5 * 10.1 ↑
 beste Teiler 46.8 (34.) 78.8 (35.) 121.1 (39.)
 Trefferlage 0.35 mm links, 0.09 mm hoch
 Streuwert 1.51, horizontal: 1.59, vertikal: 1.41

Unterschrift des Schützen

Meyton Elektronik

Ergebnis: **400.2** (382)
 Serien: 98.2 101.0 101.1 99.9
 Zähler: 23 16 1 0 0 0 0 0 0 0
 Innenzehner: 17
 weiteste: 639 (14), 491 (5), 483 (7)
 beste Teiler 45.0 (24.) 52.4 (19.) 95.6 (12.)
 Trefferlage 0.08 mm links, 0.59 mm hoch
 Streuwert 1.89, horizontal: 2.30, vertikal: 1.36

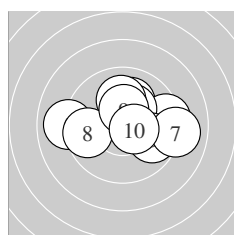
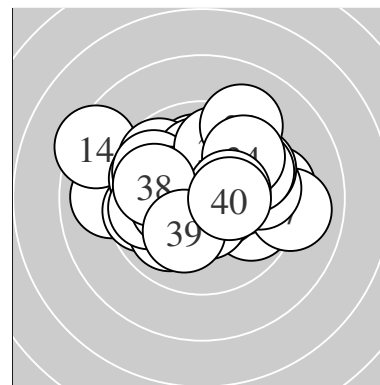

Serie 1:
 10.1 ↑ 9.4 → 10.3 * 10.0 ↑ 9.0 ←
 9.8 ↘ 9.0 → 9.7 ← 10.4 * 10.5 *
 beste Teiler 109.7 (10.) 143.4 (9.) 170.1 (3.)
 Trefferlage 0.58 mm rechts, 0.50 mm hoch
 Streuwert 2.26, horizontal: 2.95, vertikal: 1.24

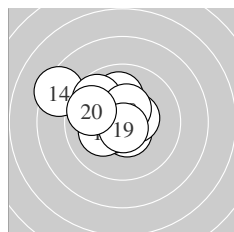

Serie 2:
 10.6 * 10.6 * 10.5 * 8.4 ↖ 10.0 ↑
 9.7 ↘ 10.2 * 10.5 * 10.7 * 9.8 ↖
 beste Teiler 52.4 (19.) 95.6 (12.) 98.8 (11.)
 Trefferlage 1.18 mm links, 0.69 mm hoch
 Streuwert 1.75, horizontal: 2.05, vertikal: 1.38

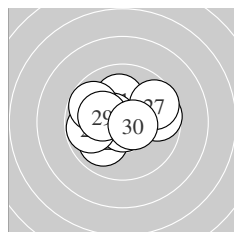

Serie 3:
 10.1 ↑ 10.0 ↙ 10.5 * 10.8 * 9.7 →
 9.8 ← 9.6 → 9.8 ↖ 10.2 * 10.6 *
 beste Teiler 45.0 (24.) 96.3 (30.) 106.4 (23.)
 Trefferlage 0.33 mm links, 0.35 mm hoch
 Streuwert 1.70, horizontal: 2.11, vertikal: 1.15

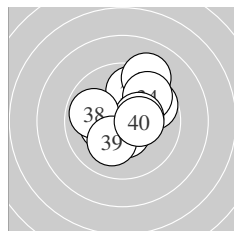

Serie 4:
 9.8 ↑ 9.7 ↗ 9.2 ↑ 9.7 ↗ 10.3 *
 10.3 * 10.5 * 9.9 ← 10.1 ↙ 10.4 *
 beste Teiler 111.8 (37.) 149.0 (40.) 151.1 (36.)
 Trefferlage 0.58 mm rechts, 0.80 mm hoch
 Streuwert 1.79, horizontal: 1.80, vertikal: 1.78

Unterschrift des Schützen

Ergebnis: **407.3** (389)
 Serien: 101.5 101.7 102.4 101.7
 Zähler: 29 11 0 0 0 0 0 0 0 0
 Innenzehner: 24
 weiteste: 403 (1), 361 (36), 347 (17)
 beste Teiler 3.6 (9.) 33.1 (23.) 64.0 (5.)
 Trefferlage 0.44 mm rechts, 0.26 mm hoch
 Streuwert 1.47, horizontal: 1.40, vertikal: 1.53

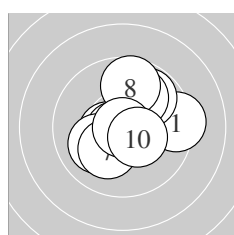
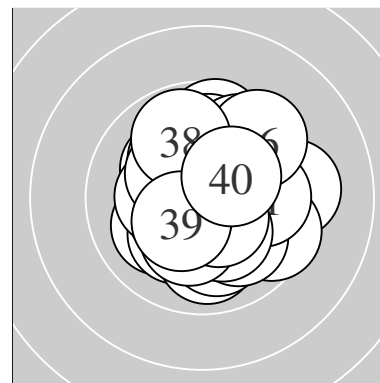

Serie 1:
 9.3 → 9.8 ↗ 10.5 * 9.9 ↗ 10.7 *
 10.1 ↙ 10.2 * 9.7 ↑ 10.9 * 10.4 *
 beste Teiler 3.6 (9.) 64.0 (5.) 111.9 (3.)
 Trefferlage 0.41 mm rechts, 0.36 mm hoch
 Streuwert 1.67, horizontal: 1.73, vertikal: 1.60

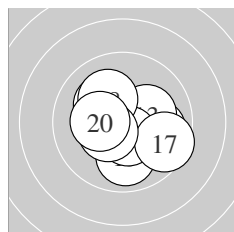

Serie 2:
 9.9 → 10.6 * 10.2 * 10.2 * 9.9 ↓
 10.5 * 9.6 ↘ 10.1 ↘ 10.4 * 10.3 *
 beste Teiler 92.6 (12.) 111.4 (16.) 130.6 (19.)
 Trefferlage 0.24 mm rechts, 0.35 mm tief
 Streuwert 1.52, horizontal: 1.71, vertikal: 1.29

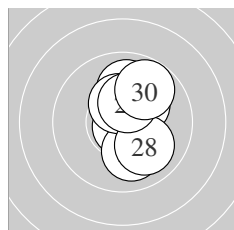

Serie 3:
 10.6 * 10.2 * 10.8 * 10.0 ↑ 10.2 *
 10.0 ↓ 10.4 * 10.0 ↘ 10.4 * 9.8 ↗
 beste Teiler 33.1 (23.) 89.0 (21.) 142.6 (27.)
 Trefferlage 0.66 mm rechts, 0.74 mm hoch
 Streuwert 1.25, horizontal: 0.69, vertikal: 1.63

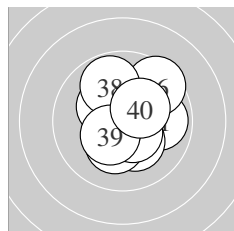

Serie 4:
 9.9 → 10.2 * 10.2 * 10.6 * 10.3 *
 9.5 ↗ 10.5 * 9.8 ↘ 10.4 * 10.3 *
 beste Teiler 93.1 (34.) 115.5 (37.) 140.2 (39.)
 Trefferlage 0.44 mm rechts, 0.31 mm hoch
 Streuwert 1.51, horizontal: 1.42, vertikal: 1.60

Unterschrift des Schützen

Meyton Elektronik

Ergebnis: **409.2** (389)
 Serien: 103.7 102.8 99.5 103.2
 Zähler: 30 9 1 0 0 0 0 0 0
 Innenzehner: 25
 weiteste: 649 (28), 406 (22), 361 (21)
 beste Teiler 15.8 (7.) 36.2 (25.) 58.0 (38.)
 Trefferlage 0.04 mm links, 0.41 mm hoch
 Streuwert 1.52, horizontal: 1.65, vertikal: 1.38

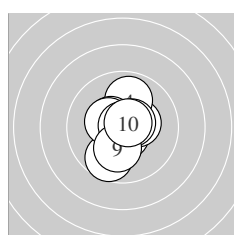
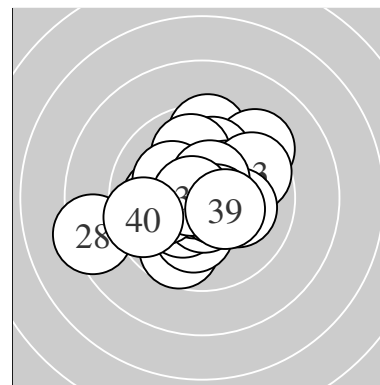

Serie 1:
 9.7 ↘ 10.6 * 10.4 * 9.9 ↑ 10.4 *
 10.4 * 10.9 * 10.6 * 10.1 ↓ 10.7 *
 beste Teiler 15.8 (7.) 65.4 (10.) 80.0 (2.)
 Trefferlage 0.07 mm links, 0.05 mm tief
 Streuwert 1.25, horizontal: 0.95, vertikal: 1.50

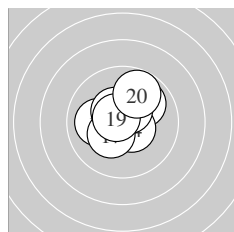

Serie 2:
 10.0 ← 10.3 * 9.9 ↗ 10.5 * 10.5 *
 10.4 * 10.3 * 10.4 * 10.7 * 9.8 ↑
 beste Teiler 73.0 (19.) 103.7 (14.) 111.2 (15.)
 Trefferlage 0.03 mm rechts, 0.72 mm hoch
 Streuwert 1.19, horizontal: 1.28, vertikal: 1.10

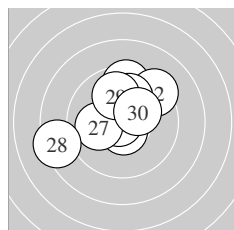

Serie 3:
 9.5 ↑ 9.3 ↗ 10.7 * 10.6 * 10.8 *
 10.0 ↑ 10.0 ← 8.4 ← 9.9 ↑ 10.3 *
 beste Teiler 36.2 (25.) 59.4 (23.) 84.5 (24.)
 Trefferlage 0.43 mm links, 0.83 mm hoch
 Streuwert 2.17, horizontal: 2.43, vertikal: 1.87

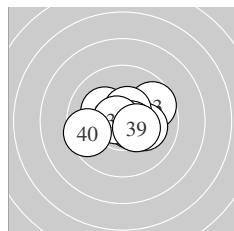

Serie 4:
 10.2 * 10.7 * 9.7 ↗ 10.1 → 10.7 *
 10.5 * 10.6 * 10.7 * 10.4 * 9.6 ←
 beste Teiler 58.0 (38.) 67.3 (35.) 73.1 (32.)
 Trefferlage 0.28 mm rechts, 0.12 mm hoch
 Streuwert 1.38, horizontal: 1.77, vertikal: 0.83

Unterschrift des Schützen

Meyton Elektronik

Ergebnis: **403.5** (386)
 Serien: 101.5 100.9 99.4 101.7
 Zähler: 28 10 2 0 0 0 0 0 0 0
 Innenzehner: 23
 weiteste: 557 (11), 514 (17), 466 (23)
 beste Teiler 56.0 (39.) 77.8 (20.) 81.2 (33.)
 Trefferlage 0.32 mm rechts, 0.08 mm hoch
 Streuwert 1.74, horizontal: 1.95, vertikal: 1.51

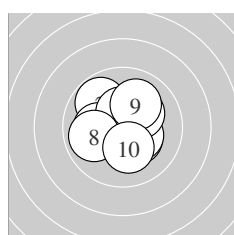
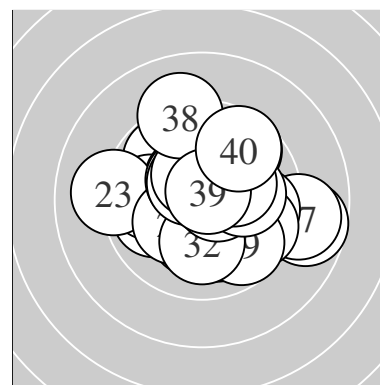

Serie 1:
 10.3 * 9.8 ↘ 10.1 ← 10.3 * 10.4 *
 10.3 * 10.2 * 9.9 ← 10.0 ↗ 10.2 *
 beste Teiler 129.4 (5.) 152.5 (6.) 161.4 (4.)
 Trefferlage 0.25 mm links, 0.23 mm hoch
 Streuwert 1.48, horizontal: 1.61, vertikal: 1.34

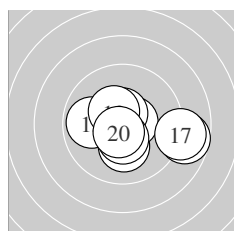

Serie 2:
 8.7 → 10.5 * 9.9 ← 10.2 * 10.6 *
 10.6 * 8.9 → 10.4 * 10.5 * 10.6 *
 beste Teiler 77.8 (20.) 87.8 (15.) 94.0 (16.)
 Trefferlage 0.71 mm rechts, 0.27 mm tief
 Streuwert 1.97, horizontal: 2.57, vertikal: 1.07

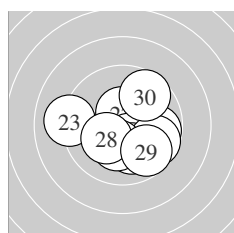

Serie 3:
 9.8 → 10.5 * 9.1 ← 10.4 * 10.1 ↘
 9.7 → 10.2 * 10.2 * 9.7 ↘ 9.7 ↗
 beste Teiler 111.5 (22.) 133.7 (24.) 181.9 (28.)
 Trefferlage 0.44 mm rechts, 0.61 mm tief
 Streuwert 1.96, horizontal: 2.29, vertikal: 1.55

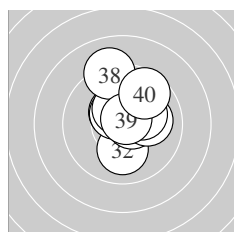

Serie 4:
 10.4 * 10.1 ↓ 10.6 * 10.5 * 10.4 *
 10.1 → 10.2 * 9.1 ↑ 10.7 * 9.6 ↗
 beste Teiler 56.0 (39.) 81.2 (33.) 112.4 (34.)
 Trefferlage 0.39 mm rechts, 0.99 mm hoch
 Streuwert 1.48, horizontal: 1.20, vertikal: 1.72

Unterschrift des Schützen

Meyton Elektronik