

**Ergebnis: 312.3 (298)**  
**Serien: 103.7 104.4 104.2**  
**Zähler: 28 2 0 0 0 0 0 0 0 0**  
**Innenzehner: 25**  
**Weiteste: 308 (9.), 261 (25.), 241 (19.)**  
**beste Teiler: 18.4 (23.), 36.2 (11.), 37.2 (8.)**  
**Trefferlage: 0.09 mm links, 0.25 mm hoch**  
**Streuwert: 1.08, horizontal: 1.39, vertikal: 0.65**

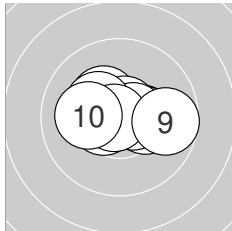
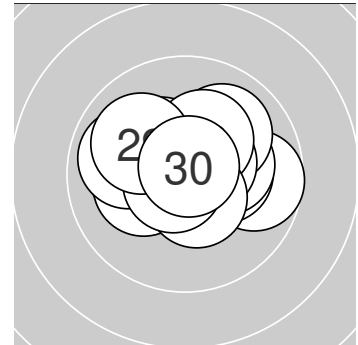

**Serie 1:**

10.4 *	10.3 *	10.5 *	10.3 *	10.7 *
10.6 *	10.3 *	10.8 *	9.7 →	10.1 ←

**beste Teiler: 37.2 (8.), 59.3 (5.), 89.2 (6.)**  
**Trefferlage: 0.15 mm rechts, 0.17 mm hoch**  
**Streuwert: 1.21, horizontal: 1.63, vertikal: 0.50**

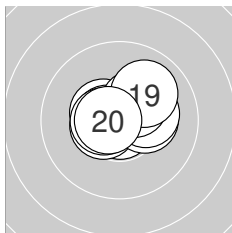

**Serie 2:**

10.8 *	10.5 *	10.5 *	10.6 *	10.5 *
10.3 *	10.2 *	10.4 *	10.0 ↗	10.6 *

**beste Teiler: 36.2 (11.), 77.0 (20.), 84.4 (14.)**  
**Trefferlage: 0.12 mm rechts, 0.31 mm hoch**  
**Streuwert: 1.01, horizontal: 1.25, vertikal: 0.67**

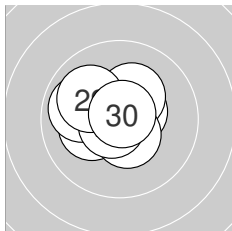

**Serie 3:**

10.5 *	10.4 *	10.9 *	10.2 *	9.9 ←
10.3 *	10.5 *	10.7 *	10.0 ↘	10.8 *

**beste Teiler: 18.4 (23.), 38.0 (30.), 63.2 (28.)**  
**Trefferlage: 0.56 mm links, 0.27 mm hoch**  
**Streuwert: 1.06, horizontal: 1.27, vertikal: 0.80**



**Ergebnis: 311.6 (297)**  
**Serien: 102.8 104.5 104.3**  
**Zähler: 27 3 0 0 0 0 0 0 0 0**  
**Innenzehner: 22**  
**Weiteste: 333 (10.), 278 (13.), 268 (9.)**  
**beste Teiler: 13.3 (27.), 40.4 (16.), 59.0 (2.)**  
**Trefferlage: 0.55 mm rechts, 0.10 mm hoch**  
**Streuwert: 1.09, horizontal: 1.03, vertikal: 1.15**

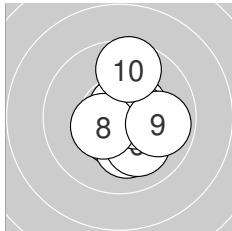
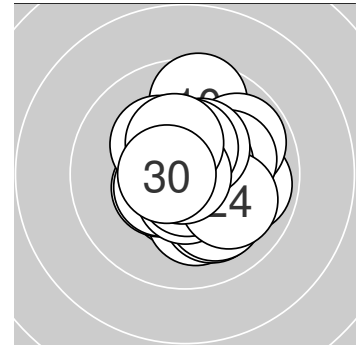

**Serie 1:**

10.4 *	10.7 *	10.5 *	10.5 *	10.2 *
10.1 ↘	10.5 *	10.4 *	9.9 →	9.6 ↑

**beste Teiler: 59.0 (2.), 111.2 (7.), 111.6 (3.)**  
**Trefferlage: 0.71 mm rechts, 0.14 mm tief**  
**Streuwert: 1.28, horizontal: 1.03, vertikal: 1.49**

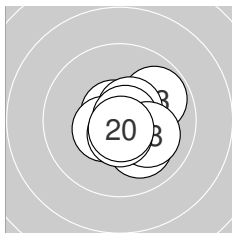

**Serie 2:**

10.6 *	10.7 *	9.8 ↗	10.6 *	10.5 *
10.8 *	10.1 ↘	10.1 ↘	10.6 *	10.7 *

**beste Teiler: 40.4 (16.), 60.8 (20.), 65.4 (12.)**  
**Trefferlage: 0.62 mm rechts, 0.14 mm tief**  
**Streuwert: 1.01, horizontal: 1.04, vertikal: 0.97**

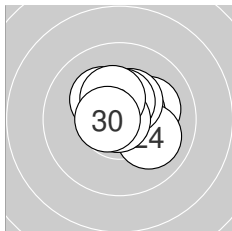

**Serie 3:**

10.1 →	10.6 *	10.6 *	10.0 ↘	10.4 *
10.5 *	10.9 *	10.2 *	10.4 *	10.6 *

**beste Teiler: 13.3 (27.), 83.0 (30.), 92.2 (23.)**  
**Trefferlage: 0.32 mm rechts, 0.60 mm hoch**  
**Streuwert: 0.96, horizontal: 1.08, vertikal: 0.82**



**Ergebnis: 308.4 (297)**  
**Serien: 101.8 103.3 103.3**  
**Zähler: 27 3 0 0 0 0 0 0 0 0**  
**Innenzehner: 19**  
**Weiteste: 311 (4.), 264 (19.), 255 (14.)**  
**beste Teiler: 40.2 (25.), 50.2 (27.), 65.0 (18.)**  
**Trefferlage: 0.04 mm links, 0.19 mm tief**  
**Streuwert: 1.30, horizontal: 1.40, vertikal: 1.19**

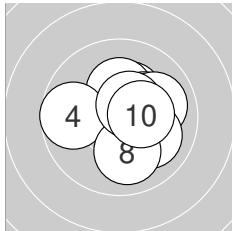
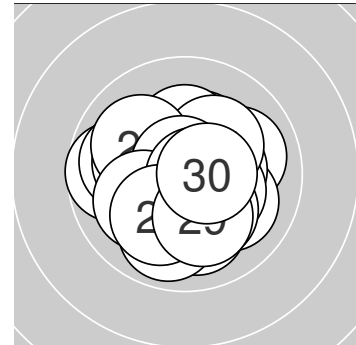

**Serie 1:**

10.4 *	10.3 *	10.3 *	9.7 ←	10.2 *
10.0 →	10.0 ↘	10.0 ↓	10.5 *	10.4 *

**beste Teiler: 106.8 (9.), 137.6 (1.), 144.3 (10.)**  
**Trefferlage: 0.65 mm rechts, 0.38 mm hoch**  
**Streuwert: 1.39, horizontal: 1.51, vertikal: 1.25**

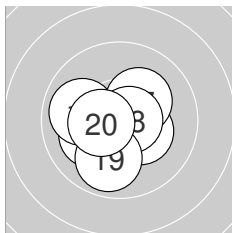

**Serie 2:**

10.5 *	10.3 *	10.1 ↙	9.9 ←	10.6 *
10.6 *	10.2 *	10.7 *	9.9 ↓	10.5 *

**beste Teiler: 65.0 (18.), 77.4 (16.), 94.8 (15.)**  
**Trefferlage: 0.36 mm links, 0.38 mm tief**  
**Streuwert: 1.19, horizontal: 1.32, vertikal: 1.05**

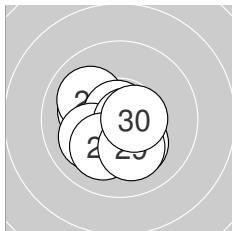

**Serie 3:**

10.4 *	10.2 *	10.2 *	10.0 ↘	10.8 *
10.1 ↙	10.8 *	10.1 ↘	10.1 ↓	10.6 *

**beste Teiler: 40.2 (25.), 50.2 (27.), 98.0 (30.)**  
**Trefferlage: 0.42 mm links, 0.58 mm tief**  
**Streuwert: 1.18, horizontal: 1.23, vertikal: 1.13**



**Ergebnis: 311.7 (298)**  
**Serien: 102.6 104.0 105.1**  
**Zähler: 28 2 0 0 0 0 0 0 0 0**  
**Innenzehner: 23**  
**Weiteste: 287 (11.), 279 (12.), 224 (8.)**  
**beste Teiler: 9.4 (19.), 13.0 (16.), 39.1 (27.)**  
**Trefferlage: 0.11 mm links, 0.06 mm tief**  
**Streuwert: 1.14, horizontal: 1.22, vertikal: 1.05**

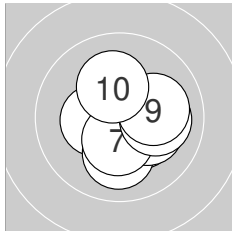
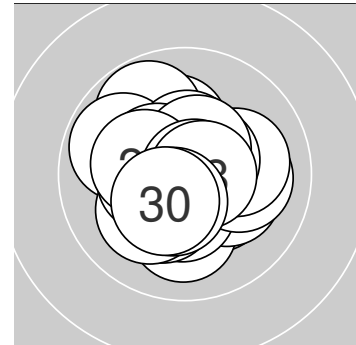

**Serie 1:**

10.3 *	10.7 *	10.1 →	10.4 *	10.1 ↓
10.2 *	10.4 *	10.1 →	10.1 →	10.2 *

**beste Teiler: 63.3 (2.), 139.4 (7.), 147.2 (4.)**  
**Trefferlage: 0.74 mm rechts, 0.39 mm tief**  
**Streuwert: 1.21, horizontal: 1.30, vertikal: 1.11**

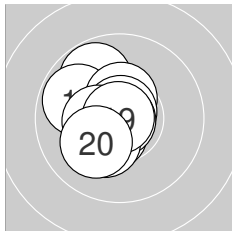

**Serie 2:**

9.8 ↘	9.8 ↖	10.5 *	10.5 *	10.8 *
10.9 *	10.4 *	10.3 *	10.9 *	10.1 ↙

**beste Teiler: 9.4 (19.), 13.0 (16.), 41.5 (15.)**  
**Trefferlage: 0.82 mm links, 0.10 mm hoch**  
**Streuwert: 1.08, horizontal: 0.89, vertikal: 1.25**

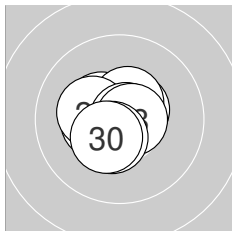

**Serie 3:**

10.6 *	10.5 *	10.4 *	10.4 *	10.5 *
10.3 *	10.8 *	10.7 *	10.5 *	10.4 *

**beste Teiler: 39.1 (27.), 73.0 (28.), 85.0 (21.)**  
**Trefferlage: 0.26 mm links, 0.10 mm hoch**  
**Streuwert: 0.86, horizontal: 0.95, vertikal: 0.75**



**Ergebnis:** **309.2** (296)  
**Serien:** 103.5 102.6 103.1  
**Zähler:** 26 4 0 0 0 0 0 0 0 0  
**Innenzehner:** 21  
**Weiteste:** 412 (13.), 314 (16.), 268 (18.)  
**beste Teiler:** 24.0 (20.), 61.0 (12.), 68.4 (4.)  
**Trefferlage:** 0.07 mm links, 0.39 mm hoch  
**Streuwert:** 1.28, horizontal: 1.47, vertikal: 1.05

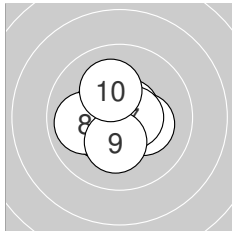
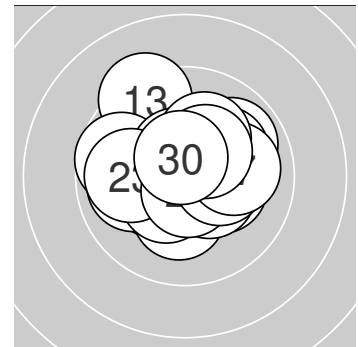

**Serie 1:**

10.6 *	10.2 *	10.4 *	10.7 *	10.5 *
10.2 *	10.6 *	10.0 ←	10.2 *	10.1 ↗

**beste Teiler:** 68.4 (4.), 78.7 (1.), 92.0 (7.)  
**Trefferlage:** 0.35 mm links, 0.09 mm tief  
**Streuwert:** 1.17, horizontal: 1.32, vertikal: 0.99

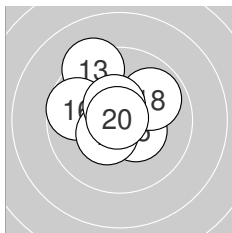

**Serie 2:**

10.2 *	10.7 *	9.3 ↘	10.6 *	10.4 *
9.7 ←	10.4 *	9.9 ↗	10.5 *	10.9 *

**beste Teiler:** 24.0 (20.), 61.0 (12.), 93.2 (14.)  
**Trefferlage:** 0.47 mm links, 0.74 mm hoch  
**Streuwert:** 1.42, horizontal: 1.55, vertikal: 1.28

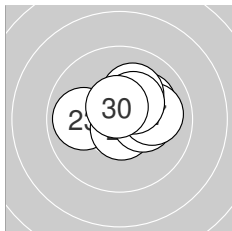

**Serie 3:**

10.7 *	10.1 ↗	9.9 ←	10.4 *	10.7 *
10.3 *	10.0 →	10.1 ↗	10.3 *	10.6 *

**beste Teiler:** 70.4 (25.), 73.0 (21.), 91.0 (30.)  
**Trefferlage:** 0.58 mm rechts, 0.54 mm hoch  
**Streuwert:** 1.14, horizontal: 1.44, vertikal: 0.72



**Ergebnis:** **308.8** (296)  
**Serien:** 102.9 104.0 101.9  
**Zähler:** 26 4 0 0 0 0 0 0 0 0  
**Innenzehner:** 21  
**Weiteste:** 285 (6.), 266 (18.), 254 (7.)  
**beste Teiler:** 17.2 (17.), 62.2 (10.), 71.8 (19.)  
**Trefferlage:** 0.01 mm links, 0.31 mm tief  
**Streuwert:** 1.25, horizontal: 1.36, vertikal: 1.13

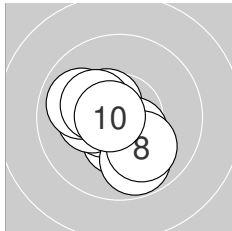
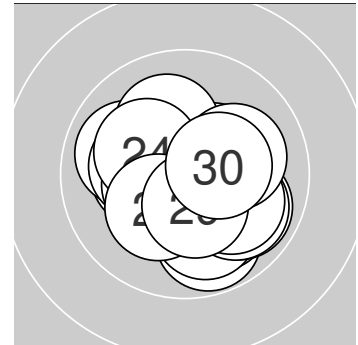

**Serie 1:**

10.4 *	10.5 *	10.6 *	10.4 *	10.3 *
9.8 ↘	9.9 ↖	10.0 ↘	10.3 *	10.7 *

**beste Teiler:** 62.2 (10.), 94.2 (3.), 115.9 (2.)  
**Trefferlage:** 0.49 mm links, 0.47 mm tief  
**Streuwert:** 1.23, horizontal: 1.25, vertikal: 1.22

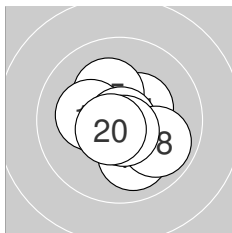

**Serie 2:**

10.5 *	10.0 ↘	10.6 *	10.4 *	10.2 *
10.2 *	10.9 *	9.9 ↘	10.7 *	10.6 *

**beste Teiler:** 17.2 (17.), 71.8 (19.), 80.6 (20.)  
**Trefferlage:** 0.04 mm links, 0.21 mm tief  
**Streuwert:** 1.16, horizontal: 1.23, vertikal: 1.09

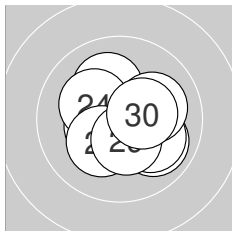

**Serie 3:**

10.1 ↖	9.9 ↘	10.4 *	10.2 *	10.2 *
10.2 *	10.0 ↘	10.1 ↗	10.4 *	10.4 *

**beste Teiler:** 134.4 (23.), 135.9 (29.), 147.4 (30.)  
**Trefferlage:** 0.48 mm rechts, 0.25 mm tief  
**Streuwert:** 1.37, horizontal: 1.53, vertikal: 1.19



# LG Mixed Quali – Wertung – offene Klasse

StartNr: 35

StandNr: 140

12. November 2022 10:29

Penz., Florian #70218025

SG\_Matrei\_a.\_B. / SG Matrei a. B. 1

**Ergebnis: 311.3 (297)**  
**Serien: 103.0 104.2 104.1**  
**Zähler: 27 3 0 0 0 0 0 0 0 0**  
**Innenzehner: 24**  
**Weiteste: 297 (4.), 269 (27.), 263 (3.)**  
**beste Teiler: 42.3 (26.), 49.0 (22.), 80.4 (11.)**  
**Trefferlage: 0.18 mm rechts, 0.33 mm hoch**  
**Streuwert: 1.11, horizontal: 0.92, vertikal: 1.28**

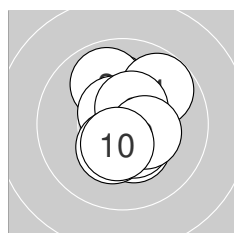
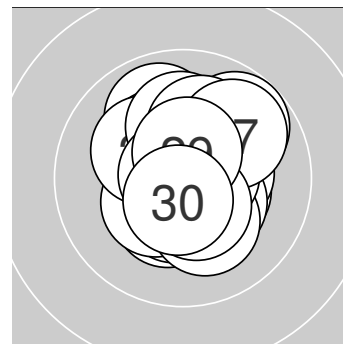

**Serie 1:**  
 10.1 ↑                      10.4 \*                      9.9 ↖                      9.8 ↗                      10.6 \*  
 10.5 \*                      10.3 \*                      10.5 \*                      10.4 \*                      10.5 \*  
**beste Teiler: 87.4 (5.), 114.5 (6.), 125.0 (8.)**  
**Trefferlage: 0.25 mm rechts, 0.28 mm hoch**  
**Streuwert: 1.30, horizontal: 0.98, vertikal: 1.56**

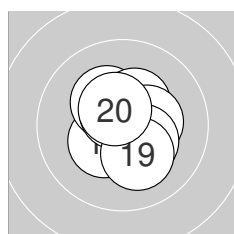

**Serie 2:**  
 10.6 \*                      10.4 \*                      10.5 \*                      10.3 \*                      10.4 \*  
 10.6 \*                      10.4 \*                      10.3 \*                      10.2 \*                      10.5 \*  
**beste Teiler: 80.4 (11.), 85.8 (16.), 109.5 (20.)**  
**Trefferlage: 0.07 mm rechts, 0.13 mm hoch**  
**Streuwert: 1.03, horizontal: 0.92, vertikal: 1.13**

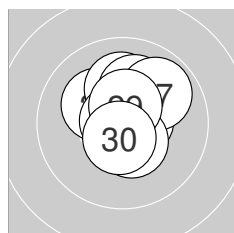

**Serie 3:**  
 10.2 \*                      10.8 \*                      10.1 ↑                      10.1 ↗                      10.6 \*  
 10.8 \*                      9.9 ↗                      10.5 \*                      10.5 \*                      10.6 \*  
**beste Teiler: 42.3 (26.), 49.0 (22.), 90.6 (25.)**  
**Trefferlage: 0.21 mm rechts, 0.58 mm hoch**  
**Streuwert: 1.07, horizontal: 0.93, vertikal: 1.19**



**Ergebnis: 313.0 (299)**  
**Serien: 104.6 104.1 104.3**  
**Zähler: 29 1 0 0 0 0 0 0 0**  
**Innenzehner: 27**  
**Weiteste: 336 (19.), 223 (25.), 208 (26.)**  
**beste Teiler: 8.4 (11.), 20.0 (17.), 44.4 (24.)**  
**Trefferlage: 0.09 mm rechts, 0.22 mm tief**  
**Streuwert: 1.02, horizontal: 1.26, vertikal: 0.71**

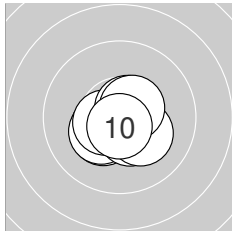
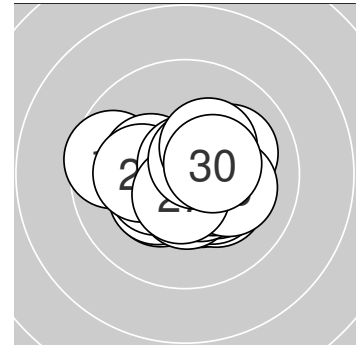

**Serie 1:**

10.4 *	10.3 *	10.3 *	10.7 *	10.5 *
10.4 *	10.6 *	10.2 *	10.5 *	10.7 *

**beste Teiler: 54.4 (4.), 62.0 (10.), 82.3 (7.)**  
**Trefferlage: 0.05 mm links, 0.50 mm tief**  
**Streuwert: 0.85, horizontal: 0.99, vertikal: 0.67**

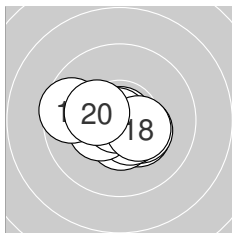

**Serie 2:**

10.9 *	10.3 *	10.5 *	10.3 *	10.5 *
10.4 *	10.9 *	10.4 *	9.6 ←	10.3 *

**beste Teiler: 8.4 (11.), 20.0 (17.), 109.9 (15.)**  
**Trefferlage: 0.15 mm links, 0.35 mm tief**  
**Streuwert: 1.16, horizontal: 1.51, vertikal: 0.63**

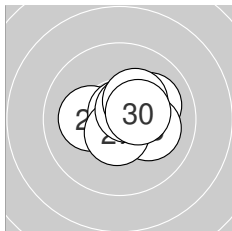

**Serie 3:**

10.6 *	10.2 *	10.6 *	10.8 *	10.1 →
10.1 →	10.6 *	10.6 *	10.3 *	10.4 *

**beste Teiler: 44.4 (24.), 76.1 (21.), 84.3 (23.)**  
**Trefferlage: 0.49 mm rechts, 0.20 mm hoch**  
**Streuwert: 1.00, horizontal: 1.24, vertikal: 0.68**





# LG Mixed Quali – Wertung – offene Klasse

StartNr: 37

StandNr: 142

12. November 2022 10:19

Clari,, Alexandra #70233079

SG\_Thaur / SG Thaur 1

Ergebnis: **308.6** (295)  
 Serien: 102.0 103.9 102.7  
 Zähler: 26 3 1 0 0 0 0 0 0  
 Innenzehner: 22  
 Weitestе: 588 (22.), 364 (6.), 275 (29.)  
 beste Teiler: 17.8 (21.), 51.0 (4.), 59.0 (20.)  
 Trefferlage: 0.23 mm links, 0.73 mm tief  
 Streuwert: 1.34, horizontal: 1.54, vertikal: 1.10

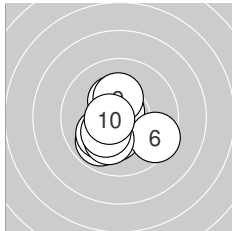
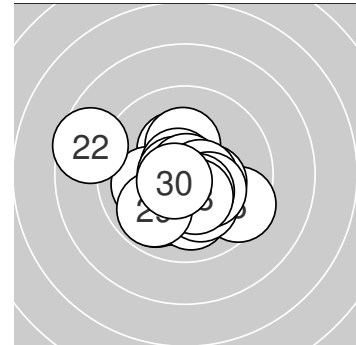

**Serie 1:**

9.9 ↙	10.3 *	10.3 *	10.7 *	10.1 ↗
9.5 ↘	10.1 ↙	10.2 *	10.3 *	10.6 *

beste Teiler: 51.0 (4.), 92.5 (10.), 158.2 (2.)  
 Trefferlage: 0.44 mm links, 0.68 mm tief  
 Streuwert: 1.43, horizontal: 1.40, vertikal: 1.45

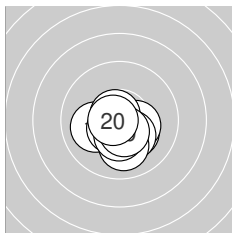

**Serie 2:**

10.1 ↙	10.3 *	10.4 *	10.3 *	10.0 ↓
10.5 *	10.7 *	10.4 *	10.5 *	10.7 *

beste Teiler: 59.0 (20.), 63.1 (17.), 101.1 (16.)  
 Trefferlage: 0.05 mm rechts, 0.84 mm tief  
 Streuwert: 0.94, horizontal: 1.09, vertikal: 0.77

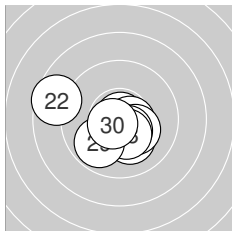

**Serie 3:**

10.9 *	8.6 ↖	10.6 *	10.6 *	10.2 *
10.3 *	10.5 *	10.4 *	9.9 ↙	10.7 *

beste Teiler: 17.8 (21.), 75.1 (30.), 84.7 (24.)  
 Trefferlage: 0.33 mm links, 0.67 mm tief  
 Streuwert: 1.66, horizontal: 2.08, vertikal: 1.08



# LG Mixed Quali – Wertung – offene Klasse

StartNr: 38

StandNr: 143

12. November 2022 10:17

Egger,, Walter #70233113

SG\_Thaur / SG Thaur 1

**Ergebnis: 315.3 (300)**  
**Serien: 104.0 106.1 105.2**  
**Zähler: 30 0 0 0 0 0 0 0 0 0**  
**Innenzehner: 26**  
**Weiteste: 221 (21.), 218 (5.), 204 (24.)**  
**beste Teiler: 27.7 (16.), 33.2 (12.), 55.0 (22.)**  
**Trefferlage: 0.11 mm links, 0.19 mm hoch**  
**Streuwert: 0.88, horizontal: 0.87, vertikal: 0.88**

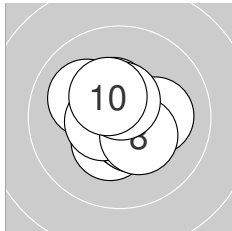
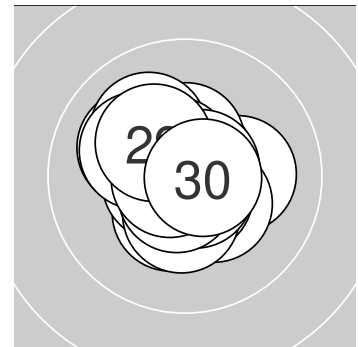

**Serie 1:**

10.1 →	10.4 *	10.5 *	10.5 *	10.1 ↖
10.6 *	10.5 *	10.3 *	10.6 *	10.4 *

**beste Teiler: 94.4 (9.), 95.3 (6.), 102.4 (3.)**  
**Trefferlage: 0.01 mm rechts, 0.00 mm**  
**Streuwert: 1.08, horizontal: 1.13, vertikal: 1.03**

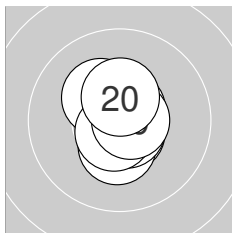

**Serie 2:**

10.6 *	10.8 *	10.3 *	10.4 *	10.7 *
10.8 *	10.7 *	10.7 *	10.7 *	10.4 *

**beste Teiler: 27.7 (16.), 33.2 (12.), 63.0 (19.)**  
**Trefferlage: 0.07 mm rechts, 0.04 mm tief**  
**Streuwert: 0.73, horizontal: 0.50, vertikal: 0.90**

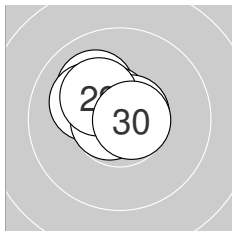

**Serie 3:**

10.1 ↖	10.7 *	10.7 *	10.1 ↖	10.6 *
10.6 *	10.7 *	10.7 *	10.3 *	10.7 *

**beste Teiler: 55.0 (22.), 58.8 (27.), 65.0 (23.)**  
**Trefferlage: 0.44 mm links, 0.62 mm hoch**  
**Streuwert: 0.74, horizontal: 0.87, vertikal: 0.58**



**Ergebnis:** **306.0** (291)  
**Serien:** 102.4 104.0 99.6  
**Zähler:** 22 7 1 0 0 0 0 0 0  
**Innenzehner:** 18  
**Weiteste:** 511 (25.), 355 (9.), 352 (23.)  
**beste Teiler:** 14.5 (1.), 47.0 (16.), 53.4 (13.)  
**Trefferlage:** 0.81 mm links, 0.16 mm hoch  
**Streuwert:** 1.45, horizontal: 1.64, vertikal: 1.23

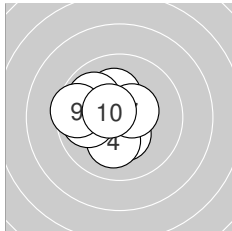
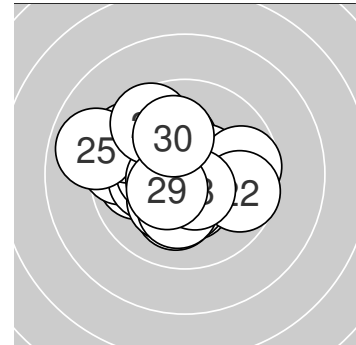

**Serie 1:**

10.9 *	10.4 *	10.4 *	10.1 ↓	10.2 *
9.9 ↘	10.5 *	9.9 ←	9.5 ←	10.6 *

**beste Teiler:** 14.5 (1.), 100.4 (10.), 114.9 (7.)  
**Trefferlage:** 1.00 mm links, 0.18 mm hoch  
**Streuwert:** 1.29, horizontal: 1.40, vertikal: 1.16

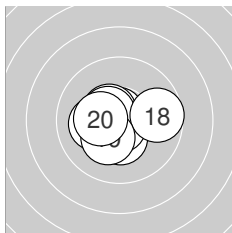

**Serie 2:**

10.7 *	10.4 *	10.7 *	10.1 ←	10.5 *
10.8 *	10.5 *	9.7 →	10.3 *	10.3 *

**beste Teiler:** 47.0 (16.), 53.4 (13.), 61.8 (11.)  
**Trefferlage:** 0.37 mm links, 0.18 mm tief  
**Streuwert:** 1.14, horizontal: 1.40, vertikal: 0.80

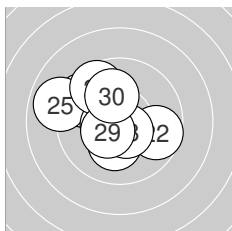

**Serie 3:**

10.1 ↘	9.7 →	9.5 ↘	10.2 *	8.9 ←
10.5 *	9.6 ↘	10.6 *	10.4 *	10.1 ↗

**beste Teiler:** 100.4 (28.), 106.7 (26.), 128.5 (29.)  
**Trefferlage:** 1.07 mm links, 0.49 mm hoch  
**Streuwert:** 1.87, horizontal: 2.10, vertikal: 1.61



# LG Mixed Quali – Wertung – offene Klasse

StartNr: 40

StandNr: 145

12. November 2022 10:25

Quickner,, Egon #70225036 SG\_Wattens–Rettenberg / SG Wattens–Rettenberg 1

Ergebnis: **303.6** (290)  
 Serien: 102.1 101.6 99.9  
 Zähler: 21 8 1 0 0 0 0 0 0  
 Innenzehner: 14  
 Weitesten: 596 (16.), 465 (23.), 357 (21.)  
 beste Teiler: 39.0 (10.), 50.2 (13.), 59.9 (15.)  
 Trefferlage: 0.64 mm links, 0.19 mm tief  
 Streuwert: 1.67, horizontal: 1.72, vertikal: 1.61

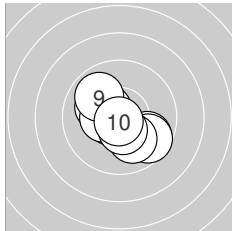
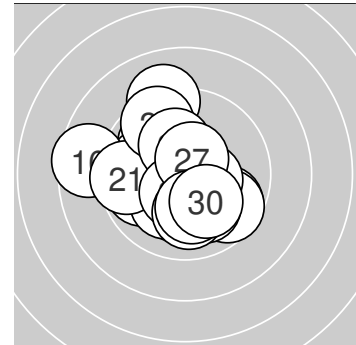

**Serie 1:**

10.4 *	10.1 ↘	9.7 ↘	10.6 *	9.7 ↘
10.0 ↘	10.4 *	10.5 *	9.9 ↘	10.8 *

beste Teiler: 39.0 (10.), 86.4 (4.), 121.7 (8.)  
 Trefferlage: 0.05 mm links, 0.40 mm tief  
 Streuwert: 1.51, horizontal: 1.69, vertikal: 1.32

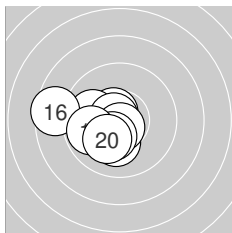

**Serie 2:**

10.1 ↓	10.6 *	10.8 *	9.9 ←	10.7 *
8.6 ←	10.7 *	10.3 *	9.8 ←	10.1 ↙

beste Teiler: 50.2 (13.), 59.9 (15.), 65.2 (17.)  
 Trefferlage: 1.46 mm links, 0.43 mm tief  
 Streuwert: 1.48, horizontal: 1.80, vertikal: 1.06

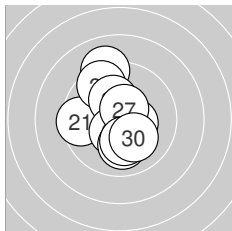

**Serie 3:**

9.5 ←	10.4 *	9.1 ↑	9.5 ↘	10.2 *
10.5 *	10.5 *	10.0 ↓	10.1 ↓	10.1 ↘

beste Teiler: 102.9 (27.), 123.8 (26.), 133.6 (22.)  
 Trefferlage: 0.40 mm links, 0.26 mm hoch  
 Streuwert: 1.93, horizontal: 1.49, vertikal: 2.28



# LG Mixed Quali – Wertung – offene Klasse

StartNr: 41

StandNr: 146

12. November 2022 10:21

Iacob,, Cosmin #70312095

SG\_Sportschützen\_St.\_Johann / SG St. Johann 1

Ergebnis: **310.0** (297)  
 Serien: 104.0 101.7 104.3  
 Zähler: 27 3 0 0 0 0 0 0 0  
 Innenzehner: 24  
 Weitesten: 299 (14.), 290 (16.), 284 (20.)  
 beste Teiler: 28.1 (22.), 36.0 (23.), 68.8 (10.)  
 Trefferlage: 0.23 mm links, 0.12 mm hoch  
 Streuwert: 1.19, horizontal: 1.23, vertikal: 1.14

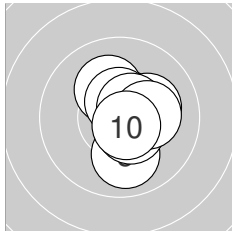
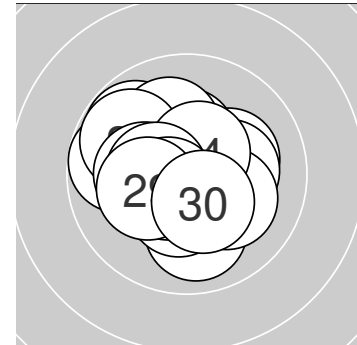

**Serie 1:**

10.6 *	10.2 *	10.2 *	10.5 *	10.0 ↓
10.6 *	10.5 *	10.5 *	10.2 *	10.7 *

beste Teiler: 68.8 (10.), 92.9 (1.), 97.8 (6.)  
 Trefferlage: 0.63 mm rechts, 0.08 mm hoch  
 Streuwert: 1.01, horizontal: 0.77, vertikal: 1.20

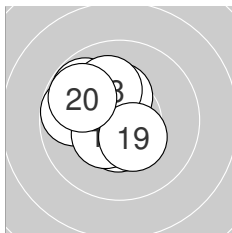

**Serie 2:**

10.2 *	10.5 *	10.4 *	9.8 ←	10.4 *
9.8 ↘	10.3 *	10.1 ↗	10.4 *	9.8 ↖

beste Teiler: 115.3 (12.), 126.7 (13.), 130.1 (15.)  
 Trefferlage: 1.02 mm links, 0.67 mm hoch  
 Streuwert: 1.24, horizontal: 1.19, vertikal: 1.28

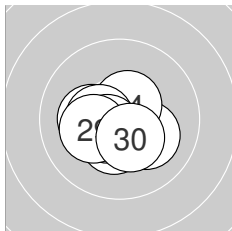

**Serie 3:**

10.1 ↘	10.8 *	10.8 *	10.5 *	10.4 *
10.2 *	10.4 *	10.5 *	10.2 *	10.4 *

beste Teiler: 28.1 (22.), 36.0 (23.), 102.6 (28.)  
 Trefferlage: 0.31 mm links, 0.39 mm tief  
 Streuwert: 0.95, horizontal: 1.14, vertikal: 0.71



# LG Mixed Quali – Wertung – offene Klasse

StartNr: 42

StandNr: 147

12. November 2022 10:23

Zamfir,, Daniela #70312093

SG\_Sportschützen\_St.\_Johann / SG St. Johann 1

Ergebnis: **310.9** (296)  
 Serien: 103.4 103.5 104.0  
 Zähler: 26 4 0 0 0 0 0 0 0 0  
 Innenzehner: 21  
 Weitesten: 323 (5.), 284 (15.), 273 (24.)  
 beste Teiler: 27.2 (10.), 32.2 (13.), 57.4 (21.)  
 Trefferlage: 0.10 mm rechts, 0.31 mm tief  
 Streuwert: 1.18, horizontal: 1.45, vertikal: 0.83

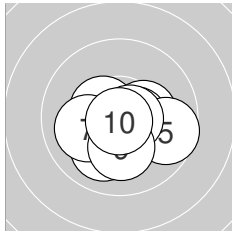
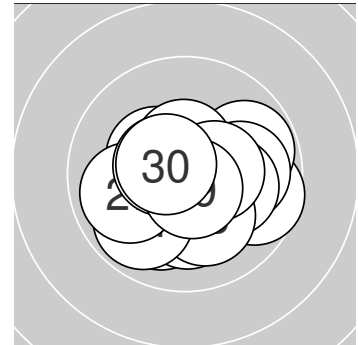

**Serie 1:**

10.6 *	10.5 *	10.3 *	10.5 *	9.7 →
10.0 ↙	10.1 ←	10.7 *	10.2 *	10.8 *

beste Teiler: 27.2 (10.), 69.5 (8.), 88.4 (1.)  
 Trefferlage: 0.14 mm rechts, 0.60 mm tief  
 Streuwert: 1.24, horizontal: 1.52, vertikal: 0.85

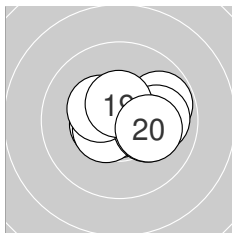

**Serie 2:**

10.7 *	10.5 *	10.8 *	10.5 *	9.8 →
10.4 *	10.0 →	10.2 *	10.5 *	10.1 →

beste Teiler: 32.2 (13.), 72.1 (11.), 108.4 (14.)  
 Trefferlage: 0.47 mm rechts, 0.08 mm hoch  
 Streuwert: 1.21, horizontal: 1.57, vertikal: 0.66

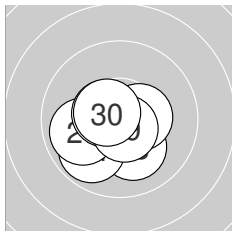

**Serie 3:**

10.7 *	10.6 *	10.1 ↘	9.9 ↙	10.6 *
10.4 *	9.9 ←	10.5 *	10.7 *	10.6 *

beste Teiler: 57.4 (21.), 71.1 (29.), 91.5 (25.)  
 Trefferlage: 0.29 mm links, 0.44 mm tief  
 Streuwert: 1.10, horizontal: 1.29, vertikal: 0.88

