

LG Mixed Quali – Wertung – offene Klasse

StartNr: 1

StandNr: 103

12. November 2022 10:29

Blasisker,, Claudia #70204005

SG_Ellbögen / SG Ellbögen 1

Ergebnis: **300.1** (287)
 Serien: 101.1 99.7 99.3
 Zähler: 18 11 1 0 0 0 0 0 0
 Innenzehner: 15
 Weiteste: 511 (23.), 456 (20.), 447 (15.)
 beste Teiler: 39.3 (6.), 66.7 (26.), 76.0 (7.)
 Trefferlage: 0.48 mm links, 0.04 mm hoch
 Streuwert: 1.92, horizontal: 2.22, vertikal: 1.56

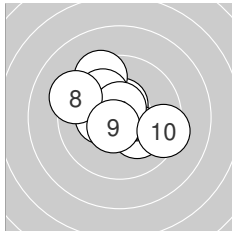
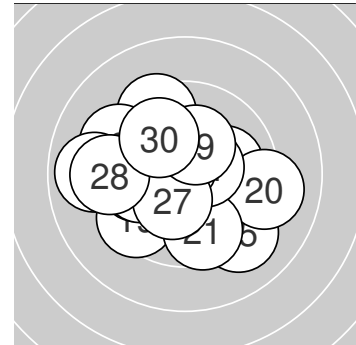

Serie 1:

10.5 *	9.4 ↘	10.2 *	10.3 *	10.0 ↘
10.8 *	10.6 *	9.3 ↘	10.6 *	9.4 →

beste Teiler: 39.3 (6.), 76.0 (7.), 93.4 (9.)
 Trefferlage: 0.35 mm links, 0.52 mm hoch
 Streuwert: 1.77, horizontal: 2.00, vertikal: 1.51

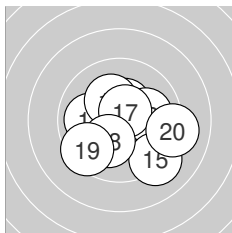

Serie 2:

10.5 *	10.4 *	10.0 →	10.0 ←	9.2 ↘
10.2 *	10.6 *	10.2 *	9.5 ↙	9.1 →

beste Teiler: 88.5 (17.), 116.5 (11.), 137.2 (12.)
 Trefferlage: 0.36 mm rechts, 0.29 mm tief
 Streuwert: 2.04, horizontal: 2.32, vertikal: 1.71

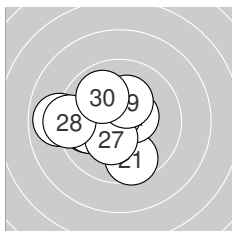

Serie 3:

9.6 ↓	9.9 ←	8.9 ←	10.5 *	9.9 ←
10.7 *	10.3 *	9.3 ←	10.3 *	9.9 ↘

beste Teiler: 66.7 (26.), 115.7 (24.), 160.5 (27.)
 Trefferlage: 1.44 mm links, 0.08 mm tief
 Streuwert: 1.85, horizontal: 2.16, vertikal: 1.48



LG Mixed Quali – Wertung – offene Klasse

StartNr: 2

StandNr: 104

12. November 2022 10:29

Gutheinz,, Johannes #70204053

SG_Ellbögen / SG Ellbögen 1

Ergebnis: **304.8** (294)
 Serien: 102.5 101.6 100.7
 Zähler: 24 6 0 0 0 0 0 0 0 0
 Innenzehner: 16
 Weitester: 456 (22.), 368 (24.), 311 (13.)
 beste Teiler: 62.0 (16.), 64.1 (4.), 96.5 (30.)
 Trefferlage: 0.47 mm links, 0.07 mm tief
 Streuwert: 1.52, horizontal: 1.45, vertikal: 1.59

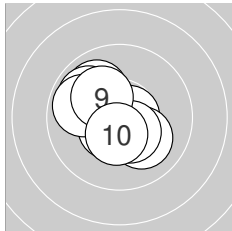
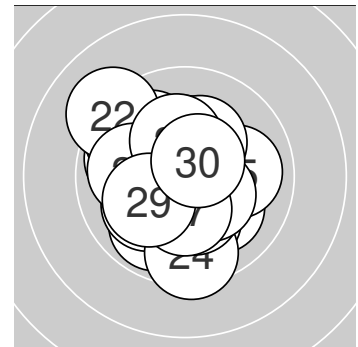

Serie 1:

10.0 ↘	10.3 *	10.5 *	10.7 *	10.1 ↘
10.4 *	9.9 ↘	9.9 ↘	10.2 *	10.5 *

beste Teiler: 64.1 (4.), 108.9 (3.), 122.9 (10.)
 Trefferlage: 0.72 mm links, 0.17 mm hoch
 Streuwert: 1.31, horizontal: 1.38, vertikal: 1.24

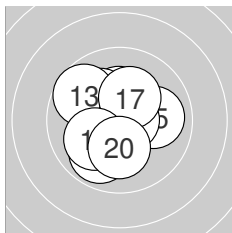

Serie 2:

10.3 *	10.1 ↘	9.7 ↘	10.4 *	10.0 →
10.7 *	10.2 *	9.9 ↗	10.1 ↗	10.2 *

beste Teiler: 62.0 (16.), 138.3 (14.), 163.1 (11.)
 Trefferlage: 0.20 mm links, 0.13 mm hoch
 Streuwert: 1.55, horizontal: 1.56, vertikal: 1.55

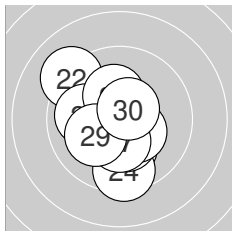

Serie 3:

10.1 ↓	9.1 ↘	10.0 ←	9.5 ↓	10.3 *
10.4 *	10.3 *	10.3 *	10.1 ↗	10.6 *

beste Teiler: 96.5 (30.), 146.2 (26.), 158.0 (27.)
 Trefferlage: 0.50 mm links, 0.51 mm tief
 Streuwert: 1.75, horizontal: 1.52, vertikal: 1.96



LG Mixed Quali – Wertung – offene Klasse

StartNr: 3

StandNr: 105

12. November 2022 10:25

Felderer,, Lisa #70233005

SG_Thaur / SG Thaur 1

Ergebnis: **310.2** (297)
 Serien: 103.4 103.8 103.0
 Zähler: 27 3 0 0 0 0 0 0 0 0
 Innenzehner: 24
 Weitest: 295 (19.), 294 (4.), 262 (12.)
 beste Teiler: 54.0 (18.), 59.8 (14.), 62.0 (26.)
 Trefferlage: 0.02 mm links, 0.24 mm hoch
 Streuwert: 1.19, horizontal: 1.27, vertikal: 1.10

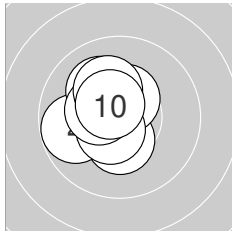
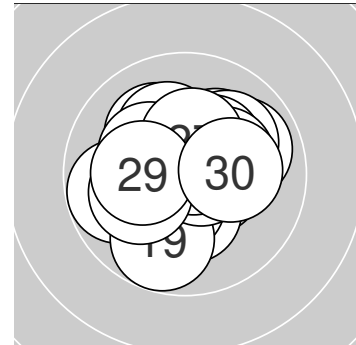

Serie 1:

10.4 *	10.3 *	10.6 *	9.8 ←	10.1 ↘
10.5 *	10.6 *	10.4 *	10.2 *	10.5 *

beste Teiler: 78.7 (3.), 98.8 (7.), 103.6 (10.)
 Trefferlage: 0.83 mm links, 0.48 mm hoch
 Streuwert: 1.01, horizontal: 0.89, vertikal: 1.11

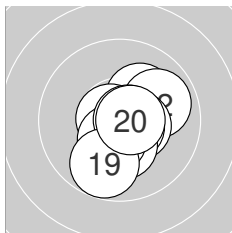

Serie 2:

10.2 *	9.9 ↗	10.5 *	10.7 *	10.6 *
10.3 *	10.4 *	10.7 *	9.8 ↓	10.7 *

beste Teiler: 54.0 (18.), 59.8 (14.), 70.0 (20.)
 Trefferlage: 0.48 mm rechts, 0.37 mm tief
 Streuwert: 1.13, horizontal: 1.01, vertikal: 1.25

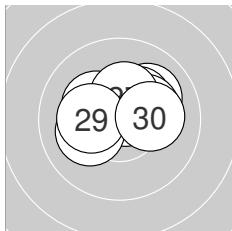

Serie 3:

10.6 *	10.0 ↗	10.3 *	10.3 *	10.2 *
10.7 *	10.4 *	10.1 ←	10.2 *	10.2 *

beste Teiler: 62.0 (26.), 97.5 (21.), 150.0 (27.)
 Trefferlage: 0.26 mm rechts, 0.62 mm hoch
 Streuwert: 1.17, horizontal: 1.51, vertikal: 0.68



LG Mixed Quali – Wertung – offene Klasse

StartNr: 4

StandNr: 106

12. November 2022 10:29

Kuen,, Johannes #70233134

SG_Thaur / SG Thaur 1

Ergebnis: 302.9 (288)
Serien: 100.2 101.2 101.5
Zähler: 18 12 0 0 0 0 0 0 0
Innenzehner: 14
Weiteste: 475 (17.), 362 (5.), 350 (9.)
beste Teiler: 68.3 (15.), 88.4 (20.), 97.0 (22.)
Trefferlage: 0.11 mm rechts, 0.17 mm tief
Streuwert: 1.71, horizontal: 1.97, vertikal: 1.41

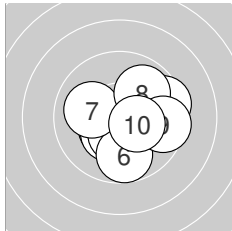
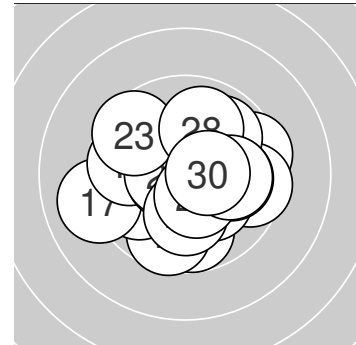

Serie 1:

10.4 *	9.9 ↗	10.3 *	10.4 *	9.5 →
9.8 ↓	10.0 ←	9.9 ↗	9.6 →	10.4 *

beste Teiler: 136.1 (4.), 138.1 (1.), 147.4 (10.)
Trefferlage: 0.83 mm rechts, 0.25 mm tief
Streuwert: 1.74, horizontal: 1.95, vertikal: 1.50

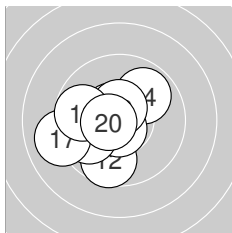

Serie 2:

10.3 *	9.7 ↓	10.6 *	9.9 ↗	10.7 *
9.9 ↖	9.1 ←	10.6 *	9.8 ←	10.6 *

beste Teiler: 68.3 (15.), 88.4 (20.), 99.1 (18.)
Trefferlage: 1.21 mm links, 0.23 mm tief
Streuwert: 1.62, horizontal: 1.77, vertikal: 1.45

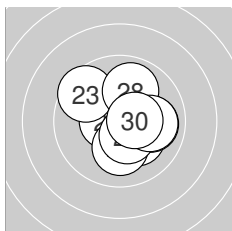

Serie 3:

10.2 *	10.6 *	9.6 ↘	10.1 ↓	10.0 →
10.2 *	10.4 *	9.9 ↗	10.0 →	10.5 *

beste Teiler: 97.0 (22.), 121.1 (30.), 130.1 (27.)
Trefferlage: 0.72 mm rechts, 0.02 mm tief
Streuwert: 1.51, horizontal: 1.60, vertikal: 1.41



LG Mixed Quali – Wertung – offene Klasse

StartNr: 5

StandNr: 107

12. November 2022 10:27

Blasisker,, Melanie #70204071

SG_Ellbögen / SG Ellbögen 2

Ergebnis: **281.9** (267)
 Serien: 93.8 99.1 89.0
 Zähler: 9 14 4 1 2 0 0 0 0 0
 Innenzehner: 6
 Weitester: 1121 (23.), 1021 (29.), 978 (4.)
 beste Teiler: 52.1 (7.), 61.5 (14.), 69.2 (16.)
 Trefferlage: 0.44 mm rechts, 0.79 mm tief
 Streuwert: 3.33, horizontal: 4.23, vertikal: 2.07

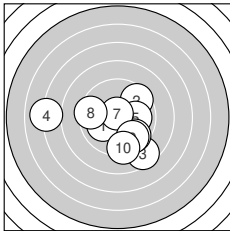
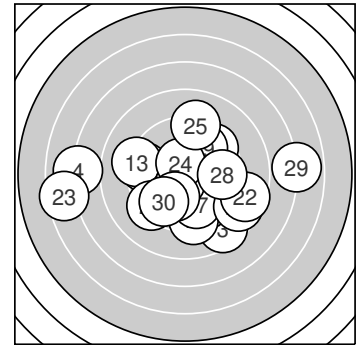

Serie 1:

10.1 ←	9.5 ↗	8.5 ↘	7.0 ←	10.0 →
9.6 ↘	10.7 *	9.5 ←	9.6 ↘	9.3 ↓

beste Teiler: 52.1 (7.), 225.8 (1.), 245.0 (5.)
 Trefferlage: 0.19 mm links, 1.15 mm tief
 Streuwert: 3.31, horizontal: 4.05, vertikal: 2.34

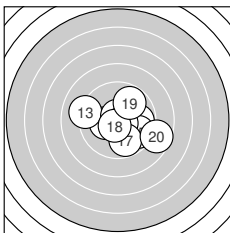

Serie 2:

9.8 →	10.3 *	9.1 ←	10.7 *	9.7 ↘
10.7 *	9.8 ↘	10.6 *	9.8 ↗	8.6 ↘

beste Teiler: 61.5 (14.), 69.2 (16.), 86.3 (18.)
 Trefferlage: 0.76 mm rechts, 0.40 mm tief
 Streuwert: 2.19, horizontal: 2.69, vertikal: 1.54

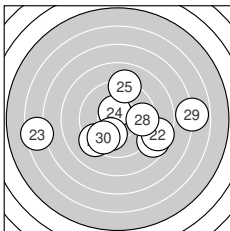

Serie 3:

8.7 ↘	8.6 ↘	6.5 ←	10.5 *	9.1 ↑
9.3 ↗	10.1 ↓	9.6 →	6.9 →	9.7 ↙

beste Teiler: 109.5 (24.), 224.6 (27.), 315.8 (30.)
 Trefferlage: 0.75 mm rechts, 0.83 mm tief
 Streuwert: 4.42, horizontal: 5.78, vertikal: 2.37



LG Mixed Quali – Wertung – offene Klasse

StartNr: 6

StandNr: 108

12. November 2022 10:34

Waldauer,, Thomas #70204026

SG_Ellbögen / SG Ellbögen 2

Ergebnis: **302.6** (288)
 Serien: 101.5 99.2 101.9
 Zähler: 19 10 1 0 0 0 0 0 0 0
 Innenzehner: 15
 Weitestе: 581 (26.), 366 (19.), 342 (3.)
 beste Teiler: 49.7 (22.), 79.6 (5.), 84.3 (29.)
 Trefferlage: 0.40 mm links, 0.34 mm hoch
 Streuwert: 1.69, horizontal: 1.89, vertikal: 1.47

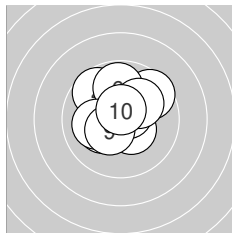
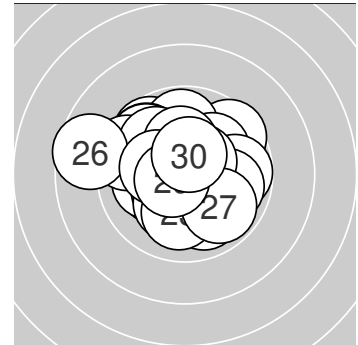

Serie 1:

10.2 *	10.4 *	9.6 ↗	9.7 ↘	10.6 *
9.8 ↑	10.1 ←	10.1 ↗	10.4 *	10.6 *

beste Teiler: 79.6 (5.), 85.0 (10.), 131.5 (2.)
 Trefferlage: 0.11 mm links, 0.70 mm hoch
 Streuwert: 1.53, horizontal: 1.60, vertikal: 1.46

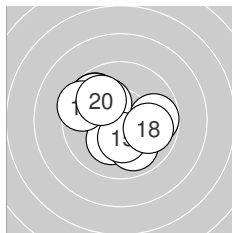

Serie 2:

9.8 →	10.2 *	10.2 *	9.9 ↘	10.3 *
9.7 ↘	9.7 ↘	9.9 →	9.5 ←	10.0 ↘

beste Teiler: 157.0 (15.), 192.3 (13.), 195.2 (12.)
 Trefferlage: 0.51 mm links, 0.23 mm hoch
 Streuwert: 1.93, horizontal: 2.15, vertikal: 1.68

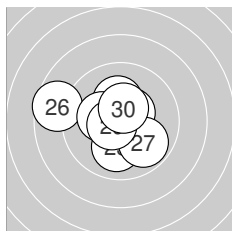

Serie 3:

10.2 *	10.8 *	10.0 ↓	10.6 *	10.5 *
8.6 ←	9.8 ↘	10.3 *	10.6 *	10.5 *

beste Teiler: 49.7 (22.), 84.3 (29.), 84.7 (24.)
 Trefferlage: 0.59 mm links, 0.09 mm hoch
 Streuwert: 1.73, horizontal: 2.05, vertikal: 1.33



LG Mixed Quali – Wertung – offene Klasse

StartNr: 7

StandNr: 109

12. November 2022 10:33

Kostenzer,, Alexander #70415010

SG_Münster / SG Münster 3

Ergebnis: 294.8 (285)
Serien: 98.6 96.0 100.2
Zähler: 18 9 3 0 0 0 0 0 0
Innenzehner: 6
Weiteste: 701 (17.), 665 (18.), 540 (21.)
beste Teiler: 51.6 (2.), 70.4 (25.), 133.6 (30.)
Trefferlage: 0.08 mm rechts, 0.63 mm hoch
Streuwert: 2.25, horizontal: 2.43, vertikal: 2.05

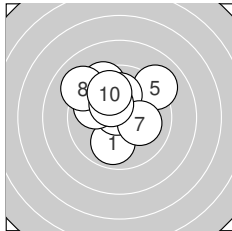
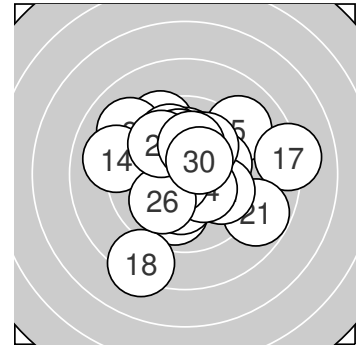

Serie 1:
 9.9 ↙ 10.7 * 9.9 ↖ 9.5 ↖ 9.1 ↗
 10.1 ↑ 10.1 → 9.1 ↘ 10.3 * 9.9 ↖
beste Teiler: 51.6 (2.), 154.7 (9.), 209.4 (7.)
Trefferlage: 0.49 mm links, 1.36 mm hoch
Streuwert: 1.96, horizontal: 2.08, vertikal: 1.85

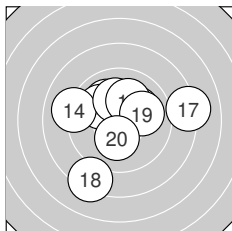

Serie 2:
 10.1 ↗ 10.0 ↘ 10.0 ↘ 9.1 ← 10.1 ↑
 10.1 ↗ 8.1 → 8.3 ↘ 10.0 → 10.2 *
beste Teiler: 182.0 (20.), 205.7 (15.), 207.1 (11.)
Trefferlage: 0.02 mm rechts, 0.34 mm hoch
Streuwert: 2.86, horizontal: 3.20, vertikal: 2.47

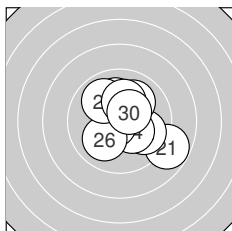

Serie 3:
 8.8 ↘ 9.9 ↘ 10.1 ↑ 10.3 * 10.7 *
 10.0 ↘ 10.0 ↗ 9.9 ↘ 10.1 ↑ 10.4 *
beste Teiler: 70.4 (25.), 133.6 (30.), 160.2 (24.)
Trefferlage: 0.71 mm rechts, 0.21 mm hoch
Streuwert: 1.86, horizontal: 1.93, vertikal: 1.78



LG Mixed Quali – Wertung – offene Klasse

StartNr: 8

StandNr: 110

12. November 2022 10:23

Rauter,, Julia #70415225

SG_Münster / SG Münster 3

Ergebnis: 291.8 (279)
Serien: 97.3 99.3 95.2
Zähler: 13 13 4 0 0 0 0 0 0 0
Innenzehner: 11
Weiteste: 684 (4.), 678 (27.), 661 (25.)
beste Teiler: 6.3 (2.), 47.0 (20.), 80.9 (21.)
Trefferlage: 0.03 mm links, 1.19 mm hoch
Streuwert: 2.41, horizontal: 2.16, vertikal: 2.64

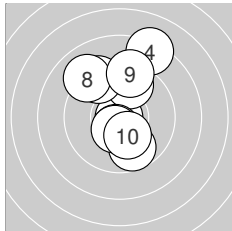
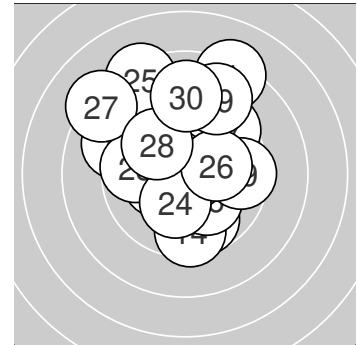

Serie 1:

9.7 ↘	10.9 *	9.7 ↑	8.2 ↑	10.5 *
10.5 *	9.3 ↘	9.0 ↘	9.3 ↑	10.2 *

beste Teiler: 6.3 (2.), 109.7 (5.), 121.2 (6.)
Trefferlage: 0.08 mm rechts, 1.39 mm hoch
Streuwert: 2.48, horizontal: 1.69, vertikal: 3.07

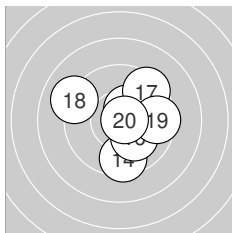

Serie 2:

10.2 *	10.3 *	9.9 ↗	9.5 ↓	10.4 *
10.1 ↘	9.5 ↗	9.1 ↖	9.5 →	10.8 *

beste Teiler: 47.0 (20.), 130.9 (15.), 160.7 (12.)
Trefferlage: 0.98 mm rechts, 0.07 mm hoch
Streuwert: 1.99, horizontal: 2.10, vertikal: 1.88

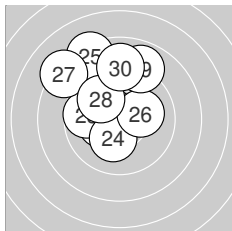

Serie 3:

10.6 *	10.3 *	9.7 ←	10.2 *	8.3 ↘
10.1 →	8.2 ↘	9.9 ↘	8.9 ↑	9.0 ↑

beste Teiler: 80.9 (21.), 173.4 (22.), 188.1 (24.)
Trefferlage: 1.17 mm links, 2.11 mm hoch
Streuwert: 2.47, horizontal: 2.26, vertikal: 2.67



LG Mixed Quali – Wertung – offene Klasse

StartNr: 9

StandNr: 111

12. November 2022 10:26

Holzkecht,, Wolfgang #70209010

SG_Hötting-Ibk / SG Hötting-Ibk 1

Ergebnis: **299.7** (287)
 Serien: 99.8 100.4 99.5
 Zähler: 18 11 1 0 0 0 0 0 0
 Innenzehner: 16
 Weitestе: 567 (26.), 489 (12.), 437 (3.)
 beste Teiler: 58.8 (25.), 87.9 (2.), 102.8 (24.)
 Trefferlage: 0.04 mm links, 0.61 mm hoch
 Streuwert: 1.91, horizontal: 2.25, vertikal: 1.50

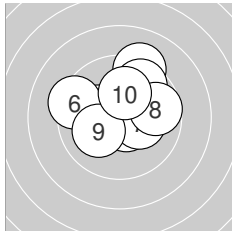
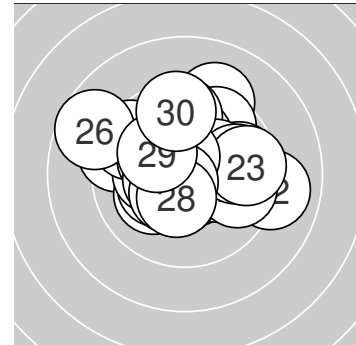

Serie 1:

10.5 *	10.6 *	9.2 ↑	9.7 ↑	10.2 *
9.4 ↖	10.3 *	9.7 →	10.1 ↙	10.1 ↑

beste Teiler: 87.9 (2.), 122.0 (1.), 171.9 (7.)
 Trefferlage: 0.06 mm rechts, 0.84 mm hoch
 Streuwert: 1.91, horizontal: 2.12, vertikal: 1.66

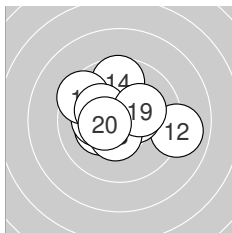

Serie 2:

10.3 *	9.0 →	10.4 *	9.7 ↑	10.2 *
9.5 ↖	10.2 *	10.5 *	10.2 *	10.4 *

beste Teiler: 124.0 (18.), 129.0 (20.), 129.5 (13.)
 Trefferlage: 0.20 mm links, 0.41 mm hoch
 Streuwert: 1.88, horizontal: 2.28, vertikal: 1.36

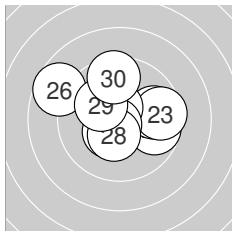

Serie 3:

9.7 →	9.8 →	9.6 →	10.5 *	10.7 *
8.7 ↖	10.4 *	10.4 *	10.2 *	9.5 ↑

beste Teiler: 58.8 (25.), 102.8 (24.), 138.9 (27.)
 Trefferlage: 0.00 mm , 0.57 mm hoch
 Streuwert: 2.12, horizontal: 2.56, vertikal: 1.57



LG Mixed Quali – Wertung – offene Klasse

StartNr: 10

StandNr: 112

12. November 2022 10:30

Kathrein,, Johanna #70209011

SG_Hötting-Ibk / SG Hötting-Ibk 1

Ergebnis: **305.9** (291)
 Serien: 102.5 101.0 102.4
 Zähler: 21 9 0 0 0 0 0 0 0 0
 Innenzehner: 17
 Weitestе: 429 (25.), 387 (16.), 370 (9.)
 beste Teiler: 16.4 (1.), 34.3 (20.), 44.2 (6.)
 Trefferlage: 0.15 mm rechts, 0.18 mm tief
 Streuwert: 1.59, horizontal: 1.79, vertikal: 1.36

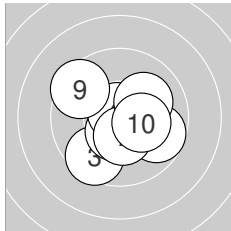
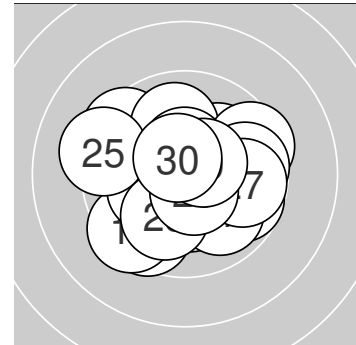

Serie 1:

10.9 *	10.7 *	9.6 ↙	10.5 *	9.7 ↘
10.8 *	10.4 *	10.1 ↗	9.5 ↘	10.3 *
beste Teiler: 16.4 (1.), 44.2 (6.), 62.2 (2.)				
Trefferlage: 0.13 mm rechts, 0.38 mm tief				
Streuwert: 1.58, horizontal: 1.73, vertikal: 1.42				

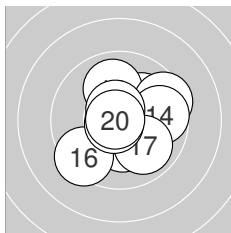

Serie 2:

10.1 ↗	10.0 ↑	9.5 ↗	9.7 →	10.3 *
9.4 ↙	9.9 ↘	10.6 *	10.7 *	10.8 *
beste Teiler: 34.3 (20.), 51.3 (19.), 86.5 (18.)				
Trefferlage: 0.57 mm rechts, 0.01 mm tief				
Streuwert: 1.76, horizontal: 1.86, vertikal: 1.65				

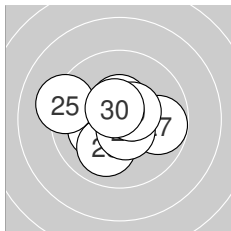

Serie 3:

10.5 *	10.2 *	10.0 ↙	10.5 *	9.2 ←
10.5 *	9.8 →	10.6 *	10.5 *	10.6 *
beste Teiler: 91.2 (30.), 96.6 (28.), 107.0 (24.)				
Trefferlage: 0.23 mm links, 0.14 mm tief				
Streuwert: 1.53, horizontal: 1.88, vertikal: 1.08				



LG Mixed Quali – Wertung – offene Klasse

StartNr: 11

StandNr: 113

12. November 2022 10:29

Hirner,, Julia #70415212

SG_Münster / SG Münster 1

Ergebnis: **308.9** (294)
 Serien: 102.3 104.3 102.3
 Zähler: 24 6 0 0 0 0 0 0 0
 Innenzehner: 19
 Weitesten: 376 (7.), 273 (14.), 267 (24.)
 beste Teiler: 10.2 (27.), 39.0 (2.), 59.6 (11.)
 Trefferlage: 0.09 mm rechts, 0.48 mm tief
 Streuwert: 1.28, horizontal: 1.38, vertikal: 1.16

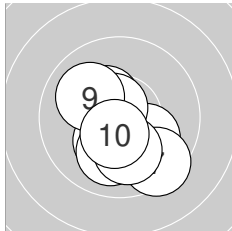
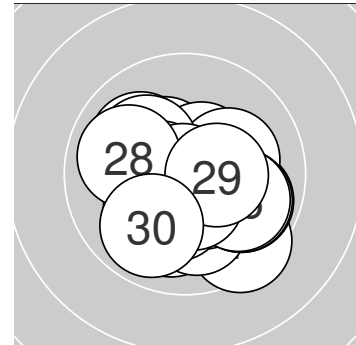

Serie 1:

10.4 *	10.8 *	10.1 ↘	10.3 *	10.7 *
10.0 ↓	9.4 ↘	10.1 ↓	10.0 ↖	10.5 *

beste Teiler: 39.0 (2.), 74.3 (5.), 113.8 (10.)
 Trefferlage: 0.07 mm links, 0.80 mm tief
 Streuwert: 1.40, horizontal: 1.28, vertikal: 1.50

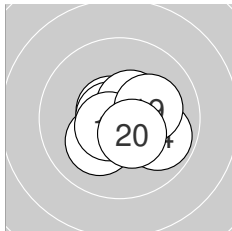

Serie 2:

10.7 *	10.5 *	10.6 *	9.9 ↘	10.2 *
10.7 *	10.5 *	10.6 *	10.2 *	10.4 *

beste Teiler: 59.6 (11.), 62.3 (16.), 77.3 (13.)
 Trefferlage: 0.42 mm rechts, 0.13 mm tief
 Streuwert: 1.05, horizontal: 1.21, vertikal: 0.85

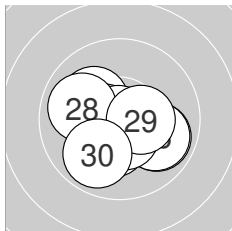

Serie 3:

10.1 ↖	10.5 *	10.3 *	9.9 ↘	9.9 ↘
10.5 *	10.9 *	9.9 ↖	10.4 *	9.9 ↙

beste Teiler: 10.2 (27.), 106.1 (22.), 111.0 (26.)
 Trefferlage: 0.06 mm links, 0.51 mm tief
 Streuwert: 1.41, horizontal: 1.68, vertikal: 1.07



LG Mixed Quali – Wertung – offene Klasse

StartNr: 12

StandNr: 114

12. November 2022 10:34

Kostenzer,, Thomas #70415053

SG_Münster / SG Münster 1

Ergebnis: **301.5** (289)
 Serien: 102.1 99.9 99.5
 Zähler: 19 11 0 0 0 0 0 0 0
 Innenzehner: 15
 Weitester: 451 (19.), 441 (22.), 407 (17.)
 beste Teiler: 17.0 (2.), 68.4 (6.), 102.3 (11.)
 Trefferlage: 0.31 mm rechts, 0.33 mm tief
 Streuwert: 1.79, horizontal: 1.84, vertikal: 1.74

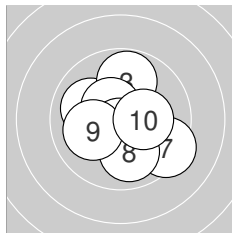
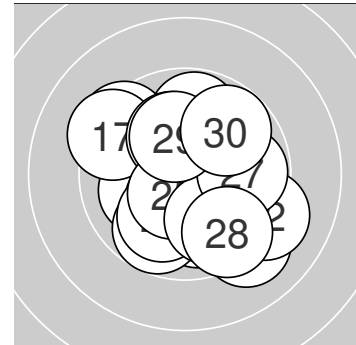

Serie 1:

10.0 ↖	10.9 *	9.8 ↑	10.5 *	10.4 *
10.7 *	9.4 ↘	10.0 ↓	10.1 ↖	10.3 *

beste Teiler: 17.0 (2.), 68.4 (6.), 111.3 (4.)
 Trefferlage: 0.19 mm rechts, 0.23 mm tief
 Streuwert: 1.60, horizontal: 1.67, vertikal: 1.52

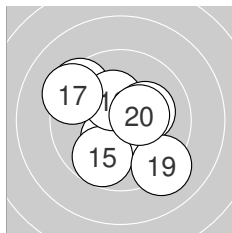

Serie 2:

10.5 *	10.5 *	10.4 *	9.4 ↖	9.8 ↙
10.3 *	9.3 ↖	10.2 *	9.1 ↘	10.4 *

beste Teiler: 102.3 (11.), 102.6 (12.), 144.1 (20.)
 Trefferlage: 0.16 mm links, 0.19 mm tief
 Streuwert: 2.01, horizontal: 2.10, vertikal: 1.91

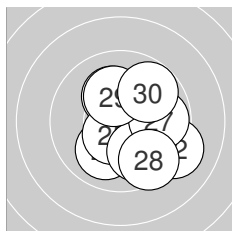

Serie 3:

10.4 *	9.2 ↘	10.0 ↙	10.2 *	10.5 *
9.9 ↘	9.8 →	9.5 ↘	10.2 *	9.8 ↗

beste Teiler: 114.0 (25.), 149.3 (21.), 191.9 (29.)
 Trefferlage: 0.91 mm rechts, 0.57 mm tief
 Streuwert: 1.83, horizontal: 1.75, vertikal: 1.92



LG Mixed Quali – Wertung – offene Klasse

StartNr: 13

StandNr: 115

12. November 2022 10:27

Entner,, Lorena #70404054

SG_Breitenbach / SG Breitenbach 1

Ergebnis: **303.1** (291)
 Serien: 99.1 101.3 102.7
 Zähler: 21 9 0 0 0 0 0 0 0 0
 Innenzehner: 17
 Weitesten: 454 (17.), 428 (25.), 371 (6.)
 beste Teiler: 14.1 (30.), 59.6 (29.), 70.1 (15.)
 Trefferlage: 0.26 mm links, 0.26 mm tief
 Streuwert: 1.71, horizontal: 2.13, vertikal: 1.13

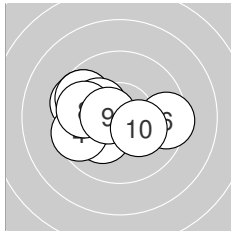
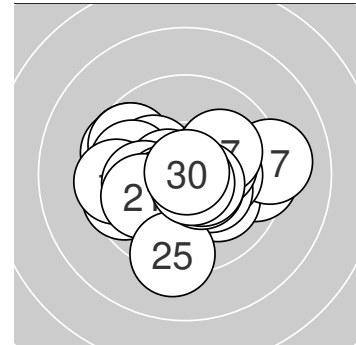

Serie 1:

9.6 ↖	9.6 ↖	10.2 *	9.6 ↖	9.7 ↖
9.5 →	10.2 *	9.8 ↖	10.6 *	10.3 *

beste Teiler: 90.9 (9.), 175.1 (10.), 186.5 (7.)
 Trefferlage: 1.37 mm links, 0.19 mm hoch
 Streuwert: 1.81, horizontal: 2.31, vertikal: 1.10

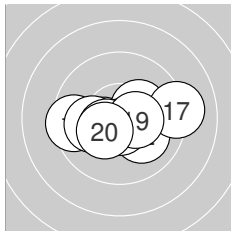

Serie 2:

10.4 *	10.1 ↘	10.3 *	9.5 ↖	10.7 *
10.1 ↖	9.1 →	10.4 *	10.4 *	10.3 *

beste Teiler: 70.1 (15.), 126.7 (19.), 127.0 (18.)
 Trefferlage: 0.02 mm links, 0.38 mm tief
 Streuwert: 1.72, horizontal: 2.34, vertikal: 0.67

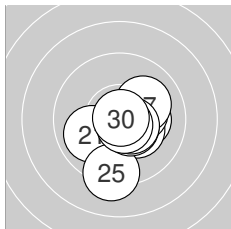

Serie 3:

10.0 ↖	10.2 *	10.3 *	10.3 *	9.2 ↓
10.5 *	10.1 ↗	10.5 *	10.7 *	10.9 *

beste Teiler: 14.1 (30.), 59.6 (29.), 104.3 (28.)
 Trefferlage: 0.60 mm rechts, 0.61 mm tief
 Streuwert: 1.36, horizontal: 1.27, vertikal: 1.44



LG Mixed Quali – Wertung – offene Klasse

StartNr: 14

StandNr: 116

12. November 2022 10:29

Entner,, Patrick #70404036

SG_Breitenbach / SG Breitenbach 1

Ergebnis: **304.4** (290)
 Serien: 100.3 100.7 103.4
 Zähler: 20 10 0 0 0 0 0 0 0 0
 Innenzehner: 14
 Weitestе: 354 (7.), 342 (30.), 338 (6.)
 beste Teiler: 42.4 (22.), 60.7 (23.), 88.5 (26.)
 Trefferlage: 0.12 mm links, 0.71 mm hoch
 Streuwert: 1.50, horizontal: 1.58, vertikal: 1.42

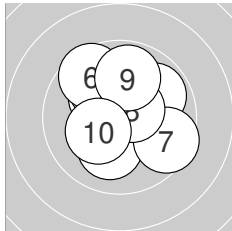
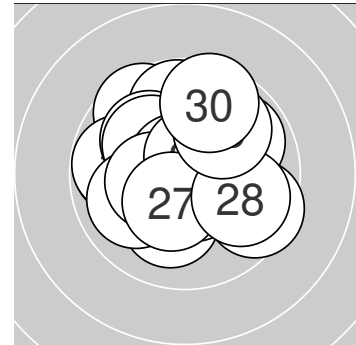

Serie 1:

10.2 *	10.1 ↙	10.2 *	9.9 ↗	10.0 ↘
9.6 ↘	9.5 ↗	10.6 *	9.9 ↑	10.3 *

beste Teiler: 99.3 (8.), 174.1 (10.), 180.7 (1.)
 Trefferlage: 0.21 mm rechts, 0.66 mm hoch
 Streuwert: 1.74, horizontal: 1.78, vertikal: 1.70

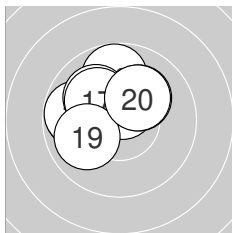

Serie 2:

10.1 ↑	9.8 ↑	9.8 ←	9.8 ←	10.1 ↘
10.6 *	10.1 ↘	10.2 *	10.0 ↙	10.2 *

beste Teiler: 96.1 (16.), 194.9 (20.), 200.0 (18.)
 Trefferlage: 0.90 mm links, 1.15 mm hoch
 Streuwert: 1.34, horizontal: 1.55, vertikal: 1.10

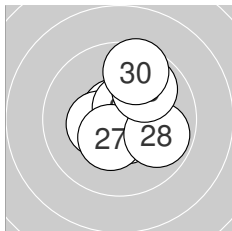

Serie 3:

10.5 *	10.8 *	10.7 *	10.6 *	10.4 *
10.6 *	10.4 *	9.9 ↗	9.9 ↗	9.6 ↑

beste Teiler: 42.4 (22.), 60.7 (23.), 88.5 (26.)
 Trefferlage: 0.31 mm rechts, 0.32 mm hoch
 Streuwert: 1.32, horizontal: 1.23, vertikal: 1.41



Ergebnis: **290.0** (278)
 Serien: 94.9 96.7 98.4
 Zähler: 14 11 4 1 0 0 0 0 0 0
 Innenzehner: 6
 Weitester: 921 (11.), 660 (5.), 568 (13.)
 beste Teiler: 95.1 (19.), 141.9 (14.), 154.1 (9.)
 Trefferlage: 0.31 mm rechts, 0.52 mm hoch
 Streuwert: 2.59, horizontal: 3.22, vertikal: 1.74

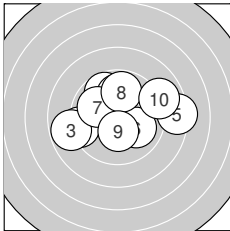
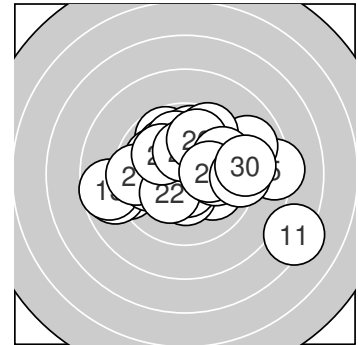

Serie 1:

9.2 ← 9.7 ↖ 8.8 ← 9.9 ↑ 8.3 →
 10.0 ↘ 10.0 ↙ 9.8 ↑ 10.3 * 8.9 →

beste Teiler: 154.1 (9.), 234.5 (6.), 250.4 (7.)
 Trefferlage: 0.06 mm rechts, 0.64 mm hoch
 Streuwert: 2.89, horizontal: 3.66, vertikal: 1.83

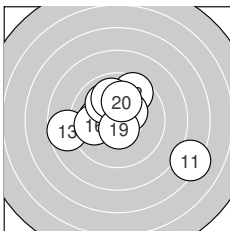

Serie 2:

7.3 ↘ 9.6 ↗ 8.7 ← 10.4 * 10.1 ←
 9.9 ← 10.0 ↘ 10.0 ↑ 10.6 * 10.1 ↑

beste Teiler: 95.1 (19.), 141.9 (14.), 212.6 (20.)
 Trefferlage: 0.09 mm links, 0.33 mm hoch
 Streuwert: 2.97, horizontal: 3.55, vertikal: 2.23

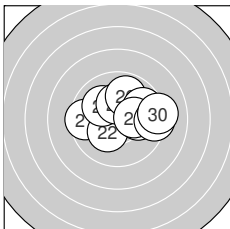

Serie 3:

9.5 ← 10.2 * 10.1 ↘ 10.0 → 10.3 *
 9.9 ↑ 9.7 → 10.2 * 9.3 → 9.2 →

beste Teiler: 171.5 (25.), 176.3 (22.), 181.8 (28.)
 Trefferlage: 0.97 mm rechts, 0.61 mm hoch
 Streuwert: 2.01, horizontal: 2.60, vertikal: 1.14



LG Mixed Quali – Wertung – offene Klasse

StartNr: 16

StandNr: 118

12. November 2022 10:26

Ramsbacher,, Martin #70415201

SG_Münster / SG Münster 2

Ergebnis: **296.8** (284)
 Serien: 100.1 96.2 100.5
 Zähler: 15 14 1 0 0 0 0 0 0 0
 Innenzehner: 13
 Weitester: 612 (13.), 465 (25.), 458 (16.)
 beste Teiler: 35.2 (18.), 40.0 (24.), 53.4 (29.)
 Trefferlage: 0.63 mm links, 0.48 mm hoch
 Streuwert: 2.14, horizontal: 2.73, vertikal: 1.31

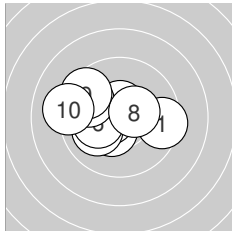
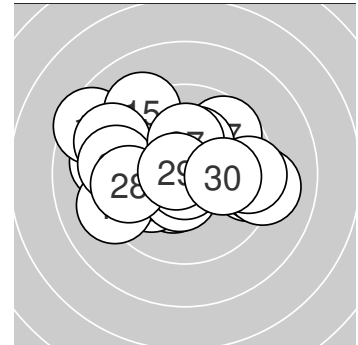

Serie 1:

9.5 →	10.4 *	10.6 *	10.1 ←	10.6 *
10.2 *	9.7 ↖	10.4 *	9.5 ↘	9.1 ←

beste Teiler: 91.0 (3.), 97.1 (5.), 137.0 (2.)
 Trefferlage: 1.04 mm links, 0.21 mm hoch
 Streuwert: 1.82, horizontal: 2.34, vertikal: 1.09

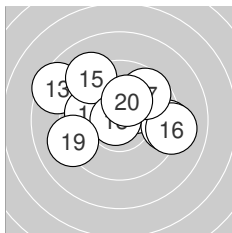

Serie 2:

10.3 *	9.3 →	8.5 ↘	9.9 ←	9.2 ↘
9.1 →	9.7 ↗	10.8 *	9.2 ←	10.2 *

beste Teiler: 35.2 (18.), 174.4 (11.), 182.5 (20.)
 Trefferlage: 0.20 mm links, 0.92 mm hoch
 Streuwert: 2.69, horizontal: 3.39, vertikal: 1.73

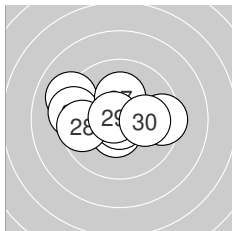

Serie 3:

9.5 →	10.7 *	10.5 *	10.8 *	9.1 ↖
9.3 ←	10.2 *	9.6 ←	10.7 *	10.1 →

beste Teiler: 40.0 (24.), 53.4 (29.), 74.3 (22.)
 Trefferlage: 0.64 mm links, 0.30 mm hoch
 Streuwert: 1.95, horizontal: 2.58, vertikal: 1.00



LG Mixed Quali – Wertung – offene Klasse

StartNr: 17

StandNr: 119

12. November 2022 10:33

Embacher,, Sonja #70420014 SG_Söller_Sportschützen / SG Söller Sportschützen 1

Ergebnis: **311.5** (297)
Serien: 103.4 104.8 103.3
Zähler: 27 3 0 0 0 0 0 0 0
Innenzehner: 25
Weiteste: 317 (7.), 313 (24.), 254 (29.)
beste Teiler: 41.8 (12.), 43.9 (22.), 48.0 (15.)
Trefferlage: 0.01 mm links, 0.15 mm tief
Streuwert: 1.13, horizontal: 1.19, vertikal: 1.07

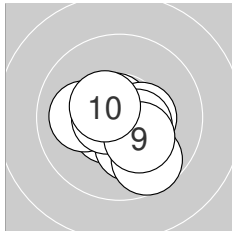
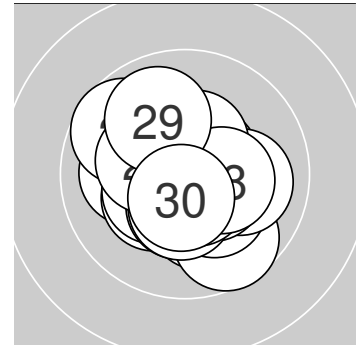

Serie 1:

10.5 *	10.2 *	10.1 ←	10.7 *	10.6 *
10.4 *	9.7 ↘	10.5 *	10.2 *	10.5 *

beste Teiler: 62.6 (4.), 79.4 (5.), 101.2 (1.)
Trefferlage: 0.10 mm rechts, 0.57 mm tief
Streuwert: 1.18, horizontal: 1.29, vertikal: 1.06

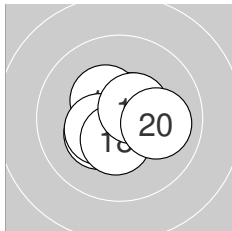

Serie 2:

10.3 *	10.8 *	10.6 *	10.6 *	10.8 *
10.4 *	10.4 *	10.4 *	10.5 *	10.0 →

beste Teiler: 41.8 (12.), 48.0 (15.), 91.9 (14.)
Trefferlage: 0.05 mm rechts, 0.12 mm tief
Streuwert: 0.97, horizontal: 1.13, vertikal: 0.79

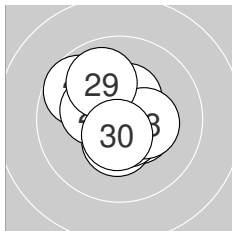

Serie 3:

10.4 *	10.8 *	10.4 *	9.7 ↖	10.4 *
10.6 *	10.3 *	10.3 *	9.9 ↗	10.5 *

beste Teiler: 43.9 (22.), 91.4 (26.), 101.2 (30.)
Trefferlage: 0.19 mm links, 0.23 mm hoch
Streuwert: 1.25, horizontal: 1.25, vertikal: 1.24



Ergebnis: 314.1 (298)
Serien: 104.7 104.9 104.5
Zähler: 28 2 0 0 0 0 0 0 0
Innenzehner: 27
Weiteste: 283 (7.), 253 (23.), 213 (24.)
beste Teiler: 35.1 (22.), 39.4 (27.), 55.1 (6.)
Trefferlage: 0.22 mm rechts, 0.07 mm hoch
Streuwert: 0.95, horizontal: 1.04, vertikal: 0.85

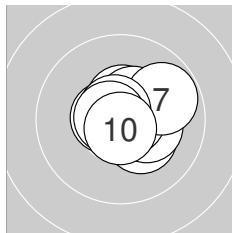
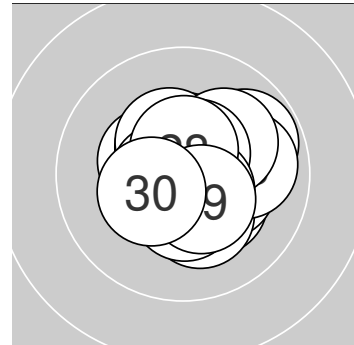

Serie 1:
 10.3 * 10.6 * 10.3 * 10.5 * 10.4 *
 10.7 * 9.8 ↗ 10.7 * 10.7 * 10.7 *
beste Teiler: 55.1 (6.), 57.0 (10.), 63.0 (8.)
Trefferlage: 0.49 mm rechts, 0.20 mm hoch
Streuwert: 0.95, horizontal: 1.08, vertikal: 0.79

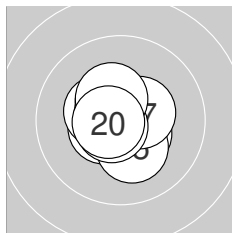

Serie 2:
 10.5 * 10.5 * 10.4 * 10.7 * 10.2 *
 10.5 * 10.4 * 10.7 * 10.4 * 10.6 *
beste Teiler: 67.4 (18.), 75.7 (14.), 76.9 (20.)
Trefferlage: 0.25 mm links, 0.04 mm hoch
Streuwert: 0.89, horizontal: 0.86, vertikal: 0.91

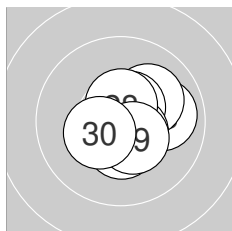

Serie 3:
 10.4 * 10.8 * 9.9 → 10.1 ↗ 10.5 *
 10.6 * 10.8 * 10.6 * 10.4 * 10.4 *
beste Teiler: 35.1 (22.), 39.4 (27.), 99.7 (26.)
Trefferlage: 0.42 mm rechts, 0.03 mm tief
Streuwert: 1.00, horizontal: 1.09, vertikal: 0.91



Ergebnis: **308.7** (295)
 Serien: 103.5 103.2 102.0
 Zähler: 25 5 0 0 0 0 0 0 0 0
 Innenzehner: 20
 Weitestе: 401 (27.), 327 (28.), 325 (11.)
 beste Teiler: 66.5 (29.), 70.0 (19.), 83.3 (16.)
 Trefferlage: 0.08 mm rechts, 0.43 mm tief
 Streuwert: 1.34, horizontal: 1.46, vertikal: 1.22

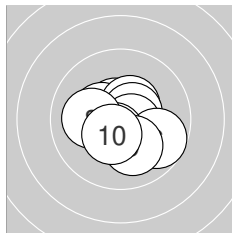
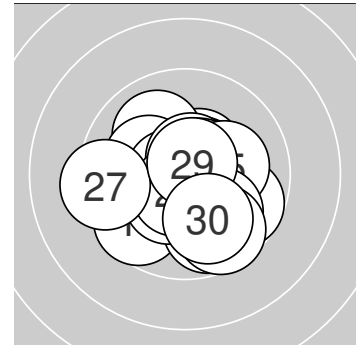

Serie 1:
 10.6 * 10.4 * 10.5 * 10.6 * 10.6 *
 9.7 ↘ 10.5 * 10.1 ← 10.1 ↘ 10.4 *
 beste Teiler: 86.4 (5.), 92.1 (1.), 99.8 (4.)
 Trefferlage: 0.08 mm rechts, 0.29 mm tief
 Streuwert: 1.22, horizontal: 1.39, vertikal: 1.03

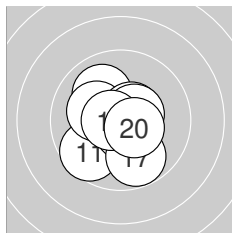

Serie 2:
 9.7 ↙ 10.0 ↘ 10.2 * 10.6 * 10.6 *
 10.6 * 9.8 ↘ 10.5 * 10.7 * 10.5 *
 beste Teiler: 70.0 (19.), 83.3 (16.), 90.6 (15.)
 Trefferlage: 0.10 mm links, 0.28 mm tief
 Streuwert: 1.36, horizontal: 1.32, vertikal: 1.39

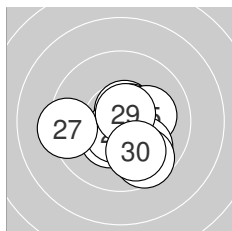

Serie 3:
 10.6 * 10.6 * 10.4 * 10.6 * 10.2 *
 10.0 ↘ 9.3 ← 9.6 ↘ 10.7 * 10.0 ↘
 beste Teiler: 66.5 (29.), 85.0 (21.), 89.2 (22.)
 Trefferlage: 0.26 mm rechts, 0.71 mm tief
 Streuwert: 1.54, horizontal: 1.75, vertikal: 1.29



Ergebnis: 307.8 (296)
Serien: 104.1 101.8 101.9
Zähler: 26 4 0 0 0 0 0 0 0 0
Innenzehner: 20
Weiteste: 410 (27.), 388 (24.), 285 (16.)
beste Teiler: 18.3 (10.), 33.3 (29.), 50.6 (8.)
Trefferlage: 0.15 mm links, 0.47 mm hoch
Streuwert: 1.37, horizontal: 1.69, vertikal: 0.96

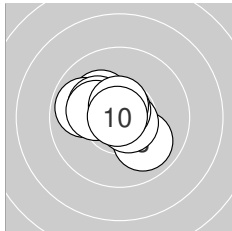
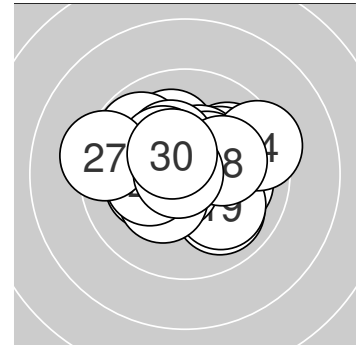

Serie 1:

10.2 *	9.9 ←	10.0 ↘	10.6 *	10.7 *
10.2 *	10.2 *	10.8 *	10.6 *	10.9 *

beste Teiler: 18.3 (10.), 50.6 (8.), 60.8 (5.)
Trefferlage: 0.55 mm links, 0.30 mm hoch
Streuwert: 1.10, horizontal: 1.30, vertikal: 0.87

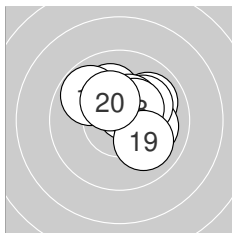

Serie 2:

10.1 ↑	10.6 *	10.0 ↗	10.1 →	10.1 ↗
9.8 ↘	10.4 *	10.4 *	10.0 ↘	10.3 *

beste Teiler: 90.6 (12.), 139.4 (17.), 140.7 (18.)
Trefferlage: 0.65 mm rechts, 0.86 mm hoch
Streuwert: 1.28, horizontal: 1.45, vertikal: 1.08

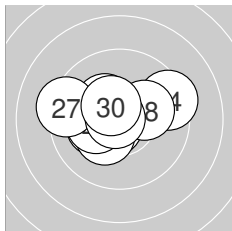

Serie 3:

10.7 *	10.2 *	10.3 *	9.4 →	10.3 *
10.2 *	9.3 ←	10.2 *	10.8 *	10.5 *

beste Teiler: 33.3 (29.), 73.5 (21.), 119.5 (30.)
Trefferlage: 0.57 mm links, 0.26 mm hoch
Streuwert: 1.59, horizontal: 2.07, vertikal: 0.89



LG Mixed Quali – Wertung – offene Klasse

StartNr: 21

StandNr: 123

12. November 2022 10:27

Embacher,, Martin #70420001 SG_Söller_Sportschützen / SG Söller Sportschützen 2

Ergebnis: **291.2** (278)
Serien: 95.0 98.2 98.0
Zähler: 12 14 4 0 0 0 0 0 0 0
Innenzehner: 8
Weiteste: 677 (3.), 609 (17.), 554 (2.)
beste Teiler: 43.4 (16.), 66.0 (5.), 88.2 (28.)
Trefferlage: 0.56 mm links, 0.25 mm hoch
Streuwert: 2.48, horizontal: 2.90, vertikal: 1.96

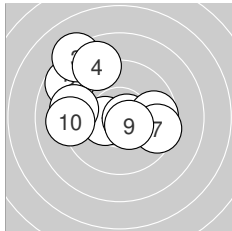
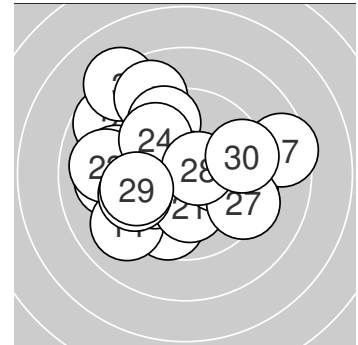

Serie 1:

10.4 *	8.7 ↘	8.2 ↘	8.9 ↗	10.7 *
9.7 →	9.5 →	9.3 ←	10.5 *	9.1 ←

beste Teiler: 66.0 (5.), 111.6 (9.), 136.3 (1.)
Trefferlage: 1.25 mm links, 1.16 mm hoch
Streuwert: 2.78, horizontal: 3.13, vertikal: 2.38

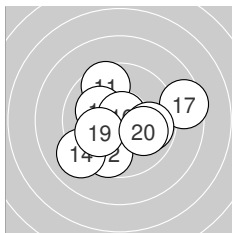

Serie 2:

9.6 ↘	9.7 ↓	10.4 *	9.1 ↙	10.2 *
10.8 *	8.5 →	9.8 →	10.1 ↙	10.0 →

beste Teiler: 43.4 (16.), 128.7 (13.), 200.8 (15.)
Trefferlage: 0.02 mm rechts, 0.27 mm tief
Streuwert: 2.40, horizontal: 2.81, vertikal: 1.91

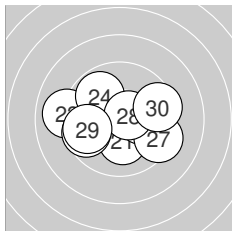

Serie 3:

10.2 *	10.1 ←	9.0 ←	9.8 ↘	10.1 →
9.6 ←	9.4 →	10.6 *	9.7 ←	9.5 →

beste Teiler: 88.2 (28.), 195.1 (21.), 203.1 (25.)
Trefferlage: 0.45 mm links, 0.12 mm tief
Streuwert: 2.27, horizontal: 2.93, vertikal: 1.30



Ergebnis: 306.7 (291)
Serien: 102.1 102.0 102.6
Zähler: 21 9 0 0 0 0 0 0 0 0
Innenzehner: 21
Weiteste: 430 (4.), 429 (24.), 367 (12.)
beste Teiler: 44.4 (25.), 58.4 (28.), 66.0 (20.)
Trefferlage: 0.39 mm rechts, 0.39 mm hoch
Streuwert: 1.48, horizontal: 1.75, vertikal: 1.14

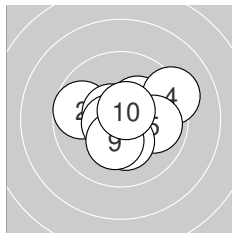
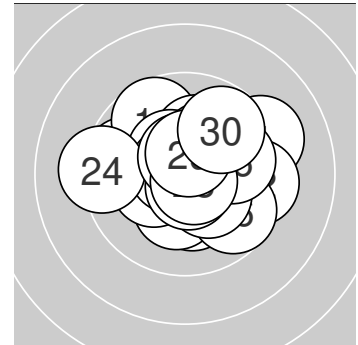

Serie 1:
 10.6 * 9.7 ← 10.3 * 9.2 → 9.9 →
 10.6 * 10.3 * 10.6 * 10.3 * 10.6 *
beste Teiler: 79.6 (10.), 85.2 (8.), 88.7 (6.)
Trefferlage: 0.43 mm rechts, 0.13 mm hoch
Streuwert: 1.57, horizontal: 1.91, vertikal: 1.14

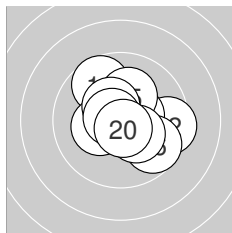

Serie 2:
 9.7 ↘ 9.5 → 10.5 * 10.3 * 10.2 *
 9.7 ↘ 10.3 * 10.4 * 10.7 * 10.7 *
beste Teiler: 66.0 (20.), 69.5 (19.), 120.8 (13.)
Trefferlage: 0.47 mm rechts, 0.18 mm hoch
Streuwert: 1.56, horizontal: 1.71, vertikal: 1.39

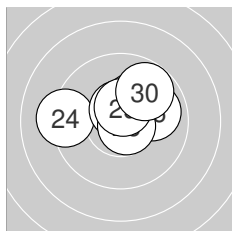

Serie 3:
 10.2 * 10.3 * 10.6 * 9.2 ← 10.8 *
 9.9 → 10.6 * 10.7 * 10.5 * 9.8 ↗
beste Teiler: 44.4 (25.), 58.4 (28.), 87.0 (23.)
Trefferlage: 0.27 mm rechts, 0.88 mm hoch
Streuwert: 1.38, horizontal: 1.81, vertikal: 0.73



LG Mixed Quali – Wertung – offene Klasse

StartNr: 23

StandNr: 125

12. November 2022 10:25

Nagl,, Selina #70233081

SG_Thaur / SG Thaur 2

Ergebnis: **305.9** (292)
 Serien: 101.9 103.3 100.7
 Zähler: 22 8 0 0 0 0 0 0 0 0
 Innenzehner: 19
 Weitesten: 394 (21.), 345 (4.), 342 (25.)
 beste Teiler: 36.0 (17.), 54.5 (14.), 61.4 (3.)
 Trefferlage: 0.00 mm , 0.62 mm hoch
 Streuwert: 1.46, horizontal: 1.68, vertikal: 1.19

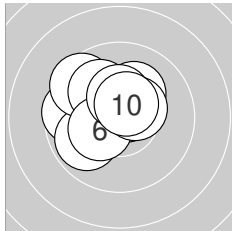
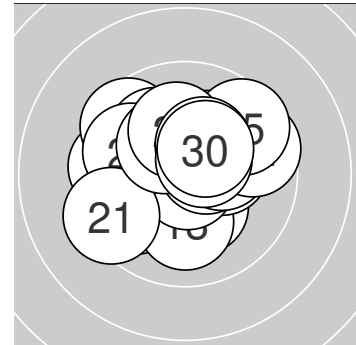

Serie 1:

9.7 ←	9.9 ↙	10.7 *	9.6 ↘	10.1 ↘
10.3 *	10.2 *	10.5 *	10.4 *	10.5 *

beste Teiler: 61.4 (3.), 104.2 (10.), 125.3 (8.)
 Trefferlage: 0.79 mm links, 0.72 mm hoch
 Streuwert: 1.38, horizontal: 1.57, vertikal: 1.16

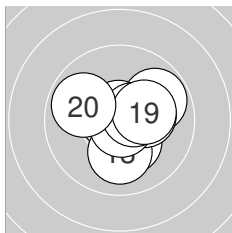

Serie 2:

10.3 *	10.7 *	10.1 ↓	10.7 *	9.8 ↗
10.3 *	10.8 *	10.5 *	10.2 *	9.9 ↖

beste Teiler: 36.0 (17.), 54.5 (14.), 71.1 (12.)
 Trefferlage: 0.44 mm rechts, 0.04 mm hoch
 Streuwert: 1.28, horizontal: 1.42, vertikal: 1.12

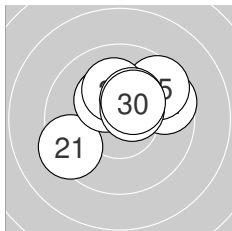

Serie 3:

9.4 ↙	9.6 ↗	10.3 *	10.3 *	9.6 ↗
10.3 *	10.1 ↑	10.3 *	10.5 *	10.3 *

beste Teiler: 112.4 (29.), 151.4 (30.), 153.3 (26.)
 Trefferlage: 0.34 mm rechts, 1.09 mm hoch
 Streuwert: 1.56, horizontal: 1.88, vertikal: 1.15



LG Mixed Quali – Wertung – offene Klasse

StartNr: 24

StandNr: 126

12. November 2022 10:28

Rief,, Daniel #70233026

SG_Thaur / SG Thaur 2

Ergebnis: **288.5** (276)
 Serien: 97.1 92.9 98.5
 Zähler: 13 11 5 1 0 0 0 0 0 0
 Innenzehner: 8
 Weitester: 774 (15.), 698 (22.), 631 (11.)
 beste Teiler: 81.4 (14.), 90.2 (23.), 116.7 (24.)
 Trefferlage: 0.66 mm links, 0.04 mm hoch
 Streuwert: 2.74, horizontal: 2.74, vertikal: 2.75

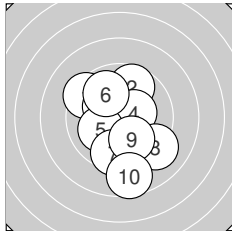
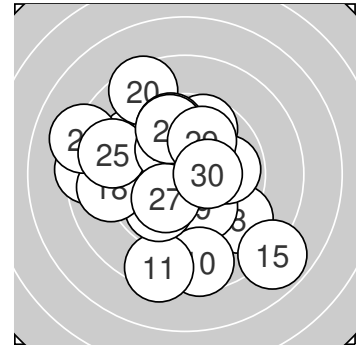

Serie 1:

9.4 ↘	9.7 ↗	10.3 *	10.4 *	10.1 ↖
9.9 ↘	9.6 ↓	9.1 ↘	10.0 ↘	8.6 ↓

beste Teiler: 147.0 (4.), 174.8 (3.), 218.0 (5.)
 Trefferlage: 0.02 mm links, 0.64 mm tief
 Streuwert: 2.48, horizontal: 2.00, vertikal: 2.88

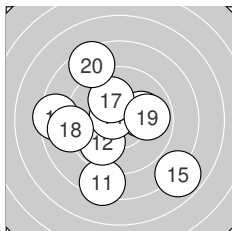

Serie 2:

8.4 ↓	9.9 ↙	10.1 →	10.6 *	7.9 ↘
8.5 ←	10.1 ↖	9.0 ←	9.9 →	8.5 ↖

beste Teiler: 81.4 (14.), 216.9 (17.), 218.8 (13.)
 Trefferlage: 0.82 mm links, 0.52 mm tief
 Streuwert: 3.46, horizontal: 3.56, vertikal: 3.35

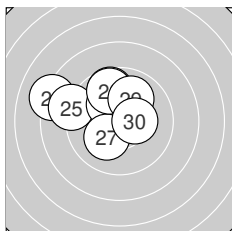

Serie 3:

9.7 ↖	8.2 ↖	10.6 *	10.5 *	9.0 ↖
10.2 *	10.2 *	9.7 ↖	10.0 ↗	10.4 *

beste Teiler: 90.2 (23.), 116.7 (24.), 149.0 (30.)
 Trefferlage: 1.14 mm links, 1.30 mm hoch
 Streuwert: 2.12, horizontal: 2.62, vertikal: 1.45



LG Mixed Quali – Wertung – offene Klasse

StartNr: 25

StandNr: 127

12. November 2022 10:35

Patka,, Hannes #70421021 SG_Thierberger_Schützen / SG Thierberger Schützen 1

Ergebnis: **311.5** (297)
Serien: 103.1 104.9 103.5
Zähler: 27 3 0 0 0 0 0 0 0
Innenzehner: 23
Weiteste: 319 (5.), 317 (21.), 299 (22.)
beste Teiler: 8.5 (11.), 23.1 (24.), 38.1 (15.)
Trefferlage: 0.30 mm rechts, 0.05 mm hoch
Streuwert: 1.17, horizontal: 1.25, vertikal: 1.07

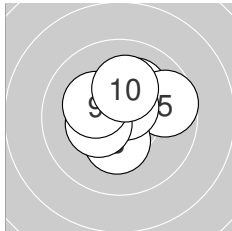
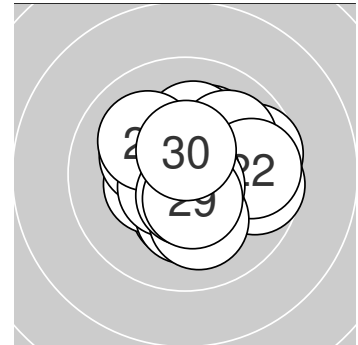

Serie 1:
 10.1 ↗ 10.7 * 10.4 * 10.5 * 9.7 →
 10.3 * 10.6 * 10.4 * 10.2 * 10.2 *
beste Teiler: 63.6 (2.), 81.0 (7.), 123.4 (4.)
Trefferlage: 0.11 mm links, 0.45 mm hoch
Streuwert: 1.26, horizontal: 1.43, vertikal: 1.07

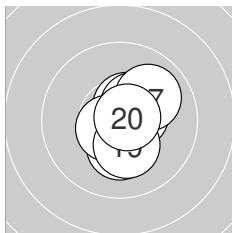

Serie 2:
 10.9 * 10.2 * 10.5 * 10.5 * 10.8 *
 10.4 * 10.0 ↗ 10.6 * 10.3 * 10.7 *
beste Teiler: 8.5 (11.), 38.1 (15.), 55.3 (20.)
Trefferlage: 0.49 mm rechts, 0.00 mm
Streuwert: 0.92, horizontal: 0.71, vertikal: 1.09

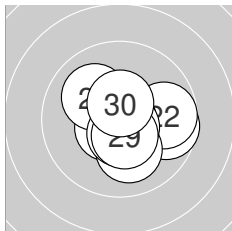

Serie 3:
 9.7 → 9.8 → 10.6 * 10.9 * 10.1 ↓
 10.1 ↘ 10.7 * 10.6 * 10.5 * 10.5 *
beste Teiler: 23.1 (24.), 68.8 (27.), 96.0 (28.)
Trefferlage: 0.53 mm rechts, 0.29 mm tief
Streuwert: 1.28, horizontal: 1.49, vertikal: 1.04



LG Mixed Quali – Wertung – offene Klasse

StartNr: 26

StandNr: 128

12. November 2022 10:25

Patka-Rangger,, Patricia #SG2Thierberger_Schützen / SG Thierberger Schützen 1

Ergebnis: **300.0** (284)
 Serien: 99.3 100.5 100.2
 Zähler: 16 12 2 0 0 0 0 0 0
 Innenzehner: 11
 Weitestе: 578 (13.), 518 (30.), 431 (20.)
 beste Teiler: 20.0 (21.), 48.3 (19.), 50.0 (25.)
 Trefferlage: 0.58 mm rechts, 0.17 mm tief
 Streuwert: 1.93, horizontal: 1.76, vertikal: 2.09

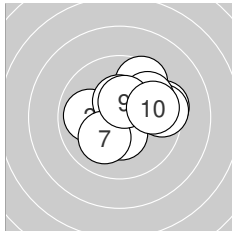
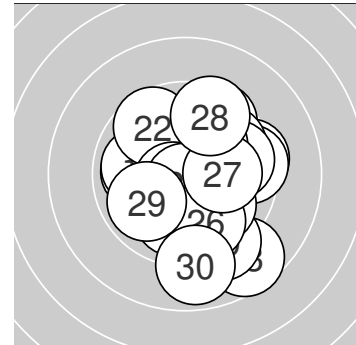

Serie 1:

9.4 →	9.9 ←	9.6 ↗	10.4 *	10.4 *
9.5 →	10.1 ↘	9.8 ↗	10.4 *	9.8 →

beste Teiler: 136.1 (5.), 137.2 (9.), 139.7 (4.)
 Trefferlage: 1.10 mm rechts, 0.65 mm hoch
 Streuwert: 1.78, horizontal: 2.10, vertikal: 1.38

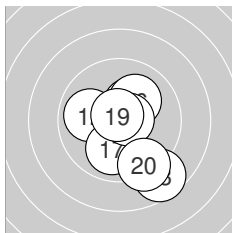

Serie 2:

10.4 *	9.9 ←	8.6 ↘	10.5 *	10.3 *
10.1 ↗	10.0 ↓	10.7 *	10.8 *	9.2 ↘

beste Teiler: 48.3 (19.), 70.3 (18.), 120.9 (14.)
 Trefferlage: 0.41 mm rechts, 0.58 mm tief
 Streuwert: 1.99, horizontal: 1.71, vertikal: 2.23

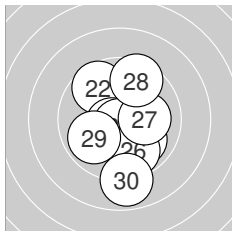

Serie 3:

10.9 *	9.7 ↘	10.6 *	10.0 ↘	10.8 *
9.8 ↘	10.1 →	9.5 ↗	9.9 ↘	8.9 ↓

beste Teiler: 20.0 (21.), 50.0 (25.), 78.7 (23.)
 Trefferlage: 0.22 mm rechts, 0.59 mm tief
 Streuwert: 2.02, horizontal: 1.47, vertikal: 2.45



Ergebnis: **287.1** (274)
Serien: 94.5 97.1 95.5
Zähler: 9 16 5 0 0 0 0 0 0
Innenzehner: 4
Weiteste: 668 (28.), 599 (12.), 591 (3.)
beste Teiler: 110.2 (17.), 129.8 (25.), 135.4 (8.)
Trefferlage: 0.51 mm rechts, 0.26 mm tief
Streuwert: 2.66, horizontal: 2.84, vertikal: 2.48

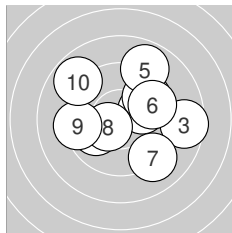
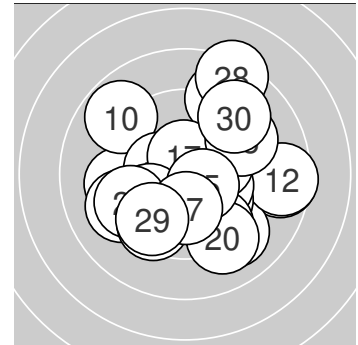

Serie 1:

9.9 ↙	10.1 →	8.6 →	9.7 ↗	8.9 ↗
9.7 ↗	9.1 ↘	10.4 *	9.3 ←	8.8 ↖

beste Teiler: 135.4 (8.), 217.5 (2.), 254.0 (1.)
Trefferlage: 0.70 mm rechts, 0.61 mm hoch
Streuwert: 2.91, horizontal: 3.33, vertikal: 2.41

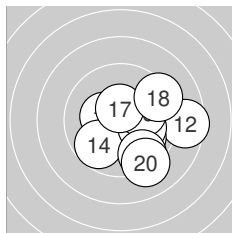

Serie 2:

10.3 *	8.6 →	9.9 ↘	9.7 ↙	10.1 →
10.1 →	10.5 *	9.3 ↗	9.5 ↘	9.1 ↘

beste Teiler: 110.2 (17.), 157.9 (11.), 211.2 (16.)
Trefferlage: 1.61 mm rechts, 0.76 mm tief
Streuwert: 2.16, horizontal: 2.35, vertikal: 1.94

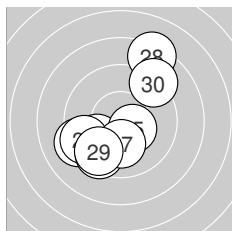

Serie 3:

10.0 ↗	9.9 ↙	9.2 ↙	9.4 ↙	10.4 *
9.5 ↙	10.1 ↓	8.3 ↗	9.6 ↙	9.1 ↗

beste Teiler: 129.8 (25.), 210.1 (27.), 245.6 (21.)
Trefferlage: 0.77 mm links, 0.63 mm tief
Streuwert: 2.74, horizontal: 2.46, vertikal: 2.99



Ergebnis: 298.6 (283)
Serien: 99.9 98.3 100.4
Zähler: 16 11 3 0 0 0 0 0 0 0
Innenzehner: 12
Weiteste: 541 (19.), 507 (18.), 506 (1.)
beste Teiler: 49.2 (3.), 64.8 (17.), 64.9 (8.)
Trefferlage: 0.84 mm links, 0.72 mm tief
Streuwert: 1.98, horizontal: 2.60, vertikal: 1.04

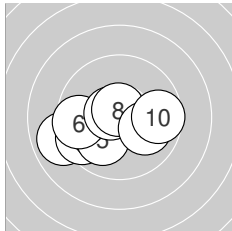
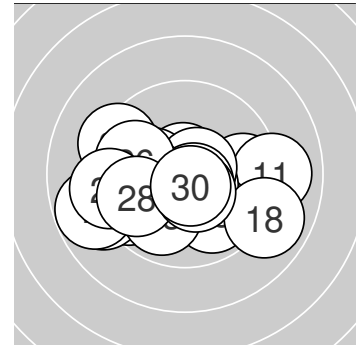

Serie 1:

8.9 ←	9.5 ←	10.8 *	10.1 ←	10.0 ↙
9.6 ←	10.6 *	10.7 *	10.0 ↘	9.7 →

beste Teiler: 49.2 (3.), 64.9 (8.), 82.8 (7.)
Trefferlage: 0.99 mm links, 0.74 mm tief
Streuwert: 1.86, horizontal: 2.48, vertikal: 0.91

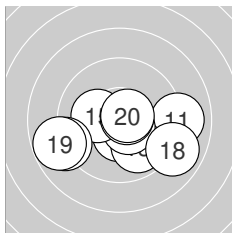

Serie 2:

9.0 →	10.5 *	9.9 ↘	10.6 *	10.2 *
9.0 ←	10.7 *	8.9 ↘	8.8 ←	10.7 *

beste Teiler: 64.8 (17.), 75.6 (20.), 97.8 (14.)
Trefferlage: 0.13 mm rechts, 0.95 mm tief
Streuwert: 2.46, horizontal: 3.28, vertikal: 1.15

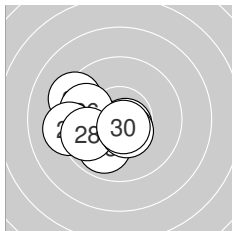

Serie 3:

10.4 *	10.1 ←	9.9 ↙	10.7 *	9.3 ↖
9.8 ↖	9.2 ←	9.8 ←	10.5 *	10.7 *

beste Teiler: 69.3 (24.), 73.3 (30.), 116.6 (29.)
Trefferlage: 1.68 mm links, 0.48 mm tief
Streuwert: 1.46, horizontal: 1.75, vertikal: 1.10

