

**EYL Rifle – Wertung – offene Klasse**

**StartNr: 6**

StandNr: 133

10. Juni 2018 9:17

**KRUMM, Clémentine** #1000000237

France / France

Ergebnis: **412.6** (393)  
 Serien: 101.8 104.9 104.3 101.6  
 Zähler: 34 5 1 0 0 0 0 0 0 0  
 Innenzehner: 30  
 weiteste: 513 (8), 363 (2), 337 (39)  
 beste Teiler 18.6 (4.) 37.2 (23.) 45.8 (18.)  
 Trefferlage 0.13 mm links, 0.08 mm tief  
 Streuwert 1.33, horizontal: 1.49, vertikal: 1.15

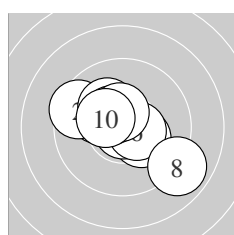
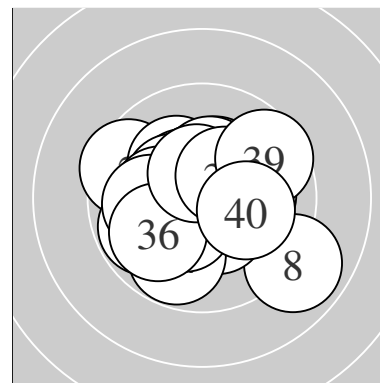

Serie 1:  
 10.1 ↖ 9.5 ↖ 10.3 \* 10.9 \* 10.2 \*  
 10.5 \* 10.5 \* 8.9 ↘ 10.5 \* 10.4 \*  
 beste Teiler 18.6 (4.) 112.7 (6.) 116.1 (9.)  
 Trefferlage 0.20 mm links, 0.23 mm hoch  
 Streuwert 1.76, horizontal: 2.08, vertikal: 1.37

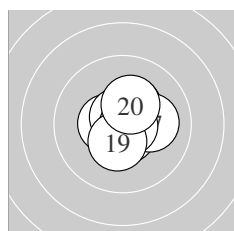

Serie 2:  
 10.4 \* 10.6 \* 10.6 \* 10.5 \* 10.5 \*  
 10.7 \* 10.1 → 10.8 \* 10.4 \* 10.3 \*  
 beste Teiler 45.8 (18.) 63.0 (16.) 78.9 (12.)  
 Trefferlage 0.26 mm rechts, 0.13 mm hoch  
 Streuwert 0.92, horizontal: 0.92, vertikal: 0.92

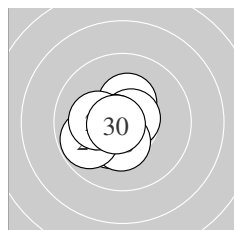

Serie 3:  
 10.3 \* 10.4 \* 10.8 \* 10.3 \* 10.7 \*  
 10.4 \* 10.7 \* 9.8 ↙ 10.2 \* 10.7 \*  
 beste Teiler 37.2 (23.) 54.0 (30.) 67.4 (27.)  
 Trefferlage 0.71 mm links, 0.33 mm tief  
 Streuwert 0.94, horizontal: 0.97, vertikal: 0.91

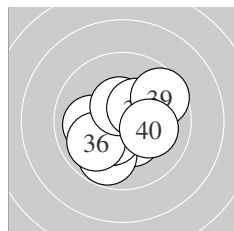

Serie 4:  
 10.4 \* 10.5 \* 10.0 ← 9.8 ↓ 10.4 \*  
 9.9 ↙ 10.5 \* 10.4 \* 9.6 ↗ 10.1 →  
 beste Teiler 111.0 (32.) 115.7 (37.) 140.4 (35.)  
 Trefferlage 0.10 mm rechts, 0.38 mm tief  
 Streuwert 1.55, horizontal: 1.71, vertikal: 1.37

Unterschrift des Schützen

Meyton Elektronik

**EYL Rifle – Wertung – offene Klasse**

**StartNr: 7**

StandNr: 135

10. Juni 2018 9:17

**MULLER, Océane** #1000000239

France / France

Ergebnis: **410.6** (392)  
 Serien: 102.1 102.4 104.8 101.3  
 Zähler: 32 8 0 0 0 0 0 0 0 0  
 Innenzehner: 27  
 weiteste: 402 (39), 321 (9), 314 (38)  
 beste Teiler 37.6 (13.) 44.1 (25.) 50.8 (14.)  
 Trefferlage 0.03 mm links, 0.39 mm hoch  
 Streuwert 1.35, horizontal: 1.47, vertikal: 1.23

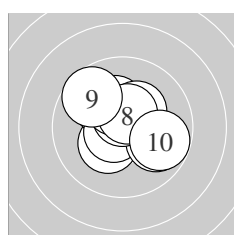
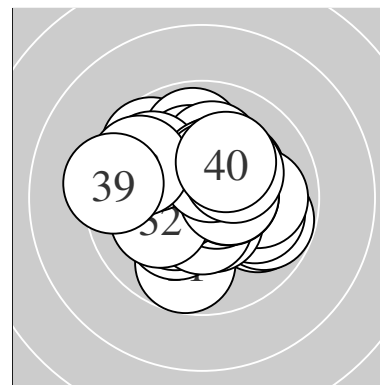

Serie 1:  
 10.3 \*                      10.1 ↘                      10.6 \*                      9.9 ↘                      10.6 \*  
 10.3 \*                      10.3 \*                      10.5 \*                      9.7 ↘                      9.8 ↘  
 beste Teiler 76.1 (3.) 81.0 (5.) 105.6 (8.)  
 Trefferlage 0.06 mm rechts, 0.48 mm hoch  
 Streuwert 1.47, horizontal: 1.64, vertikal: 1.28

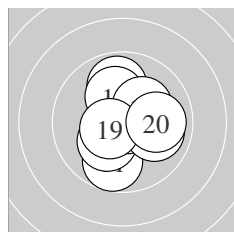

Serie 2:  
 9.8 ↓                      10.2 \*                      10.8 \*                      10.8 \*                      9.9 ↑  
 10.0 →                      10.2 \*                      10.2 \*                      10.5 \*                      10.0 →  
 beste Teiler 37.6 (13.) 50.8 (14.) 107.7 (19.)  
 Trefferlage 0.23 mm rechts, 0.02 mm hoch  
 Streuwert 1.50, horizontal: 1.38, vertikal: 1.61

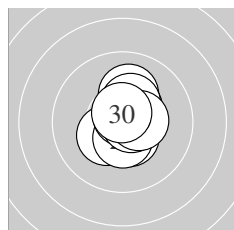

Serie 3:  
 10.3 \*                      10.1 ↑                      10.5 \*                      10.5 \*                      10.8 \*  
 10.7 \*                      10.4 \*                      10.3 \*                      10.5 \*                      10.7 \*  
 beste Teiler 44.1 (25.) 65.0 (26.) 70.3 (30.)  
 Trefferlage 0.28 mm rechts, 0.25 mm hoch  
 Streuwert 0.91, horizontal: 0.65, vertikal: 1.11

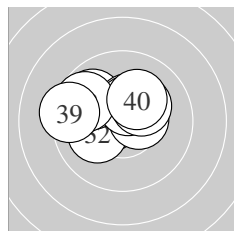

Serie 4:  
 10.6 \*                      10.1 ↙                      10.5 \*                      9.8 ↘                      10.4 \*  
 10.5 \*                      10.2 \*                      9.7 ↘                      9.3 ←                      10.2 \*  
 beste Teiler 93.0 (31.) 120.8 (33.) 123.0 (36.)  
 Trefferlage 0.73 mm links, 0.81 mm hoch  
 Streuwert 1.46, horizontal: 1.90, vertikal: 0.83

Unterschrift des Schützen

Meyton Elektronik

Ergebnis: **406.4** (387)  
 Serien: 102.5 100.3 101.3 102.3  
 Zähler: 27 13 0 0 0 0 0 0 0 0  
 Innenzehner: 21  
 weiteste: 439 (11), 439 (22), 367 (9)  
 beste Teiler 14.0 (7.) 20.1 (38.) 63.5 (17.)  
 Trefferlage 0.08 mm rechts, 0.57 mm hoch  
 Streuwert 1.56, horizontal: 1.96, vertikal: 1.00

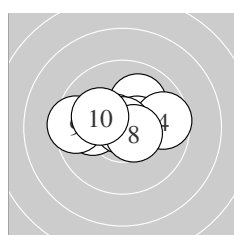
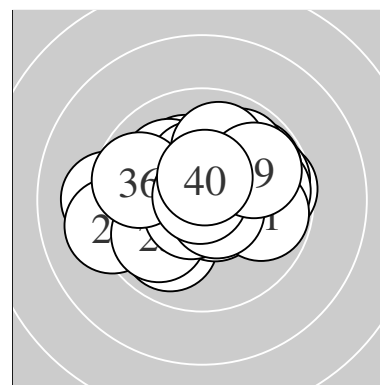

Serie 1:  
 10.5 \* 10.0 ↗ 10.5 \* 9.7 → 10.6 \*  
 10.0 ← 10.9 \* 10.6 \* 9.5 ← 10.2 \*  
 beste Teiler 14.0 (7.) 77.8 (5.) 99.3 (8.)  
 Trefferlage 0.10 mm links, 0.43 mm hoch  
 Streuwert 1.50, horizontal: 2.03, vertikal: 0.64

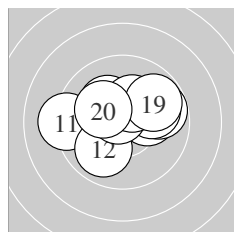

Serie 2:  
 9.2 ← 9.9 ↘ 10.2 \* 9.8 → 10.2 \*  
 10.0 → 10.7 \* 10.3 \* 9.8 ↗ 10.2 \*  
 beste Teiler 63.5 (17.) 164.1 (18.) 181.9 (20.)  
 Trefferlage 0.12 mm rechts, 0.61 mm hoch  
 Streuwert 1.81, horizontal: 2.32, vertikal: 1.06

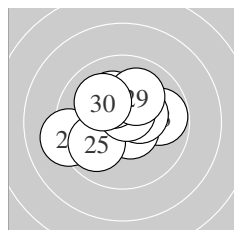

Serie 3:  
 10.4 \* 9.2 ← 9.8 → 10.6 \* 9.9 ↘  
 10.4 \* 10.6 \* 10.2 \* 10.1 ↗ 10.1 ↖  
 beste Teiler 80.6 (27.) 88.4 (24.) 132.2 (21.)  
 Trefferlage 0.14 mm links, 0.45 mm hoch  
 Streuwert 1.68, horizontal: 2.03, vertikal: 1.24

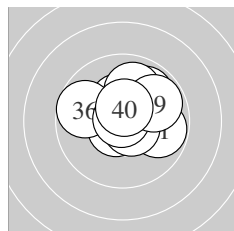

Serie 4:  
 9.8 → 9.9 ↗ 10.4 \* 10.7 \* 10.0 ↗  
 9.7 ← 10.6 \* 10.9 \* 9.8 → 10.5 \*  
 beste Teiler 20.1 (38.) 74.2 (34.) 85.2 (37.)  
 Trefferlage 0.46 mm rechts, 0.77 mm hoch  
 Streuwert 1.40, horizontal: 1.65, vertikal: 1.09

Unterschrift des Schützen

Ergebnis: **410.3** (394)  
 Serien: 102.2 103.5 101.5 103.1  
 Zähler: 34 6 0 0 0 0 0 0 0 0  
 Innenzehner: 26  
 weiteste: 494 (30), 468 (6), 409 (28)  
 beste Teiler 7.8 (20.) 10.0 (21.) 41.1 (33.)  
 Trefferlage 0.19 mm rechts, 0.43 mm hoch  
 Streuwert 1.43, horizontal: 1.71, vertikal: 1.09

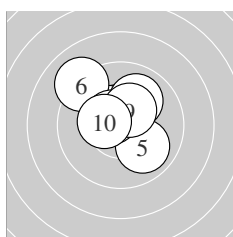
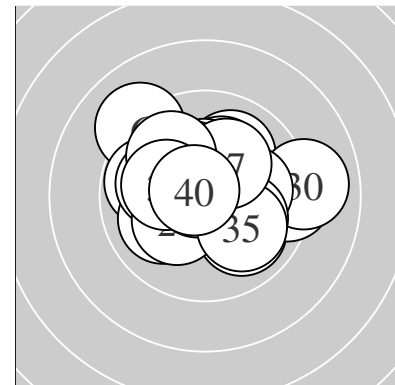

Serie 1:  
 10.6 \* 10.5 \* 10.3 \* 10.4 \* 9.9 ↘  
 9.1 ↙ 10.6 \* 10.0 ↗ 10.4 \* 10.4 \*  
 beste Teiler 97.6 (1.) 99.8 (7.) 117.3 (2.)  
 Trefferlage 0.25 mm links, 1.03 mm hoch  
 Streuwert 1.38, horizontal: 1.47, vertikal: 1.29

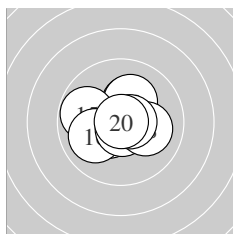

Serie 2:  
 10.4 \* 10.3 \* 10.2 \* 10.5 \* 9.8 ↖  
 10.0 ↙ 10.7 \* 10.1 → 10.6 \* 10.9 \*  
 beste Teiler 7.8 (20.) 61.6 (17.) 77.0 (19.)  
 Trefferlage 0.04 mm links, 0.22 mm hoch  
 Streuwert 1.27, horizontal: 1.48, vertikal: 1.02

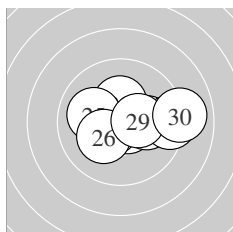

Serie 3:  
 10.9 \* 10.7 \* 10.3 \* 10.6 \* 10.0 ↖  
 10.2 \* 10.1 → 9.3 → 10.4 \* 9.0 →  
 beste Teiler 10.0 (21.) 69.3 (22.) 87.9 (24.)  
 Trefferlage 0.86 mm rechts, 0.07 mm hoch  
 Streuwert 1.71, horizontal: 2.30, vertikal: 0.75

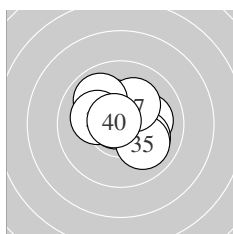

Serie 4:  
 10.1 → 10.1 ↘ 10.8 \* 10.8 \* 10.0 ↘  
 10.3 \* 10.2 \* 9.9 ↙ 10.2 \* 10.7 \*  
 beste Teiler 41.1 (33.) 49.4 (34.) 60.8 (40.)  
 Trefferlage 0.21 mm rechts, 0.38 mm hoch  
 Streuwert 1.31, horizontal: 1.48, vertikal: 1.11

Unterschrift des Schützen

**EYL Rifle – Wertung – offene Klasse**

**StartNr: 27**

StandNr: 136

10. Juni 2018 9:12

**GABRIELLI, Nicole #71**

Italy / Italy

Ergebnis: **416.2** (398)  
 Serien: 103.0 103.9 105.1 104.2  
 Zähler: 38 2 0 0 0 0 0 0 0 0  
 Innenzehner: 32  
 weiteste: 319 (1), 302 (3), 243 (35)  
 beste Teiler 28.3 (13.) 44.7 (40.) 48.1 (24.)  
 Trefferlage 0.12 mm rechts, 0.15 mm hoch  
 Streuwert 1.09, horizontal: 1.14, vertikal: 1.03

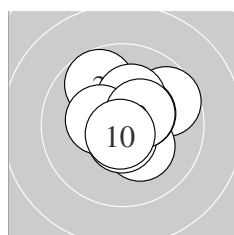
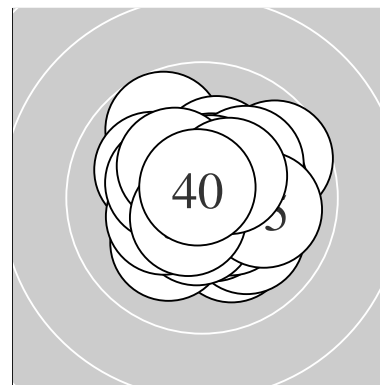

Serie 1:  
 9.7 ↗ 10.2 \* 9.7 ↖ 10.7 \* 10.4 \*  
 10.2 \* 10.6 \* 10.4 \* 10.4 \* 10.7 \*  
 beste Teiler 60.1 (10.) 75.7 (4.) 83.0 (7.)  
 Trefferlage 0.33 mm rechts, 0.56 mm hoch  
 Streuwert 1.27, horizontal: 1.31, vertikal: 1.23

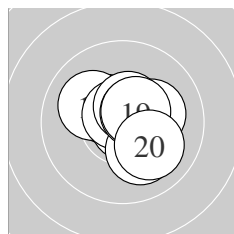

Serie 2:  
 10.4 \* 10.1 ↖ 10.8 \* 10.7 \* 10.1 ↘  
 10.2 \* 10.5 \* 10.6 \* 10.5 \* 10.0 ↘  
 beste Teiler 28.3 (13.) 61.4 (14.) 100.4 (18.)  
 Trefferlage 0.35 mm rechts, 0.17 mm hoch  
 Streuwert 1.11, horizontal: 1.19, vertikal: 1.02

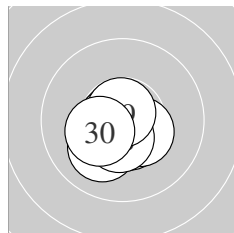

Serie 3:  
 10.4 \* 10.6 \* 10.5 \* 10.8 \* 10.1 ↙  
 10.4 \* 10.7 \* 10.5 \* 10.8 \* 10.3 \*  
 beste Teiler 48.1 (24.) 49.2 (29.) 56.0 (27.)  
 Trefferlage 0.40 mm links, 0.69 mm tief  
 Streuwert 0.70, horizontal: 0.76, vertikal: 0.64

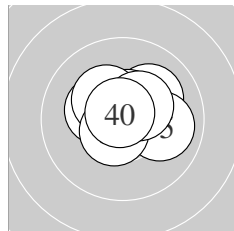

Serie 4:  
 10.5 \* 10.1 ↗ 10.6 \* 10.6 \* 10.0 →  
 10.3 \* 10.3 \* 10.6 \* 10.4 \* 10.8 \*  
 beste Teiler 44.7 (40.) 94.0 (38.) 100.2 (34.)  
 Trefferlage 0.22 mm rechts, 0.57 mm hoch  
 Streuwert 1.00, horizontal: 1.24, vertikal: 0.68

Unterschrift des Schützen

Meyton Elektronik

**EYL Rifle – Wertung – offene Klasse**

**StartNr: 28**

StandNr: 132

10. Juni 2018 9:14

**FORMICHELLA, Carmine** #1000000236

Italy / Italy

Ergebnis: **408.8** (395)  
 Serien: 101.7 102.8 101.5 102.8  
 Zähler: 35 5 0 0 0 0 0 0 0 0  
 Innenzehner: 24  
 weiteste: 396 (13), 312 (7), 305 (8)  
 beste Teiler 32.5 (12.) 52.6 (34.) 65.5 (1.)  
 Trefferlage 0.08 mm rechts, 0.34 mm hoch  
 Streuwert 1.39, horizontal: 1.66, vertikal: 1.06

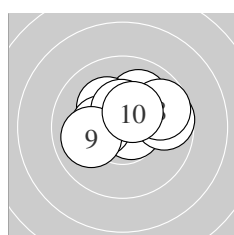
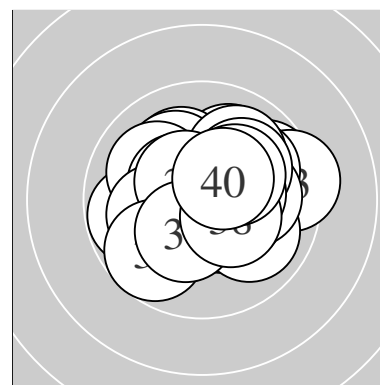

Serie 1:  
 10.7 \*                      10.0 ↗                      10.3 \*                      10.2 \*                      10.3 \*  
 10.4 \*                      9.7 →                      9.7 ↗                      10.0 ←                      10.4 \*  
 beste Teiler 65.5 (1.) 128.3 (6.) 134.2 (10.)  
 Trefferlage 0.24 mm rechts, 0.82 mm hoch  
 Streuwert 1.40, horizontal: 1.78, vertikal: 0.85

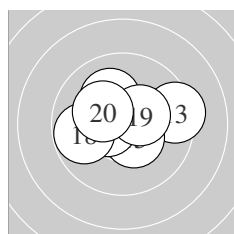

Serie 2:  
 10.4 \*                      10.8 \*                      9.4 →                      10.7 \*                      10.4 \*  
 10.1 ↘                      10.5 \*                      9.8 ←                      10.4 \*                      10.3 \*  
 beste Teiler 32.5 (12.) 70.6 (14.) 113.9 (17.)  
 Trefferlage 0.26 mm links, 0.29 mm hoch  
 Streuwert 1.45, horizontal: 1.86, vertikal: 0.85

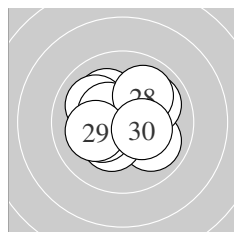

Serie 3:  
 10.1 ↘                      10.0 ↘                      10.3 \*                      10.3 \*                      10.0 ↘  
 10.4 \*                      10.0 ↗                      10.0 ↗                      10.1 ←                      10.3 \*  
 beste Teiler 127.3 (26.) 151.2 (30.) 160.3 (23.)  
 Trefferlage 0.14 mm links, 0.22 mm hoch  
 Streuwert 1.51, horizontal: 1.70, vertikal: 1.29

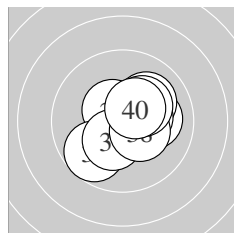

Serie 4:  
 10.1 →                      10.1 ↗                      10.4 \*                      10.7 \*                      10.5 \*  
 9.7 ↗                      10.3 \*                      10.4 \*                      10.2 \*                      10.4 \*  
 beste Teiler 52.6 (34.) 111.1 (35.) 132.2 (40.)  
 Trefferlage 0.49 mm rechts, 0.04 mm hoch  
 Streuwert 1.29, horizontal: 1.40, vertikal: 1.16

Unterschrift des Schützen

Meyton Elektronik