

Ergebnis: **408.5** (390)
 Serien: 103.4 102.2 103.3 99.6
 Zähler: 30 10 0 0 0 0 0 0 0 0
 Innenzehner: 23
 weiteste: 463 (36), 429 (26), 359 (31)
 beste Teiler 17.8 (20.) 18.0 (22.) 36.1 (18.)
 Trefferlage 0.09 mm rechts, 0.07 mm tief
 Streuwert 1.55, horizontal: 1.72, vertikal: 1.36

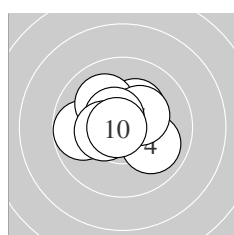

Serie 1:
 10.3 * 9.8 ← 10.3 * 10.0 ↘ 10.1 ↖
 10.8 * 10.3 * 10.6 * 10.4 * 10.8 *
 beste Teiler 41.1 (6.) 44.1 (10.) 97.9 (8.)
 Trefferlage 0.41 mm links, 0.36 mm hoch
 Streuwert 1.25, horizontal: 1.53, vertikal: 0.88

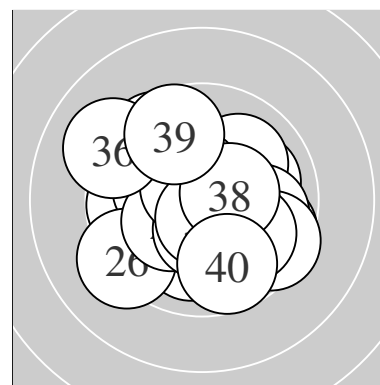
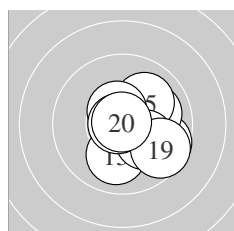

Serie 2:
 10.6 * 9.7 ↘ 10.0 ↓ 10.0 → 10.0 ↗
 10.5 * 10.1 ↘ 10.8 * 9.6 ↘ 10.9 *
 beste Teiler 17.8 (20.) 36.1 (18.) 89.1 (11.)
 Trefferlage 1.07 mm rechts, 0.33 mm tief
 Streuwert 1.33, horizontal: 1.36, vertikal: 1.29

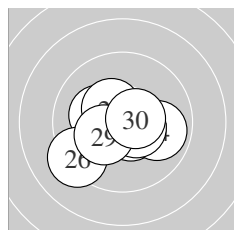

Serie 3:
 10.7 * 10.9 * 10.6 * 9.9 → 10.2 *
 9.2 ↙ 10.5 * 10.4 * 10.3 * 10.6 *
 beste Teiler 18.0 (22.) 67.4 (21.) 91.2 (23.)
 Trefferlage 0.26 mm links, 0.38 mm tief
 Streuwert 1.39, horizontal: 1.69, vertikal: 1.01

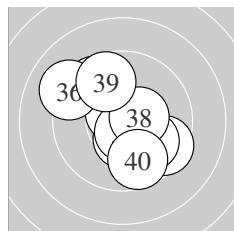

Serie 4:
 9.5 ↘ 9.6 ↖ 10.4 * 10.0 ↘ 10.6 *
 9.1 ↖ 10.6 * 10.4 * 9.7 ↖ 9.7 ↓
 beste Teiler 82.8 (35.) 83.1 (37.) 127.8 (38.)
 Trefferlage 0.02 mm links, 0.04 mm hoch
 Streuwert 2.06, horizontal: 2.07, vertikal: 2.05

Unterschrift des Schützen

Meyton Elektronik

EYL Rifle – Wertung – offene Klasse

StartNr: 24

StandNr: 141

10. Juni 2018 12:10

MAIR, Tobias #161

Austria / Austria

Ergebnis: **412.3** (392)
 Serien: 103.6 102.2 103.2 103.3
 Zähler: 32 8 0 0 0 0 0 0 0 0
 Innenzehner: 26
 weiteste: 305 (14), 296 (21), 295 (29)
 beste Teiler 22.3 (39.) 38.4 (5.) 46.8 (22.)
 Trefferlage 0.31 mm links, 0.04 mm hoch
 Streuwert 1.28, horizontal: 1.42, vertikal: 1.13

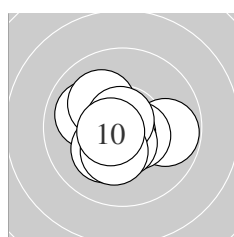
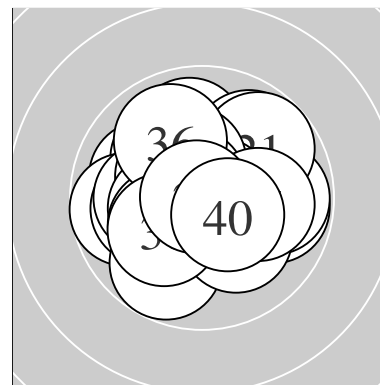

Serie 1:
 9.8 → 10.5 * 10.0 ↖ 10.1 ↘ 10.8 *
 10.2 * 10.5 * 10.8 * 10.3 * 10.6 *
 beste Teiler 38.4 (5.) 47.7 (8.) 84.8 (10.)
 Trefferlage 0.25 mm links, 0.28 mm tief
 Streuwert 1.21, horizontal: 1.40, vertikal: 0.99

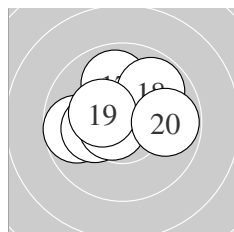

Serie 2:
 10.5 * 10.4 * 10.8 * 9.7 ← 10.2 *
 10.7 * 9.9 ↑ 9.8 ↗ 10.4 * 9.8 →
 beste Teiler 48.8 (13.) 73.1 (16.) 123.9 (11.)
 Trefferlage 0.11 mm links, 0.64 mm hoch
 Streuwert 1.44, horizontal: 1.76, vertikal: 1.02

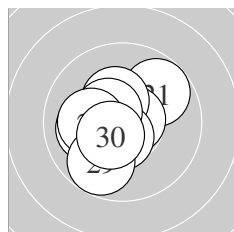

Serie 3:
 9.8 ↗ 10.8 * 10.7 * 10.1 ← 10.3 *
 10.6 * 10.5 * 10.1 ← 9.8 ↘ 10.5 *
 beste Teiler 46.8 (22.) 62.3 (23.) 97.4 (26.)
 Trefferlage 0.57 mm links, 0.05 mm tief
 Streuwert 1.29, horizontal: 1.30, vertikal: 1.29

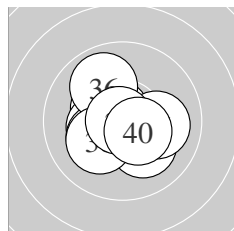

Serie 4:
 10.1 ↘ 10.4 * 10.3 * 10.7 * 10.2 *
 9.9 ↘ 10.1 → 10.2 * 10.9 * 10.5 *
 beste Teiler 22.3 (39.) 70.8 (34.) 122.0 (40.)
 Trefferlage 0.30 mm links, 0.14 mm tief
 Streuwert 1.26, horizontal: 1.37, vertikal: 1.14

Unterschrift des Schützen

Meyton Elektronik

Ergebnis: **411.3** (394)
 Serien: 103.1 102.4 102.0 103.8
 Zähler: 34 6 0 0 0 0 0 0 0 0
 Innenzehner: 27
 weiteste: 401 (3), 373 (24), 337 (12)
 beste Teiler 48.5 (39.) 58.0 (15.) 61.0 (6.)
 Trefferlage 0.17 mm links, 0.30 mm hoch
 Streuwert 1.33, horizontal: 1.57, vertikal: 1.02

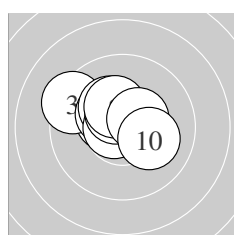
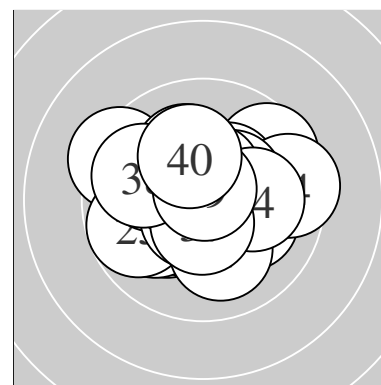

Serie 1:
 10.6 * 10.4 * 9.3 ↖ 10.4 * 10.3 *
 10.7 * 10.5 * 10.3 * 10.5 * 10.1 →
 beste Teiler 61.0 (6.) 89.0 (1.) 113.6 (7.)
 Trefferlage 0.46 mm links, 0.69 mm hoch
 Streuwert 1.22, horizontal: 1.53, vertikal: 0.80

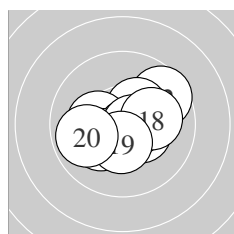

Serie 2:
 10.4 * 9.6 ↗ 10.3 * 10.2 * 10.7 *
 10.2 * 10.6 * 10.1 → 10.4 * 9.9 ←
 beste Teiler 58.0 (15.) 76.1 (17.) 132.3 (19.)
 Trefferlage 0.22 mm rechts, 0.08 mm tief
 Streuwert 1.42, horizontal: 1.73, vertikal: 1.02

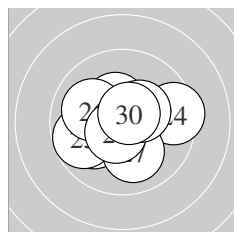

Serie 3:
 10.4 * 10.6 * 10.0 ↙ 9.5 → 9.8 ←
 10.0 ↖ 10.1 ↓ 10.6 * 10.4 * 10.6 *
 beste Teiler 78.0 (30.) 86.5 (28.) 99.0 (22.)
 Trefferlage 0.12 mm links, 0.15 mm tief
 Streuwert 1.58, horizontal: 1.93, vertikal: 1.14

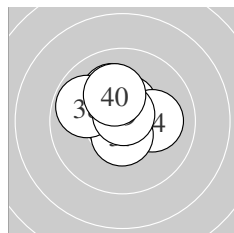

Serie 4:
 10.1 ↖ 10.5 * 10.7 * 10.1 → 10.5 *
 10.5 * 10.6 * 9.8 ↖ 10.8 * 10.2 *
 beste Teiler 48.5 (39.) 67.9 (33.) 99.0 (37.)
 Trefferlage 0.32 mm links, 0.74 mm hoch
 Streuwert 1.03, horizontal: 1.18, vertikal: 0.85

Unterschrift des Schützen

Meyton Elektronik

EYL Rifle – Wertung – offene Klasse

StartNr: 38

StandNr: 140

10. Juni 2018 12:11

?NIDARI?, Nusa #1000000249

Slovenia / Slovenia

Ergebnis: **412.1** (394)
 Serien: 101.6 101.9 104.7 103.9
 Zähler: 34 6 0 0 0 0 0 0 0 0
 Innenzehner: 28
 weiteste: 358 (11), 315 (2), 297 (19)
 beste Teiler 41.5 (33.) 45.3 (10.) 48.8 (5.)
 Trefferlage 0.01 mm links, 0.30 mm hoch
 Streuwert 1.28, horizontal: 1.21, vertikal: 1.35

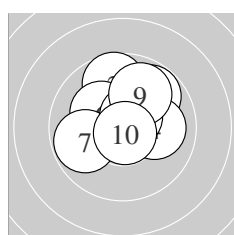
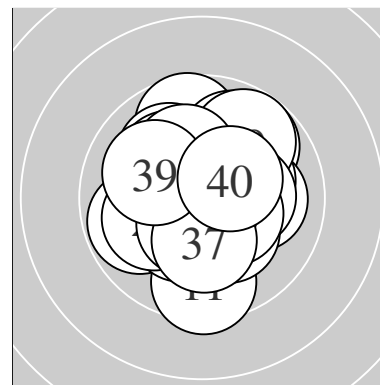

Serie 1:
 10.0 ↑ 9.7 ↑ 9.8 ↗ 10.0 → 10.8 *
 10.2 * 9.8 ← 10.6 * 9.9 ↗ 10.8 *
 beste Teiler 45.3 (10.) 48.8 (5.) 96.8 (8.)
 Trefferlage 0.04 mm rechts, 1.01 mm hoch
 Streuwert 1.47, horizontal: 1.53, vertikal: 1.40

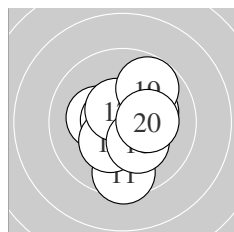

Serie 2:
 9.5 ↓ 10.3 * 10.2 * 10.6 * 10.3 *
 10.2 * 10.6 * 10.2 * 9.8 ↗ 10.2 *
 beste Teiler 77.4 (14.) 97.4 (17.) 154.8 (12.)
 Trefferlage 0.34 mm rechts, 0.30 mm tief
 Streuwert 1.48, horizontal: 1.28, vertikal: 1.65

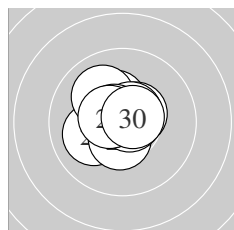

Serie 3:
 10.1 ← 10.5 * 10.3 * 10.8 * 10.5 *
 10.0 ↘ 10.6 * 10.7 * 10.6 * 10.6 *
 beste Teiler 50.4 (24.) 75.0 (28.) 80.4 (30.)
 Trefferlage 0.30 mm links, 0.37 mm hoch
 Streuwert 0.94, horizontal: 0.99, vertikal: 0.90

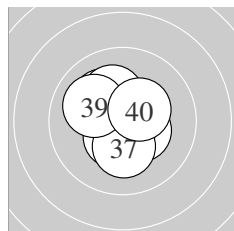

Serie 4:
 10.6 * 10.5 * 10.8 * 10.4 * 10.7 *
 10.1 ↘ 10.2 * 10.2 * 10.0 ↘ 10.4 *
 beste Teiler 41.5 (33.) 59.2 (35.) 94.7 (31.)
 Trefferlage 0.13 mm links, 0.12 mm hoch
 Streuwert 1.13, horizontal: 1.06, vertikal: 1.19

Unterschrift des Schützen

Meyton Elektronik

EYL Rifle – Wertung – offene Klasse

StartNr: 39

StandNr: 142

10. Juni 2018 12:10

SO?I?, Jure #1000000250

Slovenia / Slovenia

Ergebnis: **407.7** (386)
 Serien: 103.5 100.4 103.0 100.8
 Zähler: 26 14 0 0 0 0 0 0 0 0
 Innenzehner: 22
 weiteste: 352 (18), 347 (23), 334 (12)
 beste Teiler 9.0 (14.) 12.3 (28.) 57.4 (8.)
 Trefferlage 0.25 mm links, 0.33 mm hoch
 Streuwert 1.50, horizontal: 1.66, vertikal: 1.32

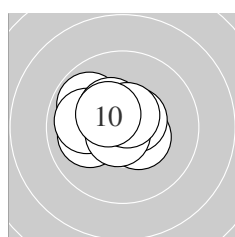
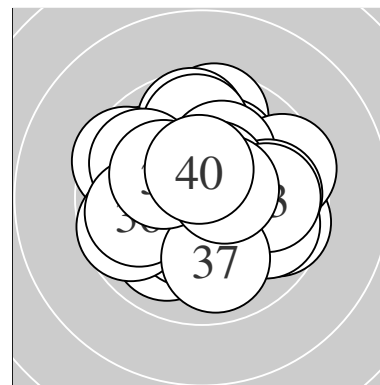

Serie 1:
 9.9 ↘ 10.5 * 10.0 ← 10.0 ← 10.4 *
 10.6 * 10.4 * 10.7 * 10.6 * 10.4 *
 beste Teiler 57.4 (8.) 87.6 (9.) 95.5 (6.)
 Trefferlage 0.77 mm links, 0.44 mm hoch
 Streuwert 1.05, horizontal: 1.28, vertikal: 0.76

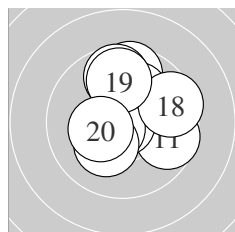

Serie 2:
 9.7 → 9.6 ↑ 9.7 ↑ 10.9 * 10.1 ↗
 10.6 * 10.2 * 9.5 → 9.8 ↑ 10.3 *
 beste Teiler 9.0 (14.) 82.3 (16.) 158.4 (20.)
 Trefferlage 0.38 mm rechts, 0.88 mm hoch
 Streuwert 1.74, horizontal: 1.65, vertikal: 1.82

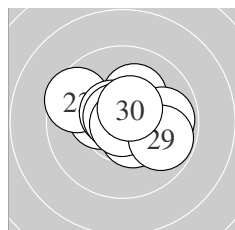

Serie 3:
 10.3 * 10.2 * 9.6 ↘ 9.9 → 10.6 *
 10.5 * 10.7 * 10.9 * 9.8 → 10.5 *
 beste Teiler 12.3 (28.) 61.8 (27.) 97.0 (25.)
 Trefferlage 0.14 mm rechts, 0.37 mm hoch
 Streuwert 1.41, horizontal: 1.77, vertikal: 0.92

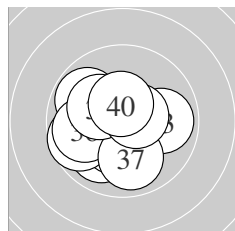

Serie 4:
 10.0 ↙ 10.3 * 9.9 → 9.8 ↘ 9.7 ←
 9.9 ← 9.9 ↓ 10.2 * 10.6 * 10.5 *
 beste Teiler 99.7 (39.) 118.6 (40.) 153.0 (32.)
 Trefferlage 0.75 mm links, 0.37 mm tief
 Streuwert 1.60, horizontal: 1.79, vertikal: 1.38

Unterschrift des Schützen

Meyton Elektronik

Ergebnis: **399.7** (382)
 Serien: 99.8 100.4 99.5 100.0
 Zähler: 23 16 1 0 0 0 0 0 0 0
 Innenzehner: 13
 weiteste: 559 (28), 420 (37), 382 (35)
 beste Teiler 82.8 (15.) 86.6 (25.) 88.0 (33.)
 Trefferlage 0.18 mm links, 0.00 mm
 Streuwert 1.86, horizontal: 2.12, vertikal: 1.55

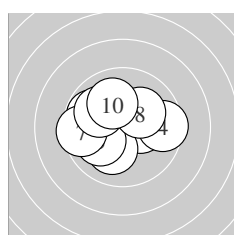
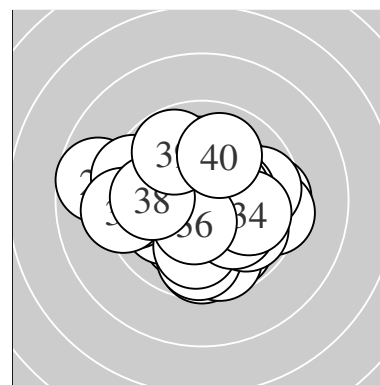

Serie 1:
 10.5 * 10.3 * 10.1 ↙ 9.5 → 10.0 ↖
 9.8 ↖ 9.5 ← 10.1 ↗ 10.0 ↘ 10.0 ↗
 beste Teiler 121.0 (1.) 158.1 (2.) 201.0 (8.)
 Trefferlage 0.42 mm links, 0.24 mm hoch
 Streuwert 1.83, horizontal: 2.29, vertikal: 1.23

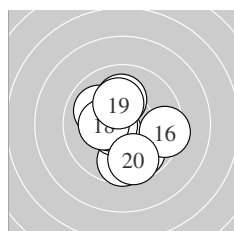

Serie 2:
 9.8 ↘ 10.1 ↑ 10.0 ↖ 9.7 ↓ 10.6 *
 9.4 → 10.6 * 10.3 * 10.2 * 9.7 ↓
 beste Teiler 82.8 (15.) 95.0 (17.) 166.0 (18.)
 Trefferlage 0.03 mm rechts, 0.49 mm tief
 Streuwert 1.81, horizontal: 1.68, vertikal: 1.93

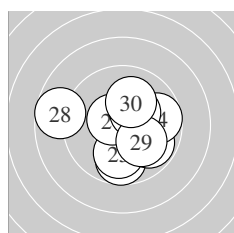

Serie 3:
 9.7 ↓ 9.8 ↘ 10.0 ↓ 9.7 → 10.6 *
 10.5 * 10.3 * 8.7 ← 10.1 ↘ 10.1 ↑
 beste Teiler 86.6 (25.) 103.3 (26.) 156.9 (27.)
 Trefferlage 0.26 mm rechts, 0.27 mm tief
 Streuwert 2.06, horizontal: 2.36, vertikal: 1.71

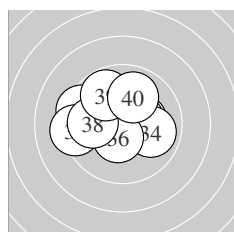

Serie 4:
 10.3 * 10.4 * 10.6 * 9.9 → 9.4 ↖
 10.5 * 9.3 ← 9.9 ← 9.8 ↘ 9.9 ↑
 beste Teiler 88.0 (33.) 123.0 (36.) 143.0 (32.)
 Trefferlage 0.61 mm links, 0.54 mm hoch
 Streuwert 1.84, horizontal: 2.30, vertikal: 1.23

Unterschrift des Schützen

Meyton Elektronik