

Ergebnis: **409.5** (393)  
 Serien: 101.2 102.8 103.2 102.3  
 Zähler: 34 5 1 0 0 0 0 0 0  
 Innenzehner: 29  
 Weitester: 532 (1.), 338 (14.), 328 (16.)  
 beste Teiler: 82.2 (13.), 91.6 (11.), 92.4 (17.)  
 Trefferlage: 0.47 mm rechts, 0.26 mm tief  
 Streuwert: 1.37, horizontal: 1.36, vertikal: 1.37

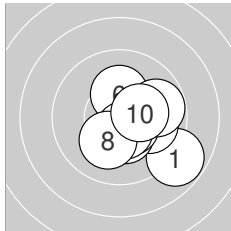
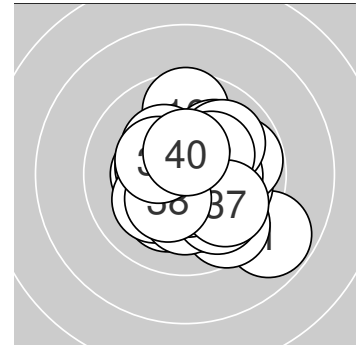

**Serie 1:**

8.8 ↘	10.0 →	10.4 *	10.5 *	10.5 *
10.2 *	10.5 *	10.2 *	9.8 →	10.3 *

beste Teiler: 107.2 (7.), 109.1 (5.), 109.2 (4.)  
 Trefferlage: 1.22 mm rechts, 0.47 mm tief  
 Streuwert: 1.50, horizontal: 1.55, vertikal: 1.46

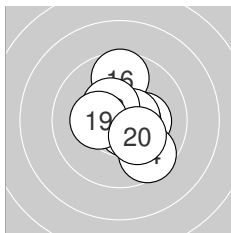

**Serie 2:**

10.6 *	10.2 *	10.6 *	9.6 ↘	10.6 *
9.6 ↑	10.6 *	10.5 *	10.3 *	10.2 *

beste Teiler: 82.2 (13.), 91.6 (11.), 92.4 (17.)  
 Trefferlage: 0.55 mm rechts, 0.08 mm hoch  
 Streuwert: 1.36, horizontal: 1.15, vertikal: 1.54

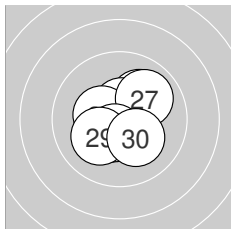

**Serie 3:**

10.1 ↗	10.4 *	10.6 *	10.5 *	10.4 *
10.4 *	10.0 ↗	10.5 *	10.1 ↗	10.2 *

beste Teiler: 98.1 (23.), 112.6 (28.), 120.2 (24.)  
 Trefferlage: 0.18 mm links, 0.14 mm tief  
 Streuwert: 1.26, horizontal: 1.32, vertikal: 1.20

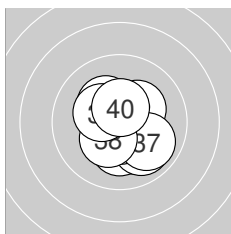

**Serie 4:**

10.1 ↘	10.3 *	10.2 *	9.9 ↘	10.3 *
10.5 *	9.9 ↘	10.3 *	10.3 *	10.5 *

beste Teiler: 102.9 (36.), 113.2 (40.), 154.5 (38.)  
 Trefferlage: 0.30 mm rechts, 0.51 mm tief  
 Streuwert: 1.30, horizontal: 1.20, vertikal: 1.39



Ergebnis: **414.1** (397)  
 Serien: 103.1 101.6 104.2 105.2  
 Zähler: 37 3 0 0 0 0 0 0 0 0  
 Innenzehner: 32  
 Weitesten: 330 (13.), 318 (14.), 263 (17.)  
 beste Teiler: 18.7 (33.), 31.1 (25.), 39.4 (39.)  
 Trefferlage: 0.20 mm rechts, 0.23 mm tief  
 Streuwert: 1.16, horizontal: 1.21, vertikal: 1.11

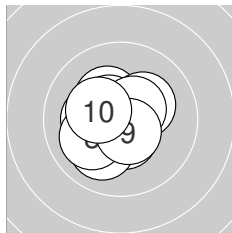
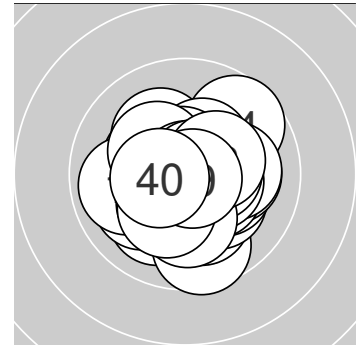

**Serie 1:**

10.3 *	10.5 *	10.2 *	10.5 *	10.2 *
10.0 ↙	10.5 *	10.0 ↙	10.6 *	10.3 *

beste Teiler: 97.9 (9.), 108.9 (4.), 110.2 (7.)  
 Trefferlage: 0.50 mm links, 0.06 mm tief  
 Streuwert: 1.16, horizontal: 1.21, vertikal: 1.12

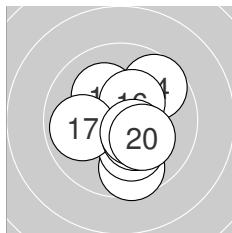

**Serie 2:**

10.7 *	10.2 *	9.6 ↓	9.7 ↗	10.1 ↓
10.4 *	9.9 ←	10.3 *	10.5 *	10.2 *

beste Teiler: 53.6 (11.), 118.8 (19.), 143.1 (16.)  
 Trefferlage: 0.36 mm rechts, 0.39 mm tief  
 Streuwert: 1.54, horizontal: 1.40, vertikal: 1.68

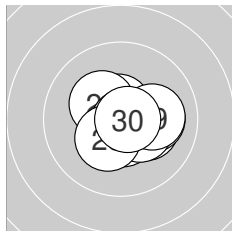

**Serie 3:**

10.2 *	10.6 *	10.6 *	10.3 *	10.8 *
10.1 →	10.4 *	10.3 *	10.1 →	10.8 *

beste Teiler: 31.1 (25.), 48.0 (30.), 83.3 (23.)  
 Trefferlage: 0.59 mm rechts, 0.17 mm tief  
 Streuwert: 1.00, horizontal: 1.20, vertikal: 0.74

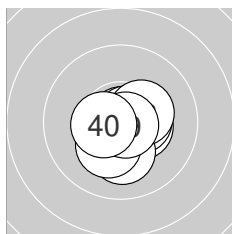

**Serie 4:**

10.4 *	10.4 *	10.9 *	10.7 *	10.2 *
10.7 *	10.3 *	10.3 *	10.8 *	10.5 *

beste Teiler: 18.7 (33.), 39.4 (39.), 52.3 (36.)  
 Trefferlage: 0.35 mm rechts, 0.30 mm tief  
 Streuwert: 0.84, horizontal: 0.86, vertikal: 0.82



Ergebnis: **408.7** (391)  
 Serien: 100.3 101.0 104.1 103.3  
 Zähler: 32 7 1 0 0 0 0 0 0  
 Innenzehner: 27  
 Weitestе: 553 (16.), 484 (4.), 336 (8.)  
 beste Teiler: 23.7 (29.), 33.0 (9.), 71.4 (39.)  
 Trefferlage: 0.68 mm rechts, 0.42 mm hoch  
 Streuwert: 1.41, horizontal: 1.40, vertikal: 1.42

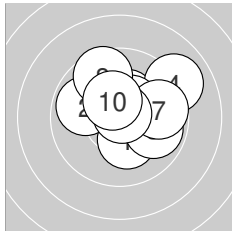
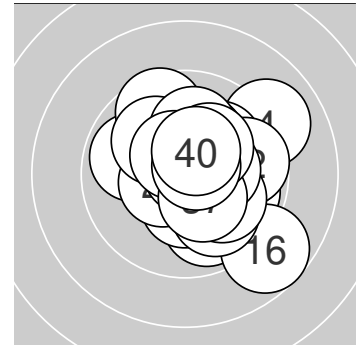

**Serie 1:**

10.2 *	9.9 ↖	10.4 *	9.0 ↗	9.9 ↗
10.4 *	9.7 →	9.6 ↘	10.8 *	10.4 *

beste Teiler: 33.0 (9.), 126.8 (6.), 138.0 (10.)  
 Trefferlage: 0.74 mm rechts, 0.84 mm hoch  
 Streuwert: 1.75, horizontal: 2.02, vertikal: 1.43

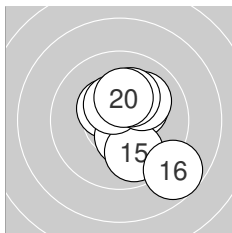

**Serie 2:**

10.4 *	10.3 *	10.4 *	10.3 *	9.9 ↘
8.7 ↘	10.4 *	10.1 ↗	10.2 *	10.3 *

beste Teiler: 126.6 (13.), 128.1 (17.), 135.3 (11.)  
 Trefferlage: 0.89 mm rechts, 0.20 mm hoch  
 Streuwert: 1.70, horizontal: 1.38, vertikal: 1.96

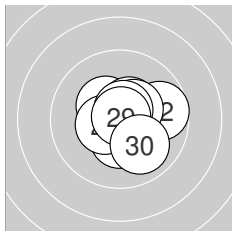

**Serie 3:**

10.4 *	9.7 →	10.5 *	10.6 *	10.4 *
10.4 *	10.5 *	10.7 *	10.9 *	10.0 ↘

beste Teiler: 23.7 (29.), 74.4 (28.), 85.4 (24.)  
 Trefferlage: 0.52 mm rechts, 0.00 mm  
 Streuwert: 1.13, horizontal: 1.22, vertikal: 1.04

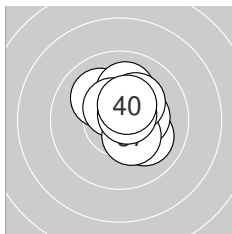

**Serie 4:**

10.1 ↘	10.1 ↘	10.3 *	10.1 ↑	10.5 *
10.5 *	10.4 *	10.2 *	10.7 *	10.4 *

beste Teiler: 71.4 (39.), 108.6 (36.), 110.1 (35.)  
 Trefferlage: 0.57 mm rechts, 0.64 mm hoch  
 Streuwert: 1.06, horizontal: 0.98, vertikal: 1.13



Ergebnis: **405.8** (387)  
 Serien: 103.0 100.8 101.9 100.1  
 Zähler: 27 13 0 0 0 0 0 0 0 0  
 Innenzehner: 21  
 Weitester: 444 (39.), 428 (13.), 428 (40.)  
 beste Teiler: 19.4 (3.), 27.7 (38.), 44.9 (6.)  
 Trefferlage: 0.68 mm rechts, 0.23 mm hoch  
 Streuwert: 1.56, horizontal: 1.68, vertikal: 1.42

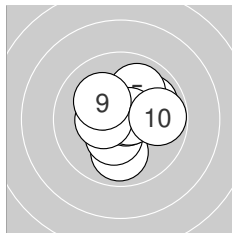
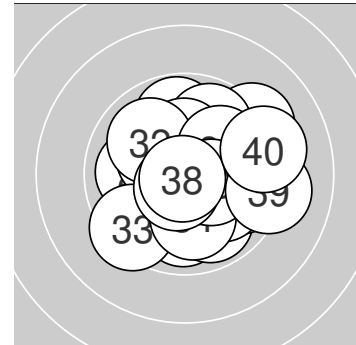

**Serie 1:**

9.9 ↓	9.9 ↗	10.9 *	10.4 *	10.0 ↗
10.8 *	10.7 *	10.4 *	10.2 *	9.8 →

beste Teiler: 19.4 (3.), 44.9 (6.), 68.0 (7.)  
 Trefferlage: 0.39 mm rechts, 0.14 mm hoch  
 Streuwert: 1.38, horizontal: 1.42, vertikal: 1.34

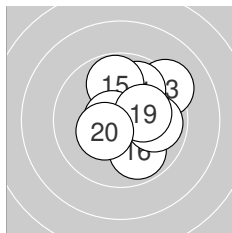

**Serie 2:**

10.5 *	10.3 *	9.2 ↗	9.9 ↗	9.8 ↑
9.9 ↘	9.9 →	10.7 *	10.2 *	10.4 *

beste Teiler: 65.2 (18.), 125.2 (11.), 150.9 (20.)  
 Trefferlage: 0.98 mm rechts, 0.61 mm hoch  
 Streuwert: 1.58, horizontal: 1.51, vertikal: 1.64

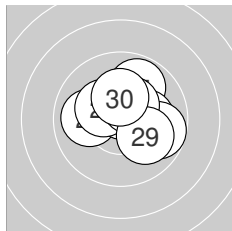

**Serie 3:**

10.0 ←	10.7 *	10.4 *	10.3 *	9.8 ↗
10.2 *	9.8 →	10.4 *	10.0 ↘	10.3 *

beste Teiler: 67.4 (22.), 128.8 (23.), 134.0 (28.)  
 Trefferlage: 0.59 mm rechts, 0.58 mm hoch  
 Streuwert: 1.38, horizontal: 1.59, vertikal: 1.13

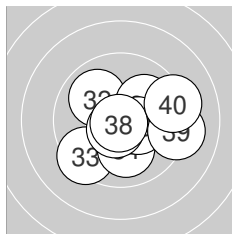

**Serie 4:**

10.4 *	10.0 ↘	9.4 ↗	10.1 ↓	10.0 ↗
10.4 *	10.6 *	10.8 *	9.2 →	9.2 →

beste Teiler: 27.7 (38.), 81.6 (37.), 136.1 (31.)  
 Trefferlage: 0.74 mm rechts, 0.41 mm tief  
 Streuwert: 1.93, horizontal: 2.28, vertikal: 1.50



**Ergebnis:** **414.4** (395)  
**Serien:** 105.2 103.3 101.7 104.2  
**Zähler:** 35 5 0 0 0 0 0 0 0 0  
**Innenzehner:** 29  
**Weiteste:** 302 (27.), 289 (15.), 269 (21.)  
**beste Teiler:** 18.9 (33.), 42.0 (12.), 52.0 (1.)  
**Trefferlage:** 0.29 mm links, 0.36 mm hoch  
**Streuwert:** 1.14, horizontal: 1.05, vertikal: 1.23

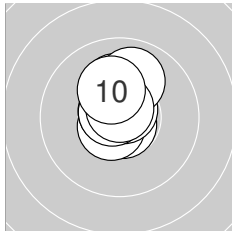
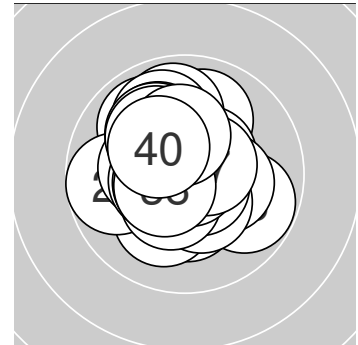

**Serie 1:**

10.7 *	10.7 *	10.6 *	10.2 *	10.7 *
10.7 *	10.0 ↑	10.7 *	10.7 *	10.2 *

**beste Teiler:** 52.0 (1.), 56.8 (6.), 58.8 (8.)  
**Trefferlage:** 0.15 mm links, 0.74 mm hoch  
**Streuwert:** 0.77, horizontal: 0.44, vertikal: 1.00

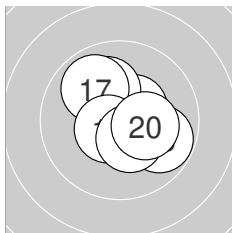

**Serie 2:**

10.5 *	10.8 *	10.2 *	10.7 *	9.8 ↘
10.1 ↘	9.9 ↘	10.6 *	10.4 *	10.3 *

**beste Teiler:** 42.0 (12.), 75.7 (14.), 94.8 (18.)  
**Trefferlage:** 0.38 mm rechts, 0.06 mm hoch  
**Streuwert:** 1.30, horizontal: 1.36, vertikal: 1.23

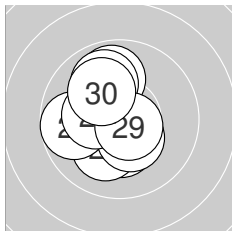

**Serie 3:**

9.9 ↑	10.3 *	10.1 ↙	10.4 *	9.9 ↘
10.4 *	9.7 ←	10.3 *	10.6 *	10.1 ↘

**beste Teiler:** 77.0 (29.), 128.7 (24.), 142.5 (26.)  
**Trefferlage:** 0.78 mm links, 0.22 mm hoch  
**Streuwert:** 1.39, horizontal: 1.10, vertikal: 1.62

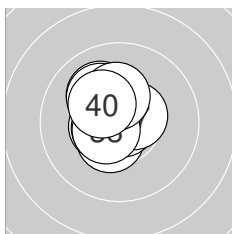

**Serie 4:**

10.5 *	10.5 *	10.9 *	10.5 *	10.1 ↘
10.1 ↘	10.5 *	10.5 *	10.3 *	10.3 *

**beste Teiler:** 18.9 (33.), 102.0 (37.), 102.3 (34.)  
**Trefferlage:** 0.64 mm links, 0.44 mm hoch  
**Streuwert:** 0.91, horizontal: 0.73, vertikal: 1.06



Ergebnis: **415.3** (395)  
 Serien: 102.2 105.0 104.9 103.2  
 Zähler: 35 5 0 0 0 0 0 0 0 0  
 Innenzehner: 33  
 Weitester: 452 (4.), 322 (9.), 283 (38.)  
 beste Teiler: 7.8 (25.), 15.0 (14.), 50.5 (12.)  
 Trefferlage: 0.18 mm links, 0.18 mm hoch  
 Streuwert: 1.17, horizontal: 1.23, vertikal: 1.10

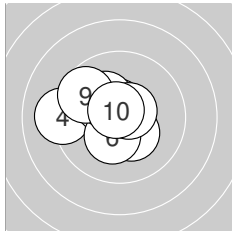
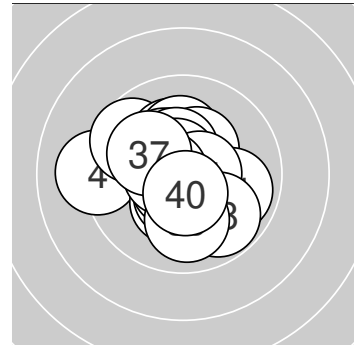

**Serie 1:**

10.4 *	10.6 *	10.3 *	9.1 ←	10.3 *
10.3 *	10.2 *	10.6 *	9.7 ↘	10.7 *

beste Teiler: 63.9 (10.), 85.6 (2.), 88.4 (8.)  
 Trefferlage: 1.03 mm links, 0.40 mm hoch  
 Streuwert: 1.36, horizontal: 1.62, vertikal: 1.05

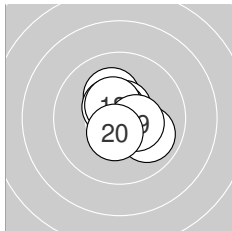

**Serie 2:**

10.2 *	10.8 *	10.5 *	10.9 *	10.6 *
10.7 *	9.9 ↘	10.5 *	10.4 *	10.5 *

beste Teiler: 15.0 (14.), 50.5 (12.), 62.0 (16.)  
 Trefferlage: 0.16 mm rechts, 0.18 mm hoch  
 Streuwert: 0.96, horizontal: 0.93, vertikal: 0.99

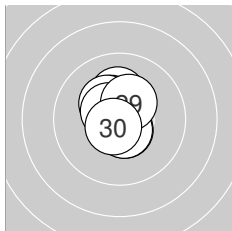

**Serie 3:**

10.6 *	10.4 *	10.2 *	10.4 *	10.9 *
10.3 *	10.6 *	10.5 *	10.4 *	10.6 *

beste Teiler: 7.8 (25.), 77.3 (30.), 93.2 (27.)  
 Trefferlage: 0.14 mm links, 0.53 mm hoch  
 Streuwert: 0.84, horizontal: 0.59, vertikal: 1.02

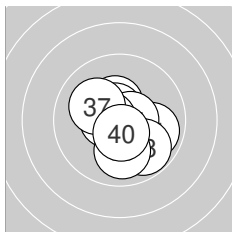

**Serie 4:**

10.7 *	10.4 *	10.6 *	9.9 ↘	10.6 *
10.6 *	10.1 ↘	9.8 ↘	10.0 ↓	10.5 *

beste Teiler: 75.2 (31.), 80.5 (33.), 87.0 (35.)  
 Trefferlage: 0.25 mm rechts, 0.38 mm tief  
 Streuwert: 1.27, horizontal: 1.27, vertikal: 1.26



Ergebnis: **414.8** (398)  
 Serien: 104.9 104.1 103.7 102.1  
 Zähler: 38 2 0 0 0 0 0 0 0  
 Innenzehner: 29  
 Weitester: 274 (21.), 251 (36.), 224 (34.)  
 beste Teiler: 62.7 (27.), 71.5 (30.), 72.2 (6.)  
 Trefferlage: 0.43 mm rechts, 0.13 mm hoch  
 Streuwert: 1.07, horizontal: 1.05, vertikal: 1.10

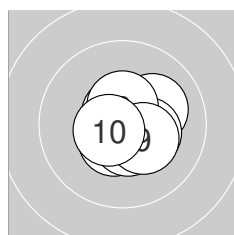
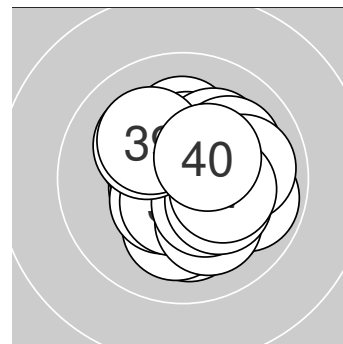

**Serie 1:**

10.1 ↗	10.5 *	10.5 *	10.3 *	10.7 *
10.7 *	10.7 *	10.5 *	10.3 *	10.6 *

beste Teiler: 72.2 (6.), 72.8 (5.), 73.0 (7.)  
 Trefferlage: 0.31 mm rechts, 0.03 mm hoch  
 Streuwert: 0.89, horizontal: 0.91, vertikal: 0.87

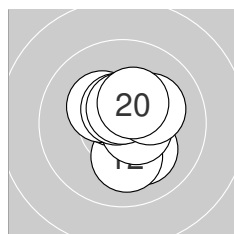

**Serie 2:**

10.1 ↘	10.1 ↓	10.6 *	10.6 *	10.3 *
10.6 *	10.6 *	10.6 *	10.2 *	10.4 *

beste Teiler: 89.9 (13.), 92.8 (16.), 93.0 (18.)  
 Trefferlage: 0.33 mm rechts, 0.16 mm hoch  
 Streuwert: 1.06, horizontal: 0.91, vertikal: 1.19

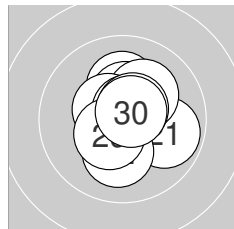

**Serie 3:**

9.9 ↗	10.1 ↓	10.1 ↑	10.4 *	10.2 *
10.5 *	10.7 *	10.6 *	10.5 *	10.7 *

beste Teiler: 62.7 (27.), 71.5 (30.), 91.2 (28.)  
 Trefferlage: 0.34 mm rechts, 0.34 mm hoch  
 Streuwert: 1.15, horizontal: 1.04, vertikal: 1.25

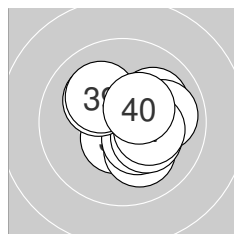

**Serie 4:**

10.5 *	10.1 ↘	10.4 *	10.1 ↗	10.2 *
9.9 →	10.3 *	10.1 ↖	10.1 ↖	10.4 *

beste Teiler: 106.7 (31.), 134.8 (40.), 140.2 (33.)  
 Trefferlage: 0.73 mm rechts, 0.01 mm hoch  
 Streuwert: 1.29, horizontal: 1.36, vertikal: 1.21



Ergebnis: **409.4** (389)  
 Serien: 103.8 102.3 104.2 99.1  
 Zähler: 30 9 1 0 0 0 0 0 0  
 Innenzehner: 27  
 Weitester: 622 (40.), 406 (31.), 397 (33.)  
 beste Teiler: 40.4 (39.), 45.0 (10.), 52.2 (29.)  
 Trefferlage: 0.40 mm rechts, 0.27 mm tief  
 Streuwert: 1.51, horizontal: 1.44, vertikal: 1.58

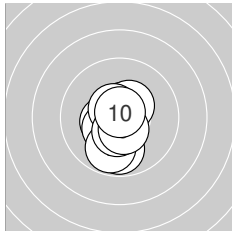
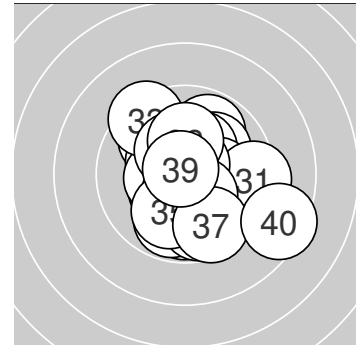

**Serie 1:**

9.8 ↓	10.6 *	10.4 *	10.4 *	10.4 *
10.6 *	9.8 ↓	10.5 *	10.5 *	10.8 *

beste Teiler: 45.0 (10.), 90.8 (6.), 93.0 (2.)  
 Trefferlage: 0.24 mm links, 0.60 mm tief  
 Streuwert: 1.10, horizontal: 0.68, vertikal: 1.40

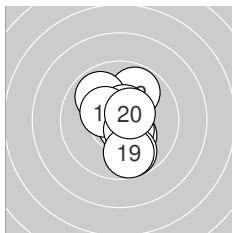

**Serie 2:**

10.3 *	9.8 ↗	9.9 ↘	10.7 *	10.6 *
10.4 *	10.5 *	9.8 ↓	9.8 ↓	10.5 *

beste Teiler: 64.1 (14.), 98.4 (15.), 109.0 (20.)  
 Trefferlage: 0.37 mm rechts, 0.15 mm tief  
 Streuwert: 1.49, horizontal: 1.03, vertikal: 1.84

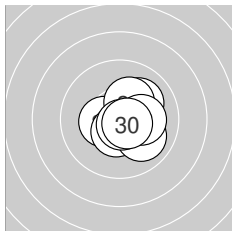

**Serie 3:**

10.1 ↗	10.4 *	10.7 *	10.7 *	10.3 *
10.5 *	10.0 ↘	10.2 *	10.7 *	10.6 *

beste Teiler: 52.2 (29.), 70.1 (24.), 72.6 (23.)  
 Trefferlage: 0.66 mm rechts, 0.14 mm tief  
 Streuwert: 1.00, horizontal: 1.03, vertikal: 0.96

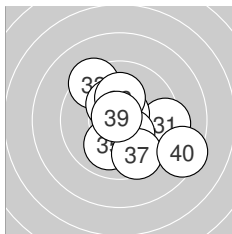

**Serie 4:**

9.3 →	10.7 *	9.4 ↘	10.3 *	10.0 ↓
10.3 *	9.6 ↓	10.2 *	10.8 *	8.5 ↘

beste Teiler: 40.4 (39.), 70.4 (32.), 151.4 (34.)  
 Trefferlage: 0.82 mm rechts, 0.19 mm tief  
 Streuwert: 2.24, horizontal: 2.37, vertikal: 2.10





Ergebnis: **412.4** (396)  
 Serien: 104.7 101.0 102.7 104.0  
 Zähler: 36 4 0 0 0 0 0 0 0 0  
 Innenzehner: 29  
 Weitester: 444 (14.), 314 (9.), 304 (13.)  
 beste Teiler: 48.4 (20.), 53.6 (2.), 55.4 (4.)  
 Trefferlage: 0.07 mm links, 0.44 mm tief  
 Streuwert: 1.24, horizontal: 1.33, vertikal: 1.13

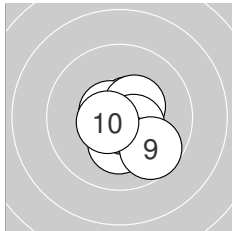
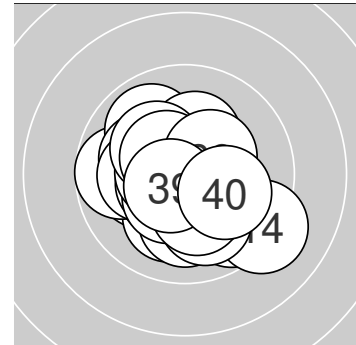

**Serie 1:**

10.7 *	10.7 *	10.6 *	10.7 *	10.6 *
10.4 *	10.5 *	10.2 *	9.7 ↘	10.6 *

beste Teiler: 53.6 (2.), 55.4 (4.), 71.2 (1.)  
 Trefferlage: 0.28 mm rechts, 0.43 mm tief  
 Streuwert: 0.97, horizontal: 0.97, vertikal: 0.98

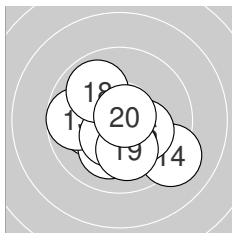

**Serie 2:**

10.1 ←	10.1 ↙	9.7 ←	9.2 ↘	10.5 *
10.2 *	10.4 *	9.9 ↘	10.1 ↓	10.8 *

beste Teiler: 48.4 (20.), 115.6 (15.), 129.1 (17.)  
 Trefferlage: 0.12 mm links, 0.73 mm tief  
 Streuwert: 1.67, horizontal: 1.93, vertikal: 1.36

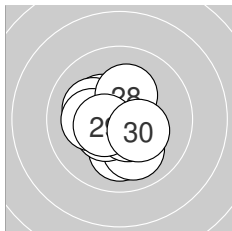

**Serie 3:**

10.1 ↓	10.0 ↘	10.3 *	10.4 *	10.6 *
10.1 ↖	10.2 *	10.2 *	10.5 *	10.3 *

beste Teiler: 100.2 (25.), 117.5 (29.), 126.6 (24.)  
 Trefferlage: 0.37 mm links, 0.38 mm tief  
 Streuwert: 1.24, horizontal: 1.21, vertikal: 1.27

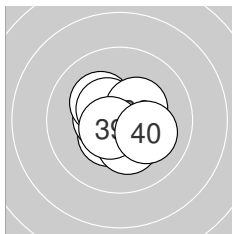

**Serie 4:**

10.4 *	10.5 *	10.2 *	10.3 *	10.7 *
10.5 *	10.3 *	10.4 *	10.6 *	10.1 ↘

beste Teiler: 63.6 (35.), 88.8 (39.), 112.4 (32.)  
 Trefferlage: 0.06 mm links, 0.24 mm tief  
 Streuwert: 1.07, horizontal: 1.16, vertikal: 0.98



Ergebnis: **418.1** (396)  
 Serien: 104.5 103.9 104.6 105.1  
 Zähler: 36 4 0 0 0 0 0 0 0  
 Innenzehner: 34  
 Weitester: 400 (24.), 372 (1.), 282 (39.)  
 beste Teiler: 24.7 (19.), 28.6 (29.), 35.8 (4.)  
 Trefferlage: 0.08 mm rechts, 0.01 mm tief  
 Streuwert: 1.08, horizontal: 1.25, vertikal: 0.88

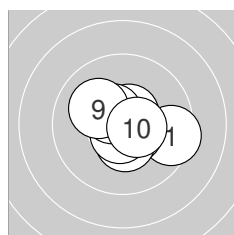
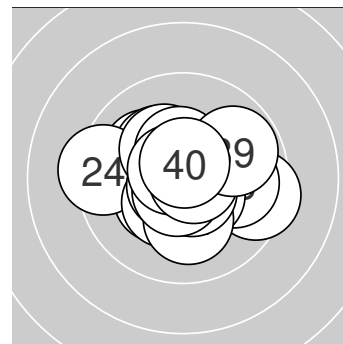

**Serie 1:**  
 9.5 → 10.6 \* 10.4 \* 10.8 \* 10.8 \*  
 10.7 \* 10.6 \* 10.5 \* 10.1 ↘ 10.5 \*  
 beste Teiler: 35.8 (4.), 43.0 (5.), 71.8 (6.)  
 Trefferlage: 0.36 mm rechts, 0.07 mm tief  
 Streuwert: 1.15, horizontal: 1.40, vertikal: 0.82

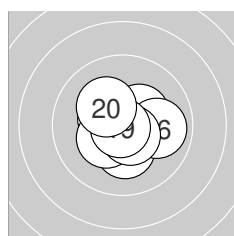

**Serie 2:**  
 10.4 \* 10.5 \* 10.5 \* 10.4 \* 10.2 \*  
 9.9 → 10.3 \* 10.6 \* 10.9 \* 10.2 \*  
 beste Teiler: 24.7 (19.), 94.8 (18.), 119.4 (12.)  
 Trefferlage: 0.31 mm rechts, 0.22 mm tief  
 Streuwert: 1.10, horizontal: 1.26, vertikal: 0.91

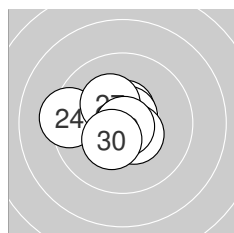

**Serie 3:**  
 10.6 \* 10.8 \* 10.5 \* 9.4 ← 10.6 \*  
 10.7 \* 10.3 \* 10.5 \* 10.8 \* 10.4 \*  
 beste Teiler: 28.6 (29.), 40.3 (22.), 63.2 (26.)  
 Trefferlage: 0.59 mm links, 0.20 mm hoch  
 Streuwert: 1.11, horizontal: 1.34, vertikal: 0.82

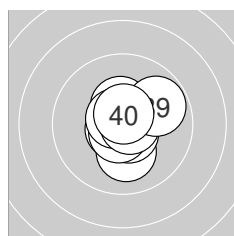

**Serie 4:**  
 10.7 \* 10.1 ↓ 10.6 \* 10.7 \* 10.4 \*  
 10.8 \* 10.7 \* 10.7 \* 9.8 ↗ 10.6 \*  
 beste Teiler: 42.4 (36.), 54.0 (38.), 66.8 (37.)  
 Trefferlage: 0.25 mm rechts, 0.04 mm hoch  
 Streuwert: 0.96, horizontal: 0.87, vertikal: 1.03



Ergebnis: **398.7** (381)  
 Serien: 101.1 99.2 98.1 100.3  
 Zähler: 22 17 1 0 0 0 0 0 0 0  
 Innenzehner: 14  
 Weitester: 598 (11.), 463 (8.), 424 (36.)  
 beste Teiler: 66.4 (5.), 77.1 (7.), 95.7 (39.)  
 Trefferlage: 0.30 mm rechts, 1.70 mm hoch  
 Streuwert: 1.49, horizontal: 1.64, vertikal: 1.33

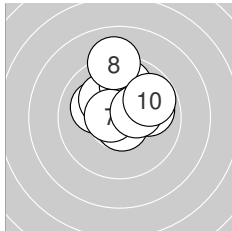
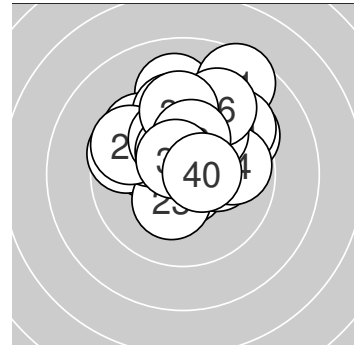

**Serie 1:**

9.9 →	10.5 *	10.1 ↖	10.2 *	10.7 *
9.9 ↑	10.6 *	9.1 ↑	10.3 *	9.8 ↗

beste Teiler: 66.4 (5.), 77.1 (7.), 117.0 (2.)  
 Trefferlage: 0.27 mm rechts, 1.29 mm hoch  
 Streuwert: 1.48, horizontal: 1.50, vertikal: 1.47

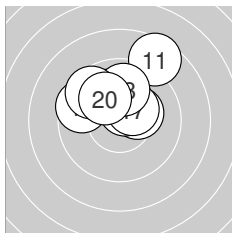

**Serie 2:**

8.6 ↗	10.0 ↘	9.6 ↖	10.3 *	10.5 *
10.2 *	10.4 *	9.9 ↑	9.6 ↘	10.1 ↘

beste Teiler: 101.0 (15.), 146.2 (17.), 164.1 (14.)  
 Trefferlage: 0.09 mm links, 1.95 mm hoch  
 Streuwert: 1.62, horizontal: 1.88, vertikal: 1.31

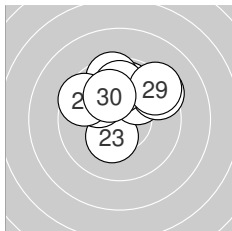

**Serie 3:**

9.9 ↑	9.5 ↑	10.3 *	10.0 ↘	9.6 ↖
10.0 ↗	9.4 ↗	9.9 ↑	9.4 ↗	10.1 ↘

beste Teiler: 160.7 (23.), 216.7 (30.), 233.4 (26.)  
 Trefferlage: 0.15 mm rechts, 1.91 mm hoch  
 Streuwert: 1.70, horizontal: 2.00, vertikal: 1.33

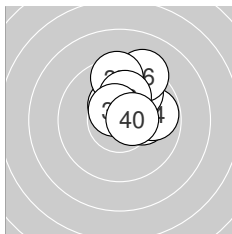

**Serie 4:**

10.4 *	10.1 ↑	10.2 *	9.8 →	9.8 ↗
9.3 ↗	9.5 ↑	10.1 ↑	10.6 *	10.5 *

beste Teiler: 95.7 (39.), 108.3 (40.), 137.2 (31.)  
 Trefferlage: 0.89 mm rechts, 1.66 mm hoch  
 Streuwert: 1.23, horizontal: 1.13, vertikal: 1.33



Ergebnis: **386.6** (365)  
 Serien: 95.9 101.7 90.9 98.1  
 Zähler: 17 15 7 0 0 0 1 0 0 0  
 Innenzehner: 11  
 Weitester: 1523 (22.), 568 (25.), 539 (31.)  
 beste Teiler: 55.2 (8.), 69.4 (30.), 70.7 (20.)  
 Trefferlage: 0.21 mm links, 0.96 mm tief  
 Streuwert: 2.79, horizontal: 3.29, vertikal: 2.17

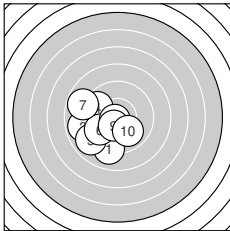
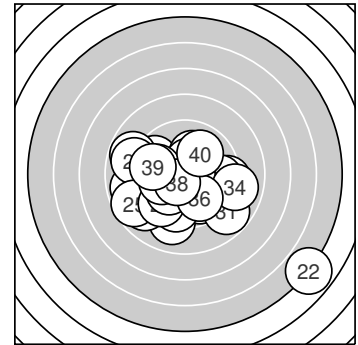

**Serie 1:**

9.1 ↓	9.8 ←	8.9 ←	9.6 ↖	8.9 ↙
9.7 ↙	8.8 ↖	10.7 *	10.4 *	10.0 ↘

beste Teiler: 55.2 (8.), 134.2 (9.), 249.2 (10.)  
 Trefferlage: 2.29 mm links, 1.09 mm tief  
 Streuwert: 2.05, horizontal: 2.11, vertikal: 1.99

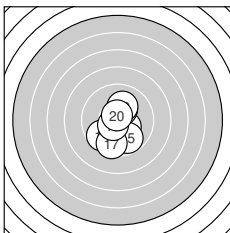

**Serie 2:**

10.3 *	10.2 *	10.3 *	10.4 *	9.8 ↘
9.7 ↙	9.6 ↓	10.1 ↑	10.6 *	10.7 *

beste Teiler: 70.7 (20.), 96.8 (19.), 138.9 (14.)  
 Trefferlage: 0.03 mm rechts, 0.52 mm tief  
 Streuwert: 1.56, horizontal: 1.12, vertikal: 1.91

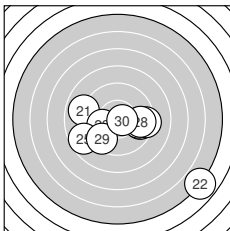

**Serie 3:**

8.9 ←	4.9 ↘	10.0 ←	9.6 →	8.7 ↙
9.7 →	9.3 →	9.6 →	9.5 ↙	10.7 *

beste Teiler: 69.4 (30.), 237.5 (23.), 306.2 (26.)  
 Trefferlage: 1.20 mm rechts, 1.67 mm tief  
 Streuwert: 4.19, horizontal: 5.12, vertikal: 2.97

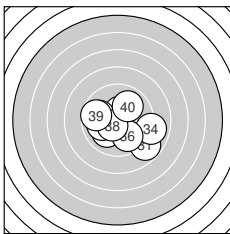

**Serie 4:**

8.8 ↘	10.4 *	10.0 ↙	8.9 →	9.9 ←
9.9 ↘	10.0 ←	10.5 *	9.7 ←	10.0 ↗

beste Teiler: 109.6 (38.), 127.0 (32.), 229.3 (33.)  
 Trefferlage: 0.17 mm rechts, 0.57 mm tief  
 Streuwert: 2.30, horizontal: 2.76, vertikal: 1.73



**Ergebnis:** **418.1** (397)  
**Serien:** 103.9 104.2 106.0 104.0  
**Zähler:** 37 3 0 0 0 0 0 0 0 0  
**Innenzehner:** 35  
**Weiteste:** 316 (40.), 312 (17.), 258 (2.)  
**beste Teiler:** 10.6 (21.), 24.5 (32.), 36.1 (27.)  
**Trefferlage:** 0.29 mm rechts, 0.19 mm hoch  
**Streuwert:** 1.00, horizontal: 1.15, vertikal: 0.82

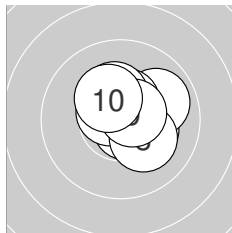
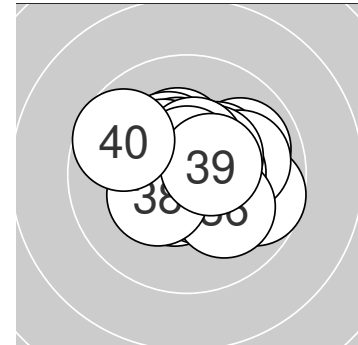

**Serie 1:**

10.3 *	9.9 ↗	10.7 *	10.5 *	10.5 *
10.6 *	10.3 *	10.2 *	10.6 *	10.3 *

**beste Teiler:** 59.5 (3.), 85.4 (6.), 89.4 (9.)  
**Trefferlage:** 0.45 mm rechts, 0.48 mm hoch  
**Streuwert:** 1.02, horizontal: 1.08, vertikal: 0.96

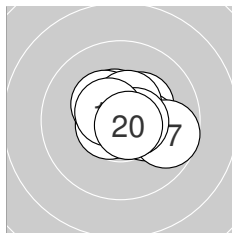

**Serie 2:**

10.6 *	10.3 *	10.3 *	10.5 *	10.4 *
10.5 *	9.7 ↗	10.6 *	10.6 *	10.7 *

**beste Teiler:** 62.1 (20.), 81.0 (11.), 93.5 (18.)  
**Trefferlage:** 0.49 mm rechts, 0.25 mm hoch  
**Streuwert:** 1.05, horizontal: 1.28, vertikal: 0.76

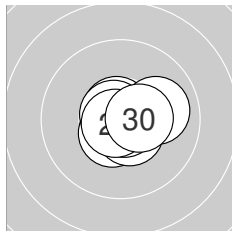

**Serie 3:**

10.9 *	10.7 *	10.6 *	10.5 *	10.5 *
10.0 →	10.8 *	10.7 *	10.8 *	10.5 *

**beste Teiler:** 10.6 (21.), 36.1 (27.), 44.2 (29.)  
**Trefferlage:** 0.29 mm rechts, 0.16 mm tief  
**Streuwert:** 0.75, horizontal: 0.90, vertikal: 0.56

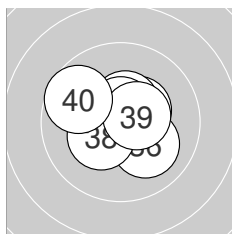

**Serie 4:**

10.6 *	10.9 *	10.4 *	10.5 *	10.3 *
10.1 ↘	10.7 *	10.3 *	10.5 *	9.7 ↘

**beste Teiler:** 24.5 (32.), 75.0 (37.), 77.0 (31.)  
**Trefferlage:** 0.07 mm links, 0.21 mm hoch  
**Streuwert:** 1.18, horizontal: 1.38, vertikal: 0.95



Ergebnis: **416.3** (399)  
 Serien: 104.6 103.8 103.5 104.4  
 Zähler: 39 1 0 0 0 0 0 0 0  
 Innenzehner: 34  
 Weitestе: 293 (19.), 250 (29.), 239 (5.)  
 beste Teiler: 40.3 (14.), 42.1 (2.), 48.0 (37.)  
 Trefferlage: 0.11 mm rechts, 0.00 mm  
 Streuwert: 1.08, horizontal: 0.96, vertikal: 1.18

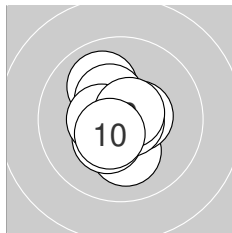
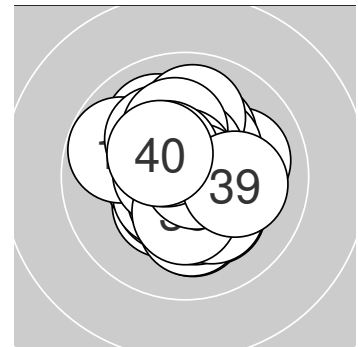

**Serie 1:**

10.1 ↓	10.8 *	10.5 *	10.4 *	10.0 ↖
10.7 *	10.4 *	10.5 *	10.7 *	10.5 *

beste Teiler: 42.1 (2.), 54.5 (6.), 68.6 (9.)  
 Trefferlage: 0.16 mm links, 0.02 mm tief  
 Streuwert: 1.02, horizontal: 0.84, vertikal: 1.18

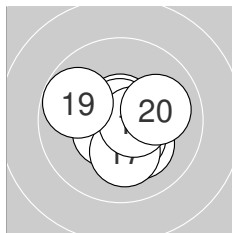

**Serie 2:**

10.2 *	10.7 *	10.5 *	10.8 *	10.5 *
10.5 *	10.2 *	10.6 *	9.8 ↙	10.0 →

beste Teiler: 40.3 (14.), 69.0 (12.), 85.7 (18.)  
 Trefferlage: 0.22 mm rechts, 0.33 mm tief  
 Streuwert: 1.19, horizontal: 1.32, vertikal: 1.04

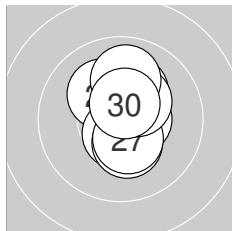

**Serie 3:**

10.5 *	10.2 *	10.2 *	10.5 *	10.6 *
10.3 *	10.4 *	10.3 *	10.0 ↑	10.5 *

beste Teiler: 94.1 (25.), 102.0 (21.), 103.3 (30.)  
 Trefferlage: 0.32 mm rechts, 0.30 mm hoch  
 Streuwert: 1.13, horizontal: 0.64, vertikal: 1.46

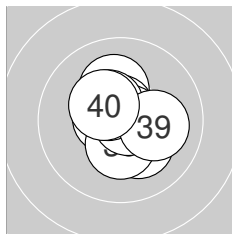

**Serie 4:**

10.2 *	10.2 *	10.6 *	10.6 *	10.3 *
10.7 *	10.8 *	10.5 *	10.1 →	10.4 *

beste Teiler: 48.0 (37.), 64.7 (36.), 82.7 (33.)  
 Trefferlage: 0.09 mm rechts, 0.05 mm hoch  
 Streuwert: 1.05, horizontal: 0.98, vertikal: 1.11



Ergebnis: **423.5** (400)  
 Serien: 106.3 106.2 105.5 105.5  
 Zähler: 40 0 0 0 0 0 0 0 0 0  
 Innenzehner: 39  
 Weitestе: 249 (37.), 176 (20.), 167 (29.)  
 beste Teiler: 9.0 (10.), 21.2 (11.), 23.6 (23.)  
 Trefferlage: 0.25 mm rechts, 0.10 mm tief  
 Streuwert: 0.70, horizontal: 0.68, vertikal: 0.73

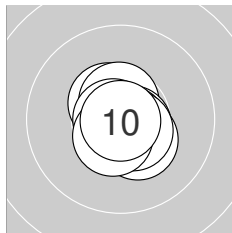
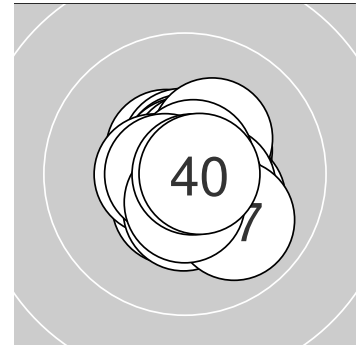

**Serie 1:**

10.6 *	10.5 *	10.6 *	10.7 *	10.4 *
10.7 *	10.8 *	10.6 *	10.5 *	10.9 *

beste Teiler: 9.0 (10.), 42.0 (7.), 54.4 (6.)  
 Trefferlage: 0.05 mm rechts, 0.08 mm tief  
 Streuwert: 0.67, horizontal: 0.56, vertikal: 0.76

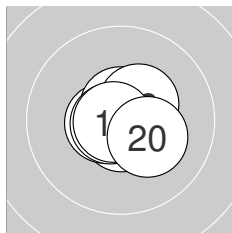

**Serie 2:**

10.9 *	10.7 *	10.6 *	10.5 *	10.7 *
10.7 *	10.7 *	10.4 *	10.8 *	10.2 *

beste Teiler: 21.2 (11.), 41.2 (19.), 55.0 (16.)  
 Trefferlage: 0.23 mm rechts, 0.01 mm hoch  
 Streuwert: 0.67, horizontal: 0.76, vertikal: 0.55

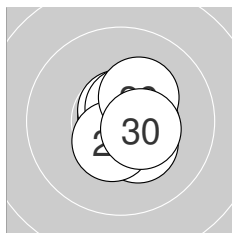

**Serie 3:**

10.7 *	10.5 *	10.9 *	10.3 *	10.5 *
10.7 *	10.6 *	10.5 *	10.3 *	10.5 *

beste Teiler: 23.6 (23.), 60.2 (21.), 61.8 (26.)  
 Trefferlage: 0.47 mm rechts, 0.09 mm hoch  
 Streuwert: 0.72, horizontal: 0.58, vertikal: 0.84

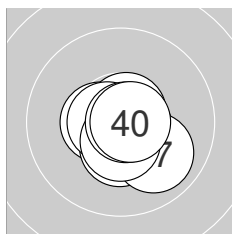

**Serie 4:**

10.6 *	10.5 *	10.7 *	10.4 *	10.7 *
10.6 *	10.0 ↘	10.5 *	10.8 *	10.7 *

beste Teiler: 28.0 (39.), 54.0 (40.), 60.5 (33.)  
 Trefferlage: 0.23 mm rechts, 0.46 mm tief  
 Streuwert: 0.76, horizontal: 0.81, vertikal: 0.71



**Ergebnis:** **412.5** (393)  
**Serien:** 103.3 100.0 104.3 104.9  
**Zähler:** 33 7 0 0 0 0 0 0 0  
**Innenzehner:** 30  
**Weiteste:** 414 (20.), 301 (16.), 298 (15.)  
**beste Teiler:** 20.0 (10.), 26.2 (33.), 45.1 (35.)  
**Trefferlage:** 0.15 mm links, 0.02 mm tief  
**Streuwert:** 1.30, horizontal: 1.46, vertikal: 1.10

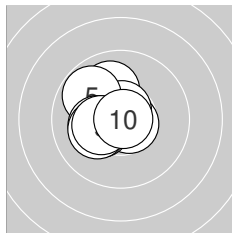
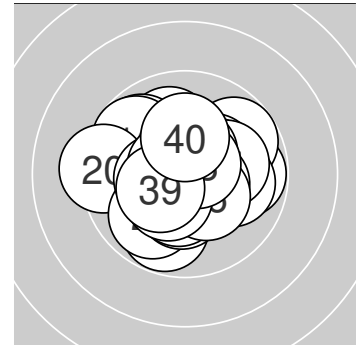

**Serie 1:**  
 10.2 \*                      10.7 \*                      10.0 ↗  
 10.2 \*                      10.3 \*                      10.2 \*  
**beste Teiler:** 20.0 (10.), 69.7 (4.), 74.7 (2.)  
**Trefferlage:** 0.99 mm links, 0.33 mm hoch  
**Streuwert:** 1.04, horizontal: 0.98, vertikal: 1.09

10.7 \*                      9.8 ↘  
 10.3 \*                      10.9 \*

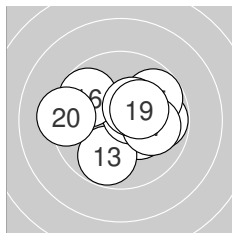

**Serie 2:**  
 10.3 \*                      9.8 →                      9.8 ↘  
 9.7 ↘                      10.0 →                      10.4 \*  
**beste Teiler:** 94.3 (14.), 134.1 (18.), 155.7 (11.)  
**Trefferlage:** 0.45 mm rechts, 0.21 mm hoch  
**Streuwert:** 1.87, horizontal: 2.30, vertikal: 1.30

10.6 \*                      9.8 ↗  
 10.3 \*                      9.3 ←

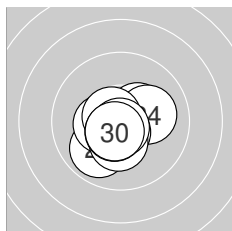

**Serie 3:**  
 9.9 ↙                      10.4 \*                      10.4 \*  
 10.3 \*                      10.6 \*                      10.6 \*  
**beste Teiler:** 49.3 (29.), 77.8 (27.), 84.0 (25.)  
**Trefferlage:** 0.15 mm links, 0.52 mm tief  
**Streuwert:** 1.00, horizontal: 1.11, vertikal: 0.88

10.1 →                      10.6 \*  
 10.8 \*                      10.6 \*

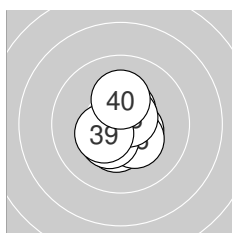

**Serie 4:**  
 10.5 \*                      10.4 \*                      10.8 \*  
 10.3 \*                      10.4 \*                      10.6 \*  
**beste Teiler:** 26.2 (33.), 45.1 (35.), 77.3 (38.)  
**Trefferlage:** 0.08 mm rechts, 0.12 mm tief  
**Streuwert:** 0.92, horizontal: 0.75, vertikal: 1.07

10.5 \*                      10.8 \*  
 10.4 \*                      10.2 \*





Ergebnis: **411.7** (394)  
 Serien: 103.5 102.2 102.5 103.5  
 Zähler: 34 6 0 0 0 0 0 0 0 0  
 Innenzehner: 26  
 Weitester: 433 (28.), 356 (24.), 342 (20.)  
 beste Teiler: 15.2 (26.), 37.2 (8.), 51.2 (33.)  
 Trefferlage: 0.42 mm links, 0.10 mm hoch  
 Streuwert: 1.31, horizontal: 1.68, vertikal: 0.80

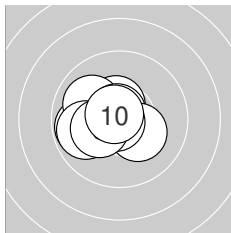
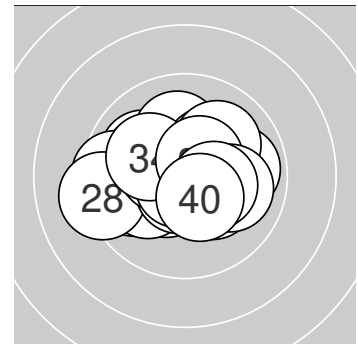

**Serie 1:**

10.5 *	9.8 ←	10.5 *	10.0 ↖	10.7 *
9.9 ←	10.3 *	10.8 *	10.3 *	10.7 *

beste Teiler: 37.2 (8.), 52.3 (5.), 55.9 (10.)  
 Trefferlage: 0.98 mm links, 0.05 mm tief  
 Streuwert: 1.06, horizontal: 1.29, vertikal: 0.78

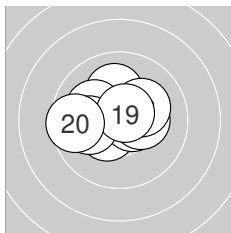

**Serie 2:**

10.2 *	10.4 *	10.6 *	10.1 ↑	10.3 *
10.1 ↖	10.0 ←	10.2 *	10.7 *	9.6 ←

beste Teiler: 69.8 (19.), 100.2 (13.), 130.9 (12.)  
 Trefferlage: 0.60 mm links, 0.34 mm hoch  
 Streuwert: 1.39, horizontal: 1.76, vertikal: 0.86

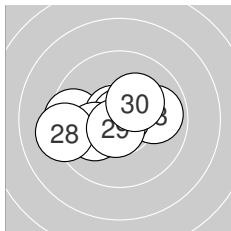

**Serie 3:**

10.6 *	10.7 *	9.9 →	9.5 ←	10.7 *
10.9 *	10.1 ←	9.2 ←	10.7 *	10.2 *

beste Teiler: 15.2 (26.), 56.8 (25.), 62.4 (22.)  
 Trefferlage: 0.65 mm links, 0.06 mm tief  
 Streuwert: 1.56, horizontal: 2.08, vertikal: 0.74

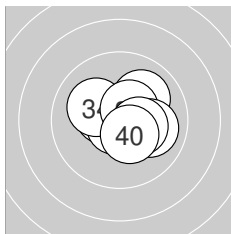

**Serie 4:**

10.5 *	10.6 *	10.7 *	10.1 ↖	10.4 *
10.0 ↗	10.5 *	10.0 →	10.3 *	10.4 *

beste Teiler: 51.2 (33.), 85.1 (32.), 112.6 (37.)  
 Trefferlage: 0.53 mm rechts, 0.19 mm hoch  
 Streuwert: 1.09, horizontal: 1.28, vertikal: 0.87



Ergebnis: **411.8** (395)  
 Serien: 102.7 102.7 102.8 103.6  
 Zähler: 35 5 0 0 0 0 0 0 0 0  
 Innenzehner: 30  
 Weitestе: 411 (19.), 307 (3.), 278 (24.)  
 beste Teiler: 28.4 (21.), 63.5 (40.), 65.9 (27.)  
 Trefferlage: 0.20 mm rechts, 0.14 mm hoch  
 Streuwert: 1.28, horizontal: 1.42, vertikal: 1.13

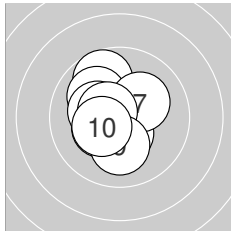
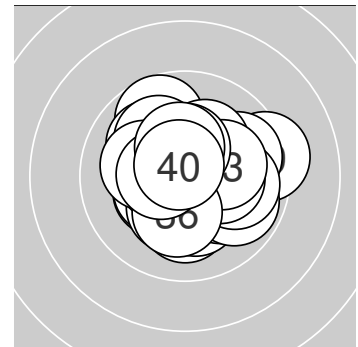

**Serie 1:**

10.6 *	10.5 *	9.7 ↖	10.3 *	10.0 ↖
10.3 *	10.2 *	10.6 *	10.1 ↓	10.4 *

beste Teiler: 90.4 (1.), 100.3 (8.), 122.0 (2.)  
 Trefferlage: 0.66 mm links, 0.24 mm hoch  
 Streuwert: 1.26, horizontal: 1.04, vertikal: 1.45

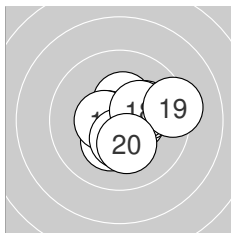

**Serie 2:**

10.4 *	10.5 *	10.2 *	10.6 *	10.3 *
10.5 *	10.4 *	10.3 *	9.3 →	10.2 *

beste Teiler: 93.0 (14.), 116.0 (16.), 118.0 (12.)  
 Trefferlage: 0.65 mm rechts, 0.09 mm tief  
 Streuwert: 1.35, horizontal: 1.56, vertikal: 1.11

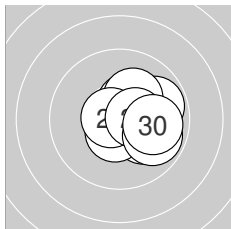

**Serie 3:**

10.8 *	10.4 *	10.1 ↘	9.8 →	10.5 *
10.2 *	10.7 *	10.5 *	9.9 ↘	9.9 →

beste Teiler: 28.4 (21.), 65.9 (27.), 101.8 (25.)  
 Trefferlage: 1.09 mm rechts, 0.00 mm  
 Streuwert: 1.11, horizontal: 1.22, vertikal: 0.99

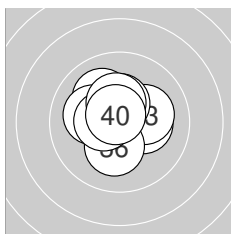

**Serie 4:**

10.7 *	10.3 *	10.2 *	10.1 ↖	10.4 *
10.2 *	10.1 ←	10.5 *	10.4 *	10.7 *

beste Teiler: 63.5 (40.), 70.8 (31.), 119.3 (38.)  
 Trefferlage: 0.25 mm links, 0.43 mm hoch  
 Streuwert: 1.14, horizontal: 1.24, vertikal: 1.02



Ergebnis: **416.7** (397)  
 Serien: 104.7 104.1 104.9 103.0  
 Zähler: 37 3 0 0 0 0 0 0 0 0  
 Innenzehner: 33  
 Weitestе: 322 (8.), 272 (40.), 257 (33.)  
 beste Teiler: 18.7 (38.), 25.0 (30.), 34.4 (29.)  
 Trefferlage: 0.16 mm links, 0.10 mm hoch  
 Streuwert: 1.09, horizontal: 1.19, vertikal: 0.97

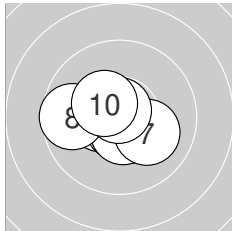
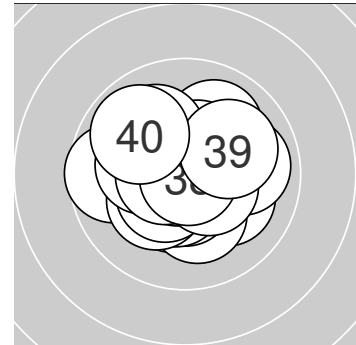

**Serie 1:**

10.5 *	10.7 *	10.7 *	10.7 *	10.5 *
10.6 *	10.1 ↘	9.7 ←	10.8 *	10.4 *

beste Teiler: 47.6 (9.), 69.3 (3.), 74.3 (2.)  
 Trefferlage: 0.22 mm links, 0.34 mm tief  
 Streuwert: 1.07, horizontal: 1.36, vertikal: 0.67

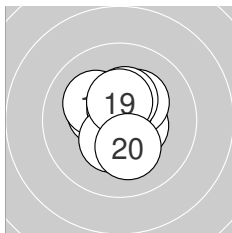

**Serie 2:**

10.4 *	10.6 *	10.2 *	10.5 *	10.3 *
10.6 *	10.4 *	10.4 *	10.5 *	10.2 *

beste Teiler: 76.0 (16.), 94.9 (12.), 114.7 (14.)  
 Trefferlage: 0.00 mm, 0.19 mm hoch  
 Streuwert: 1.06, horizontal: 0.92, vertikal: 1.19

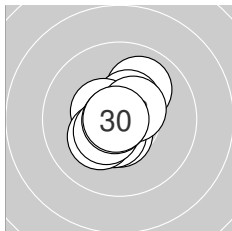

**Serie 3:**

10.5 *	10.0 ↗	10.5 *	10.5 *	10.5 *
10.2 *	10.5 *	10.5 *	10.8 *	10.9 *

beste Teiler: 25.0 (30.), 34.4 (29.), 102.0 (21.)  
 Trefferlage: 0.15 mm links, 0.01 mm hoch  
 Streuwert: 0.97, horizontal: 0.87, vertikal: 1.07

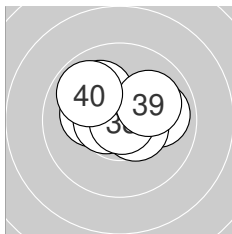

**Serie 4:**

10.6 *	10.3 *	9.9 →	10.2 *	10.5 *
10.6 *	10.1 ↘	10.9 *	10.0 ↗	9.9 ↘

beste Teiler: 18.7 (38.), 85.5 (31.), 91.0 (36.)  
 Trefferlage: 0.27 mm links, 0.54 mm hoch  
 Streuwert: 1.29, horizontal: 1.63, vertikal: 0.80



**Ergebnis:** **412.6** (394)  
**Serien:** 102.5 102.9 105.1 102.1  
**Zähler:** 34 6 0 0 0 0 0 0 0 0  
**Innenzehner:** 28  
**Weiteste:** 359 (15.), 315 (32.), 293 (9.)  
**beste Teiler:** 18.7 (22.), 20.6 (11.), 30.5 (30.)  
**Trefferlage:** 0.40 mm rechts, 0.08 mm tief  
**Streuwert:** 1.24, horizontal: 1.19, vertikal: 1.29

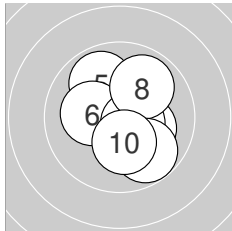
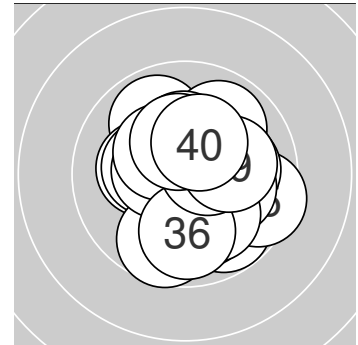

**Serie 1:**

10.8 *	10.3 *	10.6 *	10.2 *	9.9 ↘
10.2 *	10.6 *	9.9 ↗	9.8 ↘	10.2 *

**beste Teiler:** 45.4 (1.), 89.9 (3.), 100.7 (7.)  
**Trefferlage:** 0.31 mm rechts, 0.07 mm tief  
**Streuwert:** 1.42, horizontal: 1.27, vertikal: 1.56

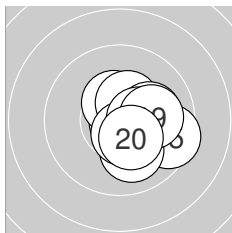

**Serie 2:**

10.9 *	10.4 *	10.4 *	10.1 →	9.5 ↘
10.1 ↘	10.6 *	10.4 *	10.1 →	10.4 *

**beste Teiler:** 20.6 (11.), 96.3 (17.), 128.7 (12.)  
**Trefferlage:** 1.11 mm rechts, 0.23 mm tief  
**Streuwert:** 1.12, horizontal: 1.15, vertikal: 1.08

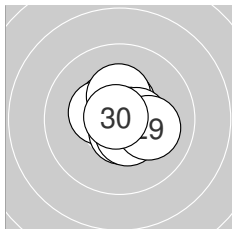

**Serie 3:**

10.5 *	10.9 *	10.5 *	10.4 *	10.3 *
10.5 *	10.6 *	10.5 *	10.1 →	10.8 *

**beste Teiler:** 18.7 (22.), 30.5 (30.), 90.5 (27.)  
**Trefferlage:** 0.17 mm rechts, 0.18 mm hoch  
**Streuwert:** 0.90, horizontal: 0.93, vertikal: 0.86

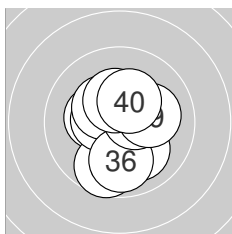

**Serie 4:**

10.3 *	9.7 ↓	10.1 ↘	10.5 *	10.4 *
9.9 ↓	10.5 *	10.3 *	10.1 →	10.3 *

**beste Teiler:** 111.0 (37.), 119.3 (34.), 150.6 (35.)  
**Trefferlage:** 0.00 mm, 0.22 mm tief  
**Streuwert:** 1.46, horizontal: 1.23, vertikal: 1.67



Ergebnis: **417.1** (400)  
 Serien: 103.1 105.0 103.6 105.4  
 Zähler: 40 0 0 0 0 0 0 0 0 0  
 Innenzehner: 34  
 Weitesten: 246 (6.), 243 (3.), 238 (25.)  
 beste Teiler: 36.0 (30.), 36.2 (38.), 53.3 (17.)  
 Trefferlage: 0.07 mm rechts, 0.27 mm tief  
 Streuwert: 1.02, horizontal: 0.91, vertikal: 1.12

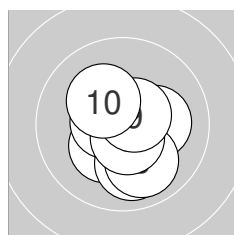
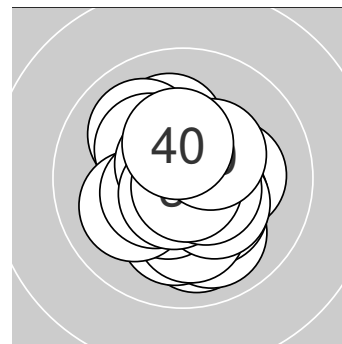

**Serie 1:**  
 10.2 \*                      10.3 \*                      10.0 ↓                      10.4 \*                      10.2 \*  
 10.0 ↓                      10.6 \*                      10.6 \*                      10.6 \*                      10.2 \*  
 beste Teiler: 86.0 (8.), 90.4 (9.), 95.1 (7.)  
 Trefferlage: 0.27 mm rechts, 0.71 mm tief  
 Streuwert: 1.14, horizontal: 1.02, vertikal: 1.25

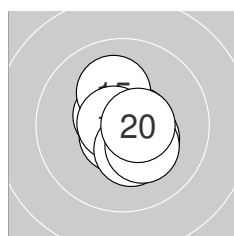

**Serie 2:**  
 10.6 \*                      10.6 \*                      10.4 \*                      10.7 \*                      10.1 ↑  
 10.7 \*                      10.7 \*                      10.3 \*                      10.3 \*                      10.6 \*  
 beste Teiler: 53.3 (17.), 67.4 (14.), 72.4 (16.)  
 Trefferlage: 0.21 mm rechts, 0.07 mm tief  
 Streuwert: 0.91, horizontal: 0.78, vertikal: 1.02

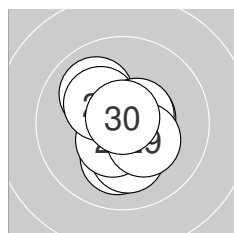

**Serie 3:**  
 10.4 \*                      10.1 ↓                      10.2 \*                      10.5 \*                      10.0 ↘  
 10.5 \*                      10.2 \*                      10.6 \*                      10.3 \*                      10.8 \*  
 beste Teiler: 36.0 (30.), 98.8 (28.), 101.5 (24.)  
 Trefferlage: 0.02 mm rechts, 0.32 mm tief  
 Streuwert: 1.16, horizontal: 0.98, vertikal: 1.32

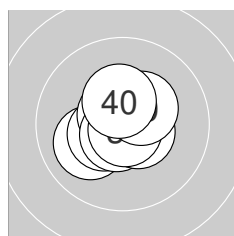

**Serie 4:**  
 10.1 ↙                      10.7 \*                      10.5 \*                      10.6 \*                      10.7 \*  
 10.7 \*                      10.5 \*                      10.8 \*                      10.4 \*                      10.4 \*  
 beste Teiler: 36.2 (38.), 71.7 (32.), 72.5 (36.)  
 Trefferlage: 0.23 mm links, 0.01 mm hoch  
 Streuwert: 0.88, horizontal: 0.90, vertikal: 0.86



Ergebnis: **416.8** (398)  
 Serien: 105.0 103.3 104.0 104.5  
 Zähler: 38 2 0 0 0 0 0 0 0 0  
 Innenzehner: 32  
 Weitesten: 302 (18.), 290 (7.), 244 (36.)  
 beste Teiler: 19.2 (28.), 26.9 (31.), 43.1 (3.)  
 Trefferlage: 0.08 mm rechts, 0.10 mm tief  
 Streuwert: 1.08, horizontal: 1.13, vertikal: 1.03

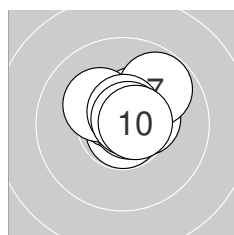
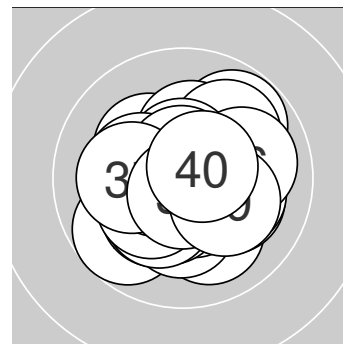

**Serie 1:**  
 10.4 \*                      10.4 \*                      10.8 \*                      10.6 \*                      10.8 \*  
 10.2 \*                      9.8 ↗                      10.6 \*                      10.8 \*                      10.6 \*  
 beste Teiler: 43.1 (3.), 43.3 (5.), 47.3 (9.)  
 Trefferlage: 0.36 mm rechts, 0.66 mm hoch  
 Streuwert: 0.83, horizontal: 0.93, vertikal: 0.72

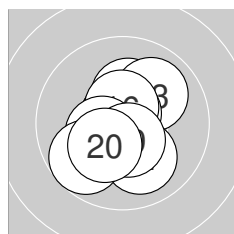

**Serie 2:**  
 10.3 \*                      10.8 \*                      10.0 ↗                      10.0 ↘                      10.7 \*  
 10.6 \*                      10.4 \*                      9.7 ↙                      10.5 \*                      10.3 \*  
 beste Teiler: 50.3 (12.), 60.8 (15.), 97.1 (16.)  
 Trefferlage: 0.13 mm links, 0.17 mm tief  
 Streuwert: 1.30, horizontal: 1.15, vertikal: 1.44

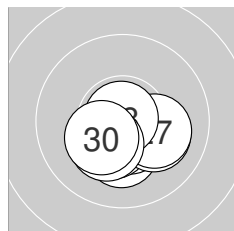

**Serie 3:**  
 10.6 \*                      10.2 \*                      10.5 \*                      10.6 \*                      10.4 \*  
 10.1 ↘                      10.1 ↘                      10.9 \*                      10.3 \*                      10.3 \*  
 beste Teiler: 19.2 (28.), 91.6 (24.), 92.7 (21.)  
 Trefferlage: 0.04 mm rechts, 0.92 mm tief  
 Streuwert: 0.85, horizontal: 1.09, vertikal: 0.52

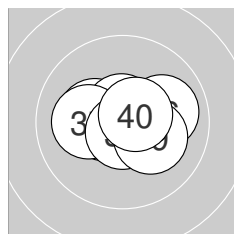

**Serie 4:**  
 10.8 \*                      10.5 \*                      10.6 \*                      10.3 \*                      10.7 \*  
 10.0 →                      10.1 ←                      10.7 \*                      10.2 \*                      10.6 \*  
 beste Teiler: 26.9 (31.), 61.0 (38.), 68.3 (35.)  
 Trefferlage: 0.05 mm rechts, 0.02 mm hoch  
 Streuwert: 1.07, horizontal: 1.41, vertikal: 0.52



Ergebnis: **417.5** (399)  
 Serien: 105.4 104.1 104.2 103.8  
 Zähler: 39 1 0 0 0 0 0 0 0 0  
 Innenzehner: 33  
 Weitester: 251 (25.), 250 (40.), 245 (31.)  
 beste Teiler: 4.1 (13.), 18.4 (12.), 29.1 (29.)  
 Trefferlage: 0.02 mm links, 0.04 mm hoch  
 Streuwert: 1.05, horizontal: 1.07, vertikal: 1.04

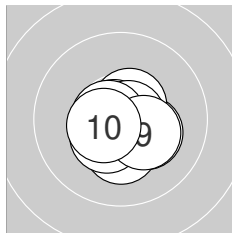
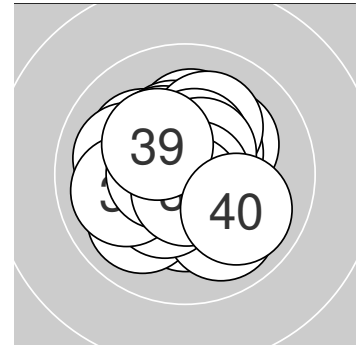

**Serie 1:**

10.3 *	10.7 *	10.6 *	10.3 *	10.8 *
10.8 *	10.7 *	10.4 *	10.3 *	10.5 *

beste Teiler: 41.7 (5.), 47.8 (6.), 72.4 (2.)  
 Trefferlage: 0.11 mm rechts, 0.42 mm tief  
 Streuwert: 0.81, horizontal: 0.89, vertikal: 0.72

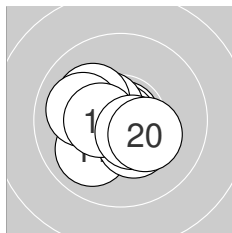

**Serie 2:**

10.0 ↙	10.9 *	10.9 *	10.5 *	10.4 *
10.1 ↘	10.0 ←	10.5 *	10.5 *	10.3 *

beste Teiler: 4.1 (13.), 18.4 (12.), 101.1 (19.)  
 Trefferlage: 0.45 mm links, 0.19 mm tief  
 Streuwert: 1.11, horizontal: 1.26, vertikal: 0.93

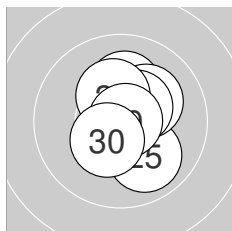

**Serie 3:**

10.7 *	10.2 *	10.4 *	10.8 *	9.9 ↘
10.2 *	10.5 *	10.3 *	10.8 *	10.4 *

beste Teiler: 29.1 (29.), 37.1 (24.), 52.7 (21.)  
 Trefferlage: 0.31 mm rechts, 0.41 mm hoch  
 Streuwert: 1.05, horizontal: 0.78, vertikal: 1.26

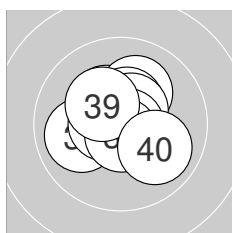

**Serie 4:**

10.0 ←	10.3 *	10.1 ↗	10.5 *	10.6 *
10.5 *	10.8 *	10.7 *	10.3 *	10.0 ↘

beste Teiler: 39.0 (37.), 65.3 (38.), 93.0 (35.)  
 Trefferlage: 0.08 mm links, 0.36 mm hoch  
 Streuwert: 1.17, horizontal: 1.25, vertikal: 1.08



**Ergebnis:** 417.6 (398)  
**Serien:** 103.8 103.8 104.3 105.7  
**Zähler:** 38 2 0 0 0 0 0 0 0 0  
**Innenzehner:** 35  
**Weiteste:** 327 (11.), 290 (1.), 238 (7.)  
**beste Teiler:** 6.7 (26.), 56.0 (19.), 59.4 (14.)  
**Trefferlage:** 0.18 mm rechts, 0.02 mm hoch  
**Streuwert:** 1.02, horizontal: 1.16, vertikal: 0.87

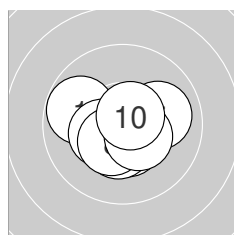
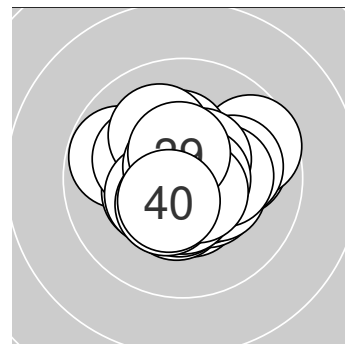

**Serie 1:**  
 9.8 ←                      10.5 \*                      10.5 \*                      10.7 \*                      10.4 \*  
 10.4 \*                      10.0 →                      10.4 \*                      10.4 \*                      10.7 \*  
**beste Teiler:** 68.0 (4.), 75.7 (10.), 115.2 (3.)  
**Trefferlage:** 0.05 mm rechts, 0.41 mm tief  
**Streuwert:** 1.15, horizontal: 1.41, vertikal: 0.81

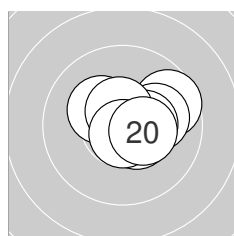

**Serie 2:**  
 9.6 →                      10.5 \*                      10.5 \*                      10.7 \*                      10.1 →  
 10.4 \*                      10.3 \*                      10.6 \*                      10.7 \*                      10.4 \*  
**beste Teiler:** 56.0 (19.), 59.4 (14.), 95.5 (18.)  
**Trefferlage:** 0.80 mm rechts, 0.25 mm hoch  
**Streuwert:** 1.04, horizontal: 1.27, vertikal: 0.73

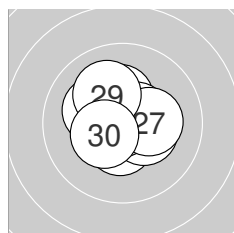

**Serie 3:**  
 10.6 \*                      10.3 \*                      10.5 \*                      10.6 \*                      10.4 \*  
 10.9 \*                      10.3 \*                      10.2 \*                      10.1 ↖                      10.4 \*  
**beste Teiler:** 6.7 (26.), 95.1 (21.), 98.4 (24.)  
**Trefferlage:** 0.13 mm links, 0.25 mm hoch  
**Streuwert:** 1.07, horizontal: 1.15, vertikal: 0.98

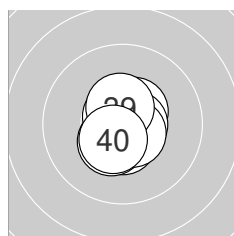

**Serie 4:**  
 10.5 \*                      10.6 \*                      10.5 \*                      10.7 \*                      10.7 \*  
 10.4 \*                      10.7 \*                      10.6 \*                      10.5 \*                      10.5 \*  
**beste Teiler:** 59.4 (35.), 64.2 (37.), 72.0 (34.)  
**Trefferlage:** 0.01 mm rechts, 0.01 mm tief  
**Streuwert:** 0.73, horizontal: 0.55, vertikal: 0.87





Ergebnis: **404.9** (386)  
 Serien: 99.1 103.2 102.5 100.1  
 Zähler: 26 14 0 0 0 0 0 0 0 0  
 Innenzehner: 20  
 Weitester: 383 (40.), 362 (33.), 358 (20.)  
 beste Teiler: 32.2 (17.), 63.8 (32.), 67.6 (30.)  
 Trefferlage: 0.43 mm links, 0.11 mm hoch  
 Streuwert: 1.62, horizontal: 1.68, vertikal: 1.55

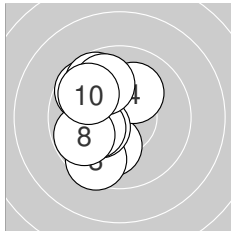
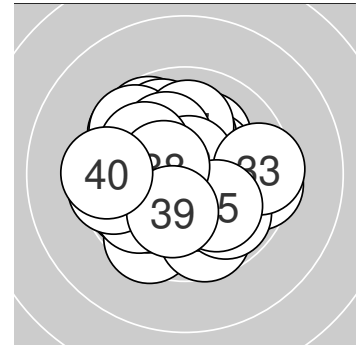

**Serie 1:**

10.1 ↓	9.7 ↘	9.5 ↙	10.1 ↗	10.3 *
9.7 ↘	10.2 *	9.8 ↙	9.9 ↘	9.8 ↘

beste Teiler: 164.1 (5.), 196.0 (7.), 205.5 (4.)  
 Trefferlage: 1.48 mm links, 0.23 mm hoch  
 Streuwert: 1.65, horizontal: 1.07, vertikal: 2.07

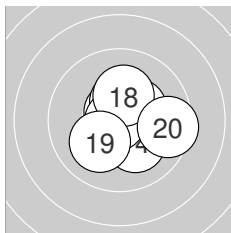

**Serie 2:**

10.4 *	10.7 *	10.4 *	10.2 *	10.5 *
10.4 *	10.8 *	10.2 *	10.1 ↙	9.5 →

beste Teiler: 32.2 (17.), 70.4 (12.), 109.6 (15.)  
 Trefferlage: 0.49 mm rechts, 0.31 mm hoch  
 Streuwert: 1.27, horizontal: 1.32, vertikal: 1.21

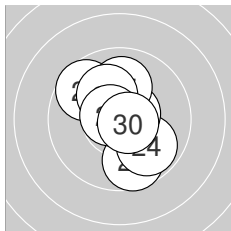

**Serie 3:**

10.6 *	9.7 ↓	10.4 *	9.9 ↘	10.6 *
9.7 ↘	10.0 ↑	10.2 *	10.7 *	10.7 *

beste Teiler: 67.6 (30.), 73.5 (29.), 77.7 (21.)  
 Trefferlage: 0.05 mm rechts, 0.35 mm hoch  
 Streuwert: 1.50, horizontal: 1.23, vertikal: 1.73

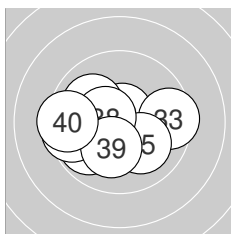

**Serie 4:**

9.8 ↙	10.7 *	9.5 →	10.4 *	10.1 ↘
10.0 ↘	9.5 ←	10.5 *	10.2 *	9.4 ←

beste Teiler: 63.8 (32.), 110.3 (38.), 143.2 (34.)  
 Trefferlage: 0.79 mm links, 0.45 mm tief  
 Streuwert: 1.79, horizontal: 2.27, vertikal: 1.11



Ergebnis: **417.5** (397)  
 Serien: 104.4 104.9 103.5 104.7  
 Zähler: 37 3 0 0 0 0 0 0 0 0  
 Innenzehner: 35  
 Weitestе: 282 (30.), 277 (1.), 252 (24.)  
 beste Teiler: 6.4 (22.), 39.0 (8.), 54.2 (39.)  
 Trefferlage: 0.10 mm links, 0.21 mm hoch  
 Streuwert: 1.01, horizontal: 1.02, vertikal: 1.01

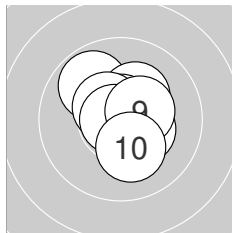
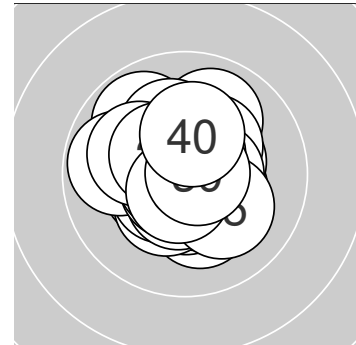

**Serie 1:**

9.8 ↘	10.7 *	10.3 *	10.6 *	10.7 *
10.5 *	10.4 *	10.8 *	10.4 *	10.2 *

beste Teiler: 39.0 (8.), 65.0 (5.), 74.7 (2.)  
 Trefferlage: 0.15 mm rechts, 0.41 mm hoch  
 Streuwert: 1.04, horizontal: 0.99, vertikal: 1.08

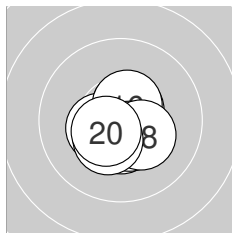

**Serie 2:**

10.6 *	10.6 *	10.5 *	10.4 *	10.6 *
10.5 *	10.5 *	10.3 *	10.4 *	10.5 *

beste Teiler: 86.0 (15.), 88.5 (11.), 98.0 (12.)  
 Trefferlage: 0.05 mm rechts, 0.39 mm tief  
 Streuwert: 0.85, horizontal: 0.81, vertikal: 0.89

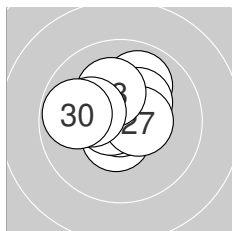

**Serie 3:**

10.5 *	10.9 *	10.5 *	9.9 ↗	10.3 *
10.7 *	10.5 *	10.2 *	10.2 *	9.8 ←

beste Teiler: 6.4 (22.), 62.2 (26.), 102.0 (23.)  
 Trefferlage: 0.37 mm links, 0.59 mm hoch  
 Streuwert: 1.14, horizontal: 1.30, vertikal: 0.96

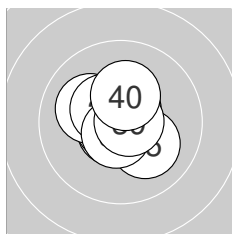

**Serie 4:**

10.7 *	10.7 *	10.1 ↖	10.6 *	10.1 ↘
10.5 *	10.4 *	10.6 *	10.7 *	10.3 *

beste Teiler: 54.2 (39.), 69.3 (32.), 75.6 (31.)  
 Trefferlage: 0.23 mm links, 0.23 mm hoch  
 Streuwert: 0.96, horizontal: 0.98, vertikal: 0.94



Ergebnis: **425.0** (400)  
 Serien: 107.1 105.7 106.3 105.9  
 Zähler: 40 0 0 0 0 0 0 0 0 0  
 Innenzehner: 39  
 Weitest: 216 (13.), 150 (27.), 141 (35.)  
 beste Teiler: 4.1 (24.), 35.5 (9.), 38.0 (23.)  
 Trefferlage: 0.03 mm links, 0.16 mm hoch  
 Streuwert: 0.65, horizontal: 0.59, vertikal: 0.70

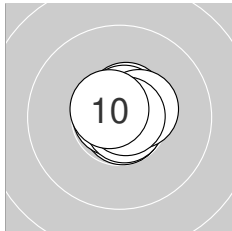
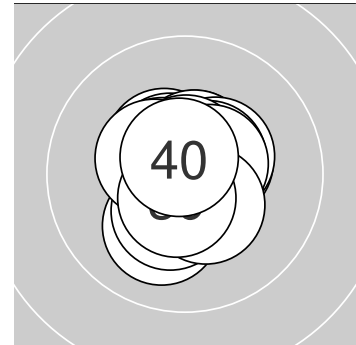

**Serie 1:**

10.6 *	10.8 *	10.7 *	10.8 *	10.8 *
10.6 *	10.8 *	10.5 *	10.8 *	10.7 *

beste Teiler: 35.5 (9.), 42.2 (5.), 44.2 (7.)  
 Trefferlage: 0.14 mm rechts, 0.28 mm hoch  
 Streuwert: 0.47, horizontal: 0.49, vertikal: 0.45

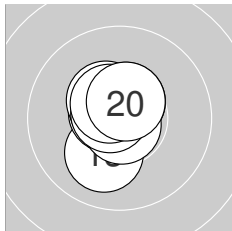

**Serie 2:**

10.7 *	10.6 *	10.1 ✓	10.7 *	10.6 *
10.4 *	10.8 *	10.7 *	10.6 *	10.5 *

beste Teiler: 38.8 (17.), 60.8 (18.), 67.0 (11.)  
 Trefferlage: 0.37 mm links, 0.29 mm hoch  
 Streuwert: 0.72, horizontal: 0.47, vertikal: 0.90

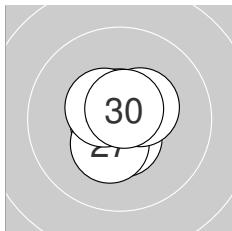

**Serie 3:**

10.7 *	10.7 *	10.8 *	10.9 *	10.7 *
10.5 *	10.4 *	10.4 *	10.5 *	10.7 *

beste Teiler: 4.1 (24.), 38.0 (23.), 62.1 (22.)  
 Trefferlage: 0.04 mm rechts, 0.02 mm hoch  
 Streuwert: 0.67, horizontal: 0.59, vertikal: 0.74

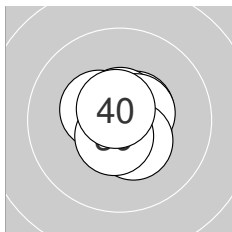

**Serie 4:**

10.6 *	10.5 *	10.6 *	10.6 *	10.4 *
10.7 *	10.8 *	10.4 *	10.6 *	10.7 *

beste Teiler: 49.0 (37.), 64.3 (36.), 67.6 (40.)  
 Trefferlage: 0.06 mm rechts, 0.07 mm hoch  
 Streuwert: 0.72, horizontal: 0.72, vertikal: 0.71



**Ergebnis:** **416.4** (399)  
**Serien:** 103.3 105.4 103.0 104.7  
**Zähler:** 39 1 0 0 0 0 0 0 0  
**Innenzehner:** 36  
**Weiteste:** 305 (3.), 222 (28.), 220 (1.)  
**beste Teiler:** 40.5 (22.), 47.4 (15.), 67.9 (17.)  
**Trefferlage:** 0.50 mm links, 0.23 mm hoch  
**Streuwert:** 0.98, horizontal: 0.98, vertikal: 0.98

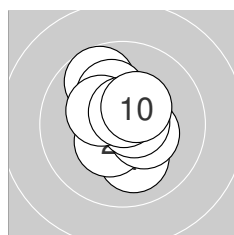
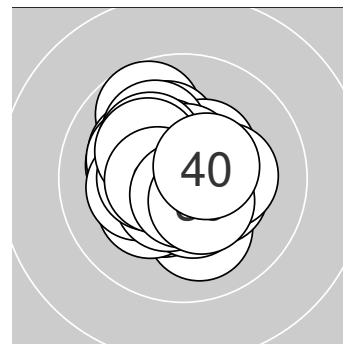

**Serie 1:**  
 10.1 ↓                      10.4 \*                      9.7 ↗  
 10.4 \*                      10.7 \*                      10.3 \*                      10.5 \*                      10.2 \*  
 10.4 \*                      10.7 \*                      10.3 \*                      10.6 \*                      10.4 \*  
**beste Teiler:** 74.9 (7.), 77.4 (9.), 116.7 (4.)  
**Trefferlage:** 0.10 mm links, 0.46 mm hoch  
**Streuwert:** 1.22, horizontal: 0.99, vertikal: 1.42

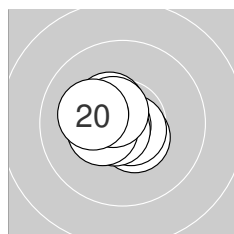

**Serie 2:**  
 10.5 \*                      10.5 \*                      10.6 \*                      10.7 \*                      10.8 \*  
 10.4 \*                      10.7 \*                      10.4 \*                      10.6 \*                      10.2 \*  
**beste Teiler:** 47.4 (15.), 67.9 (17.), 68.8 (14.)  
**Trefferlage:** 0.62 mm links, 0.03 mm hoch  
**Streuwert:** 0.71, horizontal: 0.79, vertikal: 0.61

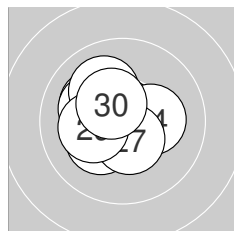

**Serie 3:**  
 10.2 \*                      10.8 \*                      10.1 ↖  
 10.2 \*                      10.5 \*                      10.1 ↗                      10.2 \*                      10.3 \*  
 10.2 \*                      10.5 \*                      10.1 ↗                      10.2 \*                      10.4 \*  
**beste Teiler:** 40.5 (22.), 120.9 (27.), 131.7 (30.)  
**Trefferlage:** 0.79 mm links, 0.31 mm hoch  
**Streuwert:** 1.10, horizontal: 1.21, vertikal: 0.98

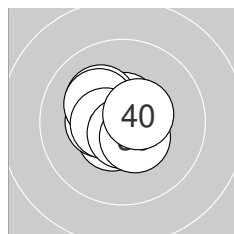

**Serie 4:**  
 10.6 \*                      10.6 \*                      10.5 \*                      10.4 \*                      10.2 \*  
 10.2 \*                      10.5 \*                      10.7 \*                      10.5 \*                      10.5 \*  
**beste Teiler:** 70.0 (38.), 79.1 (32.), 90.4 (31.)  
**Trefferlage:** 0.49 mm links, 0.13 mm hoch  
**Streuwert:** 0.87, horizontal: 0.91, vertikal: 0.83



Ergebnis: **416.7** (398)  
 Serien: 104.8 103.9 104.3 103.7  
 Zähler: 38 2 0 0 0 0 0 0 0 0  
 Innenzehner: 35  
 Weitester: 283 (38.), 255 (11.), 249 (30.)  
 beste Teiler: 24.0 (10.), 55.0 (35.), 56.0 (14.)  
 Trefferlage: 0.22 mm links, 0.00 mm  
 Streuwert: 1.04, horizontal: 1.09, vertikal: 0.99

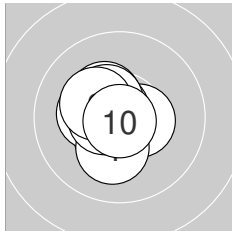
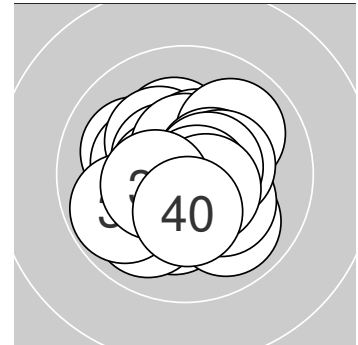

**Serie 1:**

10.5 *	10.4 *	10.3 *	10.2 *	10.4 *
10.7 *	10.5 *	10.6 *	10.3 *	10.9 *

beste Teiler: 24.0 (10.), 59.3 (6.), 93.1 (8.)  
 Trefferlage: 0.59 mm links, 0.00 mm  
 Streuwert: 0.88, horizontal: 0.79, vertikal: 0.96

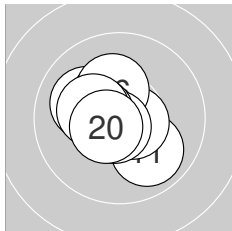

**Serie 2:**

9.9 ↘	10.1 ↖	10.6 *	10.7 *	10.4 *
10.2 *	10.7 *	10.4 *	10.3 *	10.6 *

beste Teiler: 56.0 (14.), 60.5 (17.), 83.4 (13.)  
 Trefferlage: 0.53 mm links, 0.10 mm hoch  
 Streuwert: 1.07, horizontal: 1.10, vertikal: 1.04

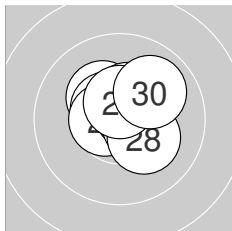

**Serie 3:**

10.7 *	10.3 *	10.5 *	10.6 *	10.6 *
10.4 *	10.5 *	10.2 *	10.5 *	10.0 ↗

beste Teiler: 59.4 (21.), 80.1 (25.), 88.0 (24.)  
 Trefferlage: 0.25 mm rechts, 0.52 mm hoch  
 Streuwert: 0.95, horizontal: 1.04, vertikal: 0.85

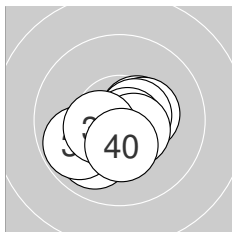

**Serie 4:**

10.5 *	10.4 *	10.6 *	10.5 *	10.7 *
10.5 *	10.0 ↙	9.8 ↙	10.4 *	10.3 *

beste Teiler: 55.0 (35.), 99.3 (33.), 104.8 (36.)  
 Trefferlage: 0.02 mm links, 0.61 mm tief  
 Streuwert: 1.10, horizontal: 1.29, vertikal: 0.86



Ergebnis: **418.7** (398)  
 Serien: 104.0 104.9 105.5 104.3  
 Zähler: 38 2 0 0 0 0 0 0 0 0  
 Innenzehner: 36  
 Weitestе: 298 (3.), 252 (33.), 242 (23.)  
 beste Teiler: 2.0 (26.), 9.2 (14.), 16.1 (29.)  
 Trefferlage: 0.06 mm rechts, 0.09 mm hoch  
 Streuwert: 1.00, horizontal: 0.85, vertikal: 1.13

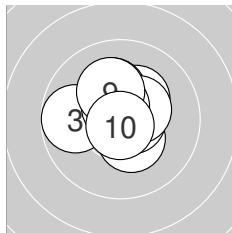
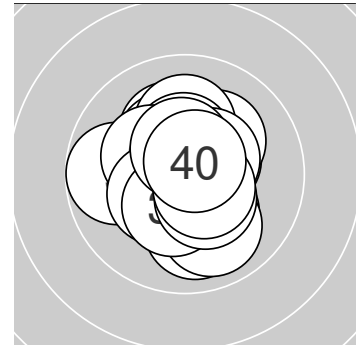

**Serie 1:**

10.4 *	10.6 *	9.8 ←	10.7 *	10.3 *
10.2 *	10.4 *	10.6 *	10.2 *	10.8 *

beste Teiler: 41.1 (10.), 73.1 (4.), 89.6 (8.)  
 Trefferlage: 0.16 mm links, 0.54 mm hoch  
 Streuwert: 1.10, horizontal: 1.21, vertikal: 0.98

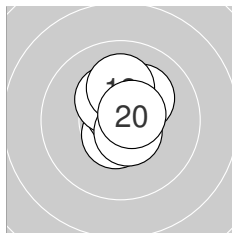

**Serie 2:**

10.4 *	10.4 *	10.2 *	10.9 *	10.6 *
10.8 *	10.3 *	10.1 ↑	10.6 *	10.6 *

beste Teiler: 9.2 (14.), 50.0 (16.), 83.1 (20.)  
 Trefferlage: 0.13 mm rechts, 0.68 mm hoch  
 Streuwert: 0.86, horizontal: 0.65, vertikal: 1.02

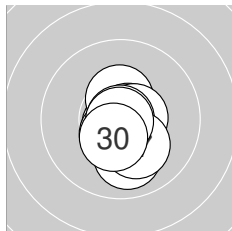

**Serie 3:**

10.8 *	10.4 *	10.0 ↓	10.8 *	10.6 *
10.9 *	10.2 *	10.5 *	10.9 *	10.4 *

beste Teiler: 2.0 (26.), 16.1 (29.), 49.0 (21.)  
 Trefferlage: 0.14 mm rechts, 0.51 mm tief  
 Streuwert: 0.84, horizontal: 0.54, vertikal: 1.06

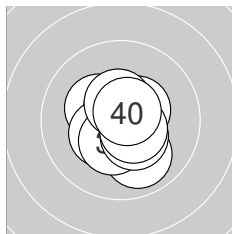

**Serie 4:**

10.7 *	10.5 *	9.9 ↘	10.3 *	10.4 *
10.4 *	10.4 *	10.5 *	10.5 *	10.7 *

beste Teiler: 52.3 (31.), 71.4 (40.), 102.6 (39.)  
 Trefferlage: 0.14 mm rechts, 0.33 mm tief  
 Streuwert: 1.02, horizontal: 0.93, vertikal: 1.10



Ergebnis: **415.4** (397)  
 Serien: 104.0 103.0 103.9 104.5  
 Zähler: 37 3 0 0 0 0 0 0 0 0  
 Innenzehner: 32  
 Weitestе: 273 (21.), 262 (4.), 260 (2.)  
 beste Teiler: 7.6 (39.), 37.0 (9.), 45.1 (32.)  
 Trefferlage: 0.21 mm links, 0.30 mm tief  
 Streuwert: 1.08, horizontal: 1.14, vertikal: 1.02

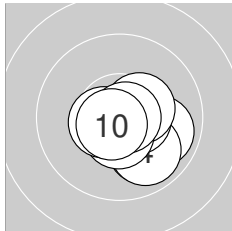
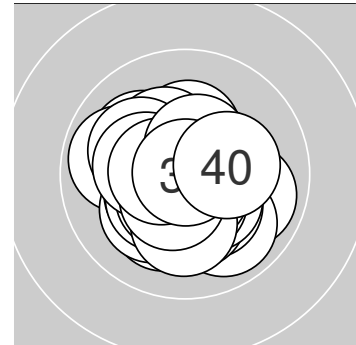

**Serie 1:**

10.8 *	9.9 ↗	10.0 ↘	9.9 ↘	10.5 *
10.4 *	10.5 *	10.5 *	10.8 *	10.7 *

beste Teiler: 37.0 (9.), 48.0 (1.), 67.2 (10.)  
 Trefferlage: 0.65 mm rechts, 0.67 mm tief  
 Streuwert: 0.96, horizontal: 1.08, vertikal: 0.83

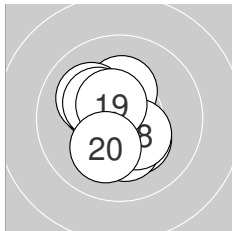

**Serie 2:**

10.3 *	10.3 *	10.3 *	10.2 *	10.1 ↘
10.3 *	10.5 *	10.4 *	10.5 *	10.1 ↙

beste Teiler: 101.3 (19.), 108.6 (17.), 144.2 (18.)  
 Trefferlage: 0.30 mm links, 0.11 mm tief  
 Streuwert: 1.21, horizontal: 1.03, vertikal: 1.37

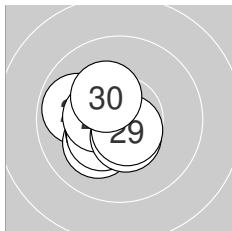

**Serie 3:**

9.9 ↖	10.7 *	10.2 *	10.4 *	10.5 *
10.4 *	10.4 *	10.5 *	10.6 *	10.3 *

beste Teiler: 54.7 (22.), 83.4 (29.), 115.7 (28.)  
 Trefferlage: 0.89 mm links, 0.33 mm tief  
 Streuwert: 0.91, horizontal: 0.93, vertikal: 0.89

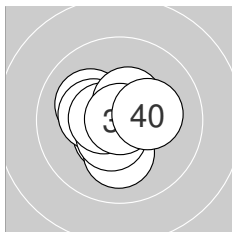

**Serie 4:**

10.1 ↖	10.8 *	10.5 *	10.3 *	10.1 ↓
10.5 *	10.6 *	10.5 *	10.9 *	10.2 *

beste Teiler: 7.6 (39.), 45.1 (32.), 99.7 (37.)  
 Trefferlage: 0.29 mm links, 0.09 mm tief  
 Streuwert: 1.03, horizontal: 1.08, vertikal: 0.97



Ergebnis: **415.4** (398)  
 Serien: 104.2 101.3 104.7 105.2  
 Zähler: 38 2 0 0 0 0 0 0 0  
 Innenzehner: 34  
 Weitester: 363 (19.), 356 (20.), 229 (18.)  
 beste Teiler: 18.0 (39.), 47.4 (13.), 56.3 (9.)  
 Trefferlage: 0.43 mm links, 0.05 mm tief  
 Streuwert: 1.10, horizontal: 1.26, vertikal: 0.91

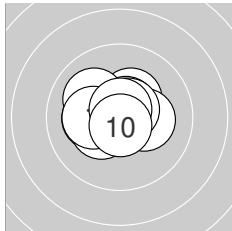
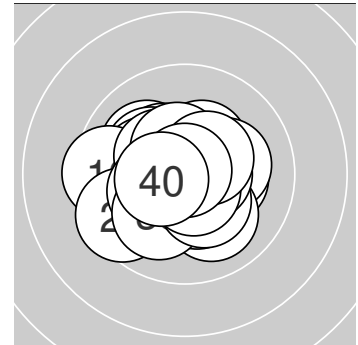

**Serie 1:**

10.4 *	10.6 *	10.2 *	10.3 *	10.1 ↘
10.4 *	10.2 *	10.6 *	10.7 *	10.7 *

beste Teiler: 56.3 (9.), 58.3 (10.), 80.9 (2.)  
 Trefferlage: 0.31 mm links, 0.27 mm hoch  
 Streuwert: 1.05, horizontal: 1.31, vertikal: 0.71

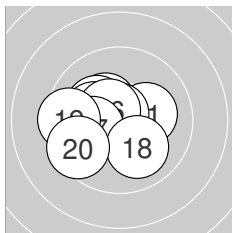

**Serie 2:**

10.2 *	10.3 *	10.8 *	10.2 *	10.2 *
10.5 *	10.1 ←	10.0 ↘	9.5 ←	9.5 ↙

beste Teiler: 47.4 (13.), 103.2 (16.), 152.3 (12.)  
 Trefferlage: 1.07 mm links, 0.01 mm tief  
 Streuwert: 1.46, horizontal: 1.73, vertikal: 1.11

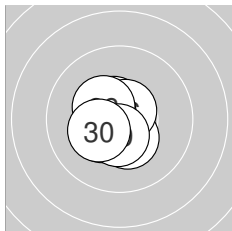

**Serie 3:**

10.5 *	10.4 *	10.3 *	10.6 *	10.5 *
10.7 *	10.5 *	10.4 *	10.5 *	10.3 *

beste Teiler: 72.6 (26.), 92.1 (24.), 102.7 (25.)  
 Trefferlage: 0.54 mm links, 0.19 mm tief  
 Streuwert: 0.83, horizontal: 0.72, vertikal: 0.93

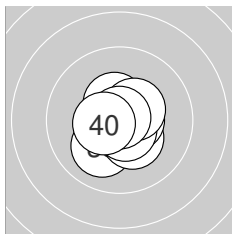

**Serie 4:**

10.5 *	10.6 *	10.1 ↙	10.3 *	10.7 *
10.6 *	10.6 *	10.4 *	10.9 *	10.5 *

beste Teiler: 18.0 (39.), 63.5 (35.), 81.6 (37.)  
 Trefferlage: 0.18 mm rechts, 0.27 mm tief  
 Streuwert: 0.87, horizontal: 0.84, vertikal: 0.90

