

Ergebnis: **415.3** (395)
 Serien: 103.2 104.2 103.4 104.5
 Zähler: 35 5 0 0 0 0 0 0 0
 Innenzehner: 34
 Weitestе: 465 (31.), 344 (29.), 285 (4.)
 beste Teiler: 15.8 (35.), 47.8 (33.), 55.1 (17.)
 Trefferlage: 0.37 mm rechts, 0.04 mm tief
 Streuwert: 1.16, horizontal: 1.38, vertikal: 0.89

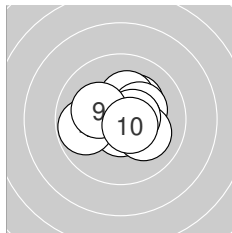

Serie 1:
 10.2 * 10.6 * 10.3 * 9.8 ← 10.3 *
 10.5 * 10.1 ↘ 10.6 * 10.2 * 10.6 *
 beste Teiler: 76.0 (2.), 89.5 (10.), 97.1 (8.)
 Trefferlage: 0.32 mm rechts, 0.17 mm hoch
 Streuwert: 1.23, horizontal: 1.48, vertikal: 0.93

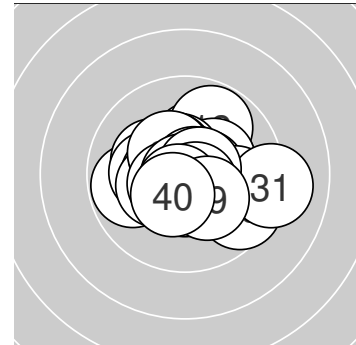
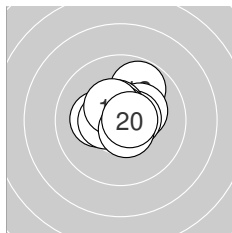

Serie 2:
 10.2 * 9.8 ↗ 10.3 * 10.5 * 10.5 *
 10.5 * 10.7 * 10.4 * 10.6 * 10.7 *
 beste Teiler: 55.1 (17.), 73.1 (20.), 87.9 (19.)
 Trefferlage: 0.10 mm rechts, 0.53 mm hoch
 Streuwert: 1.01, horizontal: 1.12, vertikal: 0.88

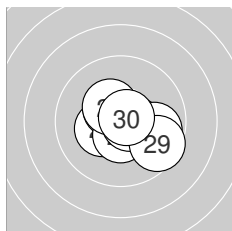

Serie 3:
 10.3 * 10.5 * 10.4 * 10.5 * 10.5 *
 10.7 * 10.4 * 9.8 → 9.6 ↘ 10.7 *
 beste Teiler: 55.2 (30.), 73.9 (26.), 110.0 (25.)
 Trefferlage: 0.60 mm rechts, 0.28 mm tief
 Streuwert: 1.21, horizontal: 1.45, vertikal: 0.89

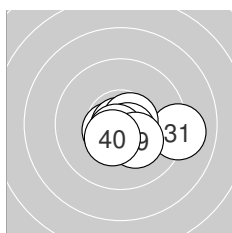

Serie 4:
 9.1 → 10.5 * 10.8 * 10.6 * 10.9 *
 10.6 * 10.6 * 10.7 * 10.3 * 10.4 *
 beste Teiler: 15.8 (35.), 47.8 (33.), 72.9 (38.)
 Trefferlage: 0.46 mm rechts, 0.59 mm tief
 Streuwert: 1.17, horizontal: 1.60, vertikal: 0.46



Ergebnis: **420.8** (400)
Serien: 106.0 105.6 105.2 104.0
Zähler: 40 0 0 0 0 0 0 0 0 0
Innenzehner: 40
Weiteste: 198 (22.), 198 (37.), 190 (35.)
beste Teiler: 35.0 (8.), 36.2 (9.), 44.3 (28.)
Trefferlage: 0.00 mm , 0.13 mm tief
Streuwert: 0.85, horizontal: 1.00, vertikal: 0.67

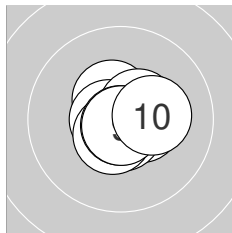
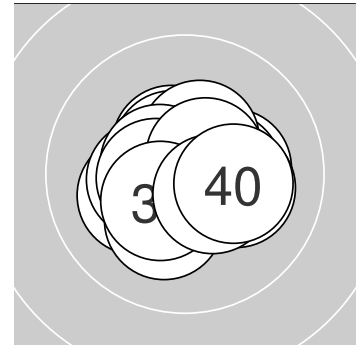

Serie 1:
 10.7 * 10.5 * 10.5 * 10.7 * 10.7 *
 10.5 * 10.6 * 10.8 * 10.8 * 10.2 *
beste Teiler: 35.0 (8.), 36.2 (9.), 66.0 (5.)
Trefferlage: 0.19 mm rechts, 0.00 mm
Streuwert: 0.73, horizontal: 0.83, vertikal: 0.61

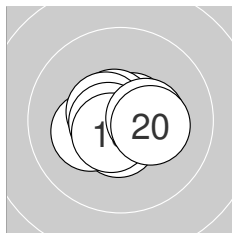

Serie 2:
 10.6 * 10.7 * 10.8 * 10.2 * 10.7 *
 10.6 * 10.7 * 10.6 * 10.4 * 10.3 *
beste Teiler: 50.9 (13.), 69.8 (17.), 73.4 (15.)
Trefferlage: 0.00 mm , 0.11 mm tief
Streuwert: 0.84, horizontal: 1.05, vertikal: 0.55

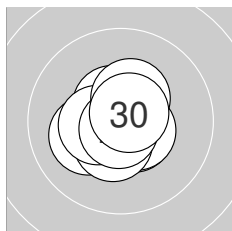

Serie 3:
 10.6 * 10.2 * 10.5 * 10.6 * 10.5 *
 10.5 * 10.4 * 10.8 * 10.4 * 10.7 *
beste Teiler: 44.3 (28.), 67.8 (30.), 81.0 (24.)
Trefferlage: 0.14 mm links, 0.03 mm tief
Streuwert: 0.86, horizontal: 0.89, vertikal: 0.84

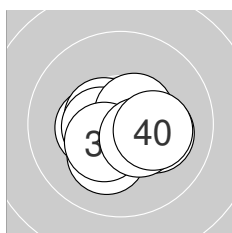

Serie 4:
 10.4 * 10.6 * 10.5 * 10.5 * 10.2 *
 10.6 * 10.2 * 10.4 * 10.4 * 10.2 *
beste Teiler: 82.8 (32.), 99.4 (36.), 102.3 (33.)
Trefferlage: 0.04 mm links, 0.39 mm tief
Streuwert: 1.03, horizontal: 1.29, vertikal: 0.67



Ergebnis: **423.0** (399)
 Serien: 106.1 105.9 105.2 105.8
 Zähler: 39 1 0 0 0 0 0 0 0
 Innenzehner: 38
 Weitestе: 289 (30.), 227 (7.), 190 (35.)
 beste Teiler: 21.5 (26.), 22.8 (20.), 24.5 (33.)
 Trefferlage: 0.08 mm rechts, 0.45 mm tief
 Streuwert: 0.72, horizontal: 0.73, vertikal: 0.71

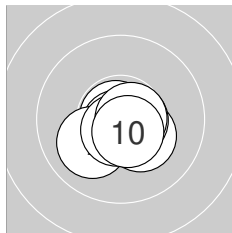
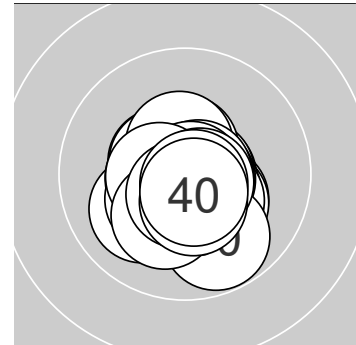

Serie 1:

10.8 *	10.7 *	10.3 *	10.8 *	10.7 *
10.8 *	10.0 ↙	10.7 *	10.7 *	10.6 *

beste Teiler: 35.3 (1.), 46.9 (6.), 47.2 (4.)
 Trefferlage: 0.11 mm rechts, 0.50 mm tief
 Streuwert: 0.68, horizontal: 0.83, vertikal: 0.50

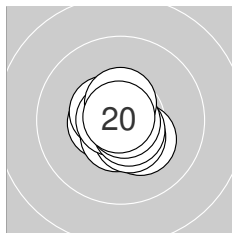

Serie 2:

10.5 *	10.3 *	10.5 *	10.6 *	10.5 *
10.7 *	10.6 *	10.8 *	10.5 *	10.9 *

beste Teiler: 22.8 (20.), 27.2 (18.), 55.0 (16.)
 Trefferlage: 0.04 mm links, 0.23 mm tief
 Streuwert: 0.72, horizontal: 0.72, vertikal: 0.73

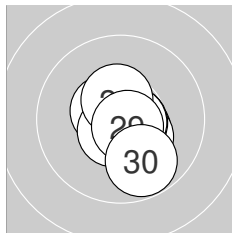

Serie 3:

10.5 *	10.3 *	10.5 *	10.7 *	10.7 *
10.9 *	10.6 *	10.5 *	10.7 *	9.8 ↘

beste Teiler: 21.5 (26.), 62.2 (29.), 67.0 (25.)
 Trefferlage: 0.33 mm rechts, 0.44 mm tief
 Streuwert: 0.87, horizontal: 0.72, vertikal: 1.00

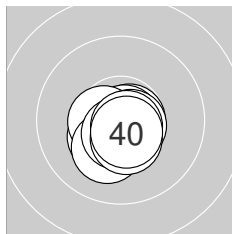

Serie 4:

10.7 *	10.4 *	10.9 *	10.5 *	10.2 *
10.7 *	10.6 *	10.7 *	10.5 *	10.6 *

beste Teiler: 24.5 (33.), 54.4 (38.), 55.0 (31.)
 Trefferlage: 0.06 mm links, 0.63 mm tief
 Streuwert: 0.62, horizontal: 0.68, vertikal: 0.56



Ergebnis: **415.0** (394)
 Serien: 105.3 103.8 102.9 103.0
 Zähler: 34 6 0 0 0 0 0 0 0 0
 Innenzehner: 32
 Weitesten: 343 (27.), 338 (31.), 308 (12.)
 beste Teiler: 19.8 (37.), 41.5 (8.), 50.1 (10.)
 Trefferlage: 0.11 mm links, 0.17 mm tief
 Streuwert: 1.18, horizontal: 1.26, vertikal: 1.09

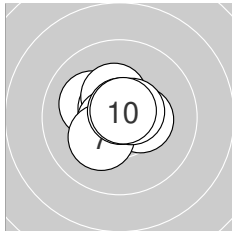
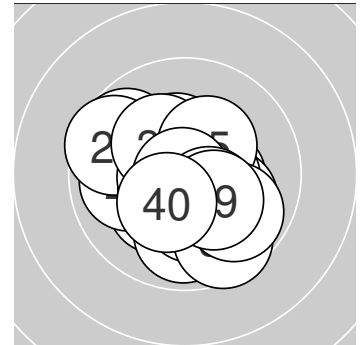

Serie 1:

10.7 *	10.1 ↘	10.6 *	10.4 *	10.7 *
10.4 *	10.2 *	10.8 *	10.6 *	10.8 *

beste Teiler: 41.5 (8.), 50.1 (10.), 60.2 (1.)
 Trefferlage: 0.16 mm links, 0.24 mm hoch
 Streuwert: 0.87, horizontal: 0.98, vertikal: 0.75

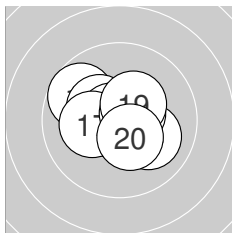

Serie 2:

10.6 *	9.7 ↘	10.3 *	10.1 ↘	10.7 *
10.8 *	10.2 *	10.6 *	10.4 *	10.4 *

beste Teiler: 50.1 (16.), 57.3 (15.), 78.5 (11.)
 Trefferlage: 0.24 mm links, 0.18 mm hoch
 Streuwert: 1.19, horizontal: 1.41, vertikal: 0.92

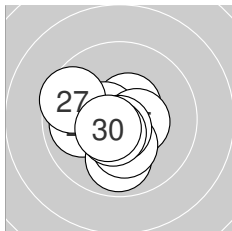

Serie 3:

9.9 ←	10.5 *	9.9 ↓	10.5 *	10.5 *
10.2 *	9.6 ↖	10.7 *	10.5 *	10.6 *

beste Teiler: 64.4 (28.), 99.6 (30.), 102.8 (29.)
 Trefferlage: 0.60 mm links, 0.46 mm tief
 Streuwert: 1.26, horizontal: 1.35, vertikal: 1.17

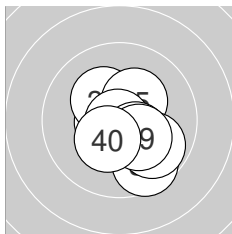

Serie 4:

9.6 ↘	10.6 *	10.5 *	10.3 *	10.3 *
9.8 ↘	10.9 *	10.4 *	10.3 *	10.3 *

beste Teiler: 19.8 (37.), 83.1 (32.), 113.8 (33.)
 Trefferlage: 0.53 mm rechts, 0.64 mm tief
 Streuwert: 1.24, horizontal: 1.16, vertikal: 1.30



LG 40 ZR – Wertung –

Männer

StartNr: 131

StandNr: 110

27. April 2022 18:13

Felderer,, Raimund #70818230

SG_Breitenbach

Ergebnis: **0.0** (0)_{DNS}
Serien:
Zähler: 0 0 0 0 0 0 0 0 0 0
Innenzehner: 0
Weiteste:
~~beste Teiler~~
Trefferlage: 0.00 mm , 0.00 mm
Streuwert:

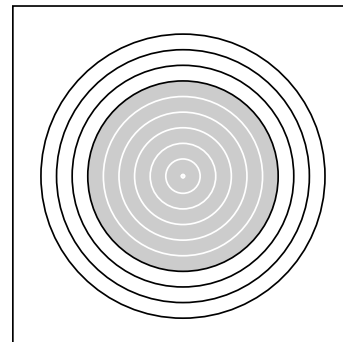

Ergebnis: **420.6** (400)
 Serien: 105.3 104.2 105.7 105.4
 Zähler: 40 0 0 0 0 0 0 0 0 0
 Innenzehner: 37
 Weitesten: 212 (31.), 203 (16.), 201 (3.)
 beste Teiler: 15.8 (8.), 29.1 (27.), 45.8 (21.)
 Trefferlage: 0.21 mm links, 0.10 mm tief
 Streuwert: 0.83, horizontal: 1.05, vertikal: 0.52

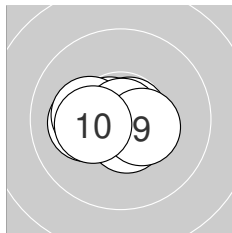
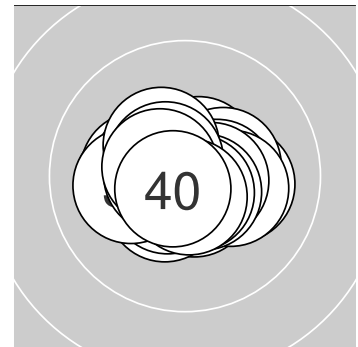

Serie 1:

10.7 *	10.7 *	10.1 ←	10.7 *	10.7 *
10.2 *	10.6 *	10.9 *	10.4 *	10.3 *

beste Teiler: 15.8 (8.), 52.9 (4.), 66.4 (2.)
 Trefferlage: 0.43 mm links, 0.20 mm tief
 Streuwert: 0.82, horizontal: 1.09, vertikal: 0.40

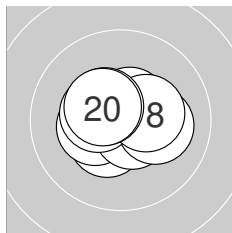

Serie 2:

10.6 *	10.4 *	10.3 *	10.6 *	10.6 *
10.1 →	10.4 *	10.3 *	10.5 *	10.4 *

beste Teiler: 87.6 (11.), 89.1 (14.), 98.4 (15.)
 Trefferlage: 0.16 mm links, 0.06 mm hoch
 Streuwert: 0.99, horizontal: 1.24, vertikal: 0.66

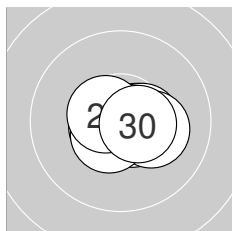

Serie 3:

10.8 *	10.6 *	10.6 *	10.5 *	10.2 *
10.6 *	10.8 *	10.5 *	10.6 *	10.5 *

beste Teiler: 29.1 (27.), 45.8 (21.), 80.4 (22.)
 Trefferlage: 0.30 mm rechts, 0.22 mm tief
 Streuwert: 0.70, horizontal: 0.95, vertikal: 0.31

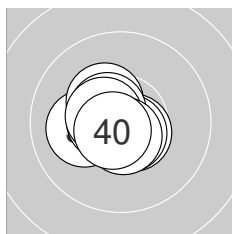

Serie 4:

10.1 ←	10.6 *	10.7 *	10.6 *	10.6 *
10.4 *	10.6 *	10.5 *	10.6 *	10.7 *

beste Teiler: 65.1 (33.), 67.8 (40.), 77.6 (35.)
 Trefferlage: 0.54 mm links, 0.04 mm tief
 Streuwert: 0.74, horizontal: 0.81, vertikal: 0.65



LG 40 ZR – Wertung –
StandNr: 112
Iacob,, Cosmin #70312095

Männer

StartNr: 133
27. April 2022 18:13
SG_St._Johann

Ergebnis: **0.0** (0)_{DNS}
Serien:
Zähler: 0 0 0 0 0 0 0 0 0 0
Innenzehner: 0
Weiteste:
~~beste Teiler~~
Trefferlage: 0.00 mm , 0.00 mm
Streuwert:

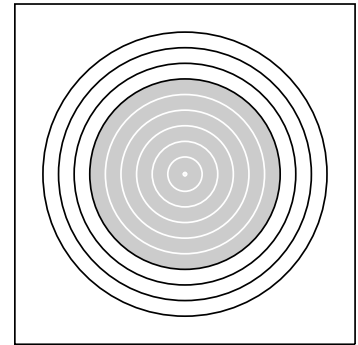

Ergebnis: **421.1** (398)
Serien: 103.9 106.3 105.6 105.3
Zähler: 38 2 0 0 0 0 0 0 0
Innenzehner: 37
Weiteste: 477 (37.), 300 (10.), 229 (9.)
beste Teiler: 19.6 (40.), 27.6 (39.), 32.2 (23.)
Trefferlage: 0.21 mm rechts, 0.14 mm tief
Streuwert: 0.94, horizontal: 1.14, vertikal: 0.68

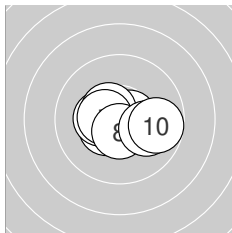
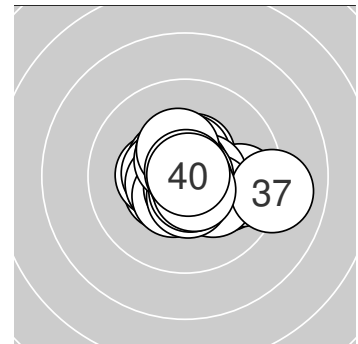

Serie 1:

10.4 *	10.5 *	10.7 *	10.6 *	10.3 *
10.5 *	10.5 *	10.6 *	10.0 →	9.8 →

beste Teiler: 65.4 (3.), 79.9 (4.), 98.0 (8.)
Trefferlage: 0.01 mm links, 0.25 mm tief
Streuwert: 1.15, horizontal: 1.54, vertikal: 0.53

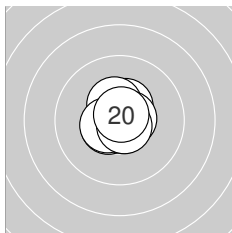

Serie 2:

10.8 *	10.8 *	10.5 *	10.5 *	10.7 *
10.4 *	10.6 *	10.5 *	10.7 *	10.8 *

beste Teiler: 35.3 (11.), 39.4 (12.), 47.8 (20.)
Trefferlage: 0.01 mm links, 0.13 mm hoch
Streuwert: 0.63, horizontal: 0.60, vertikal: 0.66

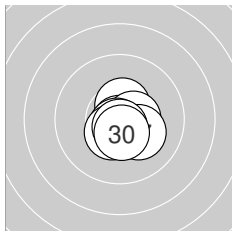

Serie 3:

10.5 *	10.6 *	10.8 *	10.6 *	10.5 *
10.7 *	10.2 *	10.5 *	10.7 *	10.5 *

beste Teiler: 32.2 (23.), 59.0 (26.), 63.0 (29.)
Trefferlage: 0.30 mm rechts, 0.49 mm tief
Streuwert: 0.65, horizontal: 0.63, vertikal: 0.66

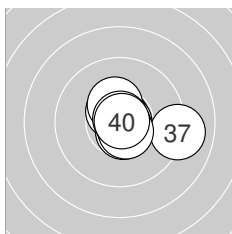

Serie 4:

10.8 *	10.8 *	10.6 *	10.6 *	10.4 *
10.8 *	9.0 →	10.6 *	10.8 *	10.9 *

beste Teiler: 19.6 (40.), 27.6 (39.), 38.0 (32.)
Trefferlage: 0.57 mm rechts, 0.03 mm hoch
Streuwert: 1.18, horizontal: 1.49, vertikal: 0.74



LG 40 ZR – Wertung –

Männer

StartNr: 135

StandNr: 114

27. April 2022 18:13

Bucher,, Reinhold #70311004

SG_Pillersee

Ergebnis: **0.0** (0)_{DNS}
Serien:
Zähler: 0 0 0 0 0 0 0 0 0 0
Innenzehner: 0
Weiteste:
~~beste Teiler~~
Trefferlage: 0.00 mm , 0.00 mm
Streuwert:

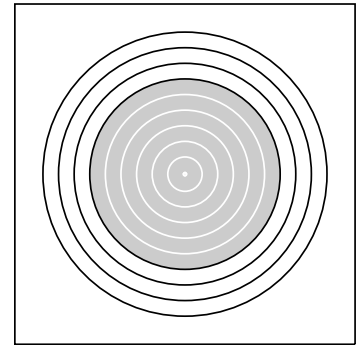

Ergebnis: **416.3** (397)
 Serien: 104.6 104.5 104.9 102.3
 Zähler: 37 3 0 0 0 0 0 0 0 0
 Innenzehner: 34
 Weitestе: 296 (33.), 282 (36.), 273 (10.)
 beste Teiler: 32.4 (27.), 38.0 (14.), 42.0 (9.)
 Trefferlage: 0.46 mm links, 0.24 mm tief
 Streuwert: 1.01, horizontal: 1.11, vertikal: 0.91

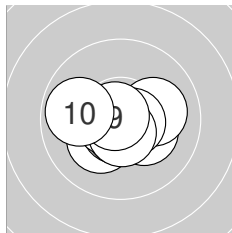
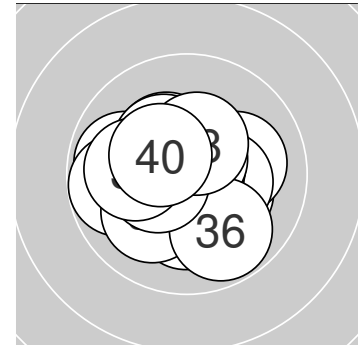

Serie 1:
 10.2 * 10.3 * 10.7 * 10.1 → 10.6 *
 10.7 * 10.7 * 10.6 * 10.8 * 9.9 ←
 beste Teiler: 42.0 (9.), 72.4 (3.), 72.8 (6.)
 Trefferlage: 0.09 mm links, 0.35 mm tief
 Streuwert: 1.06, horizontal: 1.37, vertikal: 0.61

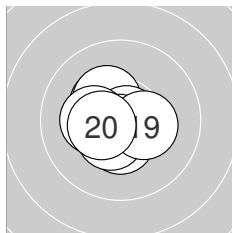

Serie 2:
 10.5 * 10.3 * 10.3 * 10.8 * 10.7 *
 10.3 * 10.4 * 10.5 * 10.3 * 10.4 *
 beste Teiler: 38.0 (14.), 55.9 (15.), 111.7 (11.)
 Trefferlage: 0.46 mm links, 0.03 mm tief
 Streuwert: 0.90, horizontal: 0.94, vertikal: 0.87

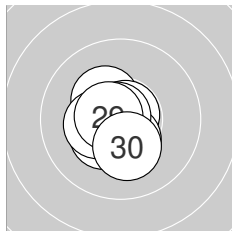

Serie 3:
 10.5 * 10.3 * 10.8 * 10.4 * 10.3 *
 10.7 * 10.8 * 10.3 * 10.6 * 10.2 *
 beste Teiler: 32.4 (27.), 42.4 (23.), 57.2 (26.)
 Trefferlage: 0.50 mm links, 0.23 mm tief
 Streuwert: 0.81, horizontal: 0.69, vertikal: 0.91

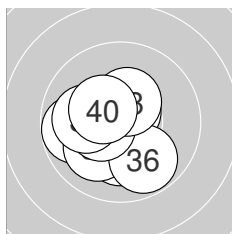

Serie 4:
 10.2 * 10.6 * 9.8 ← 10.5 * 10.1 ↗
 9.8 ↘ 10.4 * 10.4 * 10.1 ← 10.4 *
 beste Teiler: 78.0 (32.), 107.1 (34.), 129.7 (37.)
 Trefferlage: 0.79 mm links, 0.37 mm tief
 Streuwert: 1.30, horizontal: 1.35, vertikal: 1.25



Ergebnis: **414.2** (395)
 Serien: 104.7 101.8 103.3 104.4
 Zähler: 35 5 0 0 0 0 0 0 0 0
 Innenzehner: 30
 Weitestе: 406 (17.), 335 (18.), 266 (19.)
 beste Teiler: 40.0 (2.), 51.0 (36.), 58.6 (10.)
 Trefferlage: 0.06 mm rechts, 0.32 mm hoch
 Streuwert: 1.19, horizontal: 1.40, vertikal: 0.95

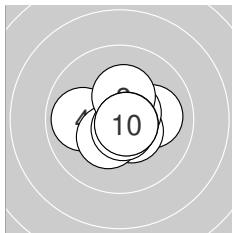
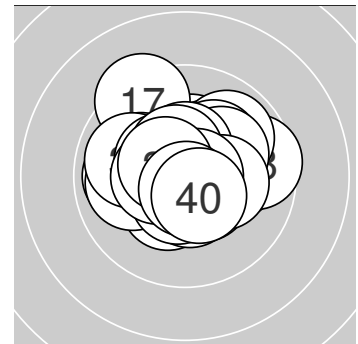

Serie 1:

10.1 →	10.8 *	10.5 *	9.9 ←	10.6 *
10.4 *	10.7 *	10.3 *	10.7 *	10.7 *

beste Teiler: 40.0 (2.), 58.6 (10.), 59.0 (9.)
 Trefferlage: 0.20 mm rechts, 0.14 mm tief
 Streuwert: 1.04, horizontal: 1.24, vertikal: 0.80

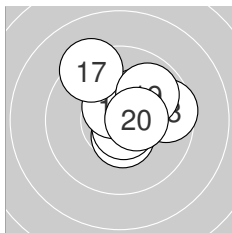

Serie 2:

10.5 *	10.5 *	10.7 *	10.1 ↗	10.2 *
10.5 *	9.3 ↘	9.6 →	9.9 ↗	10.5 *

beste Teiler: 61.2 (13.), 103.8 (16.), 109.0 (11.)
 Trefferlage: 0.87 mm rechts, 0.78 mm hoch
 Streuwert: 1.39, horizontal: 1.46, vertikal: 1.31

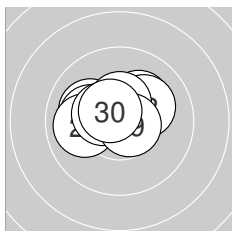

Serie 3:

10.1 ↖	10.2 *	10.2 *	10.6 *	10.1 ←
10.0 ←	10.4 *	10.4 *	10.7 *	10.6 *

beste Teiler: 75.0 (29.), 77.4 (24.), 99.0 (30.)
 Trefferlage: 0.47 mm links, 0.61 mm hoch
 Streuwert: 1.11, horizontal: 1.47, vertikal: 0.57

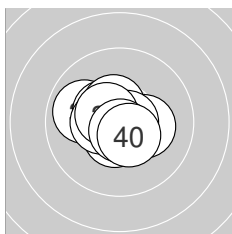

Serie 4:

9.9 ↖	10.3 *	10.5 *	10.4 *	10.5 *
10.7 *	10.4 *	10.5 *	10.7 *	10.5 *

beste Teiler: 51.0 (36.), 61.2 (39.), 101.8 (33.)
 Trefferlage: 0.35 mm links, 0.03 mm hoch
 Streuwert: 0.98, horizontal: 1.18, vertikal: 0.73



Ergebnis: **414.4** (396)
 Serien: 104.1 105.0 103.6 101.7
 Zähler: 36 4 0 0 0 0 0 0 0
 Innenzehner: 33
 Weitest: 414 (32.), 357 (31.), 350 (27.)
 beste Teiler: 9.8 (17.), 40.8 (37.), 58.2 (29.)
 Trefferlage: 0.09 mm rechts, 0.62 mm hoch
 Streuwert: 1.15, horizontal: 1.08, vertikal: 1.21

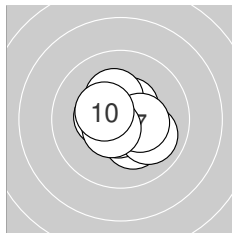
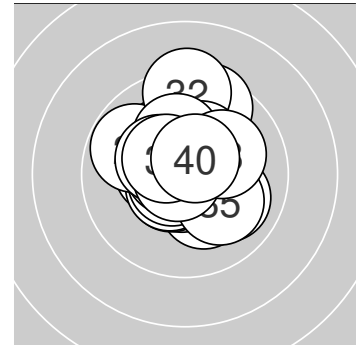

Serie 1:
 10.2 * 10.6 * 10.7 * 10.0 ↘ 10.5 *
 10.3 * 10.4 * 10.4 * 10.6 * 10.4 *
 beste Teiler: 71.8 (3.), 85.0 (2.), 96.8 (9.)
 Trefferlage: 0.21 mm rechts, 0.12 mm tief
 Streuwert: 1.08, horizontal: 1.17, vertikal: 0.98

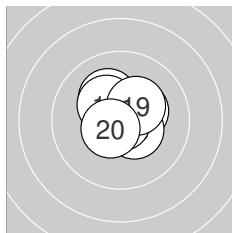

Serie 2:
 10.7 * 10.6 * 10.3 * 10.7 * 10.2 *
 10.4 * 10.9 * 10.3 * 10.3 * 10.6 *
 beste Teiler: 9.8 (17.), 63.0 (14.), 64.4 (11.)
 Trefferlage: 0.07 mm rechts, 0.45 mm hoch
 Streuwert: 0.86, horizontal: 0.94, vertikal: 0.77

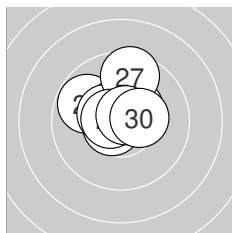

Serie 3:
 10.4 * 10.7 * 10.4 * 9.8 ↙ 10.5 *
 10.5 * 9.6 ↑ 10.6 * 10.7 * 10.4 *
 beste Teiler: 58.2 (29.), 75.2 (22.), 80.0 (28.)
 Trefferlage: 0.23 mm links, 0.90 mm hoch
 Streuwert: 1.11, horizontal: 1.18, vertikal: 1.03

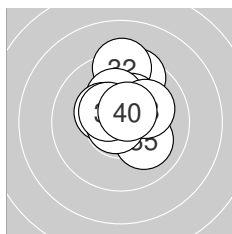

Serie 4:
 9.5 ↑ 9.3 ↑ 10.3 * 10.2 * 10.1 ↘
 10.3 * 10.8 * 10.1 ↗ 10.5 * 10.6 *
 beste Teiler: 40.8 (37.), 95.4 (40.), 123.5 (39.)
 Trefferlage: 0.32 mm rechts, 1.26 mm hoch
 Streuwert: 1.37, horizontal: 1.10, vertikal: 1.59



LG 40 ZR – Wertung –
StandNr: 118
Renzi, Michael #70818266

Männer

StartNr: 139
27. April 2022 18:13
SG_Jenbach–Buch

Ergebnis: **0.0** (0)_{DNS}
Serien:
Zähler: 0 0 0 0 0 0 0 0 0 0
Innenzehner: 0
Weiteste:
~~beste Teiler~~
Trefferlage: 0.00 mm , 0.00 mm
Streuwert:

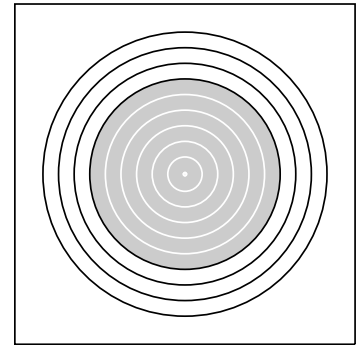

Ergebnis: **422.4** (398)
 Serien: 106.4 104.9 105.8 105.3
 Zähler: 38 2 0 0 0 0 0 0 0 0
 Innenzehner: 36
 Weitesten: 282 (19.), 252 (35.), 220 (23.)
 beste Teiler: 21.9 (7.), 27.3 (32.), 28.7 (4.)
 Trefferlage: 0.11 mm rechts, 0.26 mm tief
 Streuwert: 0.80, horizontal: 0.82, vertikal: 0.78

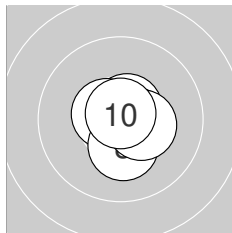
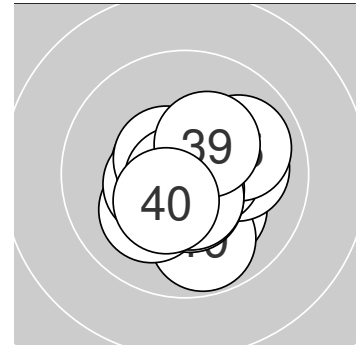

Serie 1:
 10.7 * 10.8 * 10.6 *
 10.5 * 10.9 * 10.3 *
 beste Teiler: 21.9 (7.), 28.7 (4.), 37.0 (10.)
 Trefferlage: 0.16 mm rechts, 0.08 mm tief
 Streuwert: 0.65, horizontal: 0.63, vertikal: 0.67

10.8 * 10.6 *
 10.4 * 10.8 *

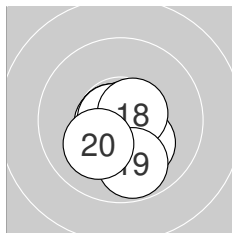

Serie 2:
 10.8 * 10.2 * 10.7 *
 10.7 * 10.7 * 10.6 *
 beste Teiler: 33.9 (11.), 38.0 (15.), 51.4 (17.)
 Trefferlage: 0.02 mm links, 0.61 mm tief
 Streuwert: 0.93, horizontal: 0.83, vertikal: 1.03

10.5 * 10.8 *
 9.8 ↘ 10.1 ↙

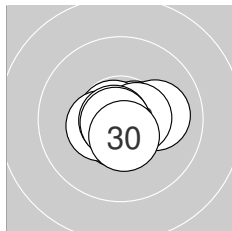

Serie 3:
 10.6 * 10.8 * 10.1 →
 10.5 * 10.4 * 10.8 *
 beste Teiler: 39.6 (29.), 42.9 (28.), 50.5 (22.)
 Trefferlage: 0.19 mm rechts, 0.23 mm tief
 Streuwert: 0.75, horizontal: 0.97, vertikal: 0.46

10.7 * 10.6 *
 10.8 * 10.5 *

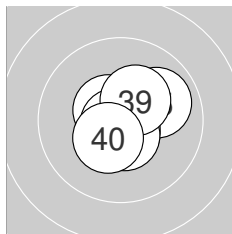

Serie 4:
 10.7 * 10.8 * 10.5 *
 10.7 * 10.8 * 10.6 *
 beste Teiler: 27.3 (32.), 38.8 (37.), 69.4 (36.)
 Trefferlage: 0.12 mm rechts, 0.12 mm tief
 Streuwert: 0.90, horizontal: 0.94, vertikal: 0.85

10.6 * 9.9 ↗
 10.3 * 10.4 *



Ergebnis: **412.4** (392)
 Serien: 104.6 102.3 101.6 103.9
 Zähler: 32 8 0 0 0 0 0 0 0 0
 Innenzehner: 30
 Weitester: 448 (22.), 345 (24.), 303 (17.)
 beste Teiler: 32.6 (7.), 37.3 (4.), 46.0 (34.)
 Trefferlage: 0.07 mm links, 0.26 mm hoch
 Streuwert: 1.30, horizontal: 1.43, vertikal: 1.16

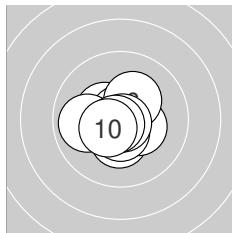
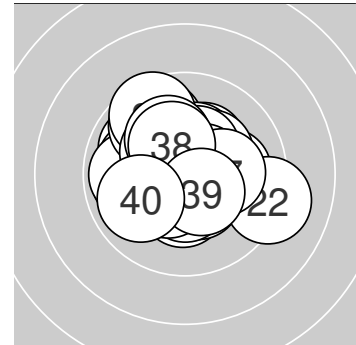

Serie 1:

10.3 *	10.4 *	10.4 *	10.8 *	10.5 *
10.3 *	10.8 *	9.9 ←	10.7 *	10.5 *

beste Teiler: 32.6 (7.), 37.3 (4.), 55.1 (9.)
 Trefferlage: 0.29 mm links, 0.23 mm tief
 Streuwert: 0.99, horizontal: 1.11, vertikal: 0.85

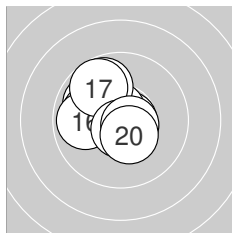

Serie 2:

10.7 *	9.9 ↘	10.6 *	10.0 ←	9.8 ↘
9.9 ←	9.7 ↘	10.7 *	10.6 *	10.4 *

beste Teiler: 57.0 (11.), 67.1 (18.), 79.6 (13.)
 Trefferlage: 0.86 mm links, 0.54 mm hoch
 Streuwert: 1.30, horizontal: 1.33, vertikal: 1.26

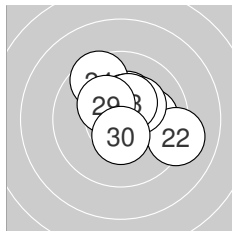

Serie 3:

10.1 →	9.2 ↘	10.3 *	9.6 ↘	10.6 *
10.3 *	10.4 *	10.4 *	10.3 *	10.4 *

beste Teiler: 80.5 (25.), 126.0 (30.), 129.1 (27.)
 Trefferlage: 0.68 mm rechts, 0.74 mm hoch
 Streuwert: 1.50, horizontal: 1.67, vertikal: 1.30

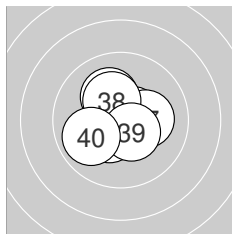

Serie 4:

10.2 *	10.5 *	10.5 *	10.8 *	10.6 *
10.4 *	10.2 *	10.3 *	10.5 *	9.9 ←

beste Teiler: 46.0 (34.), 97.8 (35.), 121.2 (32.)
 Trefferlage: 0.16 mm rechts, 0.00 mm
 Streuwert: 1.17, horizontal: 1.29, vertikal: 1.03



LG 40 ZR – Wertung –
StandNr: 121
Weber,, Alois #70818267

Männer

StartNr: 142
27. April 2022 18:13
SG_Igls–Vill–Ibk

Ergebnis: **0.0** (0)_{DNS}
Serien:
Zähler: 0 0 0 0 0 0 0 0 0 0
Innenzehner: 0
Weiteste:
~~beste Teiler~~Schütze ist nicht zum Wettkampf angetreten
Trefferlage: 0.00 mm , 0.00 mm
Streuwert:

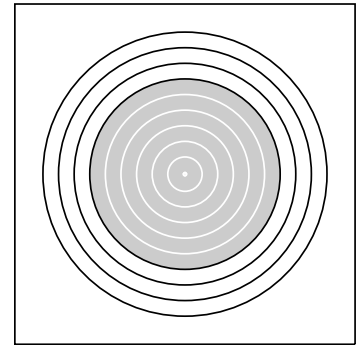

Ergebnis: **417.7** (398)
Serien: 103.3 104.5 106.5 103.4
Zähler: 38 2 0 0 0 0 0 0 0 0
Innenzehner: 34
Weiteste: 363 (35.), 345 (34.), 223 (4.)
beste Teiler: 20.2 (29.), 24.0 (19.), 29.0 (22.)
Trefferlage: 0.67 mm links, 0.32 mm tief
Streuwert: 0.92, horizontal: 1.01, vertikal: 0.81

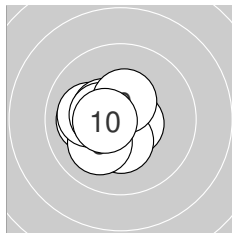
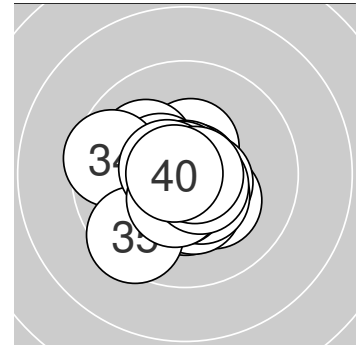

Serie 1:
 10.6 * 10.3 * 10.4 *
 10.1 ← 10.4 * 10.4 *
beste Teiler: 82.6 (1.), 109.5 (10.), 127.6 (9.)
Trefferlage: 0.96 mm links, 0.08 mm tief
Streuwert: 0.95, horizontal: 1.01, vertikal: 0.89

10.1 ← 10.1 ↗
 10.4 * 10.5 *

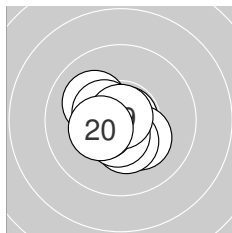

Serie 2:
 10.8 * 10.5 * 10.1 ↘
 10.5 * 10.4 * 10.4 *
beste Teiler: 24.0 (19.), 35.7 (11.), 102.9 (16.)
Trefferlage: 0.48 mm links, 0.28 mm tief
Streuwert: 0.92, horizontal: 1.00, vertikal: 0.83

10.2 * 10.3 *
 10.9 * 10.4 *

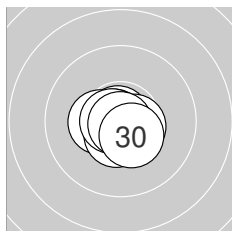

Serie 3:
 10.6 * 10.8 * 10.8 *
 10.6 * 10.6 * 10.7 *
beste Teiler: 20.2 (29.), 29.0 (22.), 45.0 (23.)
Trefferlage: 0.29 mm links, 0.30 mm tief
Streuwert: 0.57, horizontal: 0.71, vertikal: 0.40

10.6 * 10.4 *
 10.9 * 10.5 *

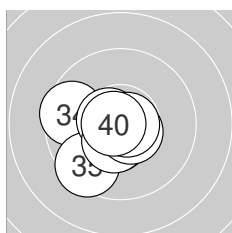

Serie 4:
 10.2 * 10.3 * 10.5 *
 10.6 * 10.5 * 10.6 *
beste Teiler: 46.1 (39.), 49.0 (40.), 86.3 (36.)
Trefferlage: 0.95 mm links, 0.62 mm tief
Streuwert: 1.13, horizontal: 1.25, vertikal: 1.01

9.6 ← 9.5 ↗
 10.8 * 10.8 *



Ergebnis: **415.4** (395)
 Serien: 103.8 103.7 103.3 104.6
 Zähler: 35 5 0 0 0 0 0 0 0 0
 Innenzehner: 31
 Weitester: 325 (25.), 287 (1.), 286 (33.)
 beste Teiler: 36.4 (15.), 38.0 (23.), 38.8 (40.)
 Trefferlage: 0.50 mm links, 0.04 mm tief
 Streuwert: 1.11, horizontal: 1.35, vertikal: 0.81

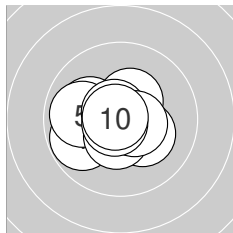
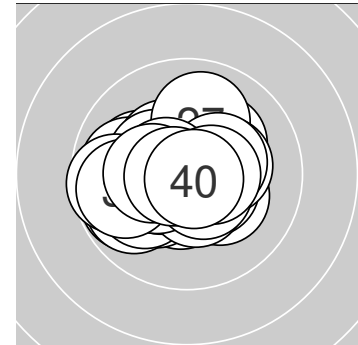

Serie 1:
 9.8 ← 10.2 * 10.1 ← 10.4 * 9.9 ←
 10.7 * 10.5 * 10.6 * 10.8 * 10.8 *
 beste Teiler: 39.5 (10.), 48.2 (9.), 63.7 (6.)
 Trefferlage: 0.56 mm links, 0.11 mm tief
 Streuwert: 1.18, horizontal: 1.44, vertikal: 0.83

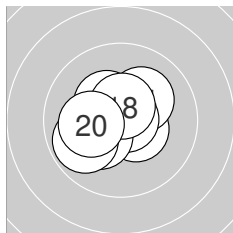

Serie 2:
 10.7 * 10.5 * 10.3 * 10.2 * 10.8 *
 10.4 * 10.2 * 10.6 * 9.9 ← 10.1 ←
 beste Teiler: 36.4 (15.), 56.9 (11.), 96.6 (18.)
 Trefferlage: 0.53 mm links, 0.03 mm hoch
 Streuwert: 1.15, horizontal: 1.33, vertikal: 0.95

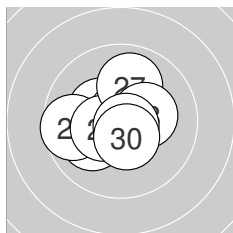

Serie 3:
 10.4 * 10.3 * 10.8 * 10.1 ← 9.7 ←
 10.4 * 10.0 ↑ 10.3 * 10.8 * 10.5 *
 beste Teiler: 38.0 (23.), 50.9 (29.), 114.5 (30.)
 Trefferlage: 0.59 mm links, 0.08 mm hoch
 Streuwert: 1.26, horizontal: 1.45, vertikal: 1.03

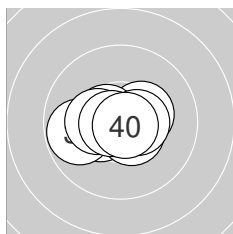

Serie 4:
 10.4 * 10.4 * 9.8 ← 10.6 * 10.5 *
 10.6 * 10.3 * 10.7 * 10.5 * 10.8 *
 beste Teiler: 38.8 (40.), 61.8 (38.), 87.9 (34.)
 Trefferlage: 0.30 mm links, 0.18 mm tief
 Streuwert: 1.01, horizontal: 1.36, vertikal: 0.42



Ergebnis: **417.0** (396)
Serien: 104.7 104.8 102.7 104.8
Zähler: 36 4 0 0 0 0 0 0 0
Innenzehner: 35
Weiteste: 413 (29.), 386 (3.), 346 (20.)
beste Teiler: 13.0 (15.), 13.6 (4.), 15.2 (16.)
Trefferlage: 0.27 mm links, 0.69 mm tief
Streuwert: 1.05, horizontal: 0.92, vertikal: 1.16

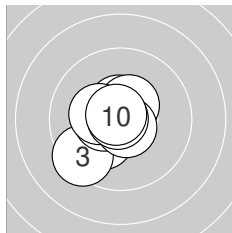
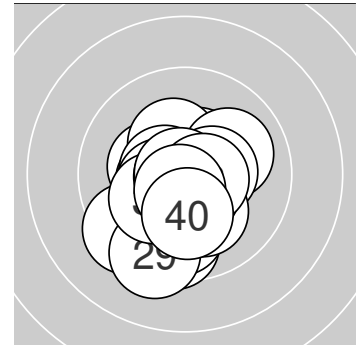

Serie 1:
 10.5 * 10.2 * 9.4 ↙
 10.5 * 10.7 * 10.3 *
beste Teiler: 13.6 (4.), 21.2 (9.), 46.6 (10.)
Trefferlage: 0.66 mm links, 0.20 mm tief
Streuwert: 1.09, horizontal: 1.04, vertikal: 1.13

10.9 * 10.5 *
 10.9 * 10.8 *

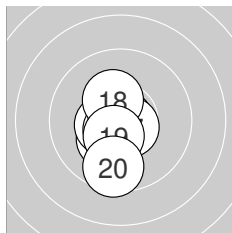

Serie 2:
 10.7 * 10.3 * 10.5 *
 10.9 * 10.6 * 10.3 *
beste Teiler: 13.0 (15.), 15.2 (16.), 57.9 (11.)
Trefferlage: 0.39 mm links, 0.65 mm tief
Streuwert: 0.95, horizontal: 0.52, vertikal: 1.24

10.6 * 10.9 *
 10.4 * 9.6 ↓

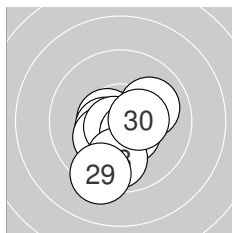

Serie 3:
 10.6 * 10.5 * 10.5 *
 10.0 → 10.5 * 9.9 ↓
beste Teiler: 63.7 (25.), 100.1 (21.), 104.2 (22.)
Trefferlage: 0.10 mm links, 0.92 mm tief
Streuwert: 1.32, horizontal: 1.21, vertikal: 1.43

10.3 * 10.7 *
 9.3 ↓ 10.4 *

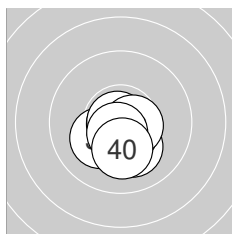

Serie 4:
 10.3 * 10.4 * 10.2 *
 10.9 * 10.6 * 10.6 *
beste Teiler: 24.1 (36.), 29.9 (35.), 82.8 (39.)
Trefferlage: 0.07 mm rechts, 1.00 mm tief
Streuwert: 0.72, horizontal: 0.71, vertikal: 0.72

10.2 * 10.8 *
 10.6 * 10.2 *



Ergebnis: **419.0** (397)
 Serien: 105.4 103.3 104.8 105.5
 Zähler: 37 3 0 0 0 0 0 0 0 0
 Innenzehner: 37
 Weitester: 386 (20.), 288 (38.), 254 (5.)
 beste Teiler: 37.4 (21.), 44.2 (32.), 45.0 (8.)
 Trefferlage: 0.15 mm rechts, 0.03 mm tief
 Streuwert: 0.99, horizontal: 1.20, vertikal: 0.73

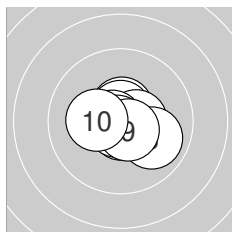
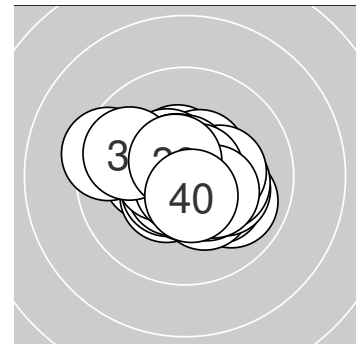

Serie 1:
 10.6 * 10.6 * 10.7 * 10.5 * 9.9 ↗
 10.7 * 10.7 * 10.8 * 10.6 * 10.3 *
 beste Teiler: 45.0 (8.), 57.2 (7.), 61.0 (6.)
 Trefferlage: 0.23 mm rechts, 0.12 mm tief
 Streuwert: 0.88, horizontal: 1.06, vertikal: 0.64

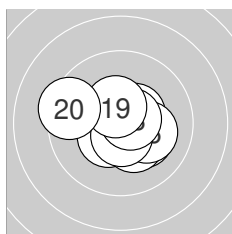

Serie 2:
 10.6 * 10.4 * 10.5 * 10.2 * 10.3 *
 10.2 * 10.6 * 10.6 * 10.5 * 9.4 ↖
 beste Teiler: 77.0 (18.), 88.8 (11.), 89.3 (17.)
 Trefferlage: 0.20 mm rechts, 0.13 mm tief
 Streuwert: 1.32, horizontal: 1.61, vertikal: 0.93

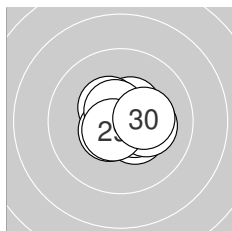

Serie 3:
 10.8 * 10.5 * 10.4 * 10.4 * 10.5 *
 10.5 * 10.2 * 10.6 * 10.6 * 10.3 *
 beste Teiler: 37.4 (21.), 84.2 (29.), 86.3 (28.)
 Trefferlage: 0.36 mm rechts, 0.04 mm hoch
 Streuwert: 0.88, horizontal: 1.03, vertikal: 0.71

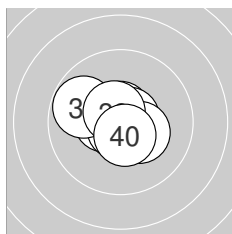

Serie 4:
 10.5 * 10.8 * 10.7 * 10.8 * 10.7 *
 10.7 * 10.3 * 9.8 ↖ 10.6 * 10.6 *
 beste Teiler: 44.2 (32.), 49.7 (34.), 63.9 (36.)
 Trefferlage: 0.18 mm links, 0.08 mm hoch
 Streuwert: 0.92, horizontal: 1.11, vertikal: 0.68



Ergebnis: **414.8** (396)
 Serien: 105.0 105.0 102.7 102.1
 Zähler: 36 4 0 0 0 0 0 0 0
 Innenzehner: 30
 Weitestе: 327 (23.), 312 (21.), 251 (37.)
 beste Teiler: 35.4 (15.), 36.4 (5.), 43.0 (18.)
 Trefferlage: 0.20 mm links, 0.11 mm hoch
 Streuwert: 1.15, horizontal: 1.10, vertikal: 1.21

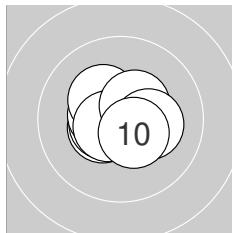
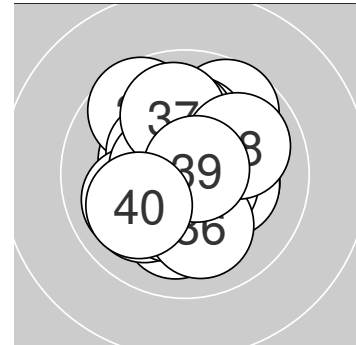

Serie 1:
 10.5 * 10.5 * 10.5 * 10.6 * 10.8 *
 10.3 * 10.6 * 10.5 * 10.2 * 10.5 *
 beste Teiler: 36.4 (5.), 82.0 (4.), 88.6 (7.)
 Trefferlage: 0.24 mm links, 0.00 mm
 Streuwert: 0.88, horizontal: 1.04, vertikal: 0.67

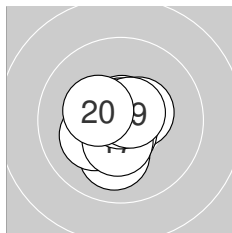

Serie 2:
 10.1 ↓ 10.2 * 10.7 * 10.5 * 10.8 *
 10.6 * 10.4 * 10.8 * 10.6 * 10.3 *
 beste Teiler: 35.4 (15.), 43.0 (18.), 59.5 (13.)
 Trefferlage: 0.21 mm links, 0.27 mm tief
 Streuwert: 0.91, horizontal: 0.83, vertikal: 0.98

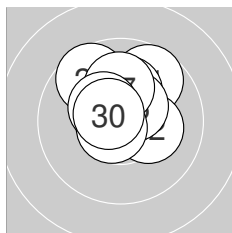

Serie 3:
 9.7 ↗ 10.2 * 9.6 ↘ 10.2 * 10.7 *
 10.5 * 10.1 ↑ 10.4 * 10.7 * 10.6 *
 beste Teiler: 51.2 (25.), 70.0 (29.), 88.8 (30.)
 Trefferlage: 0.00 mm , 1.11 mm hoch
 Streuwert: 1.17, horizontal: 1.18, vertikal: 1.16

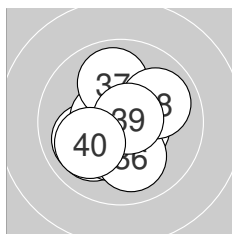

Serie 4:
 10.6 * 10.0 ↙ 10.6 * 10.0 ↙ 10.3 *
 10.1 ↓ 9.9 ↑ 9.9 ↘ 10.7 * 10.0 ↙
 beste Teiler: 52.8 (39.), 95.7 (31.), 99.9 (33.)
 Trefferlage: 0.35 mm links, 0.38 mm tief
 Streuwert: 1.41, horizontal: 1.40, vertikal: 1.43



Ergebnis: **416.6** (398)
 Serien: 104.1 104.0 104.2 104.3
 Zähler: 38 2 0 0 0 0 0 0 0
 Innenzehner: 34
 Weitestе: 303 (3.), 296 (38.), 236 (36.)
 beste Teiler: 42.5 (21.), 47.7 (1.), 51.4 (33.)
 Trefferlage: 0.07 mm rechts, 0.20 mm hoch
 Streuwert: 1.05, horizontal: 1.16, vertikal: 0.93

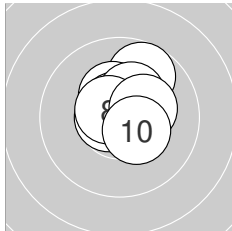
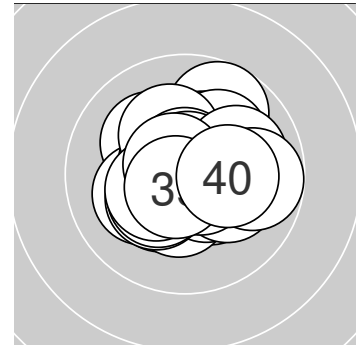

Serie 1:

10.8 *	10.3 *	9.7 ↗	10.4 *	10.6 *
10.3 *	10.7 *	10.6 *	10.3 *	10.4 *

beste Teiler: 47.7 (1.), 73.0 (7.), 78.5 (5.)
 Trefferlage: 0.27 mm rechts, 0.81 mm hoch
 Streuwert: 0.94, horizontal: 0.90, vertikal: 0.97

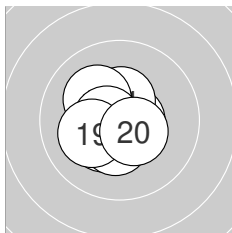

Serie 2:

10.7 *	10.5 *	10.4 *	10.4 *	10.1 ↘
10.3 *	10.4 *	10.6 *	10.1 ↙	10.5 *

beste Teiler: 74.0 (11.), 84.0 (18.), 119.6 (20.)
 Trefferlage: 0.59 mm links, 0.10 mm tief
 Streuwert: 0.96, horizontal: 0.93, vertikal: 0.98

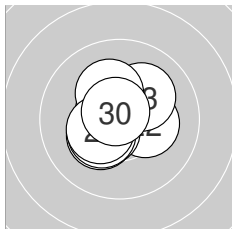

Serie 3:

10.8 *	10.3 *	10.1 ↗	10.3 *	10.6 *
10.5 *	10.3 *	10.2 *	10.4 *	10.7 *

beste Teiler: 42.5 (21.), 56.8 (30.), 84.2 (25.)
 Trefferlage: 0.34 mm links, 0.06 mm hoch
 Streuwert: 1.03, horizontal: 1.06, vertikal: 0.99

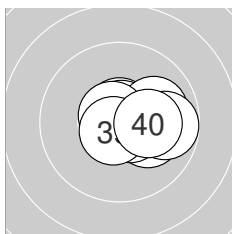

Serie 4:

10.7 *	10.7 *	10.7 *	10.2 *	10.6 *
10.0 →	10.7 *	9.8 →	10.7 *	10.2 *

beste Teiler: 51.4 (33.), 63.7 (37.), 67.0 (32.)
 Trefferlage: 0.95 mm rechts, 0.04 mm hoch
 Streuwert: 0.93, horizontal: 1.20, vertikal: 0.54



Ergebnis: **419.7** (400)
 Serien: 105.6 104.4 104.9 104.8
 Zähler: 40 0 0 0 0 0 0 0 0 0
 Innenzehner: 36
 Weitesten: 240 (32.), 223 (18.), 213 (8.)
 beste Teiler: 23.3 (2.), 27.3 (26.), 28.6 (37.)
 Trefferlage: 0.31 mm links, 0.24 mm tief
 Streuwert: 0.89, horizontal: 1.06, vertikal: 0.67

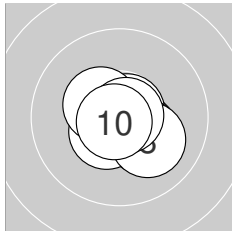
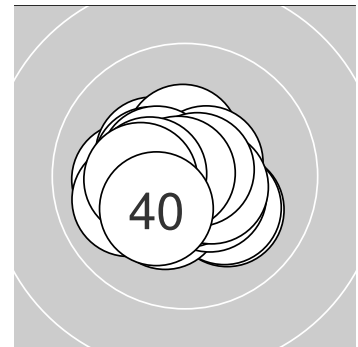

Serie 1:

10.4 *	10.9 *	10.7 *	10.7 *	10.3 *
10.5 *	10.4 *	10.1 ↘	10.8 *	10.8 *

beste Teiler: 23.3 (2.), 38.6 (9.), 41.8 (10.)
 Trefferlage: 0.26 mm rechts, 0.37 mm tief
 Streuwert: 0.80, horizontal: 0.91, vertikal: 0.66

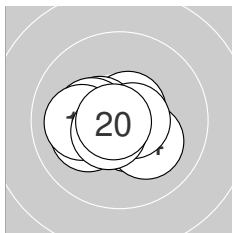

Serie 2:

10.1 ↙	10.6 *	10.6 *	10.2 *	10.5 *
10.3 *	10.6 *	10.1 ←	10.6 *	10.8 *

beste Teiler: 37.3 (20.), 76.0 (17.), 82.0 (12.)
 Trefferlage: 0.45 mm links, 0.25 mm tief
 Streuwert: 1.00, horizontal: 1.27, vertikal: 0.61

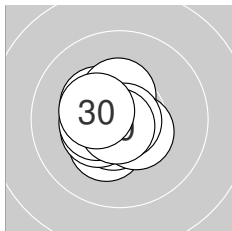

Serie 3:

10.3 *	10.6 *	10.3 *	10.4 *	10.5 *
10.8 *	10.4 *	10.4 *	10.8 *	10.4 *

beste Teiler: 27.3 (26.), 44.0 (29.), 86.3 (22.)
 Trefferlage: 0.54 mm links, 0.15 mm tief
 Streuwert: 0.83, horizontal: 0.80, vertikal: 0.85

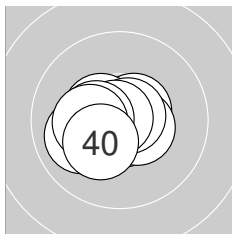

Serie 4:

10.7 *	10.0 ↙	10.6 *	10.5 *	10.5 *
10.7 *	10.8 *	10.4 *	10.3 *	10.3 *

beste Teiler: 28.6 (37.), 55.4 (36.), 57.0 (31.)
 Trefferlage: 0.53 mm links, 0.18 mm tief
 Streuwert: 0.91, horizontal: 1.14, vertikal: 0.61



Ergebnis: **417.6** (399)
 Serien: 103.9 105.8 104.4 103.5
 Zähler: 39 1 0 0 0 0 0 0 0
 Innenzehner: 31
 Weitestе: 277 (33.), 250 (36.), 230 (31.)
 beste Teiler: 30.8 (32.), 31.7 (19.), 46.7 (20.)
 Trefferlage: 0.01 mm links, 0.07 mm tief
 Streuwert: 1.03, horizontal: 1.08, vertikal: 0.98

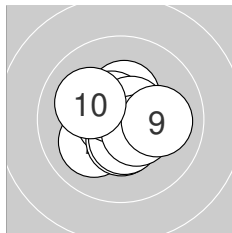
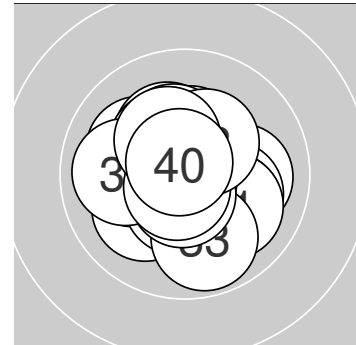

Serie 1:

10.4 *	10.1 ↙	10.7 *	10.4 *	10.5 *
10.6 *	10.6 *	10.5 *	10.0 →	10.1 ↘

beste Teiler: 57.1 (3.), 81.2 (7.), 97.4 (6.)
 Trefferlage: 0.02 mm links, 0.11 mm tief
 Streuwert: 1.14, horizontal: 1.24, vertikal: 1.04

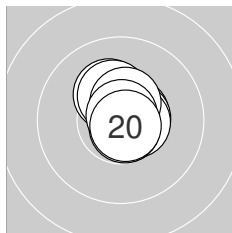

Serie 2:

10.6 *	10.2 *	10.3 *	10.7 *	10.6 *
10.6 *	10.7 *	10.5 *	10.8 *	10.8 *

beste Teiler: 31.7 (19.), 46.7 (20.), 51.1 (17.)
 Trefferlage: 0.26 mm rechts, 0.37 mm hoch
 Streuwert: 0.68, horizontal: 0.55, vertikal: 0.79

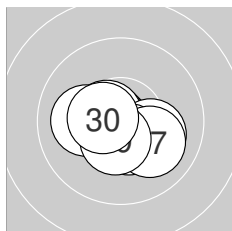

Serie 3:

10.7 *	10.7 *	10.6 *	10.6 *	10.1 ↘
10.5 *	10.1 ↘	10.1 ←	10.5 *	10.5 *

beste Teiler: 53.0 (21.), 61.1 (22.), 93.9 (23.)
 Trefferlage: 0.16 mm links, 0.47 mm tief
 Streuwert: 1.01, horizontal: 1.29, vertikal: 0.61

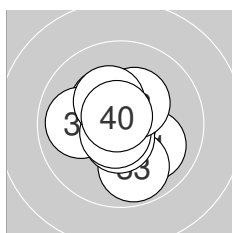

Serie 4:

10.0 ↘	10.8 *	9.8 ↓	10.6 *	10.3 *
10.0 ←	10.7 *	10.3 *	10.3 *	10.7 *

beste Teiler: 30.8 (32.), 55.4 (40.), 62.4 (37.)
 Trefferlage: 0.13 mm links, 0.10 mm tief
 Streuwert: 1.25, horizontal: 1.19, vertikal: 1.31



Ergebnis: **416.5** (399)
 Serien: 103.7 104.3 104.0 104.5
 Zähler: 39 1 0 0 0 0 0 0 0
 Innenzehner: 33
 Weitester: 275 (17.), 248 (31.), 245 (16.)
 beste Teiler: 8.5 (26.), 19.4 (12.), 29.9 (40.)
 Trefferlage: 0.01 mm links, 0.13 mm hoch
 Streuwert: 1.06, horizontal: 1.24, vertikal: 0.85

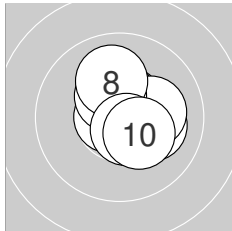
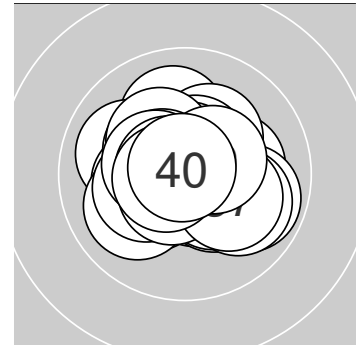

Serie 1:

10.1 ↗	10.5 *	10.5 *	10.4 *	10.2 *
10.7 *	10.4 *	10.0 ↑	10.6 *	10.3 *

beste Teiler: 61.0 (6.), 86.8 (9.), 101.0 (2.)
 Trefferlage: 0.53 mm rechts, 0.42 mm hoch
 Streuwert: 1.02, horizontal: 1.00, vertikal: 1.05

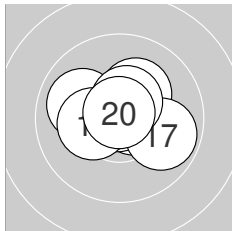

Serie 2:

10.6 *	10.9 *	10.5 *	10.2 *	10.6 *
10.0 ↖	9.9 ↘	10.3 *	10.5 *	10.8 *

beste Teiler: 19.4 (12.), 35.2 (20.), 85.8 (15.)
 Trefferlage: 0.11 mm links, 0.28 mm hoch
 Streuwert: 1.13, horizontal: 1.43, vertikal: 0.71

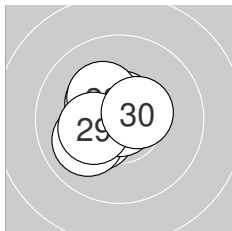

Serie 3:

10.3 *	10.6 *	10.2 *	10.0 ↙	10.3 *
10.9 *	10.6 *	10.3 *	10.3 *	10.5 *

beste Teiler: 8.5 (26.), 76.7 (27.), 79.6 (22.)
 Trefferlage: 0.69 mm links, 0.02 mm hoch
 Streuwert: 1.00, horizontal: 1.07, vertikal: 0.91

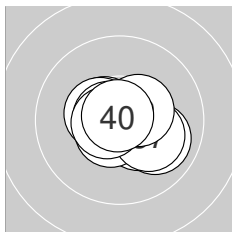

Serie 4:

10.0 ↘	10.4 *	10.5 *	10.4 *	10.7 *
10.6 *	10.1 ↘	10.6 *	10.4 *	10.8 *

beste Teiler: 29.9 (40.), 69.1 (35.), 79.6 (38.)
 Trefferlage: 0.20 mm rechts, 0.19 mm tief
 Streuwert: 1.01, horizontal: 1.26, vertikal: 0.66



Ergebnis: **415.7** (397)
 Serien: 104.6 104.3 103.5 103.3
 Zähler: 37 3 0 0 0 0 0 0 0 0
 Innenzehner: 35
 Weitester: 475 (26.), 372 (31.), 283 (8.)
 beste Teiler: 38.4 (6.), 43.0 (4.), 43.9 (23.)
 Trefferlage: 0.21 mm rechts, 0.19 mm tief
 Streuwert: 1.16, horizontal: 1.28, vertikal: 1.02

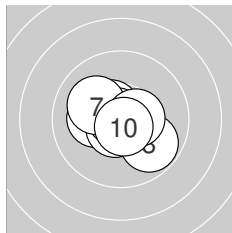
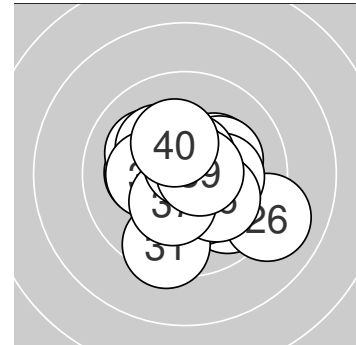

Serie 1:
 10.6 * 10.5 * 10.2 * 10.8 * 10.6 *
 10.8 * 10.1 ↖ 9.8 ↘ 10.5 * 10.7 *
 beste Teiler: 38.4 (6.), 43.0 (4.), 61.8 (10.)
 Trefferlage: 0.05 mm links, 0.16 mm tief
 Streuwert: 1.07, horizontal: 1.28, vertikal: 0.81

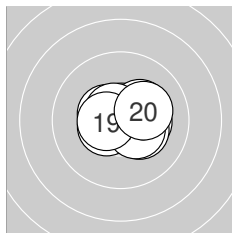

Serie 2:
 10.7 * 10.3 * 10.3 * 10.3 * 10.5 *
 10.5 * 10.6 * 10.4 * 10.5 * 10.2 *
 beste Teiler: 60.2 (11.), 80.0 (17.), 109.2 (19.)
 Trefferlage: 0.38 mm rechts, 0.11 mm hoch
 Streuwert: 0.98, horizontal: 1.25, vertikal: 0.62

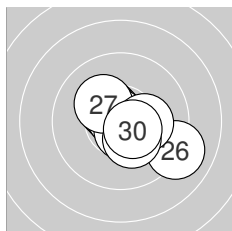

Serie 3:
 10.4 * 10.7 * 10.8 * 10.7 * 10.6 *
 9.1 ↘ 10.2 * 10.2 * 10.3 * 10.5 *
 beste Teiler: 43.9 (23.), 60.2 (24.), 74.2 (22.)
 Trefferlage: 0.52 mm rechts, 0.25 mm tief
 Streuwert: 1.36, horizontal: 1.60, vertikal: 1.07

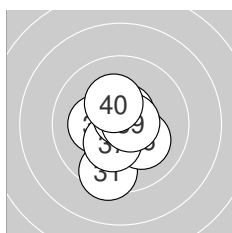

Serie 4:
 9.5 ↓ 10.6 * 10.2 * 10.4 * 10.6 *
 10.1 ↘ 10.3 * 10.7 * 10.6 * 10.3 *
 beste Teiler: 57.2 (38.), 76.7 (39.), 90.6 (35.)
 Trefferlage: 0.02 mm links, 0.48 mm tief
 Streuwert: 1.27, horizontal: 1.04, vertikal: 1.46



LG 40 ZR – Wertung –

Männer

StartNr: 153

StandNr: 132

27. April 2022 18:13

Lanzinger,, Peter #70818232

SG_Brandenberg

Ergebnis: **0.0** (0)_{DNS}
Serien:
Zähler: 0 0 0 0 0 0 0 0 0 0
Innenzehner: 0
Weiteste:
~~beste Teiler~~
Trefferlage: 0.00 mm , 0.00 mm
Streuwert:

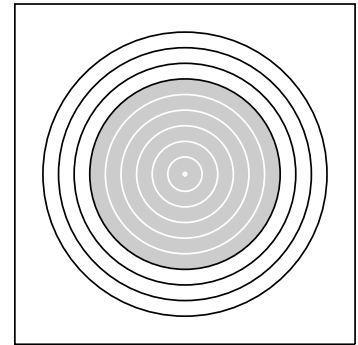

Ergebnis: **421.7** (400)
 Serien: 104.5 106.1 104.7 106.4
 Zähler: 40 0 0 0 0 0 0 0 0 0
 Innenzehner: 39
 Weitesten: 204 (24.), 191 (14.), 183 (29.)
 beste Teiler: 17.0 (11.), 25.0 (36.), 30.4 (31.)
 Trefferlage: 0.08 mm links, 0.12 mm tief
 Streuwert: 0.80, horizontal: 0.89, vertikal: 0.71

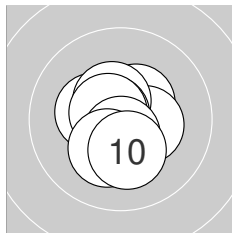
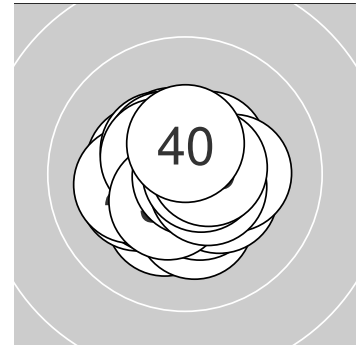

Serie 1:

10.6 *	10.4 *	10.3 *	10.4 *	10.5 *
10.7 *	10.6 *	10.6 *	10.2 *	10.2 *

beste Teiler: 64.4 (6.), 81.4 (7.), 88.8 (1.)
 Trefferlage: 0.07 mm links, 0.21 mm tief
 Streuwert: 0.95, horizontal: 0.90, vertikal: 1.00

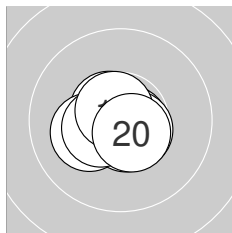

Serie 2:

10.9 *	10.6 *	10.7 *	10.2 *	10.6 *
10.6 *	10.7 *	10.5 *	10.7 *	10.6 *

beste Teiler: 17.0 (11.), 54.1 (13.), 59.2 (17.)
 Trefferlage: 0.24 mm links, 0.25 mm tief
 Streuwert: 0.67, horizontal: 0.82, vertikal: 0.48

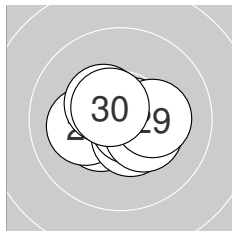

Serie 3:

10.8 *	10.7 *	10.4 *	10.1 ←	10.5 *
10.7 *	10.4 *	10.3 *	10.2 *	10.6 *

beste Teiler: 47.6 (21.), 60.5 (26.), 65.3 (22.)
 Trefferlage: 0.03 mm links, 0.14 mm tief
 Streuwert: 0.96, horizontal: 1.20, vertikal: 0.63

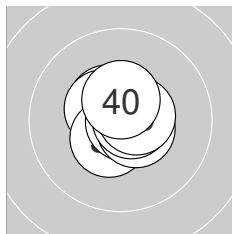

Serie 4:

10.8 *	10.5 *	10.5 *	10.5 *	10.8 *
10.9 *	10.6 *	10.7 *	10.6 *	10.5 *

beste Teiler: 25.0 (36.), 30.4 (31.), 39.4 (35.)
 Trefferlage: 0.03 mm rechts, 0.12 mm hoch
 Streuwert: 0.67, horizontal: 0.69, vertikal: 0.65



Ergebnis: **416.5** (397)
 Serien: 104.2 104.0 104.1 104.2
 Zähler: 37 3 0 0 0 0 0 0 0 0
 Innenzehner: 30
 Weitesten: 306 (8.), 273 (21.), 251 (31.)
 beste Teiler: 26.4 (29.), 37.0 (39.), 54.9 (40.)
 Trefferlage: 0.25 mm links, 0.05 mm hoch
 Streuwert: 1.08, horizontal: 1.26, vertikal: 0.86

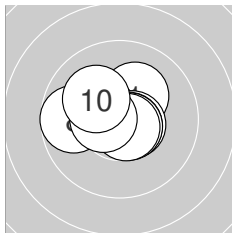
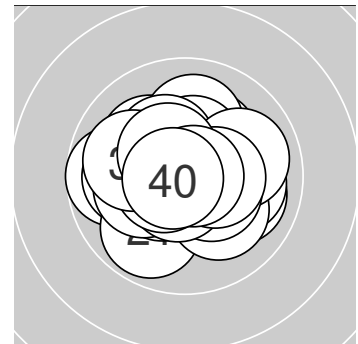

Serie 1:

10.2 *	10.6 *	10.6 *	10.7 *	10.6 *
10.5 *	10.7 *	9.7 ←	10.5 *	10.1 ↘

beste Teiler: 68.1 (7.), 75.8 (4.), 77.6 (5.)
 Trefferlage: 0.43 mm links, 0.17 mm hoch
 Streuwert: 1.08, horizontal: 1.34, vertikal: 0.74

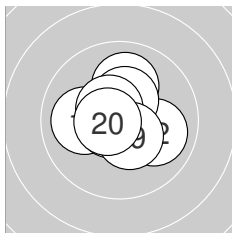

Serie 2:

10.0 ↑	10.0 ↘	10.6 *	10.4 *	10.0 ←
10.7 *	10.7 *	10.5 *	10.5 *	10.6 *

beste Teiler: 62.6 (17.), 65.2 (16.), 77.7 (13.)
 Trefferlage: 0.18 mm links, 0.24 mm hoch
 Streuwert: 1.11, horizontal: 1.21, vertikal: 1.00

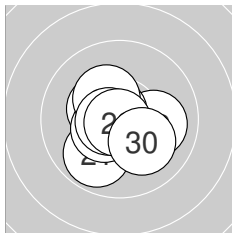

Serie 3:

9.9 ↙	10.0 →	10.7 *	10.4 *	10.5 *
10.7 *	10.3 *	10.7 *	10.8 *	10.1 ↘

beste Teiler: 26.4 (29.), 55.0 (23.), 62.3 (26.)
 Trefferlage: 0.27 mm links, 0.24 mm tief
 Streuwert: 1.14, horizontal: 1.22, vertikal: 1.05

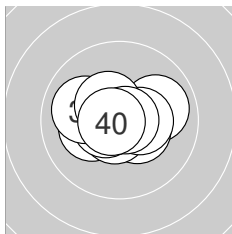

Serie 4:

9.9 →	10.2 *	10.4 *	10.7 *	10.6 *
10.0 ←	10.4 *	10.5 *	10.8 *	10.7 *

beste Teiler: 37.0 (39.), 54.9 (40.), 74.2 (34.)
 Trefferlage: 0.13 mm links, 0.02 mm hoch
 Streuwert: 1.12, horizontal: 1.46, vertikal: 0.60



Ergebnis: **422.2** (400)
Serien: 105.8 106.0 105.3 105.1
Zähler: 40 0 0 0 0 0 0 0 0 0
Innenzehner: 38
Weiteste: 206 (28.), 202 (37.), 154 (36.)
beste Teiler: 17.4 (39.), 19.7 (16.), 44.0 (17.)
Trefferlage: 0.15 mm links, 0.05 mm tief
Streuwert: 0.76, horizontal: 0.66, vertikal: 0.85

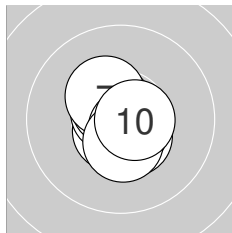
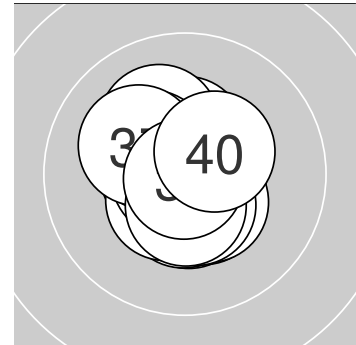

Serie 1:

10.6 *	10.5 *	10.7 *	10.7 *	10.7 *
10.6 *	10.3 *	10.7 *	10.4 *	10.6 *

beste Teiler: 58.4 (3.), 65.4 (4.), 69.6 (8.)
Trefferlage: 0.03 mm links, 0.08 mm tief
Streuwert: 0.71, horizontal: 0.57, vertikal: 0.82

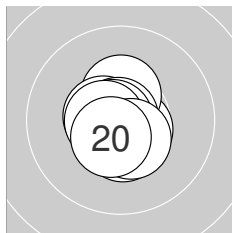

Serie 2:

10.6 *	10.4 *	10.6 *	10.6 *	10.5 *
10.9 *	10.8 *	10.6 *	10.5 *	10.5 *

beste Teiler: 19.7 (16.), 44.0 (17.), 84.8 (11.)
Trefferlage: 0.20 mm links, 0.28 mm tief
Streuwert: 0.68, horizontal: 0.56, vertikal: 0.79

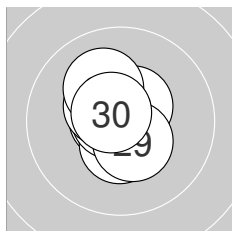

Serie 3:

10.7 *	10.7 *	10.6 *	10.5 *	10.7 *
10.5 *	10.4 *	10.1 ↖	10.4 *	10.7 *

beste Teiler: 51.6 (25.), 52.0 (21.), 63.7 (22.)
Trefferlage: 0.13 mm links, 0.27 mm hoch
Streuwert: 0.80, horizontal: 0.66, vertikal: 0.92

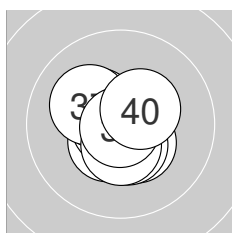

Serie 4:

10.4 *	10.7 *	10.5 *	10.8 *	10.5 *
10.3 *	10.1 ↖	10.5 *	10.9 *	10.4 *

beste Teiler: 17.4 (39.), 50.2 (34.), 71.8 (32.)
Trefferlage: 0.24 mm links, 0.14 mm tief
Streuwert: 0.90, horizontal: 0.89, vertikal: 0.90



Ergebnis: **415.1** (396)
 Serien: 105.3 104.3 104.9 100.6
 Zähler: 37 2 1 0 0 0 0 0 0
 Innenzehner: 31
 Weitester: 681 (33.), 305 (11.), 258 (25.)
 beste Teiler: 10.2 (29.), 13.4 (1.), 13.9 (18.)
 Trefferlage: 0.15 mm links, 0.16 mm hoch
 Streuwert: 1.30, horizontal: 1.69, vertikal: 0.72

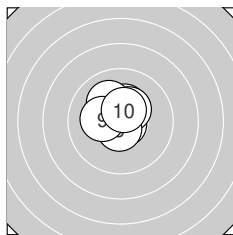
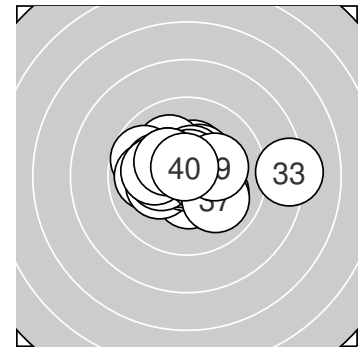

Serie 1:

10.9 *	10.6 *	10.8 *	10.8 *	10.3 *
10.4 *	10.1 ↖	10.7 *	10.2 *	10.5 *

beste Teiler: 13.4 (1.), 35.7 (3.), 46.0 (4.)
 Trefferlage: 0.21 mm links, 0.48 mm hoch
 Streuwert: 0.84, horizontal: 0.81, vertikal: 0.87

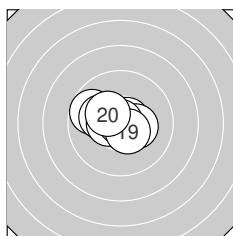

Serie 2:

9.7 ↖	10.1 ↖	10.5 *	10.8 *	10.5 *
10.7 *	10.3 *	10.9 *	10.5 *	10.3 *

beste Teiler: 13.9 (18.), 47.6 (14.), 71.5 (16.)
 Trefferlage: 0.30 mm links, 0.14 mm hoch
 Streuwert: 1.09, horizontal: 1.42, vertikal: 0.61

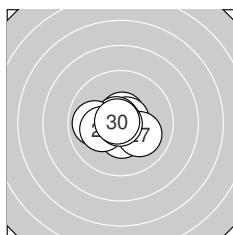

Serie 3:

10.5 *	10.6 *	10.7 *	10.7 *	9.9 ←
10.5 *	10.1 ↘	10.2 *	10.9 *	10.8 *

beste Teiler: 10.2 (29.), 38.9 (30.), 58.0 (24.)
 Trefferlage: 0.35 mm links, 0.14 mm tief
 Streuwert: 1.00, horizontal: 1.25, vertikal: 0.67

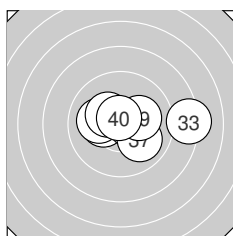

Serie 4:

10.1 ↖	10.2 *	8.2 →	10.3 *	10.5 *
10.1 ↖	10.0 ↘	10.3 *	10.2 *	10.7 *

beste Teiler: 63.0 (40.), 102.5 (35.), 159.4 (38.)
 Trefferlage: 0.24 mm rechts, 0.19 mm hoch
 Streuwert: 2.03, horizontal: 2.80, vertikal: 0.67

