

Ergebnis: **418.2** (399)
 Serien: 104.8 103.6 104.8 105.0
 Zähler: 39 1 0 0 0 0 0 0 0 0
 Innenzehner: 32
 Weitester: 264 (15.), 223 (20.), 209 (11.)
 beste Teiler: 10.4 (1.), 15.2 (8.), 36.7 (24.)
 Trefferlage: 0.07 mm links, 0.01 mm tief
 Streuwert: 0.99, horizontal: 1.27, vertikal: 0.59

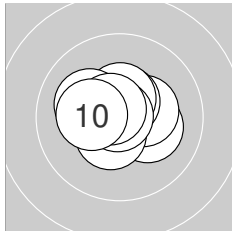
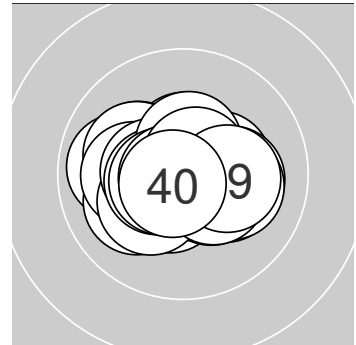

Serie 1:

10.9 *	10.2 *	10.3 *	10.5 *	10.5 *
10.5 *	10.1 ←	10.9 *	10.6 *	10.3 *

beste Teiler: 10.4 (1.), 15.2 (8.), 76.4 (9.)
 Trefferlage: 0.12 mm links, 0.25 mm hoch
 Streuwert: 0.96, horizontal: 1.17, vertikal: 0.69

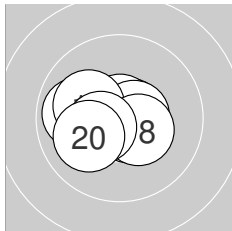

Serie 2:

10.1 ←	10.7 *	10.6 *	10.7 *	9.9 ←
10.6 *	10.1 ←	10.4 *	10.4 *	10.1 ←

beste Teiler: 52.0 (14.), 64.4 (12.), 84.9 (13.)
 Trefferlage: 0.64 mm links, 0.14 mm tief
 Streuwert: 1.11, horizontal: 1.45, vertikal: 0.63

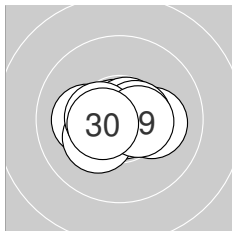

Serie 3:

10.1 ←	10.8 *	10.7 *	10.8 *	10.2 *
10.1 →	10.6 *	10.5 *	10.5 *	10.5 *

beste Teiler: 36.7 (24.), 41.4 (22.), 57.3 (23.)
 Trefferlage: 0.11 mm links, 0.11 mm tief
 Streuwert: 0.97, horizontal: 1.30, vertikal: 0.43

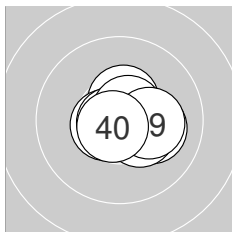

Serie 4:

10.5 *	10.6 *	10.6 *	10.8 *	10.5 *
10.6 *	10.1 →	10.4 *	10.2 *	10.7 *

beste Teiler: 48.3 (34.), 59.4 (40.), 77.1 (36.)
 Trefferlage: 0.59 mm rechts, 0.07 mm tief
 Streuwert: 0.80, horizontal: 0.98, vertikal: 0.57



Ergebnis: **411.0** (393)
 Serien: 103.2 102.4 103.1 102.3
 Zähler: 33 7 0 0 0 0 0 0 0 0
 Innenzehner: 28
 Weitester: 423 (34.), 297 (8.), 287 (23.)
 beste Teiler: 25.4 (10.), 58.5 (9.), 59.0 (5.)
 Trefferlage: 0.31 mm links, 0.30 mm hoch
 Streuwert: 1.31, horizontal: 1.57, vertikal: 0.99

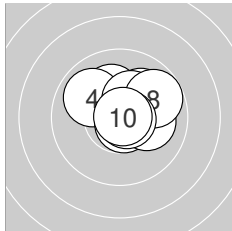
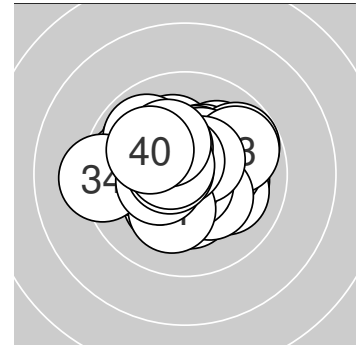

Serie 1:

10.5 *	10.1 ↗	10.2 *	9.9 ↘	10.7 *
10.3 *	10.1 →	9.8 ↗	10.7 *	10.9 *

beste Teiler: 25.4 (10.), 58.5 (9.), 59.0 (5.)
 Trefferlage: 0.66 mm rechts, 0.74 mm hoch
 Streuwert: 1.14, horizontal: 1.35, vertikal: 0.89

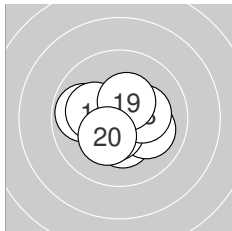

Serie 2:

10.4 *	10.2 *	9.8 ←	10.2 *	10.3 *
10.1 ↘	10.5 *	10.2 *	10.4 *	10.3 *

beste Teiler: 109.7 (17.), 137.6 (19.), 142.2 (11.)
 Trefferlage: 0.41 mm links, 0.31 mm tief
 Streuwert: 1.31, horizontal: 1.57, vertikal: 0.98

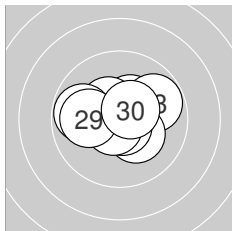

Serie 3:

10.4 *	10.5 *	9.8 ↗	10.4 *	10.3 *
10.7 *	9.8 ←	10.7 *	10.0 ←	10.5 *

beste Teiler: 59.5 (26.), 70.8 (28.), 105.5 (22.)
 Trefferlage: 0.17 mm links, 0.27 mm hoch
 Streuwert: 1.31, horizontal: 1.67, vertikal: 0.81

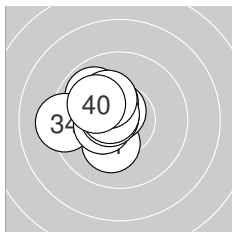

Serie 4:

10.2 *	10.7 *	9.9 ↘	9.3 ←	10.4 *
10.6 *	10.3 *	10.6 *	10.2 *	10.1 ↘

beste Teiler: 71.1 (32.), 79.8 (36.), 85.7 (38.)
 Trefferlage: 1.33 mm links, 0.50 mm hoch
 Streuwert: 1.12, horizontal: 1.15, vertikal: 1.10



Ergebnis: **420.2** (398)
 Serien: 104.9 106.9 103.5 104.9
 Zähler: 38 2 0 0 0 0 0 0 0 0
 Innenzehner: 35
 Weitester: 339 (25.), 300 (28.), 250 (38.)
 beste Teiler: 3.1 (15.), 5.0 (16.), 25.9 (37.)
 Trefferlage: 0.05 mm links, 0.37 mm hoch
 Streuwert: 0.95, horizontal: 1.14, vertikal: 0.71

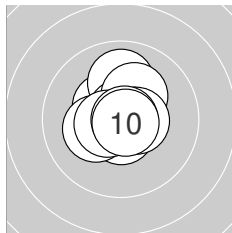
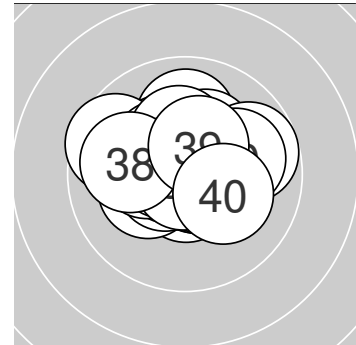

Serie 1:

10.6 *	10.4 *	10.2 *	10.0 ↑	10.8 *
10.2 *	10.6 *	10.5 *	10.8 *	10.8 *

beste Teiler: 26.0 (9.), 40.2 (10.), 45.2 (5.)
 Trefferlage: 0.08 mm links, 0.32 mm hoch
 Streuwert: 0.94, horizontal: 0.85, vertikal: 1.03

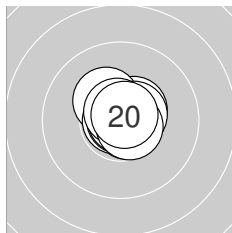

Serie 2:

10.5 *	10.3 *	10.7 *	10.8 *	10.9 *
10.9 *	10.6 *	10.7 *	10.7 *	10.8 *

beste Teiler: 3.1 (15.), 5.0 (16.), 32.0 (14.)
 Trefferlage: 0.15 mm rechts, 0.25 mm hoch
 Streuwert: 0.55, horizontal: 0.58, vertikal: 0.52

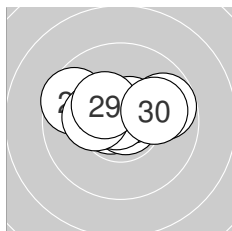

Serie 3:

10.7 *	10.5 *	10.8 *	10.6 *	9.6 ↖
10.8 *	10.3 *	9.8 ↗	10.4 *	10.0 →

beste Teiler: 34.0 (23.), 42.6 (26.), 66.1 (21.)
 Trefferlage: 0.17 mm links, 0.58 mm hoch
 Streuwert: 1.30, horizontal: 1.78, vertikal: 0.46

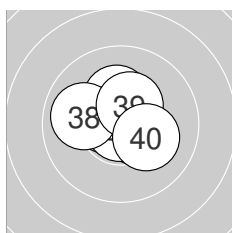

Serie 4:

10.6 *	10.5 *	10.3 *	10.6 *	10.7 *
10.7 *	10.9 *	10.0 ↖	10.4 *	10.2 *

beste Teiler: 25.9 (37.), 55.9 (35.), 61.5 (36.)
 Trefferlage: 0.11 mm links, 0.34 mm hoch
 Streuwert: 0.98, horizontal: 1.15, vertikal: 0.77



Ergebnis: **412.0** (394)
 Serien: 103.4 101.8 103.7 103.1
 Zähler: 34 6 0 0 0 0 0 0 0 0
 Innenzehner: 30
 Weitestе: 362 (11.), 361 (12.), 276 (27.)
 beste Teiler: 29.4 (5.), 39.2 (14.), 40.1 (8.)
 Trefferlage: 0.49 mm rechts, 0.07 mm hoch
 Streuwert: 1.26, horizontal: 1.25, vertikal: 1.27

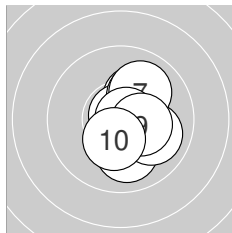
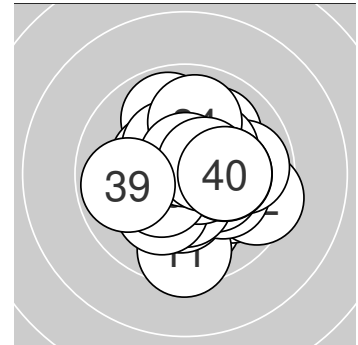

Serie 1:
 10.0 ↓ 10.2 * 10.7 * 10.0 ↘ 10.8 *
 10.1 ↗ 10.0 ↗ 10.8 * 10.4 * 10.4 *
 beste Teiler: 29.4 (5.), 40.1 (8.), 55.5 (3.)
 Trefferlage: 0.81 mm rechts, 0.01 mm hoch
 Streuwert: 1.14, horizontal: 0.79, vertikal: 1.40

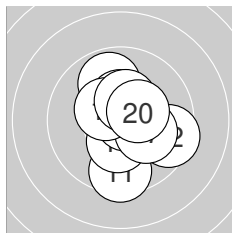

Serie 2:
 9.5 ↓ 9.5 ↘ 10.3 * 10.8 * 9.9 ↑
 10.4 * 10.2 * 10.4 * 10.4 * 10.4 *
 beste Teiler: 39.2 (14.), 133.0 (18.), 137.0 (16.)
 Trefferlage: 0.50 mm rechts, 0.02 mm tief
 Streuwert: 1.58, horizontal: 1.34, vertikal: 1.79

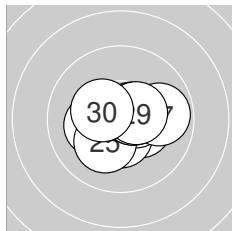

Serie 3:
 10.4 * 10.5 * 10.2 * 10.5 * 10.2 *
 10.6 * 9.8 → 10.6 * 10.5 * 10.4 *
 beste Teiler: 89.0 (26.), 98.6 (28.), 109.6 (24.)
 Trefferlage: 0.38 mm rechts, 0.14 mm tief
 Streuwert: 1.14, horizontal: 1.42, vertikal: 0.78

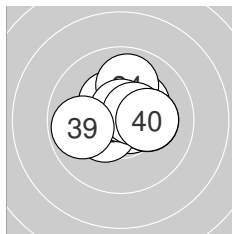

Serie 4:
 10.7 * 10.4 * 10.3 * 9.9 ↑ 10.2 *
 10.4 * 10.7 * 10.5 * 9.8 ← 10.2 *
 beste Teiler: 67.4 (31.), 69.1 (37.), 104.2 (38.)
 Trefferlage: 0.25 mm rechts, 0.46 mm hoch
 Streuwert: 1.24, horizontal: 1.45, vertikal: 0.97



Ergebnis: **408.3** (387)
 Serien: 101.7 100.4 103.0 103.2
 Zähler: 28 11 1 0 0 0 0 0 0 0
 Innenzehner: 20
 Weitesten: 514 (17.), 337 (35.), 322 (12.)
 beste Teiler: 8.0 (24.), 33.6 (39.), 46.6 (26.)
 Trefferlage: 0.16 mm rechts, 0.36 mm tief
 Streuwert: 1.52, horizontal: 1.61, vertikal: 1.42

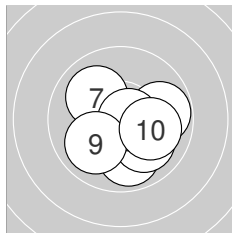
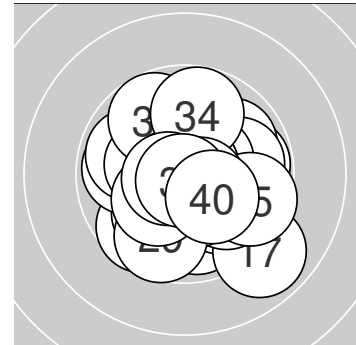

Serie 1:

10.5 *	10.0 ↓	9.9 ↓	10.7 *	9.8 →
10.0 ↘	10.0 ↖	10.7 *	10.0 ✓	10.1 →

beste Teiler: 59.0 (8.), 60.4 (4.), 120.6 (1.)
 Trefferlage: 0.60 mm rechts, 0.81 mm tief
 Streuwert: 1.39, horizontal: 1.48, vertikal: 1.29

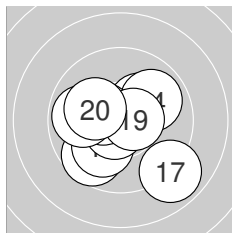

Serie 2:

10.2 *	9.7 ✓	10.0 ✓	9.9 ↗	10.7 *
10.4 *	8.9 ↘	9.9 ←	10.6 *	10.1 ↖

beste Teiler: 72.2 (15.), 91.1 (19.), 133.7 (16.)
 Trefferlage: 0.15 mm links, 0.44 mm tief
 Streuwert: 1.89, horizontal: 2.07, vertikal: 1.70

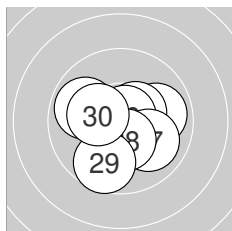

Serie 3:

9.9 →	9.9 ←	10.6 *	10.9 *	10.5 *
10.8 *	10.0 ↘	10.4 *	9.7 ↓	10.3 *

beste Teiler: 8.0 (24.), 46.6 (26.), 86.6 (23.)
 Trefferlage: 0.01 mm rechts, 0.32 mm tief
 Streuwert: 1.42, horizontal: 1.60, vertikal: 1.23

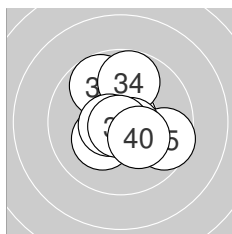

Serie 4:

10.8 *	9.8 ↘	10.7 *	9.8 ↑	9.6 →
10.6 *	10.2 *	10.6 *	10.8 *	10.3 *

beste Teiler: 33.6 (39.), 46.6 (31.), 53.4 (33.)
 Trefferlage: 0.19 mm rechts, 0.12 mm hoch
 Streuwert: 1.43, horizontal: 1.38, vertikal: 1.48



Ergebnis: **411.8** (392)
 Serien: 103.5 101.1 103.5 103.7
 Zähler: 32 8 0 0 0 0 0 0 0 0
 Innenzehner: 26
 Weitesten: 324 (26.), 314 (19.), 311 (20.)
 beste Teiler: 6.4 (18.), 23.0 (3.), 33.1 (22.)
 Trefferlage: 0.50 mm links, 0.21 mm tief
 Streuwert: 1.27, horizontal: 1.43, vertikal: 1.08

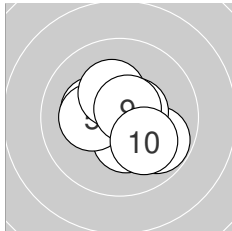
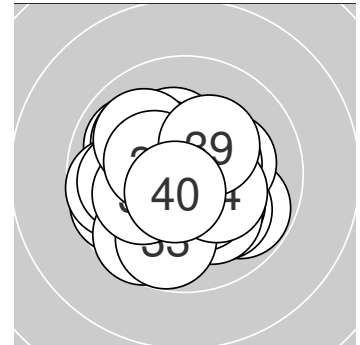

Serie 1:

10.3 *	10.5 *	10.9 *	10.3 *	10.2 *
9.8 ↘	10.5 *	10.3 *	10.6 *	10.1 ↘

beste Teiler: 23.0 (3.), 77.1 (9.), 106.6 (7.)
 Trefferlage: 0.07 mm rechts, 0.11 mm tief
 Streuwert: 1.24, horizontal: 1.40, vertikal: 1.06

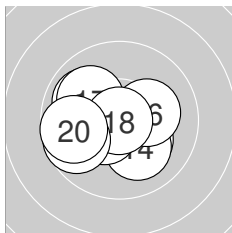

Serie 2:

9.9 ↘	9.9 ←	10.2 *	10.1 ↘	10.5 *
10.2 *	10.0 ↘	10.9 *	9.7 ←	9.7 ←

beste Teiler: 6.4 (18.), 122.6 (15.), 184.5 (13.)
 Trefferlage: 0.94 mm links, 0.31 mm tief
 Streuwert: 1.53, horizontal: 1.88, vertikal: 1.07

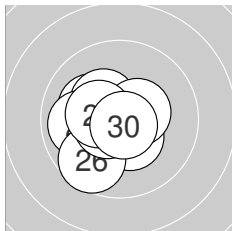

Serie 3:

10.1 ↘	10.8 *	10.4 *	10.3 *	9.9 ←
9.7 ↙	10.6 *	10.5 *	10.4 *	10.8 *

beste Teiler: 33.1 (22.), 48.2 (30.), 89.4 (27.)
 Trefferlage: 0.76 mm links, 0.23 mm tief
 Streuwert: 1.15, horizontal: 1.21, vertikal: 1.08

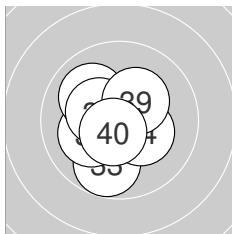

Serie 4:

10.8 *	10.7 *	9.8 ↙	10.3 *	10.1 ←
10.7 *	10.0 ↘	10.4 *	10.3 *	10.6 *

beste Teiler: 40.2 (31.), 52.0 (36.), 64.0 (32.)
 Trefferlage: 0.37 mm links, 0.20 mm tief
 Streuwert: 1.20, horizontal: 1.13, vertikal: 1.27



Ergebnis: **402.3** (385)
 Serien: 99.7 100.9 101.1 100.6
 Zähler: 26 13 1 0 0 0 0 0 0 0
 Innenzehner: 21
 Weitester: 556 (2.), 494 (37.), 477 (11.)
 beste Teiler: 18.3 (40.), 82.7 (24.), 93.0 (29.)
 Trefferlage: 0.04 mm rechts, 0.52 mm tief
 Streuwert: 1.76, horizontal: 2.12, vertikal: 1.30

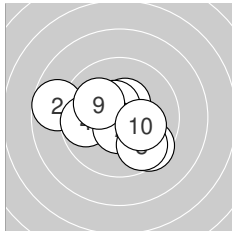
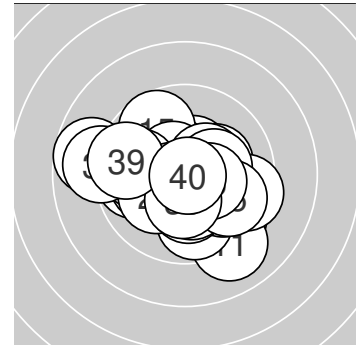

Serie 1:

10.2 *	8.7 ←	10.4 *	9.8 ←	10.5 *
9.5 ↘	10.6 *	9.7 ↘	10.1 ↘	10.2 *

beste Teiler: 94.6 (7.), 108.7 (5.), 127.3 (3.)
 Trefferlage: 0.24 mm links, 0.36 mm tief
 Streuwert: 2.06, horizontal: 2.53, vertikal: 1.44

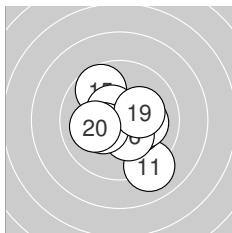

Serie 2:

9.0 ↘	10.3 *	10.4 *	10.1 →	9.7 ↘
10.3 *	10.5 *	10.3 *	10.2 *	10.1 ←

beste Teiler: 108.7 (17.), 127.6 (13.), 153.8 (16.)
 Trefferlage: 0.40 mm rechts, 0.31 mm tief
 Streuwert: 1.72, horizontal: 1.72, vertikal: 1.71

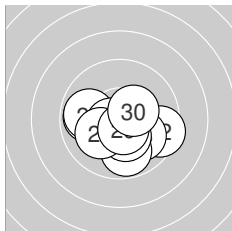

Serie 3:

9.9 ←	9.5 →	9.9 ←	10.6 *	10.0 ↘
9.8 ↓	10.3 *	10.1 ↗	10.6 *	10.4 *

beste Teiler: 82.7 (24.), 93.0 (29.), 141.8 (30.)
 Trefferlage: 0.02 mm rechts, 0.78 mm tief
 Streuwert: 1.59, horizontal: 2.00, vertikal: 1.05

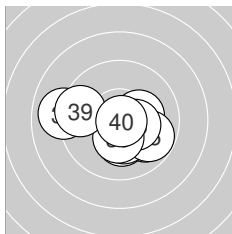

Serie 4:

9.9 ↘	10.2 *	10.3 *	10.3 *	9.8 ↘
10.4 *	9.0 ←	10.3 *	9.5 ←	10.9 *

beste Teiler: 18.3 (40.), 143.2 (36.), 152.3 (38.)
 Trefferlage: 0.01 mm rechts, 0.64 mm tief
 Streuwert: 1.85, horizontal: 2.42, vertikal: 1.01

