

Ergebnis: **183.6** (174)
 Serien: 93.2 90.4
 Zähler: 3 12 3 0 2 0 0 0 0 0
 Innenzehner: 3
 weiteste: 1087 (16), 1041 (13), 596 (20)
 beste Teiler 77.3 (17.) 124.0 (8.) 126.4 (15.)
 Trefferlage 0.11 mm rechts, 0.30 mm tief
 Streuwert 3.69, horizontal: 4.20, vertikal: 3.09

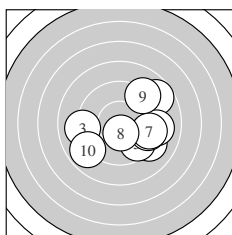

Serie 1:
 8.7 ↗ 9.2 ↘ 9.1 ← 9.1 → 9.6 ↘
 9.5 → 9.4 → 10.5 * 9.2 ↗ 8.9 ↙
 beste Teiler 124.0 (8.) 334.9 (5.) 373.1 (6.)
 Trefferlage 1.67 mm rechts, 0.62 mm tief
 Streuwert 2.90, horizontal: 3.41, vertikal: 2.27

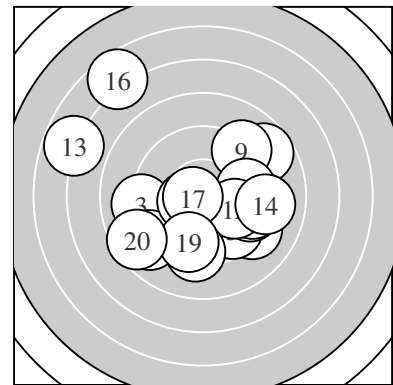
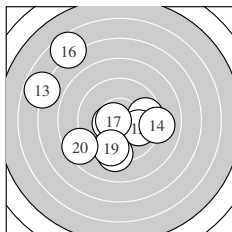

Serie 2:
 9.6 → 9.9 → 6.8 ↖ 9.1 → 10.4 *
 6.6 ↘ 10.6 * 9.3 ↓ 9.5 ↓ 8.6 ↙
 beste Teiler 77.3 (17.) 126.4 (15.) 256.6 (12.)
 Trefferlage 1.44 mm links, 0.01 mm hoch
 Streuwert 4.18, horizontal: 4.49, vertikal: 3.85

Unterschrift des Schützen

Ergebnis: **182.6** (174)
 Serien: 89.2 93.4
 Zähler: 6 6 4 4 0 0 0 0 0 0
 Innenzehner: 5
 weiteste: 964 (5), 924 (15), 911 (4)
 beste Teiler 99.8 (11.) 132.0 (6.) 162.6 (20.)
 Trefferlage 0.72 mm links, 1.02 mm tief
 Streuwert 3.77, horizontal: 4.21, vertikal: 3.27

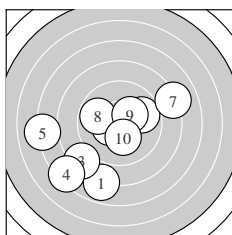
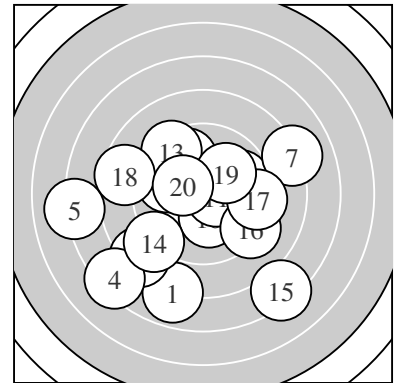

Serie 1:
 7.9 ↘ 9.8 ↗ 8.3 ↙ 7.3 ↖ 7.1 ←
 10.4 * 8.1 ↗ 9.8 ← 10.3 * 10.2 *
 beste Teiler 132.0 (6.) 166.3 (9.) 180.4 (10.)
 Trefferlage 1.59 mm links, 1.59 mm tief
 Streuwert 4.12, horizontal: 4.71, vertikal: 3.43

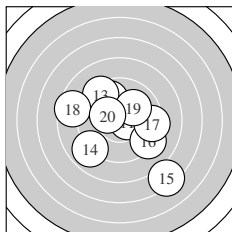

Serie 2:
 10.6 * 9.8 ↖ 9.4 ↖ 8.9 ↙ 7.3 ↘
 9.2 ↘ 9.3 → 8.6 ← 10.0 ↗ 10.3 *
 beste Teiler 99.8 (11.) 162.6 (20.) 230.0 (19.)
 Trefferlage 0.14 mm rechts, 0.44 mm tief
 Streuwert 3.45, horizontal: 3.69, vertikal: 3.18

Unterschrift des Schützen

Ergebnis: **181.6** (175)
 Serien: 90.8 90.8
 Zähler: 6 8 3 2 0 1 0 0 0 0
 Innenzehner: 2
 weiteste: 1348 (3), 1000 (18), 831 (8)
 beste Teiler 79.3 (15.) 91.5 (6.) 208.3 (12.)
 Trefferlage 0.47 mm rechts, 0.56 mm tief
 Streuwert 4.04, horizontal: 5.09, vertikal: 2.58

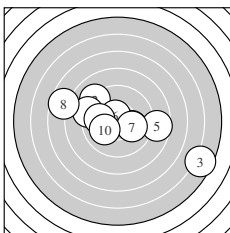
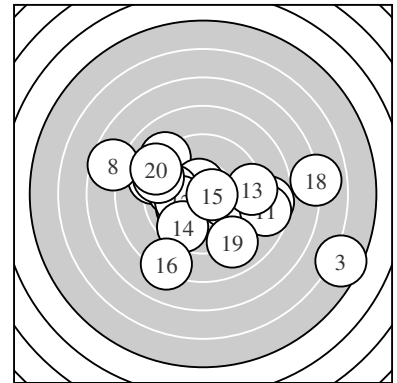

Serie 1:
 10.1 → 9.1 ↖ 5.6 ↘ 9.1 ← 8.6 →
 10.6 * 10.1 → 7.6 ← 9.9 ← 10.1 ←
 beste Teiler 91.5 (6.) 218.1 (1.) 224.0 (7.)
 Trefferlage 0.15 mm rechts, 0.10 mm tief
 Streuwert 4.41, horizontal: 5.70, vertikal: 2.52

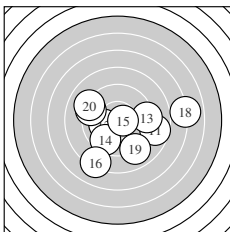

Serie 2:
 8.7 → 10.1 ← 9.2 → 9.6 ↙ 10.6 *
 8.2 ↙ 9.3 ↖ 7.0 → 9.0 ↘ 9.1 ↖
 beste Teiler 79.3 (15.) 208.3 (12.) 340.4 (14.)
 Trefferlage 0.79 mm rechts, 1.02 mm tief
 Streuwert 3.82, horizontal: 4.69, vertikal: 2.69

Unterschrift des Schützen

Ergebnis: **188.3** (178)
 Serien: 93.7 94.6
 Zähler: 4 10 6 0 0 0 0 0 0 0
 Innenzehner: 3
 weiteste: 689 (7), 582 (8), 572 (15)
 beste Teiler 97.4 (1.) 119.2 (6.) 126.4 (18.)
 Trefferlage 1.11 mm links, 2.10 mm hoch
 Streuwert 2.49, horizontal: 2.23, vertikal: 2.72

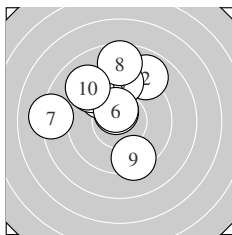
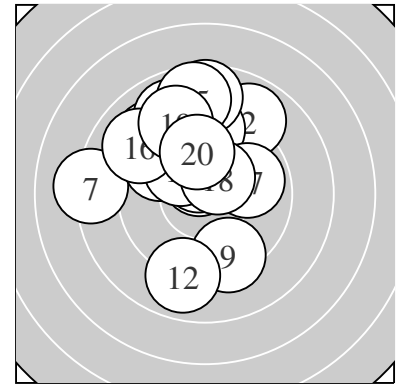

Serie 1:
 10.6 * 8.9 ↗ 9.4 ↑ 9.7 ↘ 9.3 ↖
 10.5 * 8.2 ← 8.6 ↑ 9.4 ↓ 9.1 ↗
 beste Teiler 97.4 (1.) 119.2 (6.) 307.0 (4.)
 Trefferlage 1.12 mm links, 2.19 mm hoch
 Streuwert 2.67, horizontal: 2.69, vertikal: 2.66

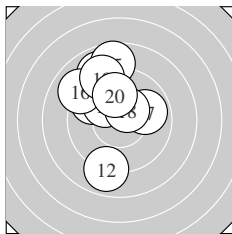

Serie 2:
 9.7 ↖ 8.9 ↓ 10.1 ↖ 8.9 ↗ 8.7 ↑
 9.0 ↖ 9.9 → 10.4 * 9.1 ↗ 9.9 ↑
 beste Teiler 126.4 (18.) 210.7 (13.) 256.5 (20.)
 Trefferlage 1.11 mm links, 2.02 mm hoch
 Streuwert 2.43, horizontal: 1.81, vertikal: 2.93

Unterschrift des Schützen

Ergebnis: **187.3** (178)
 Serien: 92.2 95.1
 Zähler: 9 3 6 1 1 0 0 0 0 0
 Innenzehner: 8
 weiteste: 1066 (19), 810 (7), 684 (5)
 beste Teiler 79.4 (6.) 101.2 (18.) 101.4 (2.)
 Trefferlage 2.29 mm rechts, 0.55 mm tief
 Streuwert 3.07, horizontal: 3.97, vertikal: 1.76

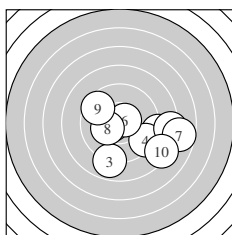
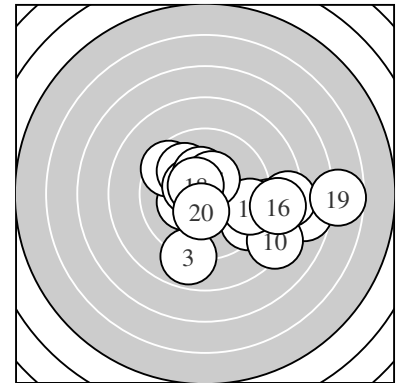

Serie 1:
 8.9 → 10.5 * 8.9 ↓ 9.3 ↘ 8.2 →
 10.6 * 7.7 → 10.3 * 9.5 ↖ 8.3 ↘
 beste Teiler 79.4 (6.) 101.4 (2.) 175.8 (8.)
 Trefferlage 2.28 mm rechts, 1.27 mm tief
 Streuwert 3.15, horizontal: 3.97, vertikal: 2.02

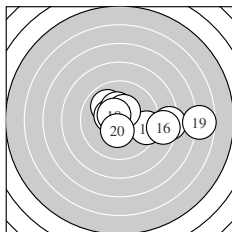

Serie 2:
 10.0 ↖ 10.4 * 8.3 → 9.5 → 10.3 *
 8.6 → 10.4 * 10.5 * 6.7 → 10.4 *
 beste Teiler 101.2 (18.) 129.7 (17.) 132.8 (12.)
 Trefferlage 2.30 mm rechts, 0.17 mm hoch
 Streuwert 3.06, horizontal: 4.18, vertikal: 1.15

Unterschrift des Schützen

Ergebnis: **179.2** (169)
 Serien: 90.7 88.5
 Zähler: 2 7 9 2 0 0 0 0 0 0
 Innenzehner: 1
 weiteste: 969 (20), 866 (13), 722 (16)
 beste Teiler 144.2 (19.) 224.3 (12.) 252.1 (4.)
 Trefferlage 2.36 mm links, 0.58 mm tief
 Streuwert 3.54, horizontal: 3.67, vertikal: 3.40

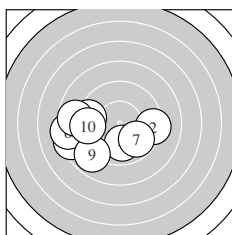
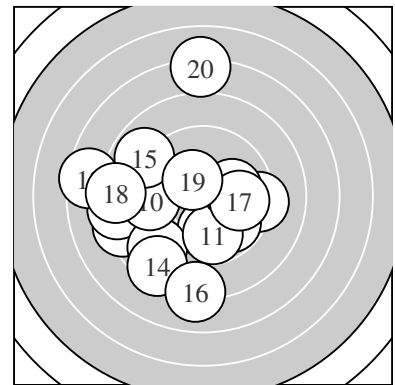

Serie 1:
 8.6 ← 9.3 → 9.4 ← 9.9 ↓ 8.4 ←
 8.3 ← 9.8 ↘ 8.7 ← 8.9 ✓ 9.4 ←
 beste Teiler 252.1 (4.) 289.3 (7.) 394.8 (3.)
 Trefferlage 2.85 mm links, 1.19 mm tief
 Streuwert 2.84, horizontal: 3.74, vertikal: 1.46

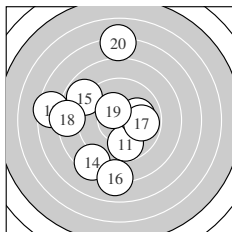

Serie 2:
 9.8 ↓ 10.1 → 7.5 ← 8.4 ✓ 8.9 ↖
 8.1 ↓ 9.9 → 8.3 ← 10.4 * 7.1 ↑
 beste Teiler 144.2 (19.) 224.3 (12.) 275.2 (17.)
 Trefferlage 1.88 mm links, 0.01 mm hoch
 Streuwert 4.21, horizontal: 3.73, vertikal: 4.64

Unterschrift des Schützen

Ergebnis: **190.1** (182)
 Serien: 94.6 95.5
 Zähler: 7 9 3 1 0 0 0 0 0 0
 Innenzehner: 3
 weiteste: 785 (12), 632 (8), 516 (16)
 beste Teiler 81.0 (19.) 162.9 (13.) 172.2 (5.)
 Trefferlage 1.90 mm rechts, 0.00 mm
 Streuwert 2.56, horizontal: 2.98, vertikal: 2.06

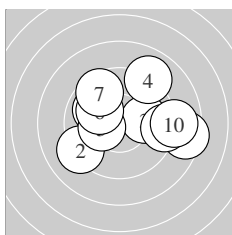
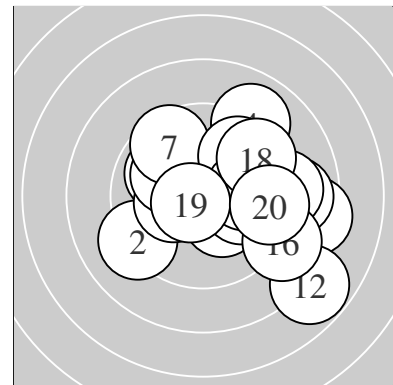

Serie 1:
 9.9 ↘ 9.2 ↙ 10.0 → 9.0 ↗ 10.3 *
 10.1 ↘ 9.6 ↘ 8.4 → 9.2 → 8.9 →
 beste Teiler 172.2 (5.) 222.4 (6.) 237.5 (3.)
 Trefferlage 0.93 mm rechts, 0.53 mm hoch
 Streuwert 2.88, horizontal: 3.59, vertikal: 1.93

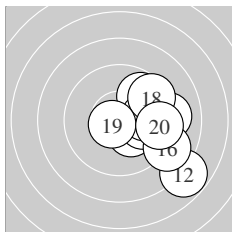

Serie 2:
 9.1 → 7.8 ↘ 10.3 * 10.1 → 9.8 ↗
 8.9 ↘ 10.0 → 9.5 ↗ 10.6 * 9.4 →
 beste Teiler 81.0 (19.) 162.9 (13.) 223.6 (14.)
 Trefferlage 2.87 mm rechts, 0.51 mm tief
 Streuwert 2.04, horizontal: 1.94, vertikal: 2.14

Unterschrift des Schützen

Ergebnis: **200.7** (191)
 Serien: 98.7 102.0
 Zähler: 11 9 0 0 0 0 0 0 0 0
 Innenzehner: 9
 weiteste: 447 (13), 426 (8), 384 (7)
 beste Teiler 63.1 (11.) 73.6 (16.) 81.6 (15.)
 Trefferlage 0.11 mm rechts, 0.09 mm hoch
 Streuwert 1.87, horizontal: 2.40, vertikal: 1.10

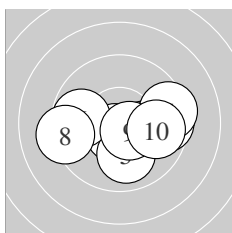
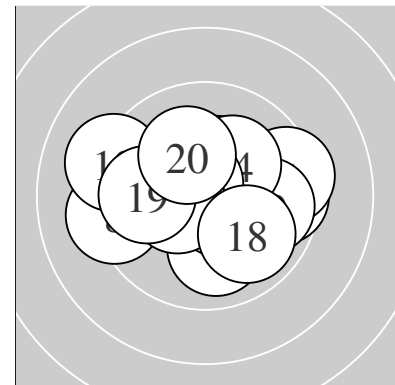

Serie 1:
 10.2 * 10.6 * 9.5 → 9.6 → 10.0 ↓
 9.8 ← 9.4 → 9.2 ← 10.6 * 9.8 →
 beste Teiler 83.6 (2.) 94.8 (9.) 188.5 (1.)
 Trefferlage 0.90 mm rechts, 0.38 mm tief
 Streuwert 2.05, horizontal: 2.75, vertikal: 0.92

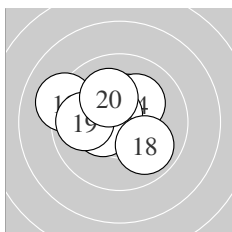

Serie 2:
 10.7 * 10.3 * 9.2 ↖ 10.2 * 10.6 *
 10.7 * 10.4 * 9.9 ↘ 9.9 ← 10.1 ↗
 beste Teiler 63.1 (11.) 73.6 (16.) 81.6 (15.)
 Trefferlage 0.68 mm links, 0.56 mm hoch
 Streuwert 1.48, horizontal: 1.79, vertikal: 1.10

Unterschrift des Schützen

Ergebnis: **189.2** (180)
 Serien: 91.9 97.3
 Zähler: 5 10 5 0 0 0 0 0 0 0
 Innenzehner: 4
 weiteste: 684 (4), 652 (1), 639 (8)
 beste Teiler 98.3 (7.) 112.4 (19.) 141.2 (11.)
 Trefferlage 0.66 mm rechts, 1.48 mm hoch
 Streuwert 2.77, horizontal: 3.57, vertikal: 1.63

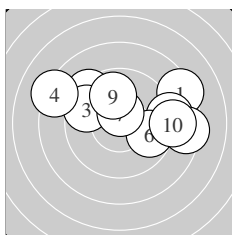
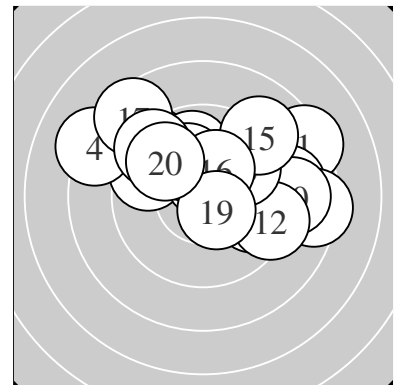

Serie 1:
 8.3 ↗ 9.3 ↘ 9.6 ↖ 8.2 ↖ 9.0 →
 9.7 → 10.6 * 8.4 → 9.9 ↑ 8.9 →
 beste Teiler 98.3 (7.) 271.4 (9.) 304.2 (6.)
 Trefferlage 1.20 mm rechts, 1.27 mm hoch
 Streuwert 3.30, horizontal: 4.41, vertikal: 1.53

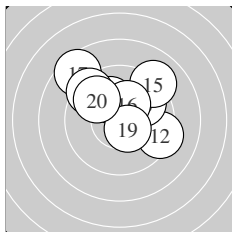

Serie 2:
 10.4 * 9.3 → 9.9 ↗ 10.1 ↘ 9.1 ↗
 10.3 * 8.5 ↘ 9.4 ↘ 10.5 * 9.8 ↘
 beste Teiler 112.4 (19.) 141.2 (11.) 170.0 (16.)
 Trefferlage 0.12 mm rechts, 1.69 mm hoch
 Streuwert 2.23, horizontal: 2.61, vertikal: 1.78

Unterschrift des Schützen

Ergebnis: **188.2** (178)
 Serien: 94.0 94.2
 Zähler: 6 8 5 0 1 0 0 0 0 0
 Innenzehner: 3
 weiteste: 1034 (9), 707 (17), 568 (8)
 beste Teiler 111.3 (2.) 130.1 (13.) 150.1 (14.)
 Trefferlage 0.01 mm rechts, 0.51 mm hoch
 Streuwert 3.19, horizontal: 3.43, vertikal: 2.92

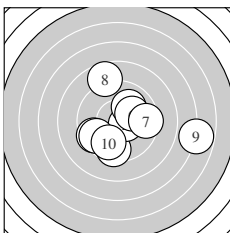
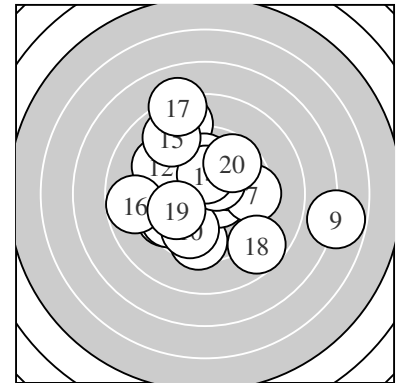

Serie 1:
 9.5 ↓ 10.5 * 9.5 ↙ 10.0 ↗ 9.6 ↙
 10.1 ↗ 9.5 → 8.7 ↕ 6.8 → 9.8 ↓
 beste Teiler 111.3 (2.) 212.0 (6.) 233.8 (4.)
 Trefferlage 0.90 mm rechts, 0.41 mm tief
 Streuwert 3.34, horizontal: 3.90, vertikal: 2.67

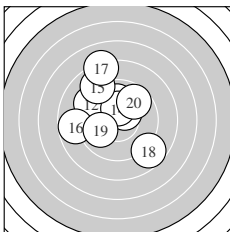

Serie 2:
 10.0 ↑ 9.3 ↘ 10.4 * 10.4 * 8.9 ↖
 8.8 ← 8.1 ↕ 8.7 ↘ 9.9 ↙ 9.7 ↗
 beste Teiler 130.1 (13.) 150.1 (14.) 244.1 (11.)
 Trefferlage 0.88 mm links, 1.45 mm hoch
 Streuwert 2.90, horizontal: 2.81, vertikal: 2.99

Unterschrift des Schützen

Ergebnis: **202.0** (193)
 Serien: 101.0 101.0
 Zähler: 14 5 1 0 0 0 0 0 0 0
 Innenzehner: 11
 weiteste: 515 (8), 430 (11), 406 (5)
 beste Teiler 24.3 (9.) 52.6 (18.) 86.1 (7.)
 Trefferlage 0.05 mm rechts, 0.45 mm hoch
 Streuwert 1.79, horizontal: 1.85, vertikal: 1.72

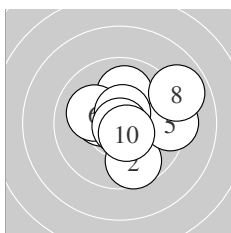
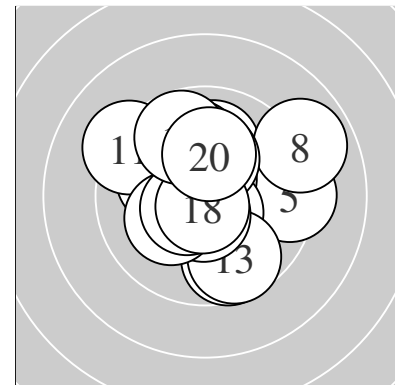

Serie 1:
 10.4 * 9.7 ↓ 10.5 * 10.0 ↑ 9.3 →
 10.1 ↖ 10.6 * 8.9 ↗ 10.9 * 10.6 *
 beste Teiler 24.3 (9.) 86.1 (7.) 97.0 (10.)
 Trefferlage 0.70 mm rechts, 0.38 mm hoch
 Streuwert 1.86, horizontal: 2.11, vertikal: 1.57

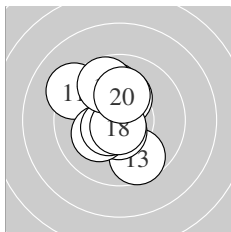

Serie 2:
 9.2 ↖ 10.2 * 9.7 ↓ 10.6 * 10.2 *
 10.5 * 10.0 ↑ 10.7 * 9.7 ↑ 10.2 *
 beste Teiler 52.6 (18.) 91.2 (14.) 105.1 (16.)
 Trefferlage 0.59 mm links, 0.52 mm hoch
 Streuwert 1.68, horizontal: 1.36, vertikal: 1.95

Unterschrift des Schützen

Ergebnis: **160.1** (153)
 Serien: 79.0 81.1
 Zähler: 1 3 10 4 0 1 0 1 0 0
 Innenzehner: 1
 weiteste: 1938 (8), 1268 (20), 964 (11)
 beste Teiler 91.1 (14.) 330.6 (7.) 341.2 (4.)
 Trefferlage 2.12 mm links, 0.95 mm hoch
 Streuwert 5.77, horizontal: 5.16, vertikal: 6.32

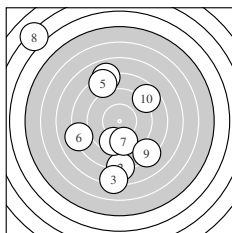
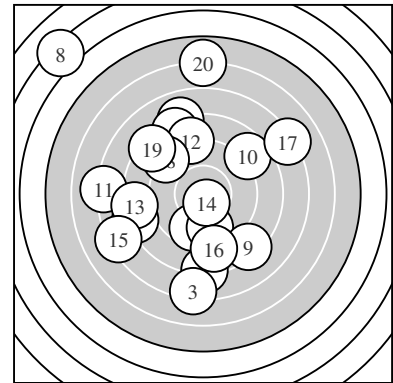

Serie 1:

8.0 ↑ 8.0 ↓ 7.2 ↓ 9.6 ↓ 8.3 ↖
 8.1 ← 9.6 ↓ 3.2 ↘ 8.3 ↘ 8.7 ↗

beste Teiler 330.6 (7.) 341.2 (4.) 565.4 (10.)
 Trefferlage 1.77 mm links, 0.04 mm tief
 Streuwert 6.40, horizontal: 5.31, vertikal: 7.33

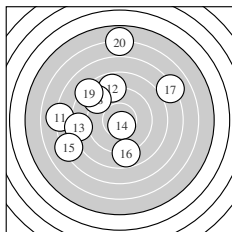

Serie 2:

7.1 ← 8.8 ↑ 8.3 ← 10.6 * 7.2 ↖
 8.8 ↓ 7.1 ↗ 9.0 ↘ 8.3 ↘ 5.9 ↑

beste Teiler 91.1 (14.) 491.8 (18.) 528.7 (12.)
 Trefferlage 2.46 mm links, 1.94 mm hoch
 Streuwert 5.30, horizontal: 5.27, vertikal: 5.32

Unterschrift des Schützen

Ergebnis: **196.4** (188)
 Serien: 99.4 97.0
 Zähler: 9 10 1 0 0 0 0 0 0 0
 Innenzehner: 7
 weiteste: 582 (18), 449 (16), 440 (7)
 beste Teiler 53.8 (15.) 60.8 (10.) 63.6 (3.)
 Trefferlage 0.75 mm links, 0.40 mm hoch
 Streuwert 2.25, horizontal: 1.99, vertikal: 2.48

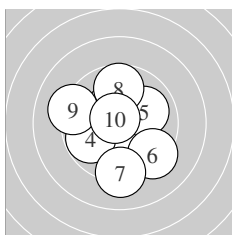
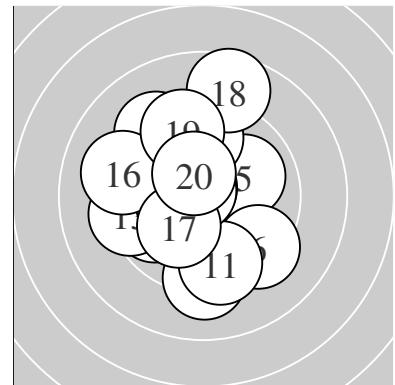

Serie 1:
 10.4 * 10.4 * 10.7 * 9.8 ↙ 10.0 ↗
 9.3 ↘ 9.2 ↓ 9.7 ↑ 9.2 ↖ 10.7 *
 beste Teiler 60.8 (10.) 63.6 (3.) 135.3 (2.)
 Trefferlage 0.19 mm links, 0.04 mm tief
 Streuwert 2.15, horizontal: 2.06, vertikal: 2.23

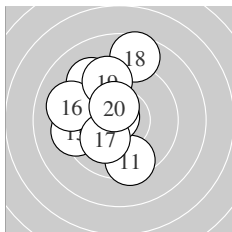

Serie 2:
 9.5 ↓ 9.3 ↖ 9.3 ← 10.4 * 10.7 *
 9.2 ↖ 10.1 ↗ 8.6 ↑ 9.5 ↑ 10.4 *
 beste Teiler 53.8 (15.) 130.5 (20.) 142.3 (14.)
 Trefferlage 1.31 mm links, 0.86 mm hoch
 Streuwert 2.34, horizontal: 1.85, vertikal: 2.74

Unterschrift des Schützen

Ergebnis: **178.8** (171)
 Serien: 86.8 92.0
 Zähler: 5 7 4 2 2 0 0 0 0 0
 Innenzehner: 3
 weiteste: 1246 (6), 1026 (7), 803 (11)
 beste Teiler 8.6 (17.) 177.0 (14.) 195.7 (5.)
 Trefferlage 1.13 mm links, 0.32 mm tief
 Streuwert 4.14, horizontal: 5.13, vertikal: 2.83

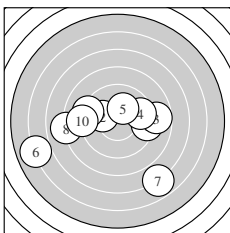
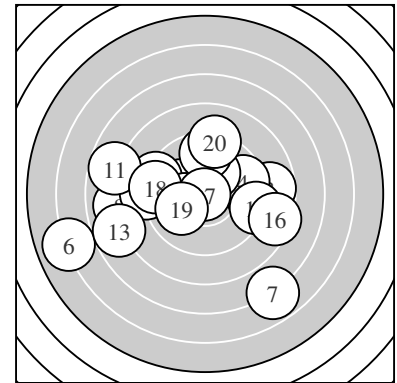

Serie 1:
 9.3 → 10.1 ← 8.7 → 9.6 → 10.2 *
 6.0 ← 6.8 ↘ 8.0 ← 9.2 ← 8.9 ←
 beste Teiler 195.7 (5.) 223.8 (2.) 344.3 (4.)
 Trefferlage 1.08 mm links, 0.88 mm tief
 Streuwert 4.77, horizontal: 5.96, vertikal: 3.18

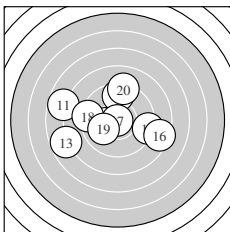

Serie 2:
 7.7 ← 9.1 → 7.8 ← 10.2 * 9.6 ↑
 8.4 → 10.9 * 9.2 ← 10.0 ← 9.1 ↑
 beste Teiler 8.6 (17.) 177.0 (14.) 237.2 (19.)
 Trefferlage 1.19 mm links, 0.24 mm hoch
 Streuwert 3.61, horizontal: 4.48, vertikal: 2.46

Unterschrift des Schützen

Ergebnis: **182.4** (174)
 Serien: 93.5 88.9
 Zähler: 7 3 7 3 0 0 0 0 0 0
 Innenzehner: 4
 weiteste: 923 (1), 821 (16), 778 (7)
 beste Teiler 102.4 (2.) 165.0 (10.) 174.7 (11.)
 Trefferlage 2.64 mm rechts, 2.35 mm hoch
 Streuwert 2.78, horizontal: 2.99, vertikal: 2.55

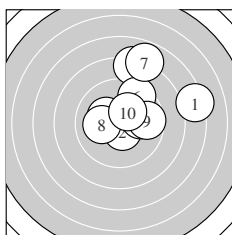
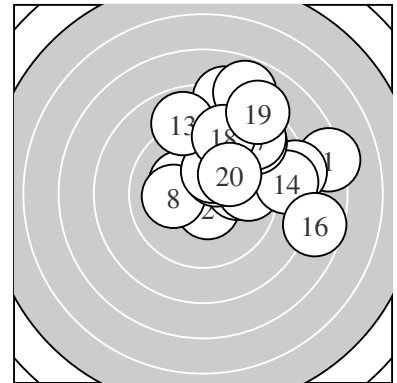

Serie 1:
 7.3 → 10.5 * 8.2 ↑ 10.2 * 10.0 →
 9.4 ↗ 7.8 ↑ 10.1 ← 9.7 → 10.3 *
 beste Teiler 102.4 (2.) 165.0 (10.) 178.8 (4.)
 Trefferlage 1.86 mm rechts, 2.13 mm hoch
 Streuwert 2.94, horizontal: 3.05, vertikal: 2.83

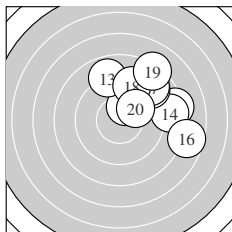

Serie 2:
 10.3 * 8.3 → 8.9 ↑ 8.6 → 8.9 ↗
 7.7 → 8.8 ↗ 9.2 ↑ 8.2 ↗ 10.0 ↗
 beste Teiler 174.7 (11.) 233.2 (20.) 432.0 (18.)
 Trefferlage 3.41 mm rechts, 2.56 mm hoch
 Streuwert 2.63, horizontal: 2.87, vertikal: 2.37

Unterschrift des Schützen

Ergebnis: **199.6** (188)
 Serien: 97.7 101.9
 Zähler: 10 9 0 1 0 0 0 0 0 0
 Innenzehner: 9
 weiteste: 755 (2), 344 (1), 341 (3)
 beste Teiler 79.1 (18.) 105.3 (20.) 111.8 (11.)
 Trefferlage 0.43 mm rechts, 0.21 mm hoch
 Streuwert 2.03, horizontal: 2.23, vertikal: 1.81

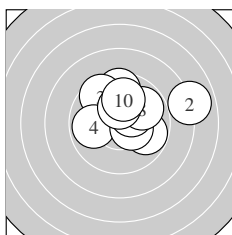
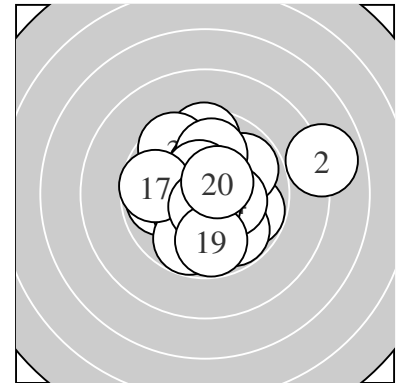

Serie 1:
 9.6 ↑ 7.9 → 9.6 ↘ 9.9 ← 9.8 ↗
 10.4 * 10.4 * 9.8 ↗ 10.3 * 10.0 ↑
 beste Teiler 135.6 (6.) 148.3 (7.) 163.0 (9.)
 Trefferlage 1.04 mm rechts, 1.28 mm hoch
 Streuwert 2.23, horizontal: 2.76, vertikal: 1.52

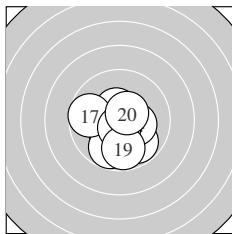

Serie 2:
 10.5 * 10.4 * 9.8 ↘ 10.3 * 10.5 *
 9.8 ↓ 9.7 ← 10.6 * 9.8 ↓ 10.5 *
 beste Teiler 79.1 (18.) 105.3 (20.) 111.8 (11.)
 Trefferlage 0.18 mm links, 0.85 mm tief
 Streuwert 1.43, horizontal: 1.44, vertikal: 1.42

Unterschrift des Schützen

Ergebnis: **194.6** (185)
 Serien: 97.3 97.3
 Zähler: 6 13 1 0 0 0 0 0 0 0
 Innenzehner: 2
 weiteste: 553 (5), 476 (14), 439 (6)
 beste Teiler 77.0 (11.) 155.1 (4.) 205.7 (9.)
 Trefferlage 0.63 mm links, 0.09 mm hoch
 Streuwert 2.32, horizontal: 2.51, vertikal: 2.10

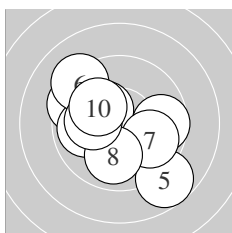
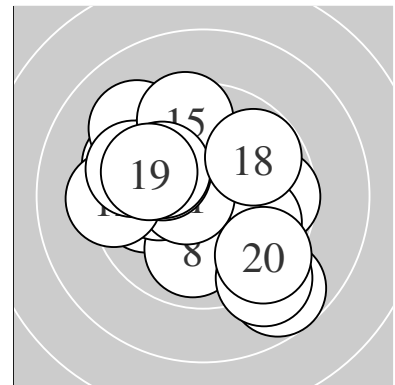

Serie 1:
 9.7 → 9.5 ↖ 9.9 ← 10.3 * 8.7 ↘
 9.2 ↘ 9.9 ↗ 9.9 ↓ 10.1 ← 10.1 ↖
 beste Teiler 155.1 (4.) 205.7 (9.) 210.0 (10.)
 Trefferlage 0.54 mm links, 0.13 mm tief
 Streuwert 2.38, horizontal: 2.61, vertikal: 2.13

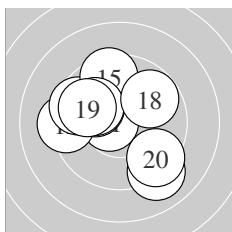

Serie 2:
 10.6 * 9.3 ← 9.6 ↖ 9.0 ↘ 9.5 ↑
 10.1 ↖ 10.1 ↖ 9.8 ↗ 9.9 ↖ 9.4 ↘
 beste Teiler 77.0 (11.) 217.4 (16.) 225.2 (17.)
 Trefferlage 0.72 mm links, 0.33 mm hoch
 Streuwert 2.37, horizontal: 2.55, vertikal: 2.17

Unterschrift des Schützen

Ergebnis: **200.0** (189)
 Serien: 101.5 98.5
 Zähler: 9 11 0 0 0 0 0 0 0 0
 Innenzehner: 7
 weiteste: 408 (3), 393 (16), 392 (5)
 beste Teiler 57.6 (8.) 96.7 (10.) 116.4 (1.)
 Trefferlage 0.68 mm rechts, 0.23 mm hoch
 Streuwert 1.81, horizontal: 2.30, vertikal: 1.11

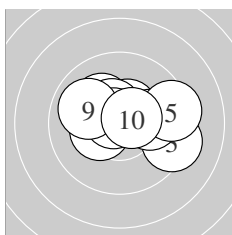
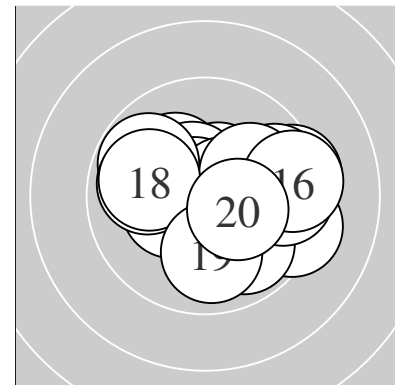

Serie 1:
 10.5 * 10.2 * 9.3 ↘ 10.1 → 9.4 →
 10.5 * 10.3 * 10.7 * 9.9 ↖ 10.6 *
 beste Teiler 57.6 (8.) 96.7 (10.) 116.4 (1.)
 Trefferlage 0.52 mm rechts, 0.46 mm hoch
 Streuwert 1.65, horizontal: 2.17, vertikal: 0.84

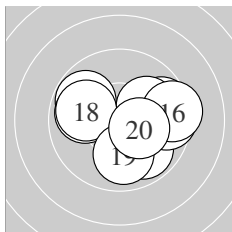

Serie 2:
 9.7 → 10.1 ↗ 9.8 ↖ 9.9 ↘ 9.6 →
 9.4 → 9.9 ← 9.9 ← 9.9 ↓ 10.3 *
 beste Teiler 156.9 (20.) 222.2 (12.) 251.6 (19.)
 Trefferlage 0.83 mm rechts, 0.00 mm
 Streuwert 2.02, horizontal: 2.53, vertikal: 1.34

Unterschrift des Schützen

Ergebnis: **193.4** (183)
 Serien: 98.5 94.9
 Zähler: 9 5 6 0 0 0 0 0 0 0
 Innenzehner: 6
 weiteste: 704 (16), 551 (19), 545 (7)
 beste Teiler 34.9 (20.) 50.0 (17.) 117.6 (4.)
 Trefferlage 0.02 mm rechts, 0.94 mm tief
 Streuwert 2.60, horizontal: 3.33, vertikal: 1.58

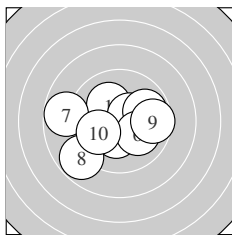
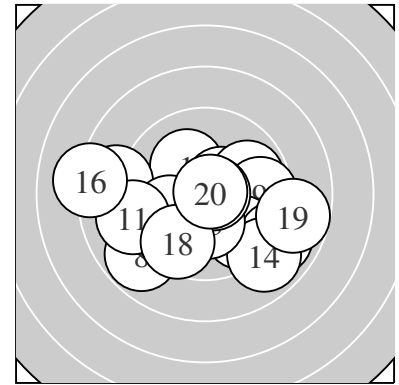

Serie 1:
 10.1 ↘ 10.3 * 10.4 * 10.5 * 9.9 →
 10.1 ↗ 8.8 ← 8.8 ↙ 9.6 → 10.0 ←
 beste Teiler 117.6 (4.) 127.1 (3.) 155.7 (2.)
 Trefferlage 0.28 mm links, 0.37 mm tief
 Streuwert 2.30, horizontal: 2.85, vertikal: 1.56

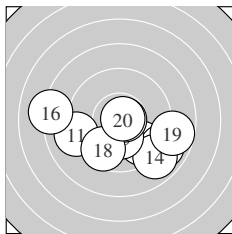

Serie 2:
 9.1 ← 9.7 ↘ 8.9 ↘ 8.9 ↘ 10.3 *
 8.1 ← 10.8 * 9.6 ↙ 8.7 → 10.8 *
 beste Teiler 34.9 (20.) 50.0 (17.) 170.8 (15.)
 Trefferlage 0.33 mm rechts, 1.50 mm tief
 Streuwert 2.93, horizontal: 3.87, vertikal: 1.47

Unterschrift des Schützen

Ergebnis: **193.6** (185)
 Serien: 94.8 98.8
 Zähler: 11 5 2 2 0 0 0 0 0 0
 Innenzehner: 8
 weiteste: 969 (8), 835 (12), 631 (4)
 beste Teiler 18.3 (1.) 45.2 (16.) 54.2 (13.)
 Trefferlage 0.45 mm rechts, 0.42 mm hoch
 Streuwert 2.93, horizontal: 4.03, vertikal: 1.00

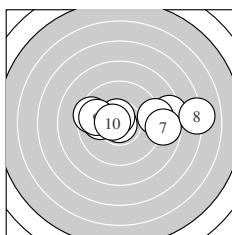
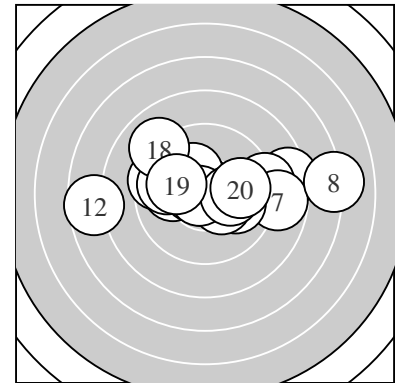

Serie 1:
 10.9 * 9.5 ← 10.0 ← 8.4 → 10.6 *
 9.1 → 8.8 → 7.1 → 9.8 ← 10.6 *
 beste Teiler 18.3 (1.) 85.9 (5.) 89.9 (10.)
 Trefferlage 1.56 mm rechts, 0.51 mm hoch
 Streuwert 3.22, horizontal: 4.52, vertikal: 0.56

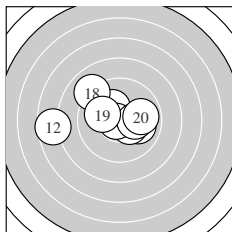

Serie 2:
 10.0 → 7.6 ← 10.7 * 10.2 * 10.4 *
 10.8 * 10.2 * 9.0 ↘ 10.0 ← 9.9 →
 beste Teiler 45.2 (16.) 54.2 (13.) 146.4 (15.)
 Trefferlage 0.66 mm links, 0.33 mm hoch
 Streuwert 2.53, horizontal: 3.33, vertikal: 1.33

Unterschrift des Schützen

Ergebnis: **199.5** (190)
 Serien: 100.4 99.1
 Zähler: 12 6 2 0 0 0 0 0 0 0
 Innenzehner: 10
 weiteste: 603 (20), 532 (12), 485 (5)
 beste Teiler 56.0 (10.) 57.0 (14.) 68.6 (2.)
 Trefferlage 0.33 mm links, 0.18 mm tief
 Streuwert 2.12, horizontal: 2.81, vertikal: 1.03

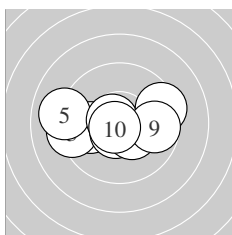
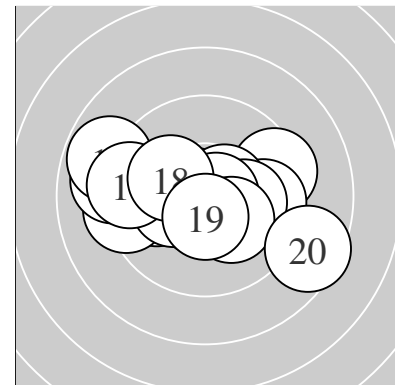

Serie 1:
 9.9 ← 10.7 * 9.3 ← 10.6 * 9.0 ←
 10.4 * 10.7 * 9.4 → 9.7 → 10.7 *
 beste Teiler 56.0 (10.) 68.6 (2.) 70.7 (7.)
 Trefferlage 0.47 mm links, 0.17 mm tief
 Streuwert 2.02, horizontal: 2.75, vertikal: 0.74

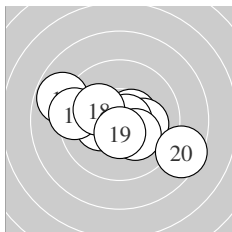

Serie 2:
 10.5 * 8.8 ↖ 10.1 → 10.7 * 10.2 *
 10.3 * 9.4 ← 10.1 ↖ 10.5 * 8.5 ↘
 beste Teiler 57.0 (14.) 109.0 (19.) 110.1 (11.)
 Trefferlage 0.19 mm links, 0.20 mm tief
 Streuwert 2.32, horizontal: 3.02, vertikal: 1.30

Unterschrift des Schützen

Ergebnis: **195.7** (186)
 Serien: 97.2 98.5
 Zähler: 8 10 2 0 0 0 0 0 0 0
 Innenzehner: 5
 weiteste: 650 (5), 530 (3), 383 (20)
 beste Teiler 148.1 (7.) 177.7 (9.) 186.7 (2.)
 Trefferlage 0.01 mm links, 0.55 mm tief
 Streuwert 2.26, horizontal: 2.61, vertikal: 1.85

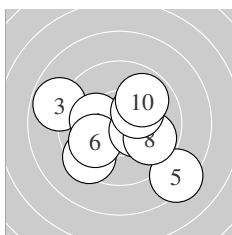
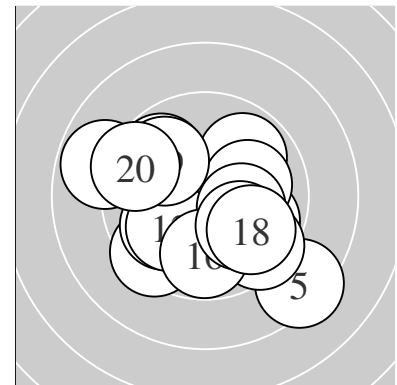

Serie 1:
 9.4 ↙ 10.2 * 8.8 ↖ 10.2 * 8.4 ↘
 9.9 ↙ 10.4 * 9.8 ↘ 10.2 * 9.9 ↗
 beste Teiler 148.1 (7.) 177.7 (9.) 186.7 (2.)
 Trefferlage 0.14 mm links, 0.60 mm tief
 Streuwert 2.54, horizontal: 2.99, vertikal: 1.99

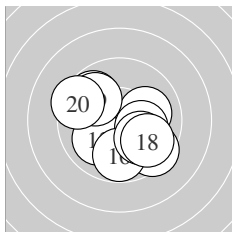

Serie 2:
 9.8 ↘ 10.1 → 10.0 ↙ 9.5 ↘ 10.2 *
 9.8 ↓ 10.0 ↘ 9.8 ↘ 9.9 ↘ 9.4 ↖
 beste Teiler 192.5 (15.) 222.6 (12.) 232.0 (17.)
 Trefferlage 0.12 mm rechts, 0.50 mm tief
 Streuwert 2.09, horizontal: 2.33, vertikal: 1.81

Unterschrift des Schützen

Ergebnis: **174.0** (165)
 Serien: 87.2 86.8
 Zähler: 2 8 5 3 2 0 0 0 0 0
 Innenzehner: 2
 weiteste: 1178 (6), 1092 (2), 985 (11)
 beste Teiler 68.0 (1.) 194.3 (7.) 272.0 (17.)
 Trefferlage 2.06 mm links, 0.92 mm hoch
 Streuwert 4.33, horizontal: 5.89, vertikal: 1.68

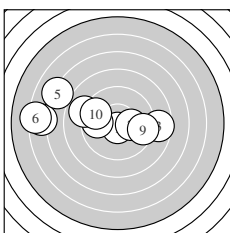
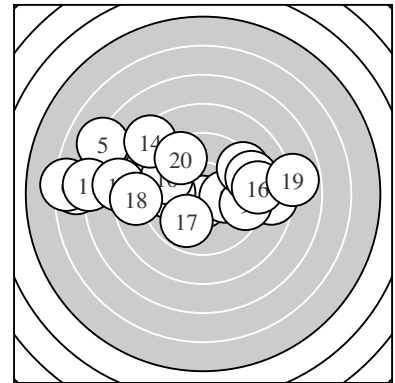

Serie 1:
 10.7 * 6.6 ← 8.6 → 9.8 ← 7.1 ↖
 6.2 ← 10.2 * 8.9 ← 9.5 → 9.6 ↖
 beste Teiler 68.0 (1.) 194.3 (7.) 291.2 (4.)
 Trefferlage 3.06 mm links, 0.66 mm hoch
 Streuwert 4.42, horizontal: 6.06, vertikal: 1.53

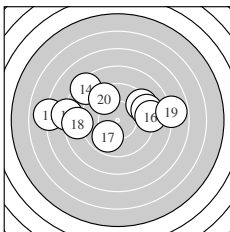

Serie 2:
 7.0 ← 9.3 ↗ 9.2 → 8.4 ↘ 8.0 ←
 9.1 → 9.9 ↙ 8.6 ← 7.8 → 9.5 ↘
 beste Teiler 272.0 (17.) 362.9 (20.) 408.0 (12.)
 Trefferlage 1.07 mm links, 1.18 mm hoch
 Streuwert 4.34, horizontal: 5.85, vertikal: 1.87

Unterschrift des Schützen

Ergebnis: **187.7** (175)
 Serien: 98.8 88.9
 Zähler: 5 8 6 0 0 1 0 0 0 0
 Innenzehner: 4
 weiteste: 1288 (14), 630 (12), 603 (11)
 beste Teiler 36.4 (5.) 171.3 (16.) 173.2 (1.)
 Trefferlage 0.66 mm links, 0.51 mm hoch
 Streuwert 3.35, horizontal: 4.43, vertikal: 1.68

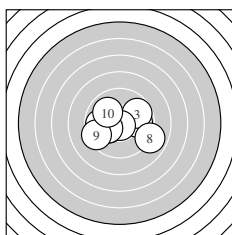
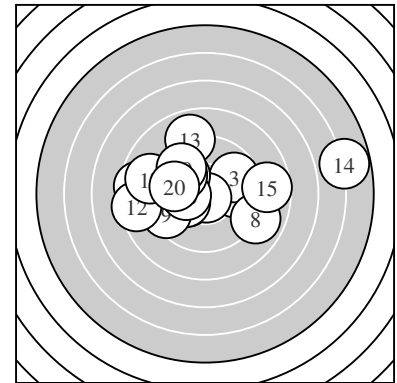

Serie 1:
 10.3 * 9.9 → 9.7 ↗ 9.8 ← 10.8 *
 9.8 ← 10.2 * 8.9 ↘ 9.4 ← 10.0 ↖
 beste Teiler 36.4 (5.) 173.2 (1.) 193.5 (7.)
 Trefferlage 0.42 mm links, 0.34 mm tief
 Streuwert 2.16, horizontal: 2.79, vertikal: 1.23

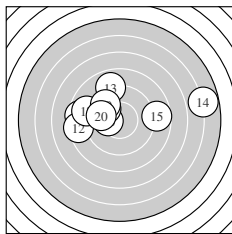

Serie 2:
 8.5 ← 8.4 ← 8.9 ↑ 5.8 → 8.7 →
 10.3 * 8.9 ← 9.9 ↘ 9.7 ↘ 9.8 ←
 beste Teiler 171.3 (16.) 267.0 (18.) 286.1 (20.)
 Trefferlage 0.90 mm links, 1.37 mm hoch
 Streuwert 4.27, horizontal: 5.79, vertikal: 1.68

Unterschrift des Schützen

Ergebnis: **200.7** (191)
 Serien: 100.1 100.6
 Zähler: 13 5 2 0 0 0 0 0 0 0
 Innenzehner: 12
 weiteste: 696 (8), 530 (16), 378 (19)
 beste Teiler 59.5 (5.) 66.2 (13.) 69.7 (2.)
 Trefferlage 1.09 mm links, 0.89 mm hoch
 Streuwert 1.74, horizontal: 2.30, vertikal: 0.88

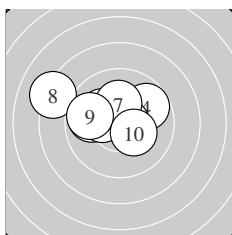
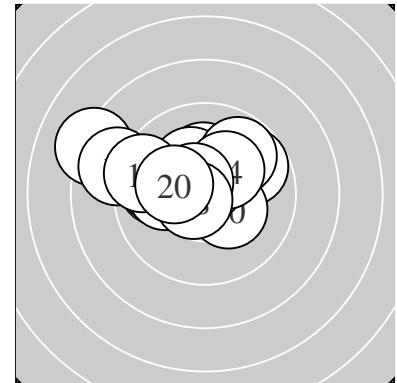

Serie 1:
 9.9 ← 10.7 * 10.2 * 9.8 ↗ 10.7 *
 10.3 * 10.2 * 8.2 ↙ 9.8 ← 10.3 *
 beste Teiler 59.5 (5.) 69.7 (2.) 162.2 (10.)
 Trefferlage 1.03 mm links, 0.82 mm hoch
 Streuwert 1.97, horizontal: 2.59, vertikal: 1.03

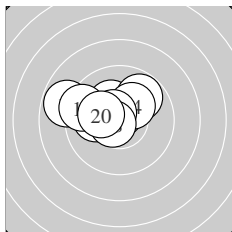

Serie 2:
 10.2 * 9.8 ↗ 10.7 * 10.2 * 10.6 *
 8.8 ↙ 10.0 ← 10.7 * 9.4 ↙ 10.2 *
 beste Teiler 66.2 (13.) 75.5 (18.) 92.0 (15.)
 Trefferlage 1.16 mm links, 0.96 mm hoch
 Streuwert 1.58, horizontal: 2.10, vertikal: 0.76

Unterschrift des Schützen

Ergebnis: **186.7** (177)
 Serien: 95.3 91.4
 Zähler: 5 11 1 2 1 0 0 0 0 0
 Innenzehner: 2
 weiteste: 1177 (15), 974 (9), 804 (19)
 beste Teiler 25.0 (10.) 166.0 (13.) 218.0 (8.)
 Trefferlage 0.37 mm rechts, 1.12 mm tief
 Streuwert 3.46, horizontal: 4.61, vertikal: 1.63

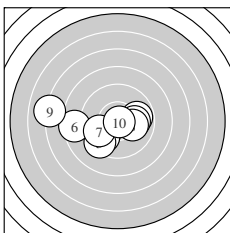
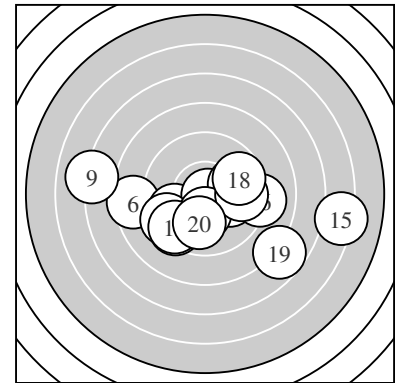

Serie 1:
 9.9 ↙ 9.8 → 9.8 ↙ 10.0 → 9.4 ↙
 8.5 ← 9.8 ↙ 10.1 → 7.1 ← 10.9 *
 beste Teiler 25.0 (10.) 218.0 (8.) 240.0 (4.)
 Trefferlage 1.72 mm links, 0.78 mm tief
 Streuwert 2.93, horizontal: 3.93, vertikal: 1.35

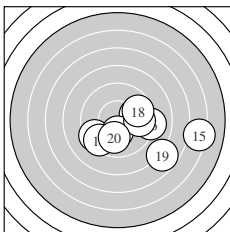

Serie 2:
 9.4 ↙ 9.9 → 10.3 * 9.4 ↙ 6.2 →
 9.1 → 9.7 → 9.7 → 7.7 ↘ 10.0 ↓
 beste Teiler 166.0 (13.) 249.8 (20.) 260.8 (12.)
 Trefferlage 2.47 mm rechts, 1.46 mm tief
 Streuwert 3.40, horizontal: 4.43, vertikal: 1.88

Unterschrift des Schützen

Ergebnis: **201.8** (193)
 Serien: 102.3 99.5
 Zähler: 14 5 1 0 0 0 0 0 0 0
 Innenzehner: 11
 weiteste: 742 (12), 455 (14), 411 (6)
 beste Teiler 41.1 (3.) 59.3 (4.) 91.1 (2.)
 Trefferlage 0.30 mm rechts, 0.47 mm hoch
 Streuwert 1.93, horizontal: 2.60, vertikal: 0.86

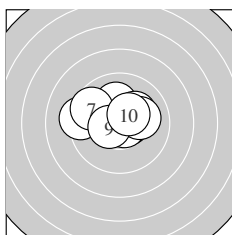
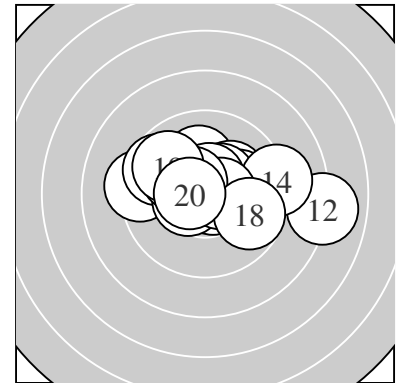

Serie 1:
 10.1 ↑ 10.6 * 10.8 * 10.7 * 10.2 *
 9.3 ← 9.6 ↖ 10.1 → 10.5 * 10.4 *
 beste Teiler 41.1 (3.) 59.3 (4.) 91.1 (2.)
 Trefferlage 0.28 mm links, 0.57 mm hoch
 Streuwert 1.50, horizontal: 1.96, vertikal: 0.82

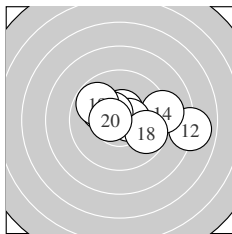

Serie 2:
 10.5 * 8.0 → 10.6 * 9.1 → 10.1 ↘
 10.6 * 10.5 * 9.7 ↘ 9.8 ↖ 10.6 *
 beste Teiler 97.0 (16.) 97.0 (20.) 98.2 (13.)
 Trefferlage 0.88 mm rechts, 0.37 mm hoch
 Streuwert 2.29, horizontal: 3.10, vertikal: 0.92

Unterschrift des Schützen

Ergebnis: **197.4** (190)
 Serien: 98.3 99.1
 Zähler: 11 8 1 0 0 0 0 0 0 0
 Innenzehner: 6
 weiteste: 527 (9), 496 (5), 400 (20)
 beste Teiler 129.0 (4.) 129.6 (11.) 151.6 (19.)
 Trefferlage 0.08 mm links, 0.77 mm hoch
 Streuwert 2.04, horizontal: 2.51, vertikal: 1.40

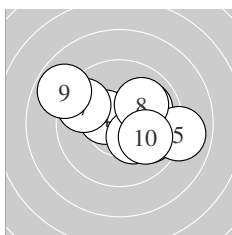
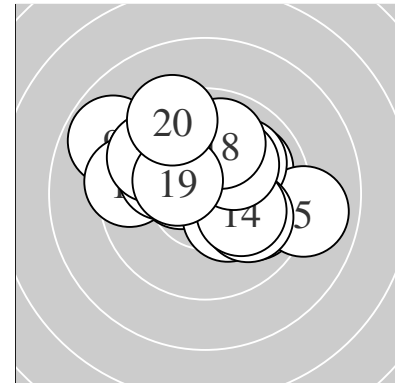

Serie 1:
 10.0 ↗ 9.9 ↘ 10.3 * 10.4 * 9.0 →
 10.3 * 9.6 ↖ 10.0 ↗ 8.8 ↖ 10.0 ↘
 beste Teiler 129.0 (4.) 154.7 (3.) 159.1 (6.)
 Trefferlage 0.71 mm rechts, 0.23 mm hoch
 Streuwert 2.22, horizontal: 2.81, vertikal: 1.41

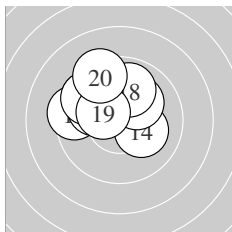

Serie 2:
 10.4 * 9.7 ↖ 9.4 ← 10.2 * 10.0 ↖
 9.7 ↖ 10.1 ↗ 9.9 ↑ 10.3 * 9.4 ↖
 beste Teiler 129.6 (11.) 151.6 (19.) 198.6 (14.)
 Trefferlage 0.88 mm links, 1.31 mm hoch
 Streuwert 1.66, horizontal: 2.00, vertikal: 1.24

Unterschrift des Schützen

Ergebnis: **194.1** (185)
 Serien: 95.6 98.5
 Zähler: 7 11 2 0 0 0 0 0 0 0
 Innenzehner: 5
 weiteste: 519 (17), 512 (5), 490 (6)
 beste Teiler 50.6 (20.) 51.8 (13.) 148.6 (14.)
 Trefferlage 0.20 mm rechts, 0.22 mm tief
 Streuwert 2.49, horizontal: 3.19, vertikal: 1.50

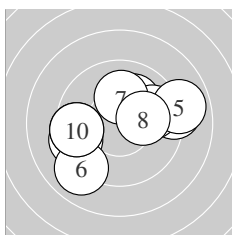
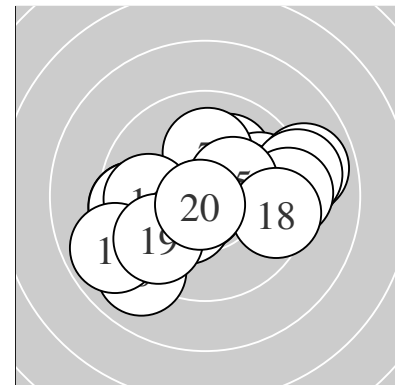

Serie 1:
 9.4 ← 10.1 ↗ 9.1 → 9.8 → 8.9 →
 9.0 ↙ 10.1 ↑ 10.2 * 9.5 ← 9.5 ←
 beste Teiler 199.2 (8.) 215.3 (7.) 217.6 (2.)
 Trefferlage 0.14 mm rechts, 0.14 mm hoch
 Streuwert 2.73, horizontal: 3.43, vertikal: 1.76

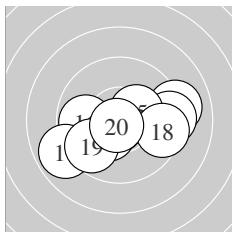

Serie 2:
 9.1 → 9.3 → 10.7 * 10.4 * 10.3 *
 9.8 ← 8.9 ← 9.5 → 9.7 ↙ 10.8 *
 beste Teiler 50.6 (20.) 51.8 (13.) 148.6 (14.)
 Trefferlage 0.26 mm rechts, 0.58 mm tief
 Streuwert 2.35, horizontal: 3.11, vertikal: 1.16

Unterschrift des Schützen

Ergebnis: **198.8** (189)
 Serien: 100.8 98.0
 Zähler: 10 9 1 0 0 0 0 0 0 0
 Innenzehner: 8
 weiteste: 520 (18), 483 (5), 461 (13)
 beste Teiler 44.7 (2.) 83.2 (10.) 87.2 (14.)
 Trefferlage 1.57 mm links, 0.61 mm hoch
 Streuwert 1.69, horizontal: 1.90, vertikal: 1.45

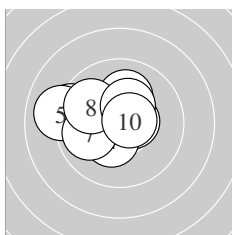
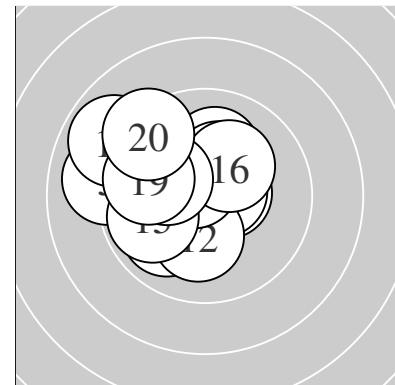

Serie 1:
 9.3 ↖ 10.8 * 10.5 * 10.4 * 9.0 ↖
 10.1 ↑ 9.9 ↖ 9.9 ↖ 10.3 * 10.6 *
 beste Teiler 44.7 (2.) 83.2 (10.) 104.0 (3.)
 Trefferlage 1.15 mm links, 0.47 mm hoch
 Streuwert 1.66, horizontal: 2.09, vertikal: 1.06

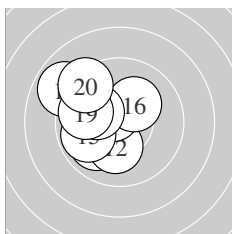

Serie 2:
 9.9 ↗ 10.2 * 9.1 ↖ 10.6 * 9.9 ↖
 10.2 * 10.1 ↖ 8.9 ↖ 9.8 ↖ 9.3 ↖
 beste Teiler 87.2 (14.) 187.7 (16.) 197.9 (12.)
 Trefferlage 1.98 mm links, 0.74 mm hoch
 Streuwert 1.75, horizontal: 1.69, vertikal: 1.81

Unterschrift des Schützen

Ergebnis: **196.0** (188)
 Serien: 98.2 97.8
 Zähler: 8 12 0 0 0 0 0 0 0 0
 Innenzehner: 6
 weiteste: 482 (18), 480 (13), 459 (3)
 beste Teiler 114.9 (19.) 144.3 (8.) 145.4 (2.)
 Trefferlage 0.18 mm links, 0.80 mm hoch
 Streuwert 2.16, horizontal: 2.52, vertikal: 1.74

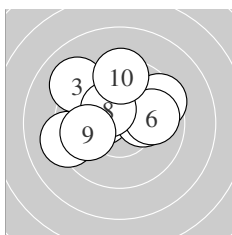
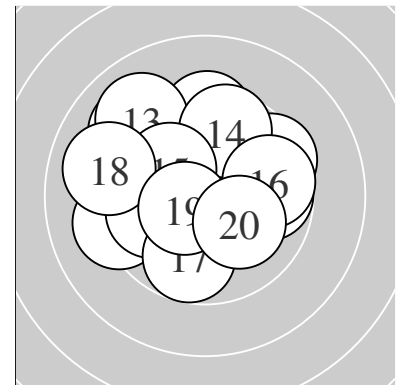

Serie 1:
 10.2 * 10.4 * 9.1 ↘ 9.5 ↗ 10.2 *
 9.9 → 9.2 ← 10.4 * 9.9 ← 9.4 ↑
 beste Teiler 144.3 (8.) 145.4 (2.) 186.8 (1.)
 Trefferlage 0.29 mm links, 0.97 mm hoch
 Streuwert 2.14, horizontal: 2.59, vertikal: 1.57

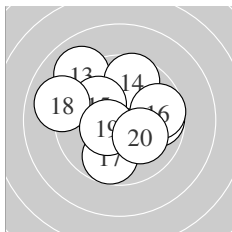

Serie 2:
 10.2 * 9.8 → 9.0 ↘ 9.6 ↑ 10.1 ↘
 9.7 → 9.8 ↓ 9.0 ← 10.5 * 10.1 ↘
 beste Teiler 114.9 (19.) 188.3 (11.) 209.0 (20.)
 Trefferlage 0.08 mm links, 0.64 mm hoch
 Streuwert 2.29, horizontal: 2.58, vertikal: 1.96

Unterschrift des Schützen

Ergebnis: **179.2** (169)
 Serien: 92.6 86.6
 Zähler: 5 8 3 2 0 1 1 0 0 0
 Innenzehner: 2
 weiteste: 1653 (18), 1287 (12), 867 (3)
 beste Teiler 102.4 (1.) 178.9 (19.) 235.4 (14.)
 Trefferlage 1.67 mm rechts, 0.11 mm tief
 Streuwert 4.40, horizontal: 5.63, vertikal: 2.66

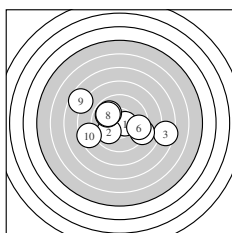
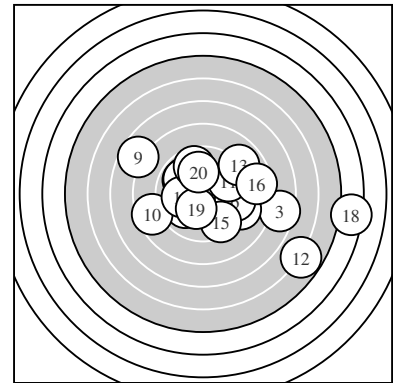

Serie 1:
 10.5 * 10.0 ↙ 7.5 → 9.2 ↘ 9.9 ↖
 9.5 → 9.9 ↘ 9.9 ↘ 7.7 ↖ 8.5 ←
 beste Teiler 102.4 (1.) 248.8 (2.) 265.8 (7.)
 Trefferlage 0.38 mm links, 0.09 mm hoch
 Streuwert 3.65, horizontal: 4.73, vertikal: 2.09

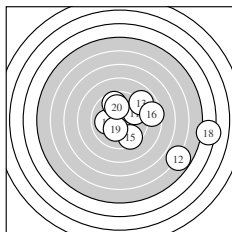

Serie 2:
 9.7 ↗ 5.8 ↘ 8.9 ↗ 10.0 ← 9.5 ↘
 8.5 → 9.7 ↑ 4.3 → 10.2 * 10.0 ↑
 beste Teiler 178.9 (19.) 235.4 (14.) 246.3 (20.)
 Trefferlage 3.72 mm rechts, 0.31 mm tief
 Streuwert 4.77, horizontal: 5.92, vertikal: 3.23

Unterschrift des Schützen

Ergebnis: **171.0** (162)
 Serien: 88.7 82.3
 Zähler: 2 10 2 2 2 2 0 0 0 0
 Innenzehner: 2
 weiteste: 1379 (16), 1296 (13), 1092 (5)
 beste Teiler 194.6 (14.) 198.0 (6.) 281.3 (19.)
 Trefferlage 0.05 mm links, 0.14 mm hoch
 Streuwert 5.06, horizontal: 6.47, vertikal: 3.06

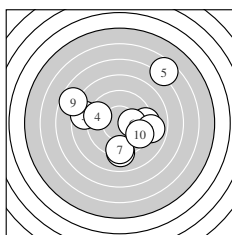
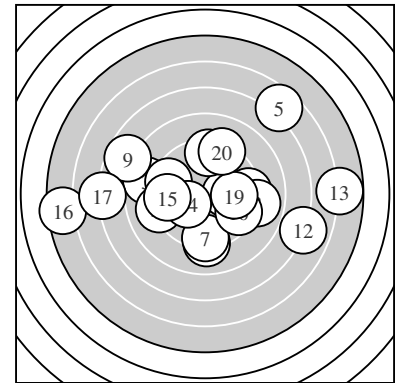

Serie 1:
 9.3 → 9.1 ↓ 8.6 ← 9.5 ← 6.6 ↗
 10.2 * 9.3 ↓ 8.9 → 7.7 ← 9.5 ↘
 beste Teiler 198.0 (6.) 366.8 (10.) 371.2 (4.)
 Trefferlage 0.50 mm rechts, 0.28 mm hoch
 Streuwert 4.29, horizontal: 4.77, vertikal: 3.75

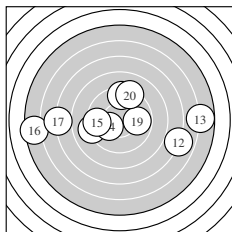

Serie 2:
 9.1 ← 6.9 → 5.8 → 10.2 * 9.5 ←
 5.4 ← 7.0 ← 9.4 ↑ 9.8 → 9.2 ↗
 beste Teiler 194.6 (14.) 281.3 (19.) 364.4 (15.)
 Trefferlage 0.61 mm links, 0.01 mm hoch
 Streuwert 5.94, horizontal: 8.06, vertikal: 2.37

Unterschrift des Schützen

Ergebnis: **187.7** (180)
 Serien: 93.7 94.0
 Zähler: 5 12 1 2 0 0 0 0 0 0
 Innenzehner: 3
 weiteste: 842 (4), 776 (20), 673 (14)
 beste Teiler 79.8 (17.) 126.0 (15.) 176.2 (7.)
 Trefferlage 1.94 mm rechts, 1.27 mm hoch
 Streuwert 2.69, horizontal: 3.42, vertikal: 1.65

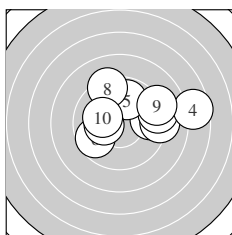
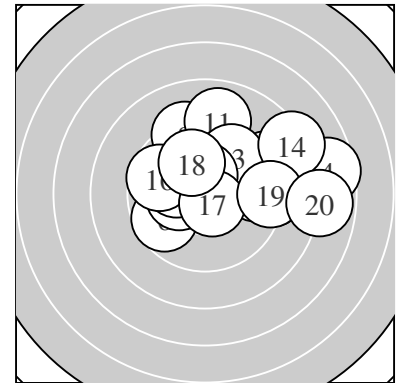

Serie 1:
 9.6 → 9.1 → 9.2 → 7.6 → 9.8 ↑
 9.7 ↙ 10.2 * 9.3 ↘ 9.1 → 10.1 ↖
 beste Teiler 176.2 (7.) 202.7 (10.) 276.1 (5.)
 Trefferlage 1.77 mm rechts, 1.05 mm hoch
 Streuwert 2.84, horizontal: 3.69, vertikal: 1.59

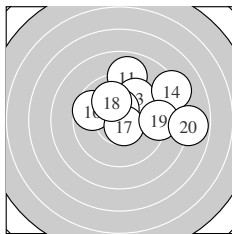

Serie 2:
 9.0 ↑ 9.3 → 9.7 ↗ 8.3 ↘ 10.4 *
 9.7 ↖ 10.6 * 10.0 ↘ 9.2 → 7.8 →
 beste Teiler 79.8 (17.) 126.0 (15.) 229.3 (18.)
 Trefferlage 2.11 mm rechts, 1.50 mm hoch
 Streuwert 2.66, horizontal: 3.33, vertikal: 1.76

Unterschrift des Schützen

Ergebnis: **201.9** (191)
 Serien: 100.3 101.6
 Zähler: 12 7 1 0 0 0 0 0 0 0
 Innenzehner: 10
 weiteste: 542 (5), 422 (3), 306 (4)
 beste Teiler 55.1 (17.) 68.1 (9.) 106.8 (6.)
 Trefferlage 0.38 mm links, 0.10 mm tief
 Streuwert 1.76, horizontal: 2.27, vertikal: 1.01

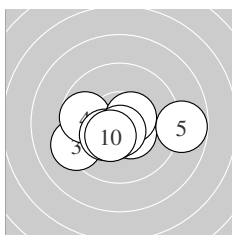
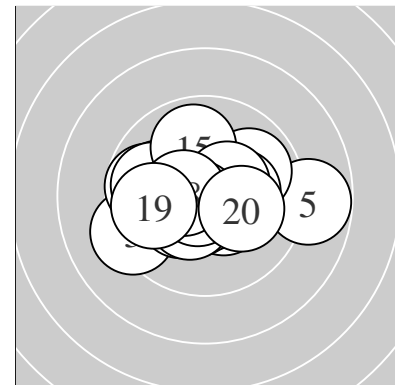

Serie 1:
 10.4 * 9.7 ← 9.3 ← 9.7 ← 8.8 →
 10.5 * 10.3 * 10.5 * 10.7 * 10.4 *
 beste Teiler 68.1 (9.) 106.8 (6.) 109.5 (8.)
 Trefferlage 0.48 mm links, 0.66 mm tief
 Streuwert 1.95, horizontal: 2.65, vertikal: 0.73

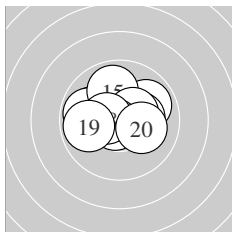

Serie 2:
 9.9 ↗ 10.0 ← 10.3 * 9.9 ← 9.9 ↑
 10.4 * 10.7 * 10.5 * 9.9 ← 10.1 →
 beste Teiler 55.1 (17.) 113.9 (18.) 131.0 (16.)
 Trefferlage 0.28 mm links, 0.44 mm hoch
 Streuwert 1.54, horizontal: 1.96, vertikal: 0.96

Unterschrift des Schützen

Ergebnis: **197.6** (189)
 Serien: 100.3 97.3
 Zähler: 9 11 0 0 0 0 0 0 0 0
 Innenzehner: 4
 weiteste: 498 (11), 490 (4), 388 (17)
 beste Teiler 80.0 (10.) 89.3 (9.) 117.6 (6.)
 Trefferlage 0.73 mm links, 0.67 mm hoch
 Streuwert 2.01, horizontal: 2.44, vertikal: 1.45

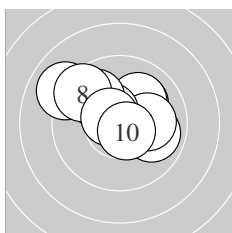
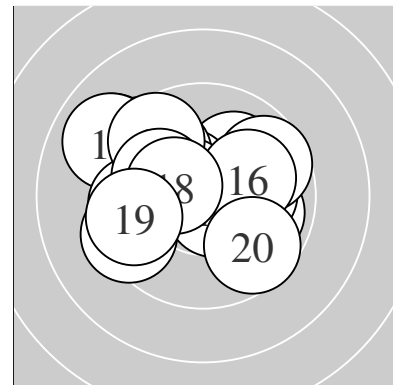

Serie 1:
 9.9 ↘ 10.1 ↗ 10.1 ↗ 9.0 ↖ 10.1 →
 10.5 * 9.9 ↖ 9.5 ↖ 10.6 * 10.6 *
 beste Teiler 80.0 (10.) 89.3 (9.) 117.6 (6.)
 Trefferlage 0.23 mm links, 1.01 mm hoch
 Streuwert 1.79, horizontal: 2.24, vertikal: 1.18

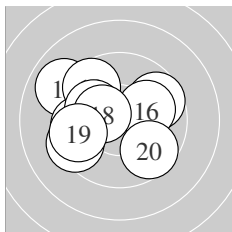

Serie 2:
 9.0 ↖ 9.7 ← 9.6 ↖ 10.1 ↖ 9.7 →
 10.1 → 9.4 ← 10.4 * 9.6 ← 9.7 ↖
 beste Teiler 143.2 (18.) 220.3 (14.) 224.3 (16.)
 Trefferlage 1.24 mm links, 0.33 mm hoch
 Streuwert 2.22, horizontal: 2.65, vertikal: 1.68

Unterschrift des Schützen