

Ergebnis: **190.9** (180)
 Serien: 92.5 98.4
 Zähler: 8 7 3 1 1 0 0 0 0 0
 Innenzehner: 8
 weiteste: 1041 (8), 864 (9), 600 (2)
 beste Teiler 84.5 (14.) 94.0 (4.) 113.5 (5.)
 Trefferlage 2.65 mm links, 0.05 mm hoch
 Streuwert 2.53, horizontal: 3.31, vertikal: 1.35

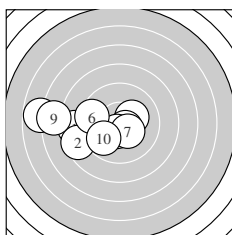

Serie 1:
 8.6 ← 8.6 ← 10.2 * 10.6 * 10.5 *
 9.5 ← 10.4 * 6.8 ← 7.5 ← 9.8 ↙
 beste Teiler 94.0 (4.) 113.5 (5.) 149.2 (7.)
 Trefferlage 3.30 mm links, 0.43 mm tief
 Streuwert 3.10, horizontal: 4.21, vertikal: 1.25

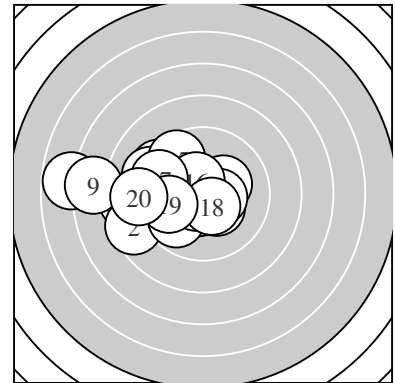
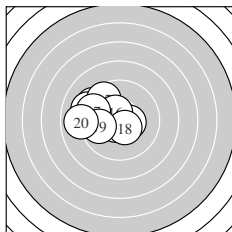

Serie 2:
 9.3 ↘ 9.2 ↘ 10.5 * 10.6 * 9.6 ↖
 10.5 * 9.5 ← 10.5 * 9.8 ← 8.9 ←
 beste Teiler 84.5 (14.) 116.7 (16.) 118.4 (18.)
 Trefferlage 2.00 mm links, 0.55 mm hoch
 Streuwert 1.76, horizontal: 2.12, vertikal: 1.31

Unterschrift des Schützen

Ergebnis: **201.8** (196)
 Serien: 100.6 101.2
 Zähler: 16 4 0 0 0 0 0 0 0 0
 Innenzehner: 9
 weiteste: 462 (10), 412 (8), 327 (18)
 beste Teiler 44.2 (1.) 90.2 (5.) 101.2 (2.)
 Trefferlage 0.36 mm links, 0.05 mm tief
 Streuwert 1.70, horizontal: 2.18, vertikal: 1.03

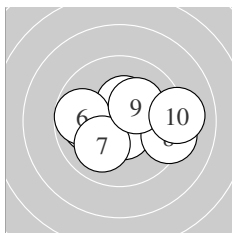
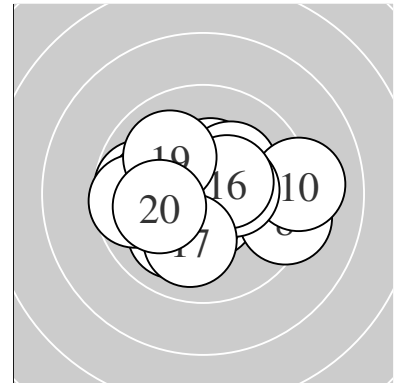

Serie 1:
 10.8 * 10.5 * 10.0 ← 10.4 * 10.6 *
 9.7 ← 10.0 ↙ 9.3 → 10.2 * 9.1 →
 beste Teiler 44.2 (1.) 90.2 (5.) 101.2 (2.)
 Trefferlage 0.48 mm rechts, 0.04 mm hoch
 Streuwert 1.88, horizontal: 2.44, vertikal: 1.05

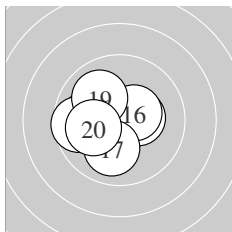

Serie 2:
 10.5 * 10.4 * 10.0 ← 10.0 ← 10.2 *
 10.4 * 10.0 ↓ 9.6 ← 10.0 ↘ 10.1 ←
 beste Teiler 119.5 (11.) 128.7 (16.) 144.1 (12.)
 Trefferlage 1.22 mm links, 0.15 mm tief
 Streuwert 1.34, horizontal: 1.57, vertikal: 1.06

Unterschrift des Schützen

Ergebnis: **199.6** (191)
 Serien: 99.2 100.4
 Zähler: 12 7 1 0 0 0 0 0 0 0
 Innenzehner: 7
 weiteste: 587 (13), 422 (5), 367 (20)
 beste Teiler 62.2 (18.) 100.9 (15.) 126.4 (9.)
 Trefferlage 0.27 mm rechts, 0.18 mm hoch
 Streuwert 1.95, horizontal: 2.43, vertikal: 1.29

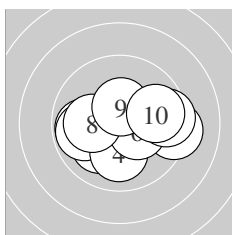
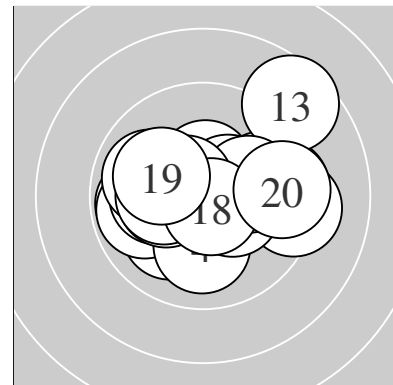

Serie 1:
 9.8 ← 10.1 ↗ 9.8 ← 10.0 ↓ 9.3 →
 10.4 * 9.5 → 10.1 ← 10.4 * 9.8 →
 beste Teiler 126.4 (9.) 148.3 (6.) 210.0 (8.)
 Trefferlage 0.29 mm rechts, 0.36 mm tief
 Streuwert 1.98, horizontal: 2.60, vertikal: 1.05

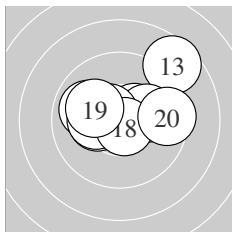

Serie 2:
 10.4 * 9.9 ↖ 8.6 ↗ 10.1 → 10.6 *
 10.3 * 10.2 * 10.7 * 10.1 ↖ 9.5 →
 beste Teiler 62.2 (18.) 100.9 (15.) 129.2 (11.)
 Trefferlage 0.25 mm rechts, 0.73 mm hoch
 Streuwert 1.93, horizontal: 2.39, vertikal: 1.32

Unterschrift des Schützen

Ergebnis: **188.0** (178)
 Serien: 97.0 91.0
 Zähler: 6 7 6 1 0 0 0 0 0 0
 Innenzehner: 3
 weiteste: 898 (16), 621 (12), 594 (17)
 beste Teiler 117.2 (19.) 136.3 (8.) 165.0 (5.)
 Trefferlage 0.83 mm links, 0.92 mm hoch
 Streuwert 3.02, horizontal: 3.51, vertikal: 2.43

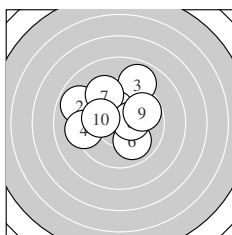
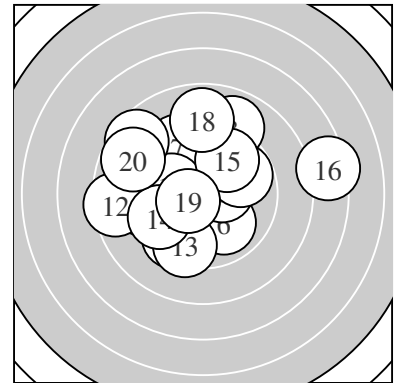

Serie 1:
 10.0 ↗ 8.9 ↖ 8.9 ↗ 9.3 ← 10.3 *
 10.0 ↘ 9.4 ↘ 10.4 * 9.8 ↗ 10.0 ←
 beste Teiler 136.3 (8.) 165.0 (5.) 229.9 (10.)
 Trefferlage 0.39 mm links, 1.25 mm hoch
 Streuwert 2.33, horizontal: 2.69, vertikal: 1.91

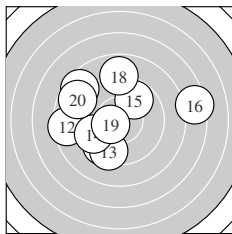

Serie 2:
 9.5 ↙ 8.5 ← 9.4 ↓ 9.6 ↙ 9.8 ↗
 7.4 → 8.6 ↘ 8.9 ↑ 10.5 * 8.8 ↖
 beste Teiler 117.2 (19.) 291.8 (15.) 345.8 (14.)
 Trefferlage 1.28 mm links, 0.59 mm hoch
 Streuwert 3.66, horizontal: 4.27, vertikal: 2.93

Unterschrift des Schützen

Ergebnis: **185.4** (175)
 Serien: 92.5 92.9
 Zähler: 5 7 6 2 0 0 0 0 0 0
 Innenzehner: 4
 weiteste: 821 (2), 760 (6), 688 (12)
 beste Teiler 116.0 (16.) 153.3 (9.) 168.8 (17.)
 Trefferlage 0.34 mm links, 0.73 mm tief
 Streuwert 3.34, horizontal: 4.10, vertikal: 2.35

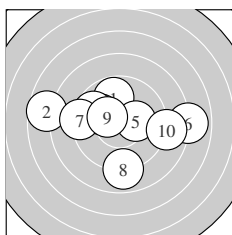
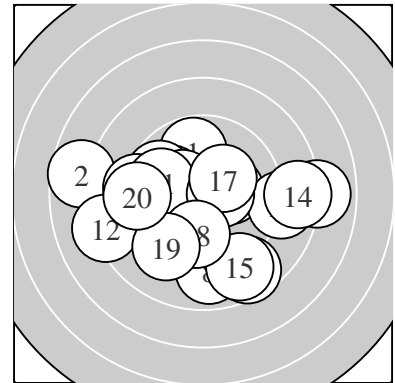

Serie 1:
 9.8 ↑ 7.7 ← 10.0 ↖ 9.7 ↖ 10.2 *
 7.9 → 9.2 ← 8.9 ↓ 10.3 * 8.8 →
 beste Teiler 153.3 (9.) 181.4 (5.) 236.2 (3.)
 Trefferlage 0.45 mm links, 0.20 mm hoch
 Streuwert 3.55, horizontal: 4.56, vertikal: 2.09

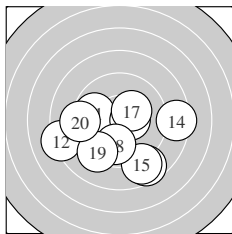

Serie 2:
 9.8 ↖ 8.2 ← 8.6 ↘ 8.4 → 8.8 ↘
 10.5 * 10.3 * 9.9 ↓ 9.2 ↙ 9.2 ←
 beste Teiler 116.0 (16.) 168.8 (17.) 272.9 (18.)
 Trefferlage 0.23 mm links, 1.67 mm tief
 Streuwert 3.17, horizontal: 3.84, vertikal: 2.30

Unterschrift des Schützen

Ergebnis: **187.8** (179)
 Serien: 93.5 94.3
 Zähler: 7 6 6 1 0 0 0 0 0 0
 Innenzehner: 6
 weiteste: 771 (4), 702 (12), 679 (13)
 beste Teiler 82.2 (16.) 103.1 (10.) 129.0 (14.)
 Trefferlage 3.22 mm links, 0.88 mm tief
 Streuwert 2.14, horizontal: 2.60, vertikal: 1.54

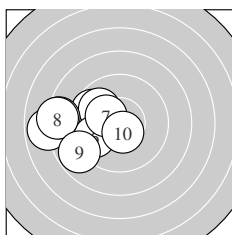
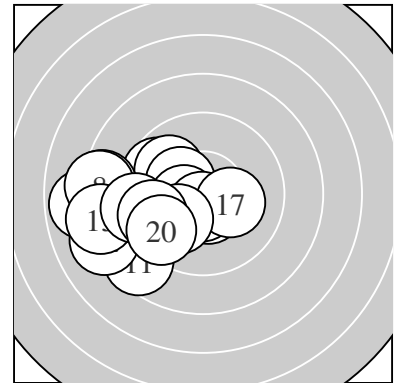

Serie 1:
 10.2 * 9.6 ↖ 9.9 ↖ 7.9 ← 8.3 ←
 9.7 ↙ 10.3 * 8.3 ← 8.8 ↙ 10.5 *
 beste Teiler 103.1 (10.) 164.6 (7.) 196.4 (1.)
 Trefferlage 3.60 mm links, 0.07 mm tief
 Streuwert 2.11, horizontal: 2.62, vertikal: 1.45

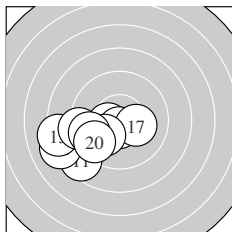

Serie 2:
 8.6 ↘ 8.1 ↖ 8.2 ← 10.4 * 9.2 ←
 10.6 * 10.2 * 10.0 ↙ 9.5 ← 9.5 ↙
 beste Teiler 82.2 (16.) 129.0 (14.) 184.3 (17.)
 Trefferlage 2.85 mm links, 1.68 mm tief
 Streuwert 2.07, horizontal: 2.66, vertikal: 1.22

Unterschrift des Schützen

Ergebnis: **195.5** (186)
 Serien: 98.4 97.1
 Zähler: 9 8 3 0 0 0 0 0 0 0
 Innenzehner: 6
 weiteste: 617 (2), 575 (7), 526 (20)
 beste Teiler 46.0 (5.) 67.4 (13.) 81.8 (1.)
 Trefferlage 0.49 mm links, 0.06 mm tief
 Streuwert 2.42, horizontal: 2.88, vertikal: 1.86

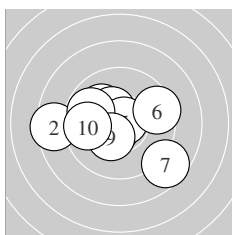
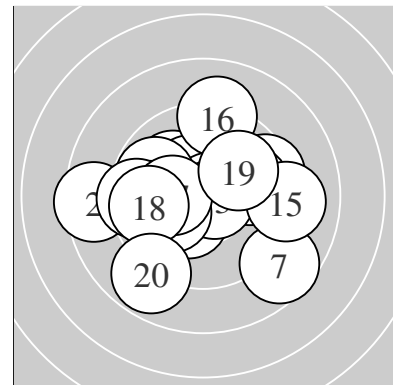

Serie 1:
 10.6 * 8.5 ← 10.1 ↖ 10.4 * 10.8 *
 9.5 → 8.7 ↘ 9.8 ← 10.3 * 9.7 ←
 beste Teiler 46.0 (5.) 81.8 (1.) 138.7 (4.)
 Trefferlage 0.73 mm links, 0.12 mm tief
 Streuwert 2.44, horizontal: 3.06, vertikal: 1.60

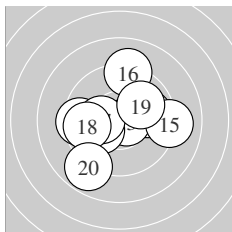

Serie 2:
 9.4 ← 9.9 → 10.7 * 10.1 ↙ 9.1 →
 9.1 ↑ 10.3 * 9.7 ← 10.0 ↗ 8.8 ↙
 beste Teiler 67.4 (13.) 173.0 (17.) 201.2 (14.)
 Trefferlage 0.25 mm links, 0.00 mm
 Streuwert 2.52, horizontal: 2.82, vertikal: 2.19

Unterschrift des Schützen

Ergebnis: **194.3** (185)
 Serien: 100.5 93.8
 Zähler: 8 9 3 0 0 0 0 0 0 0
 Innenzehner: 6
 weiteste: 705 (18), 584 (11), 528 (19)
 beste Teiler 80.3 (3.) 94.0 (9.) 159.8 (4.)
 Trefferlage 0.12 mm rechts, 0.15 mm hoch
 Streuwert 2.50, horizontal: 2.97, vertikal: 1.92

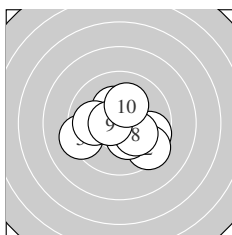
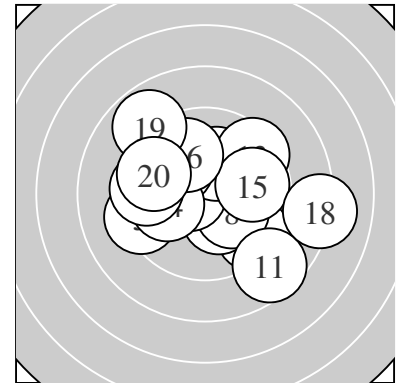

Serie 1:
 9.7 ↗ 9.4 ↘ 10.6 * 10.3 * 9.3 ←
 10.3 * 9.9 ← 10.2 * 10.6 * 10.2 *
 beste Teiler 80.3 (3.) 94.0 (9.) 159.8 (4.)
 Trefferlage 0.10 mm rechts, 0.32 mm tief
 Streuwert 1.84, horizontal: 2.21, vertikal: 1.39

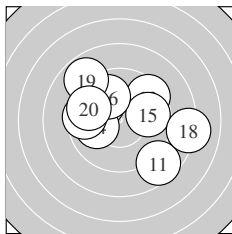

Serie 2:
 8.6 ↘ 10.0 ↖ 9.5 ↗ 10.0 ← 9.8 →
 9.9 ↘ 9.5 ← 8.1 → 8.8 ↖ 9.6 ←
 beste Teiler 234.9 (12.) 238.4 (14.) 262.5 (16.)
 Trefferlage 0.14 mm rechts, 0.64 mm hoch
 Streuwert 3.09, horizontal: 3.71, vertikal: 2.32

Unterschrift des Schützen

Ergebnis: **194.0** (183)
 Serien: 96.4 97.6
 Zähler: 8 8 3 1 0 0 0 0 0 0
 Innenzehner: 8
 weiteste: 775 (1), 680 (12), 608 (14)
 beste Teiler 74.9 (20.) 89.4 (17.) 125.2 (10.)
 Trefferlage 0.47 mm links, 0.35 mm tief
 Streuwert 2.63, horizontal: 3.30, vertikal: 1.71

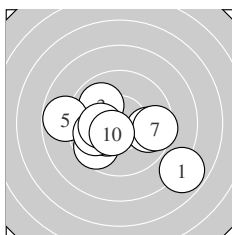
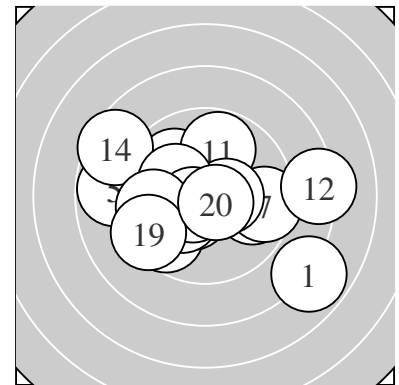

Serie 1:
 7.9 ↘ 9.8 → 9.9 ↖ 9.6 ↙ 8.8 ←
 10.3 * 9.5 → 9.9 ← 10.2 * 10.5 *
 beste Teiler 125.2 (10.) 160.5 (6.) 189.7 (9.)
 Trefferlage 0.32 mm links, 0.91 mm tief
 Streuwert 2.72, horizontal: 3.45, vertikal: 1.69

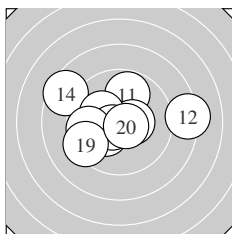

Serie 2:
 9.8 ↑ 8.2 → 10.2 * 8.5 ↖ 10.4 *
 10.2 * 10.6 * 9.7 ← 9.3 ↙ 10.7 *
 beste Teiler 74.9 (20.) 89.4 (17.) 126.0 (15.)
 Trefferlage 0.62 mm links, 0.21 mm hoch
 Streuwert 2.62, horizontal: 3.33, vertikal: 1.62

Unterschrift des Schützen

Ergebnis: **193.9** (184)
 Serien: 94.7 99.2
 Zähler: 9 7 3 1 0 0 0 0 0 0
 Innenzehner: 9
 weiteste: 836 (1), 519 (7), 511 (15)
 beste Teiler 60.1 (19.) 76.3 (13.) 112.8 (8.)
 Trefferlage 0.59 mm links, 0.79 mm hoch
 Streuwert 2.56, horizontal: 3.18, vertikal: 1.73

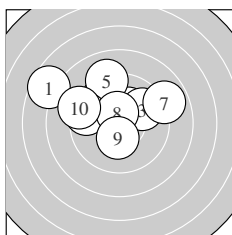
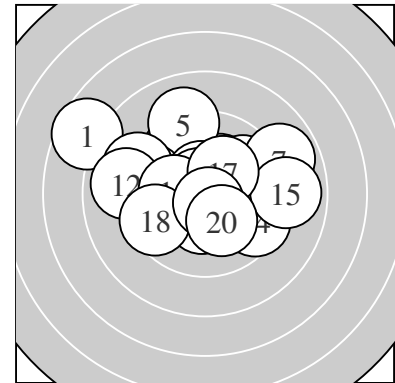

Serie 1:
 7.6 ↘ 10.2 * 9.8 ↗ 9.7 ↖ 9.1 ↗
 9.5 ↖ 8.9 ↗ 10.5 * 10.3 * 9.1 ↖
 beste Teiler 112.8 (8.) 156.2 (9.) 180.0 (2.)
 Trefferlage 1.08 mm links, 1.82 mm hoch
 Streuwert 2.72, horizontal: 3.47, vertikal: 1.65

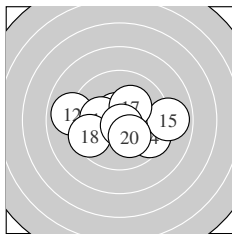

Serie 2:
 10.5 * 8.9 ← 10.6 * 9.5 ↘ 8.9 →
 10.2 * 10.2 * 9.5 ↖ 10.7 * 10.2 *
 beste Teiler 60.1 (19.) 76.3 (13.) 122.2 (11.)
 Trefferlage 0.10 mm links, 0.23 mm tief
 Streuwert 2.24, horizontal: 2.96, vertikal: 1.12

Unterschrift des Schützen

Ergebnis: **202.4** (195)
 Serien: 99.8 102.6
 Zähler: 16 3 1 0 0 0 0 0 0 0
 Innenzehner: 12
 weiteste: 525 (3), 440 (7), 429 (8)
 beste Teiler 38.1 (1.) 83.5 (15.) 94.0 (5.)
 Trefferlage 0.47 mm rechts, 0.86 mm hoch
 Streuwert 1.63, horizontal: 2.00, vertikal: 1.15

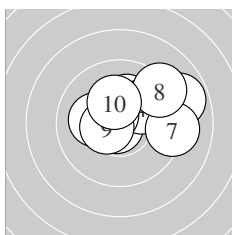
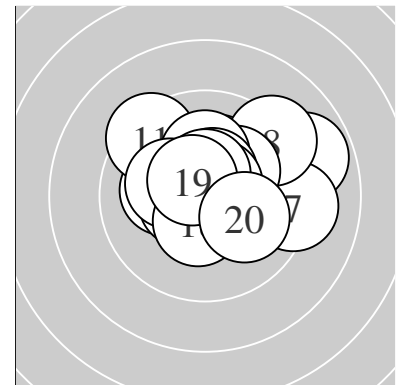

Serie 1:
 10.8 * 10.2 * 8.9 ↗ 10.1 ↗ 10.6 *
 10.1 ← 9.2 → 9.2 ↗ 10.5 * 10.2 *
 beste Teiler 38.1 (1.) 94.0 (5.) 110.4 (9.)
 Trefferlage 1.05 mm rechts, 0.94 mm hoch
 Streuwert 1.88, horizontal: 2.41, vertikal: 1.12

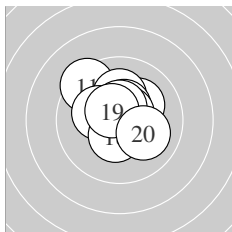

Serie 2:
 9.4 ↘ 10.2 * 10.1 ↑ 10.5 * 10.6 *
 10.5 * 10.2 * 10.4 * 10.6 * 10.1 ↘
 beste Teiler 83.5 (15.) 100.2 (19.) 107.0 (16.)
 Trefferlage 0.09 mm links, 0.79 mm hoch
 Streuwert 1.31, horizontal: 1.38, vertikal: 1.24

Unterschrift des Schützen

Ergebnis: **192.2** (184)
 Serien: 95.6 96.6
 Zähler: 5 14 1 0 0 0 0 0 0 0
 Innenzehner: 3
 weiteste: 545 (2), 487 (16), 474 (5)
 beste Teiler 121.8 (4.) 129.9 (11.) 176.1 (9.)
 Trefferlage 0.00 mm , 0.41 mm hoch
 Streuwert 2.57, horizontal: 3.24, vertikal: 1.65

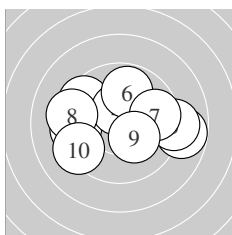
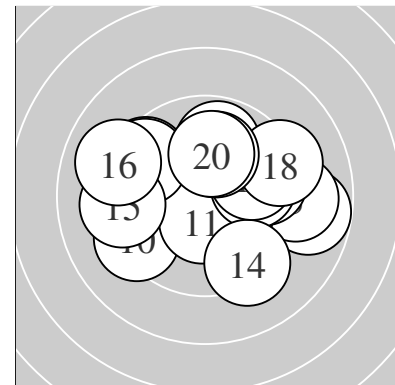

Serie 1:
 9.4 ← 8.8 → 9.5 ↖ 10.5 * 9.1 →
 9.8 ↑ 9.7 → 9.3 ← 10.2 * 9.3 ↙
 beste Teiler 121.8 (4.) 176.1 (9.) 278.6 (6.)
 Trefferlage 0.02 mm rechts, 0.23 mm hoch
 Streuwert 2.77, horizontal: 3.61, vertikal: 1.50

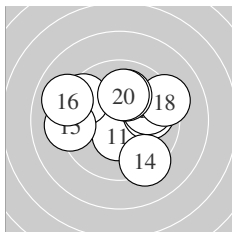

Serie 2:
 10.4 * 9.9 → 9.5 ↖ 9.3 ↘ 9.2 ←
 9.0 ↖ 9.9 → 9.2 → 10.1 ↑ 10.1 ↑
 beste Teiler 129.9 (11.) 222.4 (20.) 224.1 (19.)
 Trefferlage 0.01 mm links, 0.59 mm hoch
 Streuwert 2.51, horizontal: 3.03, vertikal: 1.85

Unterschrift des Schützen

Ergebnis: **197.3** (188)
 Serien: 99.3 98.0
 Zähler: 10 8 2 0 0 0 0 0 0 0
 Innenzehner: 10
 weiteste: 609 (9), 560 (14), 472 (2)
 beste Teiler 47.0 (13.) 86.7 (20.) 97.0 (8.)
 Trefferlage 0.17 mm rechts, 0.30 mm tief
 Streuwert 2.27, horizontal: 2.66, vertikal: 1.79

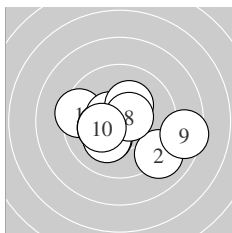
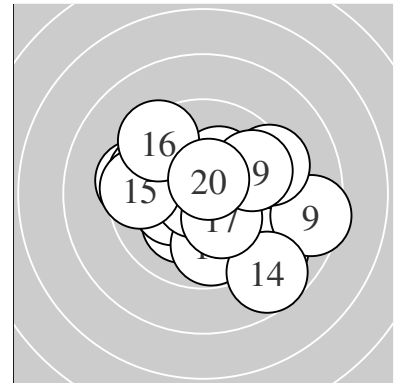

Serie 1:
 9.4 ← 9.1 ↘ 10.2 * 10.2 * 10.2 *
 10.5 * 10.3 * 10.6 * 8.5 → 10.3 *
 beste Teiler 97.0 (8.) 101.5 (6.) 173.9 (7.)
 Trefferlage 0.11 mm rechts, 0.53 mm tief
 Streuwert 2.23, horizontal: 2.85, vertikal: 1.35

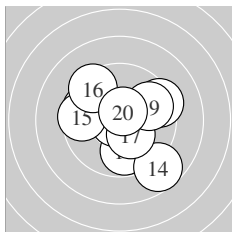

Serie 2:
 9.8 ↓ 9.7 ← 10.8 * 8.7 ↘ 9.6 ←
 9.4 ↘ 10.3 * 9.4 → 9.7 → 10.6 *
 beste Teiler 47.0 (13.) 86.7 (20.) 167.4 (17.)
 Trefferlage 0.23 mm rechts, 0.06 mm tief
 Streuwert 2.42, horizontal: 2.62, vertikal: 2.19

Unterschrift des Schützen

Ergebnis: **196.7** (187)
 Serien: 102.2 94.5
 Zähler: 10 7 3 0 0 0 0 0 0 0
 Innenzehner: 7
 weiteste: 666 (11), 568 (14), 514 (20)
 beste Teiler 31.0 (12.) 31.3 (10.) 59.5 (4.)
 Trefferlage 0.69 mm links, 0.28 mm hoch
 Streuwert 2.32, horizontal: 2.89, vertikal: 1.54

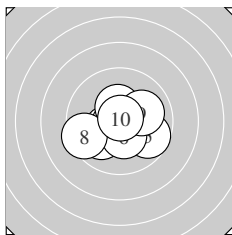
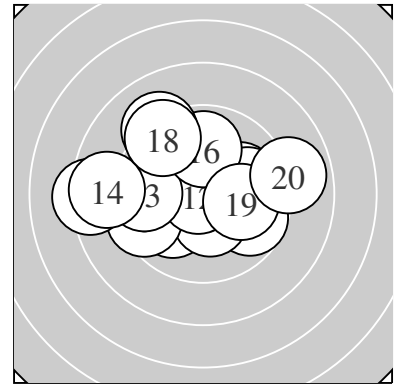

Serie 1:
 10.4 * 10.4 * 10.0 ↙ 10.7 * 9.7 ↘
 10.4 * 10.4 * 9.4 ↙ 10.0 → 10.8 *
 beste Teiler 31.3 (10.) 59.5 (4.) 130.9 (1.)
 Trefferlage 0.26 mm links, 0.52 mm tief
 Streuwert 1.48, horizontal: 1.82, vertikal: 1.04

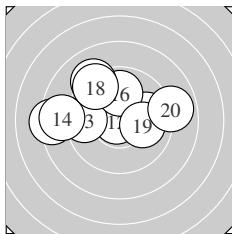

Serie 2:
 8.3 ← 10.8 * 9.6 ← 8.7 ← 9.9 →
 9.9 ↑ 9.1 ↘ 9.3 ↘ 10.0 → 8.9 →
 beste Teiler 31.0 (12.) 229.8 (19.) 264.0 (16.)
 Trefferlage 1.11 mm links, 1.08 mm hoch
 Streuwert 2.87, horizontal: 3.74, vertikal: 1.57

Unterschrift des Schützen

Ergebnis: **192.7** (184)
 Serien: 101.7 91.0
 Zähler: 13 6 0 0 0 0 0 0 0 0
 Innenzehner: 10
 weiteste: 321 (17), 315 (8), 305 (2)
 beste Teiler 61.8 (5.) 79.1 (12.) 82.8 (6.)
 Trefferlage 0.34 mm links, 0.60 mm hoch
 Streuwert 1.49, horizontal: 1.85, vertikal: 1.00

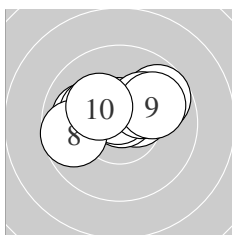
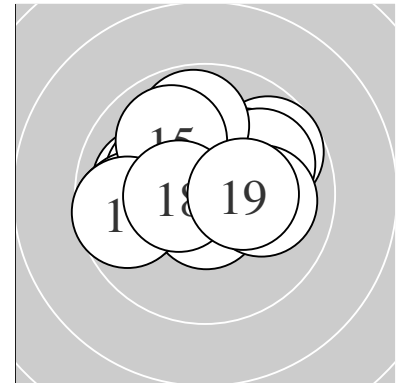

Serie 1:
 10.4 * 9.7 ↗ 10.0 ← 10.2 * 10.7 *
 10.6 * 10.2 * 9.7 ← 10.0 ↗ 10.2 *
 beste Teiler 61.8 (5.) 82.8 (6.) 128.9 (1.)
 Trefferlage 0.11 mm links, 0.77 mm hoch
 Streuwert 1.46, horizontal: 1.96, vertikal: 0.63

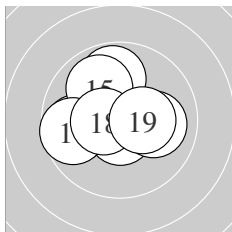

Serie 2:
 10.4 * 10.6 * 9.8 ← 9.8 ↑ 9.9 ↖
 10.0 → 9.7 ← 10.5 * 10.3 *
 beste Teiler 79.1 (12.) 106.3 (18.) 138.1 (11.)
 Trefferlage 0.60 mm links, 0.42 mm hoch
 Streuwert 1.57, horizontal: 1.79, vertikal: 1.32

Unterschrift des Schützen

Ergebnis: **199.3** (190)
 Serien: 97.6 101.7
 Zähler: 11 8 1 0 0 0 0 0 0 0
 Innenzehner: 7
 weiteste: 619 (7), 477 (18), 408 (1)
 beste Teiler 50.9 (20.) 60.8 (11.) 64.7 (12.)
 Trefferlage 0.52 mm links, 0.39 mm hoch
 Streuwert 2.01, horizontal: 2.17, vertikal: 1.83

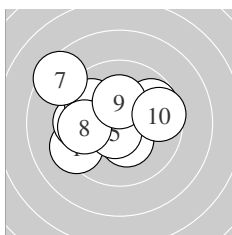
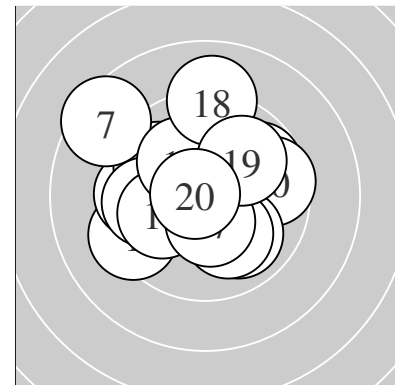

Serie 1:
 9.3 ← 10.3 * 9.6 ← 9.8 ↗ 10.6 *
 9.9 ↘ 8.5 ↘ 9.8 ← 10.2 * 9.6 →
 beste Teiler 79.6 (5.) 152.3 (2.) 178.0 (9.)
 Trefferlage 1.10 mm links, 0.49 mm hoch
 Streuwert 2.29, horizontal: 2.75, vertikal: 1.69

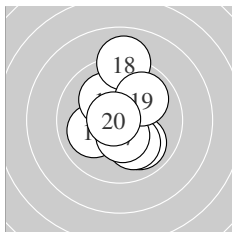

Serie 2:
 10.7 * 10.7 * 10.0 ← 10.0 ↘ 10.1 ↘
 10.1 ↘ 10.4 * 9.0 ↑ 9.9 ↗ 10.8 *
 beste Teiler 50.9 (20.) 60.8 (11.) 64.7 (12.)
 Trefferlage 0.05 mm rechts, 0.30 mm hoch
 Streuwert 1.70, horizontal: 1.26, vertikal: 2.04

Unterschrift des Schützen

Ergebnis: **194.0** (184)
 Serien: 96.6 97.4
 Zähler: 9 7 3 1 0 0 0 0 0 0
 Innenzehner: 4
 weiteste: 793 (9), 642 (3), 575 (20)
 beste Teiler 90.2 (7.) 105.5 (10.) 113.8 (16.)
 Trefferlage 0.31 mm links, 0.72 mm hoch
 Streuwert 2.57, horizontal: 3.32, vertikal: 1.48

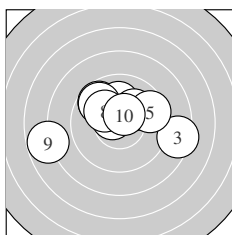
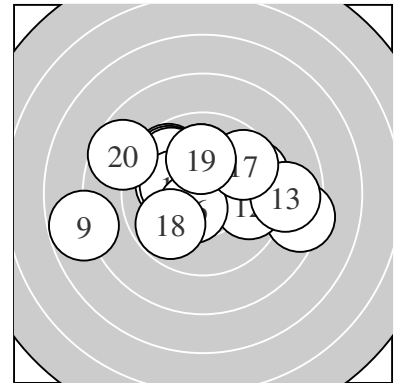

Serie 1:
 9.7 ↘ 10.1 ↑ 8.4 → 10.1 ↗ 9.6 →
 9.7 ↘ 10.6 * 10.1 ↘ 7.8 ← 10.5 *
 beste Teiler 90.2 (7.) 105.5 (10.) 205.3 (8.)
 Trefferlage 0.30 mm links, 0.84 mm hoch
 Streuwert 2.82, horizontal: 3.70, vertikal: 1.50

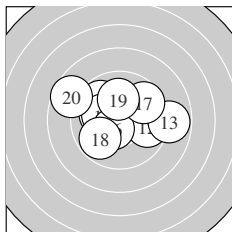

Serie 2:
 10.1 ← 9.7 → 8.8 → 9.8 ↘ 10.2 *
 10.5 * 9.7 ↗ 9.8 ↙ 10.1 ↑ 8.7 ↘
 beste Teiler 113.8 (16.) 191.0 (15.) 218.1 (11.)
 Trefferlage 0.32 mm links, 0.60 mm hoch
 Streuwert 2.44, horizontal: 3.09, vertikal: 1.53

Unterschrift des Schützen

Ergebnis: **196.3** (187)
 Serien: 98.0 98.3
 Zähler: 9 9 2 0 0 0 0 0 0 0
 Innenzehner: 9
 weiteste: 586 (13), 527 (10), 467 (12)
 beste Teiler 74.3 (19.) 84.7 (17.) 116.7 (7.)
 Trefferlage 0.64 mm rechts, 0.49 mm tief
 Streuwert 2.26, horizontal: 2.69, vertikal: 1.74

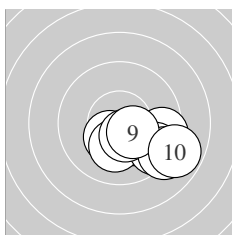
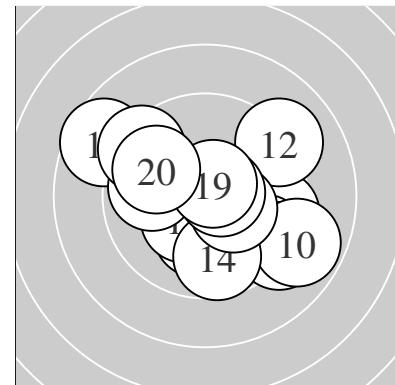

Serie 1:
 10.2 * 9.4 ↘ 10.4 * 10.2 * 9.5 →
 9.5 ↘ 10.5 * 9.1 ↘ 10.4 * 8.8 ↘
 beste Teiler 116.7 (7.) 136.7 (9.) 144.0 (3.)
 Trefferlage 2.04 mm rechts, 1.55 mm tief
 Streuwert 1.45, horizontal: 1.95, vertikal: 0.65

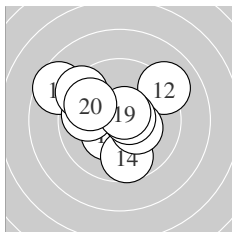

Serie 2:
 10.3 * 9.1 ↗ 8.6 ↖ 9.7 ↓ 10.3 *
 9.9 ← 10.6 * 9.3 ↖ 10.7 * 9.8 ↖
 beste Teiler 74.3 (19.) 84.7 (17.) 157.2 (11.)
 Trefferlage 0.75 mm links, 0.55 mm hoch
 Streuwert 2.30, horizontal: 2.67, vertikal: 1.87

Unterschrift des Schützen

Ergebnis: **197.4** (187)
 Serien: 99.8 97.6
 Zähler: 9 9 2 0 0 0 0 0 0 0
 Innenzehner: 9
 weiteste: 631 (3), 513 (11), 500 (8)
 beste Teiler 5.0 (4.) 48.2 (20.) 103.1 (10.)
 Trefferlage 0.57 mm rechts, 0.01 mm hoch
 Streuwert 2.27, horizontal: 2.94, vertikal: 1.30

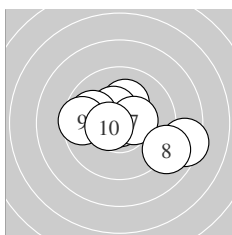
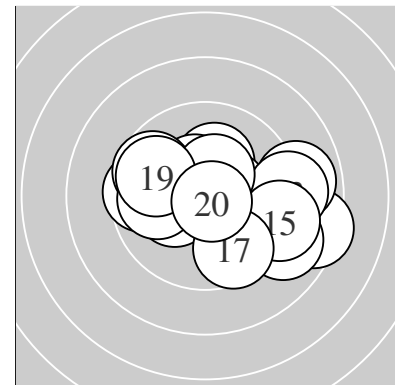

Serie 1:
 10.5 * 10.2 * 8.4 → 10.9 * 10.4 *
 9.9 ← 10.4 * 9.0 ↘ 9.6 ← 10.5 *
 beste Teiler 5.0 (4.) 103.1 (10.) 113.8 (1.)
 Trefferlage 0.51 mm rechts, 0.09 mm hoch
 Streuwert 2.25, horizontal: 2.88, vertikal: 1.33

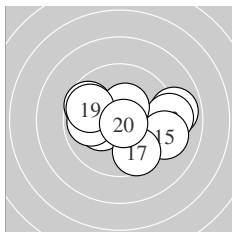

Serie 2:
 8.9 → 9.7 ← 9.1 → 10.2 * 9.2 →
 10.4 * 9.6 ↓ 9.9 ← 9.8 ← 10.8 *
 beste Teiler 48.2 (20.) 130.7 (16.) 179.3 (14.)
 Trefferlage 0.63 mm rechts, 0.06 mm tief
 Streuwert 2.42, horizontal: 3.15, vertikal: 1.34

Unterschrift des Schützen

Ergebnis: **183.7** (174)
 Serien: 93.5 90.2
 Zähler: 6 7 4 2 0 1 0 0 0 0
 Innenzehner: 4
 weiteste: 1397 (20), 910 (9), 807 (7)
 beste Teiler 71.5 (10.) 120.2 (1.) 123.3 (2.)
 Trefferlage 0.27 mm links, 0.07 mm tief
 Streuwert 3.95, horizontal: 4.53, vertikal: 3.27

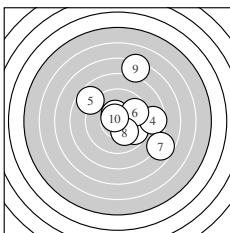
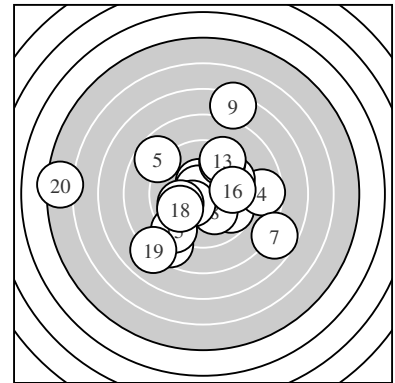

Serie 1:
 10.5 * 10.5 * 9.7 ↘ 8.6 → 8.7 ↖
 9.7 ↗ 7.7 ↘ 10.1 ↘ 7.3 ↑ 10.7 *
 beste Teiler 71.5 (10.) 120.2 (1.) 123.3 (2.)
 Trefferlage 1.81 mm rechts, 0.80 mm hoch
 Streuwert 3.34, horizontal: 3.26, vertikal: 3.41

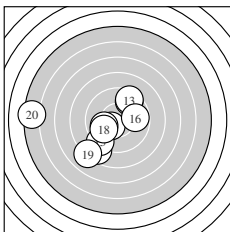

Serie 2:
 10.4 * 9.5 ↗ 9.4 ↗ 8.6 ↙ 9.2 ↙
 9.8 → 10.0 ← 9.9 ← 8.0 ↙ 5.4 ←
 beste Teiler 139.4 (11.) 238.4 (17.) 266.8 (18.)
 Trefferlage 2.36 mm links, 0.95 mm tief
 Streuwert 4.01, horizontal: 4.80, vertikal: 3.03

Unterschrift des Schützen

Ergebnis: **191.7** (184)
 Serien: 94.9 96.8
 Zähler: 6 12 2 0 0 0 0 0 0 0
 Innenzehner: 4
 weiteste: 736 (7), 679 (20), 480 (3)
 beste Teiler 78.8 (14.) 102.7 (19.) 156.7 (18.)
 Trefferlage 0.63 mm links, 0.11 mm tief
 Streuwert 2.72, horizontal: 3.61, vertikal: 1.34

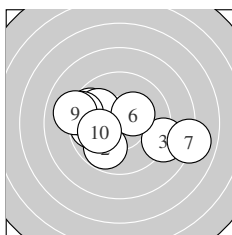
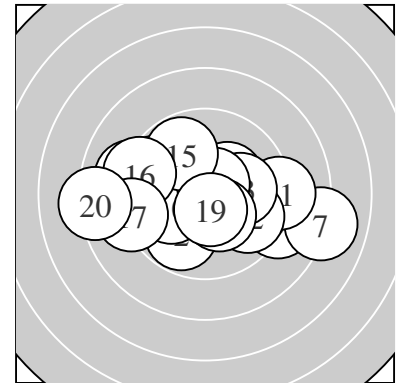

Serie 1:
 9.6 ↖ 9.8 ↙ 9.0 → 9.8 ← 9.9 ↘
 10.3 * 8.0 → 9.3 ← 9.1 ← 10.1 ←
 beste Teiler 166.7 (6.) 222.6 (10.) 252.1 (5.)
 Trefferlage 0.69 mm links, 0.15 mm tief
 Streuwert 2.90, horizontal: 3.83, vertikal: 1.47

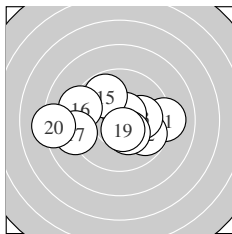

Serie 2:
 9.1 → 9.8 → 10.1 → 10.6 * 9.8 ↗
 9.3 ↖ 9.1 ← 10.3 * 10.5 * 8.2 ←
 beste Teiler 78.8 (14.) 102.7 (19.) 156.7 (18.)
 Trefferlage 0.57 mm links, 0.08 mm tief
 Streuwert 2.68, horizontal: 3.57, vertikal: 1.27

Unterschrift des Schützen

Ergebnis: **183.9** (176)
 Serien: 92.3 91.6
 Zähler: 5 7 7 1 0 0 0 0 0 0
 Innenzehner: 2
 weiteste: 890 (12), 714 (19), 684 (8)
 beste Teiler 136.0 (20.) 139.2 (15.) 205.4 (11.)
 Trefferlage 1.09 mm links, 0.03 mm tief
 Streuwert 3.42, horizontal: 4.62, vertikal: 1.44

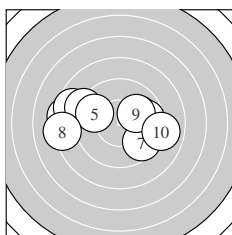
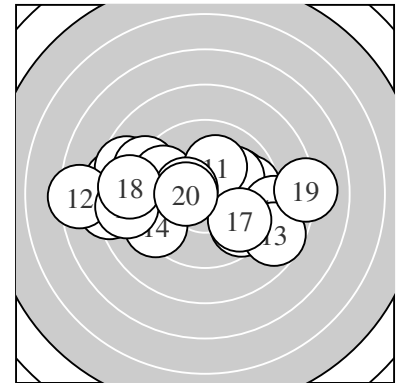

Serie 1:
 8.4 ← 8.6 ↖ 9.1 ↖ 10.0 → 9.7 ↖
 9.7 → 9.6 ↘ 8.2 ← 10.0 → 9.0 →
 beste Teiler 227.2 (9.) 245.3 (4.) 313.0 (6.)
 Trefferlage 1.11 mm links, 0.42 mm hoch
 Streuwert 3.31, horizontal: 4.48, vertikal: 1.35

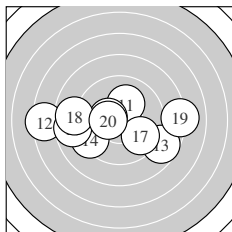

Serie 2:
 10.1 ↗ 7.4 ← 8.7 ↘ 9.3 ↙ 10.4 *
 8.7 ← 9.7 ↘ 8.8 ← 8.1 → 10.4 *
 beste Teiler 136.0 (20.) 139.2 (15.) 205.4 (11.)
 Trefferlage 1.07 mm links, 0.49 mm tief
 Streuwert 3.68, horizontal: 4.99, vertikal: 1.45

Unterschrift des Schützen

Ergebnis: **192.8** (183)
 Serien: 99.9 92.9
 Zähler: 8 8 3 1 0 0 0 0 0 0
 Innenzehner: 6
 weiteste: 938 (13), 576 (20), 548 (14)
 beste Teiler 39.6 (10.) 129.6 (6.) 137.1 (16.)
 Trefferlage 0.35 mm links, 0.78 mm hoch
 Streuwert 2.71, horizontal: 3.35, vertikal: 1.84

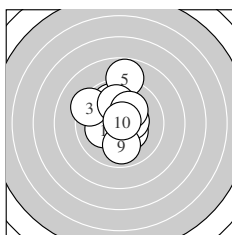
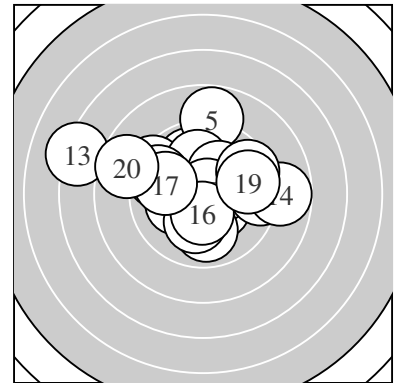

Serie 1:
 10.2 * 9.9 ↖ 9.3 ↗ 10.4 * 8.8 ↑
 10.4 * 10.0 ↑ 10.2 * 9.9 ↓ 10.8 *
 beste Teiler 39.6 (10.) 129.6 (6.) 148.3 (4.)
 Trefferlage 0.21 mm links, 0.98 mm hoch
 Streuwert 1.91, horizontal: 1.55, vertikal: 2.22

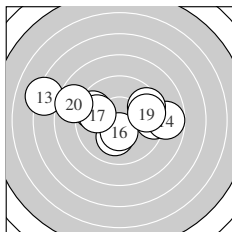

Serie 2:
 9.6 ↖ 9.3 → 7.2 ↖ 8.8 → 10.1 ↓
 10.4 * 9.8 ↖ 9.5 ↗ 9.6 → 8.6 ↖
 beste Teiler 137.1 (16.) 204.5 (15.) 278.2 (17.)
 Trefferlage 0.49 mm links, 0.58 mm hoch
 Streuwert 3.43, horizontal: 4.62, vertikal: 1.47

Unterschrift des Schützen

Ergebnis: **198.5** (189)
 Serien: 99.0 99.5
 Zähler: 10 9 1 0 0 0 0 0 0 0
 Innenzehner: 8
 weiteste: 656 (8), 462 (13), 419 (15)
 beste Teiler 82.4 (12.) 88.6 (5.) 105.0 (2.)
 Trefferlage 0.10 mm links, 0.01 mm hoch
 Streuwert 2.12, horizontal: 2.73, vertikal: 1.25

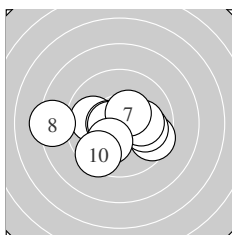
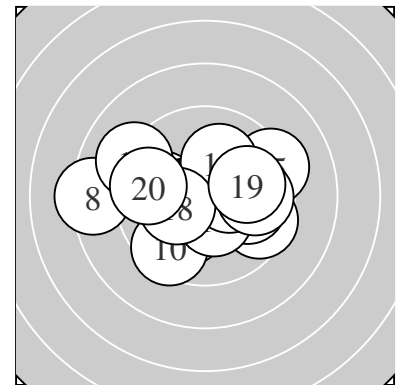

Serie 1:
 9.9 ← 10.5 * 9.6 ↘ 9.9 → 10.6 *
 10.1 → 10.4 * 8.3 ← 10.2 * 9.5 ↙
 beste Teiler 88.6 (5.) 105.0 (2.) 128.3 (7.)
 Trefferlage 0.54 mm links, 0.55 mm tief
 Streuwert 2.21, horizontal: 2.90, vertikal: 1.18

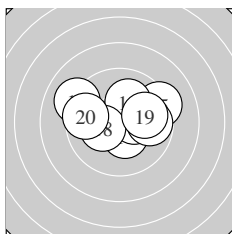

Serie 2:
 10.4 * 10.6 * 9.1 ↖ 10.4 * 9.3 →
 10.1 ↗ 9.8 → 10.3 * 9.9 → 9.6 ←
 beste Teiler 82.4 (12.) 139.4 (11.) 142.2 (14.)
 Trefferlage 0.33 mm rechts, 0.58 mm hoch
 Streuwert 2.02, horizontal: 2.63, vertikal: 1.10

Unterschrift des Schützen

Ergebnis: **198.7** (190)
 Serien: 101.1 97.6
 Zähler: 10 10 0 0 0 0 0 0 0 0
 Innenzehner: 6
 weiteste: 437 (18), 424 (5), 359 (9)
 beste Teiler 16.4 (7.) 86.2 (6.) 148.5 (1.)
 Trefferlage 0.36 mm rechts, 0.89 mm hoch
 Streuwert 1.88, horizontal: 2.36, vertikal: 1.24

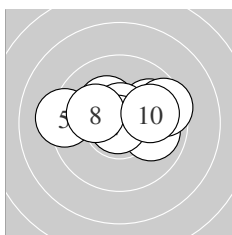
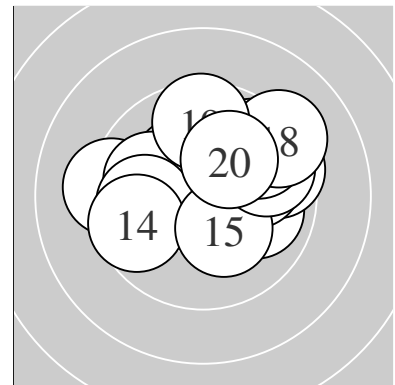

Serie 1:
 10.4 * 10.0 → 9.9 ↗ 10.3 * 9.3 ←
 10.6 * 10.9 * 10.2 * 9.5 → 10.0 →
 beste Teiler 16.4 (7.) 86.2 (6.) 148.5 (1.)
 Trefferlage 0.22 mm rechts, 0.68 mm hoch
 Streuwert 1.74, horizontal: 2.38, vertikal: 0.64

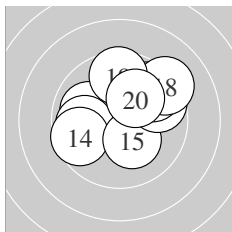

Serie 2:
 10.0 ↖ 9.7 ↗ 9.9 ← 9.6 ← 10.2 *
 9.7 → 9.6 ↗ 9.2 ↗ 9.6 ↑ 10.1 ↗
 beste Teiler 177.2 (15.) 207.0 (20.) 246.7 (11.)
 Trefferlage 0.51 mm rechts, 1.10 mm hoch
 Streuwert 2.10, horizontal: 2.45, vertikal: 1.66

Unterschrift des Schützen

Ergebnis: **178.3** (170)
 Serien: 91.5 86.8
 Zähler: 6 3 7 3 1 0 0 0 0 0
 Innenzehner: 5
 weiteste: 1027 (2), 969 (18), 866 (15)
 beste Teiler 120.8 (7.) 130.0 (16.) 130.2 (5.)
 Trefferlage 3.75 mm links, 0.47 mm tief
 Streuwert 3.23, horizontal: 3.73, vertikal: 2.64

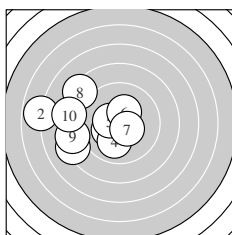
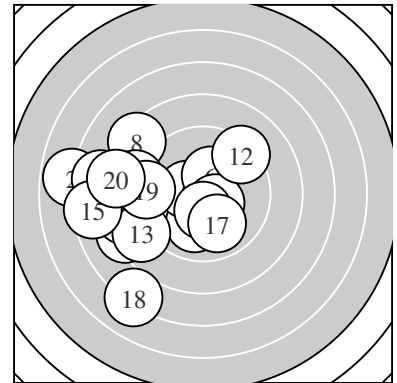

Serie 1:
 8.2 ↙ 6.8 ← 10.3 * 10.0 ↓ 10.4 *
 10.3 * 10.5 * 8.3 ↘ 8.4 ← 8.3 ←
 beste Teiler 120.8 (7.) 130.2 (5.) 155.6 (6.)
 Trefferlage 3.58 mm links, 0.04 mm tief
 Streuwert 3.03, horizontal: 3.72, vertikal: 2.12

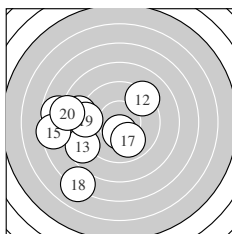

Serie 2:
 7.7 ← 9.3 ↗ 8.7 ↙ 8.8 ← 7.5 ←
 10.4 * 9.9 ↓ 7.1 ↙ 9.2 ← 8.2 ←
 beste Teiler 130.0 (16.) 253.6 (17.) 425.0 (12.)
 Trefferlage 3.91 mm links, 0.90 mm tief
 Streuwert 3.55, horizontal: 3.93, vertikal: 3.12

Unterschrift des Schützen

Ergebnis: **199.1** (190)
 Serien: 98.6 100.5
 Zähler: 10 10 0 0 0 0 0 0 0 0
 Innenzehner: 9
 weiteste: 470 (19), 440 (1), 427 (2)
 beste Teiler 57.8 (13.) 94.8 (20.) 97.5 (7.)
 Trefferlage 0.02 mm links, 0.30 mm tief
 Streuwert 2.02, horizontal: 1.89, vertikal: 2.14

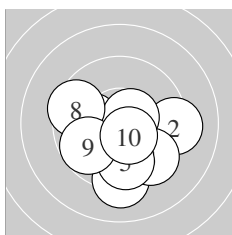
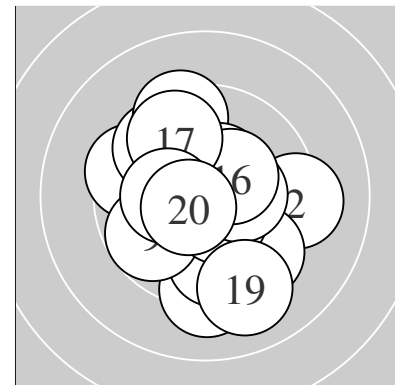

Serie 1:
 9.2 ↓ 9.2 → 9.5 ↘ 10.5 * 9.8 ↓
 10.1 ← 10.6 * 9.5 ↙ 9.7 ↖ 10.5 *
 beste Teiler 97.5 (7.) 101.2 (4.) 120.8 (10.)
 Trefferlage 0.08 mm rechts, 1.22 mm tief
 Streuwert 2.04, horizontal: 2.31, vertikal: 1.73

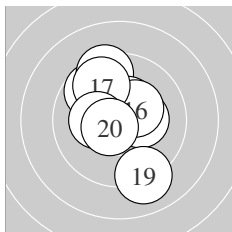

Serie 2:
 9.7 ↘ 9.4 ↑ 10.7 * 10.4 * 10.3 *
 10.3 * 9.7 ↘ 10.3 * 9.1 ↓ 10.6 *
 beste Teiler 57.8 (13.) 94.8 (20.) 134.1 (14.)
 Trefferlage 0.13 mm links, 0.62 mm hoch
 Streuwert 1.87, horizontal: 1.48, vertikal: 2.19

Unterschrift des Schützen

Ergebnis: **194.4** (185)
 Serien: 95.3 99.1
 Zähler: 8 9 3 0 0 0 0 0 0 0
 Innenzehner: 6
 weiteste: 711 (17), 684 (1), 529 (6)
 beste Teiler 52.3 (9.) 52.7 (20.) 129.8 (12.)
 Trefferlage 0.29 mm links, 0.52 mm hoch
 Streuwert 2.53, horizontal: 3.00, vertikal: 1.95

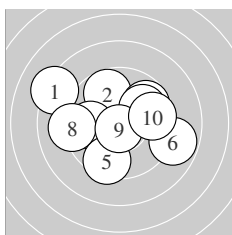
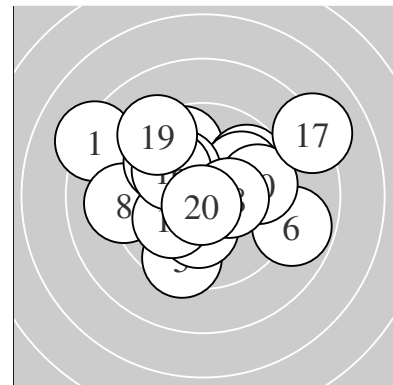

Serie 1:
 8.2 ↘ 9.7 ↖ 9.7 ↗ 9.9 ← 9.5 ↓
 8.8 → 9.9 ↗ 9.2 ← 10.7 * 9.7 →
 beste Teiler 52.3 (9.) 256.8 (7.) 273.5 (4.)
 Trefferlage 0.29 mm links, 0.34 mm hoch
 Streuwert 2.88, horizontal: 3.53, vertikal: 2.04

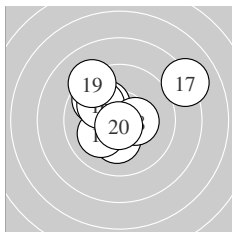

Serie 2:
 9.8 ↘ 10.4 * 10.2 * 10.1 ↙ 10.2 *
 10.0 ↘ 8.1 ↗ 10.4 * 9.2 ↖ 10.7 *
 beste Teiler 52.7 (20.) 129.8 (12.) 147.4 (18.)
 Trefferlage 0.29 mm links, 0.70 mm hoch
 Streuwert 2.28, horizontal: 2.57, vertikal: 1.94

Unterschrift des Schützen

Ergebnis: **196.4** (187)
 Serien: 99.1 97.3
 Zähler: 12 4 3 1 0 0 0 0 0 0
 Innenzehner: 7
 weiteste: 783 (16), 568 (1), 525 (13)
 beste Teiler 72.8 (5.) 78.4 (4.) 138.8 (15.)
 Trefferlage 0.16 mm rechts, 0.35 mm tief
 Streuwert 2.43, horizontal: 2.67, vertikal: 2.16

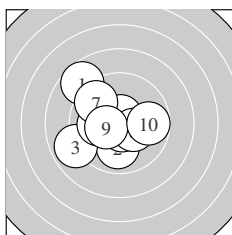
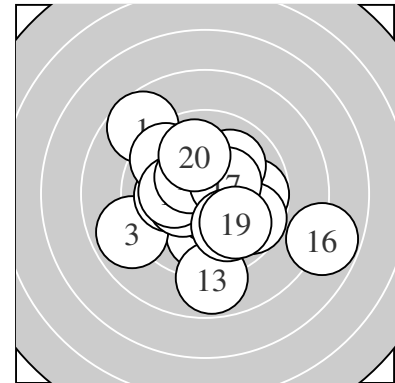

Serie 1:
 8.7 ↘ 10.0 ↓ 8.9 ↙ 10.6 * 10.7 *
 10.1 ← 9.6 ↘ 10.3 * 10.4 * 9.8 →
 beste Teiler 72.8 (5.) 78.4 (4.) 145.4 (9.)
 Trefferlage 0.98 mm links, 0.01 mm hoch
 Streuwert 2.18, horizontal: 2.36, vertikal: 1.99

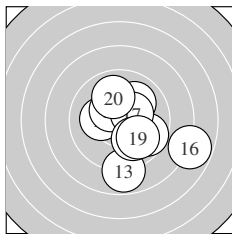

Serie 2:
 9.7 ↘ 10.2 * 8.9 ↓ 10.0 ↗ 10.4 *
 7.8 ↘ 10.4 * 10.0 ↘ 9.9 ↘ 10.0 ↑
 beste Teiler 138.8 (15.) 144.9 (17.) 192.4 (12.)
 Trefferlage 1.31 mm rechts, 0.72 mm tief
 Streuwert 2.46, horizontal: 2.56, vertikal: 2.36

Unterschrift des Schützen

Ergebnis: **191.2** (181)
 Serien: 96.0 95.2
 Zähler: 6 9 5 0 0 0 0 0 0 0
 Innenzehner: 3
 weiteste: 661 (10), 620 (18), 570 (7)
 beste Teiler 57.2 (2.) 190.1 (6.) 190.9 (16.)
 Trefferlage 0.21 mm links, 0.53 mm tief
 Streuwert 2.77, horizontal: 3.07, vertikal: 2.42

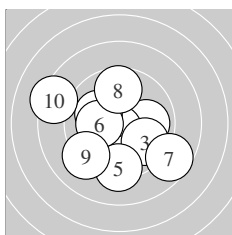
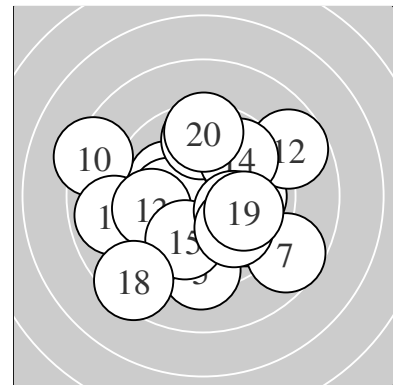

Serie 1:
 10.0 → 10.7 * 9.8 ↘ 10.1 ↖ 9.3 ↓
 10.2 * 8.7 ↘ 9.7 ↑ 9.2 ↙ 8.3 ↖
 beste Teiler 57.2 (2.) 190.1 (6.) 218.1 (4.)
 Trefferlage 0.41 mm links, 0.66 mm tief
 Streuwert 2.80, horizontal: 3.14, vertikal: 2.41

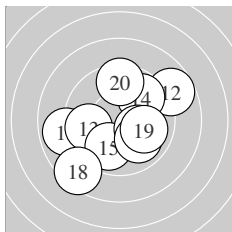

Serie 2:
 8.9 ← 8.7 ↗ 9.8 ← 9.8 ↗ 9.9 ↓
 10.2 * 9.9 ↘ 8.5 ↙ 10.0 → 9.5 ↑
 beste Teiler 190.9 (16.) 246.4 (19.) 251.7 (17.)
 Trefferlage 0.02 mm links, 0.41 mm tief
 Streuwert 2.87, horizontal: 3.16, vertikal: 2.55

Unterschrift des Schützen

Ergebnis: **198.6** (190)
 Serien: 98.5 100.1
 Zähler: 13 4 3 0 0 0 0 0 0 0
 Innenzehner: 9
 weiteste: 606 (3), 542 (8), 541 (4)
 beste Teiler 72.1 (7.) 85.4 (5.) 118.5 (16.)
 Trefferlage 0.34 mm links, 0.50 mm hoch
 Streuwert 2.13, horizontal: 2.60, vertikal: 1.53

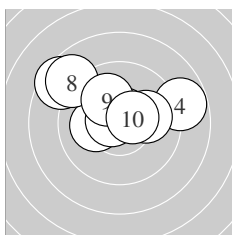
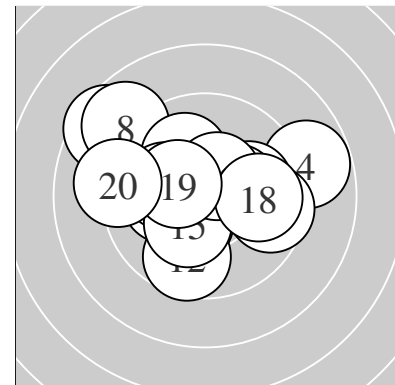

Serie 1:
 10.4 * 10.1 ← 8.5 ↖ 8.8 → 10.6 *
 10.0 → 10.7 * 8.8 ↖ 10.1 ↖ 10.5 *
 beste Teiler 72.1 (7.) 85.4 (5.) 120.4 (10.)
 Trefferlage 0.46 mm links, 1.35 mm hoch
 Streuwert 2.28, horizontal: 2.96, vertikal: 1.30

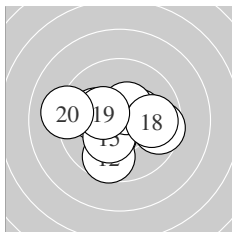

Serie 2:
 10.3 * 9.7 ↓ 10.3 * 10.1 ← 10.3 *
 10.5 * 9.6 → 9.9 → 10.3 * 9.1 ←
 beste Teiler 118.5 (16.) 152.7 (19.) 156.4 (11.)
 Trefferlage 0.22 mm links, 0.34 mm tief
 Streuwert 1.89, horizontal: 2.34, vertikal: 1.29

Unterschrift des Schützen

Ergebnis: **178.0** (171)
 Serien: 90.8 87.2
 Zähler: 5 6 6 1 2 0 0 0 0 0
 Innenzehner: 3
 weiteste: 1240 (9), 1147 (11), 856 (20)
 beste Teiler 151.3 (1.) 160.0 (10.) 200.3 (13.)
 Trefferlage 0.60 mm links, 0.78 mm tief
 Streuwert 4.26, horizontal: 4.58, vertikal: 3.92

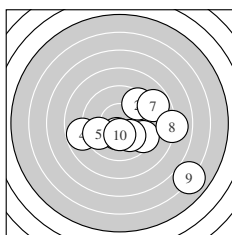
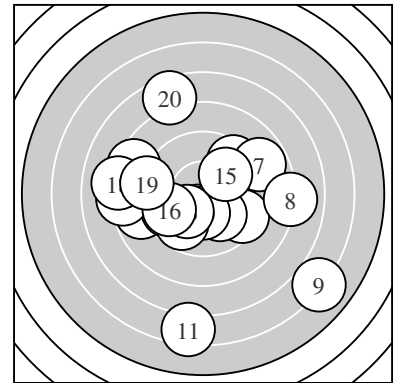

Serie 1:
 10.3 * 9.5 ↗ 9.4 ↘ 8.8 ← 9.6 ↙
 10.1 ↘ 8.8 ↗ 8.0 → 6.0 ↘ 10.3 *
 beste Teiler 151.3 (1.) 160.0 (10.) 224.4 (6.)
 Trefferlage 2.06 mm rechts, 1.25 mm tief
 Streuwert 3.78, horizontal: 4.53, vertikal: 2.83

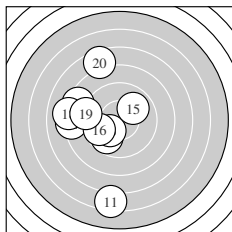

Serie 2:
 6.4 ↓ 9.7 ↙ 10.2 * 8.2 ← 10.0 ↗
 9.7 ↙ 8.4 ↖ 8.1 ← 9.0 ← 7.5 ↖
 beste Teiler 200.3 (13.) 250.8 (15.) 304.4 (12.)
 Trefferlage 3.26 mm links, 0.31 mm tief
 Streuwert 4.00, horizontal: 2.84, vertikal: 4.89

Unterschrift des Schützen

Ergebnis: **190.2** (182)
 Serien: 97.7 92.5
 Zähler: 7 8 5 0 0 0 0 0 0 0
 Innenzehner: 4
 weiteste: 726 (19), 614 (16), 582 (12)
 beste Teiler 153.5 (9.) 163.7 (8.) 173.6 (5.)
 Trefferlage 0.29 mm links, 0.88 mm tief
 Streuwert 2.81, horizontal: 3.45, vertikal: 1.98

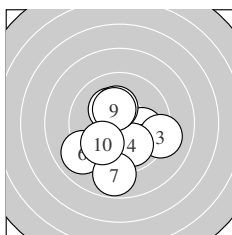
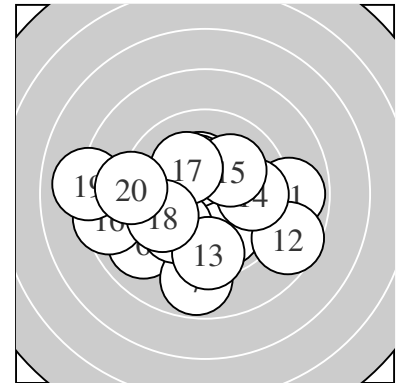

Serie 1:
 10.0 ↘ 10.0 → 9.2 → 9.9 ↘ 10.3 *
 9.0 ↙ 8.8 ↓ 10.3 * 10.3 * 9.9 ↙
 beste Teiler 153.5 (9.) 163.7 (8.) 173.6 (5.)
 Trefferlage 0.06 mm rechts, 1.23 mm tief
 Streuwert 2.23, horizontal: 2.24, vertikal: 2.23

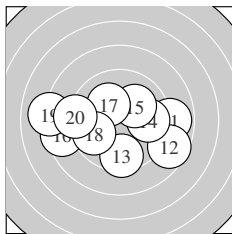

Serie 2:
 8.9 → 8.6 → 9.5 ↓ 9.8 → 10.1 ↗
 8.5 ← 10.2 * 9.8 ↙ 8.0 ← 9.1 ←
 beste Teiler 197.0 (17.) 214.3 (15.) 295.0 (14.)
 Trefferlage 0.65 mm links, 0.52 mm tief
 Streuwert 3.38, horizontal: 4.45, vertikal: 1.75

Unterschrift des Schützen

Ergebnis: **202.3** (193)
 Serien: 101.7 100.6
 Zähler: 14 5 1 0 0 0 0 0 0 0
 Innenzehner: 12
 weiteste: 623 (12), 384 (14), 358 (6)
 beste Teiler 49.2 (17.) 67.0 (8.) 70.4 (20.)
 Trefferlage 0.45 mm rechts, 0.07 mm hoch
 Streuwert 1.80, horizontal: 1.96, vertikal: 1.62

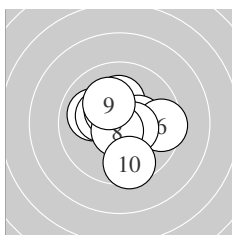
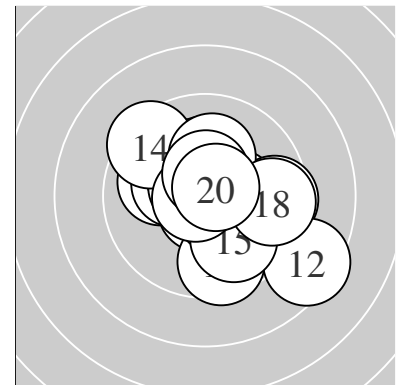

Serie 1:
 10.0 ↖ 10.2 * 10.3 * 10.3 * 10.4 *
 9.5 → 10.5 * 10.7 * 10.2 * 9.6 ↓
 beste Teiler 67.0 (8.) 117.7 (7.) 134.4 (5.)
 Trefferlage 0.12 mm rechts, 0.15 mm hoch
 Streuwert 1.60, horizontal: 1.70, vertikal: 1.50

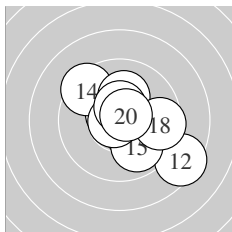

Serie 2:
 10.5 * 8.5 ↘ 10.6 * 9.4 ↘ 9.9 ↘
 10.1 ↑ 10.8 * 9.6 → 10.5 * 10.7 *
 beste Teiler 49.2 (17.) 70.4 (20.) 85.0 (13.)
 Trefferlage 0.78 mm rechts, 0.00 mm
 Streuwert 2.03, horizontal: 2.23, vertikal: 1.82

Unterschrift des Schützen

Ergebnis: **185.7** (177)
 Serien: 92.8 92.9
 Zähler: 4 9 7 0 0 0 0 0 0 0
 Innenzehner: 3
 weiteste: 641 (17), 609 (11), 603 (18)
 beste Teiler 35.5 (16.) 100.5 (7.) 102.0 (14.)
 Trefferlage 1.75 mm links, 0.25 mm hoch
 Streuwert 3.00, horizontal: 3.08, vertikal: 2.92

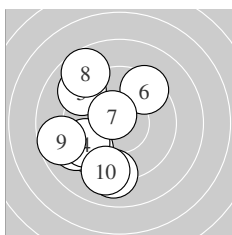
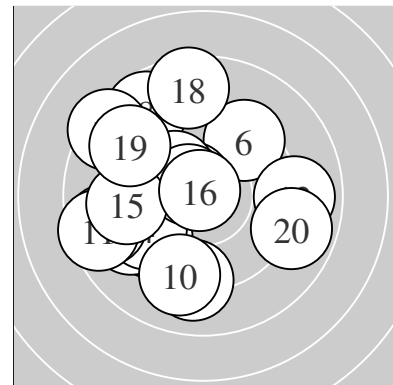

Serie 1:
 9.5 ↙ 9.1 ↙ 9.1 ↓ 9.5 ↙ 9.1 ↘
 9.4 ↗ 10.6 * 8.7 ↘ 8.7 ↙ 9.1 ↓
 beste Teiler 100.5 (7.) 364.2 (4.) 365.9 (1.)
 Trefferlage 2.22 mm links, 0.54 mm tief
 Streuwert 2.76, horizontal: 2.19, vertikal: 3.24

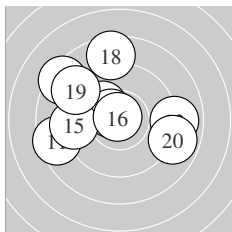

Serie 2:
 8.5 ↙ 8.9 → 10.1 ↘ 10.5 * 9.3 ←
 10.8 * 8.4 ↘ 8.5 ↑ 9.0 ↘ 8.9 →
 beste Teiler 35.5 (16.) 102.0 (14.) 207.7 (13.)
 Trefferlage 1.27 mm links, 1.05 mm hoch
 Streuwert 3.23, horizontal: 3.84, vertikal: 2.48

Unterschrift des Schützen

Ergebnis: **189.2** (183)
 Serien: 92.0 97.2
 Zähler: 8 8 3 1 0 0 0 0 0 0
 Innenzehner: 5
 weiteste: 966 (10), 750 (17), 619 (4)
 beste Teiler 88.5 (14.) 101.2 (6.) 136.5 (18.)
 Trefferlage 0.15 mm rechts, 0.35 mm hoch
 Streuwert 3.17, horizontal: 4.13, vertikal: 1.72

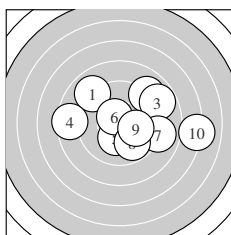
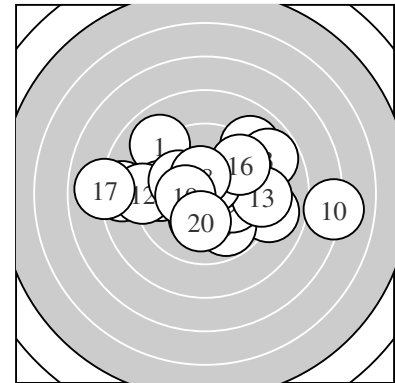

Serie 1:
 9.0 ↘ 9.0 ↗ 8.8 ↗ 8.5 ← 10.2 *
 10.5 * 9.0 → 9.8 ↘ 10.1 → 7.1 →
 beste Teiler 101.2 (6.) 183.1 (5.) 211.5 (9.)
 Trefferlage 1.53 mm rechts, 0.35 mm hoch
 Streuwert 3.55, horizontal: 4.49, vertikal: 2.23

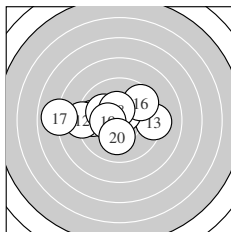

Serie 2:
 9.6 ← 9.1 ← 9.3 → 10.6 * 10.1 ↘
 9.6 ↗ 8.0 ← 10.4 * 10.4 * 10.1 ↓
 beste Teiler 88.5 (14.) 136.5 (18.) 147.4 (19.)
 Trefferlage 1.23 mm links, 0.35 mm hoch
 Streuwert 2.54, horizontal: 3.41, vertikal: 1.12

Unterschrift des Schützen

Ergebnis: **197.4** (191)
 Serien: 96.8 100.6
 Zähler: 12 7 1 0 0 0 0 0 0 0
 Innenzehner: 7
 weiteste: 523 (2), 478 (11), 451 (7)
 beste Teiler 31.5 (15.) 97.8 (12.) 150.3 (16.)
 Trefferlage 0.09 mm rechts, 1.29 mm hoch
 Streuwert 1.97, horizontal: 2.00, vertikal: 1.94

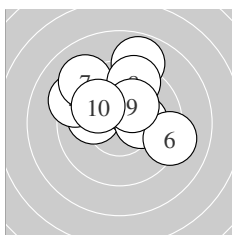
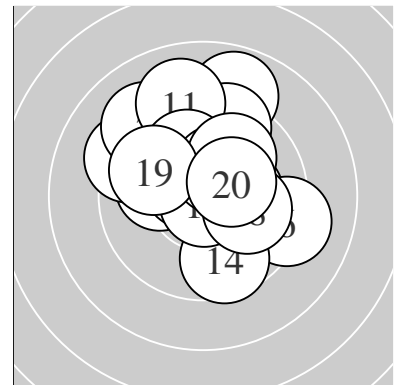

Serie 1:
 10.1 ← 8.9 ↑ 10.3 * 9.3 ↖ 10.2 *
 9.2 → 9.1 ↘ 9.5 ↑ 10.2 * 10.0 ↗
 beste Teiler 160.8 (3.) 179.4 (5.) 180.4 (9.)
 Trefferlage 0.01 mm rechts, 1.73 mm hoch
 Streuwert 2.20, horizontal: 2.51, vertikal: 1.83

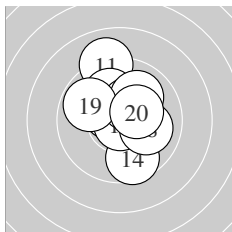

Serie 2:
 9.0 ↑ 10.6 * 10.1 ↖ 9.6 ↓ 10.8 *
 10.4 * 10.0 ↗ 10.0 → 9.8 ↖ 10.3 *
 beste Teiler 31.5 (15.) 97.8 (12.) 150.3 (16.)
 Trefferlage 0.17 mm rechts, 0.84 mm hoch
 Streuwert 1.77, horizontal: 1.46, vertikal: 2.03

Unterschrift des Schützen

Ergebnis: **187.7** (180)
 Serien: 95.0 92.7
 Zähler: 5 11 3 1 0 0 0 0 0 0
 Innenzehner: 4
 weiteste: 781 (5), 652 (18), 645 (10)
 beste Teiler 80.0 (1.) 136.9 (2.) 163.1 (8.)
 Trefferlage 1.01 mm links, 0.32 mm tief
 Streuwert 3.02, horizontal: 2.30, vertikal: 3.59

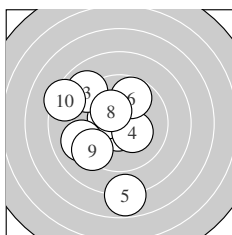
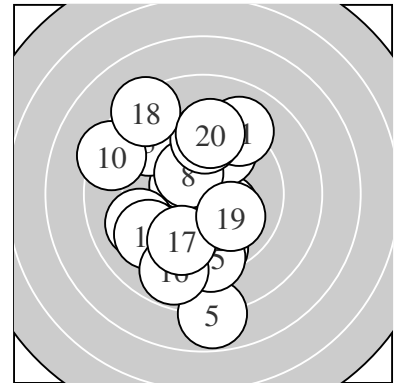

Serie 1:
 10.6 * 10.4 * 9.0 ↘ 10.3 * 7.8 ↓
 9.8 ↗ 9.1 ← 10.3 * 9.3 ✓ 8.4 ↖
 beste Teiler 80.0 (1.) 136.9 (2.) 163.1 (8.)
 Trefferlage 1.56 mm links, 0.37 mm tief
 Streuwert 2.94, horizontal: 2.48, vertikal: 3.34

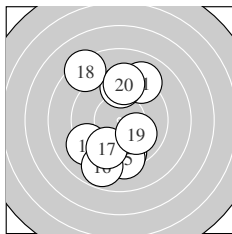

Serie 2:
 9.1 ↗ 9.5 ↑ 9.5 ↓ 9.2 ✓ 9.3 ↓
 8.8 ↓ 9.6 ↓ 8.3 ↘ 10.0 ↘ 9.4 ↑
 beste Teiler 231.7 (19.) 332.4 (17.) 357.2 (12.)
 Trefferlage 0.46 mm links, 0.27 mm tief
 Streuwert 3.20, horizontal: 2.10, vertikal: 4.01

Unterschrift des Schützen

Ergebnis: **186.2** (181)
 Serien: 92.0 94.2
 Zähler: 7 9 3 0 1 0 0 0 0 0
 Innenzehner: 4
 weiteste: 1175 (7), 730 (19), 706 (1)
 beste Teiler 85.1 (6.) 101.5 (11.) 114.1 (14.)
 Trefferlage 0.18 mm links, 0.11 mm hoch
 Streuwert 3.51, horizontal: 3.45, vertikal: 3.57

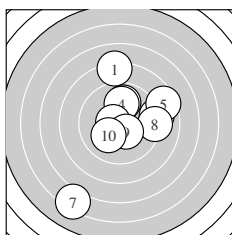
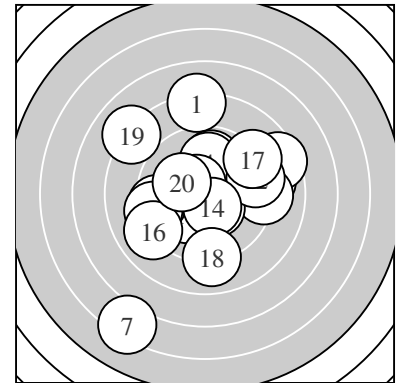

Serie 1:
 8.1 ↑ 9.9 ↑ 9.0 → 10.0 ↑ 8.5 →
 10.6 * 6.3 ↙ 9.1 → 10.4 * 10.1 ↙
 beste Teiler 85.1 (6.) 136.4 (9.) 210.8 (10.)
 Trefferlage 0.75 mm rechts, 0.29 mm hoch
 Streuwert 3.98, horizontal: 3.49, vertikal: 4.41

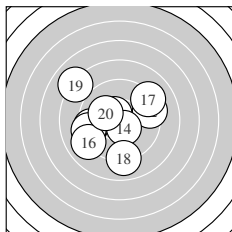

Serie 2:
 10.5 * 9.3 → 9.4 ← 10.5 * 9.3 ←
 9.0 ↙ 9.1 ↗ 9.0 ↓ 8.0 ↘ 10.1 ↘
 beste Teiler 101.5 (11.) 114.1 (14.) 201.2 (20.)
 Trefferlage 1.12 mm links, 0.06 mm tief
 Streuwert 3.02, horizontal: 3.31, vertikal: 2.71

Unterschrift des Schützen

Ergebnis: **199.8** (188)
 Serien: 101.3 98.5
 Zähler: 9 10 1 0 0 0 0 0 0 0
 Innenzehner: 8
 weiteste: 513 (15), 469 (3), 392 (19)
 beste Teiler 66.9 (20.) 68.0 (9.) 75.6 (2.)
 Trefferlage 0.17 mm links, 0.12 mm hoch
 Streuwert 1.99, horizontal: 2.28, vertikal: 1.65

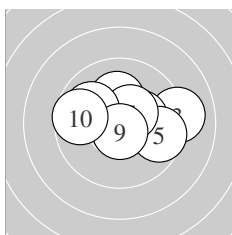
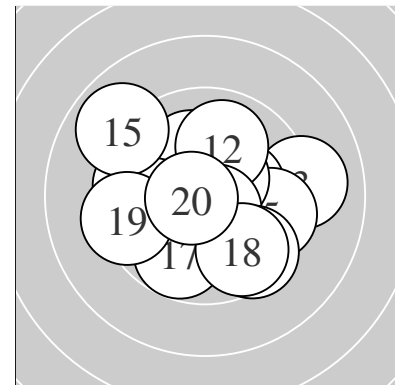

Serie 1:
 10.6 * 10.7 * 9.1 → 10.3 * 9.6 →
 10.2 * 10.5 * 9.9 ↖ 10.7 * 9.7 ←
 beste Teiler 68.0 (9.) 75.6 (2.) 100.4 (1.)
 Trefferlage 0.40 mm rechts, 0.53 mm hoch
 Streuwert 1.75, horizontal: 2.34, vertikal: 0.82

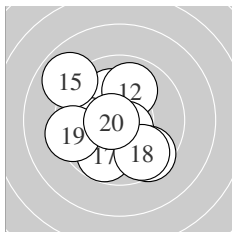

Serie 2:
 10.1 ↖ 9.9 ↑ 9.9 ← 10.6 * 8.9 ↖
 9.5 ↘ 9.8 ↓ 9.7 ↘ 9.4 ← 10.7 *
 beste Teiler 66.9 (20.) 86.2 (14.) 202.1 (11.)
 Trefferlage 0.75 mm links, 0.28 mm tief
 Streuwert 2.17, horizontal: 2.18, vertikal: 2.17

Unterschrift des Schützen

Ergebnis: **185.8** (177)
 Serien: 96.4 89.4
 Zähler: 6 7 5 2 0 0 0 0 0 0
 Innenzehner: 5
 weiteste: 912 (14), 764 (17), 718 (19)
 beste Teiler 61.7 (1.) 116.8 (3.) 147.3 (5.)
 Trefferlage 0.27 mm links, 0.99 mm hoch
 Streuwert 3.40, horizontal: 3.86, vertikal: 2.87

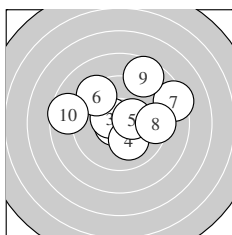
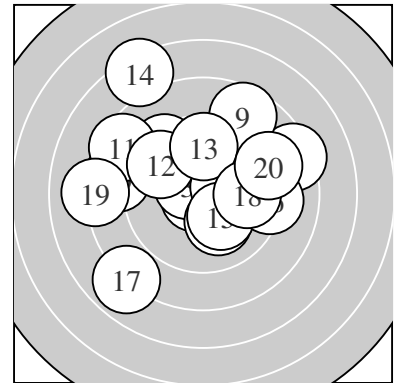

Serie 1:
 10.7 * 10.3 * 10.5 * 10.1 ↘ 10.4 *
 9.4 ↙ 8.4 → 9.4 → 8.6 ↗ 8.6 ←
 beste Teiler 61.7 (1.) 116.8 (3.) 147.3 (5.)
 Trefferlage 0.61 mm rechts, 0.92 mm hoch
 Streuwert 2.79, horizontal: 3.33, vertikal: 2.12

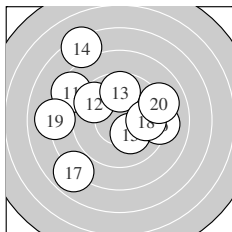

Serie 2:
 8.5 ↙ 9.6 ↙ 9.7 ↑ 7.3 ↘ 10.2 *
 9.2 → 7.9 ↙ 9.8 → 8.1 ← 9.1 →
 beste Teiler 189.9 (15.) 294.0 (18.) 315.0 (13.)
 Trefferlage 1.17 mm links, 1.06 mm hoch
 Streuwert 3.96, horizontal: 4.31, vertikal: 3.59

Unterschrift des Schützen

Ergebnis: **181.1** (171)
 Serien: 92.6 88.5
 Zähler: 4 6 8 1 1 0 0 0 0 0
 Innenzehner: 3
 weiteste: 1099 (3), 971 (16), 742 (10)
 beste Teiler 100.6 (18.) 148.6 (4.) 182.6 (2.)
 Trefferlage 1.54 mm links, 1.82 mm tief
 Streuwert 3.58, horizontal: 4.05, vertikal: 3.03

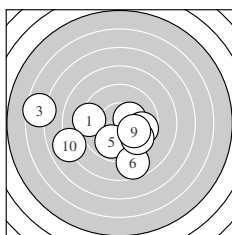
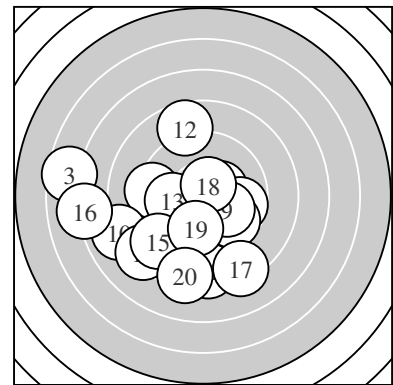

Serie 1:
 9.3 ← 10.2 * 6.6 ← 10.4 * 9.9 ↙
 8.7 ↓ 9.7 → 9.7 ↘ 10.1 ↘ 8.0 ←
 beste Teiler 148.6 (4.) 182.6 (2.) 222.4 (9.)
 Trefferlage 1.05 mm links, 1.18 mm tief
 Streuwert 3.62, horizontal: 4.69, vertikal: 2.07

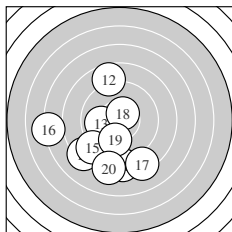

Serie 2:
 8.5 ↓ 8.7 ↑ 9.9 ← 8.3 ↙ 8.9 ↙
 7.1 ← 8.3 ↓ 10.6 * 9.9 ↓ 8.3 ↓
 beste Teiler 100.6 (18.) 251.7 (13.) 271.9 (19.)
 Trefferlage 2.02 mm links, 2.45 mm tief
 Streuwert 3.63, horizontal: 3.49, vertikal: 3.77

Unterschrift des Schützen

Ergebnis: **178.5** (170)
 Serien: 86.8 91.7
 Zähler: 6 4 4 6 0 0 0 0 0 0
 Innenzehner: 5
 weiteste: 948 (2), 933 (5), 898 (6)
 beste Teiler 117.4 (13.) 142.4 (10.) 143.1 (1.)
 Trefferlage 1.05 mm links, 0.53 mm hoch
 Streuwert 4.12, horizontal: 4.74, vertikal: 3.40

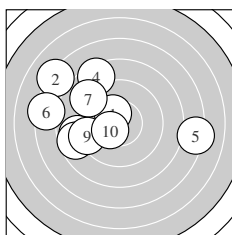
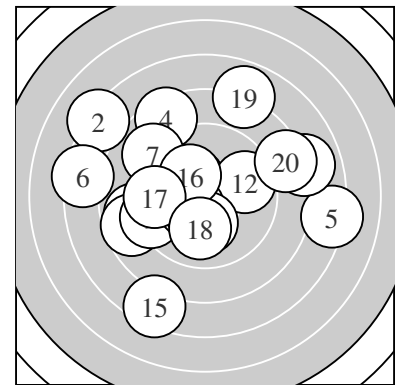

Serie 1:
 10.4 * 7.2 ↘ 8.8 ← 8.4 ↖ 7.2 →
 7.4 ← 9.0 ↘ 8.7 ← 9.3 ← 10.4 *
 beste Teiler 142.4 (10.) 143.1 (1.) 422.0 (9.)
 Trefferlage 3.03 mm links, 0.93 mm hoch
 Streuwert 4.10, horizontal: 5.01, vertikal: 2.92

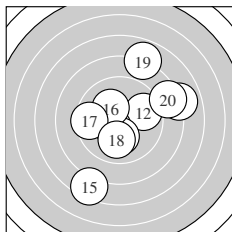

Serie 2:
 7.9 → 9.7 → 10.5 * 10.2 * 7.4 ↙
 10.2 * 9.5 ← 10.0 ↓ 7.9 ↗ 8.4 →
 beste Teiler 117.4 (13.) 184.6 (16.) 195.4 (14.)
 Trefferlage 0.92 mm rechts, 0.12 mm hoch
 Streuwert 3.82, horizontal: 3.69, vertikal: 3.94

Unterschrift des Schützen