

Ergebnis: **591.5** (563)
 Serien: 98.9 97.8 98.5 95.9 99.2 101.2
 Zähler: 26 31 3 0 0 0 0 0 0
 Innenzehner: 19
 weiteste: 708 (22), 545 (20), 503 (40)
 beste Teiler 25.9 (59.) 50.3 (16.) 61.2 (54.)
 Trefferlage 0.23 mm rechts, 0.30 mm hoch
 Streuwert 2.15, horizontal: 2.59, vertikal: 1.60

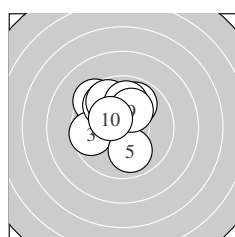

Serie 1:
 9.9 ← 9.4 ↘ 9.6 ← 9.8 ↘ 10.0 ↓
 9.8 ↘ 9.9 ↗ 10.0 ↑ 10.2 * 10.3 *
 beste Teiler 152.0 (10.) 194.0 (9.) 249.1 (5.)
 Trefferlage 0.98 mm links, 1.23 mm hoch
 Streuwert 1.68, horizontal: 1.68, vertikal: 1.68

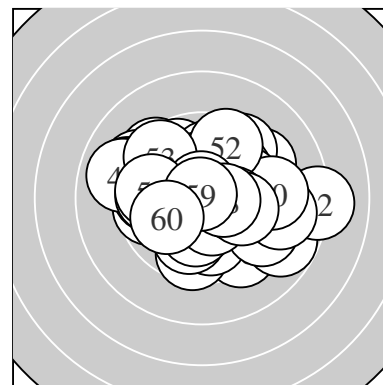
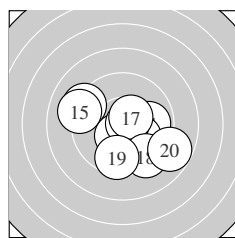

Serie 2:
 9.9 → 10.4 * 10.1 ↘ 9.2 ↖ 9.1 ←
 10.8 * 10.5 * 9.4 ↘ 9.6 ↓ 8.8 ↘
 beste Teiler 50.3 (16.) 110.6 (17.) 133.2 (12.)
 Trefferlage 0.33 mm rechts, 0.76 mm tief
 Streuwert 2.42, horizontal: 2.86, vertikal: 1.88

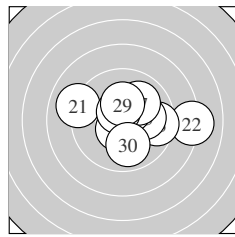

Serie 3:
 9.0 ↖ 8.1 → 9.5 → 10.5 * 10.1 →
 10.5 * 10.0 ↗ 10.6 * 10.3 * 9.9 ↓
 beste Teiler 95.2 (28.) 103.9 (24.) 119.0 (26.)
 Trefferlage 1.01 mm rechts, 0.28 mm hoch
 Streuwert 2.33, horizontal: 3.01, vertikal: 1.34

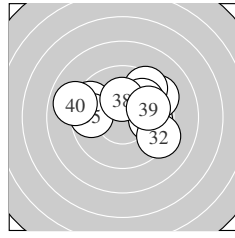

Serie 4:
 9.8 → 9.3 ↘ 9.5 ↖ 9.3 ↗ 9.7 ←
 9.5 ↗ 9.9 ↗ 10.2 * 9.8 → 8.9 ←
 beste Teiler 181.1 (38.) 261.7 (37.) 278.2 (39.)
 Trefferlage 0.56 mm rechts, 1.01 mm hoch
 Streuwert 2.46, horizontal: 3.19, vertikal: 1.38

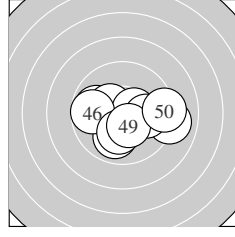

Serie 5:
 9.9 ↓ 9.9 ← 9.0 → 10.4 * 10.5 *
 9.7 ← 10.2 * 10.0 → 10.4 * 9.2 →
 beste Teiler 119.3 (45.) 141.7 (49.) 147.8 (44.)
 Trefferlage 0.49 mm rechts, 0.48 mm tief
 Streuwert 2.05, horizontal: 2.69, vertikal: 1.10

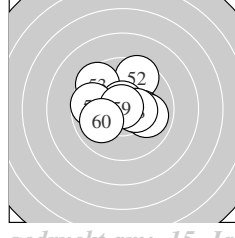

Serie 6:
 10.4 * 9.5 ↗ 9.5 ↘ 10.7 * 9.7 ←
 10.2 * 9.9 → 10.4 * 10.9 * 10.0 ←
 beste Teiler 25.9 (59.) 61.2 (54.) 128.7 (51.)
 Trefferlage 0.00 mm , 0.55 mm hoch
 Streuwert 1.70, horizontal: 1.97, vertikal: 1.37

LG 60 ZR – Wertung – Junioren

StandNr: 101

Marcel, Schöfbeck, #70423062

StartNr: 1

15. Januar 2017 10:53

SG_Walchsee

Unterschrift des Schützen

Meyton Elektronik

Ergebnis: **602.5** (576)
 Serien: 100.3 102.0 97.1 101.4 100.6 101.1
 Zähler: 37 22 1 0 0 0 0 0 0
 Innenzehner: 24
 weiteste: 537 (36), 436 (27), 426 (7)
 beste Teiler 10.0 (37.) 25.6 (38.) 29.8 (53.)
 Trefferlage 0.08 mm links, 0.29 mm tief
 Streuwert 1.83, horizontal: 1.95, vertikal: 1.70

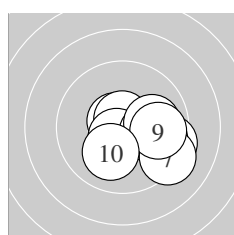
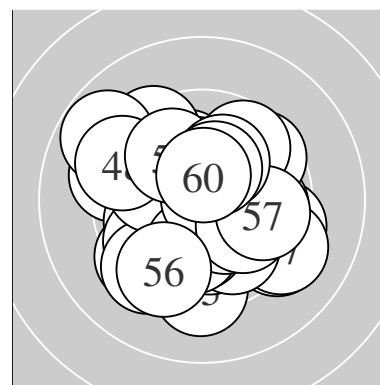

Serie 1:
 10.7 * 9.4 → 10.7 * 9.7 → 10.6 *
 10.1 → 9.2 ↘ 10.0 → 9.8 → 10.1 ↙
 beste Teiler 63.1 (3.) 75.9 (1.) 89.8 (5.)
 Trefferlage 1.52 mm rechts, 0.65 mm tief
 Streuwert 1.48, horizontal: 1.83, vertikal: 1.01

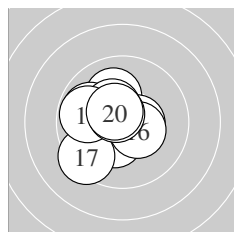

Serie 2:
 10.1 ↗ 9.9 ← 10.4 * 10.5 * 10.4 *
 10.4 * 9.4 ↙ 9.8 ← 10.6 * 10.5 *
 beste Teiler 81.2 (19.) 104.2 (20.) 112.2 (14.)
 Trefferlage 0.91 mm links, 0.14 mm hoch
 Streuwert 1.42, horizontal: 1.45, vertikal: 1.38

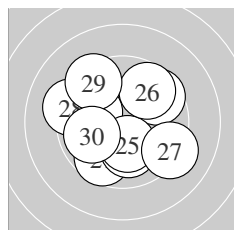

Serie 3:
 9.7 ↙ 10.0 ← 9.6 ↗ 10.1 ↓ 10.2 *
 9.7 ↗ 9.2 → 9.3 ← 9.4 ↘ 9.9 ←
 beste Teiler 177.3 (25.) 221.0 (24.) 238.4 (22.)
 Trefferlage 0.33 mm links, 0.03 mm tief
 Streuwert 2.40, horizontal: 2.58, vertikal: 2.21

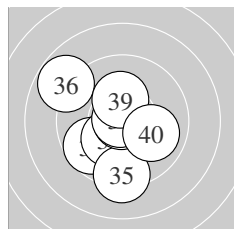

Serie 4:
 10.8 * 10.4 * 9.7 ↙ 10.3 * 9.3 ↓
 8.8 ↘ 10.9 * 10.9 * 10.3 * 10.0 →
 beste Teiler 10.0 (37.) 25.6 (38.) 50.3 (31.)
 Trefferlage 0.66 mm links, 0.46 mm tief
 Streuwert 1.89, horizontal: 1.77, vertikal: 2.01

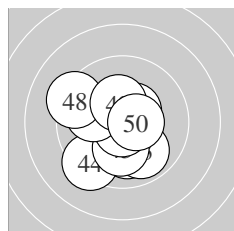

Serie 5:
 10.5 * 10.0 ↓ 9.9 ↘ 9.3 ↙ 10.1 ↓
 10.7 * 10.0 ← 9.3 ↘ 10.3 * 10.5 *
 beste Teiler 51.3 (46.) 106.0 (50.) 120.9 (41.)
 Trefferlage 0.54 mm links, 0.54 mm tief
 Streuwert 1.76, horizontal: 1.75, vertikal: 1.77

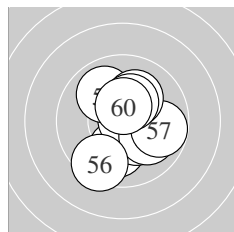

Serie 6:
 10.0 ↓ 10.3 * 10.8 * 9.9 ↘ 10.0 →
 9.4 ↙ 9.8 → 10.1 ↗ 10.3 * 10.5 *
 beste Teiler 29.8 (53.) 118.2 (60.) 161.0 (59.)
 Trefferlage 0.41 mm rechts, 0.20 mm tief
 Streuwert 1.65, horizontal: 1.44, vertikal: 1.83

LG 60 ZR – Wertung – **Männer**

StandNr: 102

Michael, Bauhofer, #70309084

StartNr: 2

15. Januar 2017 11:03

SG_Kössen

Unterschrift des Schützen

Meyton Elektronik

Ergebnis:	604.6	(577)
Serien:	101.6 100.8 98.8 99.1 103.3 101.0	
Zähler:	38 21 1 0 0 0 0 0 0	
Innenzehner:	28	
weiteste:	591 (30), 436 (22), 434 (38)	
beste Teiler	44.2 (41.) 62.0 (45.) 73.0 (7.)	
Trefferlage	0.31 mm links, 0.89 mm hoch	
Streuwert	1.63, horizontal: 1.79, vertikal: 1.45	

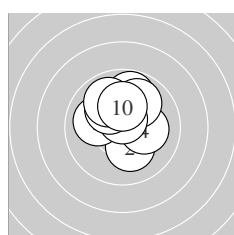
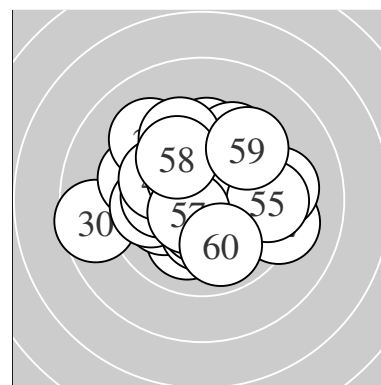

Serie 1:	10.5 *	10.2 *	10.0 ↖	10.2 *	9.8 ↑
	9.9 ↗	10.7 *	10.2 *	9.9 ↘	10.2 *
beste Teiler	73.0 (7.)	111.8 (1.)	189.0 (10.)		
Trefferlage	0.08 mm rechts, 1.06 mm hoch				
Streuwert	1.34, horizontal: 1.31, vertikal: 1.37				

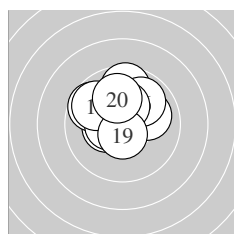

Serie 2:	10.4 *	9.6 ↑	9.7 ↘	10.5 *	10.0 →
	9.9 ↗	9.8 ↘	10.3 *	10.6 *	10.0 ↑
beste Teiler	92.0 (19.)	120.5 (14.)	147.2 (11.)		
Trefferlage	0.39 mm links, 1.20 mm hoch				
Streuwert	1.47, horizontal: 1.60, vertikal: 1.32				

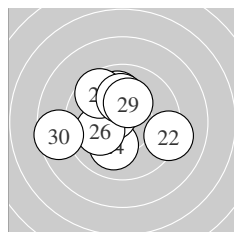

Serie 3:	10.0 ↑	9.2 →	10.4 *	10.1 ↓	10.5 *
	10.1 ↖	9.6 ↘	10.1 ↑	10.2 *	8.6 ←
beste Teiler	112.8 (25.)	147.8 (23.)	182.0 (29.)		
Trefferlage	0.78 mm links, 0.57 mm hoch				
Streuwert	2.15, horizontal: 2.49, vertikal: 1.74				

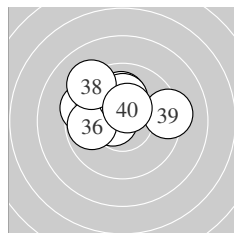

Serie 4:	10.4 *	10.6 *	9.6 ↘	10.1 ↑	9.5 ↖
	9.8 ←	10.1 ↑	9.2 ↘	9.3 →	10.5 *
beste Teiler	89.0 (32.)	125.5 (40.)	143.5 (31.)		
Trefferlage	0.86 mm links, 1.38 mm hoch				
Streuwert	1.78, horizontal: 2.25, vertikal: 1.11				

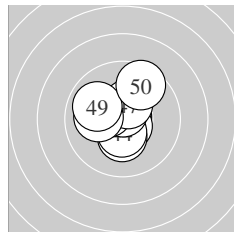

Serie 5:	10.8 *	10.6 *	10.3 *	10.5 *	10.7 *
	10.4 *	10.4 *	10.1 ←	9.9 ↘	9.6 ↗
beste Teiler	44.2 (41.)	62.0 (45.)	77.4 (42.)		
Trefferlage	0.29 mm links, 0.37 mm hoch				
Streuwert	1.31, horizontal: 1.26, vertikal: 1.36				

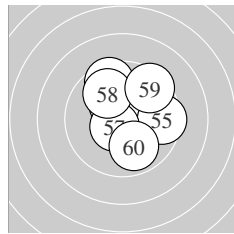

Serie 6:	10.4 *	10.5 *	10.6 *	10.6 *	9.5 →
	9.5 ↘	10.6 *	9.9 ↘	9.5 ↗	9.9 ↓
beste Teiler	76.2 (53.)	85.7 (54.)	99.7 (57.)		
Trefferlage	0.36 mm rechts, 0.78 mm hoch				
Streuwert	1.70, horizontal: 1.62, vertikal: 1.78				

Meyton Elektronik

LG 60 ZR – Wertung – **Männer**

StandNr: 104

Markus, Bauhofer, #70309007

StartNr: 4

15. Januar 2017 10:57

SG_Kössen

Unterschrift des Schützen

Meyton Elektronik

Ergebnis:	591.6	(563)
Serien:	101.6 97.3 98.0 96.2 98.7 99.8	
Zähler:	28 27 5 0 0 0 0 0 0 0	
Innenzehner:	18	
weiteste:	650 (24), 596 (11), 589 (18)	
beste Teiler	50.0 (50.) 56.6 (52.) 62.5 (51.)	
Trefferlage	0.50 mm rechts, 0.20 mm tief	
Streuwert	2.16, horizontal: 2.49, vertikal: 1.77	

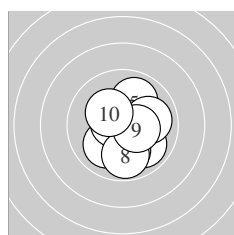
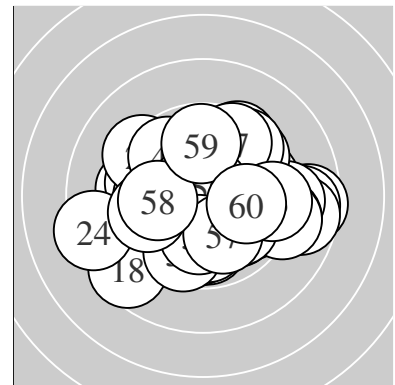

Serie 1:	9.9 ↘	10.0 ↓	10.0 ↙	10.6 *	10.0 ↗
	10.0 →	10.6 *	9.8 ↓	10.4 *	10.3 *
beste Teiler	80.6 (7.) 96.5 (4.) 134.8 (9.)				
Trefferlage	0.40 mm rechts, 0.58 mm tief				
Streuwert	1.48, horizontal: 1.31, vertikal: 1.63				

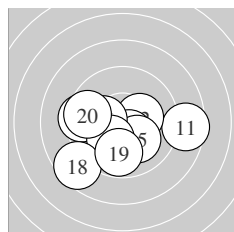

Serie 2:	8.6 →	10.3 *	10.5 *	9.4 ←	10.1 ↘
	10.2 *	10.2 *	8.6 ↗	9.8 ↓	9.6 ←
beste Teiler	124.5 (13.) 167.4 (12.) 183.5 (16.)				
Trefferlage	0.51 mm links, 0.98 mm tief				
Streuwert	2.46, horizontal: 3.09, vertikal: 1.59				

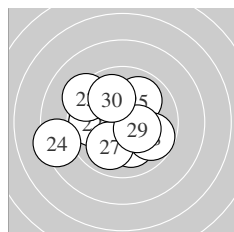

Serie 3:	10.5 *	9.8 ←	9.3 ↖	8.4 ←	9.9 ↗
	10.1 ↓	9.9 ↙	9.8 ↘	10.3 *	10.0 ↘
beste Teiler	122.2 (21.) 151.7 (29.) 216.8 (26.)				
Trefferlage	0.87 mm links, 0.04 mm tief				
Streuwert	2.31, horizontal: 2.69, vertikal: 1.86				

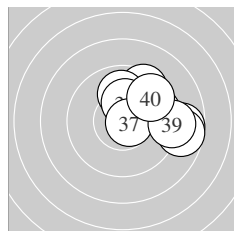

Serie 4:	9.5 ↗	10.2 *	9.9 ↑	8.7 →	10.2 *
	9.6 →	10.7 *	8.7 →	9.1 →	9.6 ↗
beste Teiler	64.5 (37.) 176.5 (35.) 197.9 (32.)				
Trefferlage	2.51 mm rechts, 1.02 mm hoch				
Streuwert	1.83, horizontal: 2.14, vertikal: 1.45				

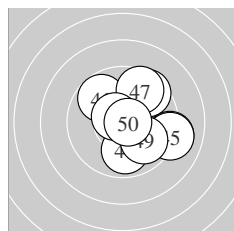

Serie 5:	9.8 ↖	10.4 *	9.1 →	9.9 ↓	9.1 →
	9.5 ↗	9.6 ↗	10.6 *	9.9 ↘	10.8 *
beste Teiler	50.0 (50.) 86.6 (48.) 149.9 (42.)				
Trefferlage	1.39 mm rechts, 0.03 mm hoch				
Streuwert	2.04, horizontal: 2.07, vertikal: 2.01				

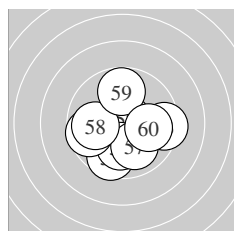

Serie 6:	10.7 *	10.7 *	9.4 →	9.6 ↓	10.1 ↓
	9.6 ←	10.0 ↘	9.9 ←	9.8 ↑	10.0 →
beste Teiler	56.6 (52.) 62.5 (51.) 220.2 (55.)				
Trefferlage	0.07 mm rechts, 0.66 mm tief				
Streuwert	1.92, horizontal: 2.12, vertikal: 1.69				

Meyton Elektronik

LG 60 ZR – Wertung – **Männer**

StandNr: 105

Fabian, Insam, #70804040

StartNr: 5

15. Januar 2017 10:52

SG_Fügenberg

Unterschrift des Schützen

Meyton Elektronik

Ergebnis: **407.6** (388)
 Serien: 102.1 102.3 102.0 101.2
 Zähler: 28 12 0 0 0 0 0 0 0 0
 Innenzehner: 24
 weiteste: 392 (20), 370 (37), 364 (6)
 beste Teiler 26.6 (3.) 71.4 (22.) 77.4 (2.)
 Trefferlage 0.08 mm links, 0.36 mm hoch
 Streuwert 1.50, horizontal: 1.57, vertikal: 1.43

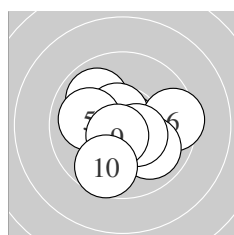
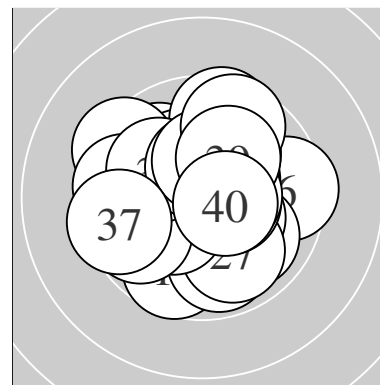

Serie 1:
 9.9 ↘ 10.6 * 10.8 * 10.6 * 10.0 ←
 9.5 → 9.9 ↘ 10.5 * 10.6 * 9.7 ↓
 beste Teiler 26.6 (3.) 77.4 (2.) 83.1 (9.)
 Trefferlage 0.01 mm rechts, 0.19 mm tief
 Streuwert 1.59, horizontal: 1.79, vertikal: 1.36

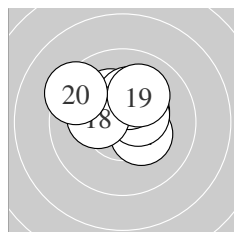

Serie 2:
 10.4 * 10.6 * 10.4 * 10.3 * 10.5 *
 10.2 * 10.2 * 10.2 * 10.1 ↗ 9.4 ↘
 beste Teiler 95.8 (12.) 122.5 (15.) 130.3 (13.)
 Trefferlage 0.07 mm links, 1.03 mm hoch
 Streuwert 1.24, horizontal: 1.52, vertikal: 0.88

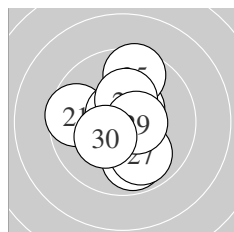

Serie 3:
 9.6 ← 10.7 * 9.9 ↓ 10.5 * 9.6 ↑
 10.6 * 9.9 ↘ 10.3 * 10.6 * 10.3 *
 beste Teiler 71.4 (22.) 95.4 (26.) 98.0 (29.)
 Trefferlage 0.04 mm links, 0.01 mm hoch
 Streuwert 1.61, horizontal: 1.39, vertikal: 1.80

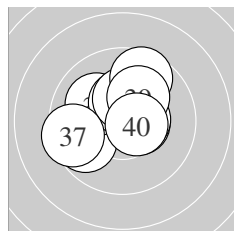

Serie 4:
 9.7 ↙ 10.1 ↘ 10.5 * 10.4 * 10.5 *
 10.3 * 9.5 ← 9.6 ↑ 10.1 ↗ 10.5 *
 beste Teiler 102.8 (40.) 116.4 (33.) 119.5 (35.)
 Trefferlage 0.24 mm links, 0.61 mm hoch
 Streuwert 1.61, horizontal: 1.81, vertikal: 1.39

Unterschrift des Schützen

Meyton Elektronik

Ergebnis: **378.8** (361)
 Serien: 97.6 95.8 94.3 91.1
 Zähler: 12 18 9 1 0 0 0 0 0 0
 Innenzehner: 9
 weiteste: 928 (27), 719 (30), 659 (15)
 beste Teiler 24.1 (17.) 68.1 (24.) 84.8 (6.)
 Trefferlage 0.13 mm links, 1.31 mm hoch
 Streuwert 2.85, horizontal: 3.64, vertikal: 1.72

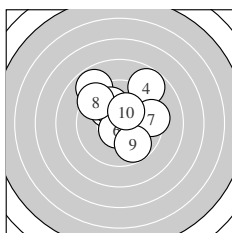
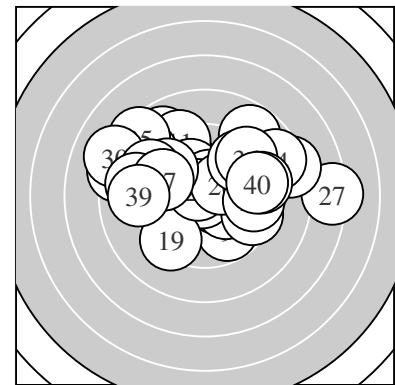

Serie 1:
 8.8 ↘ 10.4 * 10.1 ↘ 8.8 ↗ 10.0 ↘
 10.6 * 9.4 → 9.4 ↖ 9.8 ↘ 10.3 *
 beste Teiler 84.8 (6.) 147.1 (2.) 164.2 (10.)
 Trefferlage 0.00 mm , 1.52 mm hoch
 Streuwert 2.24, horizontal: 2.37, vertikal: 2.10

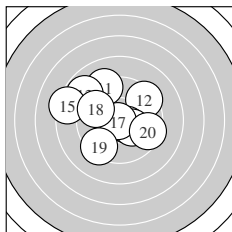

Serie 2:
 9.2 ↘ 9.4 ↗ 8.8 ↖ 10.5 * 8.3 ↖
 10.2 * 10.9 * 9.7 ↖ 9.3 ↗ 9.5 →
 beste Teiler 24.1 (17.) 108.2 (14.) 176.6 (16.)
 Trefferlage 0.91 mm links, 0.66 mm hoch
 Streuwert 2.77, horizontal: 3.19, vertikal: 2.26

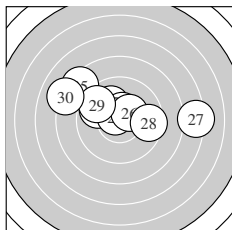

Serie 3:
 10.1 ↘ 9.8 ↖ 10.5 * 10.7 * 8.4 ↖
 10.4 * 7.2 → 9.5 → 9.6 ↖ 8.1 ↖
 beste Teiler 68.1 (24.) 115.9 (23.) 148.0 (26.)
 Trefferlage 0.40 mm links, 1.44 mm hoch
 Streuwert 3.31, horizontal: 4.49, vertikal: 1.36

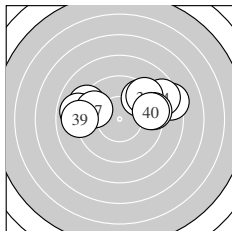

Serie 4:
 8.3 → 9.5 ↗ 9.2 ↖ 8.6 → 8.9 ←
 9.3 ↗ 9.6 ↖ 9.3 → 9.0 ← 9.4 →
 beste Teiler 329.4 (37.) 352.2 (32.) 391.9 (40.)
 Trefferlage 0.77 mm rechts, 1.59 mm hoch
 Streuwert 3.22, horizontal: 4.46, vertikal: 0.92

Unterschrift des Schützen

Ergebnis: **399.0** (381)
 Serien: 99.1 99.4 98.9 101.6
 Zähler: 23 15 2 0 0 0 0 0 0 0
 Innenzehner: 15
 weiteste: 615 (19), 582 (28), 413 (40)
 beste Teiler 28.1 (32.) 31.4 (39.) 71.8 (20.)
 Trefferlage 0.36 mm rechts, 0.08 mm hoch
 Streuwert 1.95, horizontal: 1.99, vertikal: 1.90

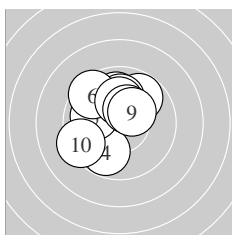
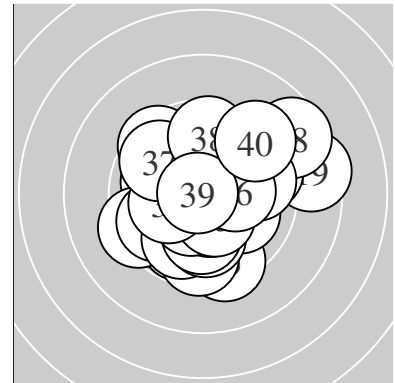

Serie 1:
 9.9 ↑ 9.8 ↗ 10.0 ↑ 9.8 ↙ 10.0 ↖
 9.5 ↘ 10.1 ↑ 10.4 * 10.3 * 9.3 ↙
 beste Teiler 147.1 (8.) 154.9 (9.) 204.0 (7.)
 Trefferlage 0.64 mm links, 1.04 mm hoch
 Streuwert 1.80, horizontal: 1.74, vertikal: 1.86

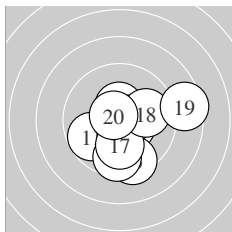

Serie 2:
 9.8 ↙ 10.4 * 10.5 * 10.6 * 9.4 ↓
 9.6 ↓ 10.0 ↓ 9.9 → 8.5 → 10.7 *
 beste Teiler 71.8 (20.) 91.3 (14.) 119.9 (13.)
 Trefferlage 0.82 mm rechts, 0.78 mm tief
 Streuwert 2.07, horizontal: 2.26, vertikal: 1.87

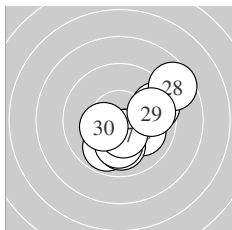

Serie 3:
 9.9 ↙ 10.4 * 10.0 ↘ 10.0 ↓ 10.1 ↓
 9.5 → 10.4 * 8.6 ↗ 9.7 → 10.3 *
 beste Teiler 131.0 (27.) 135.9 (22.) 159.5 (30.)
 Trefferlage 1.16 mm rechts, 0.61 mm tief
 Streuwert 1.95, horizontal: 2.08, vertikal: 1.81

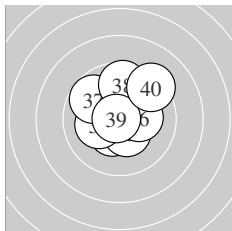

Serie 4:
 10.4 * 10.8 * 10.4 * 10.2 * 10.1 ↗
 10.2 * 9.7 ↘ 9.7 ↑ 10.8 * 9.3 ↗
 beste Teiler 28.1 (32.) 31.4 (39.) 136.9 (31.)
 Trefferlage 0.12 mm rechts, 0.69 mm hoch
 Streuwert 1.62, horizontal: 1.61, vertikal: 1.63

Unterschrift des Schützen

Meyton Elektronik

Ergebnis: **401.4** (382)
 Serien: 99.7 100.3 98.9 102.5
 Zähler: 23 16 1 0 0 0 0 0 0 0
 Innenzehner: 18
 weiteste: 540 (37), 492 (23), 448 (5)
 beste Teiler 34.8 (10.) 48.0 (39.) 67.1 (32.)
 Trefferlage 0.58 mm rechts, 0.11 mm tief
 Streuwert 1.84, horizontal: 1.98, vertikal: 1.68

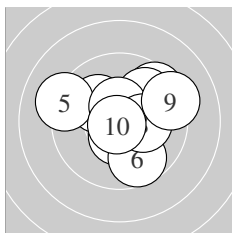
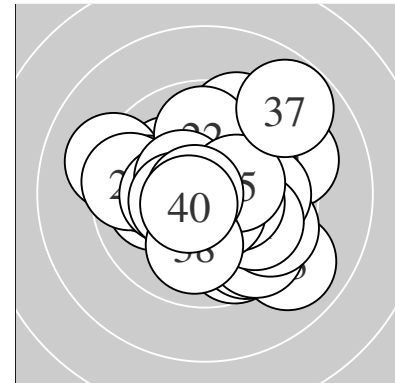

Serie 1:
 10.5 * 10.1 ↘ 9.5 ↗ 9.9 ↗ 9.2 ↖
 9.7 ↘ 10.5 * 10.2 * 9.3 ↗ 10.8 *
 beste Teiler 34.8 (10.) 114.6 (7.) 115.1 (1.)
 Trefferlage 0.53 mm rechts, 0.53 mm hoch
 Streuwert 2.01, horizontal: 2.34, vertikal: 1.60

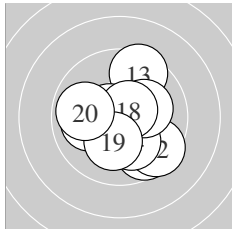

Serie 2:
 9.7 ↘ 9.5 ↘ 9.5 ↑ 10.1 ↘ 10.6 *
 10.2 * 10.0 ← 10.6 * 10.2 * 9.9 ←
 beste Teiler 85.2 (15.) 88.0 (18.) 191.6 (19.)
 Trefferlage 0.33 mm rechts, 0.36 mm tief
 Streuwert 1.84, horizontal: 1.84, vertikal: 1.83

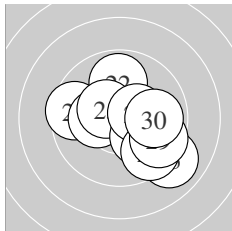

Serie 3:
 9.6 ← 9.9 ↑ 9.0 ↘ 10.3 * 10.5 *
 10.1 ↘ 10.4 * 9.6 ↘ 9.6 ↘ 9.9 →
 beste Teiler 124.5 (25.) 137.6 (27.) 171.0 (24.)
 Trefferlage 0.83 mm rechts, 0.43 mm tief
 Streuwert 2.06, horizontal: 2.34, vertikal: 1.74

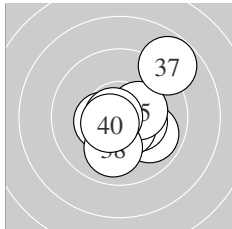

Serie 4:
 9.9 ↘ 10.7 * 10.4 * 10.6 * 10.3 *
 10.4 * 8.8 ↗ 10.0 ↓ 10.8 * 10.6 *
 beste Teiler 48.0 (39.) 67.1 (32.) 88.5 (40.)
 Trefferlage 0.62 mm rechts, 0.18 mm tief
 Streuwert 1.61, horizontal: 1.57, vertikal: 1.64

Unterschrift des Schützen

Ergebnis: **400.8** (382)
 Serien: 99.8 99.5 99.4 102.1
 Zähler: 22 18 0 0 0 0 0 0 0 0
 Innenzehner: 18
 weiteste: 492 (32), 443 (28), 439 (4)
 beste Teiler 12.0 (8.) 55.8 (9.) 59.0 (7.)
 Trefferlage 0.37 mm links, 0.07 mm hoch
 Streuwert 1.92, horizontal: 2.13, vertikal: 1.68

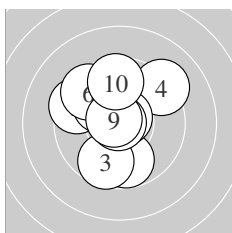
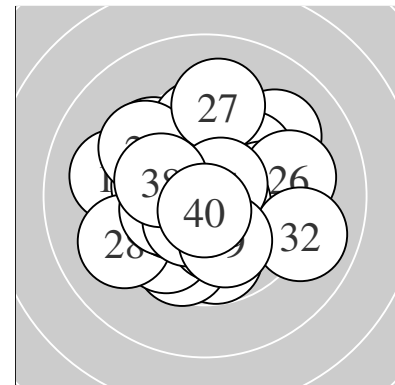

Serie 1:
 9.8 ↓ 9.5 ↖ 9.7 ↓ 9.2 ↗ 10.1 ↘
 9.6 ↘ 10.7 * 10.9 * 10.7 * 9.6 ↑
 beste Teiler 12.0 (8.) 55.8 (9.) 59.0 (7.)
 Trefferlage 0.51 mm links, 0.63 mm hoch
 Streuwert 2.03, horizontal: 1.84, vertikal: 2.20

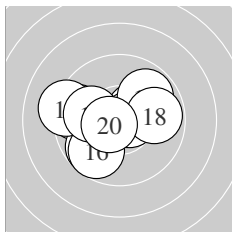

Serie 2:
 9.6 ↖ 9.8 ↗ 10.4 * 9.2 ↖ 10.6 *
 9.7 ↗ 9.8 ↗ 9.8 → 10.0 ↖ 10.6 *
 beste Teiler 79.1 (15.) 90.0 (20.) 143.2 (13.)
 Trefferlage 0.78 mm links, 0.01 mm hoch
 Streuwert 1.93, horizontal: 2.39, vertikal: 1.34

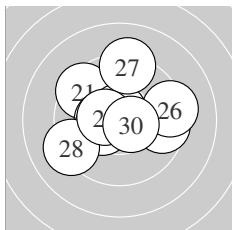

Serie 3:
 9.5 ↘ 10.4 * 10.4 * 10.7 * 9.6 →
 9.3 → 9.2 ↑ 9.2 ↖ 10.5 * 10.6 *
 beste Teiler 66.6 (24.) 97.1 (30.) 119.2 (29.)
 Trefferlage 0.17 mm links, 0.49 mm hoch
 Streuwert 2.18, horizontal: 2.52, vertikal: 1.78

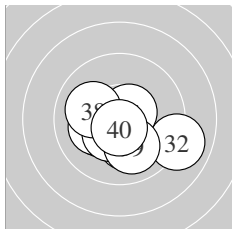

Serie 4:
 10.2 * 9.0 → 10.6 * 10.6 * 10.3 *
 10.2 * 10.4 * 10.1 ↖ 10.0 ↓ 10.7 *
 beste Teiler 70.0 (40.) 93.0 (34.) 99.7 (33.)
 Trefferlage 0.01 mm links, 0.85 mm tief
 Streuwert 1.53, horizontal: 1.94, vertikal: 0.96

Unterschrift des Schützen

Meyton Elektronik

Ergebnis: **200.1** (189)
 Serien: 99.3 100.8
 Zähler: 10 9 1 0 0 0 0 0 0 0
 Innenzehner: 7
 weiteste: 509 (3), 368 (10), 333 (20)
 beste Teiler 31.4 (11.) 62.3 (9.) 84.5 (6.)
 Trefferlage 0.30 mm links, 0.62 mm hoch
 Streuwert 1.83, horizontal: 2.16, vertikal: 1.42

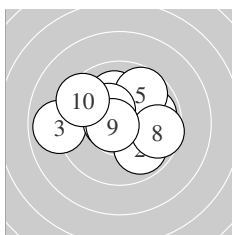
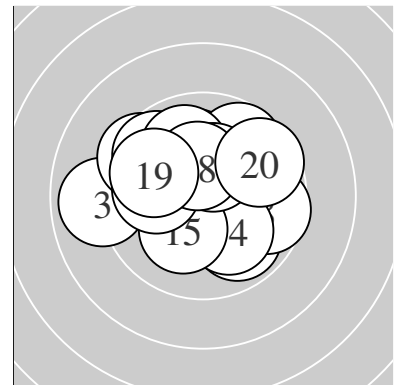

Serie 1:
 10.1 ↑ 9.9 ↘ 8.9 ← 9.9 → 9.7 ↗
 10.6 * 10.4 * 9.6 → 10.7 * 9.5 ↖
 beste Teiler 62.3 (9.) 84.5 (6.) 144.3 (7.)
 Trefferlage 0.16 mm links, 0.53 mm hoch
 Streuwert 2.10, horizontal: 2.60, vertikal: 1.44

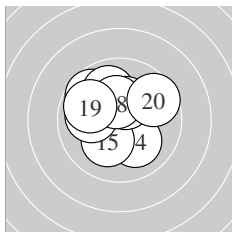

Serie 2:
 10.8 * 9.7 ↖ 9.9 ↗ 10.1 ↘ 10.2 *
 10.3 * 10.0 ← 10.3 * 9.9 ↖ 9.6 ↗
 beste Teiler 31.4 (11.) 153.7 (16.) 154.5 (18.)
 Trefferlage 0.44 mm links, 0.71 mm hoch
 Streuwert 1.62, horizontal: 1.76, vertikal: 1.47

Unterschrift des Schützen

Ergebnis: **408.1** (390)
 Serien: 101.2 103.6 102.2 101.1
 Zähler: 30 10 0 0 0 0 0 0 0 0
 Innenzehner: 24
 weiteste: 413 (21), 328 (6), 310 (40)
 beste Teiler 44.5 (2.) 46.6 (16.) 56.7 (29.)
 Trefferlage 0.16 mm links, 0.07 mm tief
 Streuwert 1.46, horizontal: 1.52, vertikal: 1.40

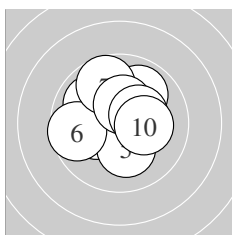
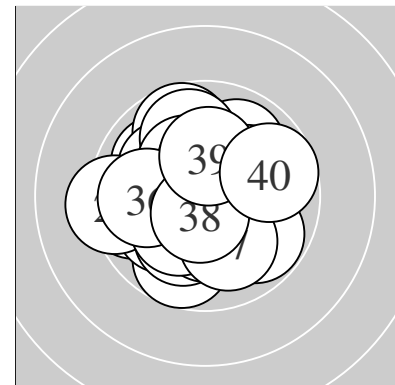

Serie 1:
 9.9 ↗ 10.8 * 10.2 * 9.9 ↘ 10.2 *
 9.6 ← 9.7 ↖ 10.4 * 10.3 * 10.2 *
 beste Teiler 44.5 (2.) 143.1 (8.) 156.1 (9.)
 Trefferlage 0.25 mm links, 0.58 mm hoch
 Streuwert 1.57, horizontal: 1.70, vertikal: 1.43

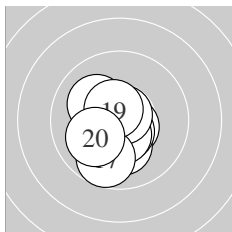

Serie 2:
 10.6 * 10.2 * 10.6 * 10.4 * 10.5 *
 10.8 * 9.7 ↓ 10.1 ↘ 10.6 * 10.1 ↙
 beste Teiler 46.6 (16.) 91.5 (11.) 94.8 (19.)
 Trefferlage 0.45 mm links, 0.69 mm tief
 Streuwert 1.11, horizontal: 0.95, vertikal: 1.25

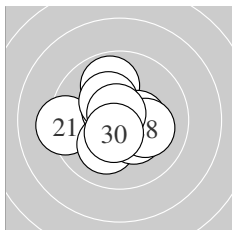

Serie 3:
 9.3 ← 10.6 * 10.1 ↙ 9.9 ↑ 10.4 *
 10.3 * 10.3 * 10.1 → 10.7 * 10.5 *
 beste Teiler 56.7 (29.) 97.0 (22.) 106.5 (30.)
 Trefferlage 0.36 mm links, 0.03 mm hoch
 Streuwert 1.51, horizontal: 1.68, vertikal: 1.32

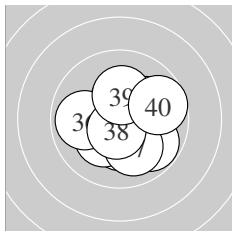

Serie 4:
 9.8 ↘ 10.3 * 10.1 ↗ 10.3 * 10.2 *
 9.9 ← 10.0 ↓ 10.6 * 10.2 * 9.7 →
 beste Teiler 83.2 (38.) 151.1 (32.) 168.1 (34.)
 Trefferlage 0.44 mm rechts, 0.23 mm tief
 Streuwert 1.58, horizontal: 1.67, vertikal: 1.48

Unterschrift des Schützen

Meyton Elektronik

Ergebnis: **409.7** (393)
 Serien: 100.2 102.6 102.8 104.1
 Zähler: 33 7 0 0 0 0 0 0 0 0
 Innenzehner: 26
 weiteste: 440 (9), 349 (29), 294 (8)
 beste Teiler 50.6 (21.) 53.8 (24.) 60.0 (3.)
 Trefferlage 0.55 mm links, 0.08 mm tief
 Streuwert 1.37, horizontal: 1.53, vertikal: 1.18

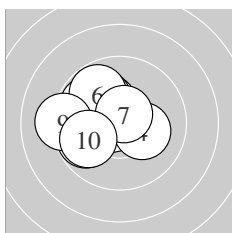
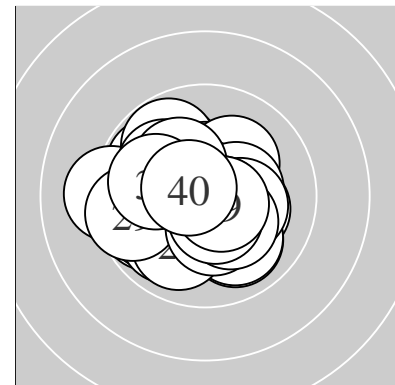

Serie 1:
 9.8 ↘ 10.2 * 10.7 * 10.2 * 10.0 ↗
 9.8 ↘ 10.6 * 9.8 ↙ 9.2 ← 9.9 ↙
 beste Teiler 60.0 (3.) 78.7 (7.) 179.2 (2.)
 Trefferlage 1.44 mm links, 0.49 mm hoch
 Streuwert 1.53, horizontal: 1.72, vertikal: 1.31

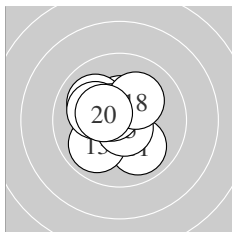

Serie 2:
 10.0 ↘ 10.2 * 9.9 ↙ 10.5 * 10.7 *
 10.0 ↘ 10.6 * 10.2 * 10.1 ↘ 10.4 *
 beste Teiler 69.8 (15.) 87.7 (17.) 124.0 (14.)
 Trefferlage 0.58 mm links, 0.25 mm hoch
 Streuwert 1.30, horizontal: 1.29, vertikal: 1.31

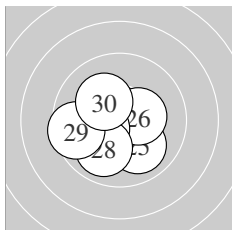

Serie 3:
 10.8 * 10.6 * 10.2 * 10.7 * 10.0 ↘
 10.4 * 10.3 * 10.0 ↙ 9.6 ← 10.2 *
 beste Teiler 50.6 (21.) 53.8 (24.) 93.0 (22.)
 Trefferlage 0.62 mm links, 0.53 mm tief
 Streuwert 1.31, horizontal: 1.50, vertikal: 1.08

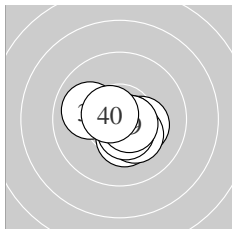

Serie 4:
 10.0 ↘ 10.5 * 10.3 * 10.6 * 10.4 *
 10.3 * 10.3 * 10.5 * 10.6 * 10.6 *
 beste Teiler 80.0 (34.) 84.9 (39.) 84.9 (40.)
 Trefferlage 0.40 mm rechts, 0.55 mm tief
 Streuwert 0.94, horizontal: 1.15, vertikal: 0.68

Unterschrift des Schützen

Meyton Elektronik

Ergebnis: **374.1** (356)
 Serien: 91.1 93.5 94.9 94.6
 Zähler: 10 18 10 2 0 0 0 0 0 0
 Innenzehner: 8
 weiteste: 941 (21), 771 (19), 709 (9)
 beste Teiler 55.0 (26.) 123.9 (1.) 128.2 (39.)
 Trefferlage 0.95 mm links, 0.30 mm hoch
 Streuwert 3.12, horizontal: 3.68, vertikal: 2.44

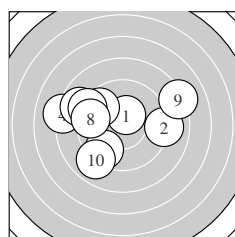
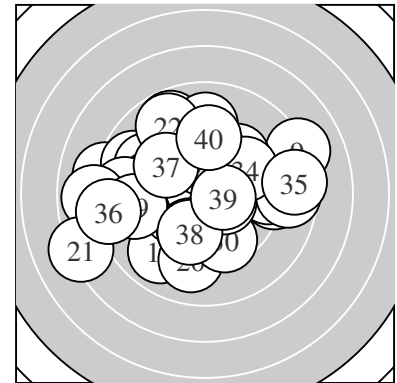

Serie 1:
 10.5 * 9.0 → 9.6 ↘ 8.1 ← 8.8 ↖
 9.5 ↙ 9.2 ↖ 9.4 ← 8.1 → 8.9 ↘
 beste Teiler 123.9 (1.) 332.6 (3.) 354.6 (6.)
 Trefferlage 1.58 mm links, 0.54 mm hoch
 Streuwert 3.41, horizontal: 4.26, vertikal: 2.26

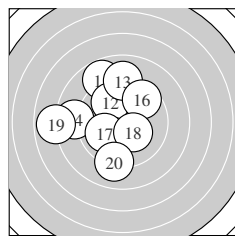

Serie 2:
 8.8 ↖ 9.9 ↖ 9.0 ↑ 8.7 ← 10.2 *
 9.6 ↗ 10.0 ↙ 10.3 * 7.9 ← 9.1 ↓
 beste Teiler 169.0 (18.) 196.4 (15.) 241.6 (17.)
 Trefferlage 1.75 mm links, 0.59 mm hoch
 Streuwert 3.00, horizontal: 2.98, vertikal: 3.03

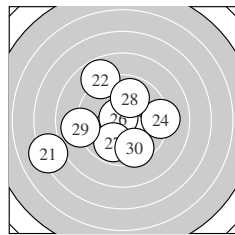

Serie 3:
 7.2 ↙ 8.8 ↖ 10.4 * 9.2 → 10.3 *
 10.7 * 9.8 ↙ 9.9 ↑ 9.0 ← 9.6 ↓
 beste Teiler 55.0 (26.) 128.6 (23.) 156.9 (25.)
 Trefferlage 1.16 mm links, 0.50 mm tief
 Streuwert 3.13, horizontal: 3.58, vertikal: 2.61

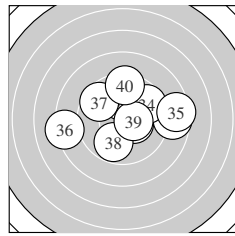

Serie 4:
 10.4 * 8.6 → 10.1 ↑ 9.6 ↗ 8.5 →
 8.2 ← 9.6 ↘ 9.8 ↓ 10.4 * 9.4 ↑
 beste Teiler 128.2 (39.) 143.3 (31.) 212.6 (33.)
 Trefferlage 0.69 mm rechts, 0.57 mm hoch
 Streuwert 3.02, horizontal: 3.82, vertikal: 1.91

Unterschrift des Schützen

Meyton Elektronik

Ergebnis: **378.2** (364)
 Serien: 96.2 97.0 92.4 92.6
 Zähler: 14 18 6 2 0 0 0 0 0 0
 Innenzehner: 6
 weiteste: 941 (34), 843 (24), 746 (27)
 beste Teiler 94.8 (4.) 99.6 (37.) 110.6 (14.)
 Trefferlage 0.43 mm rechts, 0.87 mm tief
 Streuwert 2.97, horizontal: 3.47, vertikal: 2.38

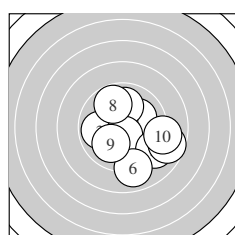
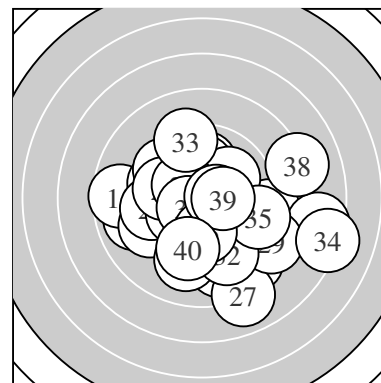

Serie 1:
 10.1 ↗ 10.0 ↑ 9.9 ← 10.6 * 9.1 ↘
 9.0 ↓ 8.7 ↘ 9.8 ↖ 10.0 ✓ 9.0 →
 beste Teiler 94.8 (4.) 212.2 (1.) 236.4 (9.)
 Trefferlage 1.20 mm rechts, 0.72 mm tief
 Streuwert 2.52, horizontal: 2.69, vertikal: 2.33

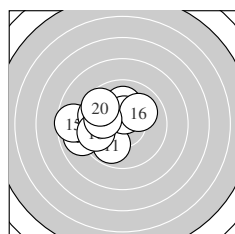

Serie 2:
 9.9 ↙ 9.0 ← 10.1 ↑ 10.5 * 8.6 ←
 10.0 ↗ 9.7 ← 9.6 ← 10.0 ← 9.6 ↘
 beste Teiler 110.6 (14.) 223.0 (13.) 233.8 (16.)
 Trefferlage 2.10 mm links, 0.36 mm hoch
 Streuwert 1.98, horizontal: 2.35, vertikal: 1.53

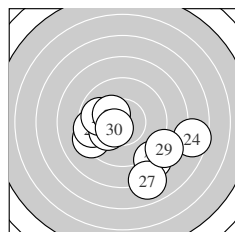

Serie 3:
 9.3 ← 8.7 ↘ 9.5 ← 7.6 → 10.1 ←
 9.8 ← 8.0 ↓ 10.3 * 8.6 ↘ 10.5 *
 beste Teiler 119.8 (30.) 162.2 (28.) 206.1 (25.)
 Trefferlage 0.56 mm rechts, 1.92 mm tief
 Streuwert 3.33, horizontal: 4.07, vertikal: 2.38

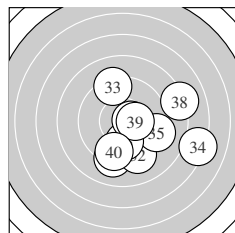

Serie 4:
 9.1 ↓ 9.2 ↓ 9.2 ↑ 7.2 → 9.3 →
 10.0 ↓ 10.6 * 8.1 → 10.4 * 9.5 ↓
 beste Teiler 99.6 (37.) 149.0 (39.) 242.0 (36.)
 Trefferlage 2.08 mm rechts, 1.21 mm tief
 Streuwert 3.16, horizontal: 3.46, vertikal: 2.83

Unterschrift des Schützen

Meyton Elektronik

Ergebnis: **397.1** (379)
 Serien: 98.2 99.0 97.4 102.5
 Zähler: 19 21 0 0 0 0 0 0 0 0
 Innenzehner: 14
 weiteste: 457 (18), 451 (30), 427 (28)
 beste Teiler 18.2 (35.) 62.2 (32.) 92.9 (6.)
 Trefferlage 0.18 mm rechts, 0.18 mm tief
 Streuwert 2.01, horizontal: 2.25, vertikal: 1.73

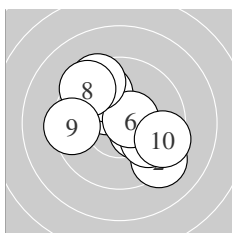
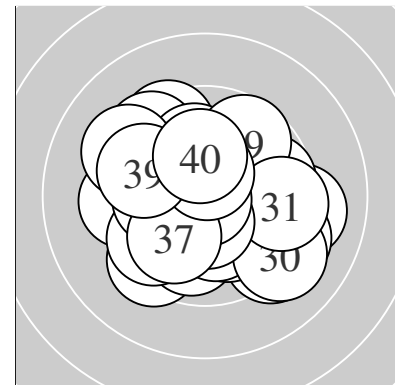

Serie 1:
 10.3 * 9.3 ↘ 10.3 * 9.9 ↘ 9.9 ↗
 10.6 * 9.5 ↗ 9.5 ↘ 9.4 ← 9.5 →
 beste Teiler 92.9 (6.) 153.5 (3.) 168.2 (1.)
 Trefferlage 0.07 mm rechts, 0.37 mm hoch
 Streuwert 2.26, horizontal: 2.49, vertikal: 2.01

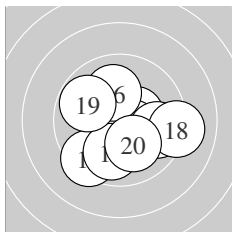

Serie 2:
 10.0 ↓ 10.4 * 10.5 * 9.4 ↗ 9.9 ↓
 10.1 ↑ 9.7 → 9.1 → 9.8 ↖ 10.1 ↘
 beste Teiler 112.8 (13.) 133.1 (12.) 214.5 (20.)
 Trefferlage 0.39 mm rechts, 0.78 mm tief
 Streuwert 1.99, horizontal: 2.23, vertikal: 1.70

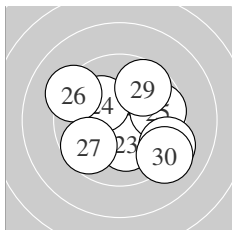

Serie 3:
 9.9 ↘ 10.4 * 10.2 * 10.2 * 9.7 →
 9.3 ↖ 9.7 ↙ 9.2 ↘ 9.7 ↗ 9.1 ↘
 beste Teiler 135.0 (22.) 189.0 (23.) 192.6 (24.)
 Trefferlage 0.67 mm rechts, 0.41 mm tief
 Streuwert 2.31, horizontal: 2.64, vertikal: 1.92

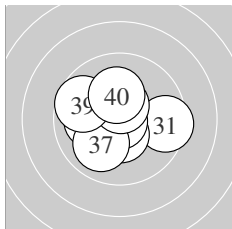

Serie 4:
 9.5 → 10.7 * 10.4 * 10.5 * 10.9 *
 10.1 ← 10.0 ↙ 10.5 * 9.7 ↖ 10.2 *
 beste Teiler 18.2 (35.) 62.2 (32.) 109.4 (38.)
 Trefferlage 0.41 mm links, 0.09 mm hoch
 Streuwert 1.50, horizontal: 1.76, vertikal: 1.20

Unterschrift des Schützen

Meyton Elektronik

Ergebnis: **401.1** (381)
 Serien: 99.9 99.4 100.0 101.8
 Zähler: 23 15 2 0 0 0 0 0 0 0
 Innenzehner: 16
 weiteste: 670 (6), 589 (20), 378 (21)
 beste Teiler 2.2 (11.) 8.9 (10.) 68.0 (31.)
 Trefferlage 0.06 mm rechts, 0.00 mm
 Streuwert 1.92, horizontal: 1.92, vertikal: 1.92

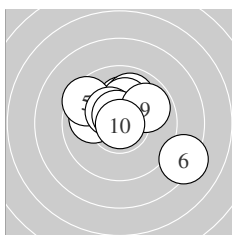
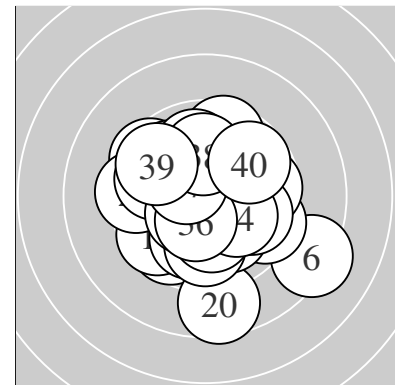

Serie 1:
 10.1 ↑ 10.0 ↗ 10.2 * 10.0 ← 9.5 ↘
 8.3 ↘ 10.4 * 10.6 * 9.9 ↗ 10.9 *
 beste Teiler 8.9 (10.) 80.0 (8.) 138.2 (7.)
 Trefferlage 0.33 mm rechts, 0.84 mm hoch
 Streuwert 2.11, horizontal: 2.48, vertikal: 1.65

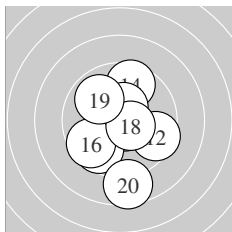

Serie 2:
 10.9 * 9.5 ↘ 10.6 * 9.6 ↑ 9.7 ↙
 9.6 ↙ 10.5 * 10.5 * 9.9 ↘ 8.6 ↓
 beste Teiler 2.2 (11.) 76.4 (13.) 112.2 (18.)
 Trefferlage 0.05 mm rechts, 0.67 mm tief
 Streuwert 2.19, horizontal: 1.75, vertikal: 2.56

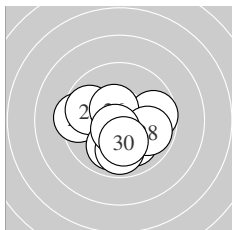

Serie 3:
 9.4 ← 9.8 ↖ 9.7 → 10.0 ↘ 10.0 ↓
 10.5 * 9.9 ↓ 9.9 ↘ 10.6 * 10.2 *
 beste Teiler 90.3 (29.) 113.1 (26.) 197.3 (30.)
 Trefferlage 0.09 mm links, 0.81 mm tief
 Streuwert 1.79, horizontal: 2.12, vertikal: 1.39

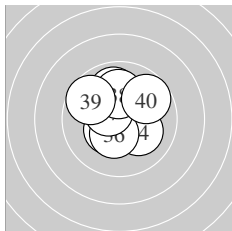

Serie 4:
 10.7 * 10.4 * 9.9 ↑ 10.1 ↘ 10.4 *
 10.4 * 10.5 * 10.0 ↑ 9.7 ↘ 9.7 ↗
 beste Teiler 68.0 (31.) 122.8 (37.) 141.5 (35.)
 Trefferlage 0.05 mm links, 0.61 mm hoch
 Streuwert 1.48, horizontal: 1.47, vertikal: 1.49

Unterschrift des Schützen

Meyton Elektronik

Ergebnis: **391.5** (376)
 Serien: 99.8 95.9 96.9 98.9
 Zähler: 21 15 3 1 0 0 0 0 0 0
 Innenzehner: 13
 weiteste: 958 (13), 649 (20), 577 (35)
 beste Teiler 44.7 (32.) 80.2 (10.) 109.6 (39.)
 Trefferlage 0.29 mm links, 0.45 mm hoch
 Streuwert 2.39, horizontal: 2.81, vertikal: 1.88

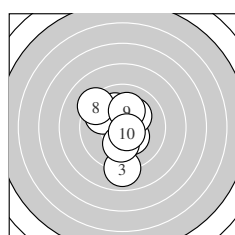
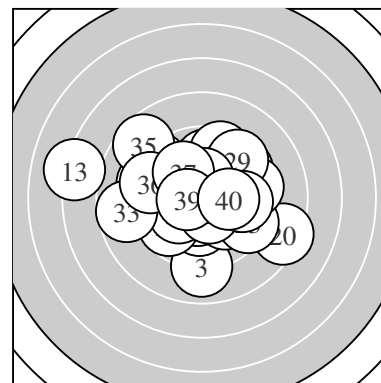

Serie 1:
 10.3 * 10.1 ↗ 9.0 ↓ 10.3 * 9.8 ↘
 10.1 ↓ 10.2 * 9.3 ↘ 10.1 ↑ 10.6 *
 beste Teiler 80.2 (10.) 154.3 (1.) 164.6 (4.)
 Trefferlage 0.32 mm links, 0.21 mm hoch
 Streuwert 1.98, horizontal: 1.48, vertikal: 2.38

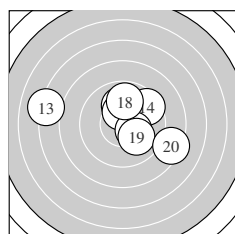

Serie 2:
 10.1 ↗ 10.4 * 7.1 ← 9.5 ↗ 10.0 ↑
 10.3 * 10.3 * 9.8 ↑ 10.0 ↘ 8.4 →
 beste Teiler 136.7 (12.) 151.7 (17.) 154.0 (16.)
 Trefferlage 0.45 mm rechts, 0.85 mm hoch
 Streuwert 3.05, horizontal: 3.90, vertikal: 1.84

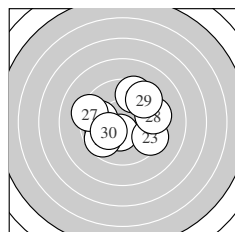

Serie 3:
 10.4 * 9.8 ← 9.4 ↘ 9.9 ← 9.5 ↑
 9.7 ↗ 9.3 ← 9.4 → 9.4 ↗ 10.1 ←
 beste Teiler 131.9 (21.) 201.9 (30.) 252.9 (24.)
 Trefferlage 0.25 mm links, 0.13 mm hoch
 Streuwert 2.40, horizontal: 2.82, vertikal: 1.88

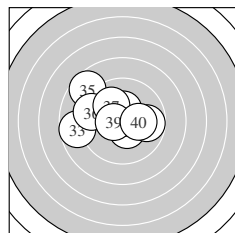

Serie 4:
 10.5 * 10.8 * 8.7 ← 10.4 * 8.6 ↘
 9.4 ← 10.0 ↘ 9.8 → 10.5 * 10.2 *
 beste Teiler 44.7 (32.) 109.6 (39.) 122.5 (31.)
 Trefferlage 1.03 mm links, 0.61 mm hoch
 Streuwert 2.22, horizontal: 2.76, vertikal: 1.51

Unterschrift des Schützen

Meyton Elektronik

Ergebnis: **391.9** (372)
 Serien: 98.9 96.1 98.1 98.8
 Zähler: 17 18 5 0 0 0 0 0 0 0
 Innenzehner: 14
 weiteste: 682 (7), 600 (28), 520 (39)
 beste Teiler 43.0 (3.) 82.1 (34.) 90.3 (22.)
 Trefferlage 0.44 mm links, 0.48 mm hoch
 Streuwert 2.31, horizontal: 2.86, vertikal: 1.57

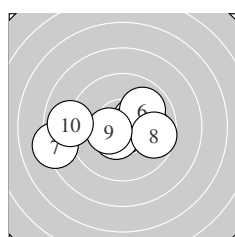
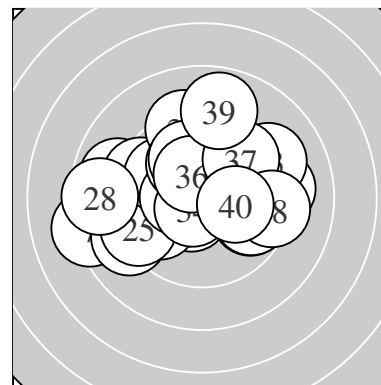

Serie 1:
 10.4 * 9.9 → 10.8 * 10.2 * 10.5 *
 9.9 ↗ 8.2 ← 9.7 → 10.4 * 8.9 ←
 beste Teiler 43.0 (3.) 109.8 (5.) 138.0 (9.)
 Trefferlage 0.31 mm links, 0.13 mm tief
 Streuwert 2.40, horizontal: 3.25, vertikal: 0.97

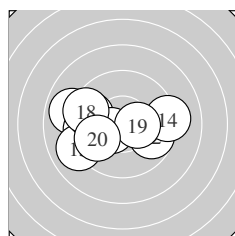

Serie 2:
 8.9 ← 9.7 → 9.5 ← 9.2 → 9.0 ←
 9.7 ← 10.5 * 9.4 ← 10.4 * 9.8 ←
 beste Teiler 125.0 (17.) 145.4 (19.) 283.3 (20.)
 Trefferlage 1.43 mm links, 0.20 mm tief
 Streuwert 2.44, horizontal: 3.24, vertikal: 1.20

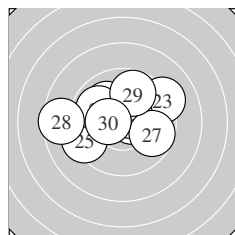

Serie 3:
 10.0 ↘ 10.6 * 9.2 ↗ 10.6 * 9.3 ←
 9.9 ↘ 9.7 → 8.6 ← 9.8 ↑ 10.4 *
 beste Teiler 90.3 (22.) 95.4 (24.) 141.0 (30.)
 Trefferlage 0.56 mm links, 0.60 mm hoch
 Streuwert 2.36, horizontal: 3.02, vertikal: 1.43

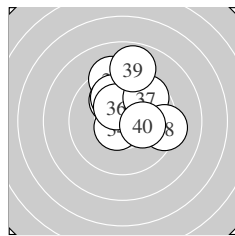

Serie 4:
 9.3 ↑ 10.5 * 10.0 ↘ 10.6 * 10.0 ↘
 10.3 * 9.7 ↗ 9.3 → 8.9 ↑ 10.2 *
 beste Teiler 82.1 (34.) 115.8 (32.) 151.3 (36.)
 Trefferlage 0.54 mm rechts, 1.66 mm hoch
 Streuwert 1.84, horizontal: 1.75, vertikal: 1.93

Unterschrift des Schützen

Meyton Elektronik

Ergebnis: **191.3** (182)
 Serien: 96.8 94.5
 Zähler: 8 7 4 1 0 0 0 0 0 0
 Innenzehner: 4
 weiteste: 761 (20), 688 (18), 612 (4)
 beste Teiler 106.2 (16.) 111.0 (17.) 155.6 (2.)
 Trefferlage 0.07 mm rechts, 0.81 mm hoch
 Streuwert 2.80, horizontal: 3.09, vertikal: 2.49

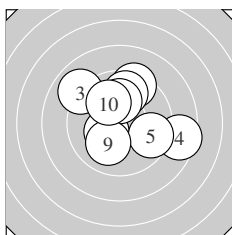
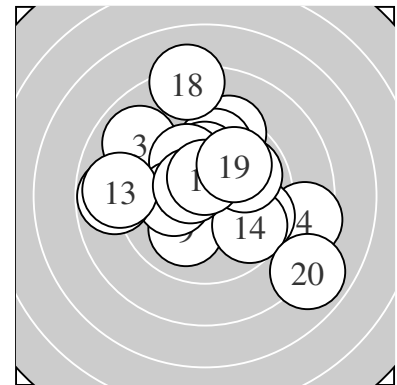

Serie 1:
 9.4 ↗ 10.3 * 9.0 ↘ 8.5 → 9.6 ↘
 10.1 ↖ 9.7 ↑ 10.1 ↑ 10.1 ↙ 10.0 ↖
 beste Teiler 155.6 (2.) 218.2 (6.) 219.0 (8.)
 Trefferlage 0.28 mm rechts, 1.07 mm hoch
 Streuwert 2.46, horizontal: 2.72, vertikal: 2.17

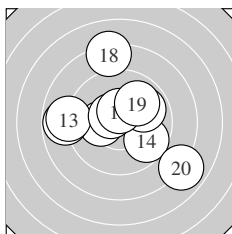

Serie 2:
 10.2 * 8.8 ← 8.9 ← 9.7 ↘ 9.9 ↗
 10.5 * 10.5 * 8.2 ↑ 9.9 ↗ 7.9 ↘
 beste Teiler 106.2 (16.) 111.0 (17.) 186.6 (11.)
 Trefferlage 0.14 mm links, 0.55 mm hoch
 Streuwert 3.22, horizontal: 3.55, vertikal: 2.86

Unterschrift des Schützen

Ergebnis: **358.0** (338)
 Serien: 88.8 94.8 79.5 94.9
 Zähler: 12 10 11 4 2 0 0 0 0 0
 Innenzehner: 11
 weiteste: 3028 (27), 1082 (21), 1043 (16)
 beste Teiler 64.1 (39.) 79.7 (13.) 82.0 (23.)
 Trefferlage 3.03 mm rechts, 0.20 mm tief
 Streuwert 4.59, horizontal: 5.33, vertikal: 3.71

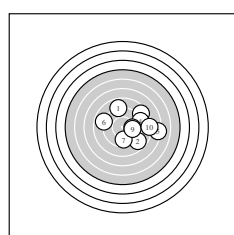
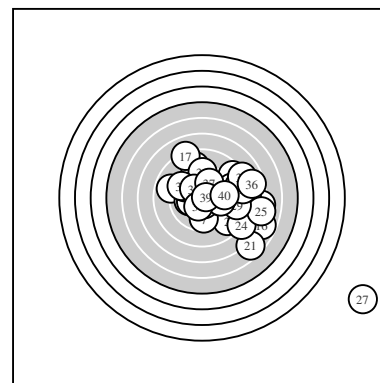

Serie 1:
 8.9 ↑ 8.8 ↘ 8.5 ↗ 9.0 → 7.2 →
 8.9 ↖ 9.6 ↓ 9.9 → 9.9 → 8.1 →
 beste Teiler 259.1 (8.) 267.1 (9.) 329.1 (7.)
 Trefferlage 2.95 mm rechts, 0.33 mm hoch
 Streuwert 3.52, horizontal: 4.14, vertikal: 2.75

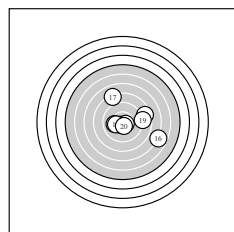

Serie 2:
 8.5 → 10.6 * 10.6 * 10.6 * 10.1 ←
 6.8 ↘ 8.1 ↖ 10.2 * 8.8 → 10.5 *
 beste Teiler 79.7 (13.) 89.4 (12.) 93.0 (14.)
 Trefferlage 1.47 mm rechts, 0.08 mm hoch
 Streuwert 3.48, horizontal: 4.05, vertikal: 2.80

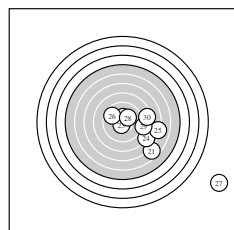

Serie 3:
 6.6 ↘ 10.4 * 10.6 * 7.9 ↘ 7.1 →
 9.7 ↖ 0.0 ↘ 10.2 * 8.7 → 8.3 →
 beste Teiler 82.0 (23.) 138.1 (22.) 185.8 (28.)
 Trefferlage 5.95 mm rechts, 2.64 mm tief
 Streuwert 6.89, horizontal: 7.98, vertikal: 5.59

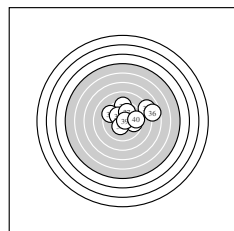

Serie 4:
 9.3 ↑ 9.4 ↖ 8.1 ↗ 10.2 * 9.7 →
 7.7 → 9.9 ↗ 10.4 * 10.7 * 9.5 →
 beste Teiler 64.1 (39.) 148.6 (38.) 194.2 (34.)
 Trefferlage 1.76 mm rechts, 1.41 mm hoch
 Streuwert 2.75, horizontal: 3.47, vertikal: 1.74

Unterschrift des Schützen

Meyton Elektronik

Ergebnis: **368.6** (351)
 Serien: 88.1 93.1 91.7 95.7
 Zähler: 8 17 13 2 0 0 0 0 0 0
 Innenzehner: 3
 weiteste: 984 (7), 791 (25), 693 (18)
 beste Teiler 119.7 (11.) 142.0 (34.) 151.9 (8.)
 Trefferlage 0.97 mm links, 2.05 mm tief
 Streuwert 3.00, horizontal: 3.37, vertikal: 2.57

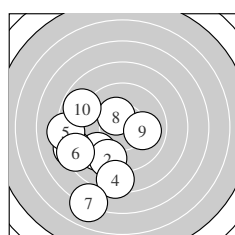
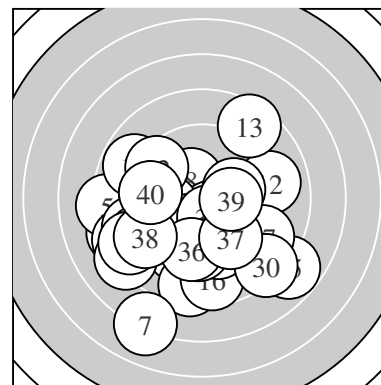

Serie 1:
 9.3 ↙ 9.3 ↓ 8.4 ← 8.4 ↓ 8.2 ←
 8.4 ← 7.0 ↓ 10.3 * 10.0 → 8.8 ↗
 beste Teiler 151.9 (8.) 239.7 (9.) 410.2 (2.)
 Trefferlage 3.12 mm links, 2.45 mm tief
 Streuwert 3.14, horizontal: 2.86, vertikal: 3.39

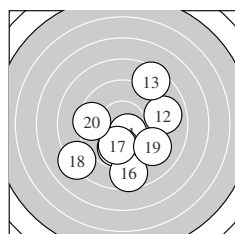

Serie 2:
 10.5 * 9.0 → 8.5 ↗ 9.9 ↓ 9.8 ↓
 8.6 ↓ 9.9 ↓ 8.2 ↙ 9.2 ↘ 9.5 ←
 beste Teiler 119.7 (11.) 258.7 (17.) 275.2 (14.)
 Trefferlage 0.22 mm rechts, 1.52 mm tief
 Streuwert 3.14, horizontal: 3.19, vertikal: 3.09

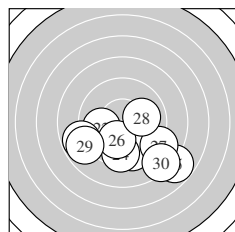

Serie 3:
 9.5 ↓ 9.9 ← 8.8 ← 9.5 ↓ 7.8 ↘
 10.1 ↓ 8.9 ↘ 10.0 → 8.9 ← 8.3 ↘
 beste Teiler 218.8 (26.) 233.5 (28.) 257.6 (22.)
 Trefferlage 0.56 mm rechts, 2.66 mm tief
 Streuwert 2.97, horizontal: 3.83, vertikal: 1.74

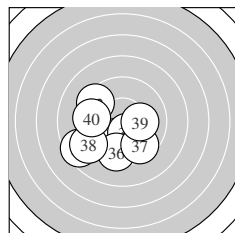

Serie 4:
 9.6 ↙ 9.4 ↘ 10.1 ↓ 10.4 * 8.5 ←
 9.5 ↓ 9.6 ↘ 9.0 ← 10.1 → 9.5 ←
 beste Teiler 142.0 (34.) 205.0 (33.) 206.2 (39.)
 Trefferlage 1.55 mm links, 1.57 mm tief
 Streuwert 2.23, horizontal: 2.56, vertikal: 1.86

Unterschrift des Schützen

Meyton Elektronik

Ergebnis: **399.8** (381)
 Serien: 101.1 97.5 102.6 98.6
 Zähler: 23 15 2 0 0 0 0 0 0 0
 Innenzehner: 18
 weiteste: 515 (32), 513 (14), 475 (17)
 beste Teiler 12.8 (23.) 31.7 (35.) 51.0 (7.)
 Trefferlage 0.25 mm links, 0.08 mm hoch
 Streuwert 1.94, horizontal: 2.10, vertikal: 1.77

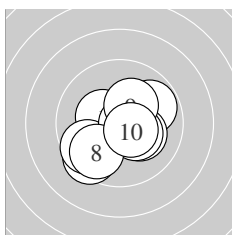
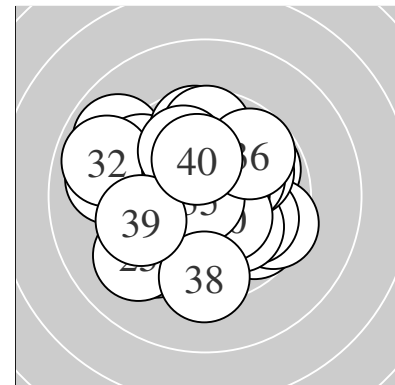

Serie 1:
 10.4 * 9.8 ↗ 10.2 * 10.3 * 9.5 ↙
 9.6 ↙ 10.7 * 9.8 ↙ 10.3 * 10.5 *
 beste Teiler 51.0 (7.) 108.5 (10.) 149.6 (1.)
 Trefferlage 0.05 mm links, 0.60 mm tief
 Streuwert 1.68, horizontal: 1.87, vertikal: 1.46

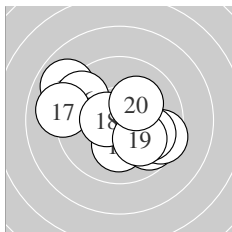

Serie 2:
 10.1 ↓ 9.7 ↘ 9.5 ↘ 8.9 ↖ 9.9 ↘
 9.5 ↖ 9.1 ← 10.5 * 10.1 ↘ 10.2 *
 beste Teiler 106.1 (18.) 194.4 (20.) 202.1 (11.)
 Trefferlage 0.19 mm links, 0.10 mm tief
 Streuwert 2.42, horizontal: 2.96, vertikal: 1.72

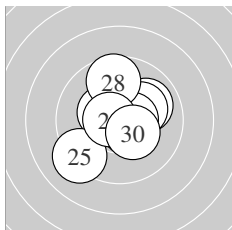

Serie 3:
 10.4 * 10.0 ↗ 10.9 * 10.2 * 9.2 ↙
 10.6 * 10.6 * 9.7 ↑ 10.6 * 10.4 *
 beste Teiler 12.8 (23.) 80.1 (29.) 95.1 (27.)
 Trefferlage 0.07 mm rechts, 0.13 mm hoch
 Streuwert 1.61, horizontal: 1.62, vertikal: 1.60

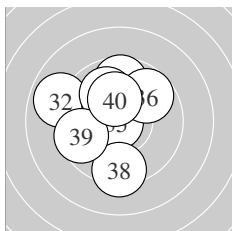

Serie 4:
 10.1 ↑ 8.9 ↖ 9.7 ↑ 10.3 * 10.8 *
 9.7 ↗ 10.0 ↘ 9.3 ↓ 9.6 ↙ 10.2 *
 beste Teiler 31.7 (35.) 158.0 (34.) 185.3 (40.)
 Trefferlage 0.84 mm links, 0.91 mm hoch
 Streuwert 2.04, horizontal: 1.93, vertikal: 2.15

Unterschrift des Schützen

Ergebnis: **181.4** (171)
 Serien: 84.3 97.1
 Zähler: 7 5 2 4 2 0 0 0 0 0
 Innenzehner: 7
 weiteste: 1150 (20), 1005 (9), 867 (4)
 beste Teiler 117.9 (19.) 134.8 (11.) 149.8 (18.)
 Trefferlage 1.60 mm links, 1.45 mm hoch
 Streuwert 3.82, horizontal: 4.89, vertikal: 2.29

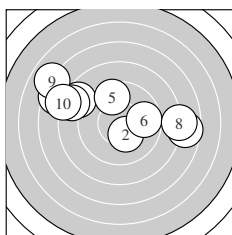
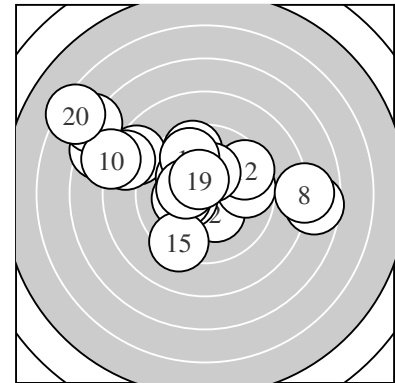

Serie 1:
 7.6 → 10.3 * 8.6 ↖ 7.5 ↖ 9.6 ↑
 9.7 → 8.3 ↖ 7.9 → 6.9 ↖ 7.9 ↖
 beste Teiler 159.3 (2.) 312.2 (6.) 342.1 (5.)
 Trefferlage 1.61 mm links, 1.84 mm hoch
 Streuwert 4.72, horizontal: 6.33, vertikal: 2.15

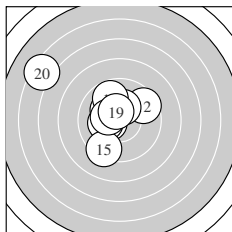

Serie 2:
 10.4 * 9.6 ↗ 10.2 * 10.2 * 9.3 ↙
 10.3 * 9.8 ↘ 10.4 * 10.5 * 6.4 ↖
 beste Teiler 117.9 (19.) 134.8 (11.) 149.8 (18.)
 Trefferlage 1.59 mm links, 1.06 mm hoch
 Streuwert 2.88, horizontal: 3.24, vertikal: 2.47

Unterschrift des Schützen

Ergebnis: **192.0** (187)
 Serien: 95.7 96.3
 Zähler: 8 11 1 0 0 0 0 0 0 0
 Innenzehner: 3
 weiteste: 615 (8), 494 (13), 483 (20)
 beste Teiler 176.2 (3.) 198.0 (15.) 200.8 (16.)
 Trefferlage 0.72 mm rechts, 0.08 mm hoch
 Streuwert 2.55, horizontal: 2.96, vertikal: 2.07

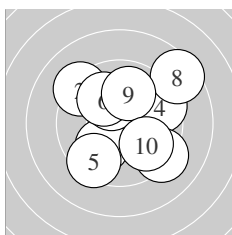
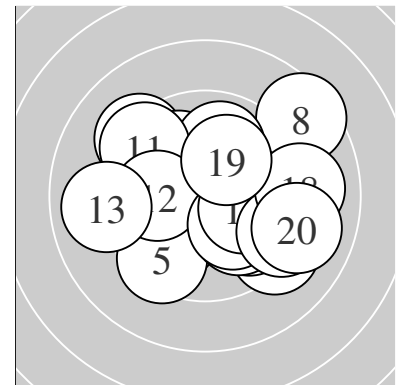

Serie 1:
 10.0 ↙ 9.2 ↘ 10.2 * 9.5 → 9.4 ↙
 10.0 ↘ 9.2 ↘ 8.5 ↗ 9.9 ↑ 9.8 ↘
 beste Teiler 176.2 (3.) 238.2 (1.) 238.5 (6.)
 Trefferlage 0.57 mm rechts, 0.48 mm hoch
 Streuwert 2.65, horizontal: 2.74, vertikal: 2.55

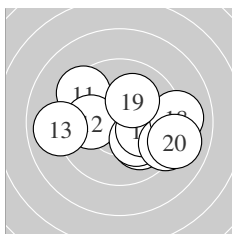

Serie 2:
 9.4 ↘ 10.0 ← 9.0 ← 10.0 ↘ 10.2 *
 10.2 * 9.3 ↘ 9.1 → 10.1 ↗ 9.0 ↘
 beste Teiler 198.0 (15.) 200.8 (16.) 208.0 (19.)
 Trefferlage 0.88 mm rechts, 0.30 mm tief
 Streuwert 2.55, horizontal: 3.30, vertikal: 1.47

Unterschrift des Schützen

Ergebnis: **187.9** (180)
 Serien: 92.0 95.9
 Zähler: 7 7 5 1 0 0 0 0 0 0
 Innenzehner: 5
 weiteste: 968 (9), 736 (11), 664 (4)
 beste Teiler 126.5 (20.) 130.3 (7.) 184.5 (12.)
 Trefferlage 1.31 mm links, 0.47 mm hoch
 Streuwert 3.09, horizontal: 3.60, vertikal: 2.48

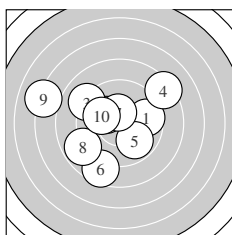
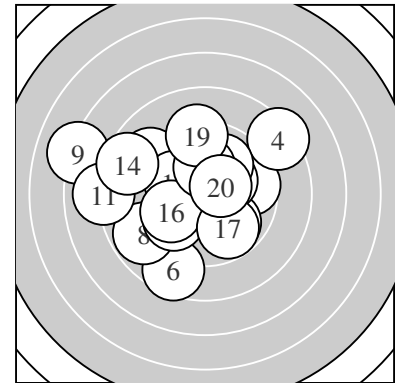

Serie 1:
 9.6 → 10.2 * 9.1 ↖ 8.3 ↗ 9.9 ↘
 8.6 ↙ 10.4 * 8.8 ↗ 7.1 ↖ 10.0 ↖
 beste Teiler 130.3 (7.) 191.2 (2.) 235.4 (10.)
 Trefferlage 1.35 mm links, 0.29 mm hoch
 Streuwert 3.60, horizontal: 4.17, vertikal: 2.92

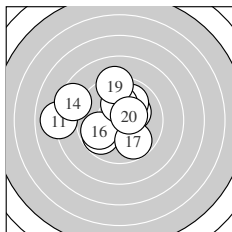

Serie 2:
 8.0 ← 10.2 * 10.0 ↗ 8.5 ↖ 9.8 ↗
 9.8 ↗ 9.8 ↘ 10.2 * 9.2 ↑ 10.4 *
 beste Teiler 126.5 (20.) 184.5 (12.) 194.0 (18.)
 Trefferlage 1.27 mm links, 0.64 mm hoch
 Streuwert 2.67, horizontal: 3.15, vertikal: 2.09

Unterschrift des Schützen

Ergebnis: **184.2** (175)
 Serien: 89.3 94.9
 Zähler: 5 7 6 2 0 0 0 0 0 0
 Innenzehner: 4
 weiteste: 849 (8), 791 (10), 703 (16)
 beste Teiler 80.1 (7.) 130.6 (18.) 172.1 (15.)
 Trefferlage 1.78 mm links, 0.68 mm tief
 Streuwert 3.26, horizontal: 3.47, vertikal: 3.04

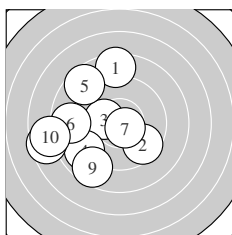
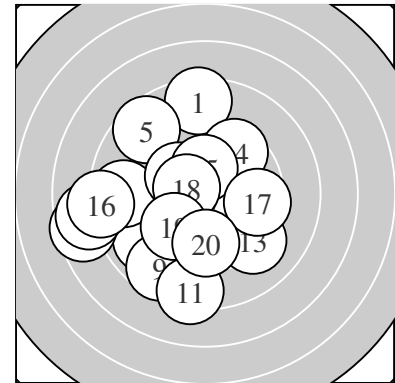

Serie 1:
 8.5 ↑ 9.6 ↘ 10.2 * 9.0 ↙ 8.6 ↖
 8.8 ← 10.6 * 7.6 ← 8.6 ↘ 7.8 ←
 beste Teiler 80.1 (7.) 178.5 (3.) 348.3 (2.)
 Trefferlage 3.13 mm links, 0.35 mm tief
 Streuwert 3.44, horizontal: 3.49, vertikal: 3.38

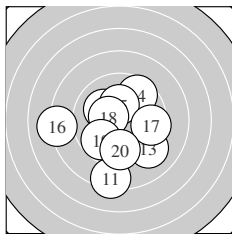

Serie 2:
 8.3 ↓ 10.1 ↖ 9.2 ↘ 9.6 ↗ 10.3 *
 8.1 ← 9.5 → 10.4 * 9.8 ↘ 9.6 ↓
 beste Teiler 130.6 (18.) 172.1 (15.) 216.0 (12.)
 Trefferlage 0.44 mm links, 1.01 mm tief
 Streuwert 2.92, horizontal: 3.05, vertikal: 2.79

Unterschrift des Schützen

Ergebnis: **191.4** (183)
 Serien: 95.4 96.0
 Zähler: 6 12 1 1 0 0 0 0 0 0
 Innenzehner: 4
 weiteste: 796 (1), 682 (15), 481 (9)
 beste Teiler 83.7 (2.) 116.9 (6.) 120.7 (14.)
 Trefferlage 1.33 mm links, 0.95 mm tief
 Streuwert 2.56, horizontal: 2.79, vertikal: 2.29

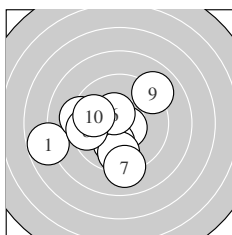
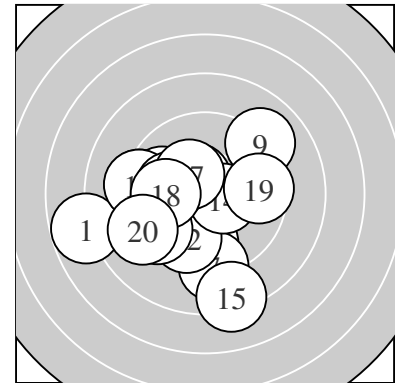

Serie 1:
 7.8 ← 10.6 * 10.1 ↓ 9.3 ← 9.7 ↓
 10.5 * 9.1 ↓ 9.5 ← 9.0 ↗ 9.8 ←
 beste Teiler 83.7 (2.) 116.9 (6.) 213.5 (3.)
 Trefferlage 1.46 mm links, 0.74 mm tief
 Streuwert 2.76, horizontal: 3.14, vertikal: 2.31

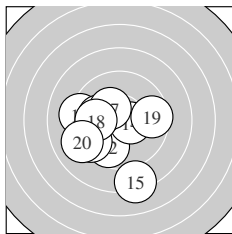

Serie 2:
 9.2 ← 9.7 ↓ 9.4 ↙ 10.5 * 8.2 ↓
 10.1 ← 10.3 * 9.9 ← 9.6 → 9.1 ←
 beste Teiler 120.7 (14.) 160.7 (17.) 225.7 (16.)
 Trefferlage 1.19 mm links, 1.16 mm tief
 Streuwert 2.47, horizontal: 2.56, vertikal: 2.38

Unterschrift des Schützen

Ergebnis: **158.7** (151)
 Serien: 83.1 75.6
 Zähler: 2 4 6 3 2 2 1 0 0 0
 Innenzehner: 2
 weiteste: 1723 (20), 1485 (15), 1438 (16)
 beste Teiler 82.0 (13.) 187.2 (11.) 301.2 (18.)
 Trefferlage 4.77 mm rechts, 2.25 mm tief
 Streuwert 4.96, horizontal: 6.08, vertikal: 3.50

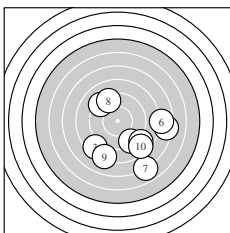
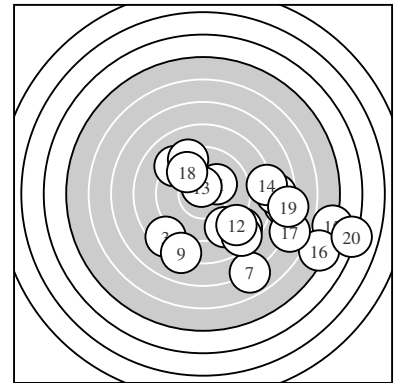

Serie 1:
 9.2 ↘ 9.2 ↖ 8.4 ↙ 7.3 → 8.6 ↘
 7.7 → 6.9 ↘ 9.3 ↖ 8.1 ↓ 8.4 ↘
 beste Teiler 416.9 (8.) 442.6 (1.) 443.4 (2.)
 Trefferlage 2.19 mm rechts, 2.66 mm tief
 Streuwert 4.43, horizontal: 4.79, vertikal: 4.04

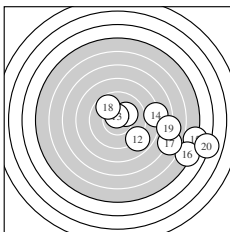

Serie 2:
 10.2 * 8.9 ↘ 10.6 * 8.1 → 5.0 →
 5.2 ↘ 6.7 ↘ 9.7 ↖ 7.1 → 4.1 →
 beste Teiler 82.0 (13.) 187.2 (11.) 301.2 (18.)
 Trefferlage 7.34 mm rechts, 1.83 mm tief
 Streuwert 4.97, horizontal: 6.35, vertikal: 3.01

Unterschrift des Schützen

Ergebnis: **196.1** (186)
 Serien: 97.9 98.2
 Zähler: 8 10 2 0 0 0 0 0 0 0
 Innenzehner: 8
 weiteste: 552 (5), 501 (6), 489 (11)
 beste Teiler 67.6 (2.) 108.4 (8.) 117.3 (15.)
 Trefferlage 0.42 mm rechts, 1.29 mm hoch
 Streuwert 2.07, horizontal: 2.11, vertikal: 2.01

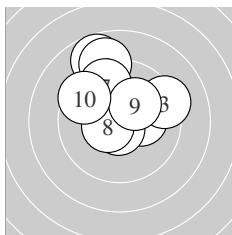
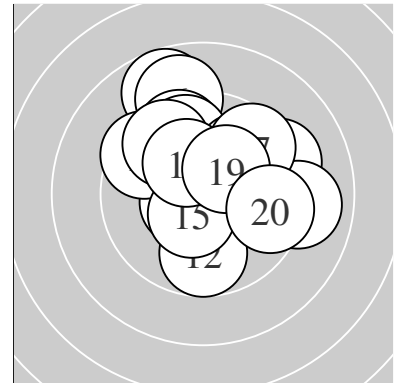

Serie 1:
 10.2 * 10.7 * 9.3 ↗ 10.3 * 8.7 ↖
 8.9 ↗ 9.6 ↖ 10.5 * 10.2 * 9.5 ↖
 beste Teiler 67.6 (2.) 108.4 (8.) 156.5 (4.)
 Trefferlage 0.11 mm links, 1.87 mm hoch
 Streuwert 2.01, horizontal: 2.01, vertikal: 2.01

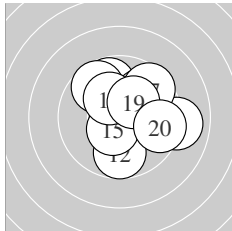

Serie 2:
 9.0 → 9.7 ↓ 9.8 ↖ 9.9 ↗ 10.5 *
 9.7 ↖ 9.6 ↗ 10.2 * 10.3 * 9.5 →
 beste Teiler 117.3 (15.) 173.3 (19.) 180.2 (18.)
 Trefferlage 0.96 mm rechts, 0.71 mm hoch
 Streuwert 2.06, horizontal: 2.18, vertikal: 1.94

Unterschrift des Schützen

Ergebnis: **177.1** (166)
 Serien: 89.9 87.2
 Zähler: 2 9 4 4 0 1 0 0 0 0
 Innenzehner: 2
 weiteste: 1292 (12), 966 (3), 792 (17)
 beste Teiler 106.0 (8.) 149.9 (16.) 259.2 (4.)
 Trefferlage 0.50 mm rechts, 0.07 mm tief
 Streuwert 4.32, horizontal: 5.23, vertikal: 3.15

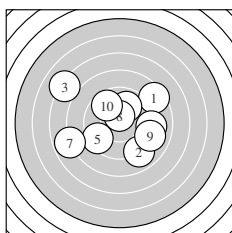
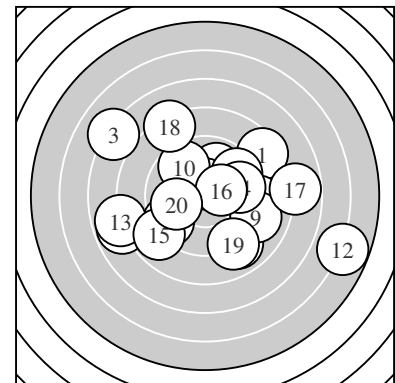

Serie 1:
 8.5 ↗ 8.9 ↘ 7.1 ↖ 9.9 ↗ 9.4 ↖
 9.1 → 7.8 ← 10.5 * 9.0 → 9.7 ↘
 beste Teiler 106.0 (8.) 259.2 (4.) 317.4 (10.)
 Trefferlage 0.24 mm links, 0.36 mm hoch
 Streuwert 4.04, horizontal: 4.78, vertikal: 3.13

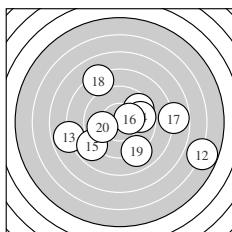

Serie 2:
 9.6 ↗ 5.8 → 7.9 ← 9.7 → 8.9 ↖
 10.4 * 7.8 → 8.2 ↘ 9.0 ↘ 9.9 ←
 beste Teiler 149.9 (16.) 260.8 (20.) 313.3 (14.)
 Trefferlage 1.26 mm rechts, 0.52 mm tief
 Streuwert 4.71, horizontal: 5.81, vertikal: 3.26

Unterschrift des Schützen

Ergebnis: **200.7** (192)
 Serien: 102.8 97.9
 Zähler: 14 4 2 0 0 0 0 0 0 0
 Innenzehner: 12
 weiteste: 591 (20), 522 (1), 443 (13)
 beste Teiler 20.8 (6.) 92.9 (12.) 113.6 (9.)
 Trefferlage 0.02 mm links, 0.36 mm hoch
 Streuwert 2.01, horizontal: 2.19, vertikal: 1.80

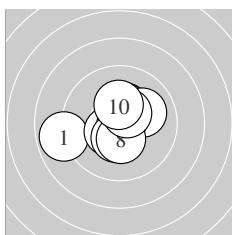
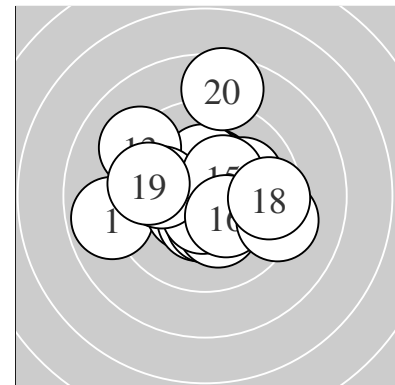

Serie 1:
 8.9 ← 10.5 * 10.4 * 10.4 * 10.1 ↗
 10.9 * 10.4 * 10.4 * 10.5 * 10.3 *
 beste Teiler 20.8 (6.) 113.6 (9.) 124.2 (2.)
 Trefferlage 0.26 mm links, 0.17 mm hoch
 Streuwert 1.59, horizontal: 1.86, vertikal: 1.25

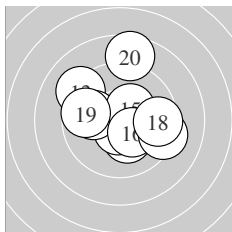

Serie 2:
 10.2 * 10.6 * 9.2 ↘ 10.0 ← 10.4 *
 10.3 * 9.3 → 9.6 → 9.7 ← 8.6 ↑
 beste Teiler 92.9 (12.) 145.0 (15.) 159.8 (16.)
 Trefferlage 0.21 mm rechts, 0.55 mm hoch
 Streuwert 2.42, horizontal: 2.56, vertikal: 2.27

Unterschrift des Schützen

Ergebnis: **201.4** (194)
 Serien: 102.6 98.8
 Zähler: 15 4 1 0 0 0 0 0 0 0
 Innenzehner: 8
 weiteste: 551 (16), 468 (14), 418 (13)
 beste Teiler 51.6 (10.) 55.8 (19.) 63.3 (9.)
 Trefferlage 0.25 mm links, 0.80 mm hoch
 Streuwert 1.77, horizontal: 2.42, vertikal: 0.64

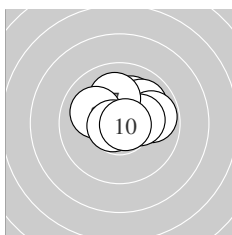
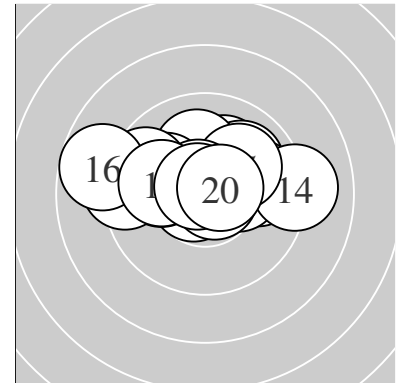

Serie 1:
 10.6 * 10.1 ↗ 10.3 * 10.0 ↗ 9.8 →
 10.3 * 10.1 ↑ 10.0 ↖ 10.7 * 10.7 *
 beste Teiler 51.6 (10.) 63.3 (9.) 78.0 (1.)
 Trefferlage 0.56 mm rechts, 0.90 mm hoch
 Streuwert 1.15, horizontal: 1.41, vertikal: 0.81

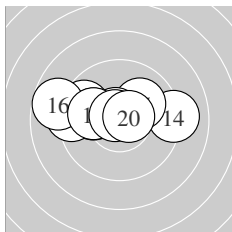

Serie 2:
 9.6 ↖ 10.0 ← 9.3 ← 9.1 → 10.1 ↗
 8.7 ↖ 10.7 * 10.0 ← 10.7 * 10.6 *
 beste Teiler 55.8 (19.) 68.2 (17.) 85.2 (20.)
 Trefferlage 1.06 mm links, 0.71 mm hoch
 Streuwert 2.13, horizontal: 2.98, vertikal: 0.45

Unterschrift des Schützen

Ergebnis: **192.7** (182)
 Serien: 96.8 95.9
 Zähler: 8 7 4 1 0 0 0 0 0 0
 Innenzehner: 6
 weiteste: 795 (10), 576 (20), 573 (1)
 beste Teiler 42.6 (17.) 63.6 (4.) 89.0 (7.)
 Trefferlage 0.52 mm rechts, 0.43 mm tief
 Streuwert 2.75, horizontal: 3.62, vertikal: 1.44

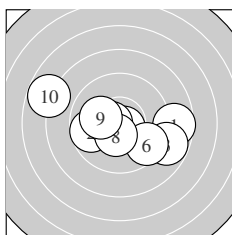
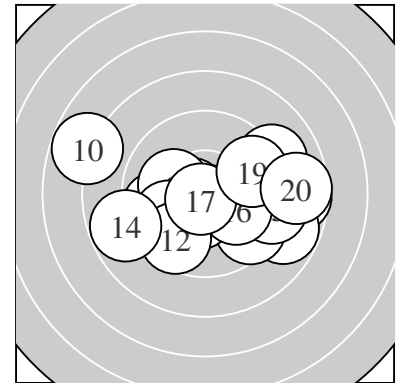

Serie 1:
 8.7 → 9.7 ← 8.8 ↘ 10.7 * 10.5 *
 9.5 ↘ 10.6 * 10.4 * 10.1 ← 7.8 ←
 beste Teiler 63.6 (4.) 89.0 (7.) 125.4 (5.)
 Trefferlage 0.09 mm links, 0.34 mm tief
 Streuwert 2.94, horizontal: 3.88, vertikal: 1.46

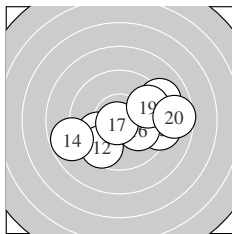

Serie 2:
 9.9 ↙ 9.6 ↙ 10.2 * 8.8 ← 9.2 →
 10.1 ↘ 10.8 * 9.1 ↗ 9.6 → 8.6 →
 beste Teiler 42.6 (17.) 187.6 (13.) 219.1 (16.)
 Trefferlage 1.14 mm rechts, 0.51 mm tief
 Streuwert 2.64, horizontal: 3.42, vertikal: 1.49

Unterschrift des Schützen

Ergebnis: **196.0** (188)
 Serien: 95.6 100.4
 Zähler: 10 8 2 0 0 0 0 0 0 0
 Innenzehner: 7
 weiteste: 579 (5), 532 (6), 465 (14)
 beste Teiler 79.2 (4.) 105.4 (19.) 154.2 (20.)
 Trefferlage 0.73 mm links, 0.72 mm hoch
 Streuwert 2.18, horizontal: 2.50, vertikal: 1.81

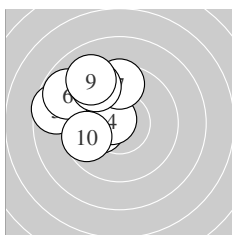
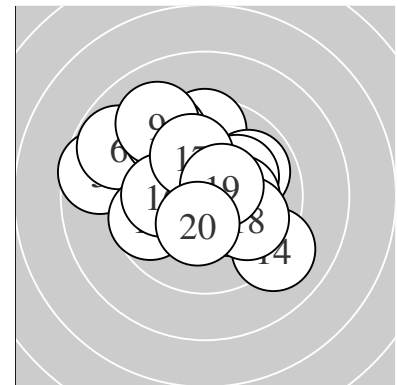

Serie 1:
 10.1 ↘ 9.5 ← 10.2 * 10.6 * 8.6 ←
 8.8 ↘ 9.6 ↑ 9.4 ↘ 9.1 ↘ 9.7 ←
 beste Teiler 79.2 (4.) 184.8 (3.) 218.6 (1.)
 Trefferlage 2.52 mm links, 1.59 mm hoch
 Streuwert 1.73, horizontal: 1.73, vertikal: 1.72

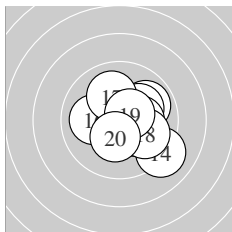

Serie 2:
 9.9 ↗ 10.2 * 10.3 * 9.1 ↘ 10.2 *
 10.0 ← 10.0 ↘ 9.9 ↘ 10.5 * 10.3 *
 beste Teiler 105.4 (19.) 154.2 (20.) 165.2 (13.)
 Trefferlage 1.06 mm rechts, 0.15 mm tief
 Streuwert 1.62, horizontal: 1.74, vertikal: 1.50

Unterschrift des Schützen

Ergebnis: **198.2** (190)
 Serien: 98.3 99.9
 Zähler: 12 6 2 0 0 0 0 0 0 0
 Innenzehner: 7
 weiteste: 584 (20), 556 (8), 368 (2)
 beste Teiler 82.8 (19.) 95.4 (18.) 115.2 (9.)
 Trefferlage 0.27 mm rechts, 1.12 mm tief
 Streuwert 1.92, horizontal: 2.19, vertikal: 1.60

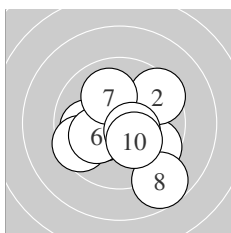
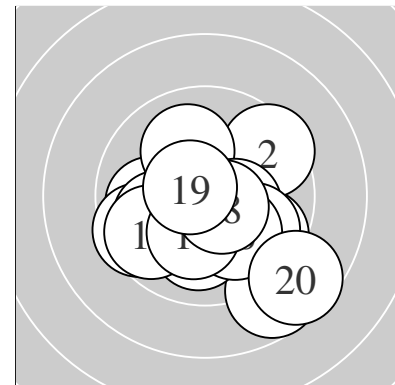

Serie 1:
 9.6 ↘ 9.5 ↗ 9.9 ← 9.5 ← 10.3 *
 10.1 ← 10.0 ↖ 8.7 ↘ 10.5 * 10.2 *
 beste Teiler 115.2 (9.) 152.9 (5.) 178.7 (10.)
 Trefferlage 0.14 mm rechts, 0.78 mm tief
 Streuwert 2.17, horizontal: 2.38, vertikal: 1.94

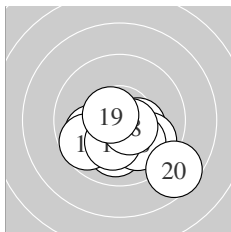

Serie 2:
 10.0 ← 10.0 ↓ 10.4 * 9.7 ← 9.8 ↘
 10.0 ↘ 10.2 * 10.6 * 10.6 * 8.6 ↘
 beste Teiler 82.8 (19.) 95.4 (18.) 150.5 (13.)
 Trefferlage 0.39 mm rechts, 1.46 mm tief
 Streuwert 1.70, horizontal: 2.10, vertikal: 1.18

Unterschrift des Schützen

Ergebnis: **202.8** (192)
 Serien: 101.7 101.1
 Zähler: 12 8 0 0 0 0 0 0 0 0
 Innenzehner: 9
 weiteste: 471 (15), 352 (2), 302 (9)
 beste Teiler 21.1 (3.) 67.2 (1.) 73.3 (11.)
 Trefferlage 0.12 mm rechts, 0.01 mm hoch
 Streuwert 1.68, horizontal: 1.97, vertikal: 1.34

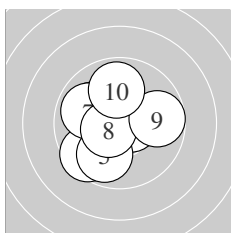
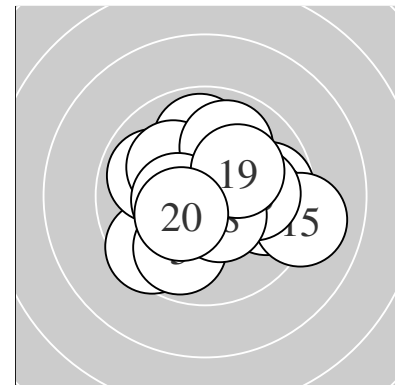

Serie 1:
 10.7 * 9.5 ↙ 10.9 * 10.6 * 9.9 ↙
 10.0 ↖ 9.9 ↖ 10.6 * 9.7 → 9.9 ↑
 beste Teiler 21.1 (3.) 67.2 (1.) 89.2 (4.)
 Trefferlage 0.60 mm links, 0.12 mm tief
 Streuwert 1.62, horizontal: 1.69, vertikal: 1.55

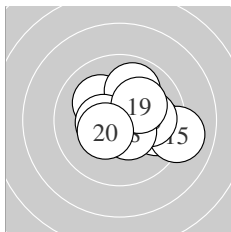

Serie 2:
 10.7 * 10.1 ↖ 9.8 → 9.9 ↗ 9.1 →
 10.0 → 10.4 * 10.5 * 10.2 * 10.4 *
 beste Teiler 73.3 (11.) 117.0 (18.) 131.3 (17.)
 Trefferlage 0.84 mm rechts, 0.15 mm hoch
 Streuwert 1.66, horizontal: 2.04, vertikal: 1.15

Unterschrift des Schützen

Ergebnis: **162.7** (152)
 Serien: 87.4 75.3
 Zähler: 0 3 8 7 2 0 0 0 0 0
 Innenzehner: 0
 weiteste: 1153 (19), 1020 (17), 980 (12)
 beste Teiler 298.2 (9.) 352.9 (10.) 444.3 (4.)
 Trefferlage 0.78 mm links, 6.06 mm hoch
 Streuwert 2.96, horizontal: 3.27, vertikal: 2.61

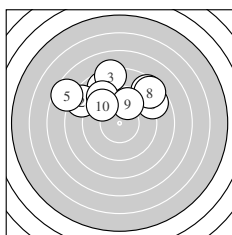
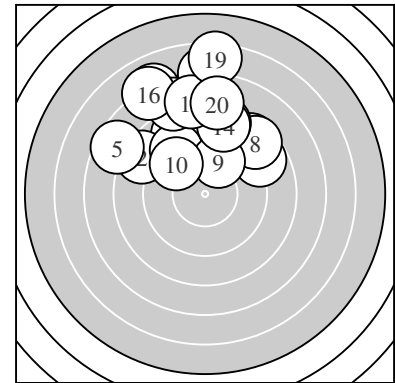

Serie 1:
 8.7 ↖ 8.5 ↖ 8.2 ↑ 9.2 ↖ 7.6 ↖
 8.8 ↗ 8.6 ↗ 8.5 ↗ 9.8 ↑ 9.5 ↖
 beste Teiler 298.2 (9.) 352.9 (10.) 444.3 (4.)
 Trefferlage 0.74 mm links, 3.96 mm hoch
 Streuwert 3.05, horizontal: 4.12, vertikal: 1.27

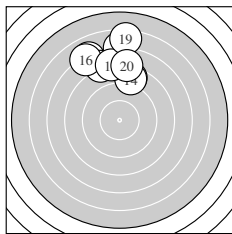

Serie 2:
 8.5 ↑ 7.0 ↖ 7.8 ↑ 8.5 ↑ 7.7 ↖
 7.0 ↖ 6.9 ↑ 7.8 ↑ 6.3 ↑ 7.8 ↑
 beste Teiler 602.5 (14.) 621.7 (11.) 776.7 (20.)
 Trefferlage 0.83 mm links, 8.17 mm hoch
 Streuwert 2.07, horizontal: 2.37, vertikal: 1.72

Unterschrift des Schützen

Ergebnis: **202.5** (193)
 Serien: 99.6 102.9
 Zähler: 16 2 1 1 0 0 0 0 0 0
 Innenzehner: 16
 weiteste: 875 (3), 622 (4), 365 (19)
 beste Teiler 47.5 (13.) 52.4 (6.) 87.0 (7.)
 Trefferlage 1.39 mm links, 0.76 mm hoch
 Streuwert 1.75, horizontal: 2.39, vertikal: 0.67

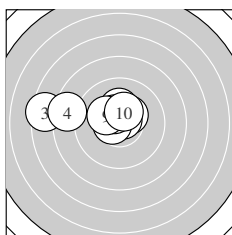
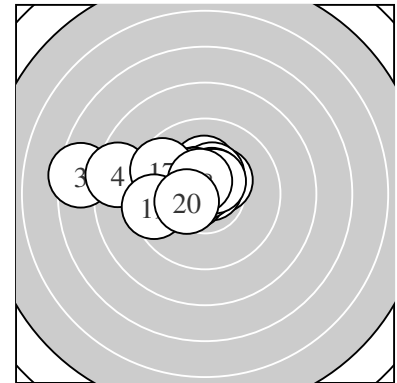

Serie 1:
 10.6 * 10.4 * 7.5 ← 8.5 ← 10.2 *
 10.7 * 10.6 * 10.5 * 10.2 * 10.4 *
 beste Teiler 52.4 (6.) 87.0 (7.) 94.6 (1.)
 Trefferlage 1.66 mm links, 0.94 mm hoch
 Streuwert 2.27, horizontal: 3.16, vertikal: 0.57

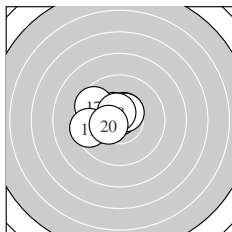

Serie 2:
 10.2 * 10.3 * 10.8 * 10.5 * 10.5 *
 10.5 * 9.6 ↘ 10.6 * 9.5 ← 10.4 *
 beste Teiler 47.5 (13.) 96.0 (18.) 106.5 (16.)
 Trefferlage 1.11 mm links, 0.59 mm hoch
 Streuwert 1.11, horizontal: 1.38, vertikal: 0.75

Unterschrift des Schützen

Ergebnis: **198.0** (190)
 Serien: 98.9 99.1
 Zähler: 12 7 0 1 0 0 0 0 0 0
 Innenzehner: 9
 weiteste: 830 (5), 464 (19), 375 (1)
 beste Teiler 90.2 (2.) 108.5 (13.) 123.1 (9.)
 Trefferlage 1.29 mm links, 0.84 mm hoch
 Streuwert 1.95, horizontal: 2.24, vertikal: 1.60

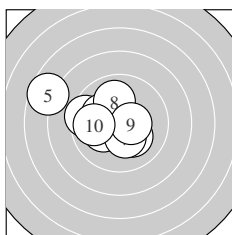
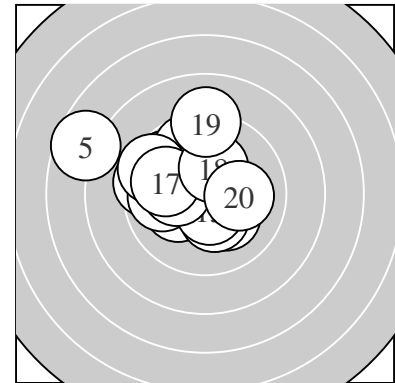

Serie 1:
 9.5 ← 10.6 * 10.2 * 10.1 ↖ 7.6 ↖
 10.2 * 10.3 * 10.0 ↑ 10.5 * 9.9 ←
 beste Teiler 90.2 (2.) 123.1 (9.) 161.9 (7.)
 Trefferlage 1.58 mm links, 0.37 mm hoch
 Streuwert 2.20, horizontal: 2.72, vertikal: 1.51

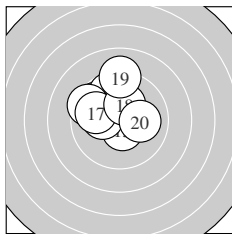

Serie 2:
 10.2 * 9.7 ↖ 10.5 * 10.2 * 9.7 ↑
 9.5 ↖ 9.9 ← 10.2 * 9.1 ↑ 10.1 →
 beste Teiler 108.5 (13.) 176.7 (18.) 183.8 (14.)
 Trefferlage 1.00 mm links, 1.31 mm hoch
 Streuwert 1.68, horizontal: 1.74, vertikal: 1.62

Unterschrift des Schützen

Ergebnis: **190.3** (181)
 Serien: 95.1 95.2
 Zähler: 6 9 5 0 0 0 0 0 0 0
 Innenzehner: 3
 weiteste: 712 (2), 609 (14), 564 (13)
 beste Teiler 76.8 (17.) 118.0 (4.) 190.9 (10.)
 Trefferlage 1.16 mm links, 0.22 mm hoch
 Streuwert 2.74, horizontal: 3.38, vertikal: 1.90

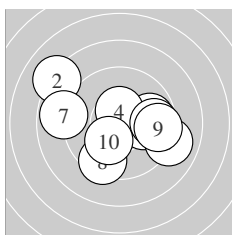
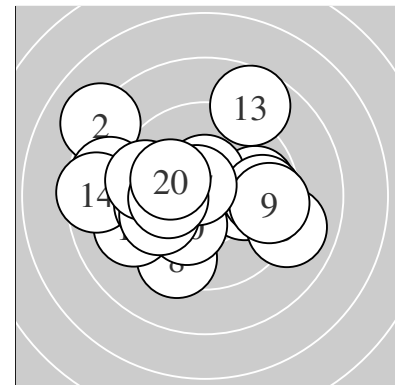

Serie 1:
 10.1 → 8.1 ↖ 9.8 → 10.5 * 9.0 →
 9.7 → 8.8 ← 9.4 ↙ 9.5 → 10.2 *
 beste Teiler 118.0 (4.) 190.9 (10.) 224.1 (1.)
 Trefferlage 0.27 mm rechts, 0.08 mm tief
 Streuwert 2.96, horizontal: 3.67, vertikal: 2.02

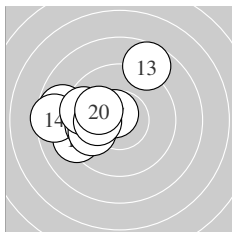

Serie 2:
 8.8 ← 9.2 ← 8.7 ↗ 8.5 ← 9.8 ←
 9.8 ← 10.6 * 9.6 ← 10.1 ← 10.1 ↖
 beste Teiler 76.8 (17.) 206.3 (19.) 214.7 (20.)
 Trefferlage 2.61 mm links, 0.53 mm hoch
 Streuwert 2.16, horizontal: 2.44, vertikal: 1.83

Unterschrift des Schützen

Ergebnis: **204.5** (195)
 Serien: 100.7 103.8
 Zähler: 15 5 0 0 0 0 0 0 0 0
 Innenzehner: 13
 weiteste: 407 (6), 390 (10), 389 (8)
 beste Teiler 24.7 (16.) 46.0 (7.) 63.8 (2.)
 Trefferlage 0.55 mm links, 0.21 mm hoch
 Streuwert 1.52, horizontal: 1.87, vertikal: 1.06

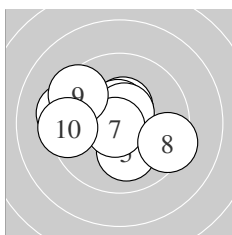
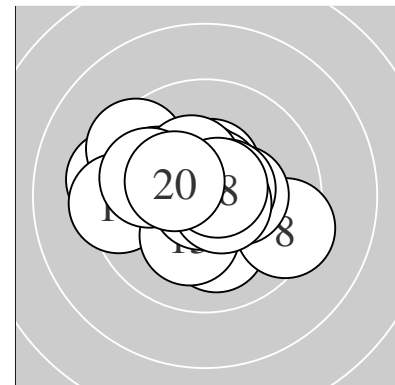

Serie 1:
 10.5 * 10.7 * 10.5 * 10.6 * 10.1 ↓
 9.3 ← 10.8 * 9.4 → 9.4 ↖ 9.4 ←
 beste Teiler 46.0 (7.) 63.8 (2.) 84.5 (4.)
 Trefferlage 0.72 mm links, 0.21 mm hoch
 Streuwert 1.89, horizontal: 2.34, vertikal: 1.27

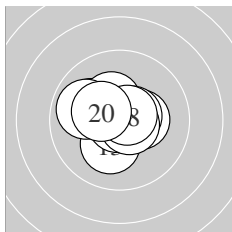

Serie 2:
 10.3 * 10.0 ↖ 10.2 * 10.3 * 10.6 *
 10.9 * 10.6 * 10.7 * 9.9 ↖ 10.3 *
 beste Teiler 24.7 (16.) 67.9 (18.) 81.4 (17.)
 Trefferlage 0.37 mm links, 0.21 mm hoch
 Streuwert 1.13, horizontal: 1.35, vertikal: 0.87

Unterschrift des Schützen

Ergebnis: **201.6** (193)
 Serien: 100.5 101.1
 Zähler: 15 3 2 0 0 0 0 0 0 0
 Innenzehner: 12
 weiteste: 591 (5), 538 (12), 286 (15)
 beste Teiler 69.0 (20.) 82.7 (7.) 99.2 (10.)
 Trefferlage 0.43 mm links, 0.68 mm hoch
 Streuwert 1.76, horizontal: 2.06, vertikal: 1.40

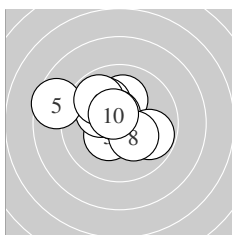
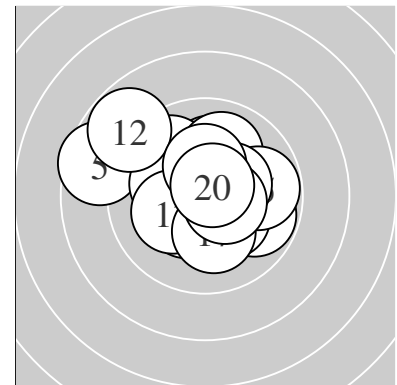

Serie 1:
 10.1 ↑ 9.8 → 10.4 * 10.2 * 8.6 ↖
 10.1 ↘ 10.6 * 10.3 * 9.8 ↘ 10.6 *
 beste Teiler 82.7 (7.) 99.2 (10.) 146.6 (3.)
 Trefferlage 0.81 mm links, 0.70 mm hoch
 Streuwert 1.81, horizontal: 2.19, vertikal: 1.32

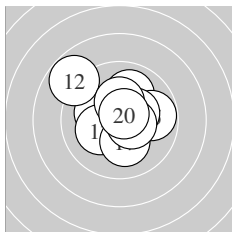

Serie 2:
 10.2 * 8.8 ↘ 10.2 * 10.0 ↗ 9.8 →
 10.4 * 10.2 * 10.5 * 10.3 * 10.7 *
 beste Teiler 69.0 (20.) 111.9 (18.) 148.0 (16.)
 Trefferlage 0.06 mm links, 0.66 mm hoch
 Streuwert 1.77, horizontal: 1.97, vertikal: 1.55

Unterschrift des Schützen

Ergebnis: **199.1** (191)
 Serien: 98.8 100.3
 Zähler: 11 9 0 0 0 0 0 0 0 0
 Innenzehner: 7
 weiteste: 432 (18), 427 (8), 421 (1)
 beste Teiler 83.4 (16.) 98.0 (5.) 100.6 (15.)
 Trefferlage 0.73 mm links, 0.05 mm tief
 Streuwert 1.92, horizontal: 2.38, vertikal: 1.33

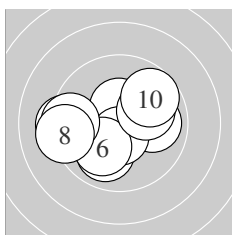
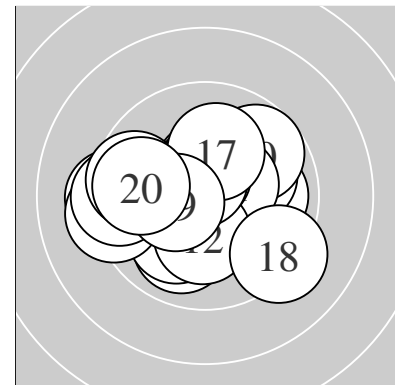

Serie 1:
 9.3 ← 10.0 ↙ 9.9 → 10.5 * 10.6 *
 10.1 ↘ 9.4 ← 9.2 ← 10.1 ↗ 9.7 ↗
 beste Teiler 98.0 (5.) 121.1 (4.) 222.3 (9.)
 Trefferlage 0.78 mm links, 0.17 mm tief
 Streuwert 2.08, horizontal: 2.63, vertikal: 1.32

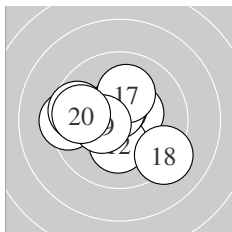

Serie 2:
 10.4 * 10.2 * 9.4 ← 9.6 ← 10.6 *
 10.6 * 10.1 ↑ 9.2 ↘ 10.4 * 9.8 ←
 beste Teiler 83.4 (16.) 100.6 (15.) 126.6 (11.)
 Trefferlage 0.69 mm links, 0.07 mm hoch
 Streuwert 1.86, horizontal: 2.24, vertikal: 1.39

Unterschrift des Schützen

Ergebnis: **196.3** (185)
 Serien: 101.4 94.9
 Zähler: 8 9 3 0 0 0 0 0 0 0
 Innenzehner: 5
 weiteste: 617 (17), 586 (14), 521 (12)
 beste Teiler 52.3 (8.) 52.6 (10.) 57.0 (18.)
 Trefferlage 1.66 mm links, 0.11 mm tief
 Streuwert 2.00, horizontal: 2.39, vertikal: 1.52

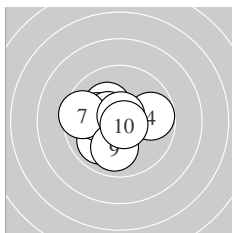
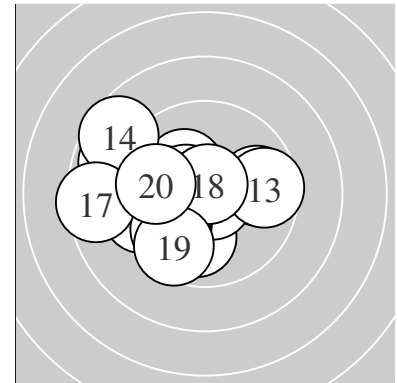

Serie 1:
 10.0 ← 9.9 ↙ 10.2 * 9.8 → 10.1 ←
 10.5 * 9.5 ← 10.7 * 10.0 ↓ 10.7 *
 beste Teiler 52.3 (8.) 52.6 (10.) 119.4 (6.)
 Trefferlage 0.89 mm links, 0.06 mm tief
 Streuwert 1.51, horizontal: 1.78, vertikal: 1.18

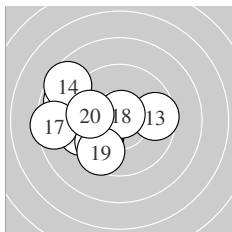

Serie 2:
 9.9 ↙ 8.9 ↖ 9.6 → 8.6 ↘ 9.5 ←
 9.8 ↙ 8.5 ← 10.7 * 9.6 ↘ 9.8 ←
 beste Teiler 57.0 (18.) 252.7 (11.) 280.0 (16.)
 Trefferlage 2.43 mm links, 0.16 mm tief
 Streuwert 2.35, horizontal: 2.75, vertikal: 1.86

Unterschrift des Schützen

Ergebnis: **200.0** (188)
 Serien: 99.1 100.9
 Zähler: 9 10 1 0 0 0 0 0 0 0
 Innenzehner: 9
 weiteste: 530 (7), 375 (16), 375 (18)
 beste Teiler 56.0 (14.) 63.0 (19.) 109.3 (20.)
 Trefferlage 0.19 mm links, 0.90 mm hoch
 Streuwert 1.84, horizontal: 2.20, vertikal: 1.38

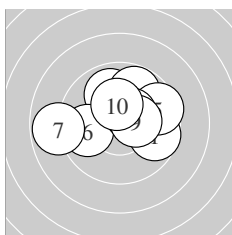
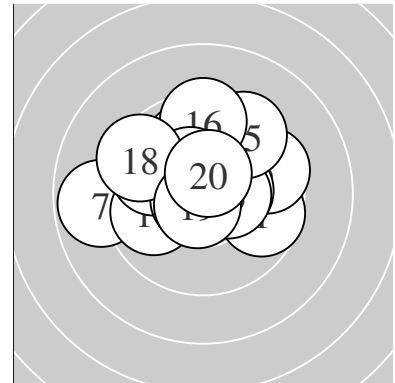

Serie 1:
 9.7 → 9.9 ↖ 10.3 * 9.8 ↗ 9.6 →
 9.8 ← 8.8 ← 10.5 * 10.4 * 10.3 *
 beste Teiler 124.1 (8.) 141.1 (9.) 163.6 (10.)
 Trefferlage 0.21 mm rechts, 0.78 mm hoch
 Streuwert 2.06, horizontal: 2.62, vertikal: 1.26

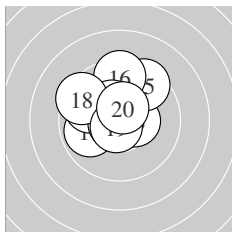

Serie 2:
 9.9 ← 9.8 ↖ 10.4 * 10.7 * 9.5 ↗
 9.5 ↑ 10.4 * 9.5 ↖ 10.7 * 10.5 *
 beste Teiler 56.0 (14.) 63.0 (19.) 109.3 (20.)
 Trefferlage 0.61 mm links, 1.02 mm hoch
 Streuwert 1.63, horizontal: 1.72, vertikal: 1.54

Unterschrift des Schützen

Ergebnis: **158.3** (147)
 Serien: 77.1 81.2
 Zähler: 3 1 7 2 3 4 0 0 0 0
 Innenzehner: 1
 weiteste: 1362 (16), 1295 (19), 1271 (7)
 beste Teiler 159.7 (2.) 205.3 (15.) 236.4 (20.)
 Trefferlage 0.08 mm links, 3.09 mm hoch
 Streuwert 5.75, horizontal: 7.60, vertikal: 2.92

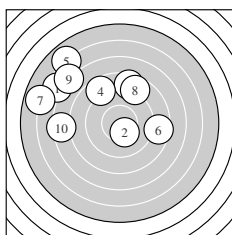
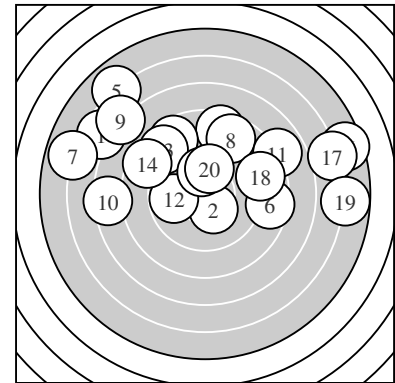

Serie 1:
 6.5 ↘ 10.3 * 8.5 ↑ 8.6 ↖ 5.9 ↖
 8.5 → 5.9 ← 8.7 ↑ 6.8 ↖ 7.4 ←
 beste Teiler 159.7 (2.) 562.8 (8.) 577.2 (4.)
 Trefferlage 3.91 mm links, 3.84 mm hoch
 Streuwert 5.12, horizontal: 6.23, vertikal: 3.69

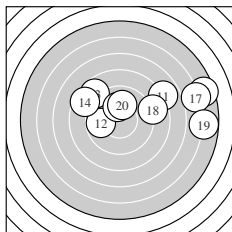

Serie 2:
 7.9 ↗ 9.8 ← 8.7 ↖ 8.5 ↖ 10.1 ↑
 5.5 → 6.1 → 8.8 → 5.8 → 10.0 ↑
 beste Teiler 205.3 (15.) 236.4 (20.) 291.1 (12.)
 Trefferlage 3.74 mm rechts, 2.34 mm hoch
 Streuwert 5.18, horizontal: 7.11, vertikal: 1.77

Unterschrift des Schützen

Ergebnis: **186.8** (175)
 Serien: 93.9 92.9
 Zähler: 4 9 6 0 1 0 0 0 0 0
 Innenzehner: 3
 weiteste: 1181 (19), 597 (3), 579 (1)
 beste Teiler 45.2 (20.) 55.0 (7.) 146.9 (18.)
 Trefferlage 1.42 mm links, 0.05 mm hoch
 Streuwert 3.24, horizontal: 3.88, vertikal: 2.44

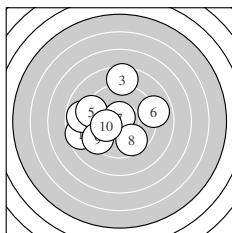
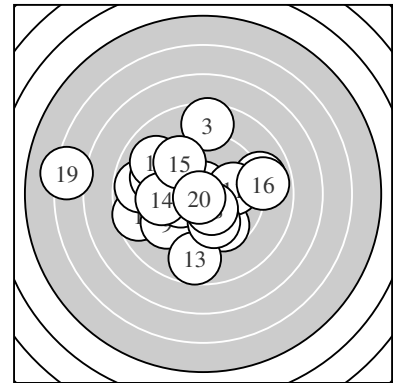

Serie 1:
 8.6 ← 8.8 ← 8.6 ↑ 9.9 ← 9.2 ↖
 8.9 → 10.7 * 9.7 ↘ 9.4 ↙ 10.1 ←

beste Teiler 55.0 (7.) 201.1 (10.) 270.0 (4.)
 Trefferlage 1.56 mm links, 0.24 mm hoch
 Streuwert 2.92, horizontal: 3.30, vertikal: 2.50

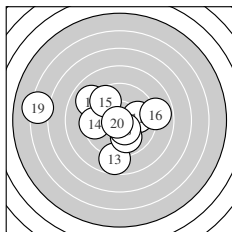

Serie 2:
 9.9 → 9.0 ↖ 8.7 ↓ 9.5 ← 9.6 ↖
 8.9 → 9.9 ↘ 10.4 * 6.2 ← 10.8 *

beste Teiler 45.2 (20.) 146.9 (18.) 256.4 (17.)
 Trefferlage 1.29 mm links, 0.13 mm tief
 Streuwert 3.68, horizontal: 4.57, vertikal: 2.51

Unterschrift des Schützen

Ergebnis: **185.8** (176)
 Serien: 90.6 95.2
 Zähler: 5 7 7 1 0 0 0 0 0 0
 Innenzehner: 3
 weiteste: 829 (5), 670 (8), 643 (13)
 beste Teiler 182.2 (20.) 188.6 (17.) 190.3 (15.)
 Trefferlage 0.83 mm links, 0.63 mm hoch
 Streuwert 3.22, horizontal: 4.27, vertikal: 1.58

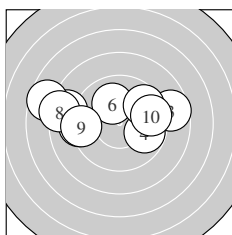
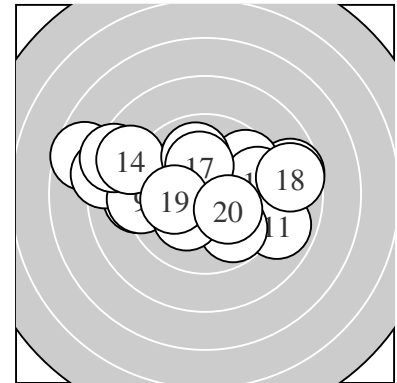

Serie 1:
 9.2 ← 8.6 ← 8.7 → 9.8 → 7.6 ←
 10.0 ↑ 9.6 ↗ 8.3 ← 9.3 ← 9.5 →
 beste Teiler 228.1 (6.) 291.0 (4.) 329.6 (7.)
 Trefferlage 1.52 mm links, 0.98 mm hoch
 Streuwert 3.53, horizontal: 4.85, vertikal: 1.17

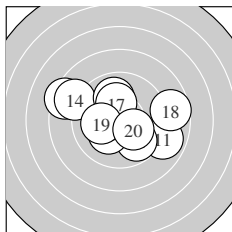

Serie 2:
 8.9 → 9.8 ↘ 8.4 ↖ 8.8 ↖ 10.2 *
 9.9 ↑ 10.2 * 8.7 → 10.1 ← 10.2 *
 beste Teiler 182.2 (20.) 188.6 (17.) 190.3 (15.)
 Trefferlage 0.14 mm links, 0.28 mm hoch
 Streuwert 2.96, horizontal: 3.73, vertikal: 1.91

Unterschrift des Schützen

Ergebnis: **161.1** (151)
 Serien: 79.2 81.9
 Zähler: 1 6 5 3 2 2 1 0 0 0
 Innenzehner: 1
 weiteste: 1586 (13), 1390 (19), 1367 (10)
 beste Teiler 102.3 (5.) 259.6 (16.) 262.0 (17.)
 Trefferlage 1.75 mm rechts, 0.15 mm tief
 Streuwert 5.89, horizontal: 7.60, vertikal: 3.42

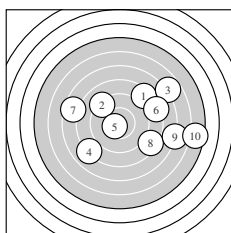
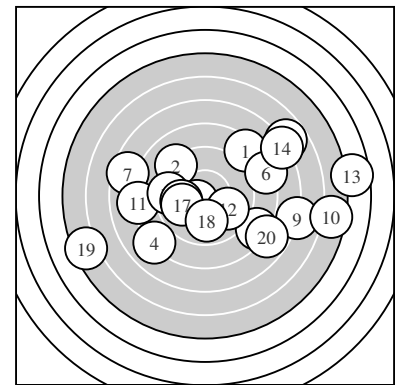

Serie 1:
 8.4 ↗ 9.1 ↘ 6.8 ↗ 8.0 ↙ 10.5 *
 8.2 → 7.5 ← 8.3 ↘ 6.9 → 5.5 →
 beste Teiler 102.3 (5.) 452.0 (2.) 649.4 (1.)
 Trefferlage 3.06 mm rechts, 0.53 mm hoch
 Streuwert 5.71, horizontal: 7.15, vertikal: 3.76

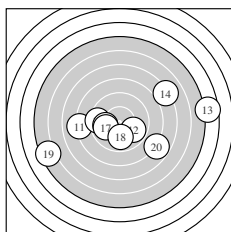

Serie 2:
 8.1 ← 9.8 ↘ 4.6 → 7.1 ↗ 9.4 ←
 9.9 ← 9.9 ← 9.9 ↓ 5.4 ← 7.8 ↘
 beste Teiler 259.6 (16.) 262.0 (17.) 264.5 (18.)
 Trefferlage 0.43 mm rechts, 0.84 mm tief
 Streuwert 6.18, horizontal: 8.18, vertikal: 3.08

Unterschrift des Schützen

Ergebnis: **197.2** (188)
 Serien: 99.0 98.2
 Zähler: 9 10 1 0 0 0 0 0 0 0
 Innenzehner: 4
 weiteste: 507 (18), 405 (14), 396 (3)
 beste Teiler 93.0 (20.) 97.5 (6.) 109.7 (10.)
 Trefferlage 0.65 mm links, 0.44 mm tief
 Streuwert 2.05, horizontal: 2.53, vertikal: 1.42

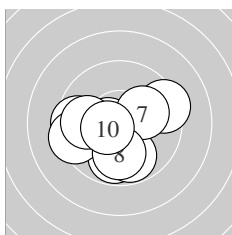
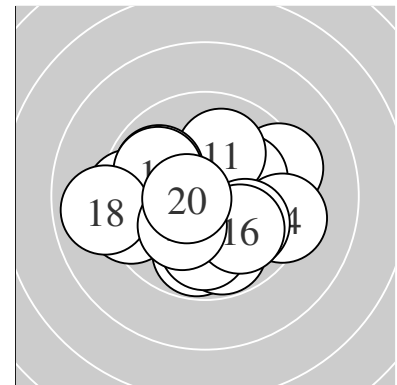

Serie 1:
 9.8 ↓ 9.5 ← 9.4 → 9.4 ← 9.8 ↓
 10.6 * 10.1 → 10.0 ↓ 9.9 ← 10.5 *
 beste Teiler 97.5 (6.) 109.7 (10.) 211.2 (7.)
 Trefferlage 0.59 mm links, 0.72 mm tief
 Streuwert 1.99, horizontal: 2.37, vertikal: 1.51

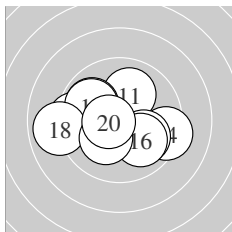

Serie 2:
 10.0 ↗ 9.9 ↖ 9.4 ← 9.3 → 10.0 ↘
 10.0 ↘ 9.9 ↖ 8.9 ← 10.2 * 10.6 *
 beste Teiler 93.0 (20.) 188.2 (19.) 229.7 (11.)
 Trefferlage 0.70 mm links, 0.17 mm tief
 Streuwert 2.20, horizontal: 2.80, vertikal: 1.35

Unterschrift des Schützen

Ergebnis: **186.8** (180)
 Serien: 94.9 91.9
 Zähler: 8 8 2 1 0 1 0 0 0 0
 Innenzehner: 8
 weiteste: 1260 (11), 916 (6), 666 (19)
 beste Teiler 63.8 (5.) 104.6 (18.) 125.2 (3.)
 Trefferlage 1.50 mm links, 0.33 mm tief
 Streuwert 3.43, horizontal: 4.35, vertikal: 2.15

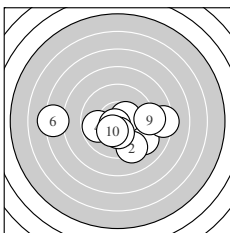
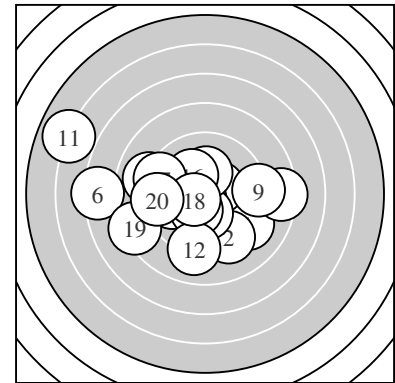

Serie 1:
 9.2 ↘ 9.3 ↘ 10.5 * 9.8 ← 10.7 *
 7.3 ← 8.4 → 10.3 * 9.1 → 10.3 *
 beste Teiler 63.8 (5.) 125.2 (3.) 155.7 (10.)
 Trefferlage 0.48 mm rechts, 0.96 mm tief
 Streuwert 3.23, horizontal: 4.37, vertikal: 1.36

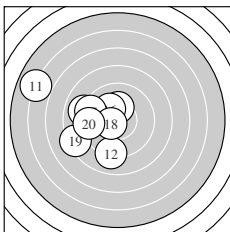

Serie 2:
 5.9 ↖ 9.0 ↓ 9.0 ↖ 10.2 * 10.2 *
 10.2 * 9.3 ↖ 10.5 * 8.3 ← 9.3 ←
 beste Teiler 104.6 (18.) 181.2 (15.) 186.2 (14.)
 Trefferlage 3.49 mm links, 0.29 mm hoch
 Streuwert 3.09, horizontal: 3.48, vertikal: 2.66

Unterschrift des Schützen

Ergebnis: **201.4** (191)
 Serien: 102.1 99.3
 Zähler: 12 7 1 0 0 0 0 0 0 0
 Innenzehner: 10
 weiteste: 711 (18), 410 (10), 382 (15)
 beste Teiler 37.0 (4.) 64.2 (6.) 71.4 (13.)
 Trefferlage 0.49 mm rechts, 0.68 mm hoch
 Streuwert 1.90, horizontal: 2.27, vertikal: 1.42

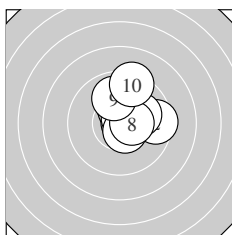
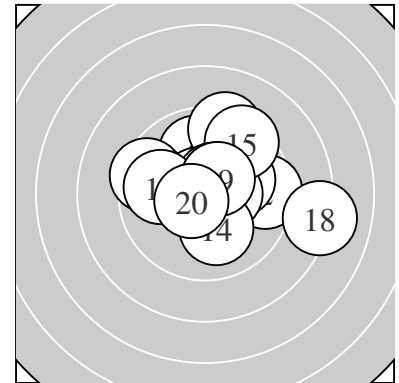

Serie 1:
 10.2 * 9.5 → 10.5 * 10.8 * 10.1 ↗
 10.7 * 10.6 * 10.5 * 9.9 ↑ 9.3 ↑
 beste Teiler 37.0 (4.) 64.2 (6.) 95.4 (7.)
 Trefferlage 0.88 mm rechts, 1.01 mm hoch
 Streuwert 1.31, horizontal: 1.23, vertikal: 1.40

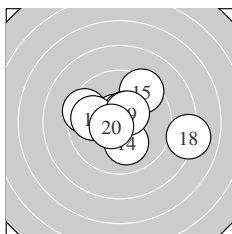

Serie 2:
 9.9 ← 9.5 ← 10.7 * 10.1 ↓ 9.4 ↖
 10.6 * 9.9 ← 8.1 → 10.5 * 10.6 *
 beste Teiler 71.4 (13.) 93.4 (20.) 99.9 (16.)
 Trefferlage 0.11 mm rechts, 0.34 mm hoch
 Streuwert 2.36, horizontal: 3.01, vertikal: 1.44

Unterschrift des Schützen

Ergebnis: **195.5** (186)
 Serien: 96.5 99.0
 Zähler: 9 8 3 0 0 0 0 0 0 0
 Innenzehner: 8
 weiteste: 575 (2), 569 (1), 551 (13)
 beste Teiler 36.8 (16.) 146.0 (14.) 151.0 (12.)
 Trefferlage 0.27 mm links, 0.46 mm hoch
 Streuwert 2.36, horizontal: 3.03, vertikal: 1.39

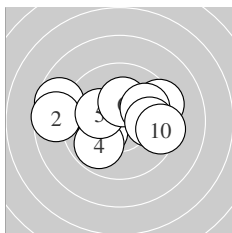
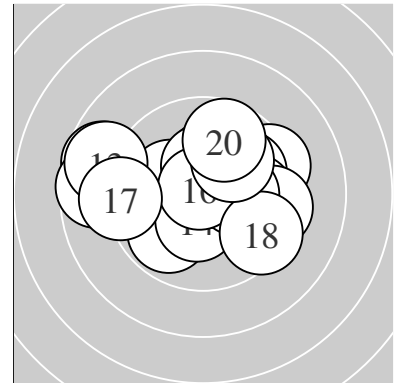

Serie 1:
 8.7 ← 8.7 ← 10.2 * 9.9 ↙ 10.2 *
 10.2 * 9.4 → 9.9 ↗ 9.9 → 9.4 →
 beste Teiler 176.4 (3.) 176.4 (6.) 189.9 (5.)
 Trefferlage 0.37 mm links, 0.34 mm hoch
 Streuwert 2.62, horizontal: 3.48, vertikal: 1.27

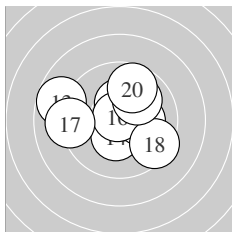

Serie 2:
 10.3 * 10.3 * 8.7 ← 10.4 * 10.2 *
 10.8 * 9.2 ← 9.4 ↘ 10.0 ↗ 9.7 ↗
 beste Teiler 36.8 (16.) 146.0 (14.) 151.0 (12.)
 Trefferlage 0.18 mm links, 0.57 mm hoch
 Streuwert 2.20, horizontal: 2.69, vertikal: 1.57

Unterschrift des Schützen

Ergebnis: **193.8** (184)
 Serien: 96.4 97.4
 Zähler: 5 14 1 0 0 0 0 0 0 0
 Innenzehner: 4
 weiteste: 603 (12), 495 (5), 460 (16)
 beste Teiler 106.9 (20.) 128.5 (11.) 152.5 (13.)
 Trefferlage 0.20 mm rechts, 0.25 mm hoch
 Streuwert 2.45, horizontal: 3.05, vertikal: 1.64

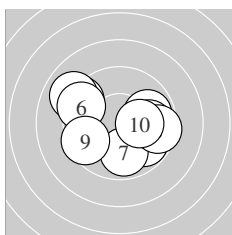
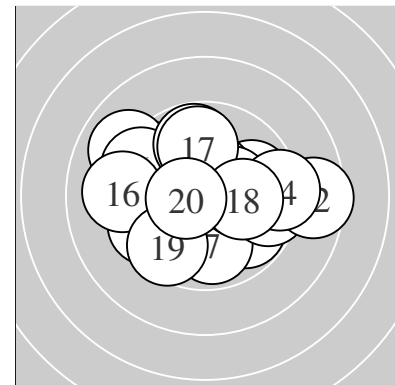

Serie 1:
 9.9 → 9.9 → 9.8 ↘ 9.3 ↖ 9.0 ↖
 9.4 ↖ 9.9 ↓ 9.5 → 9.5 ↙ 10.2 *
 beste Teiler 186.0 (10.) 268.9 (7.) 271.1 (2.)
 Trefferlage 0.13 mm links, 0.03 mm hoch
 Streuwert 2.55, horizontal: 3.15, vertikal: 1.74

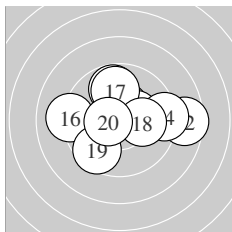

Serie 2:
 10.4 * 8.5 → 10.3 * 9.3 → 9.8 ↑
 9.1 ← 9.8 ↑ 10.1 → 9.6 ↙ 10.5 *
 beste Teiler 106.9 (20.) 128.5 (11.) 152.5 (13.)
 Trefferlage 0.53 mm rechts, 0.47 mm hoch
 Streuwert 2.45, horizontal: 3.07, vertikal: 1.60

Unterschrift des Schützen

Ergebnis: **182.8** (174)
 Serien: 92.7 90.1
 Zähler: 7 4 7 1 0 1 0 0 0 0
 Innenzehner: 5
 weiteste: 1287 (19), 825 (11), 669 (3)
 beste Teiler 8.5 (9.) 65.0 (16.) 96.0 (6.)
 Trefferlage 0.71 mm links, 1.35 mm hoch
 Streuwert 3.82, horizontal: 5.06, vertikal: 1.89

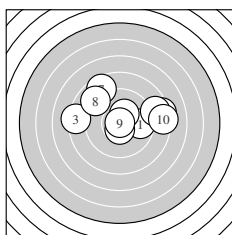
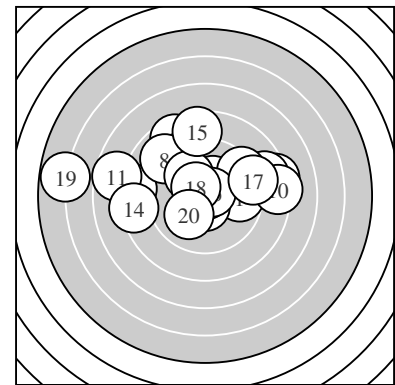

Serie 1:
 9.7 → 8.3 → 8.3 ← 10.3 * 8.7 →
 10.6 * 8.6 ↖ 9.0 ↖ 10.9 * 8.3 →
 beste Teiler 8.5 (9.) 96.0 (6.) 157.8 (4.)
 Trefferlage 0.92 mm rechts, 1.37 mm hoch
 Streuwert 3.42, horizontal: 4.49, vertikal: 1.81

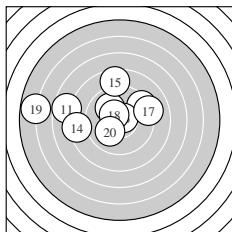

Serie 2:
 7.7 ← 10.0 ↖ 9.3 ↗ 8.3 ← 8.6 ↑
 10.7 * 9.1 → 10.5 * 5.8 ← 10.1 ↙
 beste Teiler 65.0 (16.) 117.3 (18.) 224.7 (20.)
 Trefferlage 2.35 mm links, 1.33 mm hoch
 Streuwert 4.01, horizontal: 5.28, vertikal: 2.07

Unterschrift des Schützen

Ergebnis: **196.0** (187)
 Serien: 100.4 95.6
 Zähler: 9 9 2 0 0 0 0 0 0 0
 Innenzehner: 6
 weiteste: 658 (17), 587 (20), 430 (15)
 beste Teiler 58.2 (13.) 77.4 (7.) 111.0 (10.)
 Trefferlage 0.72 mm links, 0.45 mm tief
 Streuwert 2.27, horizontal: 2.20, vertikal: 2.35

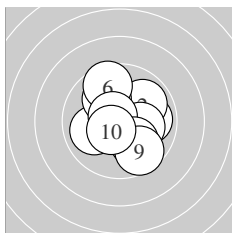
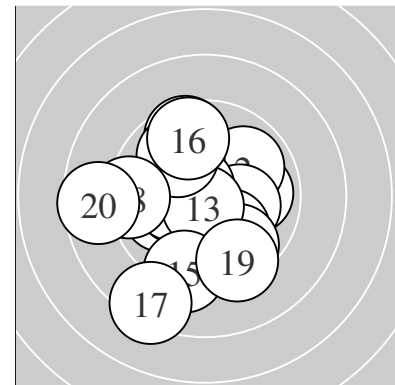

Serie 1:
 9.9 → 9.9 ↗ 10.0 ← 10.2 * 10.0 ↖
 9.6 ↑ 10.6 * 10.0 ↘ 9.7 ↓ 10.5 *
 beste Teiler 77.4 (7.) 111.0 (10.) 196.9 (4.)
 Trefferlage 0.37 mm rechts, 0.07 mm hoch
 Streuwert 1.78, horizontal: 1.74, vertikal: 1.81

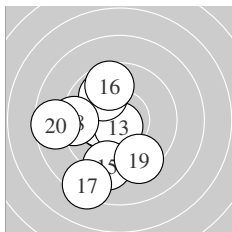

Serie 2:
 10.3 * 10.3 * 10.7 * 9.9 ↖ 9.2 ↓
 9.6 ↑ 8.3 ↙ 9.3 ← 9.4 ↓ 8.6 ←
 beste Teiler 58.2 (13.) 155.9 (11.) 172.4 (12.)
 Trefferlage 1.81 mm links, 0.98 mm tief
 Streuwert 2.47, horizontal: 2.12, vertikal: 2.79

Unterschrift des Schützen

Ergebnis: **188.5** (181)
 Serien: 96.3 92.2
 Zähler: 7 10 1 1 1 0 0 0 0 0
 Innenzehner: 7
 weiteste: 1138 (11), 989 (18), 615 (4)
 beste Teiler 107.0 (6.) 128.0 (1.) 151.6 (14.)
 Trefferlage 0.57 mm rechts, 0.33 mm hoch
 Streuwert 3.32, horizontal: 4.18, vertikal: 2.13

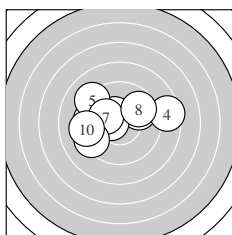
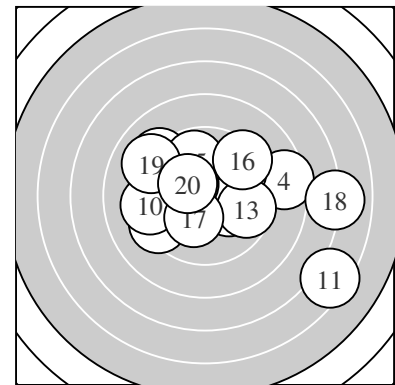

Serie 1:
 10.4 * 9.5 ← 9.8 ↗ 8.5 → 9.1 ↘
 10.5 * 10.2 * 9.7 ↗ 9.3 ↙ 9.3 ←
 beste Teiler 107.0 (6.) 128.0 (1.) 192.3 (7.)
 Trefferlage 0.73 mm links, 0.69 mm hoch
 Streuwert 2.58, horizontal: 3.38, vertikal: 1.39

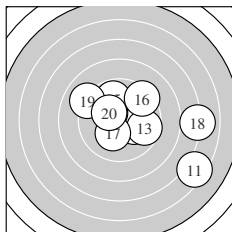

Serie 2:
 6.4 ↘ 10.2 * 9.6 ↘ 10.3 * 9.8 ↗
 9.4 ↗ 10.2 * 7.0 → 9.0 ↘ 10.3 *
 beste Teiler 151.6 (14.) 162.8 (20.) 186.0 (17.)
 Trefferlage 1.88 mm rechts, 0.02 mm tief
 Streuwert 3.81, horizontal: 4.66, vertikal: 2.71

Unterschrift des Schützen

Ergebnis: **186.4** (177)
 Serien: 99.3 87.1
 Zähler: 7 7 4 0 2 0 0 0 0 0
 Innenzehner: 6
 weiteste: 1144 (16), 1115 (19), 613 (9)
 beste Teiler 72.2 (5.) 124.8 (1.) 126.8 (6.)
 Trefferlage 0.62 mm links, 0.33 mm hoch
 Streuwert 3.59, horizontal: 4.50, vertikal: 2.37

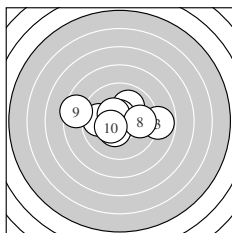
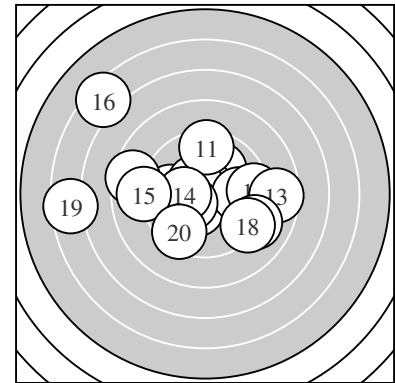

Serie 1:
 10.5 * 10.0 ↗ 8.8 → 9.8 ← 10.7 *
 10.4 * 10.4 * 9.8 → 8.5 ← 10.4 *
 beste Teiler 72.2 (5.) 124.8 (1.) 126.8 (6.)
 Trefferlage 0.16 mm links, 0.39 mm hoch
 Streuwert 2.27, horizontal: 3.05, vertikal: 1.00

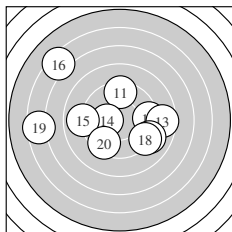

Serie 2:
 9.4 ↑ 9.3 → 8.6 → 10.3 * 8.9 ←
 6.4 ↘ 9.1 ↘ 9.2 ↘ 6.5 ← 9.4 ↙
 beste Teiler 173.0 (14.) 377.7 (20.) 385.1 (11.)
 Trefferlage 1.07 mm links, 0.26 mm hoch
 Streuwert 4.68, horizontal: 5.73, vertikal: 3.29

Unterschrift des Schützen

Ergebnis: **402.3** (385)
 Serien: 101.5 101.0 99.4 100.4
 Zähler: 26 13 1 0 0 0 0 0 0 0
 Innenzehner: 23
 weiteste: 502 (26), 437 (39), 406 (22)
 beste Teiler 42.1 (24.) 56.0 (25.) 98.3 (10.)
 Trefferlage 0.30 mm rechts, 0.51 mm hoch
 Streuwert 1.74, horizontal: 1.70, vertikal: 1.78

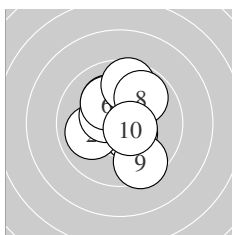

Serie 1:
 10.5 * 10.0 ← 10.4 * 10.2 * 10.6 *
 10.2 * 9.7 ↑ 9.8 ↗ 9.5 ↓ 10.6 *
 beste Teiler 98.3 (10.) 98.7 (5.) 124.4 (1.)
 Trefferlage 0.14 mm rechts, 0.46 mm hoch
 Streuwert 1.63, horizontal: 1.38, vertikal: 1.85

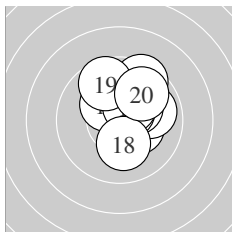

Serie 2:
 10.3 * 9.9 → 10.3 * 9.5 ↗ 10.6 *
 10.3 * 10.4 * 10.2 * 9.7 ↖ 9.8 ↗
 beste Teiler 99.7 (15.) 142.0 (17.) 159.3 (11.)
 Trefferlage 0.85 mm rechts, 1.08 mm hoch
 Streuwert 1.40, horizontal: 1.22, vertikal: 1.56

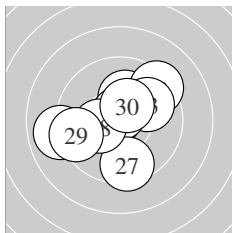

Serie 3:
 10.2 * 9.3 ↗ 9.9 ↗ 10.8 * 10.7 *
 8.9 ← 9.5 ↓ 10.3 * 9.4 ← 10.4 *
 beste Teiler 42.1 (24.) 56.0 (25.) 135.9 (30.)
 Trefferlage 0.35 mm links, 0.14 mm hoch
 Streuwert 2.17, horizontal: 2.46, vertikal: 1.83

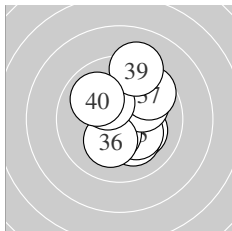

Serie 4:
 10.2 * 10.2 * 10.2 * 10.4 * 10.1 ↗
 10.2 * 9.6 ↗ 10.3 * 9.2 ↑ 10.0 ↘
 beste Teiler 132.5 (34.) 166.0 (38.) 179.1 (33.)
 Trefferlage 0.59 mm rechts, 0.37 mm hoch
 Streuwert 1.75, horizontal: 1.46, vertikal: 2.00

Unterschrift des Schützen

Meyton Elektronik

Ergebnis: **200.1** (191)
 Serien: 101.3 98.8
 Zähler: 12 7 1 0 0 0 0 0 0 0
 Innenzehner: 10
 weiteste: 564 (11), 468 (19), 430 (10)
 beste Teiler 66.2 (13.) 75.0 (4.) 86.4 (1.)
 Trefferlage 0.54 mm links, 0.99 mm tief
 Streuwert 1.78, horizontal: 1.51, vertikal: 2.01

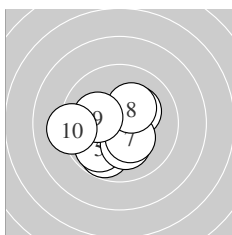
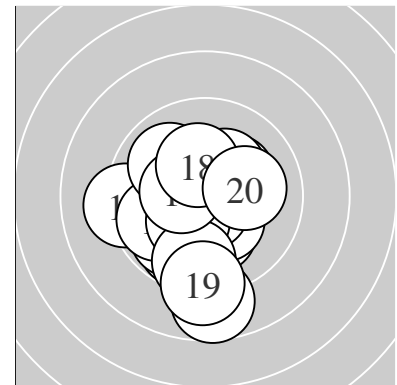

Serie 1:
 10.6 * 9.8 ↘ 10.2 * 10.7 * 9.9 ↘
 10.2 * 10.3 * 10.3 * 10.1 ← 9.2 ←
 beste Teiler 75.0 (4.) 86.4 (1.) 159.4 (7.)
 Trefferlage 0.58 mm links, 0.68 mm tief
 Streuwert 1.58, horizontal: 1.78, vertikal: 1.35

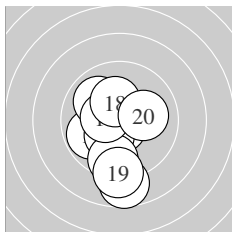

Serie 2:
 8.7 ↓ 9.8 ↙ 10.7 * 10.3 * 9.9 ↖
 9.5 ↓ 10.4 * 10.3 * 9.1 ↓ 10.1 →
 beste Teiler 66.2 (13.) 129.4 (17.) 162.5 (14.)
 Trefferlage 0.50 mm links, 1.30 mm tief
 Streuwert 2.02, horizontal: 1.29, vertikal: 2.54

Unterschrift des Schützen

Ergebnis: **188.5** (180)
 Serien: 92.2 96.3
 Zähler: 7 7 5 1 0 0 0 0 0 0
 Innenzehner: 7
 weiteste: 850 (6), 680 (2), 635 (9)
 beste Teiler 112.3 (17.) 147.3 (10.) 155.4 (15.)
 Trefferlage 1.42 mm links, 0.88 mm tief
 Streuwert 2.91, horizontal: 3.37, vertikal: 2.38

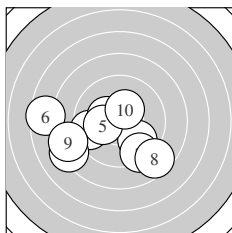
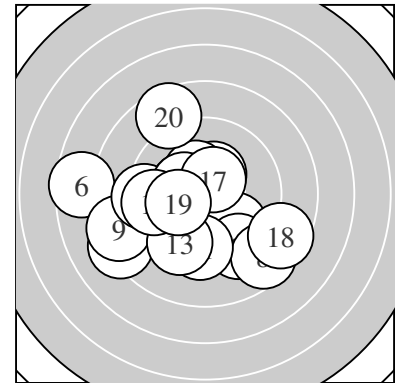

Serie 1:
 9.5 ← 8.2 ↙ 10.3 * 9.8 ↘ 10.2 *
 7.6 ← 9.2 ↘ 8.6 ↘ 8.4 ← 10.4 *
 beste Teiler 147.3 (10.) 158.5 (3.) 193.6 (5.)
 Trefferlage 1.80 mm links, 1.47 mm tief
 Streuwert 3.22, horizontal: 4.10, vertikal: 1.99

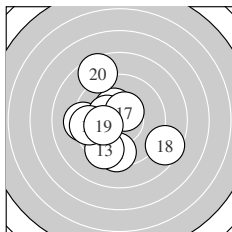

Serie 2:
 9.5 ↓ 9.3 ← 9.5 ↘ 10.3 * 10.3 *
 9.5 ← 10.5 * 8.6 ↘ 10.2 * 8.6 ↖
 beste Teiler 112.3 (17.) 155.4 (15.) 155.7 (14.)
 Trefferlage 1.04 mm links, 0.28 mm tief
 Streuwert 2.65, horizontal: 2.61, vertikal: 2.68

Unterschrift des Schützen

Ergebnis: **194.0** (183)
 Serien: 100.0 94.0
 Zähler: 8 9 2 0 1 0 0 0 0 0
 Innenzehner: 6
 weiteste: 1160 (13), 692 (14), 507 (11)
 beste Teiler 39.9 (8.) 68.1 (12.) 86.0 (1.)
 Trefferlage 0.12 mm rechts, 0.67 mm tief
 Streuwert 2.88, horizontal: 3.89, vertikal: 1.18

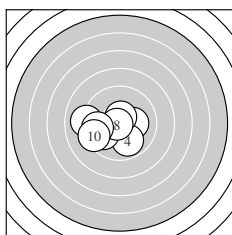
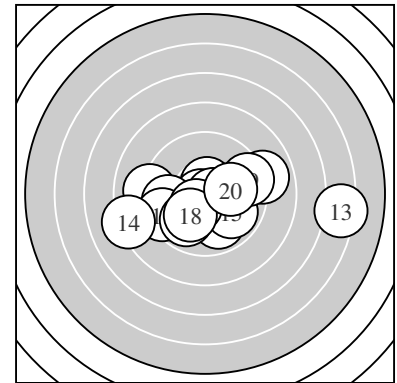

Serie 1:
 10.6 * 10.2 * 9.9 ← 9.9 ↘ 9.1 ←
 9.9 ↙ 10.6 * 10.8 * 9.7 ← 9.3 ←
 beste Teiler 39.9 (8.) 86.0 (1.) 89.4 (7.)
 Trefferlage 1.25 mm links, 0.61 mm tief
 Streuwert 1.76, horizontal: 2.26, vertikal: 1.02

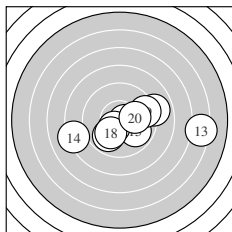

Serie 2:
 8.9 → 10.7 * 6.3 → 8.2 ← 9.9 ↘
 9.9 ↙ 10.5 * 10.1 ↙ 9.4 → 10.1 →
 beste Teiler 68.1 (12.) 124.8 (17.) 218.3 (18.)
 Trefferlage 1.49 mm rechts, 0.73 mm tief
 Streuwert 3.51, horizontal: 4.76, vertikal: 1.38

Unterschrift des Schützen