

Ergebnis:	<b>550</b>	(576.7)				
Serien:	91	90	94	92	94	89
Zähler:	22	27	10	1	0	0
Innenzehner:	6					
weiteste:	2405 (46), 2278 (1), 2017 (23)					
beste Teiler	105.6 (59.) 214.1 (19.) 312.5 (16.)					
Trefferlage	1.52 mm rechts, 1.91 mm tief					
Streuwert	8.36, horizontal: 9.02, vertikal: 7.64					

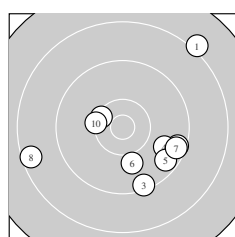

Serie 1:	8.1 ↗	9.5 →	9.4 ↓	9.8 →	9.6 ↘
	10.0 ↓	9.5 →	8.5 ←	10.3 ↖	10.3 ←
beste Teiler	486.6 (9.) 559.1 (10.) 766.2 (6.)				
Trefferlage	3.27 mm rechts, 2.46 mm tief				
Streuwert	9.19, horizontal: 10.35, vertikal: 7.87				

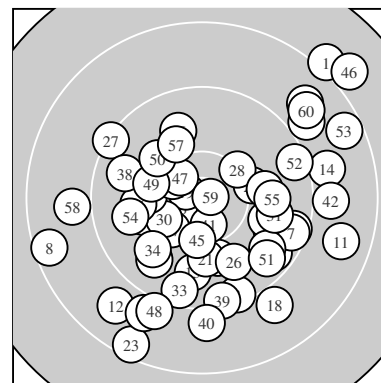
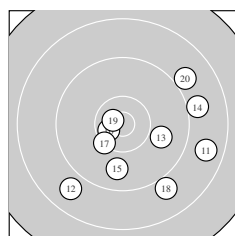

Serie 2:	8.7 →	8.8 ↙	9.9 →	9.0 →	9.8 ↓
	10.6 *	10.3 ↙	8.9 ↓	10.7 *	9.0 ↗
beste Teiler	214.1 (19.) 312.5 (16.) 539.6 (17.)				
Trefferlage	4.21 mm rechts, 3.51 mm tief				
Streuwert	8.44, horizontal: 9.50, vertikal: 7.23				

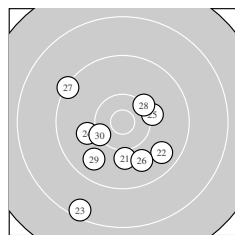

Serie 3:	10.0 ↓	9.7 →	8.4 ↙	10.0 ←	10.2 →
	9.8 ↓	9.3 ↖	10.2 ↗	9.7 ↙	10.3 ←
beste Teiler	538.4 (30.) 561.9 (28.) 634.7 (25.)				
Trefferlage	1.49 mm links, 4.02 mm tief				
Streuwert	7.04, horizontal: 6.92, vertikal: 7.17				

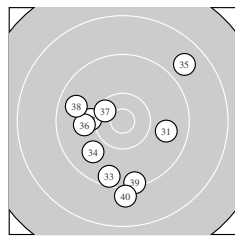

Serie 4:	9.8 →	10.1 ←	9.5 ↓	9.8 ↙	8.8 ↗
	10.0 ←	10.4 *	9.7 ↖	9.3 ↓	9.0 ↓
beste Teiler	419.3 (37.) 658.8 (32.) 793.9 (36.)				
Trefferlage	1.17 mm links, 3.16 mm tief				
Streuwert	7.89, horizontal: 7.39, vertikal: 8.35				

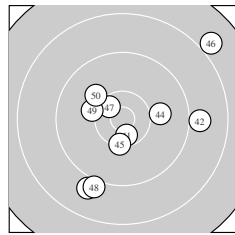

Serie 5:	10.5 *	9.0 →	9.0 ↙	10.0 →	10.3 ↓
	7.9 ↗	10.5 *	9.1 ↓	10.1 ↖	10.0 ↖
beste Teiler	341.7 (41.) 372.8 (47.) 523.4 (45.)				
Trefferlage	1.45 mm rechts, 1.11 mm tief				
Streuwert	9.12, horizontal: 9.39, vertikal: 8.85				

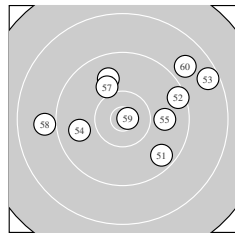

Serie 6:	9.6 ↘	9.4 →	8.5 ↗	9.8 ←	9.9 →
	9.9 ↖	10.0 ↘	8.9 ←	10.8 *	8.8 ↗
beste Teiler	105.6 (59.) 737.0 (57.) 871.0 (55.)				
Trefferlage	2.86 mm rechts, 2.76 mm hoch				
Streuwert	8.60, horizontal: 10.67, vertikal: 5.83				

**LP 60** – Wertung – **Männer**

StandNr: 101

**Engensteiner,, Rene** #70118028

**StartNr: 49**

4. Februar 2018 11:13

70118 / 0

---

\_\_\_\_\_  
Unterschrift des Schützen

Meyton Elektronik

Ergebnis: **546** (571.2)  
 Serien: 94 89 89 90 89 95  
 Zähler: 22 25 11 1 1 0 0 0 0 0  
 Innenzehner: 5  
 weiteste: 3250 (22), 2637 (13), 2112 (42)  
 beste Teiler 94.0 (55.) 310.4 (53.) 335.0 (43.)  
 Trefferlage 4.86 mm links, 1.54 mm tief  
 Streuwert 8.52, horizontal: 9.60, vertikal: 7.27

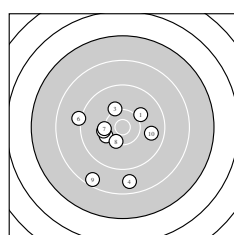
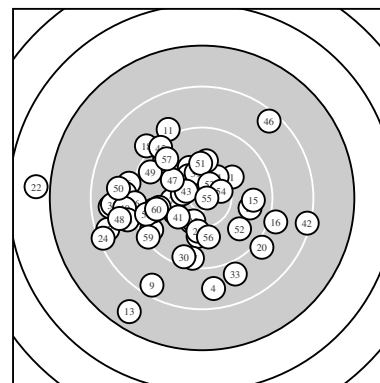

Serie 1:  
 10.1 ↗ 10.2 ↖ 10.1 ↖ 8.7 ↓ 10.2 ←  
 9.1 ← 10.2 ← 10.3 ↓ 8.5 ↓ 9.8 →  
 beste Teiler 509.1 (8.) 595.8 (7.) 608.8 (2.)  
 Trefferlage 2.87 mm links, 3.30 mm tief  
 Streuwert 7.63, horizontal: 7.14, vertikal: 8.10

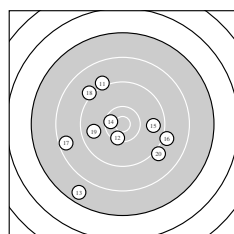

Serie 2:  
 9.1 ↖ 10.4 ↓ 7.7 ↓ 10.5 \* 9.7 →  
 9.1 → 8.5 ← 9.1 ↖ 9.7 ← 9.1 ↘  
 beste Teiler 394.0 (14.) 478.2 (12.) 966.2 (19.)  
 Trefferlage 2.88 mm links, 2.56 mm tief  
 Streuwert 10.70, horizontal: 11.40, vertikal: 9.94

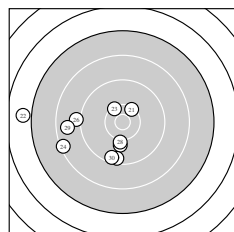

Serie 3:  
 10.3 ↗ 6.9 ← 10.3 ↖ 8.3 ← 10.0 ↓  
 9.1 ← 9.5 ↓ 10.1 ↓ 8.7 ← 9.4 ↓  
 beste Teiler 507.7 (21.) 508.1 (23.) 654.7 (28.)  
 Trefferlage 9.15 mm links, 3.53 mm tief  
 Streuwert 9.19, horizontal: 11.41, vertikal: 6.24

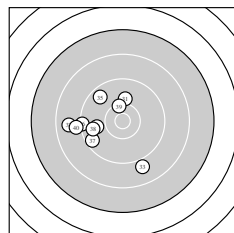

Serie 4:  
 10.0 ↑ 8.8 ← 8.9 ↓ 9.9 ← 9.6 ↖  
 9.3 ← 9.5 ← 9.7 ← 10.3 ↑ 9.0 ←  
 beste Teiler 503.5 (39.) 729.9 (31.) 859.1 (34.)  
 Trefferlage 7.47 mm links, 0.98 mm tief  
 Streuwert 7.12, horizontal: 7.50, vertikal: 6.71

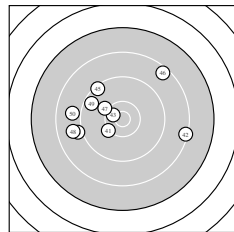

Serie 5:  
 10.2 ↖ 8.3 → 10.5 \* 9.1 ← 9.4 ↖  
 8.5 ↗ 10.1 ↖ 8.9 ← 9.5 ↖ 8.9 ←  
 beste Teiler 335.0 (43.) 596.1 (41.) 677.9 (47.)  
 Trefferlage 4.51 mm links, 1.97 mm hoch  
 Streuwert 9.89, horizontal: 12.30, vertikal: 6.67

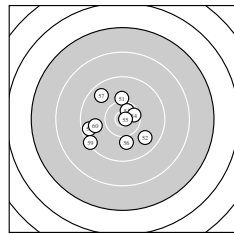

Serie 6:  
 10.1 ↑ 9.8 ↘ 10.6 \* 10.5 \* 10.8 \*  
 10.0 ↓ 9.7 ↖ 9.5 ← 9.3 ← 9.8 ←  
 beste Teiler 94.0 (55.) 310.4 (53.) 392.7 (54.)  
 Trefferlage 2.27 mm links, 0.82 mm tief  
 Streuwert 6.01, horizontal: 6.46, vertikal: 5.52

Meyton Elektronik

**LP 60** – Wertung – **Männer**

StandNr: 102

**Wohlfarter,, Hans-Dieter** #70501052

**StartNr: 50**

4. Februar 2018 11:06

70501 / 0

---

\_\_\_\_\_  
Unterschrift des Schützen

Meyton Elektronik

Ergebnis: **550** (579.3)  
 Serien: 92 90 94 94 93 87  
 Zähler: 24 24 10 2 0 0 0 0 0 0  
 Innenzehner: 11  
 weiteste: 2834 (52), 2647 (8), 2231 (38)  
 beste Teiler 173.9 (1.) 180.0 (60.) 245.3 (4.)  
 Trefferlage 2.34 mm links, 0.75 mm hoch  
 Streuwert 8.35, horizontal: 7.65, vertikal: 9.00

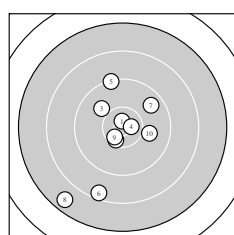
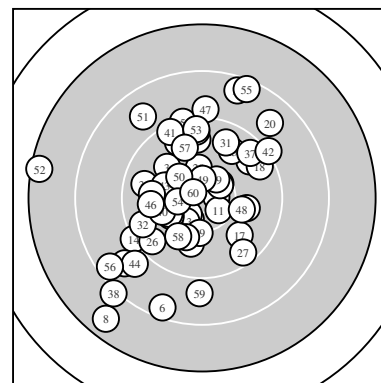

Serie 1:  
 10.7 \* 10.4 \* 9.9 ↘ 10.6 \* 9.3 ↑  
 8.5 ↓ 9.7 ↗ 7.6 ↙ 10.5 \* 10.0 →  
 beste Teiler 173.9 (1.) 245.3 (4.) 361.8 (9.)  
 Trefferlage 1.87 mm links, 2.12 mm tief  
 Streuwert 9.04, horizontal: 7.22, vertikal: 10.55

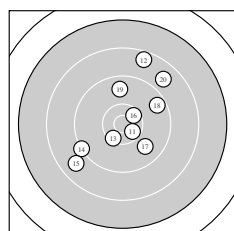

Serie 2:  
 10.5 \* 8.5 ↑ 10.3 ↙ 9.2 ↖ 8.8 ↗  
 10.5 \* 9.8 ↘ 9.5 ↗ 9.7 ↑ 8.8 ↗  
 beste Teiler 351.6 (11.) 400.1 (16.) 482.0 (13.)  
 Trefferlage 1.15 mm rechts, 1.84 mm hoch  
 Streuwert 9.07, horizontal: 8.42, vertikal: 9.67

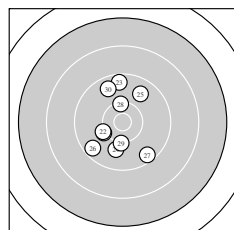

Serie 3:  
 10.2 ↖ 10.2 ↖ 9.5 ↑ 9.9 ↓ 9.8 ↗  
 9.5 ↖ 9.5 ↘ 10.3 ↑ 10.2 ↓ 9.7 ↘  
 beste Teiler 521.0 (28.) 601.5 (29.) 620.9 (21.)  
 Trefferlage 1.53 mm links, 0.23 mm tief  
 Streuwert 6.56, horizontal: 4.80, vertikal: 7.94

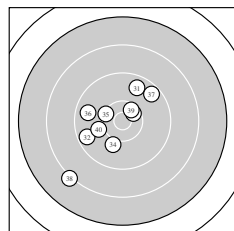

Serie 4:  
 9.7 ↑ 9.6 ↖ 10.5 \* 10.0 ↓ 10.3 ↘  
 9.7 ↖ 9.5 ↗ 8.2 ↙ 10.5 \* 10.0 ↖  
 beste Teiler 376.7 (33.) 400.6 (39.) 520.6 (35.)  
 Trefferlage 3.17 mm links, 0.30 mm tief  
 Streuwert 7.53, horizontal: 7.51, vertikal: 7.55

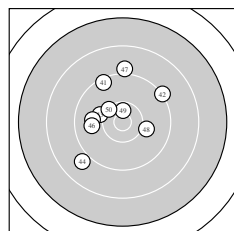

Serie 5:  
 9.4 ↘ 9.2 ↗ 10.1 ↖ 8.9 ↖ 9.9 ←  
 9.8 ← 9.1 ↑ 10.1 → 10.5 \* 10.3 ↘  
 beste Teiler 328.1 (49.) 533.5 (50.) 678.9 (43.)  
 Trefferlage 2.58 mm links, 2.98 mm hoch  
 Streuwert 7.36, horizontal: 7.31, vertikal: 7.42

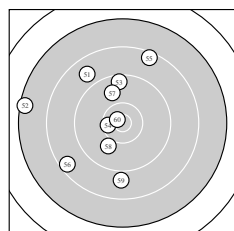

Serie 6:  
 8.8 ↘ 7.4 ← 9.5 ↑ 10.4 \* 8.4 ↑  
 8.5 ↖ 9.8 ↘ 10.0 ↙ 8.9 ↓ 10.7 \*  
 beste Teiler 180.0 (60.) 420.3 (54.) 773.9 (58.)  
 Trefferlage 6.03 mm links, 2.36 mm hoch  
 Streuwert 10.66, horizontal: 9.84, vertikal: 11.42

**LP 60** – Wertung – **Männer**

StandNr: 103

**Wutte,, Alexander** #70210007

**StartNr: 51**

4. Februar 2018 11:11

70210 / 0

---

\_\_\_\_\_  
Unterschrift des Schützen

Meyton Elektronik

Ergebnis: **529** (556.1)  
 Serien: 85 91 87 88 91 87  
 Zähler: 13 24 22 1 0 0 0 0 0 0  
 Innenzehner: 5  
 weiteste: 2617 (8), 2359 (46), 2325 (53)  
 beste Teiler 149.0 (47.) 162.4 (2.) 313.0 (15.)  
 Trefferlage 1.91 mm links, 0.70 mm hoch  
 Streuwert 10.48, horizontal: 11.19, vertikal: 9.72

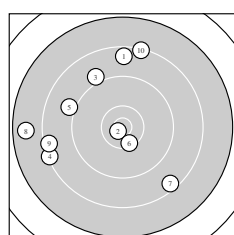
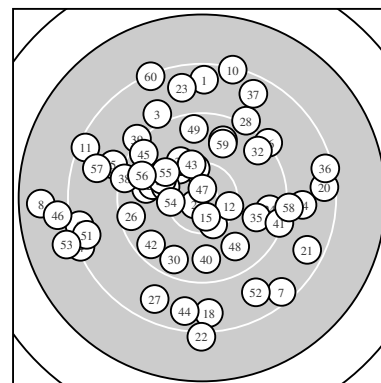

Serie 1:  
 8.6 ↑                      10.7 \*                      9.0 ↘                      8.3 ↙                      9.0 ↖  
 10.4 \*                      8.5 ↘                      7.7 ←                      8.4 ←                      8.3 ↑  
 beste Teiler 162.4 (2.) 466.1 (6.) 1540.8 (5.)  
 Trefferlage 6.86 mm links, 2.51 mm hoch  
 Streuwert 12.34, horizontal: 12.71, vertikal: 11.96

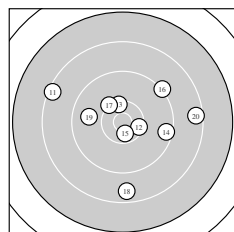

Serie 2:  
 8.4 ↖                      10.4 \*                      10.3 ↑                      9.4 →                      10.6 \*  
 9.2 ↗                      10.2 ↘                      8.6 ↓                      9.8 ←                      8.5 →  
 beste Teiler 313.0 (15.) 462.6 (12.) 489.9 (13.)  
 Trefferlage 1.58 mm rechts, 0.40 mm hoch  
 Streuwert 9.60, horizontal: 11.05, vertikal: 7.89

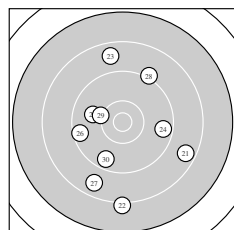

Serie 3:  
 8.6 ↘                      8.1 ↓                      8.7 ↑                      9.6 →                      9.9 ↖  
 9.5 ←                      8.7 ↙                      9.1 ↑                      10.2 ↖                      9.6 ↙  
 beste Teiler 620.3 (29.) 830.2 (25.) 1097.3 (30.)  
 Trefferlage 0.59 mm links, 2.78 mm tief  
 Streuwert 10.92, horizontal: 9.32, vertikal: 12.32

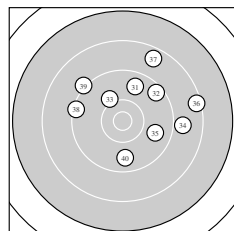

Serie 4:  
 9.7 ↑                      9.5 ↗                      10.1 ↘                      8.9 →                      9.8 →  
 8.4 →                      8.6 ↑                      9.3 ←                      9.2 ↘                      9.7 ↓  
 beste Teiler 691.5 (33.) 937.2 (35.) 994.3 (40.)  
 Trefferlage 3.99 mm rechts, 4.32 mm hoch  
 Streuwert 9.26, horizontal: 10.69, vertikal: 7.57

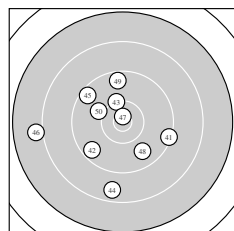

Serie 5:  
 9.3 →                      9.6 ↙                      10.2 ↑                      8.6 ↓                      9.5 ↖  
 8.0 ←                      10.8 \*                      9.8 ↘                      9.5 ↑                      10.1 ↖  
 beste Teiler 149.0 (47.) 570.6 (43.) 711.9 (50.)  
 Trefferlage 3.54 mm links, 1.23 mm tief  
 Streuwert 9.14, horizontal: 9.55, vertikal: 8.70

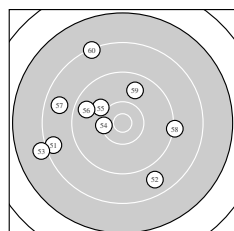

Serie 6:  
 8.5 ←                      8.7 ↘                      8.0 ←                      10.3 ←                      10.0 ↖  
 9.7 ↖                      8.7 ←                      9.2 →                      9.8 ↑                      8.3 ↘  
 beste Teiler 511.1 (54.) 725.2 (55.) 942.8 (59.)  
 Trefferlage 6.06 mm links, 1.01 mm hoch  
 Streuwert 10.83, horizontal: 11.88, vertikal: 9.66

**LP 60** – Wertung – **Männer**

StandNr: 104

**Kathrein,, Dietmar** #70501024

**StartNr: 52**

4. Februar 2018 10:47

70501 / 0

---

\_\_\_\_\_  
Unterschrift des Schützen

Meyton Elektronik



Ergebnis:	<b>552</b>						(577.2)
Serien:	92	95	91	88	95	91	
Zähler:	24	26	8	2	0	0	
Innenzehner:	14						
weiteste:	2677 (22), 2527 (33), 2394 (31)						
beste Teiler	212.5 (8.) 225.8 (29.) 256.6 (35.)						
Trefferlage	0.19 mm rechts, 2.00 mm hoch						
Streuwert	8.72, horizontal: 7.39, vertikal: 9.88						

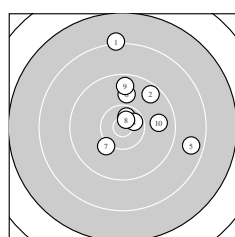
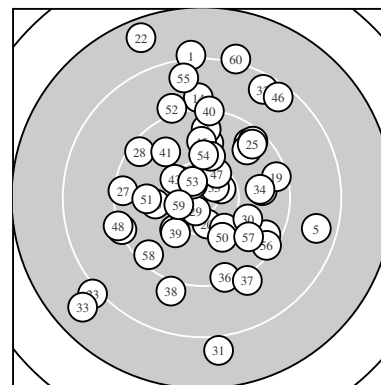

Serie 1:	8.2 ↑	9.5 ↗	10.6 *	10.5 *	8.6 →
	9.9 ↑	10.1 ↙	10.7 *	9.6 ↑	9.8 →
beste Teiler	212.5 (8.) 295.4 (3.) 329.2 (4.)				
Trefferlage	3.50 mm rechts, 4.76 mm hoch				
Streuwert	7.32, horizontal: 6.42, vertikal: 8.12				

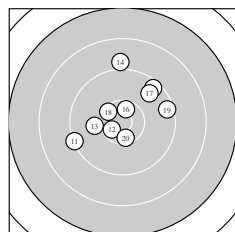

Serie 2:	9.3 ←	10.5 *	10.0 ←	9.0 ↑	9.5 ↗
	10.5 *	9.7 ↗	10.4 *	9.4 →	10.4 *
beste Teiler	339.7 (12.) 346.1 (16.) 414.4 (20.)				
Trefferlage	0.12 mm rechts, 2.94 mm hoch				
Streuwert	6.86, horizontal: 7.30, vertikal: 6.39				

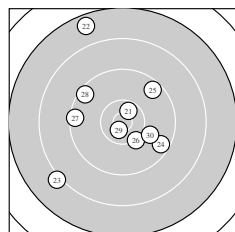

Serie 3:	10.5 *	7.6 ↘	8.1 ↙	9.5 ↘	9.5 ↗
	10.2 ↘	9.4 ←	9.4 ↘	10.7 *	10.0 ↘
beste Teiler	225.8 (29.) 328.7 (21.) 585.8 (26.)				
Trefferlage	1.98 mm links, 1.38 mm hoch				
Streuwert	10.15, horizontal: 9.54, vertikal: 10.72				

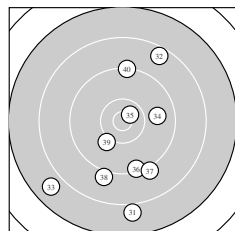

Serie 4:	8.0 ↓	8.5 ↗	7.8 ↙	9.8 →	10.6 *
	9.3 ↓	9.1 ↘	9.0 ↓	10.1 ↙	9.2 ↑
beste Teiler	256.6 (35.) 685.0 (39.) 914.8 (34.)				
Trefferlage	0.72 mm rechts, 5.26 mm tief				
Streuwert	11.18, horizontal: 8.37, vertikal: 13.41				

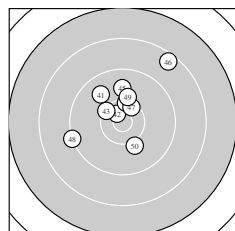

Serie 5:	9.8 ↘	10.6 *	10.3 ↘	10.3 ↑	9.8 ↑
	8.5 ↗	10.4 *	9.2 ←	10.1 ↑	10.1 ↘
beste Teiler	259.8 (42.) 447.6 (47.) 506.5 (44.)				
Trefferlage	0.50 mm links, 4.16 mm hoch				
Streuwert	6.40, horizontal: 6.51, vertikal: 6.29				

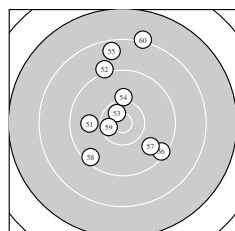

Serie 6:	9.9 ←	9.1 ↘	10.6 *	10.1 ↑	8.6 ↑
	9.4 ↘	9.8 ↘	9.4 ↙	10.5 *	8.2 ↑
beste Teiler	296.9 (53.) 378.1 (59.) 673.4 (54.)				
Trefferlage	0.68 mm links, 4.01 mm hoch				
Streuwert	8.97, horizontal: 6.39, vertikal: 10.95				

Meyton Elektronik

**LP 60** – Wertung – **Männer**

StandNr: 105

**Gstir., David** #70210006

**StartNr: 53**

4. Februar 2018 10:59

70210 / 0

---

\_\_\_\_\_  
Unterschrift des Schützen

Meyton Elektronik

Ergebnis:	<b>551</b>	(580.6)				
Serien:	93	92	89	96	93	88
Zähler:	21	30	8	1	0	0
Innenzehner:	7					
weiteste:	2438 (18), 2127 (24), 1848 (51)					
beste Teiler	199.2 (60.) 293.4 (45.) 323.7 (12.)					
Trefferlage	0.14 mm rechts, 1.97 mm tief					
Streuwert	7.90, horizontal: 9.02, vertikal: 6.59					

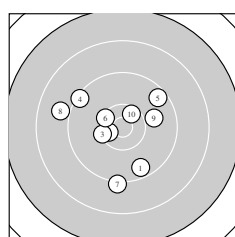
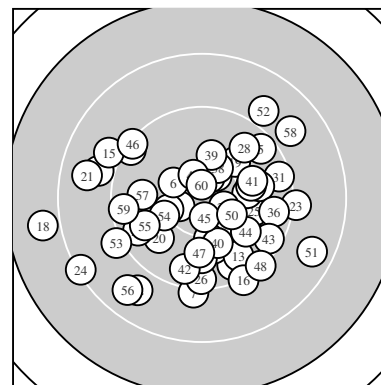

Serie 1:

9.6 ↘	10.5 *	10.3 ←	9.3 ↖	9.5 ↗
10.3 ↖	9.2 ↓	8.9 ←	9.9 →	10.5 *
beste Teiler	362.0 (2.) 397.9 (10.) 490.8 (6.)			
Trefferlage	1.68 mm links, 0.07 mm tief			
Streuwert	7.50, horizontal: 7.85, vertikal: 7.13			

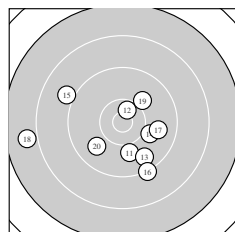

Serie 2:

10.0 ↓	10.5 *	9.7 ↘	10.0 ↗	9.0 ↖
9.2 ↘	9.8 →	7.9 ←	10.0 ↗	9.8 ↙
beste Teiler	323.7 (12.) 738.8 (19.) 745.0 (14.)			
Trefferlage	0.91 mm links, 2.85 mm tief			
Streuwert	8.80, horizontal: 10.72, vertikal: 6.32			

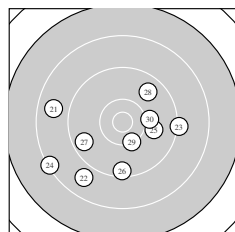

Serie 3:

8.7 ←	8.8 ↙	9.2 →	8.3 ↙	9.9 →
9.4 ↓	9.6 ←	9.7 ↗	10.3 ↓	10.1 →
beste Teiler	547.6 (29.) 684.6 (30.) 811.0 (25.)			
Trefferlage	1.76 mm links, 3.82 mm tief			
Streuwert	9.40, horizontal: 11.30, vertikal: 6.99			

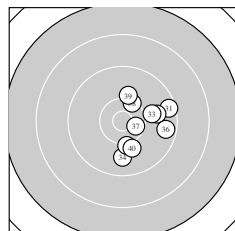

Serie 4:

9.4 →	9.8 →	10.0 →	9.8 ↓	10.2 ↓
9.6 →	10.5 *	10.3 ↑	10.1 ↑	10.0 ↓
beste Teiler	352.6 (37.) 511.3 (38.) 622.5 (35.)			
Trefferlage	4.90 mm rechts, 0.76 mm tief			
Streuwert	4.80, horizontal: 4.32, vertikal: 5.23			

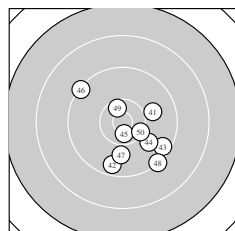

Serie 5:

9.9 →	9.6 ↓	9.5 ↘	9.9 ↘	10.6 *
9.3 ↖	9.9 ↓	9.3 ↘	10.5 *	10.3 ↘
beste Teiler	293.4 (45.) 373.7 (49.) 514.6 (50.)			
Trefferlage	2.32 mm rechts, 3.15 mm tief			
Streuwert	6.32, horizontal: 6.39, vertikal: 6.25			

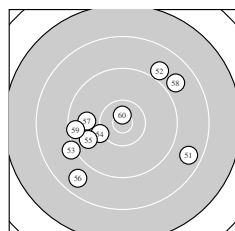

Serie 6:

8.6 ↗	8.9 ↗	9.1 ↙	10.2 ↙	9.8 ↙
8.7 ↙	9.8 ←	8.9 ↗	9.5 ←	10.7 *
beste Teiler	199.2 (60.) 629.0 (54.) 902.3 (57.)			
Trefferlage	2.02 mm links, 1.16 mm tief			
Streuwert	9.77, horizontal: 11.17, vertikal: 8.15			

Meyton Elektronik

**LP 60** – Wertung – **Männer**

StandNr: 106

**Jäger,, Gerhard** #70501020

**StartNr: 54**

4. Februar 2018 10:58

70501 / 0

---

Unterschrift des Schützen

Meyton Elektronik

Ergebnis:	<b>563</b>	(589.3)				
Serien:	96	94	96	92	93	92
Zähler:	30	24	5	1	0	0
Innenzehner:	14					
weiteste:	2503 (44), 2166 (37), 2160 (16)					
beste Teiler	127.6 (4.) 192.8 (50.) 196.7 (35.)					
Trefferlage	0.67 mm rechts, 2.96 mm hoch					
Streuwert	7.16, horizontal: 7.10, vertikal: 7.21					

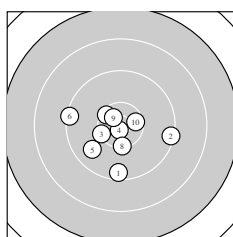
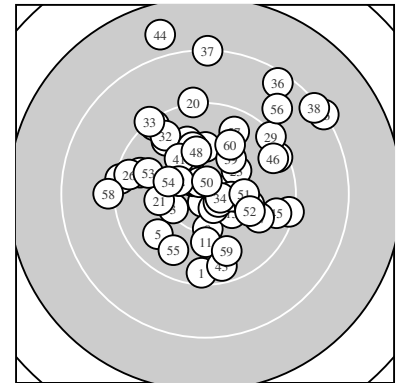

Serie 1:

9.5 ↓	9.3 →	10.3 ↙	10.8 *	9.8 ↘
9.3 ↙	10.4 *	10.3 ↓	10.6 *	10.5 *

beste Teiler 127.6 (4.) 263.8 (9.) 387.9 (10.)  
 Trefferlage 1.42 mm links, 2.18 mm tief  
 Streuwert 5.78, horizontal: 6.76, vertikal: 4.59

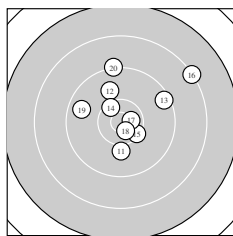

Serie 2:

10.0 ↓	9.9 ↗	9.4 ↘	10.4 *	10.3 ↘
8.3 ↗	10.6 *	10.6 *	9.7 ↙	9.2 ↑

beste Teiler 250.0 (18.) 266.8 (17.) 445.9 (14.)  
 Trefferlage 2.01 mm rechts, 3.43 mm hoch  
 Streuwert 7.24, horizontal: 7.75, vertikal: 6.69

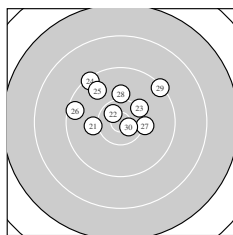

Serie 3:

10.1 ↙	10.6 *	10.2 ↘	9.3 ↘	9.7 ↘
9.5 ↙	10.2 →	10.1 ↑	9.3 ↗	10.7 *

beste Teiler 235.9 (30.) 287.6 (22.) 592.6 (23.)  
 Trefferlage 1.08 mm links, 3.97 mm hoch  
 Streuwert 5.76, horizontal: 6.90, vertikal: 4.33

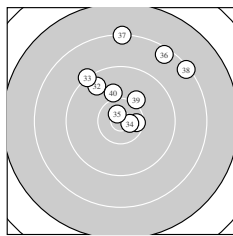

Serie 4:

10.4 *	9.6 ↘	9.2 ↘	10.7 *	10.7 *
8.4 ↗	8.2 ↑	8.3 ↗	10.1 ↗	10.0 ↑

beste Teiler 196.7 (35.) 238.1 (34.) 401.1 (31.)  
 Trefferlage 2.10 mm rechts, 8.44 mm hoch  
 Streuwert 7.40, horizontal: 7.44, vertikal: 7.36

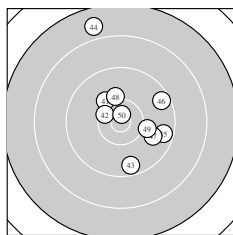

Serie 5:

10.1 ↘	10.4 *	9.6 ↓	7.8 ↑	9.6 →
9.5 ↗	9.8 →	10.1 ↑	10.1 →	10.7 *

beste Teiler 192.8 (50.) 441.4 (42.) 657.1 (48.)  
 Trefferlage 2.29 mm rechts, 2.60 mm hoch  
 Streuwert 7.92, horizontal: 6.39, vertikal: 9.20

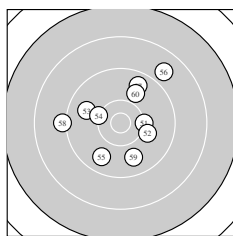

Serie 6:

10.2 →	10.0 →	9.8 ↙	10.2 ↙	9.7 ↘
8.8 ↗	9.6 ↑	9.1 ↙	9.8 ↓	9.9 ↑

beste Teiler 585.9 (54.) 593.0 (51.) 727.0 (52.)  
 Trefferlage 0.15 mm rechts, 1.51 mm hoch  
 Streuwert 7.61, horizontal: 8.08, vertikal: 7.11

Meyton Elektronik

**LP 60** – Wertung – **Männer**

StandNr: 107

**Höllwarth,, David** #70802020

**StartNr: 55**

4. Februar 2018 11:07

70802 / 0

---

\_\_\_\_\_  
Unterschrift des Schützen

Meyton Elektronik

Ergebnis:	<b>548</b>	(573.4)				
Serien:	90	94	91	91	91	91
Zähler:	19	32	7	2	0	0
Innenzehner:	7					
weiteste:	2640 (24), 2401 (45), 2222 (16)					
beste Teiler	88.6 (22.) 424.3 (60.) 426.6 (14.)					
Trefferlage	0.43 mm rechts, 0.29 mm hoch					
Streuwert	8.79, horizontal: 7.21, vertikal: 10.12					

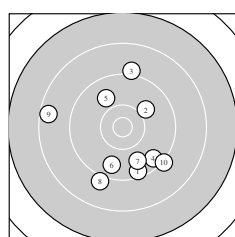
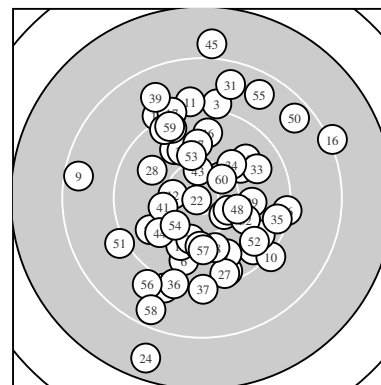

Serie 1:

9.4 ↘	10.0 ↗	9.1 ↑	9.5 ↘	9.9 ↗
9.7 ↓	9.8 ↘	9.1 ↓	8.5 ←	9.2 ↘

beste Teiler 757.4 (2.) 864.3 (5.) 951.6 (7.)  
 Trefferlage 0.26 mm rechts, 3.09 mm tief  
 Streuwert 9.23, horizontal: 8.69, vertikal: 9.74

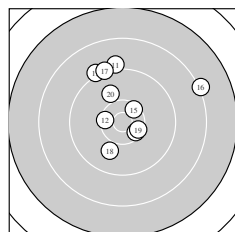

Serie 2:

9.1 ↑	10.4 *	9.1 ↘	10.4 *	10.4 *
8.2 ↗	9.2 ↘	9.9 ↓	10.4 *	10.0 ↘

beste Teiler 426.6 (14.) 440.0 (15.) 446.8 (19.)  
 Trefferlage 0.60 mm rechts, 4.94 mm hoch  
 Streuwert 7.79, horizontal: 7.89, vertikal: 7.70

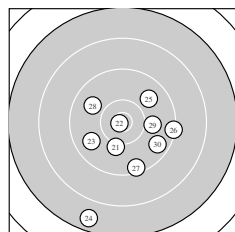

Serie 3:

10.1 ↓	10.8 *	9.8 ↙	7.7 ↓	9.8 ↗
9.3 →	9.4 ↓	9.8 ↘	10.0 →	9.6 ↘

beste Teiler 88.6 (22.) 664.9 (21.) 780.8 (29.)  
 Trefferlage 1.31 mm rechts, 4.63 mm tief  
 Streuwert 8.39, horizontal: 7.92, vertikal: 8.83

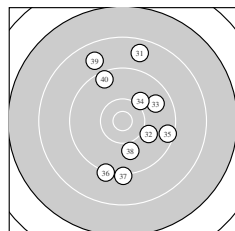

Serie 4:

8.7 ↑	10.0 ↘	9.7 ↗	10.1 ↗	9.4 →
9.2 ↓	9.2 ↓	10.0 ↓	8.8 ↘	9.5 ↘

beste Teiler 694.9 (34.) 754.8 (32.) 798.4 (38.)  
 Trefferlage 2.19 mm rechts, 1.19 mm hoch  
 Streuwert 9.17, horizontal: 6.21, vertikal: 11.39

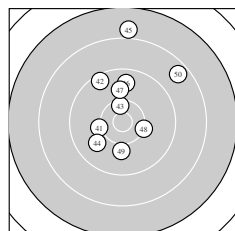

Serie 5:

10.2 ←	9.4 ↘	10.4 *	9.9 ↙	7.9 ↑
9.7 ↑	9.9 ↑	10.2 ↘	10.0 ↓	8.6 ↗

beste Teiler 429.4 (43.) 576.8 (48.) 623.8 (41.)  
 Trefferlage 0.21 mm rechts, 5.36 mm hoch  
 Streuwert 8.13, horizontal: 6.28, vertikal: 9.63

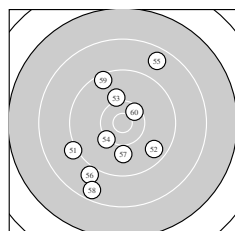

Serie 6:

9.1 ↙	9.6 ↘	10.1 ↑	10.2 ↙	8.7 ↗
9.0 ↙	9.9 ↓	8.6 ↓	9.4 ↗	10.4 *

beste Teiler 424.3 (60.) 596.8 (54.) 679.1 (53.)  
 Trefferlage 1.98 mm links, 2.02 mm tief  
 Streuwert 9.18, horizontal: 7.17, vertikal: 10.83

Meyton Elektronik

**LP 60** – Wertung – **Männer**

StandNr: 108

**Schranz,, Martin** #70501043

**StartNr: 56**

4. Februar 2018 10:57

70501 / 0

---

\_\_\_\_\_  
Unterschrift des Schützen

Meyton Elektronik



Ergebnis: **497** (525.3)  
 Serien: 85 88 82 84 79 79  
 Zähler: 7 22 21 5 3 1 0 1 0 0  
 Innenzehner: 1  
 weiteste: 5788 (56), 4146 (43), 3838 (28)  
 beste Teiler 290.2 (18.) 534.4 (11.) 598.8 (35.)  
 Trefferlage 9.36 mm rechts, 1.44 mm tief  
 Streuwert 12.70, horizontal: 13.00, vertikal: 12.38

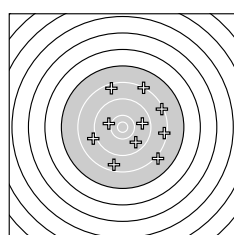
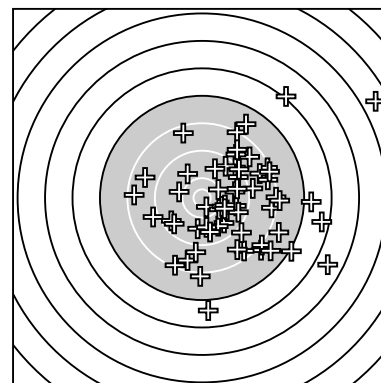

Serie 1:  
 8.6 ↓                      9.7 →                      8.4 →                      10.1 ←                      9.7 ↘  
 8.2 ↗                      8.1 ↘                      8.5 ↑                      9.0 ←                      8.3 →  
 beste Teiler 691.7 (4.) 970.8 (5.) 975.1 (2.)  
 Trefferlage 5.20 mm rechts, 0.11 mm hoch  
 Streuwert 12.46, horizontal: 12.16, vertikal: 12.75

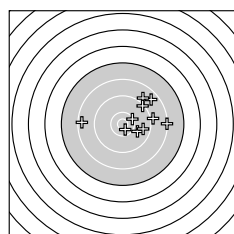

Serie 2:  
 10.3 ↗                      9.1 →                      9.9 ↘                      8.7 ↗                      8.9 ↗  
 8.5 ←                      9.7 →                      10.6 \*                      9.3 ↗                      8.3 →  
 beste Teiler 290.2 (18.) 534.4 (11.) 801.4 (13.)  
 Trefferlage 7.31 mm rechts, 3.13 mm hoch  
 Streuwert 8.89, horizontal: 11.05, vertikal: 5.99

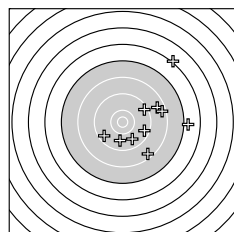

Serie 3:  
 9.8 ↓                      9.8 ↘                      8.7 ↗                      8.5 →                      7.0 →  
 8.5 ↘                      9.4 ↗                      6.2 ↗                      9.6 ↗                      9.5 ↘  
 beste Teiler 905.9 (21.) 947.7 (22.) 1118.4 (29.)  
 Trefferlage 12.00 mm rechts, 0.33 mm hoch  
 Streuwert 12.33, horizontal: 12.00, vertikal: 12.64

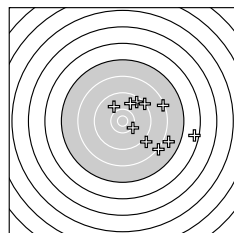

Serie 4:  
 8.3 →                      9.5 ↗                      9.8 ↑                      8.2 ↘                      10.2 ↘  
 9.0 ↘                      7.9 ↘                      6.5 →                      9.2 ↗                      9.9 ↘  
 beste Teiler 598.8 (35.) 816.3 (40.) 927.6 (33.)  
 Trefferlage 12.79 mm rechts, 0.35 mm tief  
 Streuwert 10.29, horizontal: 11.16, vertikal: 9.34

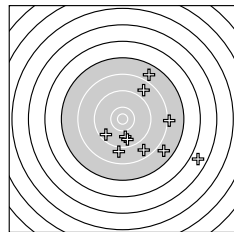

Serie 5:  
 8.8 ↗                      7.8 ↘                      5.8 ↘                      9.9 ↓                      9.0 ↓  
 7.8 ↗                      9.7 ↓                      9.6 ↗                      8.7 ↘                      8.1 →  
 beste Teiler 867.4 (44.) 1019.9 (47.) 1109.5 (48.)  
 Trefferlage 10.61 mm rechts, 5.70 mm tief  
 Streuwert 13.40, horizontal: 13.23, vertikal: 13.57

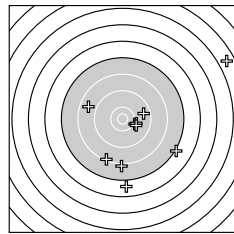

Serie 6:  
 10.2 ↘                      9.6 →                      7.2 ↘                      8.7 ←                      10.1 →  
 3.7 ↗                      8.1 ↓                      6.8 ↓                      8.3 ↓                      10.0 ↘  
 beste Teiler 635.0 (51.) 698.0 (55.) 729.5 (60.)  
 Trefferlage 8.26 mm rechts, 6.17 mm tief  
 Streuwert 17.98, horizontal: 18.62, vertikal: 17.32

**LP 60** – Wertung – **Junioren**

StandNr: 109

**Lackner, Thomas** #70804103

**StartNr: 57**

4. Februar 2018 10:53

0 / 0

---

\_\_\_\_\_  
Unterschrift des Schützen

Meyton Elektronik

Ergebnis: **357** (374.3)  
 Serien: 88 89 90 90  
 Zähler: 10 20 8 1 1 0 0 0 0 0  
 Innenzehner: 2  
 weiteste: 3662 (1), 2938 (20), 2154 (10)  
 beste Teiler 77.3 (34.) 359.7 (17.) 479.3 (35.)  
 Trefferlage 5.56 mm links, 0.16 mm hoch  
 Streuwert 9.57, horizontal: 9.45, vertikal: 9.69

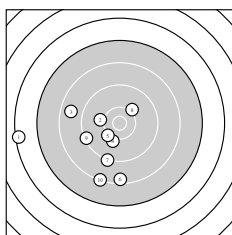
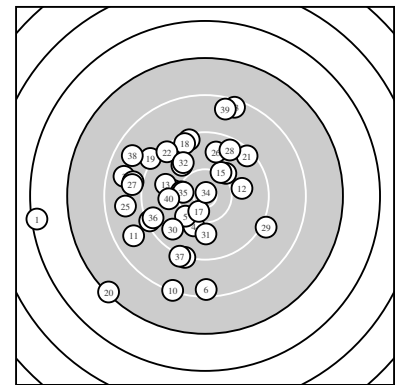

Serie 1:  
 6.4 ←                      10.1 ←                      8.7 ←                      10.1 ↓                      10.2 ↘  
 8.4 ↓                      9.2 ↓                      10.1 ↗                      9.3 ←                      8.3 ↓  
 beste Teiler 607.4 (5.) 662.3 (8.) 690.5 (4.)  
 Trefferlage 8.59 mm links, 6.47 mm tief  
 Streuwert 10.34, horizontal: 11.48, vertikal: 9.05

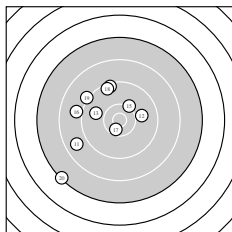

Serie 2:  
 8.7 ↙                      9.9 →                      9.8 ←                      9.4 ↑                      10.2 ↗  
 9.0 ←                      10.5 \*                      9.4 ↘                      9.2 ↘                      7.3 ↘  
 beste Teiler 359.7 (17.) 612.6 (15.) 812.5 (12.)  
 Trefferlage 6.99 mm links, 1.10 mm hoch  
 Streuwert 9.52, horizontal: 9.09, vertikal: 9.92

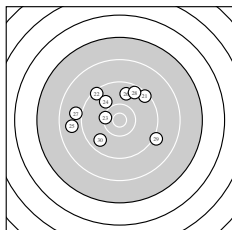

Serie 3:  
 9.4 ↗                      9.4 ↘                      10.3 ←                      9.9 ↘                      8.8 ←  
 9.7 ↑                      9.0 ←                      9.5 ↑                      9.1 ↘                      9.7 ↘  
 beste Teiler 518.6 (23.) 828.0 (24.) 975.9 (26.)  
 Trefferlage 2.82 mm links, 3.13 mm hoch  
 Streuwert 8.58, horizontal: 10.11, vertikal: 6.72

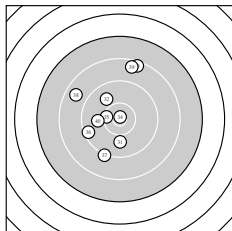

Serie 4:  
 9.9 ↓                      9.9 ↘                      8.4 ↑                      10.9 \*                      10.4 ←  
 9.4 ←                      9.2 ↓                      8.7 ↘                      8.5 ↑                      10.0 ←  
 beste Teiler 77.3 (34.) 479.3 (35.) 785.4 (40.)  
 Trefferlage 3.85 mm links, 2.87 mm hoch  
 Streuwert 8.95, horizontal: 6.82, vertikal: 10.66

Unterschrift des Schützen

Meyton Elektronik

Ergebnis:	<b>369</b>	(385.4)
Serien:	92 96 90 91	
Zähler:	15 20 4 1 0 0 0 0 0 0	
Innenzehner:	2	
weiteste:	2538 (4), 2056 (29), 1905 (35)	
beste Teiler	123.6 (38.) 367.4 (11.) 533.1 (24.)	
Trefferlage	2.54 mm rechts, 0.26 mm hoch	
Streuwert	8.11, horizontal: 8.41, vertikal: 7.80	

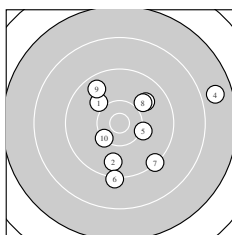
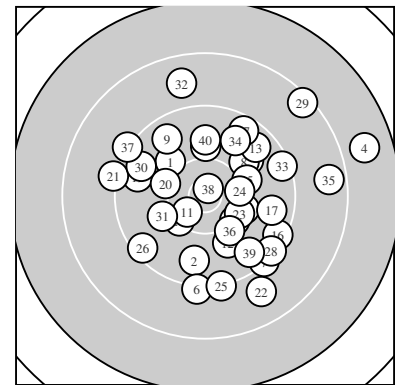

Serie 1:	10.0 ↘	9.7 ↓	9.9 ↗	7.8 →	10.2 →
	9.2 ↓	9.3 ↘	10.0 ↗	9.6 ↖	10.3 ↙
beste Teiler	546.6 (10.)	631.1 (5.)	744.5 (1.)		
Trefferlage	3.39 mm rechts, 0.78 mm tief				
Streuwert	8.74, horizontal: 9.14, vertikal: 8.32				

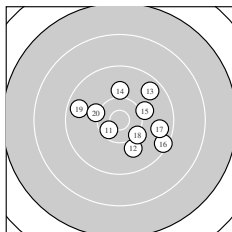

Serie 2:	10.5 *	10.0 ↘	9.6 ↗	10.0 ↑	10.1 →
	9.4 ↘	9.7 →	10.2 ↘	9.6 ↖	10.2 ↖
beste Teiler	367.4 (11.)	587.8 (18.)	631.6 (20.)		
Trefferlage	2.43 mm rechts, 0.06 mm hoch				
Streuwert	6.19, horizontal: 7.06, vertikal: 5.18				

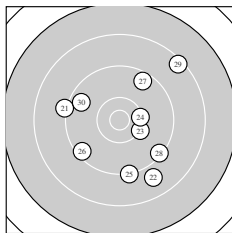

Serie 3:	9.2 ↖	8.8 ↘	10.2 ↘	10.3 →	9.2 ↓
	9.4 ↙	9.5 ↗	9.3 ↘	8.4 ↗	9.6 ↖
beste Teiler	533.1 (24.)	588.5 (23.)	1072.4 (30.)		
Trefferlage	1.91 mm rechts, 1.48 mm tief				
Streuwert	9.67, horizontal: 9.64, vertikal: 9.71				

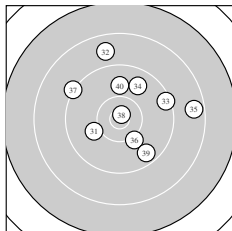

Serie 4:	10.1 ↙	8.8 ↑	9.4 →	9.7 ↗	8.6 →
	10.1 ↘	9.2 ↖	10.8 *	9.6 ↘	9.9 ↑
beste Teiler	123.6 (38.)	649.4 (36.)	720.1 (31.)		
Trefferlage	2.43 mm rechts, 3.27 mm hoch				
Streuwert	8.29, horizontal: 8.89, vertikal: 7.65				

Unterschrift des Schützen

Ergebnis: **377.6** (357)  
 Serien: 95.4 94.5 91.1 96.6  
 Zähler: 11 18 8 3 0 0 0 0 0 0  
 Innenzehner: 8  
 weiteste: 803 (19), 770 (25), 756 (38)  
 beste Teiler 50.5 (37.) 72.0 (10.) 95.4 (8.)  
 Trefferlage 0.49 mm links, 1.49 mm tief  
 Streuwert 2.90, horizontal: 3.58, vertikal: 2.00

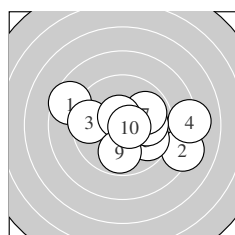
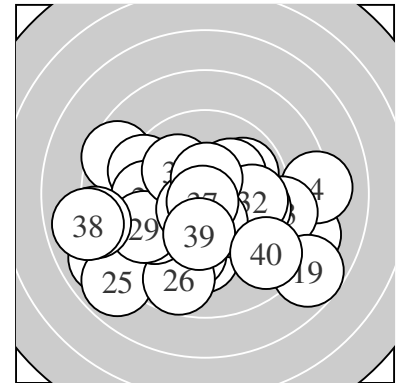

Serie 1:  
 8.6 ↖                      8.3 →                      9.6 ←                      8.2 →                      9.8 ↘  
 9.9 →                      9.9 ↗                      10.6 \*                      9.8 ↓                      10.7 \*  
 beste Teiler 72.0 (10.) 95.4 (8.) 252.1 (6.)  
 Trefferlage 1.17 mm rechts, 0.16 mm tief  
 Streuwert 2.98, horizontal: 3.88, vertikal: 1.63

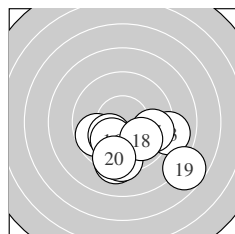

Serie 2:  
 9.8 ↙                      9.3 ↓                      9.0 →                      10.2 \*                      9.7 →  
 10.1 ↘                      9.4 ↓                      9.9 ↘                      7.7 ↘                      9.4 ↓  
 beste Teiler 193.0 (14.) 212.8 (16.) 261.1 (18.)  
 Trefferlage 0.93 mm rechts, 2.49 mm tief  
 Streuwert 2.36, horizontal: 2.99, vertikal: 1.48

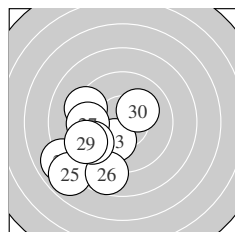

Serie 3:  
 8.0 ↙                      9.3 ↖                      10.1 ↓                      8.8 ↘                      7.9 ↙  
 8.7 ↓                      9.5 ←                      9.4 ↙                      9.2 ↙                      10.2 \*  
 beste Teiler 199.6 (30.) 205.2 (23.) 363.3 (27.)  
 Trefferlage 3.07 mm links, 2.22 mm tief  
 Streuwert 2.39, horizontal: 2.29, vertikal: 2.48

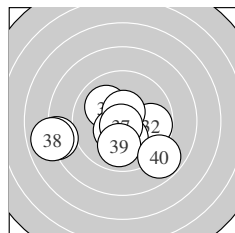

Serie 4:  
 10.0 ↖                      9.8 →                      10.2 \*                      8.1 ←                      10.5 \*  
 10.6 \*                      10.8 \*                      7.9 ←                      9.9 ↓                      8.8 ↘  
 beste Teiler 50.5 (37.) 96.5 (36.) 125.6 (35.)  
 Trefferlage 0.99 mm links, 1.10 mm tief  
 Streuwert 2.79, horizontal: 3.63, vertikal: 1.57

Unterschrift des Schützen

Meyton Elektronik

Ergebnis: **603.1** (581)  
 Serien: 99.3 101.7 102.6 100.6 98.7 100.2  
 Zähler: 42 17 1 0 0 0 0 0 0  
 Innenzehner: 30  
 weiteste: 521 (11), 494 (43), 475 (46)  
 beste Teiler 27.2 (56.) 38.0 (29.) 52.2 (19.)  
 Trefferlage 0.04 mm links, 0.08 mm tief  
 Streuwert 1.84, horizontal: 2.17, vertikal: 1.43

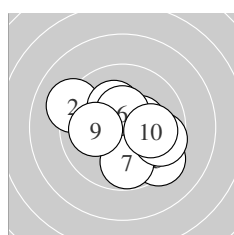
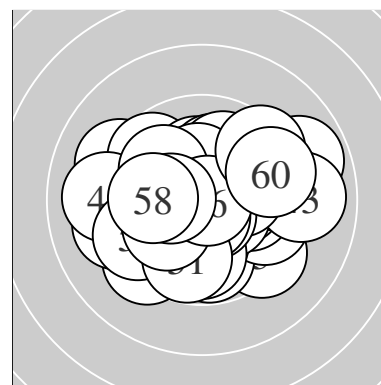

Serie 1:  
 10.4 \* 9.2 ↖ 10.2 \* 10.1 ↓ 9.4 ↘  
 10.5 \* 9.8 ↓ 9.6 → 10.1 ← 10.0 →  
 beste Teiler 120.0 (6.) 142.7 (1.) 180.0 (3.)  
 Trefferlage 0.35 mm rechts, 0.39 mm tief  
 Streuwert 2.03, horizontal: 2.30, vertikal: 1.71

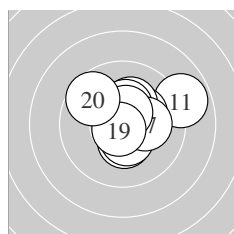

Serie 2:  
 8.9 → 10.4 \* 10.3 \* 10.2 \* 10.4 \*  
 10.4 \* 10.2 \* 10.5 \* 10.7 \* 9.7 ↖  
 beste Teiler 52.2 (19.) 101.3 (18.) 127.2 (15.)  
 Trefferlage 0.71 mm rechts, 0.60 mm hoch  
 Streuwert 1.60, horizontal: 1.86, vertikal: 1.30

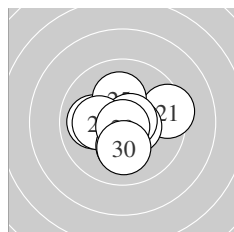

Serie 3:  
 9.4 → 10.5 \* 10.0 ← 10.5 \* 10.2 \*  
 10.7 \* 10.2 \* 10.2 \* 10.8 \* 10.1 ↓  
 beste Teiler 38.0 (29.) 64.3 (26.) 106.8 (22.)  
 Trefferlage 0.02 mm links, 0.18 mm tief  
 Streuwert 1.48, horizontal: 1.71, vertikal: 1.20

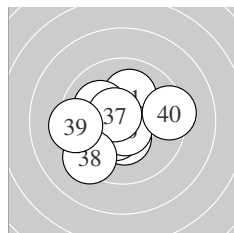

Serie 4:  
 10.1 ↑ 10.1 ↙ 10.4 \* 10.1 ↖ 10.5 \*  
 10.7 \* 10.6 \* 9.3 ↗ 9.4 ← 9.4 →  
 beste Teiler 67.6 (36.) 84.0 (37.) 123.4 (35.)  
 Trefferlage 0.67 mm links, 0.30 mm tief  
 Streuwert 1.82, horizontal: 2.14, vertikal: 1.44

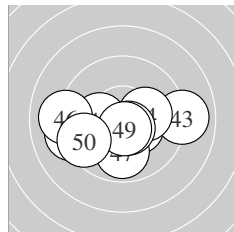

Serie 5:  
 10.2 \* 10.4 \* 9.0 → 10.2 \* 9.2 ←  
 9.1 ← 9.9 ↓ 10.6 \* 10.6 \* 9.5 ←  
 beste Teiler 82.5 (49.) 88.8 (48.) 137.0 (42.)  
 Trefferlage 0.55 mm links, 0.73 mm tief  
 Streuwert 2.23, horizontal: 3.00, vertikal: 0.97

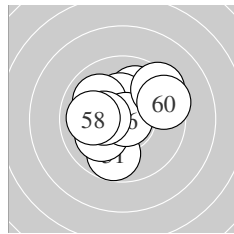

Serie 6:  
 9.8 ↓ 10.0 ↑ 10.3 \* 10.0 ↖ 10.1 ↙  
 10.8 \* 10.3 \* 10.0 ← 9.4 ↗ 9.5 →  
 beste Teiler 27.2 (56.) 156.1 (57.) 160.2 (53.)  
 Trefferlage 0.09 mm links, 0.50 mm hoch  
 Streuwert 1.86, horizontal: 2.03, vertikal: 1.66

Meyton Elektronik

**LG 60 ZR – Wertung – Männer**

StandNr: 113

**Insam,, Fabian** #70804040

**StartNr: 61**

4. Februar 2018 11:13

70804 / 0

---

\_\_\_\_\_  
Unterschrift des Schützen

Meyton Elektronik

Ergebnis:	<b>571.1</b>	(546)				
Serien:	96.3	91.1	97.0	94.7	96.8	95.2
Zähler:	19	33	4	3	1	0 0 0 0 0
Innenzehner:	12					
weiteste:	1055 (10), 939 (13), 799 (20)					
beste Teiler	53.0 (38.) 106.7 (26.) 122.8 (5.)					
Trefferlage	1.03 mm links, 0.92 mm tief					
Streuwert	2.74, horizontal: 3.26, vertikal: 2.08					

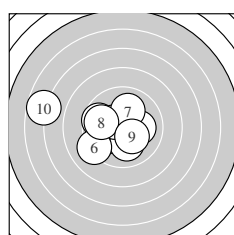
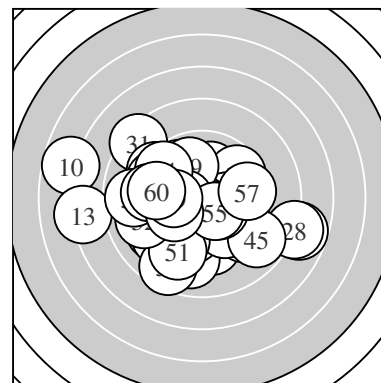

Serie 1:	9.8 ↙	9.7 ←	10.1 ↓	10.1 →	10.5 *
	9.2 ↙	10.1 ↑	9.8 ←	10.3 *	6.7 ←
beste Teiler	122.8 (5.) 171.1 (9.) 210.1 (4.)				
Trefferlage	1.87 mm links, 0.05 mm tief				
Streuwert	2.81, horizontal: 3.56, vertikal: 1.74				

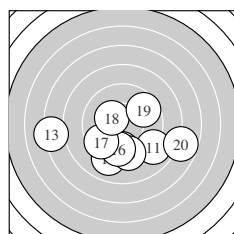

Serie 2:	9.0 ↘	9.0 ↓	7.2 ←	9.7 ↓	9.4 ↓
	9.6 ↓	9.5 ↙	10.3 *	9.6 ↗	7.8 →
beste Teiler	162.6 (18.) 321.1 (14.) 328.1 (16.)				
Trefferlage	0.09 mm links, 2.10 mm tief				
Streuwert	3.48, horizontal: 4.48, vertikal: 2.01				

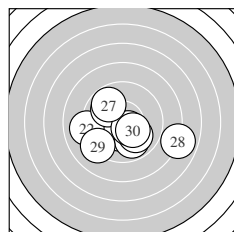

Serie 3:	10.3 *	9.1 ←	10.0 ↘	9.9 ↘	10.0 ↘
	10.5 *	9.8 ↘	7.9 →	9.2 ↙	10.3 *
beste Teiler	106.7 (26.) 159.4 (21.) 169.4 (30.)				
Trefferlage	0.00 mm , 0.99 mm tief				
Streuwert	2.64, horizontal: 3.30, vertikal: 1.73				

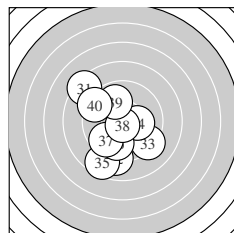

Serie 4:	8.3 ↘	9.0 ↓	9.2 ↘	10.2 *	8.6 ↓
	9.8 ↓	9.7 ↙	10.7 *	9.9 ↗	9.3 ↘
beste Teiler	53.0 (38.) 193.6 (34.) 266.2 (39.)				
Trefferlage	1.08 mm links, 1.00 mm tief				
Streuwert	2.86, horizontal: 2.46, vertikal: 3.21				

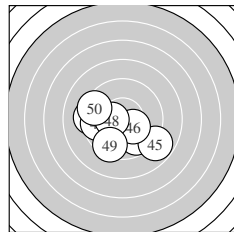

Serie 5:	10.3 *	9.5 ←	9.7 ↘	9.3 ←	8.8 ↘
	10.3 *	9.6 ←	10.4 *	9.5 ↓	9.4 ←
beste Teiler	140.1 (48.) 156.8 (41.) 168.2 (46.)				
Trefferlage	0.92 mm links, 0.98 mm tief				
Streuwert	2.31, horizontal: 2.86, vertikal: 1.58				

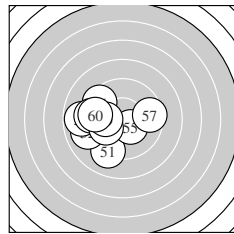

Serie 6:	9.1 ↓	9.0 ←	8.8 ←	9.5 ↘	10.4 *
	9.3 ←	9.5 →	10.0 ↙	10.1 ←	9.5 ←
beste Teiler	146.3 (55.) 222.0 (59.) 244.2 (58.)				
Trefferlage	2.22 mm links, 0.43 mm tief				
Streuwert	2.24, horizontal: 2.68, vertikal: 1.69				

Meyton Elektronik



**LG 60 ZR – Wertung – Junioren**

StandNr: 114

**Achenrainer,, Maximilian** #70504016

**StartNr: 62**

4. Februar 2018 10:46

70504 / 0

---

\_\_\_\_\_  
Unterschrift des Schützen

Meyton Elektronik

Ergebnis:	<b>617.5</b>	(590)
Serien:	102.4	104.7 104.4 102.7 100.3 103.0
Zähler:	50	10 0 0 0 0 0 0 0 0
Innenzehner:	43	
weiteste:	494 (46), 424 (58), 373 (2)	
beste Teiler	22.8 (55.)	29.1 (27.) 42.0 (14.)
Trefferlage	0.02 mm links, 0.61 mm hoch	
Streuwert	1.29, horizontal: 1.51, vertikal: 1.03	

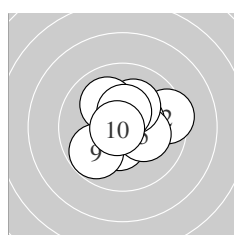
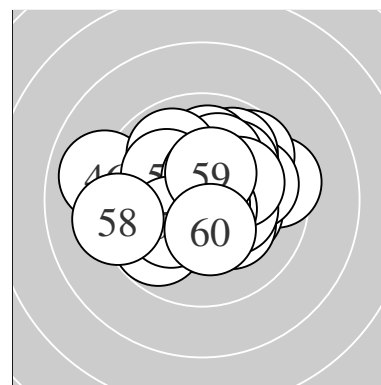

Serie 1:	10.4 *	9.5 →	10.6 *	10.4 *	10.2 *
	10.2 *	10.1 ↘	10.4 *	9.8 ✓	10.8 *
beste Teiler	45.7 (10.) 79.5 (3.) 126.6 (8.)				
Trefferlage	0.28 mm rechts, 0.28 mm hoch				
Streuwert	1.47, horizontal: 1.64, vertikal: 1.27				

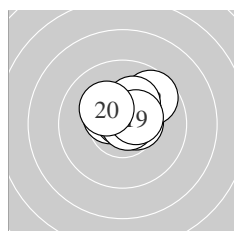

Serie 2:	10.5 *	9.7 ↗	10.7 *	10.8 *	10.5 *
	10.8 *	10.2 *	10.8 *	10.5 *	10.2 *
beste Teiler	42.0 (14.) 44.3 (18.) 47.0 (16.)				
Trefferlage	0.37 mm rechts, 0.79 mm hoch				
Streuwert	0.89, horizontal: 1.05, vertikal: 0.69				

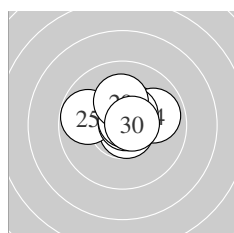

Serie 3:	10.7 *	10.7 *	10.4 *	9.9 →	9.8 ←
	10.5 *	10.8 *	10.8 *	10.2 *	10.6 *
beste Teiler	29.1 (27.) 45.7 (28.) 57.6 (21.)				
Trefferlage	0.25 mm rechts, 0.60 mm hoch				
Streuwert	1.05, horizontal: 1.33, vertikal: 0.64				

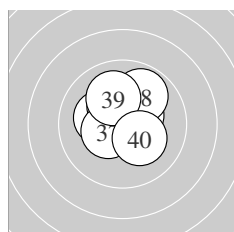

Serie 4:	10.5 *	10.3 *	10.4 *	10.2 *	10.3 *
	10.4 *	10.4 *	9.9 ↗	10.1 ↖	10.2 *
beste Teiler	109.4 (31.) 130.5 (37.) 134.3 (36.)				
Trefferlage	0.13 mm links, 0.82 mm hoch				
Streuwert	1.15, horizontal: 1.22, vertikal: 1.08				

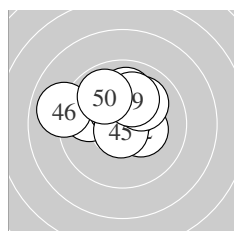

Serie 5:	9.8 ←	10.3 *	10.4 *	10.1 ↗	10.7 *
	9.0 ←	10.0 ↗	10.0 ↑	10.1 ↑	9.9 ↘
beste Teiler	54.5 (45.) 129.6 (43.) 156.6 (42.)				
Trefferlage	0.42 mm links, 1.21 mm hoch				
Streuwert	1.62, horizontal: 2.05, vertikal: 1.03				

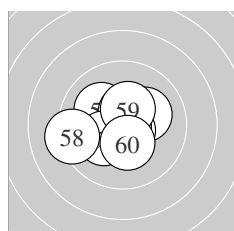

Serie 6:	10.2 *	10.7 *	10.4 *	10.1 ↘	10.9 *
	10.5 *	10.2 *	9.3 ←	10.4 *	10.3 *
beste Teiler	22.8 (55.) 63.6 (52.) 106.7 (56.)				
Trefferlage	0.52 mm links, 0.03 mm tief				
Streuwert	1.40, horizontal: 1.67, vertikal: 1.05				

Meyton Elektronik

**LG 60 ZR – Wertung – Junioren**

StandNr: 115

**Fankhauser,, Thomas** #70804016

**StartNr: 63**

4. Februar 2018 10:39

70804 / 0

---

\_\_\_\_\_  
Unterschrift des Schützen

Meyton Elektronik

Ergebnis: **405.3** (387)  
 Serien: 100.0 102.1 101.3 101.9  
 Zähler: 27 13 0 0 0 0 0 0 0 0  
 Innenzehner: 20  
 weiteste: 440 (6), 432 (33), 413 (24)  
 beste Teiler 5.0 (4.) 20.8 (30.) 27.2 (11.)  
 Trefferlage 0.27 mm rechts, 0.94 mm hoch  
 Streuwert 1.50, horizontal: 1.76, vertikal: 1.19

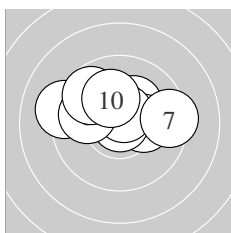
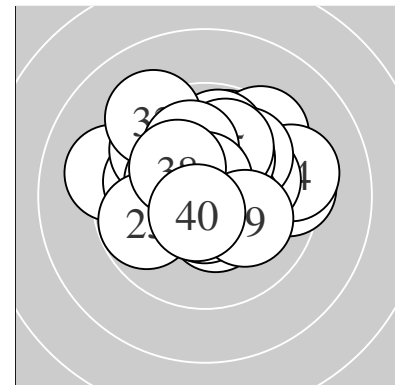

Serie 1:  
 10.2 \*                      10.2 \*                      9.8 ↘                      10.9 \*                      10.6 \*  
 9.2 ←                      9.4 →                      9.9 ←                      9.7 ↘                      10.1 ↑  
 beste Teiler 5.0 (4.) 81.9 (5.) 178.6 (1.)  
 Trefferlage 0.47 mm links, 1.02 mm hoch  
 Streuwert 1.79, horizontal: 2.41, vertikal: 0.79

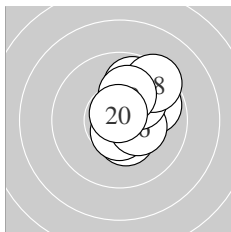

Serie 2:  
 10.8 \*                      9.8 ↗                      10.4 \*                      9.8 ↑                      10.6 \*  
 10.4 \*                      10.1 ↗                      9.4 ↗                      10.1 ↑                      10.7 \*  
 beste Teiler 27.2 (11.) 51.9 (20.) 88.0 (15.)  
 Trefferlage 1.01 mm rechts, 0.81 mm hoch  
 Streuwert 1.24, horizontal: 0.98, vertikal: 1.46

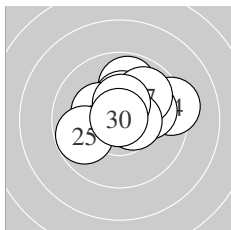

Serie 3:  
 9.9 ↑                      10.3 \*                      10.3 \*                      9.3 →                      9.8 ←  
 10.0 →                      9.9 ↗                      10.5 \*                      10.4 \*                      10.9 \*  
 beste Teiler 20.8 (30.) 104.2 (28.) 130.7 (29.)  
 Trefferlage 0.57 mm rechts, 0.89 mm hoch  
 Streuwert 1.54, horizontal: 1.89, vertikal: 1.08

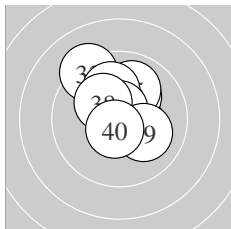

Serie 4:  
 10.5 \*                      10.4 \*                      9.2 ↘                      10.2 \*                      10.0 ↑  
 10.0 ↑                      10.7 \*                      10.2 \*                      10.1 ↘                      10.6 \*  
 beste Teiler 73.1 (37.) 86.7 (40.) 120.2 (31.)  
 Trefferlage 0.03 mm links, 1.06 mm hoch  
 Streuwert 1.40, horizontal: 1.31, vertikal: 1.48

Unterschrift des Schützen

Meyton Elektronik

Ergebnis: **389.1** (375)  
 Serien: 94.8 98.0 98.1 98.2  
 Zähler: 19 18 2 1 0 0 0 0 0 0  
 Innenzehner: 9  
 weiteste: 836 (1), 628 (10), 567 (5)  
 beste Teiler 65.5 (15.) 93.4 (39.) 110.5 (3.)  
 Trefferlage 0.45 mm rechts, 0.23 mm hoch  
 Streuwert 2.45, horizontal: 3.12, vertikal: 1.50

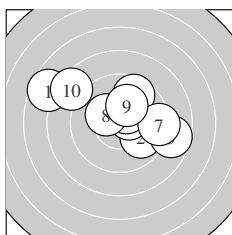
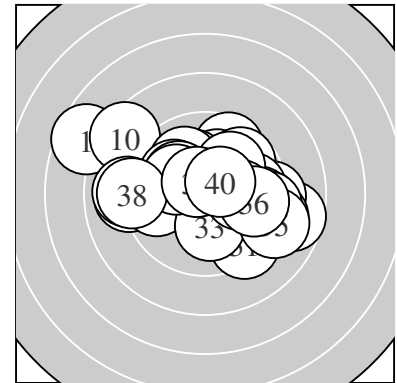

Serie 1:  
 7.6 ↘ 9.9 ↘ 10.5 \* 9.6 ↗ 8.7 →  
 10.4 \* 9.3 → 10.3 \* 10.1 ↗ 8.4 ↖  
 beste Teiler 110.5 (3.) 133.4 (6.) 167.5 (8.)  
 Trefferlage 0.18 mm rechts, 1.13 mm hoch  
 Streuwert 3.11, horizontal: 3.99, vertikal: 1.87

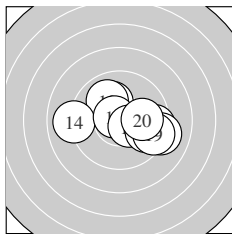

Serie 2:  
 10.1 ↖ 10.0 ↖ 9.5 → 9.0 ← 10.7 \*  
 10.5 \* 9.7 ↘ 9.1 → 9.4 → 10.0 →  
 beste Teiler 65.5 (15.) 119.5 (16.) 204.8 (11.)  
 Trefferlage 1.04 mm rechts, 0.11 mm tief  
 Streuwert 2.25, horizontal: 2.91, vertikal: 1.26

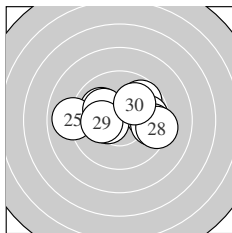

Serie 3:  
 9.7 ↗ 9.8 → 10.4 \* 10.0 ↖ 9.0 ←  
 10.1 ↖ 9.6 → 9.3 → 10.2 \* 10.0 ↗  
 beste Teiler 127.8 (23.) 190.8 (29.) 203.2 (26.)  
 Trefferlage 0.24 mm rechts, 0.49 mm hoch  
 Streuwert 2.22, horizontal: 2.98, vertikal: 0.98

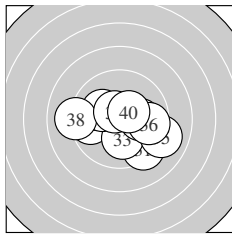

Serie 4:  
 9.3 ↘ 9.7 ← 10.1 ↓ 10.1 → 9.0 →  
 9.7 → 10.1 ↖ 9.1 ← 10.6 \* 10.5 \*  
 beste Teiler 93.4 (39.) 124.4 (40.) 205.7 (37.)  
 Trefferlage 0.34 mm rechts, 0.55 mm tief  
 Streuwert 2.27, horizontal: 2.90, vertikal: 1.38

Unterschrift des Schützen

Ergebnis: **390.7** (373)  
 Serien: 98.5 98.9 97.0 96.3  
 Zähler: 16 21 3 0 0 0 0 0 0 0  
 Innenzehner: 11  
 weiteste: 707 (21), 671 (37), 587 (31)  
 beste Teiler 13.6 (18.) 99.4 (16.) 106.7 (28.)  
 Trefferlage 0.05 mm links, 0.61 mm tief  
 Streuwert 2.35, horizontal: 2.79, vertikal: 1.80

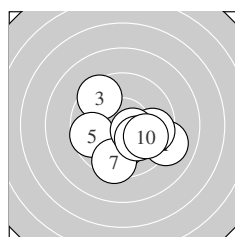
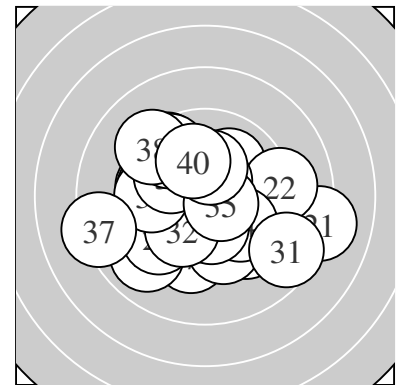

Serie 1:  
 9.1 → 10.3 \* 9.5 ↘ 10.1 ↓ 9.7 ←  
 9.7 → 9.5 ↓ 10.5 \* 10.2 \* 9.9 →  
 beste Teiler 114.0 (8.) 165.8 (2.) 195.2 (9.)  
 Trefferlage 0.71 mm rechts, 1.01 mm tief  
 Streuwert 2.00, horizontal: 2.32, vertikal: 1.62

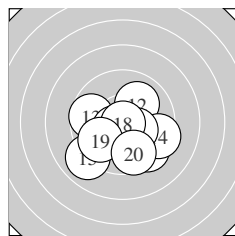

Serie 2:  
 9.5 ↘ 10.0 ↗ 9.7 ← 9.4 → 9.0 ↙  
 10.6 \* 10.3 \* 10.9 \* 9.8 ↗ 9.7 ↓  
 beste Teiler 13.6 (18.) 99.4 (16.) 152.9 (17.)  
 Trefferlage 0.02 mm rechts, 1.16 mm tief  
 Streuwert 2.07, horizontal: 2.40, vertikal: 1.69

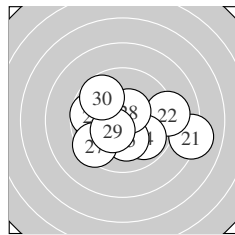

Serie 3:  
 8.1 → 9.1 → 9.9 ↙ 9.9 ↘ 10.2 \*  
 9.7 ← 9.5 ↗ 10.5 \* 10.4 \* 9.7 ↘  
 beste Teiler 106.7 (28.) 142.8 (29.) 190.0 (25.)  
 Trefferlage 0.32 mm rechts, 0.56 mm tief  
 Streuwert 2.59, horizontal: 3.33, vertikal: 1.54

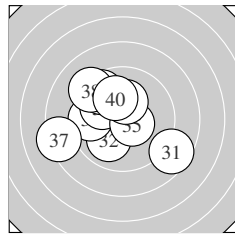

Serie 4:  
 8.6 ↘ 10.0 ↙ 9.7 ← 10.0 ↘ 10.5 \*  
 9.6 ↘ 8.3 ← 9.2 ↘ 10.3 \* 10.1 ↗  
 beste Teiler 106.8 (35.) 174.7 (39.) 222.0 (40.)  
 Trefferlage 1.29 mm links, 0.29 mm hoch  
 Streuwert 2.62, horizontal: 3.00, vertikal: 2.18

Unterschrift des Schützen

Meyton Elektronik

Ergebnis: **376.9** (355)  
 Serien: 93.4 94.4 95.9 93.2  
 Zähler: 9 21 6 4 0 0 0 0 0 0  
 Innenzehner: 6  
 weiteste: 932 (3), 797 (11), 770 (32)  
 beste Teiler 56.6 (2.) 70.3 (5.) 147.1 (18.)  
 Trefferlage 0.79 mm rechts, 0.15 mm hoch  
 Streuwert 3.02, horizontal: 3.69, vertikal: 2.15

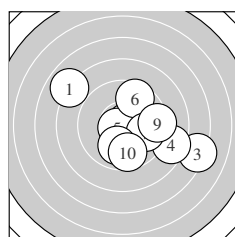
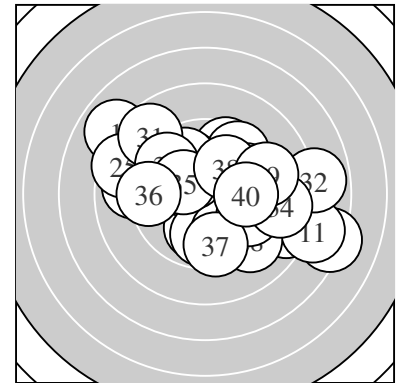

Serie 1:  
 7.9 ↘ 10.7 \* 7.2 → 8.5 → 10.7 \*  
 9.6 ↗ 9.8 → 10.0 ↓ 9.3 → 9.7 ↓  
 beste Teiler 56.6 (2.) 70.3 (5.) 244.5 (8.)  
 Trefferlage 1.61 mm rechts, 0.39 mm tief  
 Streuwert 3.40, horizontal: 4.06, vertikal: 2.56

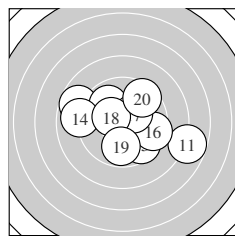

Serie 2:  
 7.8 → 8.7 ← 9.9 ↘ 8.9 ← 9.6 ↓  
 9.5 → 10.3 \* 10.4 \* 9.8 ↓ 9.5 ↗  
 beste Teiler 147.1 (18.) 159.6 (17.) 265.1 (13.)  
 Trefferlage 0.34 mm rechts, 0.00 mm  
 Streuwert 3.13, horizontal: 3.89, vertikal: 2.12

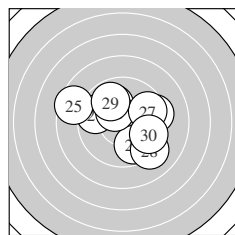

Serie 3:  
 9.6 ← 10.0 ↘ 9.8 ↓ 9.4 → 8.5 ←  
 10.4 \* 9.7 → 9.1 ↘ 9.8 ↘ 9.6 →  
 beste Teiler 148.2 (26.) 230.4 (22.) 278.3 (29.)  
 Trefferlage 0.19 mm rechts, 0.35 mm hoch  
 Streuwert 2.65, horizontal: 3.16, vertikal: 2.03

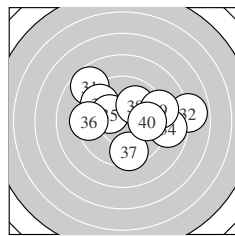

Serie 4:  
 8.7 ↘ 7.9 → 9.6 ↘ 8.8 → 10.3 \*  
 9.4 ← 9.5 ↓ 10.0 ↗ 9.2 → 9.8 →  
 beste Teiler 171.8 (35.) 237.8 (38.) 287.0 (40.)  
 Trefferlage 1.03 mm rechts, 0.67 mm hoch  
 Streuwert 3.17, horizontal: 4.01, vertikal: 2.01

Unterschrift des Schützen

Meyton Elektronik

Ergebnis: **401.6** (382)  
 Serien: 100.5 100.2 99.3 101.6  
 Zähler: 23 16 1 0 0 0 0 0 0 0  
 Innenzehner: 21  
 weiteste: 587 (22), 474 (30), 462 (20)  
 beste Teiler 52.6 (4.) 55.6 (24.) 84.0 (13.)  
 Trefferlage 0.18 mm rechts, 0.21 mm hoch  
 Streuwert 1.90, horizontal: 2.20, vertikal: 1.54

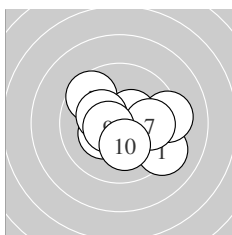
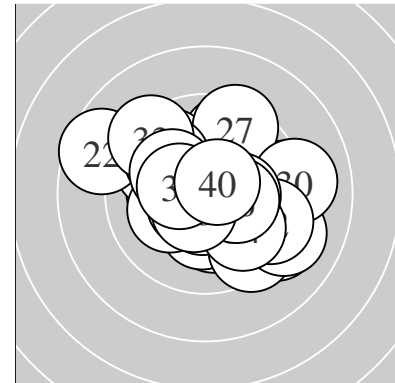

Serie 1:  
 9.2 ↘ 10.3 \* 9.3 → 10.7 \* 9.6 ↖  
 10.5 \* 9.9 → 10.3 \* 10.5 \* 10.2 \*  
 beste Teiler 52.6 (4.) 102.4 (9.) 122.8 (6.)  
 Trefferlage 0.50 mm rechts, 0.11 mm tief  
 Streuwert 1.90, horizontal: 2.32, vertikal: 1.35

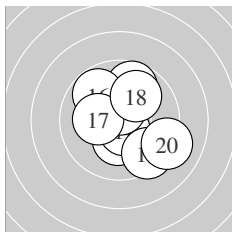

Serie 2:  
 9.7 ↗ 10.3 \* 10.6 \* 10.6 \* 10.6 \*  
 9.8 ↘ 10.2 \* 9.9 ↗ 9.4 ↘ 9.1 ↘  
 beste Teiler 84.0 (13.) 94.1 (15.) 96.6 (14.)  
 Trefferlage 0.52 mm rechts, 0.15 mm hoch  
 Streuwert 1.92, horizontal: 1.85, vertikal: 1.99

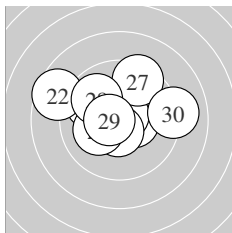

Serie 3:  
 9.8 ↘ 8.6 ↘ 10.5 \* 10.7 \* 10.6 \*  
 10.1 ↙ 9.4 ↗ 9.9 ↘ 10.6 \* 9.1 →  
 beste Teiler 55.6 (24.) 90.0 (29.) 96.8 (25.)  
 Trefferlage 0.49 mm links, 0.81 mm hoch  
 Streuwert 2.18, horizontal: 2.74, vertikal: 1.42

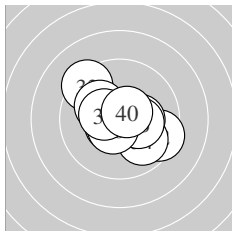

Serie 4:  
 10.6 \* 9.5 ↘ 9.3 ↘ 9.9 ↘ 10.3 \*  
 10.3 \* 10.1 ↘ 10.6 \* 10.4 \* 10.6 \*  
 beste Teiler 89.1 (40.) 97.9 (31.) 99.6 (38.)  
 Trefferlage 0.21 mm rechts, 0.01 mm hoch  
 Streuwert 1.70, horizontal: 1.98, vertikal: 1.37

Unterschrift des Schützen

Meyton Elektronik



Ergebnis: **369.7** (351)  
 Serien: 90.7 93.3 92.8 92.9  
 Zähler: 10 17 7 6 0 0 0 0 0 0  
 Innenzehner: 7  
 weiteste: 976 (3), 905 (9), 839 (12)  
 beste Teiler 36.4 (37.) 83.7 (19.) 118.2 (28.)  
 Trefferlage 1.34 mm links, 0.15 mm tief  
 Streuwert 3.38, horizontal: 4.01, vertikal: 2.61

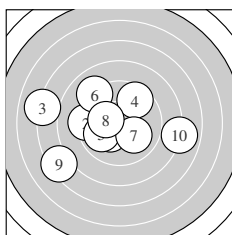
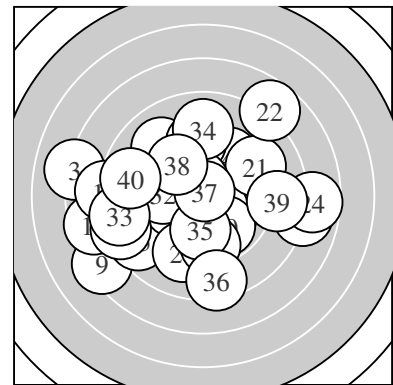

Serie 1:  
 10.3 \*                      9.3 ←                      7.0 ←                      9.6 ↗                      9.9 ↙  
 9.1 ↘                      10.0 ↘                      10.3 \*                      7.3 ↙                      7.9 →  
 beste Teiler 175.6 (8.) 175.8 (1.) 230.0 (7.)  
 Trefferlage 1.83 mm links, 0.16 mm tief  
 Streuwert 3.88, horizontal: 4.86, vertikal: 2.54

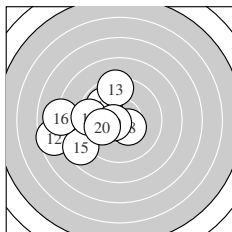

Serie 2:  
 9.9 ↘                      7.6 ←                      9.4 ↑                      9.4 ←                      8.6 ↙  
 8.0 ←                      9.4 ←                      10.4 \*                      10.6 \*                      10.0 ←  
 beste Teiler 83.7 (19.) 137.2 (18.) 230.4 (20.)  
 Trefferlage 3.21 mm links, 0.09 mm tief  
 Streuwert 2.52, horizontal: 2.95, vertikal: 2.00

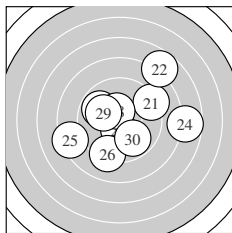

Serie 3:  
 9.2 ↗                      7.7 ↗                      10.5 \*                      7.7 →                      8.3 ←  
 9.2 ↓                      9.8 ↘                      10.5 \*                      10.1 ↖                      9.8 ↘  
 beste Teiler 118.2 (28.) 118.5 (23.) 218.9 (29.)  
 Trefferlage 0.61 mm rechts, 0.14 mm hoch  
 Streuwert 3.61, horizontal: 4.15, vertikal: 2.97

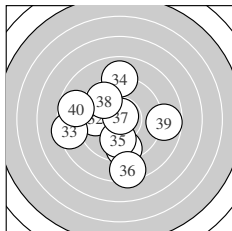

Serie 4:  
 9.5 ↓                      9.8 ←                      8.4 ←                      9.0 ↑                      9.9 ↓  
 8.4 ↓                      10.8 \*                      9.7 ↘                      8.7 →                      8.7 ←  
 beste Teiler 36.4 (37.) 251.7 (35.) 298.4 (32.)  
 Trefferlage 0.95 mm links, 0.51 mm tief  
 Streuwert 3.28, horizontal: 3.38, vertikal: 3.18

Unterschrift des Schützen

Meyton Elektronik

Ergebnis: **389.6** (370)  
 Serien: 96.6 97.5 96.8 98.7  
 Zähler: 17 16 7 0 0 0 0 0 0 0  
 Innenzehner: 12  
 weiteste: 693 (28), 613 (3), 591 (10)  
 beste Teiler 28.8 (35.) 62.1 (16.) 112.0 (2.)  
 Trefferlage 0.00 mm , 0.15 mm hoch  
 Streuwert 2.44, horizontal: 2.43, vertikal: 2.46

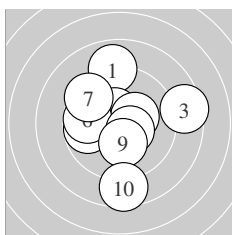
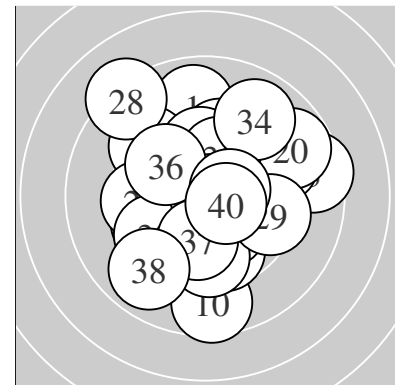

Serie 1:  
 8.9 ↑                      10.5 \*                      8.5 →                      10.3 \*                      9.8 ←  
 9.8 ←                      9.5 ↘                      10.5 \*                      10.2 \*                      8.6 ↓  
 beste Teiler 112.0 (2.) 116.7 (8.) 153.2 (4.)  
 Trefferlage 0.08 mm links, 0.18 mm hoch  
 Streuwert 2.77, horizontal: 2.69, vertikal: 2.84

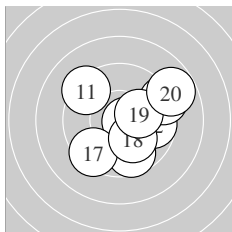

Serie 2:  
 9.3 ↘                      9.7 →                      9.2 →                      9.7 ↓                      10.4 \*  
 10.7 \*                      9.4 ↙                      10.1 ↓                      10.2 \*                      8.8 →  
 beste Teiler 62.1 (16.) 129.0 (15.) 187.8 (19.)  
 Trefferlage 1.23 mm rechts, 0.03 mm tief  
 Streuwert 2.31, horizontal: 2.51, vertikal: 2.09

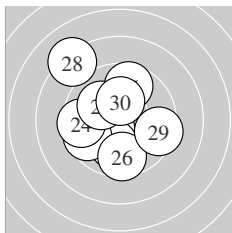

Serie 3:  
 10.5 \*                      10.0 ↓                      9.6 ←                      9.5 ←                      9.7 ↑  
 9.6 ↓                      10.1 ↘                      8.2 ↘                      9.4 →                      10.2 \*  
 beste Teiler 118.1 (21.) 176.1 (30.) 216.9 (27.)  
 Trefferlage 0.92 mm links, 0.23 mm hoch  
 Streuwert 2.51, horizontal: 2.35, vertikal: 2.66

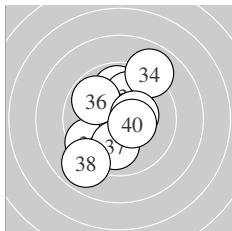

Serie 4:  
 9.9 ↑                      9.5 ↙                      10.0 ↑                      8.9 ↗                      10.8 \*  
 9.8 ↘                      10.0 ↓                      8.9 ↙                      10.4 \*                      10.5 \*  
 beste Teiler 28.8 (35.) 123.3 (40.) 142.3 (39.)  
 Trefferlage 0.23 mm links, 0.21 mm hoch  
 Streuwert 2.28, horizontal: 1.93, vertikal: 2.57

Unterschrift des Schützen

Meyton Elektronik

Ergebnis:	<b>397.7</b>	(378)
Serien:	98.0	99.8 98.7 101.2
Zähler:	21	17 1 1 0 0 0 0 0 0
Innenzehner:	18	
weiteste:	877 (23),	651 (26), 494 (31)
beste Teiler	8.5 (33.)	51.1 (24.) 58.4 (29.)
Trefferlage	0.08 mm links, 0.15 mm hoch	
Streuwert	2.19, horizontal: 2.66, vertikal: 1.60	

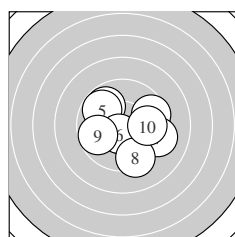
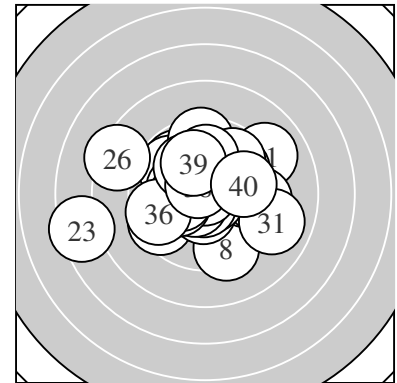

Serie 1:	9.8 ↘	9.6 →	10.5 *	9.6 →	9.8 ↘
	10.5 *	9.3 →	9.4 ↓	9.7 ←	9.8 →
beste Teiler	106.2 (6.) 125.9 (3.) 282.0 (10.)				
Trefferlage	0.77 mm rechts, 0.38 mm tief				
Streuwert	2.19, horizontal: 2.58, vertikal: 1.73				

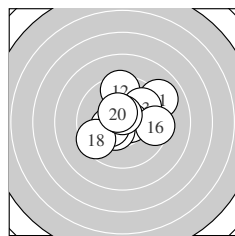

Serie 2:	9.0 ↗	9.5 ↑	9.9 ↗	10.6 *	10.4 *
	9.5 →	10.3 *	9.5 ↖	10.6 *	10.5 *
beste Teiler	82.0 (19.) 84.3 (14.) 122.5 (20.)				
Trefferlage	0.46 mm rechts, 0.59 mm hoch				
Streuwert	2.01, horizontal: 2.27, vertikal: 1.72				

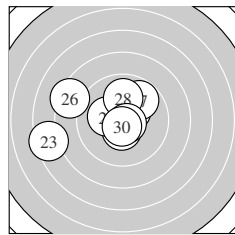

Serie 3:	10.4 *	10.5 *	7.4 ←	10.7 *	10.2 *
	8.3 ↖	9.8 ↗	10.0 ↑	10.7 *	10.7 *
beste Teiler	51.1 (24.) 58.4 (29.) 72.4 (30.)				
Trefferlage	1.30 mm links, 0.34 mm hoch				
Streuwert	2.62, horizontal: 3.31, vertikal: 1.68				

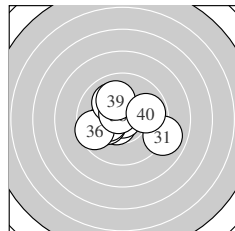

Serie 4:	9.0 →	10.6 *	10.9 *	10.2 *	10.3 *
	9.6 ←	10.1 ↘	10.6 *	10.0 ↑	9.9 →
beste Teiler	8.5 (33.) 76.0 (38.) 98.2 (32.)				
Trefferlage	0.28 mm links, 0.05 mm hoch				
Streuwert	1.85, horizontal: 2.28, vertikal: 1.29				

Unterschrift des Schützen

Ergebnis: **372.2** (354)  
 Serien: 94.8 88.3 95.3 93.8  
 Zähler: 9 21 7 1 2 0 0 0 0 0  
 Innenzehner: 6  
 weiteste: 1152 (11), 1029 (20), 823 (36)  
 beste Teiler 53.8 (17.) 67.2 (39.) 90.9 (9.)  
 Trefferlage 0.28 mm rechts, 1.31 mm hoch  
 Streuwert 3.25, horizontal: 3.95, vertikal: 2.36

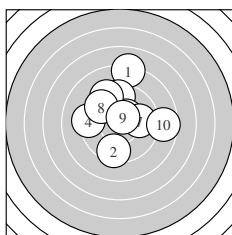
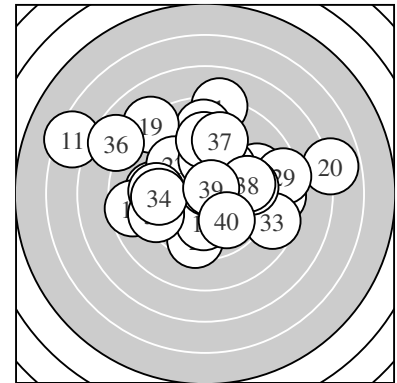

Serie 1:  
 8.1 ↑                      9.4 ↓                      9.5 ↑                      9.3 ←                      10.4 \*  
 9.4 ↘                      9.9 →                      9.6 ↘                      10.6 \*                      8.6 →  
 beste Teiler 90.9 (9.) 132.3 (5.) 264.9 (7.)  
 Trefferlage 0.16 mm rechts, 1.48 mm hoch  
 Streuwert 2.82, horizontal: 2.79, vertikal: 2.84

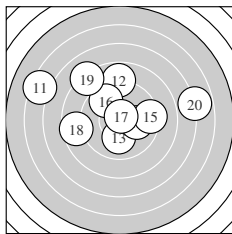

Serie 2:  
 6.3 ↖                      8.8 ↑                      10.0 ↓                      10.0 →                      9.3 →  
 9.7 ↘                      10.7 \*                      8.6 ←                      8.1 ↘                      6.8 →  
 beste Teiler 53.8 (17.) 227.2 (13.) 230.2 (14.)  
 Trefferlage 0.62 mm links, 1.72 mm hoch  
 Streuwert 4.45, horizontal: 5.67, vertikal: 2.73

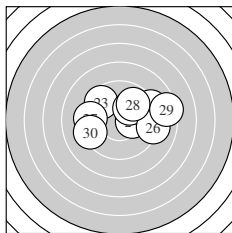

Serie 3:  
 10.2 \*                      9.1 →                      9.6 ↘                      10.3 \*                      10.1 ↗  
 9.1 →                      9.4 ←                      9.8 ↗                      8.4 →                      9.3 ←  
 beste Teiler 168.9 (24.) 192.8 (21.) 206.5 (25.)  
 Trefferlage 1.11 mm rechts, 0.76 mm hoch  
 Streuwert 2.67, horizontal: 3.53, vertikal: 1.35

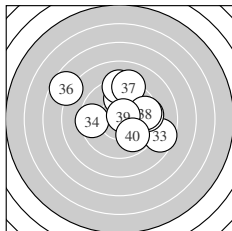

Serie 4:  
 9.9 ↑                      9.2 ↑                      8.6 ↘                      9.5 ←                      9.5 →  
 7.7 ↖                      9.2 ↑                      9.6 →                      10.7 \*                      9.9 ↘  
 beste Teiler 67.2 (39.) 271.2 (31.) 273.4 (40.)  
 Trefferlage 0.50 mm rechts, 1.27 mm hoch  
 Streuwert 3.13, horizontal: 3.67, vertikal: 2.48

Unterschrift des Schützen

Meyton Elektronik

Ergebnis: **375.1** (356)  
 Serien: 91.7 94.4 93.4 95.6  
 Zähler: 12 16 9 2 1 0 0 0 0 0  
 Innenzehner: 7  
 weiteste: 1121 (4), 947 (20), 782 (24)  
 beste Teiler 46.3 (17.) 81.3 (32.) 102.2 (25.)  
 Trefferlage 0.45 mm rechts, 0.25 mm tief  
 Streuwert 3.24, horizontal: 4.10, vertikal: 2.03

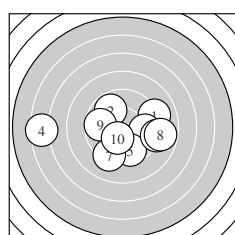
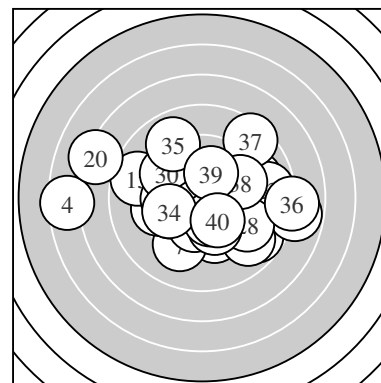

Serie 1:  
 9.1 → 9.8 ↘ 9.7 → 6.5 ← 9.6 ↓  
 9.0 → 9.2 ↓ 8.8 → 9.7 ← 10.3 \*  
 beste Teiler 165.5 (10.) 286.9 (2.) 309.8 (9.)  
 Trefferlage 0.00 mm , 0.72 mm tief  
 Streuwert 3.76, horizontal: 4.96, vertikal: 1.91

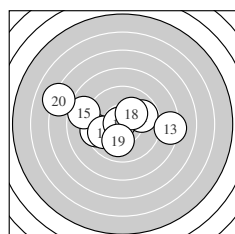

Serie 2:  
 9.8 → 9.4 ← 8.3 → 10.2 \* 8.7 ←  
 9.8 ← 10.8 \* 10.2 \* 10.0 ↓ 7.2 ←  
 beste Teiler 46.3 (17.) 188.5 (14.) 191.0 (18.)  
 Trefferlage 1.22 mm links, 0.14 mm hoch  
 Streuwert 3.28, horizontal: 4.30, vertikal: 1.73

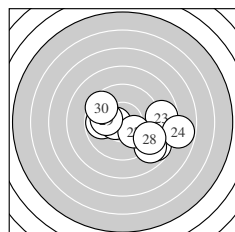

Serie 3:  
 8.8 ↘ 9.8 ← 8.8 → 7.8 → 10.5 \*  
 8.9 ↘ 10.1 ↘ 9.2 ↘ 10.0 ← 9.5 ↘  
 beste Teiler 102.2 (25.) 207.2 (27.) 228.5 (29.)  
 Trefferlage 1.77 mm rechts, 0.84 mm tief  
 Streuwert 2.97, horizontal: 3.83, vertikal: 1.75

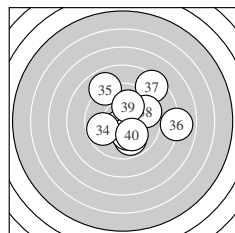

Serie 4:  
 9.9 ↓ 10.6 \* 10.2 \* 9.8 ← 8.9 ↘  
 8.0 → 8.5 ↗ 9.6 → 10.1 ↑ 10.0 ↓  
 beste Teiler 81.3 (32.) 189.4 (33.) 219.2 (39.)  
 Trefferlage 1.29 mm rechts, 0.41 mm hoch  
 Streuwert 2.83, horizontal: 3.03, vertikal: 2.62

Unterschrift des Schützen

Meyton Elektronik

Ergebnis: **378.1** (361)  
 Serien: 96.6 93.8 93.4 94.3  
 Zähler: 10 22 7 1 0 0 0 0 0 0  
 Innenzehner: 4  
 weiteste: 898 (34), 739 (10), 647 (15)  
 beste Teiler 10.8 (1.) 154.8 (6.) 184.9 (40.)  
 Trefferlage 0.49 mm links, 0.02 mm hoch  
 Streuwert 2.94, horizontal: 2.76, vertikal: 3.12

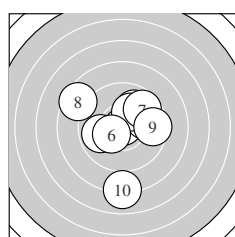
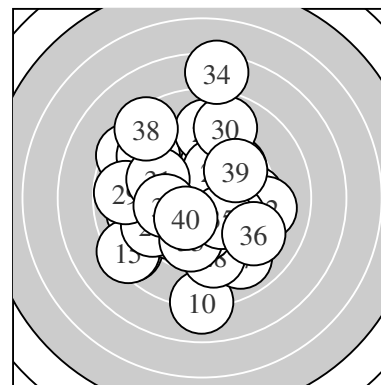

Serie 1:  
 10.9 \*                      9.8 →                      9.9 ↗                      9.9 ←                      10.1 ↗  
 10.3 \*                      9.7 ↗                      8.5 ↘                      9.5 →                      8.0 ↓  
 beste Teiler 10.8 (1.) 154.8 (6.) 201.2 (5.)  
 Trefferlage 0.16 mm rechts, 0.10 mm hoch  
 Streuwert 2.81, horizontal: 2.67, vertikal: 2.94

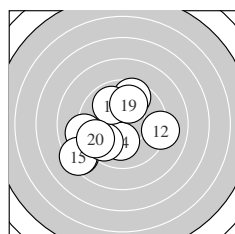

Serie 2:  
 8.4 ↙                      9.1 →                      9.1 ←                      10.1 ↓                      8.4 ↙  
 9.6 ↗                      9.7 ↙                      9.9 ↘                      10.0 ↗                      9.5 ↙  
 beste Teiler 204.4 (14.) 247.4 (19.) 259.1 (18.)  
 Trefferlage 1.55 mm links, 0.73 mm tief  
 Streuwert 2.84, horizontal: 3.13, vertikal: 2.51

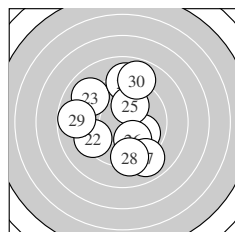

Serie 3:  
 9.9 ↘                      9.4 ↙                      9.0 ↘                      9.0 ↑                      10.1 ↗  
 10.0 ↓                      9.0 ↓                      9.3 ↓                      8.8 ←                      8.9 ↗  
 beste Teiler 214.8 (25.) 237.9 (26.) 258.6 (21.)  
 Trefferlage 0.29 mm links, 0.14 mm hoch  
 Streuwert 3.14, horizontal: 2.86, vertikal: 3.40

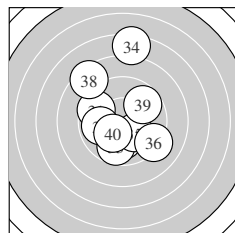

Serie 4:  
 9.6 ↘                      10.0 ↓                      9.7 ↓                      7.4 ↑                      10.2 \*  
 9.2 ↘                      9.9 ←                      8.4 ↘                      9.7 ↗                      10.2 \*  
 beste Teiler 184.9 (40.) 195.1 (35.) 226.1 (32.)  
 Trefferlage 0.31 mm links, 0.59 mm hoch  
 Streuwert 3.21, horizontal: 2.48, vertikal: 3.81

Unterschrift des Schützen

Meyton Elektronik

Ergebnis: **192.6** (185)  
 Serien: 97.9 94.7  
 Zähler: 9 8 2 1 0 0 0 0 0 0  
 Innenzehner: 7  
 weiteste: 857 (8), 642 (18), 539 (19)  
 beste Teiler 48.9 (4.) 70.6 (20.) 123.8 (10.)  
 Trefferlage 0.95 mm links, 1.05 mm hoch  
 Streuwert 2.62, horizontal: 3.45, vertikal: 1.37

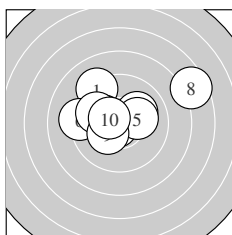
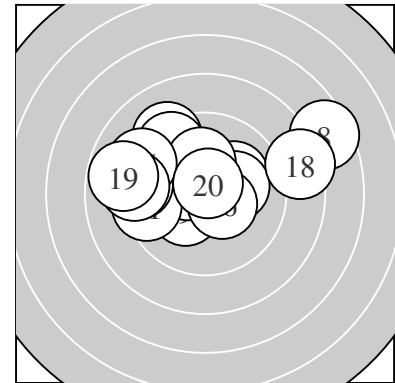

Serie 1:  
 9.2 ↘                      10.2 \*                      10.1 ↗                      10.8 \*                      10.2 \*  
 9.2 ←                      9.9 ↖                      7.5 ↗                      10.3 \*                      10.5 \*  
 beste Teiler 48.9 (4.) 123.8 (10.) 167.2 (9.)  
 Trefferlage 0.21 mm links, 1.05 mm hoch  
 Streuwert 2.63, horizontal: 3.37, vertikal: 1.57

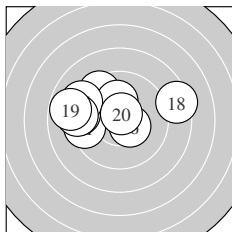

Serie 2:  
 9.4 ←                      9.5 ↘                      9.2 ←                      10.1 ↑                      9.1 ↖  
 10.4 \*                      9.1 ←                      8.4 →                      8.8 ←                      10.7 \*  
 beste Teiler 70.6 (20.) 128.6 (16.) 205.7 (14.)  
 Trefferlage 1.70 mm links, 1.05 mm hoch  
 Streuwert 2.65, horizontal: 3.54, vertikal: 1.22

Unterschrift des Schützen

Ergebnis: **404.2** (388)  
 Serien: 99.1 101.4 104.5 99.2  
 Zähler: 29 10 1 0 0 0 0 0 0  
 Innenzehner: 21  
 weiteste: 578 (8), 466 (35), 413 (31)  
 beste Teiler 40.2 (21.) 43.3 (30.) 50.9 (23.)  
 Trefferlage 0.30 mm rechts, 0.19 mm tief  
 Streuwert 1.73, horizontal: 1.32, vertikal: 2.05

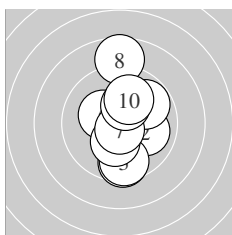
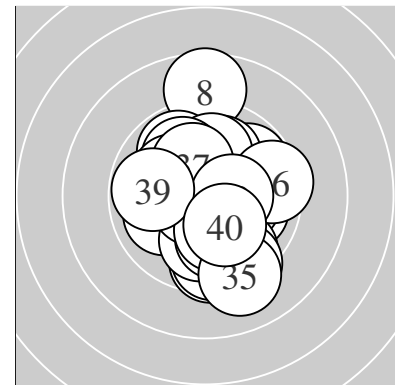

Serie 1:  
 9.5 ↓                      10.0 →                      9.6 ↓                      9.8 ↗                      10.3 \*  
 10.3 \*                      10.7 \*                      8.6 ↑                      10.3 \*                      10.0 ↑  
 beste Teiler 56.0 (7.) 167.6 (9.) 167.7 (5.)  
 Trefferlage 0.48 mm rechts, 0.20 mm hoch  
 Streuwert 2.15, horizontal: 1.16, vertikal: 2.82

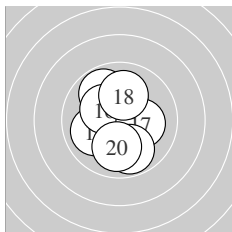

Serie 2:  
 10.5 \*                      10.2 \*                      10.6 \*                      9.8 ↖                      10.0 ←  
 10.3 \*                      10.2 \*                      10.0 ↑                      9.8 ↓                      10.0 ↓  
 beste Teiler 99.7 (13.) 119.5 (11.) 168.8 (16.)  
 Trefferlage 0.12 mm links, 0.33 mm hoch  
 Streuwert 1.56, horizontal: 1.23, vertikal: 1.84

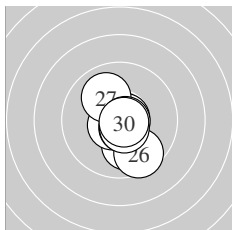

Serie 3:  
 10.8 \*                      10.0 ↓                      10.8 \*                      10.6 \*                      10.6 \*  
 9.6 ↓                      10.0 ↖                      10.7 \*                      10.6 \*                      10.8 \*  
 beste Teiler 40.2 (21.) 43.3 (30.) 50.9 (23.)  
 Trefferlage 0.22 mm rechts, 0.51 mm tief  
 Streuwert 1.13, horizontal: 0.81, vertikal: 1.37

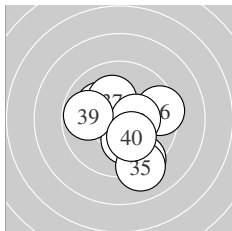

Serie 4:  
 9.3 ↓                      10.1 ↖                      10.4 \*                      10.2 \*                      9.1 ↓  
 9.5 →                      10.2 \*                      10.4 \*                      9.8 ←                      10.2 \*  
 beste Teiler 130.6 (33.) 146.0 (38.) 184.9 (37.)  
 Trefferlage 0.64 mm rechts, 0.81 mm tief  
 Streuwert 1.96, horizontal: 1.91, vertikal: 2.01

Unterschrift des Schützen

Meyton Elektronik



Ergebnis: **378.3** (359)  
 Serien: 93.1 90.2 97.0 98.0  
 Zähler: 11 20 7 1 1 0 0 0 0 0  
 Innenzehner: 7  
 weiteste: 1123 (3), 907 (16), 735 (14)  
 beste Teiler 30.0 (28.) 109.6 (37.) 139.5 (24.)  
 Trefferlage 0.06 mm rechts, 0.46 mm hoch  
 Streuwert 3.09, horizontal: 3.47, vertikal: 2.65

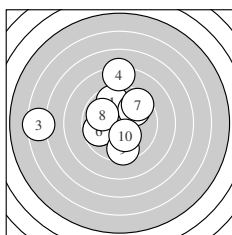
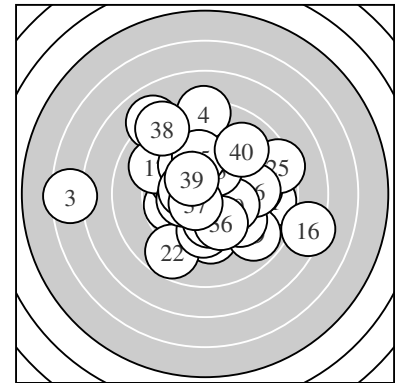

Serie 1:  
 9.7 ↗ 9.9 ↗ 6.5 ← 8.3 ↑ 9.8 ←  
 9.8 ← 9.5 ↗ 9.9 ↖ 9.5 ↓ 10.2 \*  
 beste Teiler 185.3 (10.) 266.9 (8.) 271.7 (2.)  
 Trefferlage 1.46 mm links, 0.81 mm hoch  
 Streuwert 3.45, horizontal: 3.92, vertikal: 2.92

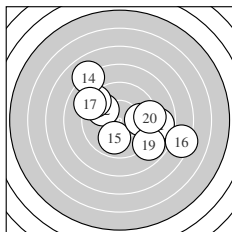

Serie 2:  
 8.8 → 9.9 ↖ 9.2 ↖ 8.0 ↖ 9.9 ↓  
 7.3 → 9.1 ↖ 9.8 → 8.9 ↘ 9.3 →  
 beste Teiler 254.4 (15.) 272.2 (12.) 292.0 (18.)  
 Trefferlage 1.01 mm rechts, 0.35 mm hoch  
 Streuwert 3.81, horizontal: 4.57, vertikal: 2.87

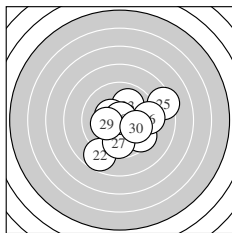

Serie 3:  
 9.5 ↘ 8.7 ↓ 10.0 ↗ 10.4 \* 8.4 →  
 9.3 → 9.7 ↓ 10.8 \* 10.2 \* 10.0 ↘  
 beste Teiler 30.0 (28.) 139.5 (24.) 186.2 (29.)  
 Trefferlage 1.06 mm rechts, 0.57 mm tief  
 Streuwert 2.52, horizontal: 2.77, vertikal: 2.24

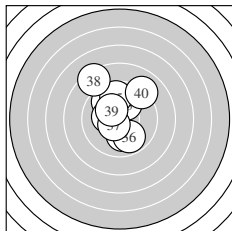

Serie 4:  
 9.8 ↖ 10.0 ↓ 10.1 ↗ 10.3 \* 9.7 ↑  
 9.9 ↓ 10.5 \* 8.4 ↖ 10.3 \* 9.0 ↗  
 beste Teiler 109.6 (37.) 167.8 (34.) 167.9 (39.)  
 Trefferlage 0.37 mm links, 1.28 mm hoch  
 Streuwert 2.24, horizontal: 1.85, vertikal: 2.57

Unterschrift des Schützen

Meyton Elektronik

Ergebnis: **388.7** (370)  
 Serien: 96.3 97.3 98.4 96.7  
 Zähler: 15 20 5 0 0 0 0 0 0 0  
 Innenzehner: 11  
 weiteste: 742 (7), 616 (31), 516 (14)  
 beste Teiler 120.0 (29.) 123.0 (16.) 125.2 (13.)  
 Trefferlage 1.08 mm links, 0.11 mm tief  
 Streuwert 2.33, horizontal: 2.49, vertikal: 2.16

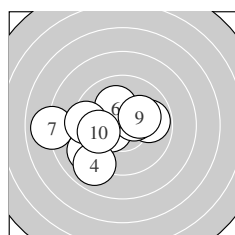
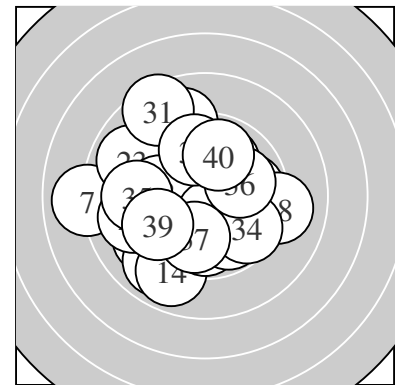

Serie 1:  
 10.4 \*                      9.8 →                      9.2 ↙                      8.9 ↘                      10.4 \*  
 10.1 †                      8.0 ←                      9.4 ←                      10.2 \*                      9.9 ←  
 beste Teiler 134.6 (5.) 138.7 (1.) 199.4 (9.)  
 Trefferlage 1.65 mm links, 0.42 mm tief  
 Streuwert 2.50, horizontal: 3.07, vertikal: 1.76

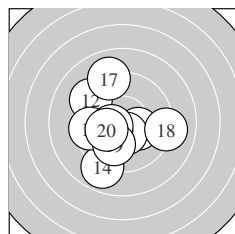

Serie 2:  
 10.2 \*                      9.3 ↖                      10.5 \*                      8.9 ↘                      9.6 ←  
 10.5 \*                      9.0 †                      9.1 →                      10.0 ↘                      10.2 \*  
 beste Teiler 123.0 (16.) 125.2 (13.) 177.3 (11.)  
 Trefferlage 0.75 mm links, 0.46 mm tief  
 Streuwert 2.45, horizontal: 2.42, vertikal: 2.49

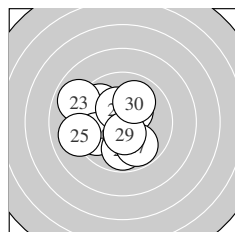

Serie 3:  
 10.4 \*                      9.8 ↖                      8.9 ↖                      9.8 ←                      9.1 ←  
 9.8 ↓                      9.8 ↘                      10.3 \*                      10.5 \*                      10.0 †  
 beste Teiler 120.0 (29.) 146.0 (21.) 156.0 (28.)  
 Trefferlage 1.09 mm links, 0.03 mm tief  
 Streuwert 2.13, horizontal: 2.30, vertikal: 1.95

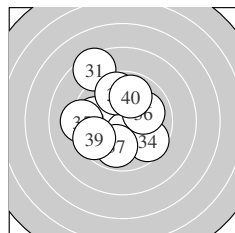

Serie 4:  
 8.5 †                      9.8 ←                      10.4 \*                      9.6 ↘                      9.2 ←  
 10.0 →                      9.9 ↓                      9.8 †                      9.6 ↙                      9.9 †  
 beste Teiler 131.5 (33.) 236.5 (36.) 269.4 (37.)  
 Trefferlage 0.83 mm links, 0.43 mm hoch  
 Streuwert 2.47, horizontal: 2.38, vertikal: 2.56

Unterschrift des Schützen

Meyton Elektronik

Ergebnis: **373.7** (354)  
 Serien: 93.7 94.3 94.8 90.9  
 Zähler: 11 15 11 3 0 0 0 0 0 0  
 Innenzehner: 10  
 weiteste: 828 (11), 817 (39), 805 (3)  
 beste Teiler 35.0 (29.) 81.8 (14.) 96.5 (26.)  
 Trefferlage 0.22 mm rechts, 1.62 mm tief  
 Streuwert 3.07, horizontal: 3.65, vertikal: 2.34

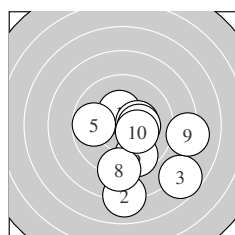
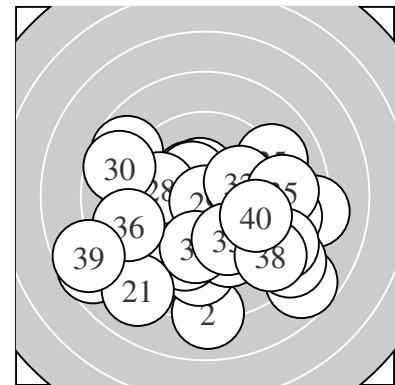

Serie 1:  
 10.4 \*                      8.0 ↓                      7.7 ↘                      10.3 \*                      9.8 ←  
    9.6 ↘                      10.3 \*                      9.1 ↓                      8.2 →                      10.3 \*  
 beste Teiler 140.6 (1.) 155.9 (4.) 164.2 (10.)  
 Trefferlage 1.54 mm rechts, 2.03 mm tief  
 Streuwert 2.90, horizontal: 2.92, vertikal: 2.88

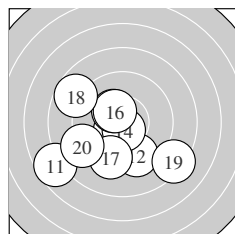

Serie 2:  
 7.6 ↙                      9.5 ↓                      10.5 \*                      10.6 \*                      10.3 \*  
    10.4 \*                      9.4 ↓                      8.7 ↘                      8.3 ↘                      9.0 ↙  
 beste Teiler 81.8 (14.) 120.4 (13.) 139.2 (16.)  
 Trefferlage 1.29 mm links, 1.47 mm tief  
 Streuwert 3.03, horizontal: 3.45, vertikal: 2.53

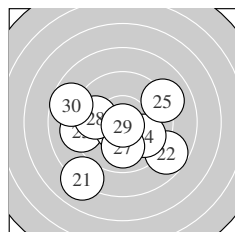

Serie 3:  
 8.1 ↙                      8.7 ↘                      9.2 ←                      9.9 ↘                      9.1 ↗  
    10.6 \*                      9.9 ↓                      9.8 ←                      10.8 \*                      8.7 ↖  
 beste Teiler 35.0 (29.) 96.5 (26.) 252.0 (27.)  
 Trefferlage 0.62 mm links, 1.04 mm tief  
 Streuwert 3.02, horizontal: 3.53, vertikal: 2.40

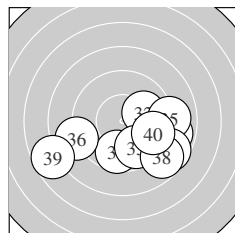

Serie 4:  
 9.7 ↓                      10.0 →                      9.7 ↓                      8.9 →                      9.0 →  
    8.9 ←                      8.7 ↘                      8.7 ↘                      7.7 ↖                      9.6 →  
 beste Teiler 234.1 (32.) 303.7 (33.) 324.4 (31.)  
 Trefferlage 1.29 mm rechts, 1.94 mm tief  
 Streuwert 3.24, horizontal: 4.28, vertikal: 1.62

Unterschrift des Schützen

Meyton Elektronik

Ergebnis: **368.3** (349)  
 Serien: 91.9 87.7 90.9 97.8  
 Zähler: 9 17 8 6 0 0 0 0 0 0  
 Innenzehner: 5  
 weiteste: 953 (15), 952 (13), 938 (29)  
 beste Teiler 59.0 (33.) 107.1 (27.) 136.3 (32.)  
 Trefferlage 0.21 mm rechts, 0.22 mm tief  
 Streuwert 3.54, horizontal: 4.55, vertikal: 2.09

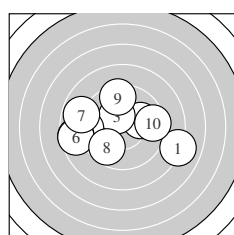
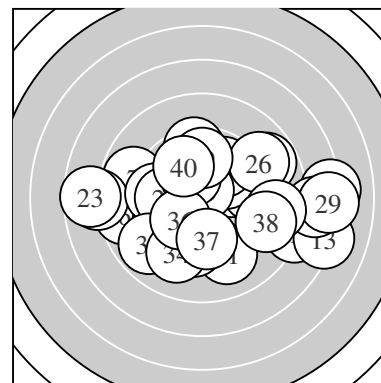

Serie 1:  
 8.0 → 10.0 → 10.3 \* 9.1 ← 8.6 ←  
 8.6 ← 8.8 ← 9.7 ↙ 9.4 ↑ 9.4 →  
 beste Teiler 158.7 (3.) 235.7 (2.) 311.1 (8.)  
 Trefferlage 1.16 mm links, 0.05 mm hoch  
 Streuwert 3.37, horizontal: 4.35, vertikal: 1.95

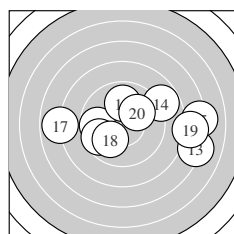

Serie 2:  
 9.7 ← 9.6 ← 7.1 → 8.8 ↗ 7.1 →  
 9.9 ↑ 7.9 ← 10.0 ↙ 7.6 → 10.0 ↗  
 beste Teiler 228.3 (20.) 241.7 (18.) 258.0 (16.)  
 Trefferlage 1.82 mm rechts, 0.02 mm tief  
 Streuwert 4.39, horizontal: 5.92, vertikal: 1.87

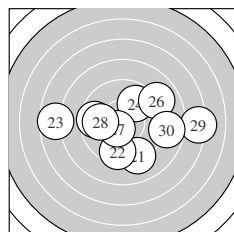

Serie 3:  
 9.1 ↘ 9.5 ↓ 7.6 ← 9.8 ↗ 9.6 ←  
 9.0 ↗ 10.5 \* 9.9 ← 7.2 → 8.7 →  
 beste Teiler 107.1 (27.) 274.0 (28.) 278.2 (24.)  
 Trefferlage 0.66 mm rechts, 0.44 mm tief  
 Streuwert 3.86, horizontal: 5.01, vertikal: 2.17

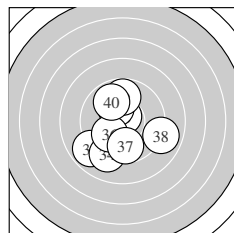

Serie 4:  
 8.9 ↙ 10.4 \* 10.7 \* 9.2 ↙ 10.2 \*  
 10.1 ↙ 9.7 ↓ 8.9 → 9.8 ↑ 9.9 ↘  
 beste Teiler 59.0 (33.) 136.3 (32.) 176.7 (35.)  
 Trefferlage 0.47 mm links, 0.50 mm tief  
 Streuwert 2.40, horizontal: 2.23, vertikal: 2.56

Unterschrift des Schützen

Meyton Elektronik

Ergebnis: **359.8** (343)  
 Serien: 94.9 90.0 85.8 89.1  
 Zähler: 8 12 16 3 1 0 0 0 0 0  
 Innenzehner: 4  
 weiteste: 1092 (39), 989 (29), 988 (36)  
 beste Teiler 41.0 (38.) 137.5 (2.) 192.0 (1.)  
 Trefferlage 1.25 mm links, 1.23 mm tief  
 Streuwert 3.74, horizontal: 4.47, vertikal: 2.82

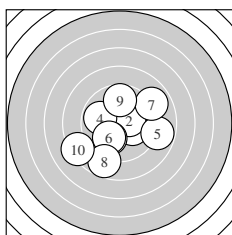
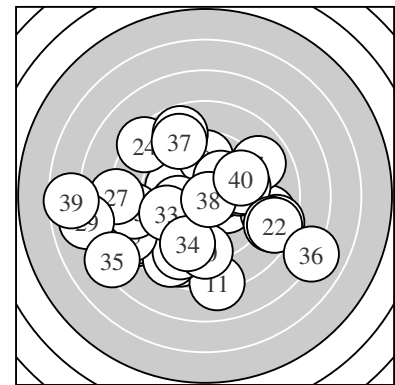

Serie 1:  
 10.2 \*                      10.4 \*                      10.0 ↙                      9.9 ↖                      8.8 →  
 10.0 ↘                      8.9 ↗                      8.7 ↓                      9.7 ↑                      8.3 ↙  
 beste Teiler 137.5 (2.) 192.0 (1.) 240.9 (3.)  
 Trefferlage 0.05 mm links, 0.79 mm tief  
 Streuwert 2.97, horizontal: 3.29, vertikal: 2.60

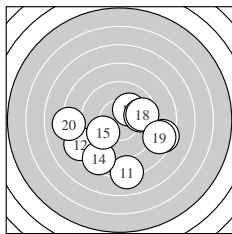

Serie 2:  
 8.1 ↓                      8.5 ↖                      8.5 →                      8.6 ↓                      9.8 ↖  
 10.2 \*                      9.8 →                      9.7 →                      8.6 →                      8.2 ←  
 beste Teiler 192.6 (16.) 280.6 (15.) 289.1 (17.)  
 Trefferlage 0.21 mm rechts, 1.93 mm tief  
 Streuwert 3.64, horizontal: 4.38, vertikal: 2.71

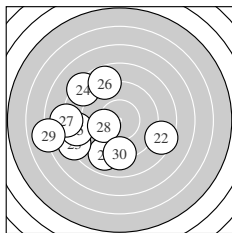

Serie 3:  
 9.0 ↓                      8.5 →                      8.2 ↖                      8.4 ↖                      8.6 ←  
 8.8 ↖                      8.1 ←                      10.1 ←                      7.0 ←                      9.1 ↓  
 beste Teiler 225.8 (28.) 451.0 (30.) 499.1 (21.)  
 Trefferlage 3.43 mm links, 0.95 mm tief  
 Streuwert 3.85, horizontal: 4.34, vertikal: 3.29

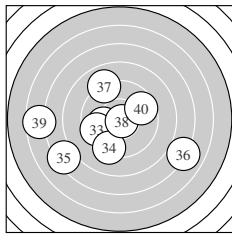

Serie 4:  
 10.0 ←                      9.9 ↖                      9.6 ↖                      9.3 ↓                      7.3 ↖  
 7.0 →                      9.0 ↖                      10.8 \*                      6.6 ←                      9.6 →  
 beste Teiler 41.0 (38.) 227.3 (31.) 275.7 (32.)  
 Trefferlage 1.74 mm links, 1.25 mm tief  
 Streuwert 4.30, horizontal: 5.32, vertikal: 2.93

Unterschrift des Schützen

Meyton Elektronik

Ergebnis: **379.7** (359)  
 Serien: 94.3 95.9 96.3 93.2  
 Zähler: 10 22 5 3 0 0 0 0 0 0  
 Innenzehner: 7  
 weiteste: 918 (34), 772 (5), 765 (39)  
 beste Teiler 110.3 (25.) 125.4 (1.) 126.7 (38.)  
 Trefferlage 1.03 mm links, 0.03 mm hoch  
 Streuwert 2.83, horizontal: 3.13, vertikal: 2.49

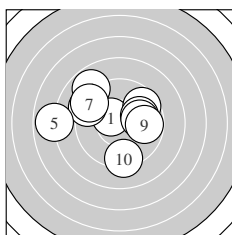
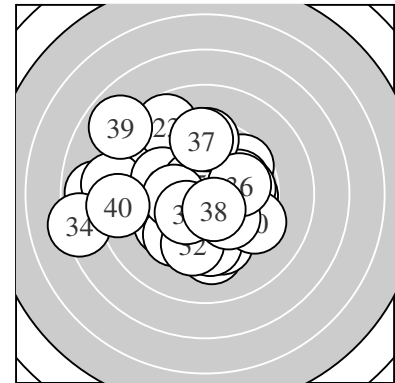

Serie 1:  
 10.5 \* 9.6 ↗ 9.3 ↘ 8.8 ↖ 7.9 ←  
 9.9 → 9.2 ↙ 10.0 → 9.8 → 9.3 ↓  
 beste Teiler 125.4 (1.) 244.9 (8.) 251.6 (6.)  
 Trefferlage 0.87 mm links, 0.82 mm hoch  
 Streuwert 2.99, horizontal: 3.63, vertikal: 2.16

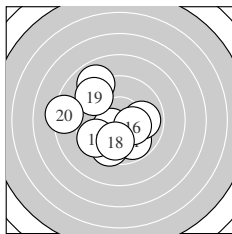

Serie 2:  
 9.8 ↘ 8.9 ↖ 9.6 ↓ 9.9 → 10.4 \*  
 10.3 \* 9.5 ↗ 9.9 ↓ 9.3 ↖ 8.3 ←  
 beste Teiler 130.4 (15.) 166.1 (16.) 252.4 (18.)  
 Trefferlage 1.22 mm links, 0.39 mm tief  
 Streuwert 2.58, horizontal: 2.73, vertikal: 2.42

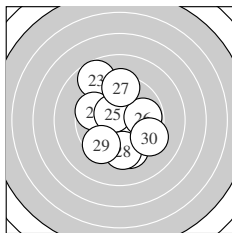

Serie 3:  
 9.5 ↓ 10.4 \* 8.7 ↖ 9.7 ↘ 10.5 \*  
 9.8 → 9.4 ↑ 9.5 ↓ 9.5 ↗ 9.3 ↘  
 beste Teiler 110.3 (25.) 138.0 (22.) 278.3 (26.)  
 Trefferlage 0.06 mm rechts, 0.10 mm tief  
 Streuwert 2.61, horizontal: 2.24, vertikal: 2.93

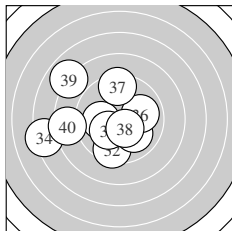

Serie 4:  
 10.1 ← 9.5 ↓ 10.2 \* 7.3 ← 10.0 ↘  
 9.9 → 9.4 ↑ 10.4 \* 7.9 ↖ 8.5 ←  
 beste Teiler 126.7 (38.) 187.3 (33.) 220.6 (31.)  
 Trefferlage 2.10 mm links, 0.16 mm tief  
 Streuwert 3.23, horizontal: 3.75, vertikal: 2.61

Unterschrift des Schützen

Meyton Elektronik

Ergebnis: **390.0** (374)  
 Serien: 97.3 97.8 97.8 97.1  
 Zähler: 18 18 4 0 0 0 0 0 0 0  
 Innenzehner: 12  
 weiteste: 532 (22), 521 (5), 515 (23)  
 beste Teiler 107.5 (2.) 109.0 (7.) 114.5 (15.)  
 Trefferlage 0.34 mm rechts, 0.23 mm hoch  
 Streuwert 2.33, horizontal: 2.35, vertikal: 2.30

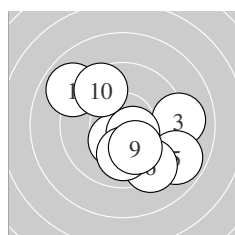
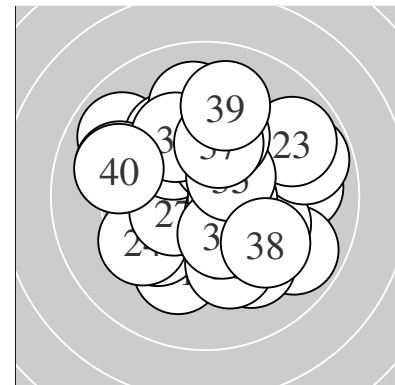

Serie 1:  
 8.9 ↘                      10.5 \*                      9.1 →                      10.4 \*                      8.9 ↘  
 9.3 ↘                      10.5 \*                      10.0 ↓                      10.1 ↘                      9.6 ↘  
 beste Teiler 107.5 (2.) 109.0 (7.) 142.2 (4.)  
 Trefferlage 0.66 mm rechts, 0.70 mm tief  
 Streuwert 2.47, horizontal: 2.71, vertikal: 2.21

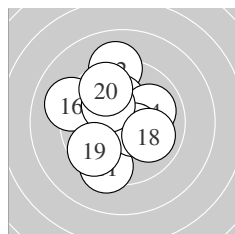

Serie 2:  
 9.4 ↓                      9.1 ↑                      10.2 \*                      10.0 →                      10.5 \*  
 9.1 ↖                      10.2 \*                      10.0 ↘                      9.6 ↗                      9.7 ↘  
 beste Teiler 114.5 (15.) 179.0 (13.) 184.3 (17.)  
 Trefferlage 0.62 mm links, 0.51 mm hoch  
 Streuwert 2.24, horizontal: 2.01, vertikal: 2.45

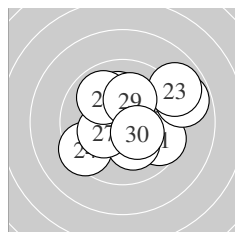

Serie 3:  
 9.6 ↘                      8.8 →                      8.9 ↗                      9.4 ↙                      10.1 ↑  
 10.2 \*                      10.3 \*                      9.9 ↘                      10.2 \*                      10.4 \*  
 beste Teiler 150.6 (30.) 173.0 (27.) 197.6 (26.)  
 Trefferlage 0.85 mm rechts, 0.34 mm hoch  
 Streuwert 2.32, horizontal: 2.67, vertikal: 1.91

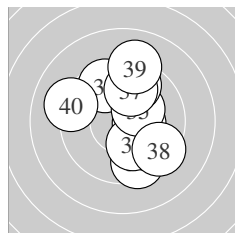

Serie 4:  
 9.5 ↓                      10.4 \*                      9.6 ↖                      10.1 ↘                      10.3 \*  
 9.7 ↑                      9.9 ↑                      9.4 ↘                      9.1 ↑                      9.1 ↖  
 beste Teiler 139.3 (32.) 162.8 (35.) 209.4 (34.)  
 Trefferlage 0.47 mm rechts, 0.76 mm hoch  
 Streuwert 2.35, horizontal: 2.01, vertikal: 2.65

Unterschrift des Schützen

Meyton Elektronik

Ergebnis: **373.0** (352)  
 Serien: 94.6 90.5 93.8 94.1  
 Zähler: 9 17 11 3 0 0 0 0 0 0  
 Innenzehner: 8  
 weiteste: 814 (1), 809 (18), 764 (39)  
 beste Teiler 1.0 (23.) 8.9 (5.) 95.2 (33.)  
 Trefferlage 0.01 mm links, 0.15 mm hoch  
 Streuwert 3.30, horizontal: 4.11, vertikal: 2.21

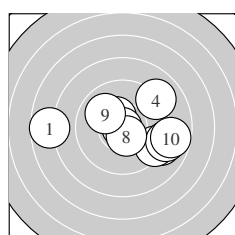
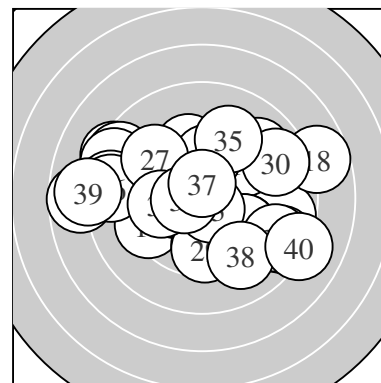

Serie 1:  
 7.7 ←                      9.1 →                      10.4 \*                      9.0 ↗                      10.9 \*  
 9.3 ↘                      8.9 →                      10.5 \*                      10.0 ↖                      8.8 →  
 beste Teiler 8.9 (5.) 106.6 (8.) 135.1 (3.)  
 Trefferlage 1.13 mm rechts, 0.22 mm tief  
 Streuwert 3.17, horizontal: 4.15, vertikal: 1.71

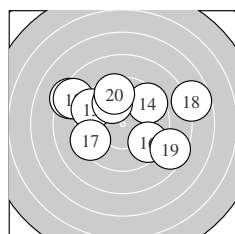

Serie 2:  
 8.3 ↖                      8.5 ↖                      9.4 ↖                      9.5 ↗                      9.9 ↖  
 9.6 ↘                      9.4 ←                      7.7 →                      8.6 ↘                      9.6 ↖  
 beste Teiler 259.8 (15.) 347.9 (16.) 348.3 (20.)  
 Trefferlage 0.19 mm links, 1.14 mm hoch  
 Streuwert 3.68, horizontal: 4.65, vertikal: 2.35

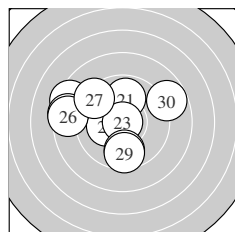

Serie 3:  
 9.9 ↑                      10.2 \*                      10.9 \*                      8.4 ↖                      8.5 ←  
 8.5 ←                      9.3 ↖                      9.7 ↓                      9.6 ↓                      8.8 →  
 beste Teiler 1.0 (23.) 183.3 (22.) 267.0 (21.)  
 Trefferlage 1.73 mm links, 0.47 mm hoch  
 Streuwert 3.00, horizontal: 3.59, vertikal: 2.27

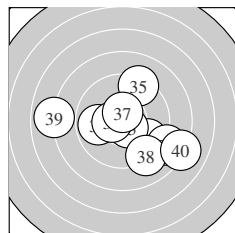

Serie 4:  
 9.8 ←                      9.6 ↘                      10.6 \*                      8.7 ↘                      9.2 ↗  
 10.5 \*                      10.6 \*                      9.1 ↘                      7.9 ←                      8.1 ↘  
 beste Teiler 95.2 (33.) 97.0 (37.) 118.6 (36.)  
 Trefferlage 0.75 mm rechts, 0.77 mm tief  
 Streuwert 3.27, horizontal: 4.02, vertikal: 2.30

Unterschrift des Schützen

Meyton Elektronik



Ergebnis:	<b>596.1</b>	(569)
Serien:	99.8 98.0 99.4 101.6 98.7 98.6	
Zähler:	31 27 2 0 0 0 0 0 0 0	
Innenzehner:	21	
weiteste:	578 (24), 578 (47), 494 (60)	
beste Teiler	10.1 (44.) 42.5 (32.) 47.1 (52.)	
Trefferlage	0.04 mm links, 0.12 mm hoch	
Streuwert	2.05, horizontal: 2.39, vertikal: 1.64	

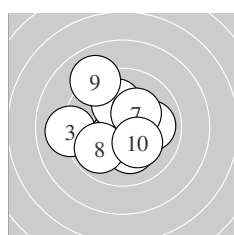
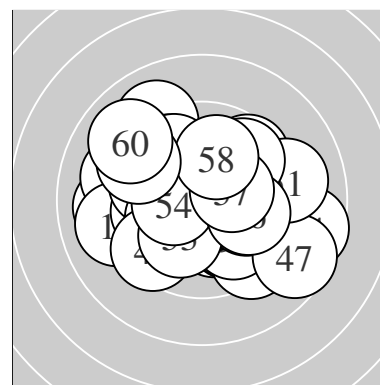

Serie 1:	10.6 *	10.2 *	9.1 ←	10.4 *	10.1 ↑
	10.0 →	10.3 *	9.9 ↗	9.0 ↖	10.2 *
beste Teiler	81.8 (1.)	147.8 (4.)	171.8 (7.)		
Trefferlage	0.31 mm links, 0.18 mm hoch				
Streuwert	2.04, horizontal: 2.19, vertikal: 1.88				

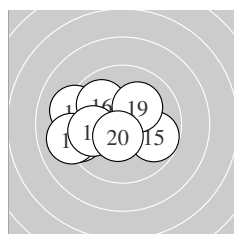

Serie 2:	10.5 *	9.6 ←	9.3 ←	9.2 ←	9.8 →
	9.9 ↘	9.1 ←	9.9 ←	10.2 *	10.5 *
beste Teiler	101.5 (11.)	114.9 (20.)	199.9 (19.)		
Trefferlage	1.74 mm links, 0.09 mm hoch				
Streuwert	1.95, horizontal: 2.46, vertikal: 1.23				

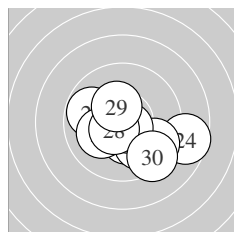

Serie 3:	10.3 *	9.8 ←	10.0 ↘	8.6 →	9.6 ↘
	10.1 ↖	10.7 *	10.6 *	10.4 *	9.3 ↘
beste Teiler	68.6 (27.)	98.7 (28.)	148.7 (29.)		
Trefferlage	0.74 mm rechts, 0.97 mm tief				
Streuwert	1.99, horizontal: 2.47, vertikal: 1.34				

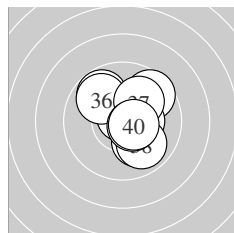

Serie 4:	9.8 ↘	10.8 *	10.1 ↘	9.6 ↗	10.4 *
	9.9 ↘	10.0 ↗	9.9 ↘	10.6 *	10.5 *
beste Teiler	42.5 (32.)	96.1 (39.)	104.3 (40.)		
Trefferlage	0.63 mm rechts, 0.41 mm hoch				
Streuwert	1.54, horizontal: 1.46, vertikal: 1.62				

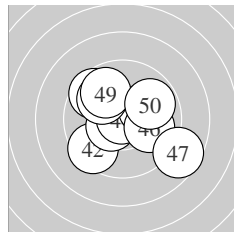

Serie 5:	9.6 ↘	9.5 ↖	10.5 *	10.9 *	10.1 →
	10.0 →	8.6 ↘	9.9 ↘	9.8 ↘	9.8 →
beste Teiler	10.1 (44.)	118.8 (43.)	205.7 (45.)		
Trefferlage	0.20 mm rechts, 0.16 mm hoch				
Streuwert	2.26, horizontal: 2.56, vertikal: 1.91				

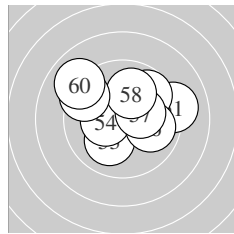

Serie 6:	9.1 →	10.8 *	10.1 ↖	10.3 *	9.7 ↗
	9.9 →	10.3 *	10.0 ↑	9.4 ↖	9.0 ↘
beste Teiler	47.1 (52.)	151.9 (54.)	167.6 (57.)		
Trefferlage	0.20 mm rechts, 0.85 mm hoch				
Streuwert	2.18, horizontal: 2.66, vertikal: 1.56				

Meyton Elektronik

**LG 60 ZR – Wertung – Männer**

StandNr: 139

**Vogl,, Andreas** #70225053

**StartNr: 87**

4. Februar 2018 10:49

70225 / 0

---

\_\_\_\_\_  
Unterschrift des Schützen

Meyton Elektronik

Ergebnis: **405.7** (387)  
 Serien: 101.8 102.4 102.3 99.2  
 Zähler: 27 13 0 0 0 0 0 0 0 0  
 Innenzehner: 19  
 weiteste: 394 (37), 360 (36), 348 (31)  
 beste Teiler 74.7 (18.) 87.6 (23.) 91.4 (1.)  
 Trefferlage 0.29 mm rechts, 0.44 mm hoch  
 Streuwert 1.55, horizontal: 1.66, vertikal: 1.42

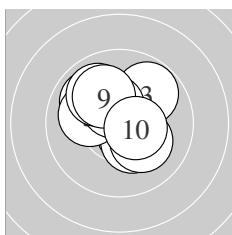
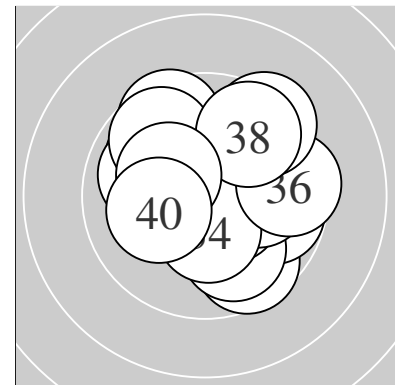

Serie 1:  
 10.6 \*                      9.9 ↘                      9.8 ↗                      10.3 \*                      10.1 ↖  
 10.4 \*                      9.9 ↘                      10.2 \*                      10.1 ↖                      10.5 \*  
 beste Teiler 91.4 (1.) 119.2 (10.) 129.2 (6.)  
 Trefferlage 0.11 mm links, 0.57 mm hoch  
 Streuwert 1.45, horizontal: 1.53, vertikal: 1.37

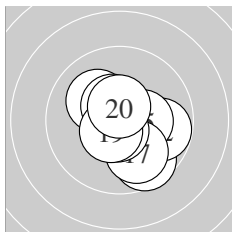

Serie 2:  
 9.6 ↘                      9.8 →                      10.3 \*                      10.1 ↖                      10.3 \*  
 10.5 \*                      9.9 ↘                      10.7 \*                      10.6 \*                      10.6 \*  
 beste Teiler 74.7 (18.) 97.0 (20.) 98.2 (19.)  
 Trefferlage 0.55 mm rechts, 0.50 mm tief  
 Streuwert 1.36, horizontal: 1.35, vertikal: 1.38

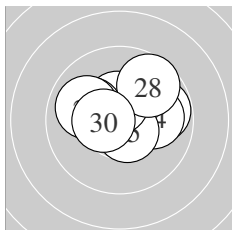

Serie 3:  
 9.8 →                      10.5 \*                      10.6 \*                      10.0 →                      10.6 \*  
 10.5 \*                      10.1 ↖                      9.7 ↗                      10.0 ↖                      10.5 \*  
 beste Teiler 87.6 (23.) 94.6 (25.) 113.7 (22.)  
 Trefferlage 0.30 mm rechts, 0.70 mm hoch  
 Streuwert 1.40, horizontal: 1.79, vertikal: 0.84

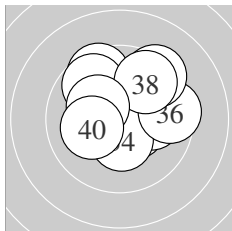

Serie 4:  
 9.6 ↘                      10.5 \*                      10.1 →                      10.4 \*                      9.7 ↘  
 9.5 →                      9.4 ↗                      9.7 ↗                      10.2 \*                      10.1 ←  
 beste Teiler 120.2 (32.) 146.7 (34.) 178.7 (39.)  
 Trefferlage 0.44 mm rechts, 0.99 mm hoch  
 Streuwert 1.89, horizontal: 2.07, vertikal: 1.69

Unterschrift des Schützen

Meyton Elektronik

Ergebnis: **406.7** (387)  
 Serien: 100.7 99.0 103.7 103.3  
 Zähler: 29 9 2 0 0 0 0 0 0 0  
 Innenzehner: 22  
 weiteste: 675 (14), 648 (4), 383 (12)  
 beste Teiler 9.2 (7.) 15.0 (36.) 25.6 (16.)  
 Trefferlage 0.29 mm links, 0.72 mm hoch  
 Streuwert 1.64, horizontal: 1.86, vertikal: 1.39

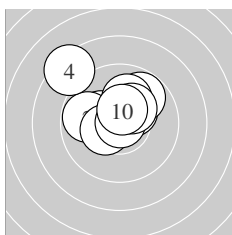
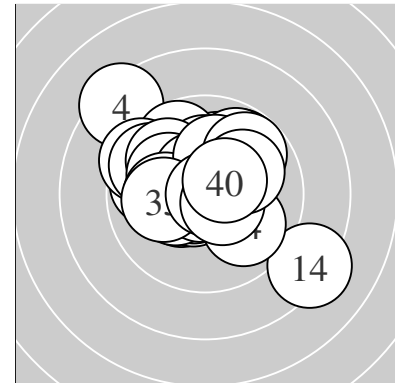

Serie 1:  
 10.2 \*                      9.8 ←                      10.3 \*                      8.4 ↘                      10.4 \*  
    9.8 ↗                      10.9 \*                      10.1 ↑                      10.3 \*                      10.5 \*  
 beste Teiler 9.2 (7.) 122.1 (10.) 138.7 (5.)  
 Trefferlage 0.52 mm links, 1.33 mm hoch  
 Streuwert 1.75, horizontal: 1.99, vertikal: 1.47

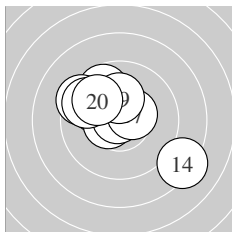

Serie 2:  
 9.7 ↘                      9.4 ↖                      10.0 ↖                      8.3 ↘                      10.5 \*  
    10.9 \*                      10.5 \*                      9.6 ↖                      10.2 \*                      9.9 ↘  
 beste Teiler 25.6 (16.) 104.1 (15.) 122.5 (17.)  
 Trefferlage 0.64 mm links, 0.75 mm hoch  
 Streuwert 2.24, horizontal: 2.58, vertikal: 1.84

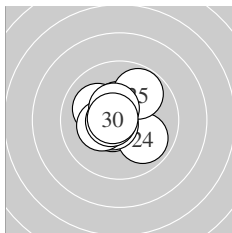

Serie 3:  
 10.6 \*                      10.5 \*                      10.1 ↖                      9.9 ↘                      9.8 ↗  
    10.7 \*                      10.3 \*                      10.6 \*                      10.5 \*                      10.7 \*  
 beste Teiler 64.0 (30.) 70.7 (26.) 78.6 (28.)  
 Trefferlage 0.30 mm links, 0.25 mm hoch  
 Streuwert 1.19, horizontal: 1.25, vertikal: 1.13

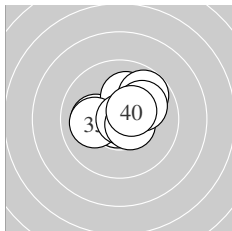

Serie 4:  
 10.1 ←                      10.6 \*                      10.1 ↑                      10.8 \*                      10.1 ←  
    10.9 \*                      10.5 \*                      9.8 ↗                      10.0 ↗                      10.4 \*  
 beste Teiler 15.0 (36.) 37.4 (34.) 87.0 (32.)  
 Trefferlage 0.28 mm rechts, 0.54 mm hoch  
 Streuwert 1.24, horizontal: 1.48, vertikal: 0.95

Unterschrift des Schützen

Meyton Elektronik

Ergebnis: **389.5** (374)  
 Serien: 99.3 96.9 94.3 99.0  
 Zähler: 20 15 4 1 0 0 0 0 0 0  
 Innenzehner: 14  
 weiteste: 800 (29), 737 (38), 601 (37)  
 beste Teiler 15.0 (7.) 23.5 (16.) 42.4 (14.)  
 Trefferlage 0.30 mm links, 0.35 mm hoch  
 Streuwert 2.55, horizontal: 3.07, vertikal: 1.89

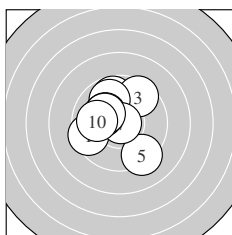
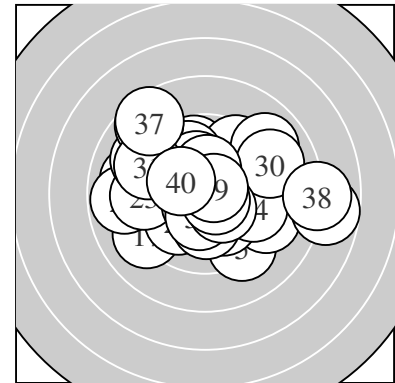

Serie 1:  
 9.5 ←                      9.8 ↑                      9.5 ↗                      9.8 ↑                      9.3 ↓  
 10.2 \*                      10.9 \*                      10.1 ↖                      10.2 \*                      10.0 ←  
 beste Teiler 15.0 (7.) 191.1 (6.) 191.9 (9.)  
 Trefferlage 0.81 mm links, 0.67 mm hoch  
 Streuwert 1.93, horizontal: 1.87, vertikal: 1.99

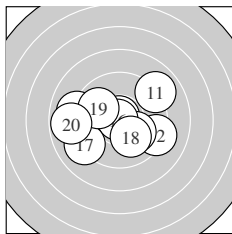

Serie 2:  
 9.0 ↗                      9.2 →                      9.0 ←                      10.8 \*                      10.1 ↓  
 10.9 \*                      9.1 ←                      10.1 ↓                      9.9 ↖                      8.8 ←  
 beste Teiler 23.5 (16.) 42.4 (14.) 218.0 (15.)  
 Trefferlage 0.55 mm links, 0.19 mm tief  
 Streuwert 2.68, horizontal: 3.39, vertikal: 1.72

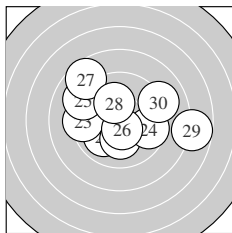

Serie 3:  
 10.0 ↗                      10.1 ↓                      9.3 ←                      9.6 →                      9.1 ↖  
 10.5 \*                      8.6 ↘                      10.2 \*                      7.8 →                      9.1 →  
 beste Teiler 103.5 (26.) 196.7 (28.) 204.1 (22.)  
 Trefferlage 0.17 mm rechts, 0.37 mm hoch  
 Streuwert 3.18, horizontal: 3.94, vertikal: 2.16

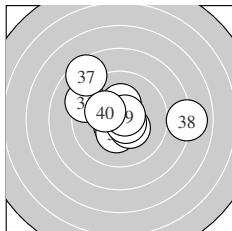

Serie 4:  
 9.3 ↖                      10.6 \*                      10.4 \*                      10.4 \*                      10.3 \*  
 10.6 \*                      8.5 ↘                      8.0 →                      10.7 \*                      10.2 \*  
 beste Teiler 69.0 (39.) 81.6 (36.) 93.6 (32.)  
 Trefferlage 0.00 mm , 0.58 mm hoch  
 Streuwert 2.55, horizontal: 3.10, vertikal: 1.83

Unterschrift des Schützen

Meyton Elektronik

Ergebnis: **175.4** (167)  
 Serien: 86.1 89.3  
 Zähler: 5 4 6 3 2 0 0 0 0 0  
 Innenzehner: 5  
 weiteste: 1118 (15), 1089 (14), 954 (4)  
 beste Teiler 117.1 (8.) 123.2 (17.) 147.1 (9.)  
 Trefferlage 1.36 mm links, 1.56 mm hoch  
 Streuwert 4.32, horizontal: 5.07, vertikal: 3.41

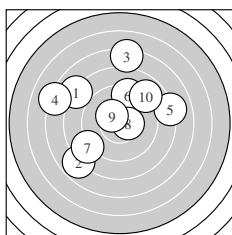
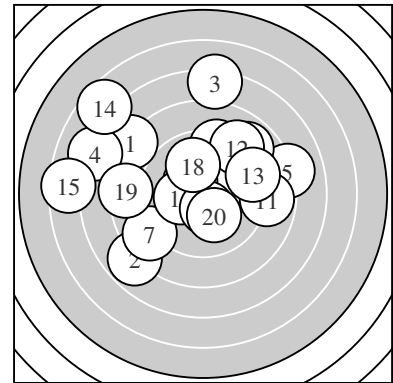

Serie 1:  
 8.0 ↘                      7.8 ↙                      7.2 ↑                      7.1 ↖                      8.1 →  
 9.3 ↑                      8.8 ↙                      10.5 \*                      10.4 \*                      8.9 ↗  
 beste Teiler 117.1 (8.) 147.1 (9.) 407.4 (6.)  
 Trefferlage 1.22 mm links, 1.88 mm hoch  
 Streuwert 4.55, horizontal: 4.94, vertikal: 4.13

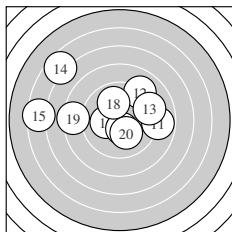

Serie 2:  
 8.8 →                      9.0 ↗                      9.2 ↘                      6.6 ↖                      6.5 ←  
 10.2 \*                      10.5 \*                      9.9 ↘                      8.4 ←                      10.2 \*  
 beste Teiler 123.2 (17.) 186.1 (16.) 198.1 (20.)  
 Trefferlage 1.49 mm links, 1.23 mm hoch  
 Streuwert 4.30, horizontal: 5.46, vertikal: 2.69

Unterschrift des Schützen

Ergebnis: **191.3** (183)  
 Serien: 93.2 98.1  
 Zähler: 8 7 5 0 0 0 0 0 0 0  
 Innenzehner: 6  
 weiteste: 746 (6), 707 (7), 682 (10)  
 beste Teiler 19.2 (17.) 79.2 (3.) 116.4 (15.)  
 Trefferlage 0.77 mm links, 0.54 mm tief  
 Streuwert 2.89, horizontal: 2.83, vertikal: 2.94

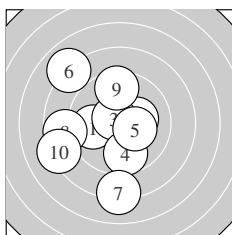
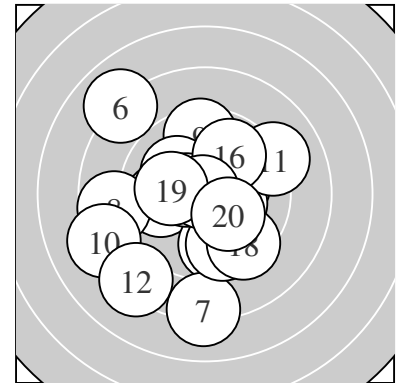

Serie 1:  
 9.9 ←                      10.2 \*                      10.6 \*                      9.7 ↓                      10.3 \*  
 8.0 ↘                      8.1 ↓                      8.7 ←                      9.5 ↑                      8.2 ←  
 beste Teiler 79.2 (3.) 166.4 (5.) 177.0 (2.)  
 Trefferlage 1.67 mm links, 0.49 mm tief  
 Streuwert 3.25, horizontal: 3.01, vertikal: 3.48

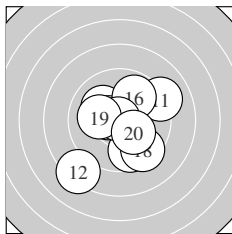

Serie 2:  
 9.1 →                      8.3 ↙                      9.7 ↓                      10.1 ↘                      10.5 \*  
 9.8 ↗                      10.9 \*                      9.4 ↘                      10.1 ←                      10.2 \*  
 beste Teiler 19.2 (17.) 116.4 (15.) 187.7 (20.)  
 Trefferlage 0.11 mm rechts, 0.60 mm tief  
 Streuwert 2.47, horizontal: 2.46, vertikal: 2.49

Unterschrift des Schützen

Ergebnis: **163.6** (153)  
 Serien: 88.3 75.3  
 Zähler: 2 5 5 3 2 3 0 0 0 0  
 Innenzehner: 2  
 weiteste: 1442 (18), 1328 (20), 1255 (19)  
 beste Teiler 85.4 (4.) 92.8 (5.) 310.6 (11.)  
 Trefferlage 0.37 mm links, 0.53 mm hoch  
 Streuwert 5.71, horizontal: 6.13, vertikal: 5.25

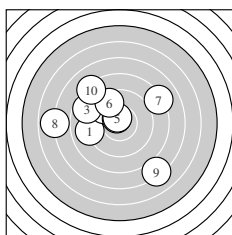
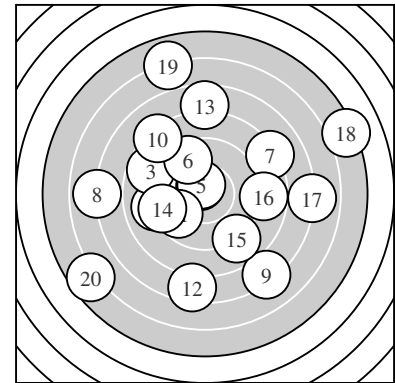

Serie 1:  
 9.0 ←                      9.6 ↘                      8.7 ↖                      10.6 \*                      10.6 \*  
 9.5 ↘                      8.1 ↗                      6.9 ←                      7.1 ↘                      8.2 ↘  
 beste Teiler 85.4 (4.) 92.8 (5.) 327.2 (2.)  
 Trefferlage 1.73 mm links, 0.93 mm hoch  
 Streuwert 4.29, horizontal: 4.94, vertikal: 3.53

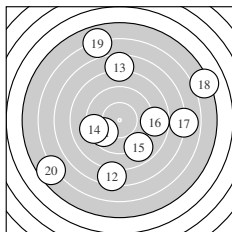

Serie 2:  
 9.7 ↙                      7.4 ↓                      7.6 ↑                      9.3 ←                      8.9 ↘  
 8.8 →                      6.9 →                      5.2 ↗                      5.9 ↑                      5.6 ↙  
 beste Teiler 310.6 (11.) 423.7 (14.) 512.4 (15.)  
 Trefferlage 0.97 mm rechts, 0.14 mm hoch  
 Streuwert 6.94, horizontal: 7.12, vertikal: 6.74

Unterschrift des Schützen



Ergebnis: **190.5** (181)  
 Serien: 96.9 93.6  
 Zähler: 4 13 3 0 0 0 0 0 0 0  
 Innenzehner: 1  
 weiteste: 698 (13), 583 (19), 521 (6)  
 beste Teiler 133.4 (20.) 217.2 (7.) 229.2 (8.)  
 Trefferlage 0.09 mm rechts, 0.50 mm hoch  
 Streuwert 2.74, horizontal: 2.98, vertikal: 2.49

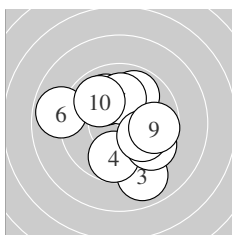
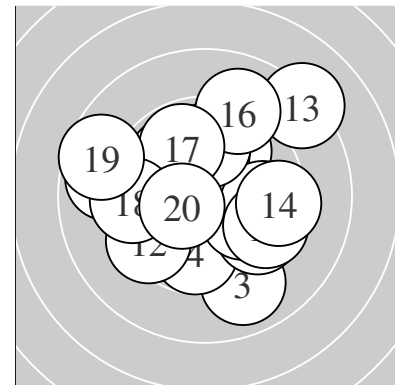

Serie 1:  
 10.0 ↖                      9.9 ↗                      9.0 ↘                      9.8 ↓                      9.6 ↘  
 8.9 ←                      10.1 ↑                      10.0 ↘                      9.7 →                      9.9 ↖  
 beste Teiler 217.2 (7.) 229.2 (8.) 239.7 (1.)  
 Trefferlage 0.25 mm rechts, 0.14 mm tief  
 Streuwert 2.48, horizontal: 2.52, vertikal: 2.44

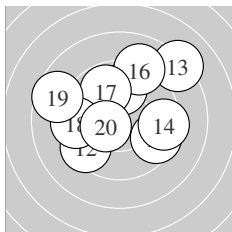

Serie 2:  
 9.5 ↘                      9.4 ↙                      8.2 ↗                      9.4 →                      9.9 ↑  
 9.0 ↗                      9.8 ↘                      9.4 ←                      8.6 ↖                      10.4 \*  
 beste Teiler 133.4 (20.) 268.5 (15.) 287.6 (17.)  
 Trefferlage 0.06 mm links, 1.14 mm hoch  
 Streuwert 3.05, horizontal: 3.51, vertikal: 2.50

Unterschrift des Schützen

Ergebnis: **181.4** (173)  
 Serien: 91.5 89.9  
 Zähler: 4 8 6 1 1 0 0 0 0 0  
 Innenzehner: 3  
 weiteste: 1166 (10), 883 (17), 741 (13)  
 beste Teiler 75.0 (15.) 181.4 (11.) 181.6 (7.)  
 Trefferlage 1.66 mm links, 1.57 mm tief  
 Streuwert 3.56, horizontal: 4.14, vertikal: 2.87

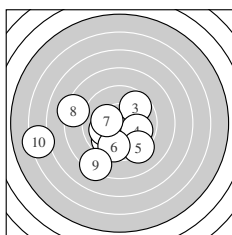
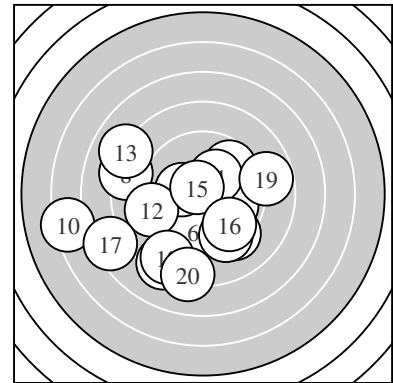

Serie 1:  
 9.8 ↙                      10.1 ←                      9.7 ↗                      9.9 →                      9.3 ↘  
 9.6 ↓                      10.2 \*                      8.3 ←                      8.3 ↓                      6.3 ←  
 beste Teiler 181.6 (7.) 225.2 (2.) 259.6 (4.)  
 Trefferlage 2.03 mm links, 1.47 mm tief  
 Streuwert 3.53, horizontal: 4.34, vertikal: 2.47

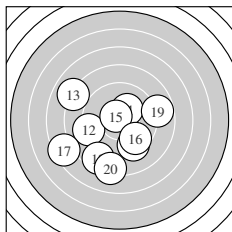

Serie 2:  
 10.2 \*                      9.1 ←                      8.0 ↘                      9.4 ↘                      10.7 \*  
 9.6 ↘                      7.4 ←                      8.5 ↓                      8.8 →                      8.2 ↓  
 beste Teiler 75.0 (15.) 181.4 (11.) 338.1 (16.)  
 Trefferlage 1.29 mm links, 1.67 mm tief  
 Streuwert 3.76, horizontal: 4.13, vertikal: 3.35

Unterschrift des Schützen

Ergebnis: **192.7** (186)  
 Serien: 98.1 94.6  
 Zähler: 11 5 3 1 0 0 0 0 0 0  
 Innenzehner: 7  
 weiteste: 779 (7), 648 (4), 596 (20)  
 beste Teiler 113.8 (9.) 145.9 (5.) 161.2 (1.)  
 Trefferlage 0.68 mm rechts, 0.24 mm hoch  
 Streuwert 2.71, horizontal: 3.35, vertikal: 1.86

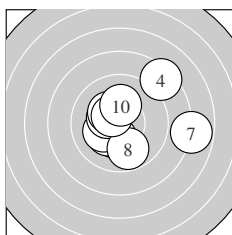
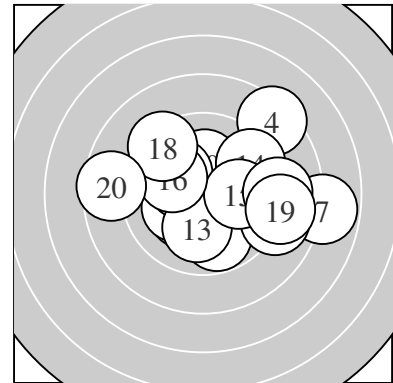

Serie 1:  
 10.3 \*                      10.2 \*                      10.2 \*                      8.4 ↗                      10.4 \*  
 10.3 \*                      7.8 →                      9.8 ↓                      10.5 \*                      10.2 \*  
 beste Teiler 113.8 (9.) 145.9 (5.) 161.2 (1.)  
 Trefferlage 0.64 mm rechts, 0.17 mm hoch  
 Streuwert 2.65, horizontal: 3.07, vertikal: 2.14

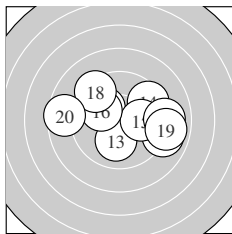

Serie 2:  
 9.0 →                      10.1 ↖                      10.1 ↓                      9.5 ↗                      10.0 →  
 10.1 ↖                      9.0 →                      9.3 ↖                      8.9 →                      8.6 ←  
 beste Teiler 211.1 (12.) 220.4 (13.) 224.5 (16.)  
 Trefferlage 0.73 mm rechts, 0.31 mm hoch  
 Streuwert 2.91, horizontal: 3.78, vertikal: 1.64

Unterschrift des Schützen

Ergebnis: **169.4** (160)  
 Serien: 86.3 83.1  
 Zähler: 2 6 5 4 3 0 0 0 0 0  
 Innenzehner: 1  
 weiteste: 1190 (19), 1066 (15), 1005 (13)  
 beste Teiler 66.0 (16.) 225.8 (18.) 296.9 (3.)  
 Trefferlage 0.73 mm rechts, 0.95 mm tief  
 Streuwert 4.89, horizontal: 6.18, vertikal: 3.11

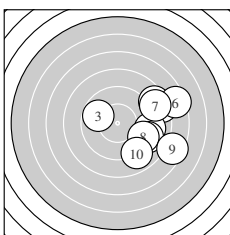
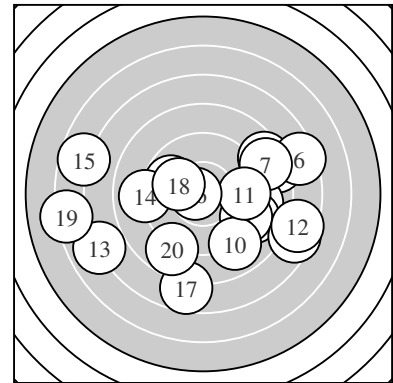

Serie 1:

8.2 →                      9.1 →                      9.8 ←                      8.5 ↗                      9.0 ↘  
 7.4 →                      8.6 →                      9.3 ↘                      7.5 ↘                      8.9 ↘

beste Teiler 296.9 (3.) 418.2 (8.) 470.0 (2.)  
 Trefferlage 4.57 mm rechts, 0.05 mm tief  
 Streuwert 2.97, horizontal: 3.11, vertikal: 2.83

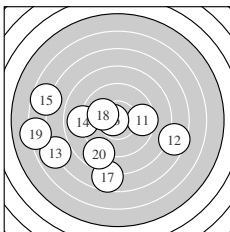

Serie 2:

9.5 →                      7.5 →                      6.9 ←                      9.0 ←                      6.7 ←  
 10.7 \*                      7.7 ↓                      10.1 ←                      6.2 ←                      8.8 ↙

beste Teiler 66.0 (16.) 225.8 (18.) 355.0 (11.)  
 Trefferlage 3.11 mm links, 1.84 mm tief  
 Streuwert 4.94, horizontal: 6.18, vertikal: 3.26

Unterschrift des Schützen

Ergebnis: **186.2** (179)  
 Serien: 94.9 91.3  
 Zähler: 8 6 4 1 1 0 0 0 0 0  
 Innenzehner: 5  
 weiteste: 1082 (18), 911 (11), 734 (15)  
 beste Teiler 144.5 (4.) 171.7 (12.) 176.7 (2.)  
 Trefferlage 0.59 mm rechts, 0.30 mm tief  
 Streuwert 3.50, horizontal: 3.65, vertikal: 3.35

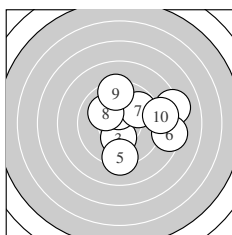
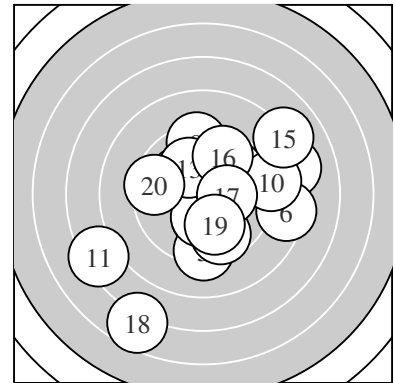

Serie 1:  
 8.2 → 10.2 \* 10.2 \* 10.4 \* 9.3 ↓  
 8.4 → 9.8 ↗ 10.1 ↖ 9.4 ↑ 8.9 →  
 beste Teiler 144.5 (4.) 176.7 (2.) 179.4 (3.)  
 Trefferlage 1.80 mm rechts, 0.56 mm hoch  
 Streuwert 2.72, horizontal: 3.06, vertikal: 2.33

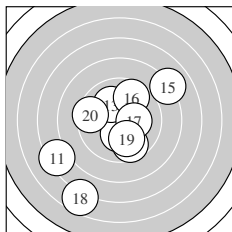

Serie 2:  
 7.3 ↙ 10.3 \* 10.1 ↖ 9.6 ↘ 8.0 ↗  
 9.7 ↗ 10.2 \* 6.6 ↙ 10.0 ↘ 9.5 ←  
 beste Teiler 171.7 (12.) 179.2 (17.) 222.8 (13.)  
 Trefferlage 0.61 mm links, 1.17 mm tief  
 Streuwert 4.00, horizontal: 3.94, vertikal: 4.06

Unterschrift des Schützen