

Ergebnis: **153** (163.8)  
 Serien: 75 78  
 Zähler: 2 6 3 3 4 2 0 0 0 0  
 Innenzehner: 0  
 weiteste: 4113 (2), 4071 (1), 3509 (18)  
 beste Teiler 741.7 (9.) 790.3 (4.) 820.1 (15.)  
 Trefferlage 4.09 mm links, 10.39 mm tief  
 Streuwert 16.26, horizontal: 15.20, vertikal: 17.24

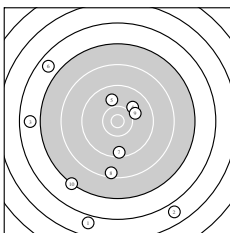

Serie 1:  
 5.9 ↓                      5.8 ↘                      6.7 ←                      10.0 ↗                      9.9 ↑  
 6.7 ↖                      9.5 ↓                      8.5 ↓                      10.0 →                      7.2 ↙  
 beste Teiler 741.7 (9.) 790.3 (4.) 848.5 (5.)  
 Trefferlage 5.90 mm links, 9.22 mm tief  
 Streuwert 18.35, horizontal: 16.67, vertikal: 19.89

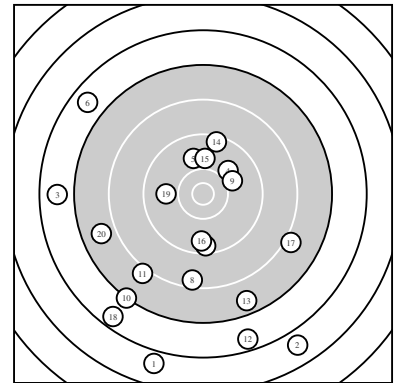
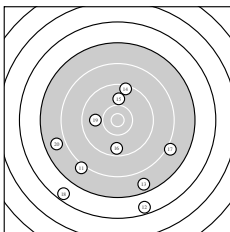

Serie 2:  
 8.1 ↗                      6.6 ↓                      7.6 ↓                      9.4 ↑                      9.9 ↑  
 9.6 ↓                      8.1 ↘                      6.6 ↙                      9.9 ←                      7.8 ←  
 beste Teiler 820.1 (15.) 854.0 (19.) 1085.6 (16.)  
 Trefferlage 2.29 mm links, 11.57 mm tief  
 Streuwert 14.70, horizontal: 14.24, vertikal: 15.14

Unterschrift des Schützen

Ergebnis: **173.1** (162)  
 Serien: 83.0 90.1  
 Zähler: 3 6 4 4 3 0 0 0 0 0  
 Innenzehner: 2  
 weiteste: 1112 (9), 1025 (16), 1004 (20)  
 beste Teiler 125.7 (17.) 195.5 (14.) 235.8 (5.)  
 Trefferlage 1.07 mm links, 0.55 mm tief  
 Streuwert 4.56, horizontal: 5.68, vertikal: 3.07

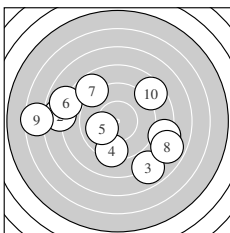
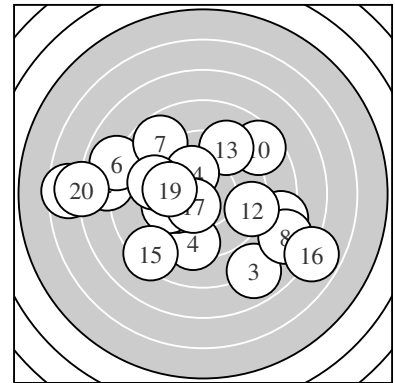

Serie 1:  
 8.3 →                      7.8 ←                      7.9 ↘                      9.3 ↓                      10.0 ←  
 7.9 ↖                      8.8 ↗                      7.9 →                      6.5 ←                      8.6 ↗  
 beste Teiler 235.8 (5.) 412.4 (4.) 550.9 (7.)  
 Trefferlage 1.06 mm links, 0.52 mm tief  
 Streuwert 5.17, horizontal: 6.42, vertikal: 3.52

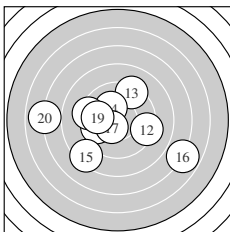

Serie 2:  
 9.7 ←                      9.3 →                      9.2 ↗                      10.2 \*                      8.3 ↘  
 6.9 →                      10.5 \*                      9.3 ←                      9.8 ←                      6.9 ←  
 beste Teiler 125.7 (17.) 195.5 (14.) 278.7 (19.)  
 Trefferlage 1.08 mm links, 0.58 mm tief  
 Streuwert 4.14, horizontal: 5.18, vertikal: 2.74

Unterschrift des Schützen

Ergebnis: **191.7** (183)  
 Serien: 93.8 97.9  
 Zähler: 7 9 4 0 0 0 0 0 0 0  
 Innenzehner: 4  
 weiteste: 606 (1), 561 (10), 547 (19)  
 beste Teiler 92.6 (2.) 154.4 (16.) 171.8 (9.)  
 Trefferlage 0.93 mm links, 0.29 mm tief  
 Streuwert 2.63, horizontal: 3.36, vertikal: 1.59

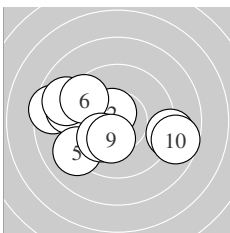
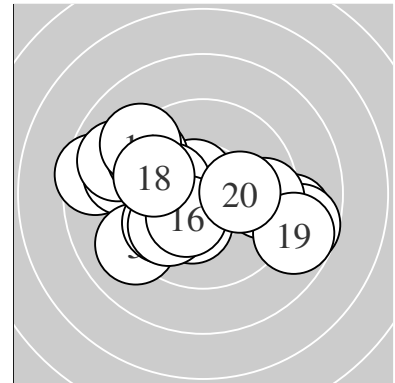

Serie 1:  
 8.5 ←                      10.6 \*                      9.1 ←                      8.9 ↖                      9.1 ↗  
 9.5 ↘                      9.0 →                      10.1 ↗                      10.3 \*                      8.7 →  
 beste Teiler 92.6 (2.) 171.8 (9.) 214.9 (8.)  
 Trefferlage 1.43 mm links, 0.19 mm tief  
 Streuwert 3.00, horizontal: 3.88, vertikal: 1.73

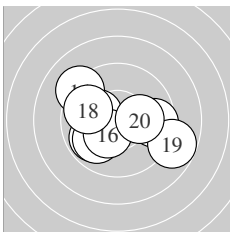

Serie 2:  
 9.9 ↗                      10.2 \*                      10.1 ↗                      9.2 ↘                      9.9 ↗  
 10.3 \*                      9.6 →                      9.8 ↖                      8.8 →                      10.1 →  
 beste Teiler 154.4 (16.) 191.0 (12.) 204.2 (20.)  
 Trefferlage 0.43 mm links, 0.39 mm tief  
 Streuwert 2.30, horizontal: 2.87, vertikal: 1.53

Unterschrift des Schützen

Ergebnis: **163.3** (155)  
 Serien: 80.2 83.1  
 Zähler: 3 2 8 4 1 1 1 0 0 0  
 Innenzehner: 3  
 weiteste: 1640 (6), 1462 (18), 1135 (15)  
 beste Teiler 79.3 (14.) 101.1 (13.) 173.2 (3.)  
 Trefferlage 1.25 mm links, 3.64 mm tief  
 Streuwert 5.04, horizontal: 5.33, vertikal: 4.72

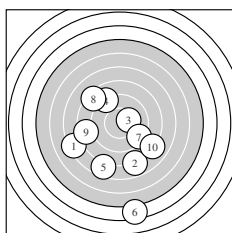
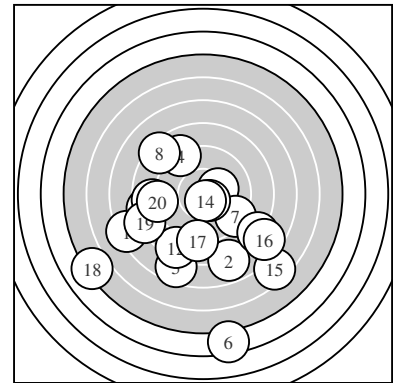

Serie 1:  
 7.2 ↙                      7.8 ↓                      10.3 \*                      9.0 ↗                      7.6 ↓  
 4.4 ↓                      9.2 ↘                      8.3 ↖                      8.4 ←                      8.0 ↘  
 beste Teiler 173.2 (3.) 431.3 (7.) 487.4 (4.)  
 Trefferlage 0.79 mm links, 3.45 mm tief  
 Streuwert 5.50, horizontal: 4.78, vertikal: 6.14

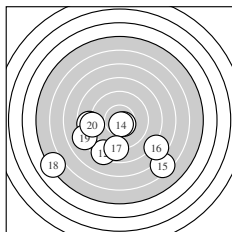

Serie 2:  
 8.7 ←                      8.3 ↙                      10.5 \*                      10.6 \*                      6.4 ↘  
 7.6 ↘                      8.9 ↓                      5.1 ↖                      8.1 ←                      8.9 ←  
 beste Teiler 79.3 (14.) 101.1 (13.) 505.6 (20.)  
 Trefferlage 1.71 mm links, 3.83 mm tief  
 Streuwert 4.80, horizontal: 6.06, vertikal: 3.05

Unterschrift des Schützen

Ergebnis: **194.9** (186)  
 Serien: 100.2 94.7  
 Zähler: 8 10 2 0 0 0 0 0 0 0  
 Innenzehner: 6  
 weiteste: 536 (17), 517 (18), 483 (13)  
 beste Teiler 123.1 (7.) 136.2 (10.) 141.0 (6.)  
 Trefferlage 1.06 mm links, 0.67 mm tief  
 Streuwert 2.19, horizontal: 2.23, vertikal: 2.16

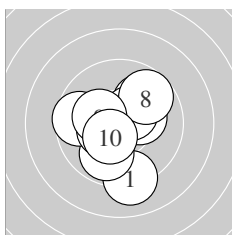
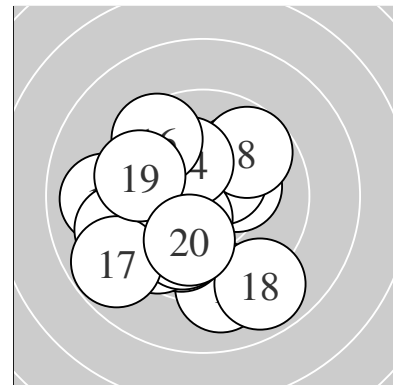

Serie 1:  
 9.1 ↓                      9.9 ↙                      10.0 ↗                      9.6 ←                      10.3 \*  
 10.4 \*                      10.5 \*                      9.7 ↗                      10.3 \*                      10.4 \*  
 beste Teiler 123.1 (7.) 136.2 (10.) 141.0 (6.)  
 Trefferlage 0.08 mm links, 0.25 mm tief  
 Streuwert 1.90, horizontal: 1.79, vertikal: 2.01

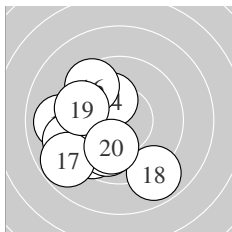

Serie 2:  
 9.6 ↗                      9.9 ↙                      9.0 ←                      10.2 \*                      9.2 ←  
 9.5 ↘                      8.8 ↙                      8.9 ↘                      9.6 ←                      10.0 ↓  
 beste Teiler 181.7 (14.) 228.3 (20.) 257.6 (12.)  
 Trefferlage 2.04 mm links, 1.10 mm tief  
 Streuwert 2.30, horizontal: 2.27, vertikal: 2.32

Unterschrift des Schützen

Ergebnis: **173.7** (165)  
 Serien: 91.3 82.4  
 Zähler: 5 4 5 3 3 0 0 0 0 0  
 Innenzehner: 4  
 weiteste: 1170 (18), 1035 (5), 1023 (15)  
 beste Teiler 35.6 (3.) 149.8 (12.) 162.1 (2.)  
 Trefferlage 0.63 mm links, 1.07 mm hoch  
 Streuwert 4.69, horizontal: 6.13, vertikal: 2.55

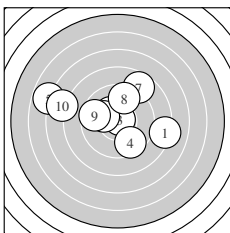
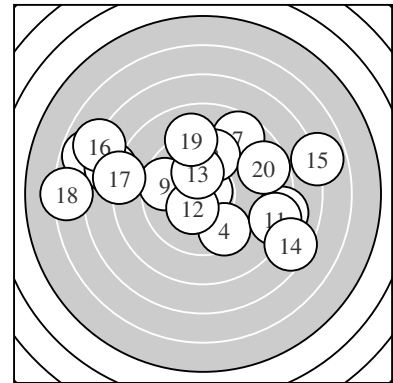

Serie 1:  
 8.2 ➤ 10.3 \* 10.8 \* 9.5 ↘ 6.8 ↖  
 10.1 ↖ 8.7 ↗ 9.6 ↗ 7.7 ↖  
 beste Teiler 35.6 (3.) 162.1 (2.) 208.4 (6.)  
 Trefferlage 1.12 mm links, 1.19 mm hoch  
 Streuwert 3.89, horizontal: 4.96, vertikal: 2.35

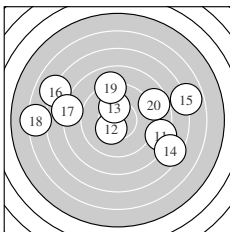

Serie 2:  
 8.3 ➤ 10.4 \* 10.2 \* 7.5 ↘ 6.9 ➔  
 7.0 ↖ 8.0 ↖ 6.3 ↖ 9.1 ↑ 8.7 ➔  
 beste Teiler 149.8 (12.) 190.8 (13.) 475.0 (19.)  
 Trefferlage 0.15 mm links, 0.96 mm hoch  
 Streuwert 5.58, horizontal: 7.36, vertikal: 2.86

Unterschrift des Schützen

Ergebnis: **169.3** (163)  
 Serien: 87.6 81.7  
 Zähler: 1 11 5 2 0 0 0 0 0 0  
 Innenzehner: 1  
 weiteste: 4638 (15), 980 (10), 782 (1)  
 beste Teiler 110.5 (16.) 305.8 (12.) 338.8 (3.)  
 Trefferlage 0.82 mm rechts, 0.61 mm tief  
 Streuwert 8.41, horizontal: 9.21, vertikal: 7.53

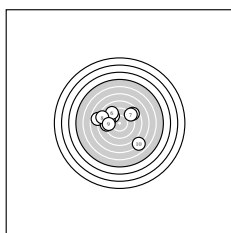
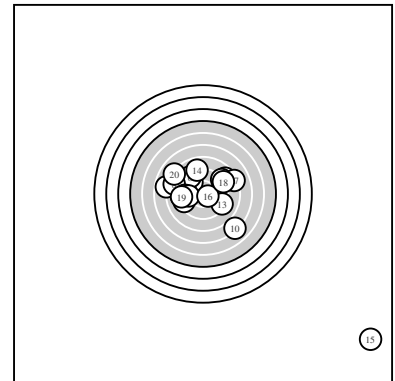

Serie 1:  
 7.8 ←                      8.7 ↗                      9.6 ↘                      9.1 ←                      9.4 ←  
 9.2 ↘                      9.0 ↗                      8.4 ←                      9.4 ←                      7.0 ↘  
 beste Teiler 338.8 (3.) 381.0 (9.) 383.7 (5.)  
 Trefferlage 1.55 mm links, 0.87 mm hoch  
 Streuwert 4.11, horizontal: 4.87, vertikal: 3.17

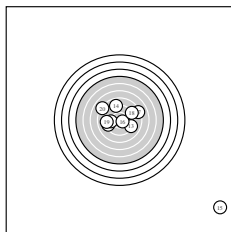

Serie 2:  
 9.2 ←                      9.7 ←                      9.2 ↘                      8.9 ↑                      0.0 ↘  
 10.5 \*                      8.1 →                      9.0 ↗                      9.1 ←                      8.0 ↘  
 beste Teiler 110.5 (16.) 305.8 (12.) 426.7 (11.)  
 Trefferlage 3.20 mm rechts, 2.10 mm tief  
 Streuwert 11.13, horizontal: 11.95, vertikal: 10.24

Unterschrift des Schützen

Ergebnis: **183.8** (174)  
 Serien: 89.2 94.6  
 Zähler: 4 9 5 1 1 0 0 0 0 0  
 Innenzehner: 3  
 weiteste: 1058 (9), 803 (8), 651 (17)  
 beste Teiler 97.1 (6.) 124.4 (13.) 175.8 (16.)  
 Trefferlage 1.11 mm links, 0.21 mm tief  
 Streuwert 3.53, horizontal: 3.29, vertikal: 3.75

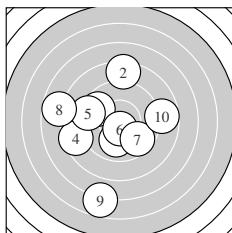
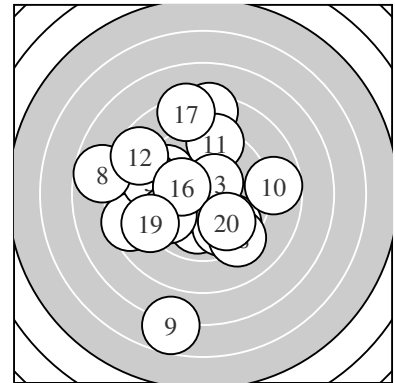

Serie 1:  
 10.0 ↓                      8.4 ↑                      9.7 ↖                      8.5 ←                      9.3 ←  
 10.6 \*                      9.6 ↘                      7.7 ←                      6.7 ↓                      8.7 →  
 beste Teiler 97.1 (6.) 245.9 (1.) 324.1 (3.)  
 Trefferlage 1.51 mm links, 0.68 mm tief  
 Streuwert 4.12, horizontal: 3.93, vertikal: 4.29

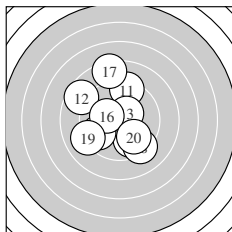

Serie 2:  
 9.3 ↑                      8.6 ↖                      10.5 \*                      9.8 ↘                      9.7 ←  
 10.3 \*                      8.3 ↑                      9.2 ↘                      9.1 ←                      9.8 ↘  
 beste Teiler 124.4 (13.) 175.8 (16.) 284.3 (20.)  
 Trefferlage 0.70 mm links, 0.26 mm hoch  
 Streuwert 2.99, horizontal: 2.65, vertikal: 3.29

Unterschrift des Schützen



Ergebnis: **185.4** (176)  
 Serien: 92.8 92.6  
 Zähler: 5 9 5 0 0 1 0 0 0 0  
 Innenzehner: 4  
 weiteste: 1381 (2), 724 (17), 673 (11)  
 beste Teiler 63.6 (8.) 126.9 (6.) 163.2 (4.)  
 Trefferlage 0.12 mm links, 0.24 mm tief  
 Streuwert 3.70, horizontal: 4.68, vertikal: 2.34

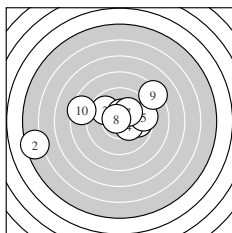
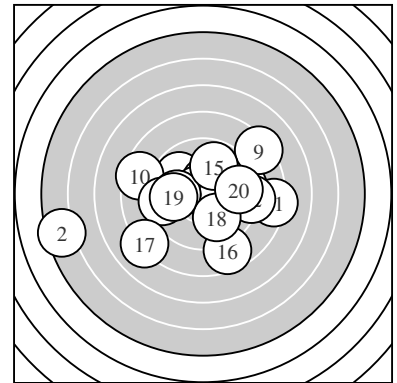

Serie 1:  
 9.8 →                      5.4 ←                      9.8 ↖                      10.3 \*                      9.4 →  
 10.4 \*                      10.2 \*                      10.7 \*                      8.3 ↗                      8.5 ←  
 beste Teiler 63.6 (8.) 126.9 (6.) 163.2 (4.)  
 Trefferlage 0.70 mm links, 0.66 mm hoch  
 Streuwert 4.11, horizontal: 5.45, vertikal: 2.02

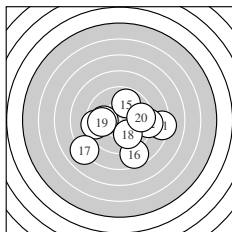

Serie 2:  
 8.3 →                      9.1 →                      10.0 ←                      9.4 ←                      9.8 ↗  
 8.6 ↓                      8.1 ↙                      9.9 ↓                      9.8 ←                      9.6 →  
 beste Teiler 248.0 (13.) 255.8 (18.) 279.5 (19.)  
 Trefferlage 0.46 mm rechts, 1.14 mm tief  
 Streuwert 3.27, horizontal: 3.97, vertikal: 2.37

Unterschrift des Schützen

Ergebnis: **193.7** (184)  
 Serien: 96.9 96.8  
 Zähler: 5 14 1 0 0 0 0 0 0 0  
 Innenzehner: 3  
 weiteste: 518 (6), 483 (14), 446 (20)  
 beste Teiler 80.5 (16.) 80.9 (1.) 174.4 (11.)  
 Trefferlage 0.06 mm links, 0.04 mm tief  
 Streuwert 2.46, horizontal: 2.94, vertikal: 1.86

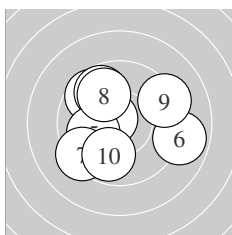
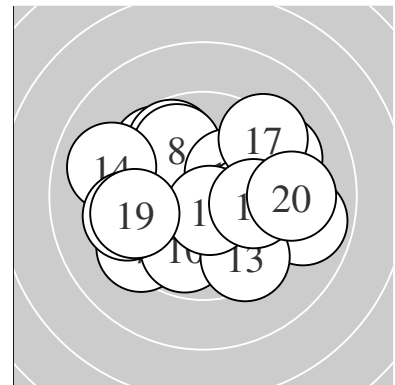

Serie 1:  
 10.6 \*                      9.8 ↙                      9.6 ↘                      9.7 ↘                      10.0 ←  
 8.9 →                      9.3 ↙                      9.9 ↘                      9.3 →                      9.8 ↓  
 beste Teiler 80.9 (1.) 235.0 (5.) 272.1 (8.)  
 Trefferlage 0.54 mm links, 0.00 mm  
 Streuwert 2.46, horizontal: 2.72, vertikal: 2.16

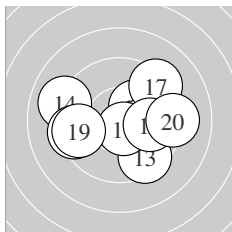

Serie 2:  
 10.3 \*                      10.1 →                      9.5 ↘                      9.0 ↖                      9.4 ←  
 10.6 \*                      9.3 ↗                      9.9 →                      9.5 ←                      9.2 →  
 beste Teiler 80.5 (16.) 174.4 (11.) 225.8 (12.)  
 Trefferlage 0.41 mm rechts, 0.09 mm tief  
 Streuwert 2.54, horizontal: 3.21, vertikal: 1.62

Unterschrift des Schützen

Ergebnis: **199.7** (193)  
 Serien: 101.1 98.6  
 Zähler: 13 7 0 0 0 0 0 0 0 0  
 Innenzehner: 8  
 weiteste: 417 (11), 401 (19), 353 (2)  
 beste Teiler 126.4 (7.) 130.6 (5.) 141.7 (1.)  
 Trefferlage 0.37 mm rechts, 0.17 mm hoch  
 Streuwert 1.82, horizontal: 1.75, vertikal: 1.89

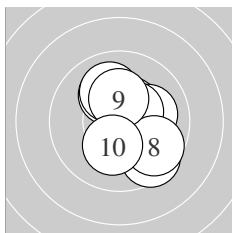
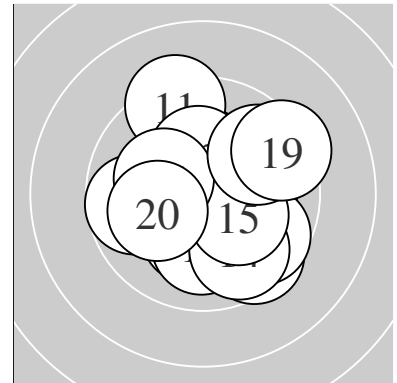

Serie 1:  
 10.4 \*                      9.5 ↘                      10.1 ↗                      10.0 ↗                      10.4 \*  
 10.1 →                      10.4 \*                      9.7 ↘                      10.3 \*                      10.2 \*  
 beste Teiler 126.4 (7.) 130.6 (5.) 141.7 (1.)  
 Trefferlage 0.67 mm rechts, 0.04 mm hoch  
 Streuwert 1.56, horizontal: 1.29, vertikal: 1.80

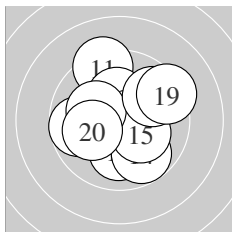

Serie 2:  
 9.3 ↗                      10.0 ↓                      10.3 \*                      9.8 ↘                      10.2 \*  
 9.7 ←                      10.2 \*                      9.7 ↗                      9.3 ↗                      10.1 ←  
 beste Teiler 171.2 (13.) 185.2 (15.) 189.0 (17.)  
 Trefferlage 0.08 mm rechts, 0.31 mm hoch  
 Streuwert 2.11, horizontal: 2.15, vertikal: 2.06

Unterschrift des Schützen

Ergebnis: **195.1** (188)  
 Serien: 95.6 99.5  
 Zähler: 11 7 1 1 0 0 0 0 0 0  
 Innenzehner: 7  
 weiteste: 901 (2), 595 (8), 445 (20)  
 beste Teiler 76.1 (19.) 90.8 (7.) 114.2 (11.)  
 Trefferlage 1.35 mm rechts, 0.61 mm tief  
 Streuwert 2.32, horizontal: 2.85, vertikal: 1.64

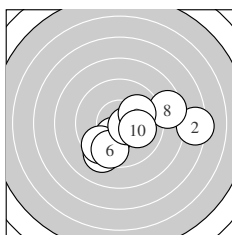
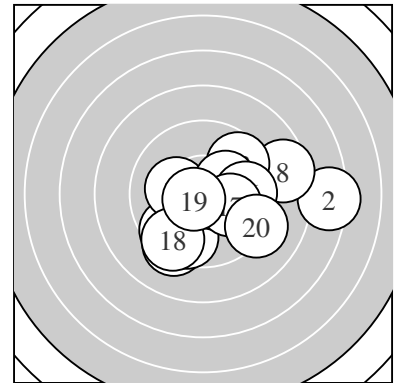

Serie 1:  
 9.3 ↙                      7.3 →                      10.3 \*                      9.6 ↙                      10.2 \*  
 9.6 ↙                      10.6 \*                      8.6 →                      10.0 ↗                      10.1 →  
 beste Teiler 90.8 (7.) 169.5 (3.) 193.0 (5.)  
 Trefferlage 1.54 mm rechts, 0.94 mm tief  
 Streuwert 2.81, horizontal: 3.57, vertikal: 1.75

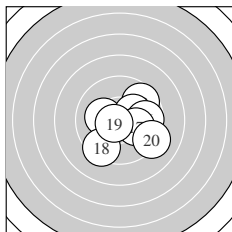

Serie 2:  
 10.5 \*                      10.0 →                      9.6 ↗                      10.2 \*                      10.2 \*  
 9.7 →                      10.1 ↘                      9.4 ↙                      10.6 \*                      9.2 ↘  
 beste Teiler 76.1 (19.) 114.2 (11.) 180.7 (15.)  
 Trefferlage 1.16 mm rechts, 0.29 mm tief  
 Streuwert 1.82, horizontal: 2.06, vertikal: 1.54

Unterschrift des Schützen

Ergebnis: **167.0** (160)  
 Serien: 80.7 86.3  
 Zähler: 4 3 9 0 2 1 1 0 0 0  
 Innenzehner: 4  
 weiteste: 1609 (2), 1344 (1), 1217 (9)  
 beste Teiler 157.4 (20.) 175.8 (4.) 180.7 (3.)  
 Trefferlage 1.54 mm rechts, 1.91 mm tief  
 Streuwert 5.25, horizontal: 6.02, vertikal: 4.36

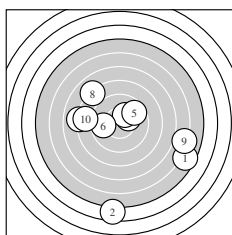
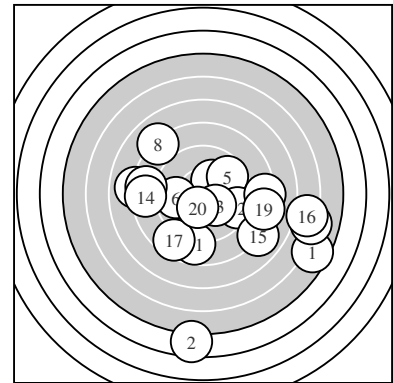

Serie 1:  
 5.6 ↘                      4.5 ↓                      10.2 \*                      10.3 \*                      9.7 ↗  
 9.8 ←                      8.0 ←                      8.0 ↖                      6.1 →                      8.5 ←  
 beste Teiler 175.8 (4.) 180.7 (3.) 296.7 (6.)  
 Trefferlage 0.61 mm rechts, 1.48 mm tief  
 Streuwert 6.39, horizontal: 6.77, vertikal: 5.99

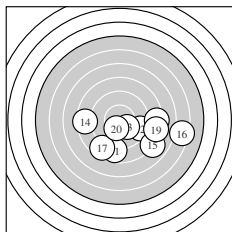

Serie 2:  
 8.7 ↓                      9.3 ↘                      10.2 \*                      8.4 ←                      8.0 ↘  
 6.3 →                      8.6 ↙                      8.3 →                      8.2 →                      10.3 \*  
 beste Teiler 157.4 (20.) 183.3 (13.) 404.2 (12.)  
 Trefferlage 2.48 mm rechts, 2.34 mm tief  
 Streuwert 4.03, horizontal: 5.35, vertikal: 1.95

Unterschrift des Schützen

Ergebnis: **200.4** (191)  
 Serien: 100.3 100.1  
 Zähler: 11 9 0 0 0 0 0 0 0 0  
 Innenzehner: 8  
 weiteste: 400 (3), 389 (18), 363 (14)  
 beste Teiler 22.3 (17.) 122.8 (19.) 125.4 (7.)  
 Trefferlage 0.09 mm rechts, 0.70 mm tief  
 Streuwert 1.83, horizontal: 2.10, vertikal: 1.50

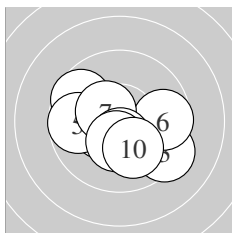
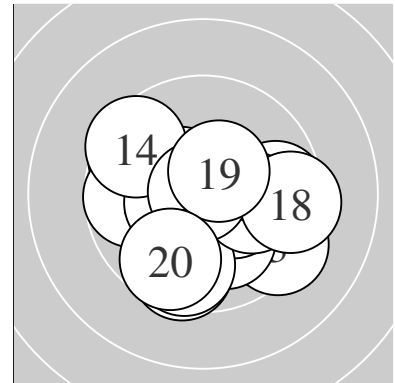

Serie 1:  
 10.0 → 10.4 \* 9.4 ↘ 9.7 ↖ 9.7 ←  
 9.7 → 10.5 \* 10.4 \* 10.4 \* 10.1 ↘  
 beste Teiler 125.4 (7.) 126.1 (8.) 138.7 (2.)  
 Trefferlage 0.14 mm rechts, 0.60 mm tief  
 Streuwert 1.84, horizontal: 2.30, vertikal: 1.20

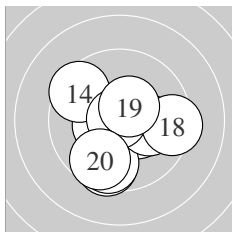

Serie 2:  
 9.6 ↓ 10.4 \* 10.4 \* 9.5 ↖ 9.6 ↓  
 10.1 → 10.9 \* 9.4 → 10.5 \* 9.7 ↓  
 beste Teiler 22.3 (17.) 122.8 (19.) 130.6 (13.)  
 Trefferlage 0.04 mm rechts, 0.79 mm tief  
 Streuwert 1.91, horizontal: 2.00, vertikal: 1.81

Unterschrift des Schützen

Ergebnis: **188.7** (179)  
 Serien: 93.1 95.6  
 Zähler: 5 11 3 0 1 0 0 0 0 0  
 Innenzehner: 3  
 weiteste: 1021 (3), 610 (19), 573 (9)  
 beste Teiler 60.1 (12.) 114.1 (8.) 150.4 (6.)  
 Trefferlage 0.56 mm links, 1.69 mm hoch  
 Streuwert 2.88, horizontal: 3.58, vertikal: 1.95

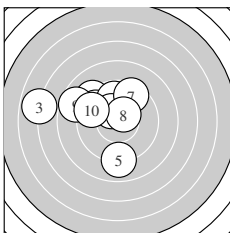
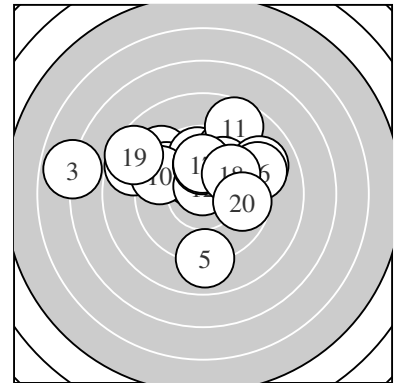

Serie 1:  
 9.2 ↘                      9.6 ↘                      6.9 ←                      9.8 ↑                      9.0 ↓  
 10.4 \*                      9.5 ↗                      10.5 \*                      8.7 ↖                      9.5 ↖  
 beste Teiler 114.1 (8.) 150.4 (6.) 291.3 (4.)  
 Trefferlage 2.33 mm links, 1.35 mm hoch  
 Streuwert 2.97, horizontal: 3.47, vertikal: 2.35

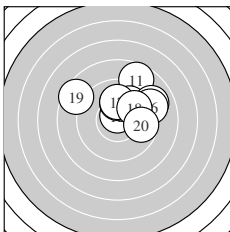

Serie 2:  
 8.7 ↗                      10.7 \*                      9.9 ↗                      9.0 →                      10.1 ↑  
 9.1 →                      10.0 ↑                      9.9 ↗                      8.5 ↖                      9.7 →  
 beste Teiler 60.1 (12.) 222.1 (15.) 233.0 (17.)  
 Trefferlage 1.21 mm rechts, 2.03 mm hoch  
 Streuwert 2.26, horizontal: 2.82, vertikal: 1.50

Unterschrift des Schützen

Ergebnis: **192.8** (182)  
 Serien: 96.7 96.1  
 Zähler: 7 8 5 0 0 0 0 0 0 0  
 Innenzehner: 5  
 weiteste: 613 (3), 586 (20), 567 (17)  
 beste Teiler 81.5 (19.) 97.6 (9.) 125.7 (8.)  
 Trefferlage 1.65 mm rechts, 0.95 mm hoch  
 Streuwert 2.28, horizontal: 2.60, vertikal: 1.91

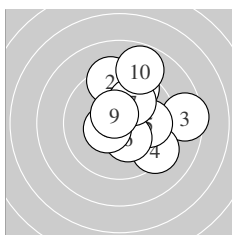
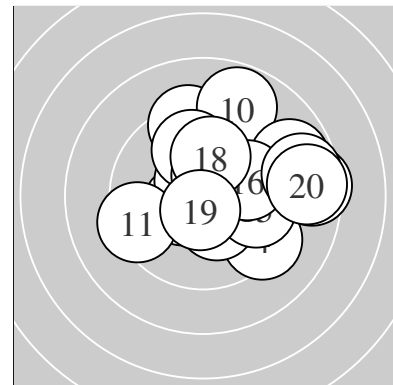

Serie 1:  
 9.5 ↗                      9.3 ↑                      8.5 →                      9.3 ↘                      9.9 →  
 10.3 \*                      10.0 ↗                      10.5 \*                      10.6 \*                      8.8 ↑  
 beste Teiler 97.6 (9.) 125.7 (8.) 157.6 (6.)  
 Trefferlage 1.49 mm rechts, 1.12 mm hoch  
 Streuwert 2.29, horizontal: 2.19, vertikal: 2.39

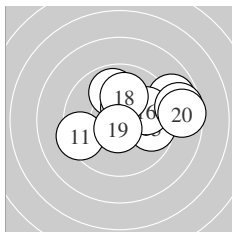

Serie 2:  
 9.4 ↙                      9.9 ↑                      8.8 ↗                      10.4 \*                      9.7 →  
 9.9 →                      8.7 →                      10.1 ↑                      10.6 \*                      8.6 →  
 beste Teiler 81.5 (19.) 126.0 (14.) 224.9 (18.)  
 Trefferlage 1.80 mm rechts, 0.78 mm hoch  
 Streuwert 2.38, horizontal: 3.07, vertikal: 1.37

Unterschrift des Schützen



Ergebnis: **185.5** (176)  
 Serien: 91.5 94.0  
 Zähler: 4 11 2 3 0 0 0 0 0 0  
 Innenzehner: 4  
 weiteste: 850 (7), 799 (5), 796 (6)  
 beste Teiler 86.8 (18.) 98.7 (1.) 134.8 (3.)  
 Trefferlage 1.27 mm rechts, 0.88 mm hoch  
 Streuwert 3.27, horizontal: 3.90, vertikal: 2.49

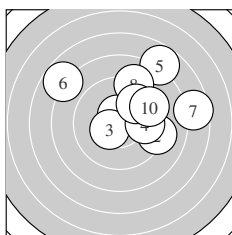
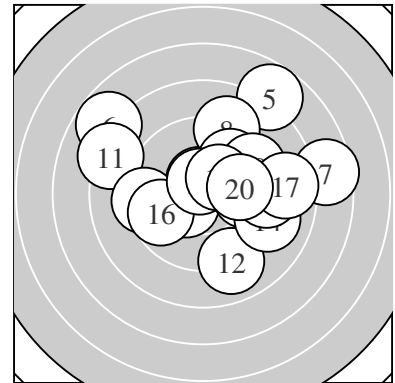

Serie 1:  
 10.6 \*                      9.2 →                      10.4 \*                      9.8 →                      7.8 ↗  
 7.8 ↘                      7.6 →                      9.1 ↑                      9.8 ↗                      9.4 ↗  
 beste Teiler 98.7 (1.) 134.8 (3.) 287.3 (9.)  
 Trefferlage 1.90 mm rechts, 2.01 mm hoch  
 Streuwert 3.33, horizontal: 3.96, vertikal: 2.54

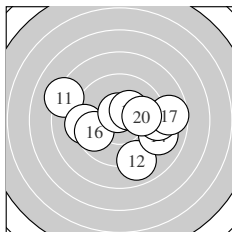

Serie 2:  
 8.2 ↖                      9.0 ↓                      9.3 ←                      9.1 →                      9.2 →  
 9.7 ←                      8.7 →                      10.6 \*                      10.3 \*                      9.9 →  
 beste Teiler 86.8 (18.) 154.8 (19.) 255.1 (20.)  
 Trefferlage 0.64 mm rechts, 0.24 mm tief  
 Streuwert 3.11, horizontal: 3.95, vertikal: 1.95

Unterschrift des Schützen

Ergebnis: **198.9** (191)  
 Serien: 99.5 99.4  
 Zähler: 12 7 1 0 0 0 0 0 0 0  
 Innenzehner: 8  
 weiteste: 582 (6), 479 (19), 440 (17)  
 beste Teiler 40.7 (2.) 60.6 (3.) 106.8 (4.)  
 Trefferlage 0.28 mm links, 0.80 mm hoch  
 Streuwert 1.98, horizontal: 2.22, vertikal: 1.72

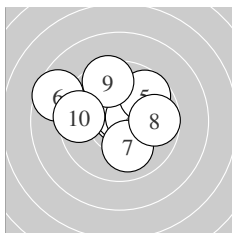
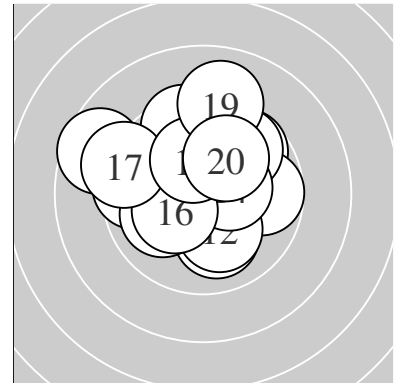

Serie 1:  
 10.5 \*                      10.8 \*                      10.7 \*                      10.5 \*                      9.7 ↗  
 8.6 ↖                      10.0 ↓                      9.7 →                      9.5 ↑                      9.5 ←  
 beste Teiler 40.7 (2.) 60.6 (3.) 106.8 (4.)  
 Trefferlage 0.18 mm links, 0.76 mm hoch  
 Streuwert 2.11, horizontal: 2.56, vertikal: 1.55

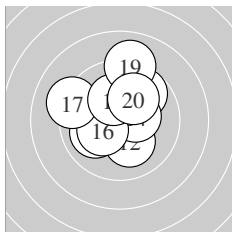

Serie 2:  
 10.3 \*                      10.1 ↓                      9.8 ↗                      10.4 \*                      10.0 ↖  
 10.3 \*                      9.2 ↖                      10.2 \*                      9.0 ↑                      10.1 ↗  
 beste Teiler 141.8 (14.) 171.1 (16.) 175.0 (11.)  
 Trefferlage 0.37 mm links, 0.84 mm hoch  
 Streuwert 1.96, horizontal: 1.95, vertikal: 1.96

Unterschrift des Schützen



Ergebnis: **183.5** (174)  
 Serien: 94.4 89.1  
 Zähler: 6 4 8 2 0 0 0 0 0 0  
 Innenzehner: 4  
 weiteste: 909 (15), 880 (20), 716 (6)  
 beste Teiler 84.3 (1.) 130.3 (16.) 138.0 (8.)  
 Trefferlage 0.22 mm rechts, 1.33 mm hoch  
 Streuwert 3.51, horizontal: 4.19, vertikal: 2.65

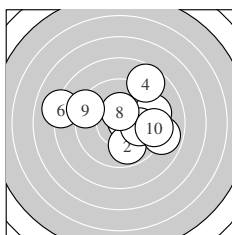
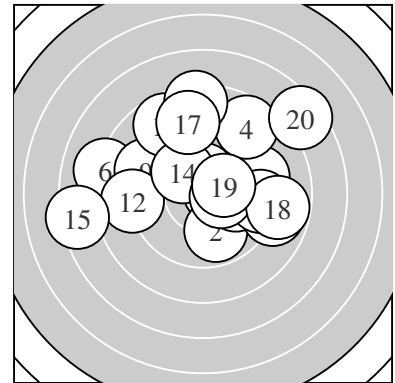

Serie 1:  
 10.6 \*                      9.9 ↓                      9.3 →                      8.7 ↗                      10.0 →  
 8.1 ←                      8.9 →                      10.4 \*                      9.2 ↖                      9.3 →  
 beste Teiler 84.3 (1.) 138.0 (8.) 236.9 (5.)  
 Trefferlage 0.91 mm rechts, 0.58 mm hoch  
 Streuwert 3.05, horizontal: 3.79, vertikal: 2.04

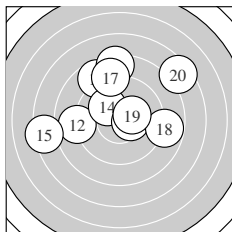

Serie 2:  
 8.7 ↖                      8.9 ←                      8.3 ↑                      10.1 ↘                      7.3 ←  
 10.4 \*                      8.9 ↑                      8.8 →                      10.3 \*                      7.4 ↗  
 beste Teiler 130.3 (16.) 159.1 (19.) 213.7 (14.)  
 Trefferlage 0.47 mm links, 2.07 mm hoch  
 Streuwert 3.94, horizontal: 4.64, vertikal: 3.08

Unterschrift des Schützen

Ergebnis: **188.2** (179)  
 Serien: 95.1 93.1  
 Zähler: 4 11 5 0 0 0 0 0 0 0  
 Innenzehner: 2  
 weiteste: 705 (18), 623 (6), 592 (2)  
 beste Teiler 131.4 (7.) 190.0 (1.) 222.3 (9.)  
 Trefferlage 0.14 mm links, 1.93 mm tief  
 Streuwert 2.66, horizontal: 3.22, vertikal: 1.94

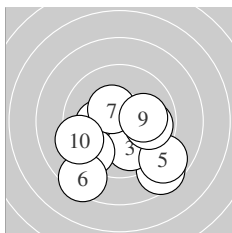
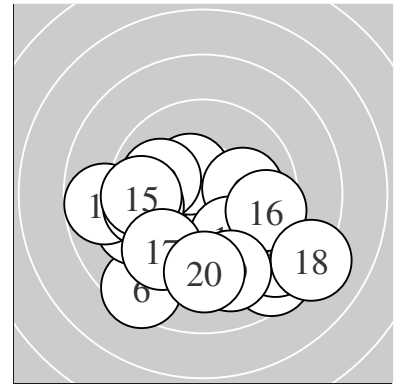

Serie 1:  
 10.2 \*                      8.6 ↘                      9.9 ↘                      9.4 ↙                      8.8 ↘  
    8.5 ↙                      10.4 \*                      9.9 →                      10.1 →                      9.3 ←  
 beste Teiler 131.4 (7.) 190.0 (1.) 222.3 (9.)  
 Trefferlage 0.12 mm rechts, 1.93 mm tief  
 Streuwert 2.59, horizontal: 2.99, vertikal: 2.12

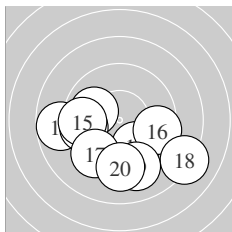

Serie 2:  
 8.8 ←                      10.0 ↖                      9.6 ←                      9.8 ↘                      9.6 ←  
    9.5 →                      9.4 ↙                      8.1 ↘                      9.1 ↘                      9.2 ↓  
 beste Teiler 249.8 (12.) 282.1 (14.) 338.8 (13.)  
 Trefferlage 0.42 mm links, 1.92 mm tief  
 Streuwert 2.85, horizontal: 3.57, vertikal: 1.86

Unterschrift des Schützen

Ergebnis: **192.2** (184)  
 Serien: 96.2 96.0  
 Zähler: 6 12 2 0 0 0 0 0 0 0  
 Innenzehner: 5  
 weiteste: 700 (13), 687 (12), 466 (1)  
 beste Teiler 80.6 (6.) 171.4 (14.) 182.0 (20.)  
 Trefferlage 0.79 mm links, 0.18 mm hoch  
 Streuwert 2.63, horizontal: 3.13, vertikal: 2.01

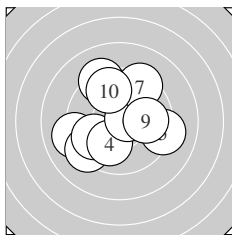
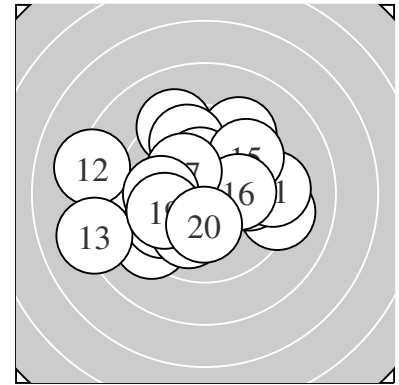

Serie 1:  
 9.1 ←                      9.3 ↙                      9.8 ↙                      10.0 ↓                      9.2 →  
 10.6 \*                      9.4 ↗                      9.2 ↘                      9.9 →                      9.7 ↗  
 beste Teiler 80.6 (6.) 236.2 (4.) 259.1 (9.)  
 Trefferlage 0.43 mm links, 0.18 mm hoch  
 Streuwert 2.62, horizontal: 2.77, vertikal: 2.46

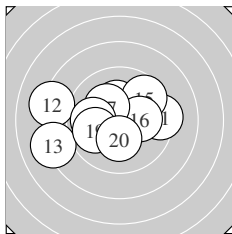

Serie 2:  
 9.3 →                      8.2 ←                      8.2 ←                      10.3 \*                      9.6 ↗  
 10.2 \*                      10.2 \*                      9.9 ←                      9.9 ←                      10.2 \*  
 beste Teiler 171.4 (14.) 182.0 (20.) 183.9 (17.)  
 Trefferlage 1.14 mm links, 0.19 mm hoch  
 Streuwert 2.76, horizontal: 3.57, vertikal: 1.57

Unterschrift des Schützen

Ergebnis: **190.4** (182)  
 Serien: 96.8 93.6  
 Zähler: 7 8 5 0 0 0 0 0 0 0  
 Innenzehner: 7  
 weiteste: 710 (7), 709 (6), 708 (18)  
 beste Teiler 81.1 (4.) 111.4 (9.) 117.3 (10.)  
 Trefferlage 0.40 mm links, 0.19 mm hoch  
 Streuwert 2.99, horizontal: 3.78, vertikal: 1.90

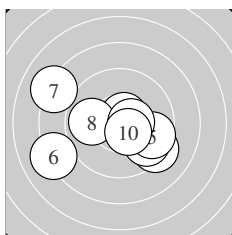
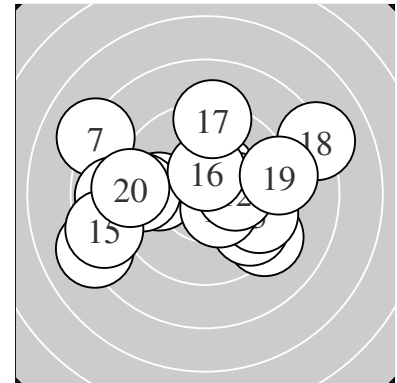

Serie 1:  
 10.5 \*                      9.3 ↘                      9.7 ↘                      10.6 \*                      9.6 ↘  
 8.1 ←                      8.1 ↖                      9.9 ←                      10.5 \*                      10.5 \*  
 beste Teiler 81.1 (4.) 111.4 (9.) 117.3 (10.)  
 Trefferlage 0.26 mm links, 0.54 mm tief  
 Streuwert 2.87, horizontal: 3.62, vertikal: 1.83

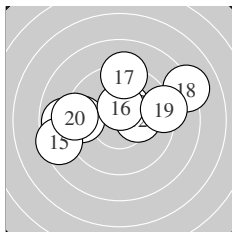

Serie 2:  
 10.4 \*                      10.3 \*                      8.8 ←                      9.5 ←                      8.5 ←  
 10.4 \*                      9.2 ↑                      8.1 ↗                      9.2 →                      9.2 ←  
 beste Teiler 127.3 (16.) 142.7 (11.) 175.4 (12.)  
 Trefferlage 0.54 mm links, 0.93 mm hoch  
 Streuwert 3.17, horizontal: 4.12, vertikal: 1.75

Unterschrift des Schützen

Ergebnis: **178.4** (171)  
 Serien: 88.5 89.9  
 Zähler: 2 8 9 1 0 0 0 0 0 0  
 Innenzehner: 2  
 weiteste: 918 (16), 750 (3), 744 (10)  
 beste Teiler 108.1 (17.) 120.2 (8.) 276.2 (9.)  
 Trefferlage 0.71 mm links, 1.16 mm hoch  
 Streuwert 3.85, horizontal: 4.64, vertikal: 2.86

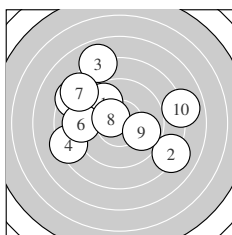
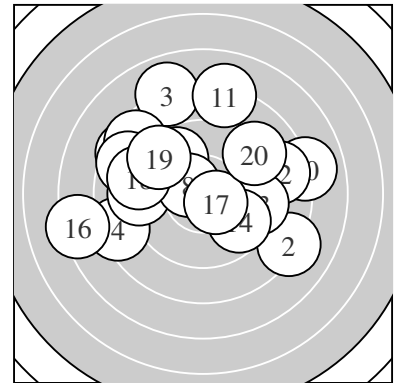

Serie 1:  
 9.7 ↖                      8.1 ↘                      8.0 ↗                      8.3 ↙                      8.5 ↘  
 9.1 ←                      8.5 ↖                      10.5 \*                      9.8 →                      8.0 →

beste Teiler 120.2 (8.) 276.2 (9.) 310.6 (1.)  
 Trefferlage 1.02 mm links, 1.14 mm hoch  
 Streuwert 4.03, horizontal: 4.77, vertikal: 3.13

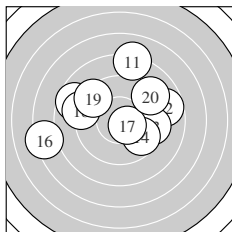

Serie 2:  
 8.1 ↑                      8.7 →                      9.4 →                      9.7 ↘                      8.7 ↖  
 7.3 ←                      10.5 \*                      9.1 ←                      9.3 ↖                      9.1 ↗

beste Teiler 108.1 (17.) 318.6 (14.) 388.0 (13.)  
 Trefferlage 0.41 mm links, 1.17 mm hoch  
 Streuwert 3.87, horizontal: 4.74, vertikal: 2.75

Unterschrift des Schützen



Ergebnis: **185.6** (179)  
 Serien: 92.0 93.6  
 Zähler: 5 9 6 0 0 0 0 0 0 0  
 Innenzehner: 4  
 weiteste: 726 (4), 718 (3), 690 (12)  
 beste Teiler 166.2 (17.) 170.4 (10.) 184.3 (18.)  
 Trefferlage 0.09 mm links, 0.18 mm hoch  
 Streuwert 3.29, horizontal: 3.63, vertikal: 2.92

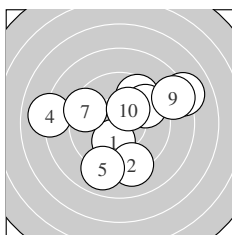
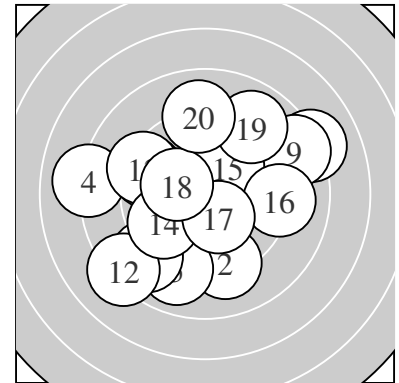

Serie 1:  
 10.2 \*                      9.2 ↓                      8.1 ↗                      8.0 ←                      9.0 ↓  
 9.6 ↗                      9.4 ↖                      9.7 ↗                      8.5 ↗                      10.3 \*  
 beste Teiler 170.4 (10.) 196.3 (1.) 318.9 (8.)  
 Trefferlage 0.55 mm rechts, 0.30 mm hoch  
 Streuwert 3.54, horizontal: 4.10, vertikal: 2.86

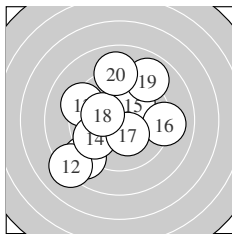

Serie 2:  
 8.8 ↗                      8.2 ↗                      9.3 ↖                      9.7 ↗                      10.1 ↗  
 9.1 →                      10.3 \*                      10.2 \*                      8.9 ↗                      9.0 ↑  
 beste Teiler 166.2 (17.) 184.3 (18.) 219.9 (15.)  
 Trefferlage 0.75 mm links, 0.06 mm hoch  
 Streuwert 3.15, horizontal: 3.16, vertikal: 3.13

Unterschrift des Schützen

Ergebnis: **185.8** (177)  
 Serien: 92.6 93.2  
 Zähler: 4 10 5 1 0 0 0 0 0 0  
 Innenzehner: 2  
 weiteste: 900 (5), 712 (20), 604 (12)  
 beste Teiler 75.8 (1.) 120.1 (18.) 209.9 (15.)  
 Trefferlage 0.72 mm links, 0.01 mm hoch  
 Streuwert 3.31, horizontal: 3.52, vertikal: 3.09

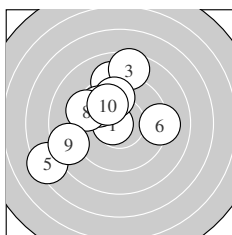
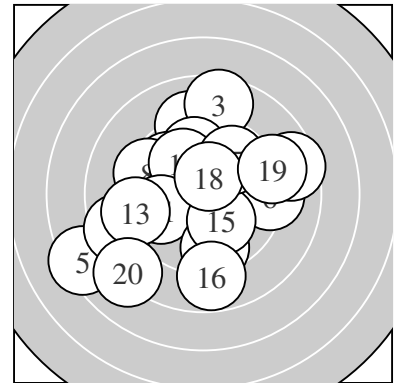

Serie 1:  
 10.7 \*                      9.1 ↑                      8.6 ↑                      9.8 ↑                      7.4 ↙  
 9.2 →                      9.8 ↘                      9.4 ↖                      8.6 ↖                      10.0 ↘  
 beste Teiler 75.8 (1.) 241.5 (10.) 284.9 (4.)  
 Trefferlage 1.74 mm links, 1.15 mm hoch  
 Streuwert 3.23, horizontal: 3.41, vertikal: 3.03

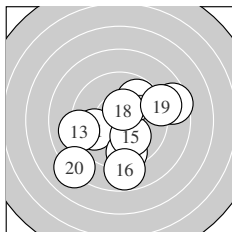

Serie 2:  
 9.8 ↙                      8.5 →                      9.1 ↖                      9.5 ↓                      10.1 ↘  
 8.8 ↓                      9.8 ↗                      10.5 \*                      9.0 →                      8.1 ↙  
 beste Teiler 120.1 (18.) 209.9 (15.) 290.9 (17.)  
 Trefferlage 0.29 mm rechts, 1.11 mm tief  
 Streuwert 3.19, horizontal: 3.50, vertikal: 2.84

Unterschrift des Schützen

Ergebnis: **191.9** (183)  
 Serien: 96.6 95.3  
 Zähler: 7 9 4 0 0 0 0 0 0 0  
 Innenzehner: 4  
 weiteste: 629 (15), 552 (4), 543 (12)  
 beste Teiler 172.7 (1.) 183.0 (17.) 188.3 (6.)  
 Trefferlage 0.98 mm rechts, 0.04 mm hoch  
 Streuwert 2.55, horizontal: 3.10, vertikal: 1.85

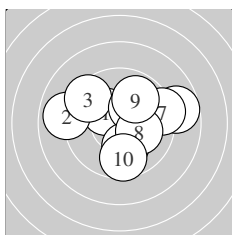
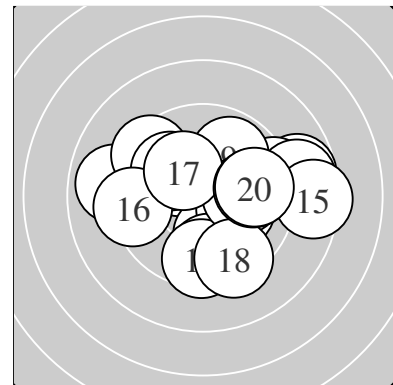

Serie 1:  
 10.3 \*                      8.9 ←                      9.4 ↘                      8.7 →                      10.1 ↓  
 10.2 \*                      9.3 →                      10.2 \*                      9.9 ↗                      9.6 ↓  
 beste Teiler 172.7 (1.) 188.3 (6.) 200.5 (8.)  
 Trefferlage 0.54 mm rechts, 0.40 mm hoch  
 Streuwert 2.55, horizontal: 3.09, vertikal: 1.88

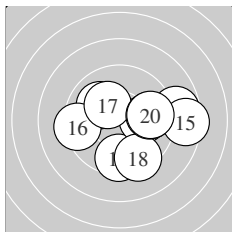

Serie 2:  
 9.5 ↓                      8.8 →                      10.1 →                      10.0 ↘                      8.4 →  
 9.3 ←                      10.2 \*                      9.4 ↓                      9.8 →                      9.8 →  
 beste Teiler 183.0 (17.) 220.0 (13.) 235.6 (14.)  
 Trefferlage 1.42 mm rechts, 0.31 mm tief  
 Streuwert 2.62, horizontal: 3.22, vertikal: 1.84

Unterschrift des Schützen

Ergebnis: **205.0** (195)  
 Serien: 101.3 103.7  
 Zähler: 15 5 0 0 0 0 0 0 0 0  
 Innenzehner: 13  
 weiteste: 446 (6), 353 (11), 302 (12)  
 beste Teiler 1.0 (14.) 42.5 (18.) 55.3 (19.)  
 Trefferlage 0.27 mm links, 0.40 mm hoch  
 Streuwert 1.49, horizontal: 1.55, vertikal: 1.42

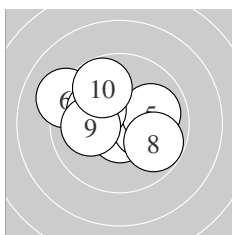
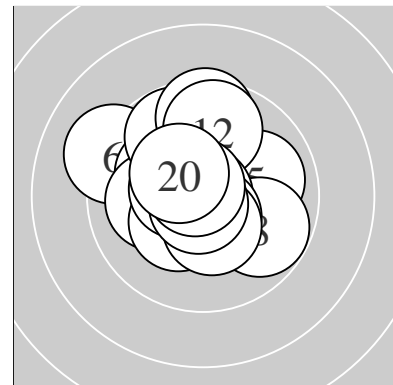

Serie 1:  
 10.7 \*                      10.5 \*                      10.7 \*                      10.3 \*                      10.0 →  
 9.2 ↖                      10.2 \*                      9.8 ↘                      10.1 ←                      9.8 ↗  
 beste Teiler 68.1 (1.) 74.1 (3.) 112.5 (2.)  
 Trefferlage 0.30 mm links, 0.37 mm hoch  
 Streuwert 1.75, horizontal: 2.15, vertikal: 1.22

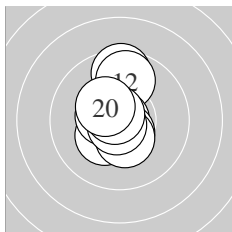

Serie 2:  
 9.5 ↑                      9.7 ↑                      10.3 \*                      10.9 \*                      10.5 \*  
 10.5 \*                      10.4 \*                      10.8 \*                      10.7 \*                      10.4 \*  
 beste Teiler 1.0 (14.) 42.5 (18.) 55.3 (19.)  
 Trefferlage 0.25 mm links, 0.44 mm hoch  
 Streuwert 1.26, horizontal: 0.64, vertikal: 1.66

Unterschrift des Schützen

Ergebnis: **188.9** (180)  
 Serien: 97.6 91.3  
 Zähler: 8 7 3 1 1 0 0 0 0 0  
 Innenzehner: 6  
 weiteste: 1062 (19), 805 (1), 658 (11)  
 beste Teiler 61.2 (10.) 112.0 (9.) 139.7 (3.)  
 Trefferlage 0.71 mm rechts, 0.13 mm hoch  
 Streuwert 3.21, horizontal: 3.89, vertikal: 2.33

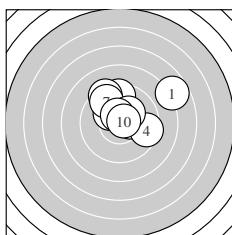
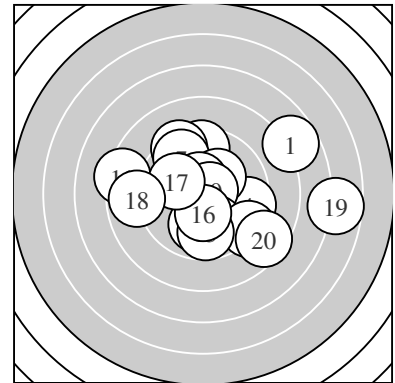

Serie 1:  
 7.7 ↗ 10.2 \* 10.4 \* 9.5 → 9.5 ↑  
 9.3 ↘ 9.6 ↘ 10.2 \* 10.5 \* 10.7 \*  
 beste Teiler 61.2 (10.) 112.0 (9.) 139.7 (3.)  
 Trefferlage 0.83 mm rechts, 1.74 mm hoch  
 Streuwert 2.27, horizontal: 2.72, vertikal: 1.70

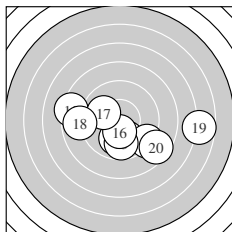

Serie 2:  
 8.3 ← 9.9 ↓ 10.0 ↓ 9.1 ↘ 9.7 ↓  
 10.3 \* 10.0 ← 8.8 ← 6.7 → 8.5 ↘  
 beste Teiler 152.0 (16.) 234.4 (17.) 246.5 (13.)  
 Trefferlage 0.58 mm rechts, 1.46 mm tief  
 Streuwert 3.70, horizontal: 4.95, vertikal: 1.70

Unterschrift des Schützen

Ergebnis: **200.6** (191)  
 Serien: 101.8 98.8  
 Zähler: 11 9 0 0 0 0 0 0 0 0  
 Innenzehner: 8  
 weiteste: 389 (14), 384 (19), 357 (16)  
 beste Teiler 68.6 (8.) 129.7 (5.) 135.5 (13.)  
 Trefferlage 0.27 mm links, 0.21 mm tief  
 Streuwert 1.76, horizontal: 1.78, vertikal: 1.74

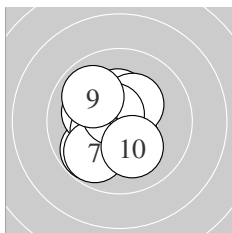
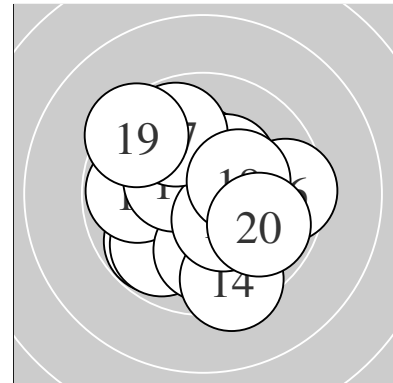

Serie 1:  
 9.8 ↙                      10.1 ↖                      10.3 \*                      10.4 \*                      10.4 \*  
 10.3 \*                      9.8 ↘                      10.7 \*                      9.9 ↗                      10.1 ↘  
 beste Teiler 68.6 (8.) 129.7 (5.) 150.2 (4.)  
 Trefferlage 0.72 mm links, 0.23 mm tief  
 Streuwert 1.40, horizontal: 1.24, vertikal: 1.54

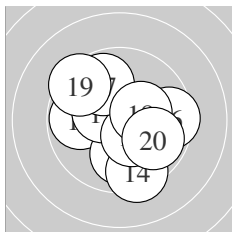

Serie 2:  
 9.8 ←                      10.0 ↓                      10.4 \*                      9.4 ↘                      10.4 \*  
 9.5 →                      9.8 ↗                      10.3 \*                      9.4 ↖                      9.8 ↘  
 beste Teiler 135.5 (13.) 141.6 (15.) 163.5 (18.)  
 Trefferlage 0.16 mm rechts, 0.20 mm tief  
 Streuwert 2.08, horizontal: 2.17, vertikal: 2.00

Unterschrift des Schützen

Ergebnis: **192.5** (183)  
 Serien: 97.7 94.8  
 Zähler: 10 4 5 1 0 0 0 0 0 0  
 Innenzehner: 10  
 weiteste: 754 (2), 749 (11), 743 (14)  
 beste Teiler 84.0 (16.) 91.4 (5.) 120.2 (9.)  
 Trefferlage 0.74 mm links, 0.30 mm hoch  
 Streuwert 2.88, horizontal: 3.31, vertikal: 2.36

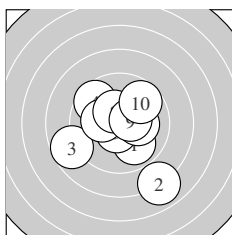
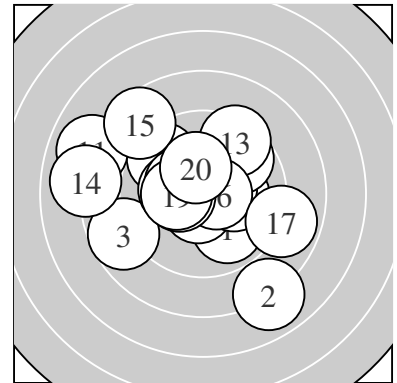

Serie 1:  
 9.9 ↘                      7.9 ↘                      8.7 ↙                      9.6 ↘                      10.6 \*  
 10.2 \*                      10.2 \*                      10.4 \*                      10.5 \*                      9.7 ↗  
 beste Teiler 91.4 (5.) 120.2 (9.) 133.8 (8.)  
 Trefferlage 0.07 mm rechts, 0.56 mm tief  
 Streuwert 2.63, horizontal: 2.68, vertikal: 2.58

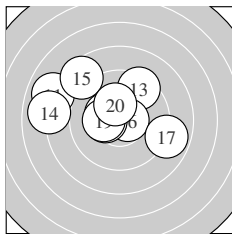

Serie 2:  
 8.0 ↖                      10.3 \*                      9.4 ↗                      8.0 ←                      8.6 ↘  
 10.6 \*                      8.9 →                      10.4 \*                      10.3 \*                      10.3 \*  
 beste Teiler 84.0 (16.) 147.5 (18.) 157.4 (12.)  
 Trefferlage 1.56 mm links, 1.17 mm hoch  
 Streuwert 3.00, horizontal: 3.81, vertikal: 1.86

Unterschrift des Schützen

Ergebnis: **191.6** (184)  
 Serien: 93.8 97.8  
 Zähler: 7 10 3 0 0 0 0 0 0 0  
 Innenzehner: 4  
 weiteste: 629 (3), 610 (9), 602 (11)  
 beste Teiler 101.4 (8.) 119.0 (1.) 172.5 (12.)  
 Trefferlage 0.84 mm rechts, 0.18 mm hoch  
 Streuwert 2.66, horizontal: 3.17, vertikal: 2.01

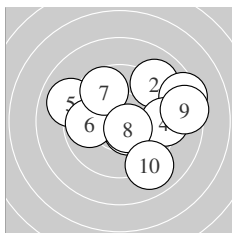
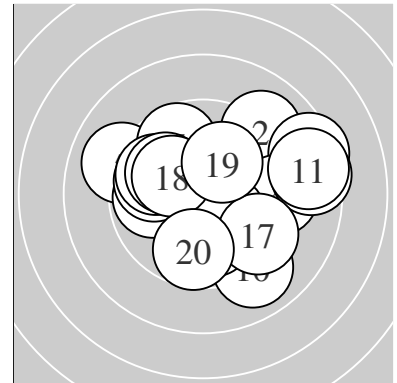

Serie 1:  
 10.5 \*                      9.1 ↗                      8.4 →                      9.3 →                      9.0 ↖  
 9.8 ←                      9.7 ↘                      10.5 \*                      8.5 →                      9.0 ↘  
 beste Teiler 101.4 (8.) 119.0 (1.) 278.6 (6.)  
 Trefferlage 1.48 mm rechts, 0.54 mm hoch  
 Streuwert 2.97, horizontal: 3.58, vertikal: 2.21

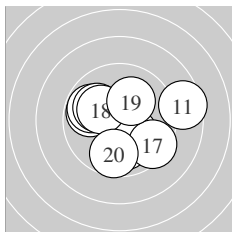

Serie 2:  
 8.5 →                      10.3 \*                      9.8 ↖                      9.8 ↖                      10.0 ↓  
 10.0 ↖                      9.4 ↘                      10.2 \*                      10.1 ↗                      9.7 ↓  
 beste Teiler 172.5 (12.) 198.4 (18.) 205.4 (19.)  
 Trefferlage 0.20 mm rechts, 0.17 mm tief  
 Streuwert 2.34, horizontal: 2.75, vertikal: 1.83

Unterschrift des Schützen



Ergebnis: **189.8** (180)  
 Serien: 95.2 94.6 0.0  
 Zähler: 10 5 3 0 1 1 0 0 0 0  
 Innenzehner: 9  
 weiteste: 1271 (17), 1017 (8), 650 (15)  
 beste Teiler 79.4 (5.) 83.3 (14.) 84.1 (12.)  
 Trefferlage 0.26 mm links, 0.54 mm hoch  
 Streuwert 3.45, horizontal: 4.67, vertikal: 1.41

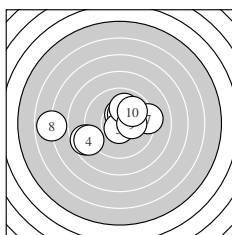
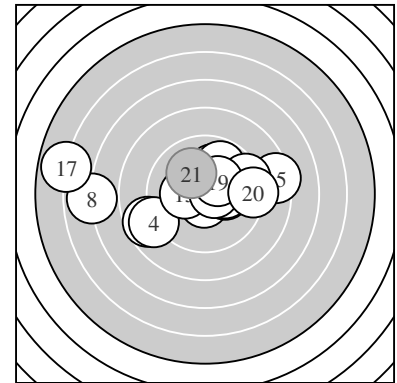

Serie 1:  
 10.4 \*                      8.7 ←                      10.4 \*                      8.9 ←                      10.6 \*  
 10.0 ↑                      9.2 →                      6.9 ←                      10.2 \*                      9.9 ↗  
 beste Teiler 79.4 (5.) 131.0 (1.) 143.5 (3.)  
 Trefferlage 1.08 mm links, 0.10 mm hoch  
 Streuwert 3.25, horizontal: 4.28, vertikal: 1.68

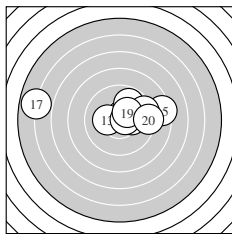

Serie 2:  
 10.2 \*                      10.6 \*                      10.2 \*                      10.6 \*                      8.4 →  
 9.8 ↗                      5.9 ←                      9.4 →                      10.3 \*                      9.2 →  
 beste Teiler 83.3 (14.) 84.1 (12.) 161.9 (19.)  
 Trefferlage 0.55 mm rechts, 0.98 mm hoch  
 Streuwert 3.68, horizontal: 5.12, vertikal: 0.95

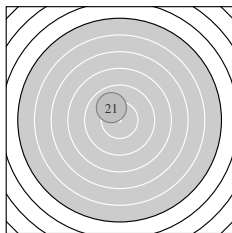

Serie 3:  
 0.0+ ↘  
 beste Teiler <sup>AST,NSC</sup>  
 Trefferlage 0.00 mm , 0.00 mm  
 Streuwert 0.00, horizontal: 0.00, vertikal: 0.00

AST – Treffer wurde nach Ende der Schießzeit abgegeben  
 NSC – Treffer wurde vermessen, geht aber nicht in die Wertung ein

\_\_\_\_\_  
 Unterschrift des Schützen

Meyton Elektronik

Ergebnis: **193.8** (186)  
 Serien: 99.1 94.7  
 Zähler: 9 9 1 1 0 0 0 0 0 0  
 Innenzehner: 2  
 weiteste: 973 (20), 590 (12), 439 (2)  
 beste Teiler 84.8 (4.) 103.0 (1.) 206.1 (11.)  
 Trefferlage 0.24 mm rechts, 0.58 mm hoch  
 Streuwert 2.63, horizontal: 3.51, vertikal: 1.24

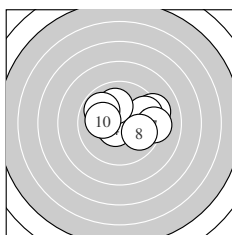
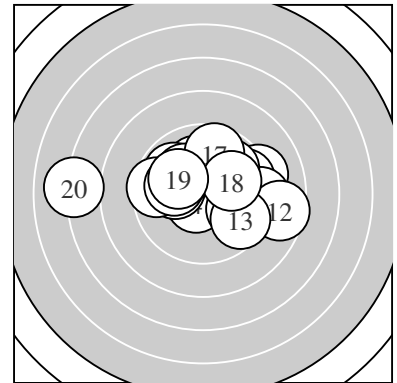

Serie 1:  
 10.5 \*                      9.2 →                      10.0 →                      10.6 \*                      9.6 →  
 10.1 ↑                      9.2 →                      9.9 ↘                      9.9 ↘                      10.1 ←  
 beste Teiler 84.8 (4.) 103.0 (1.) 212.0 (10.)  
 Trefferlage 1.00 mm rechts, 0.46 mm hoch  
 Streuwert 1.95, horizontal: 2.54, vertikal: 1.07

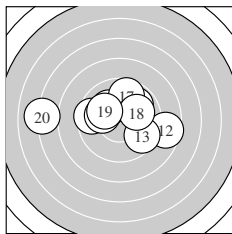

Serie 2:  
 10.1 ↘                      8.6 →                      9.6 ↘                      9.5 ←                      9.9 ↗  
 10.1 ←                      9.7 ↑                      10.0 →                      10.1 ↘                      7.1 ←  
 beste Teiler 206.1 (11.) 218.4 (19.) 225.4 (16.)  
 Trefferlage 0.50 mm links, 0.70 mm hoch  
 Streuwert 3.19, horizontal: 4.28, vertikal: 1.44

Unterschrift des Schützen

Ergebnis: **185.8** (178)  
 Serien: 93.6 92.2  
 Zähler: 7 6 6 0 1 0 0 0 0 0  
 Innenzehner: 4  
 weiteste: 1027 (20), 696 (16), 642 (5)  
 beste Teiler 121.4 (14.) 126.4 (6.) 174.4 (12.)  
 Trefferlage 0.15 mm rechts, 0.32 mm tief  
 Streuwert 3.42, horizontal: 4.42, vertikal: 1.95

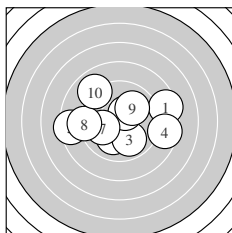
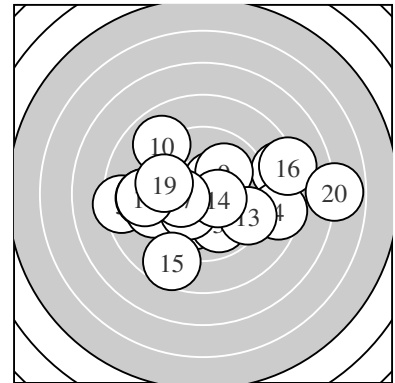

Serie 1:  
 8.4 → 10.0 ↙ 9.9 ↘ 8.5 → 8.4 ←  
 10.4 \* 10.0 ← 9.1 ← 10.0 ↗ 8.9 ↘  
 beste Teiler 126.4 (6.) 226.7 (2.) 236.2 (9.)  
 Trefferlage 0.17 mm links, 0.07 mm hoch  
 Streuwert 3.23, horizontal: 4.12, vertikal: 1.98

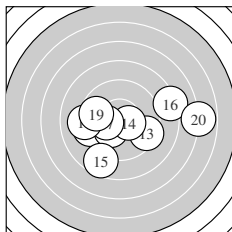

Serie 2:  
 9.3 ← 10.3 \* 9.4 ↘ 10.5 \* 8.6 ↙  
 8.2 → 10.3 \* 9.1 ← 9.7 ← 6.8 →  
 beste Teiler 121.4 (14.) 174.4 (12.) 175.1 (17.)  
 Trefferlage 0.48 mm rechts, 0.72 mm tief  
 Streuwert 3.72, horizontal: 4.89, vertikal: 1.95

Unterschrift des Schützen

Ergebnis: **187.4** (179)  
 Serien: 94.4 93.0  
 Zähler: 7 9 1 2 1 0 0 0 0 0  
 Innenzehner: 5  
 weiteste: 1079 (17), 954 (9), 945 (14)  
 beste Teiler 120.0 (10.) 130.6 (11.) 142.8 (3.)  
 Trefferlage 1.25 mm links, 0.70 mm hoch  
 Streuwert 3.37, horizontal: 4.57, vertikal: 1.35

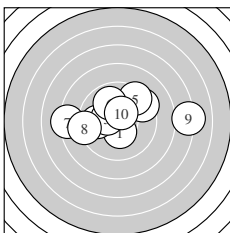
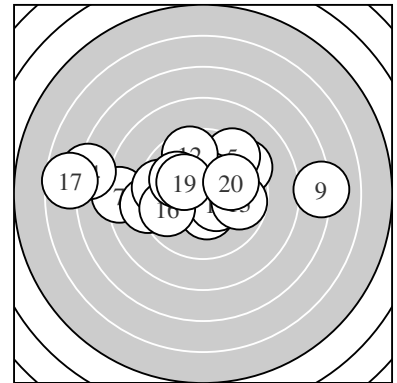

Serie 1:  
 10.4 \*                      9.9 ←                      10.4 \*                      9.4 ↗                      9.4 ↗  
 9.9 ↘                      8.3 ←                      9.1 ←                      7.1 →                      10.5 \*  
 beste Teiler 120.0 (10.) 142.8 (3.) 145.3 (1.)  
 Trefferlage 0.03 mm links, 0.69 mm hoch  
 Streuwert 3.36, horizontal: 4.52, vertikal: 1.46

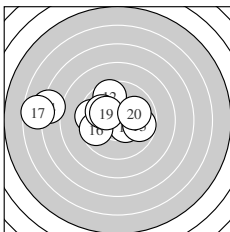

Serie 2:  
 10.4 \*                      9.6 ↖                      9.8 →                      7.2 ←                      9.5 ←  
 9.7 ←                      6.6 ←                      10.0 ↖                      10.2 \*                      10.0 →  
 beste Teiler 130.6 (11.) 179.2 (19.) 239.9 (18.)  
 Trefferlage 2.48 mm links, 0.71 mm hoch  
 Streuwert 3.32, horizontal: 4.51, vertikal: 1.30

Unterschrift des Schützen

Ergebnis: **188.6** (179)  
 Serien: 96.3 92.3  
 Zähler: 6 9 3 2 0 0 0 0 0 0  
 Innenzehner: 5  
 weiteste: 817 (11), 764 (4), 750 (8)  
 beste Teiler 89.8 (1.) 132.9 (9.) 133.9 (5.)  
 Trefferlage 0.93 mm links, 0.23 mm hoch  
 Streuwert 3.14, horizontal: 4.19, vertikal: 1.47

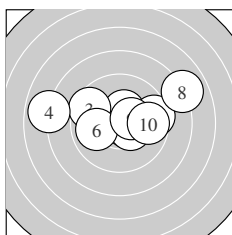
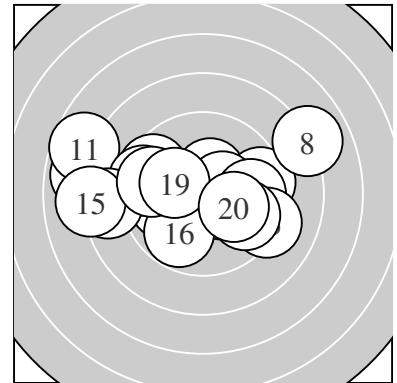

Serie 1:  
 10.6 \*                      10.4 \*                      9.5 ↖                      7.9 ←                      10.4 \*  
 9.9 ←                      9.5 →                      8.0 ↗                      10.4 \*                      9.7 →  
 beste Teiler 89.8 (1.) 132.9 (9.) 133.9 (5.)  
 Trefferlage 0.39 mm rechts, 0.69 mm hoch  
 Streuwert 2.96, horizontal: 3.99, vertikal: 1.26

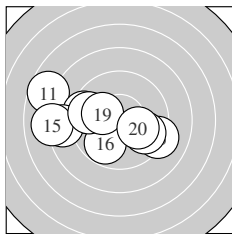

Serie 2:  
 7.7 ↖                      9.4 ←                      9.2 ↘                      8.5 ←                      8.1 ←  
 9.8 ↙                      9.7 ↘                      9.6 ←                      10.2 \*                      10.1 →  
 beste Teiler 196.2 (19.) 213.7 (20.) 288.0 (16.)  
 Trefferlage 2.26 mm links, 0.22 mm tief  
 Streuwert 3.14, horizontal: 4.15, vertikal: 1.59

Unterschrift des Schützen

Ergebnis: **201.1** (193)  
 Serien: 100.4 100.7  
 Zähler: 13 7 0 0 0 0 0 0 0 0  
 Innenzehner: 5  
 weiteste: 366 (8), 341 (20), 304 (14)  
 beste Teiler 106.6 (13.) 120.0 (18.) 123.1 (6.)  
 Trefferlage 0.01 mm rechts, 0.26 mm tief  
 Streuwert 1.69, horizontal: 2.27, vertikal: 0.75

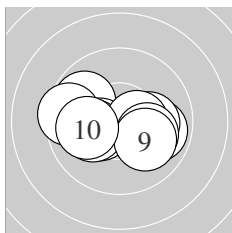
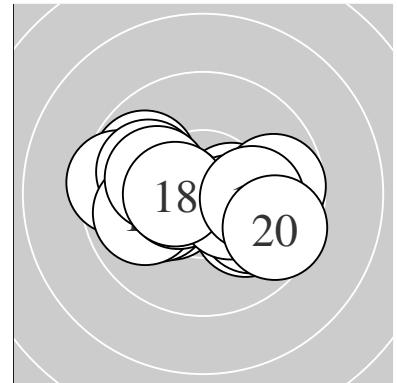

Serie 1:  
 9.8 ↘                      10.3 \*                      9.9 →                      10.1 →                      10.1 ←  
 10.5 \*                      10.1 ↘                      9.5 ←                      10.1 ↘                      10.0 ←  
 beste Teiler 123.1 (6.) 152.8 (2.) 202.4 (5.)  
 Trefferlage 0.20 mm links, 0.30 mm tief  
 Streuwert 1.75, horizontal: 2.36, vertikal: 0.76

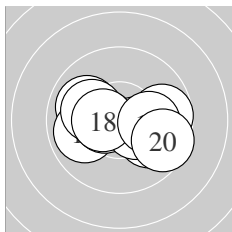

Serie 2:  
 9.9 ↘                      9.9 ←                      10.5 \*                      9.7 →                      10.0 ↘  
 10.4 \*                      10.1 ←                      10.5 \*                      10.1 →                      9.6 ↘  
 beste Teiler 106.6 (13.) 120.0 (18.) 130.1 (16.)  
 Trefferlage 0.24 mm rechts, 0.23 mm tief  
 Streuwert 1.70, horizontal: 2.28, vertikal: 0.77

Unterschrift des Schützen

Ergebnis: **199.1** (190)  
 Serien: 95.3 103.8  
 Zähler: 13 5 1 1 0 0 0 0 0 0  
 Innenzehner: 11  
 weiteste: 815 (4), 628 (8), 442 (1)  
 beste Teiler 68.8 (16.) 70.2 (12.) 101.0 (15.)  
 Trefferlage 0.82 mm rechts, 0.32 mm tief  
 Streuwert 2.18, horizontal: 2.84, vertikal: 1.20

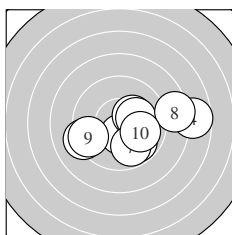
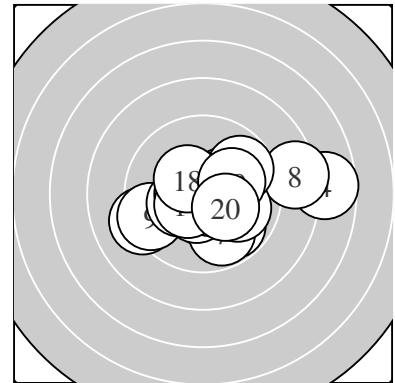

Serie 1:  
 9.2 ↙                      10.5 \*                      10.3 \*                      7.7 →                      10.2 \*  
 9.8 ↘                      9.8 ↘                      8.4 →                      9.4 ↙                      10.0 ↘  
 beste Teiler 125.2 (2.) 166.5 (3.) 190.6 (5.)  
 Trefferlage 1.55 mm rechts, 0.68 mm tief  
 Streuwert 2.80, horizontal: 3.72, vertikal: 1.38

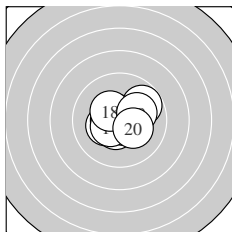

Serie 2:  
 9.8 ↗                      10.7 \*                      10.3 \*                      10.5 \*                      10.5 \*  
 10.7 \*                      10.5 \*                      10.4 \*                      10.1 →                      10.3 \*  
 beste Teiler 68.8 (16.) 70.2 (12.) 101.0 (15.)  
 Trefferlage 0.09 mm rechts, 0.03 mm hoch  
 Streuwert 1.19, horizontal: 1.41, vertikal: 0.93

Unterschrift des Schützen

Ergebnis: **185.5** (175)  
 Serien: 90.9 94.6  
 Zähler: 5 8 6 0 0 1 0 0 0 0  
 Innenzehner: 2  
 weiteste: 1297 (3), 698 (18), 618 (16)  
 beste Teiler 129.7 (4.) 197.8 (14.) 214.9 (20.)  
 Trefferlage 1.70 mm rechts, 0.59 mm tief  
 Streuwert 3.32, horizontal: 4.57, vertikal: 1.09

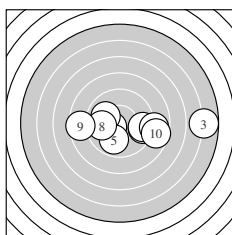
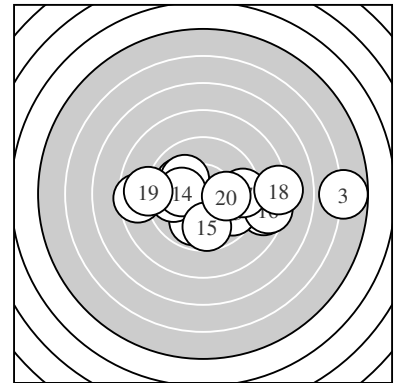

Serie 1:  
 9.5 →                      9.5 →                      5.8 →                      10.4 \*                      9.9 ↓  
 8.8 →                      10.0 ↖                      9.9 ←                      8.5 ←                      8.6 →  
 beste Teiler 129.7 (4.) 240.6 (7.) 265.0 (5.)  
 Trefferlage 1.80 mm rechts, 0.64 mm tief  
 Streuwert 3.94, horizontal: 5.49, vertikal: 0.93

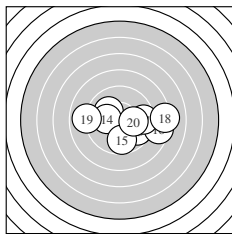

Serie 2:  
 9.7 ↘                      10.1 ↖                      9.7 ↘                      10.2 \*                      9.7 ↓  
 8.5 →                      9.5 →                      8.2 →                      8.9 ←                      10.1 →  
 beste Teiler 197.8 (14.) 214.9 (20.) 216.9 (12.)  
 Trefferlage 1.60 mm rechts, 0.54 mm tief  
 Streuwert 2.80, horizontal: 3.74, vertikal: 1.29

Unterschrift des Schützen



Ergebnis: **192.8** (185)  
 Serien: 97.1 95.7  
 Zähler: 8 9 3 0 0 0 0 0 0 0  
 Innenzehner: 6  
 weiteste: 687 (11), 607 (10), 588 (14)  
 beste Teiler 56.2 (20.) 60.3 (3.) 131.9 (2.)  
 Trefferlage 0.44 mm rechts, 0.12 mm hoch  
 Streuwert 2.70, horizontal: 3.62, vertikal: 1.21

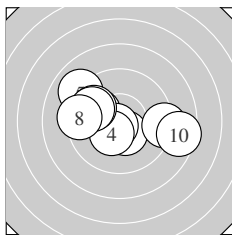
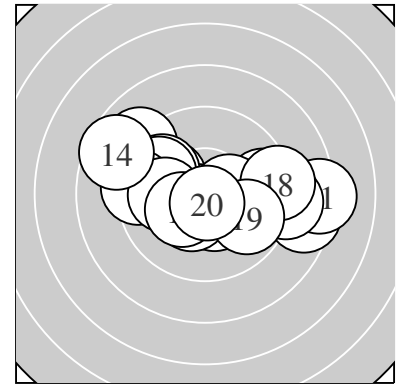

Serie 1:  
 10.0 ↘                      10.4 \*                      10.7 \*                      10.4 \*                      9.0 ↖  
 9.8 ↖                      9.8 ↖                      9.3 ←                      9.2 →                      8.5 →  
 beste Teiler 60.3 (3.) 131.9 (2.) 144.2 (4.)  
 Trefferlage 0.56 mm links, 0.23 mm hoch  
 Streuwert 2.59, horizontal: 3.39, vertikal: 1.39

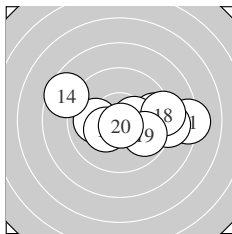

Serie 2:  
 8.2 →                      9.5 →                      10.0 ←                      8.6 ↖                      9.0 →  
 10.4 \*                      10.3 \*                      9.2 →                      9.8 ↘                      10.7 \*  
 beste Teiler 56.2 (20.) 145.5 (16.) 166.1 (17.)  
 Trefferlage 1.45 mm rechts, 0.02 mm hoch  
 Streuwert 2.74, horizontal: 3.73, vertikal: 1.07

Unterschrift des Schützen

Ergebnis: **191.0** (183)  
 Serien: 95.5 95.5  
 Zähler: 10 3 7 0 0 0 0 0 0 0  
 Innenzehner: 9  
 weiteste: 748 (10), 671 (3), 664 (15)  
 beste Teiler 88.6 (9.) 102.4 (6.) 127.8 (2.)  
 Trefferlage 0.79 mm links, 0.03 mm hoch  
 Streuwert 2.96, horizontal: 3.81, vertikal: 1.72

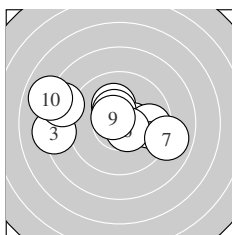
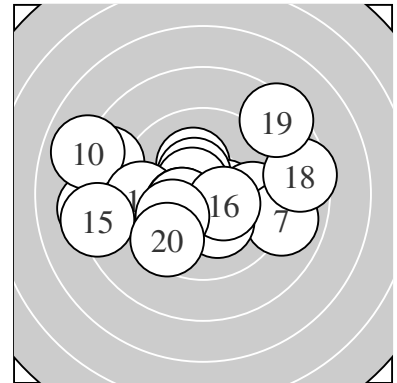

Serie 1:  
 10.2 \*                      10.4 \*                      8.3 ←                      10.4 \*                      9.7 →  
 10.5 \*                      8.9 →                      8.5 ←                      10.6 \*                      8.0 ↖  
 beste Teiler 88.6 (9.) 102.4 (6.) 127.8 (2.)  
 Trefferlage 1.14 mm links, 0.45 mm hoch  
 Streuwert 3.04, horizontal: 4.08, vertikal: 1.36

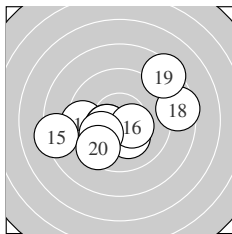

Serie 2:  
 9.4 ←                      10.4 \*                      10.2 \*                      10.4 \*                      8.3 ←  
 10.4 \*                      10.0 ↙                      8.5 →                      8.4 ↗                      9.5 ↙  
 beste Teiler 138.2 (16.) 143.5 (14.) 146.2 (12.)  
 Trefferlage 0.43 mm links, 0.39 mm tief  
 Streuwert 2.97, horizontal: 3.70, vertikal: 2.01

Unterschrift des Schützen