

Ergebnis: **546** (571.9)  
 Serien: 91 91 90 91 92 91  
 Zähler: 20 28 10 2 0 0 0 0 0 0  
 Innenzehner: 8  
 Weitester: 3006 (23.), 2480 (33.), 2265 (3.)  
 beste Teiler: 212.8 (12.), 226.7 (39.), 247.6 (6.)  
 Trefferlage: 0.85 mm links, 2.88 mm hoch  
 Streuwert: 8.85, horizontal: 8.51, vertikal: 9.18

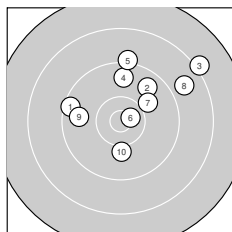
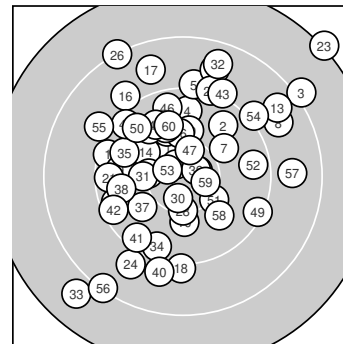

**Serie 1:**

9.4 ←	9.7 ↗	8.1 ↗	9.7 ↑	9.1 ↑
10.6 *	10.0 ↗	8.8 ↗	9.7 ←	10.1 ↓

beste Teiler: 247.6 (6.), 715.3 (10.), 775.7 (7.)  
 Trefferlage: 2.95 mm rechts, 5.64 mm hoch  
 Streuwert: 8.10, horizontal: 9.43, vertikal: 6.49

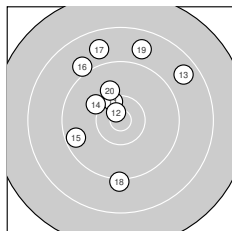

**Serie 2:**

10.4 *	10.7 *	8.7 ↗	10.1 ↖	9.5 ↖
9.0 ↘	8.8 ↘	9.1 ↓	8.8 ↑	10.0 ↘

beste Teiler: 212.8 (12.), 470.0 (11.), 692.1 (14.)  
 Trefferlage: 1.62 mm links, 5.49 mm hoch  
 Streuwert: 8.53, horizontal: 7.28, vertikal: 9.62

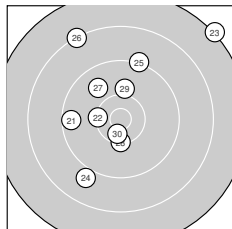

**Serie 3:**

9.5 ←	10.3 ←	7.2 ↗	8.9 ↙	9.2 ↑
8.2 ↘	9.8 ↘	10.3 ↓	10.1 ↑	10.5 *

beste Teiler: 351.3 (30.), 535.6 (22.), 538.0 (28.)  
 Trefferlage: 1.40 mm links, 4.48 mm hoch  
 Streuwert: 10.39, horizontal: 9.73, vertikal: 11.01

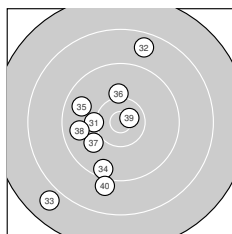

**Serie 4:**

10.2 ←	8.7 ↑	7.9 ↙	9.5 ↓	9.7 ↖
10.1 ↑	10.0 ↙	9.7 ←	10.7 *	9.0 ↓

beste Teiler: 226.7 (39.), 625.0 (31.), 672.7 (36.)  
 Trefferlage: 4.87 mm links, 2.22 mm tief  
 Streuwert: 8.78, horizontal: 6.33, vertikal: 10.68

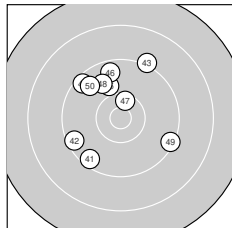

**Serie 5:**

9.5 ↗	9.4 ←	9.2 ↑	9.4 ↘	10.0 ↘
9.6 ↑	10.4 *	9.8 ↘	9.3 ↘	9.6 ↘

beste Teiler: 419.6 (47.), 798.3 (45.), 909.8 (48.)  
 Trefferlage: 2.45 mm links, 3.84 mm hoch  
 Streuwert: 7.43, horizontal: 7.05, vertikal: 7.79

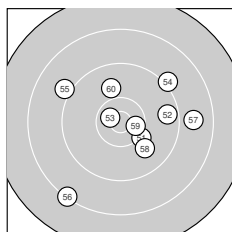

**Serie 6:**

10.2 ↘	9.6 →	10.6 *	9.1 ↗	9.0 ↖
8.3 ↙	8.8 →	9.9 ↘	10.5 *	9.9 ↑

beste Teiler: 264.8 (53.), 364.0 (59.), 610.6 (51.)  
 Trefferlage: 2.29 mm rechts, 0.02 mm hoch  
 Streuwert: 9.02, horizontal: 9.95, vertikal: 7.99



Ergebnis: **523** (550.4)  
 Serien: 89 86 87 90 84 87  
 Zähler: 11 28 15 5 1 0 0 0 0 0  
 Innenzehner: 6  
 Weitester: 3856 (46.), 3138 (21.), 2868 (48.)  
 beste Teiler: 151.7 (53.), 176.3 (13.), 177.7 (50.)  
 Trefferlage: 0.25 mm rechts, 1.84 mm tief  
 Streuwert: 11.50, horizontal: 12.63, vertikal: 10.24

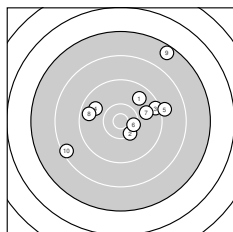
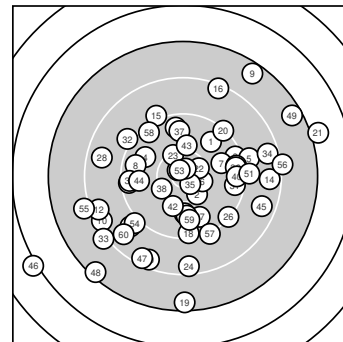

**Serie 1:**  
 9.7 ↗ 10.3 ↘ 9.4 → 9.8 ↖ 9.1 →  
 10.4 \* 9.8 → 9.6 ← 7.5 ↗ 8.4 ↖  
 beste Teiler: 445.1 (6.), 508.8 (2.), 896.1 (7.)  
 Trefferlage: 2.69 mm rechts, 3.31 mm hoch  
 Streuwert: 9.98, horizontal: 11.29, vertikal: 8.45

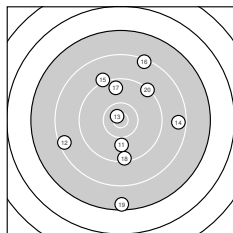

**Serie 2:**  
 9.9 ↓ 8.4 ← 10.7 \* 8.6 → 9.1 ↖  
 8.3 ↗ 9.6 ↑ 9.4 ↓ 7.5 ↓ 9.3 ↗  
 beste Teiler: 176.3 (13.), 821.6 (11.), 1085.0 (17.)  
 Trefferlage: 1.05 mm rechts, 0.19 mm tief  
 Streuwert: 12.28, horizontal: 9.91, vertikal: 14.26

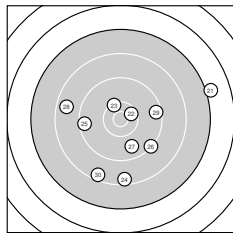

**Serie 3:**  
 7.0 → 10.5 \* 10.3 ↖ 8.5 ↓ 9.4 ←  
 9.3 ↘ 9.7 ↘ 8.7 ← 9.5 → 8.5 ↓  
 beste Teiler: 392.2 (22.), 515.3 (23.), 973.4 (27.)  
 Trefferlage: 2.06 mm rechts, 3.54 mm tief  
 Streuwert: 11.92, horizontal: 13.51, vertikal: 10.08

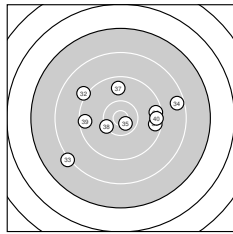

**Serie 4:**  
 9.5 → 9.1 ↖ 8.2 ↖ 8.5 → 10.7 \*  
 9.5 → 9.7 ↑ 10.3 ↖ 9.5 ← 9.5 →  
 beste Teiler: 237.7 (35.), 543.3 (38.), 999.1 (37.)  
 Trefferlage: 0.82 mm rechts, 0.36 mm hoch  
 Streuwert: 9.94, horizontal: 12.36, vertikal: 6.68

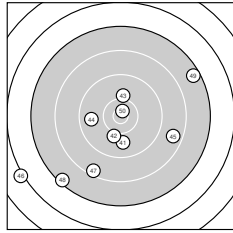

**Serie 5:**  
 9.9 ↓ 10.1 ↓ 10.1 ↑ 9.7 ← 8.6 →  
 6.1 ↖ 8.4 ↓ 7.4 ↖ 7.5 ↗ 10.7 \*  
 beste Teiler: 177.7 (50.), 685.0 (43.), 696.6 (42.)  
 Trefferlage: 2.95 mm links, 6.02 mm tief  
 Streuwert: 14.24, horizontal: 16.49, vertikal: 11.55

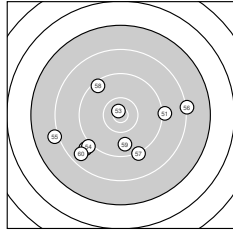

**Serie 6:**  
 9.1 → 8.9 ↖ 10.8 \* 9.1 ↖ 8.1 ←  
 8.2 → 9.2 ↘ 9.4 ↖ 9.7 ↓ 8.7 ↖  
 beste Teiler: 151.7 (53.), 975.5 (59.), 1225.1 (58.)  
 Trefferlage: 2.14 mm links, 4.97 mm tief  
 Streuwert: 11.07, horizontal: 13.52, vertikal: 7.88



Ergebnis: **336** (355.3)  
 Serien: 76 85 87 88  
 Zähler: 2 18 15 4 1 0 0 0 0 0  
 Innenzehner: 0  
 Weitesten: 3423 (7.), 2759 (10.), 2724 (4.)  
 beste Teiler: 602.5 (35.), 707.1 (16.), 830.5 (27.)  
 Trefferlage: 7.51 mm links, 2.87 mm hoch  
 Streuwert: 11.28, horizontal: 11.67, vertikal: 10.88

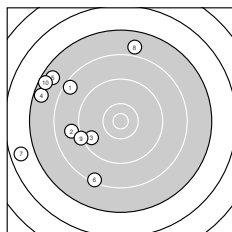
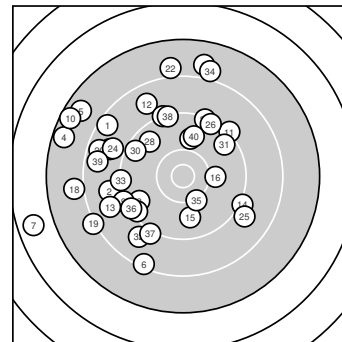

**Serie 1:**  
 8.5 ↘                      8.9 ←                      9.6 ←                      7.5 ↖                      7.7 ↖  
 8.3 ↓                      6.7 ←                      7.9 ↑                      9.2 ←                      7.5 ↖  
 beste Teiler: 1092.2 (3.), 1405.1 (9.), 1635.4 (2.)  
 Trefferlage: 16.39 mm links, 2.66 mm hoch  
 Streuwert: 12.10, horizontal: 10.61, vertikal: 13.42

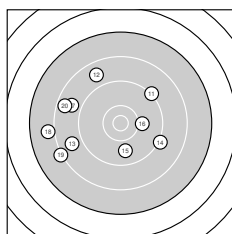

**Serie 2:**  
 9.2 ↗                      8.7 ↘                      8.8 ←                      9.2 ↘                      9.8 ↓  
 10.1 →                      8.8 ←                      8.0 ←                      8.2 ←                      8.6 ↖  
 beste Teiler: 707.1 (16.), 911.4 (15.), 1398.3 (11.)  
 Trefferlage: 6.93 mm links, 0.17 mm hoch  
 Streuwert: 11.47, horizontal: 13.67, vertikal: 8.74

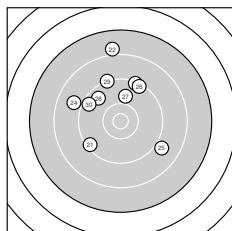

**Serie 3:**  
 9.4 ←                      8.0 ↑                      9.3 ↑                      8.9 ↖                      8.9 ↘  
 9.3 ↑                      9.9 ↑                      9.6 ↘                      9.2 ↑                      9.5 ↖  
 beste Teiler: 830.5 (27.), 1042.4 (28.), 1171.7 (30.)  
 Trefferlage: 2.40 mm links, 7.10 mm hoch  
 Streuwert: 9.21, horizontal: 8.83, vertikal: 9.58

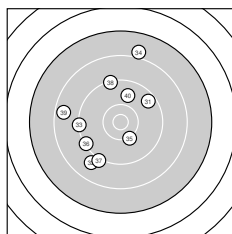

**Serie 4:**  
 9.5 ↗                      8.9 ←                      9.3 ←                      8.0 ↑                      10.2 ↘  
 9.3 ←                      9.2 ↓                      9.3 ↑                      8.6 ←                      9.8 ↑  
 beste Teiler: 602.5 (35.), 899.7 (40.), 1134.0 (31.)  
 Trefferlage: 4.31 mm links, 1.56 mm hoch  
 Streuwert: 10.44, horizontal: 9.15, vertikal: 11.59



Ergebnis: **353** (370.9)  
 Serien: 86 89 92 86  
 Zähler: 11 15 10 4 0 0 0 0 0 0  
 Innenzehner: 4  
 Weitester: 3178 (8.), 2807 (2.), 2778 (39.)  
 beste Teiler: 59.1 (24.), 171.3 (27.), 394.6 (14.)  
 Trefferlage: 1.46 mm rechts, 0.30 mm hoch  
 Streuwert: 10.92, horizontal: 10.47, vertikal: 11.34

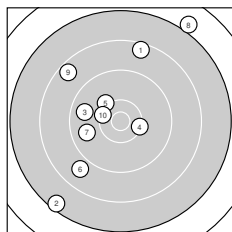
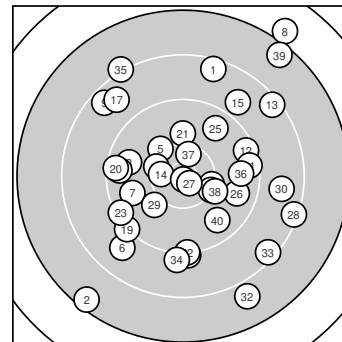

**Serie 1:**  
 8.5 ↑                      7.4 ↙                      9.7 ←                      10.3 →                      10.2 ↘  
 8.8 ↘                      9.8 ←                      7.0 ↗                      8.5 ↘                      10.3 ↘  
 beste Teiler: 508.0 (10.), 535.0 (4.), 633.6 (5.)  
 Trefferlage: 4.08 mm links, 2.80 mm hoch  
 Streuwert: 12.68, horizontal: 10.82, vertikal: 14.29

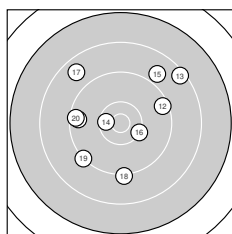

**Serie 2:**  
 9.5 ←                      9.4 →                      8.4 ↗                      10.5 \*                      8.9 ↗  
 10.3 →                      8.7 ↘                      9.2 ↓                      9.2 ↘                      9.4 ←  
 beste Teiler: 394.6 (14.), 559.0 (16.), 1143.5 (11.)  
 Trefferlage: 0.61 mm links, 2.10 mm hoch  
 Streuwert: 10.11, horizontal: 10.73, vertikal: 9.46

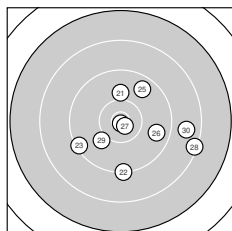

**Serie 3:**  
 10.0 ↑                      9.2 ↓                      9.3 ↙                      10.9 \*                      9.7 ↗  
 9.7 →                      10.7 \*                      8.3 →                      10.0 ↘                      8.7 →  
 beste Teiler: 59.1 (24.), 171.3 (27.), 727.6 (29.)  
 Trefferlage: 3.87 mm rechts, 2.32 mm tief  
 Streuwert: 8.29, horizontal: 9.65, vertikal: 6.66

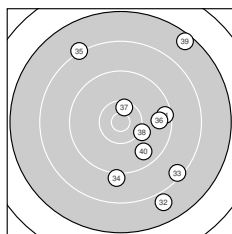

**Serie 4:**  
 9.4 →                      7.9 ↓                      8.4 ↘                      9.1 ↓                      8.2 ↘  
 9.6 →                      10.4 \*                      10.2 →                      7.5 ↗                      9.7 ↘  
 beste Teiler: 406.9 (37.), 636.0 (38.), 1000.1 (40.)  
 Trefferlage: 6.71 mm rechts, 1.36 mm tief  
 Streuwert: 11.66, horizontal: 8.59, vertikal: 14.08



Ergebnis: **343** (363.5)  
 Serien: 90 88 82 83  
 Zähler: 6 19 9 4 2 0 0 0 0 0  
 Innenzehner: 5  
 Weitesten: 3326 (25.), 3301 (23.), 2733 (34.)  
 beste Teiler: 267.2 (1.), 309.4 (2.), 325.7 (21.)  
 Trefferlage: 0.16 mm rechts, 1.38 mm hoch  
 Streuwert: 11.90, horizontal: 12.01, vertikal: 11.80

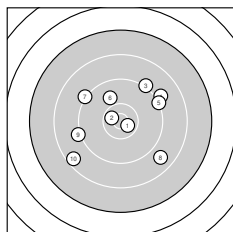
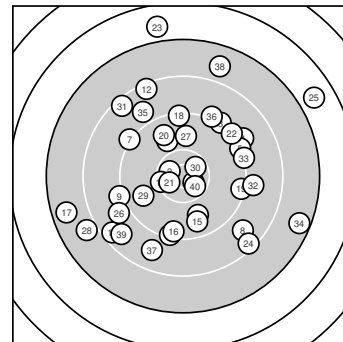

**Serie 1:**  
 10.6 \*                      10.6 \*                      9.2 ↗                      9.0 ↗                      9.2 ↗  
 9.9 ↘                      9.2 ↘                      8.8 ↘                      9.1 ↖                      8.5 ↖  
 beste Teiler: 267.2 (1.), 309.4 (2.), 837.0 (6.)  
 Trefferlage: 0.20 mm rechts, 1.28 mm hoch  
 Streuwert: 10.03, horizontal: 11.32, vertikal: 8.54

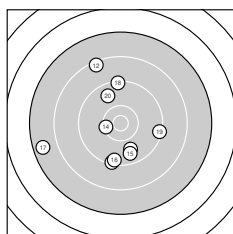

**Serie 2:**  
 9.8 ↓                      8.4 ↘                      9.3 ↓                      10.3 ←                      9.7 ↓  
 9.4 ↓                      7.6 ←                      9.3 ↑                      9.3 →                      9.7 ↘  
 beste Teiler: 495.7 (14.), 905.3 (11.), 985.1 (20.)  
 Trefferlage: 2.89 mm links, 1.39 mm tief  
 Streuwert: 10.54, horizontal: 9.76, vertikal: 11.27

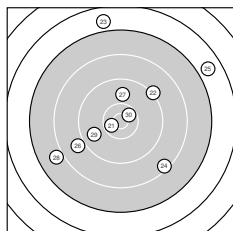

**Serie 3:**  
 10.5 \*                      9.2 ↗                      6.8 ↑                      8.4 ↘                      6.8 ↗  
 8.9 ↖                      9.9 ↑                      7.9 ↖                      9.7 ↖                      10.5 \*  
 beste Teiler: 325.7 (21.), 338.2 (30.), 877.4 (27.)  
 Trefferlage: 0.47 mm rechts, 2.95 mm hoch  
 Streuwert: 14.44, horizontal: 14.47, vertikal: 14.40

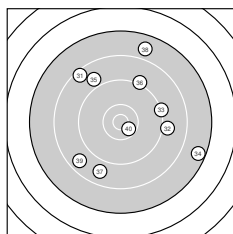

**Serie 4:**  
 8.4 ↘                      9.0 →                      9.2 →                      7.5 →                      8.9 ↘  
 9.2 ↗                      8.8 ↓                      7.8 ↑                      8.7 ↖                      10.5 \*  
 beste Teiler: 341.6 (40.), 1387.6 (33.), 1438.8 (36.)  
 Trefferlage: 2.87 mm rechts, 2.70 mm hoch  
 Streuwert: 13.33, horizontal: 13.16, vertikal: 13.51



Ergebnis: **610.3** (587)  
 Serien: 101.0 103.5 100.4 100.1 101.9 103.4  
 Zähler: 47 13 0 0 0 0 0 0 0  
 Innenzehner: 36  
 Weitester: 445 (22.), 426 (39.), 424 (30.)  
 beste Teiler: 44.1 (18.), 59.5 (54.), 62.2 (50.)  
 Trefferlage: 0.52 mm rechts, 0.28 mm tief  
 Streuwert: 1.51, horizontal: 1.57, vertikal: 1.43

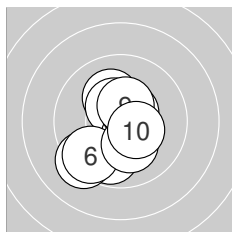
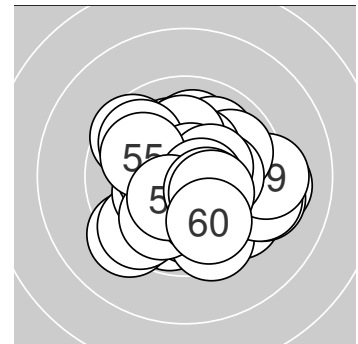

**Serie 1:**  
 10.1 ↖ 10.4 \* 9.8 ↘ 10.4 \* 9.3 ↗  
 9.5 ↗ 10.5 \* 10.2 \* 10.4 \* 10.4 \*  
 beste Teiler: 102.6 (7.), 127.5 (2.), 129.9 (9.)  
 Trefferlage: 0.35 mm links, 0.70 mm tief  
 Streuwert: 1.63, horizontal: 1.39, vertikal: 1.84

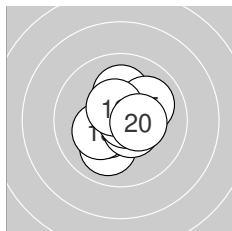

**Serie 2:**  
 10.0 ↘ 10.4 \* 10.2 \* 10.1 ↑ 10.0 ↗  
 10.6 \* 10.5 \* 10.8 \* 10.5 \* 10.4 \*  
 beste Teiler: 44.1 (18.), 100.3 (16.), 107.9 (17.)  
 Trefferlage: 0.15 mm rechts, 0.05 mm tief  
 Streuwert: 1.19, horizontal: 1.17, vertikal: 1.21

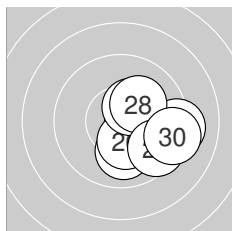

**Serie 3:**  
 10.4 \* 9.2 → 10.4 \* 10.6 \* 10.0 ↓  
 10.3 \* 10.4 \* 10.2 \* 9.6 ↘ 9.3 →  
 beste Teiler: 98.2 (24.), 132.0 (21.), 136.4 (27.)  
 Trefferlage: 1.72 mm rechts, 0.66 mm tief  
 Streuwert: 1.38, horizontal: 1.51, vertikal: 1.25

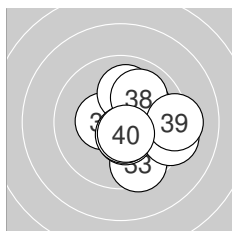

**Serie 4:**  
 10.1 ↗ 10.4 \* 9.5 ↘ 10.5 \* 10.0 ↑  
 9.3 → 10.5 \* 10.0 ↗ 9.2 → 10.6 \*  
 beste Teiler: 100.2 (40.), 102.3 (37.), 117.0 (34.)  
 Trefferlage: 1.28 mm rechts, 0.19 mm tief  
 Streuwert: 1.69, horizontal: 1.71, vertikal: 1.66

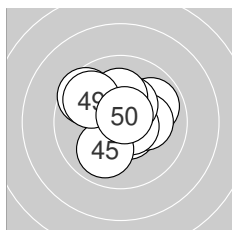

**Serie 5:**  
 10.6 \* 9.9 ↗ 10.2 \* 10.6 \* 10.0 ↗  
 10.3 \* 9.6 ↘ 10.2 \* 9.8 ↘ 10.7 \*  
 beste Teiler: 62.2 (50.), 84.6 (44.), 90.1 (41.)  
 Trefferlage: 0.02 mm rechts, 0.58 mm hoch  
 Streuwert: 1.52, horizontal: 1.67, vertikal: 1.36

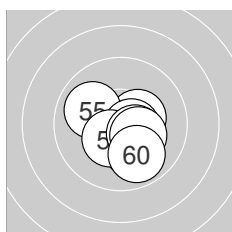

**Serie 6:**  
 10.4 \* 10.1 ↘ 10.6 \* 10.7 \* 10.0 ↘  
 10.6 \* 10.4 \* 10.4 \* 10.3 \* 9.9 ↘  
 beste Teiler: 59.5 (54.), 88.2 (53.), 88.8 (56.)  
 Trefferlage: 0.34 mm rechts, 0.69 mm tief  
 Streuwert: 1.10, horizontal: 1.18, vertikal: 1.01



Ergebnis: **582.6** (555)  
 Serien: 94.7 93.2 101.0 96.5 99.4 97.8  
 Zähler: 24 29 5 2 0 0 0 0 0  
 Innenzehner: 19  
 Weitester: 928 (5.), 915 (11.), 747 (60.)  
 beste Teiler: 42.0 (13.), 46.0 (44.), 50.7 (30.)  
 Trefferlage: 0.19 mm rechts, 1.15 mm tief  
 Streuwert: 2.48, horizontal: 2.92, vertikal: 1.94

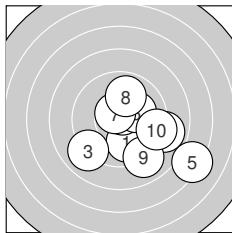
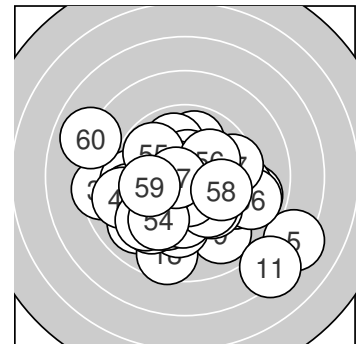

**Serie 1:**

9.9 ↓ 10.7 \* 9.0 ↙ 8.9 → 7.2 ↘  
 10.2 \* 10.6 \* 9.9 ↑ 9.0 ↘ 9.3 →  
 beste Teiler: 60.7 (2.), 82.2 (7.), 198.0 (6.)  
 Trefferlage: 1.92 mm rechts, 1.28 mm tief  
 Streuwert: 2.82, horizontal: 3.19, vertikal: 2.41

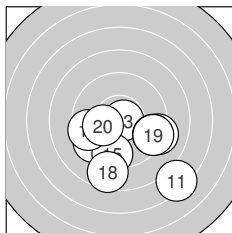

**Serie 2:**

7.3 ↘ 9.5 ↙ 10.8 \* 9.2 → 9.4 ↓  
 9.4 → 9.5 ← 8.6 ↓ 9.3 → 10.2 \*  
 beste Teiler: 42.0 (13.), 192.6 (20.), 362.4 (17.)  
 Trefferlage: 0.80 mm rechts, 2.49 mm tief  
 Streuwert: 2.87, horizontal: 3.40, vertikal: 2.20

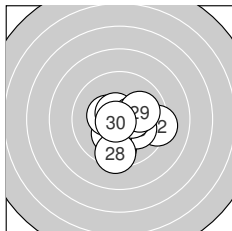

**Serie 3:**

9.7 ↓ 9.3 → 10.1 ↘ 10.2 \* 10.4 \*  
 10.6 \* 10.4 \* 9.5 ↓ 10.0 → 10.8 \*  
 beste Teiler: 50.7 (30.), 80.4 (26.), 131.8 (27.)  
 Trefferlage: 0.55 mm rechts, 0.83 mm tief  
 Streuwert: 1.66, horizontal: 1.75, vertikal: 1.56

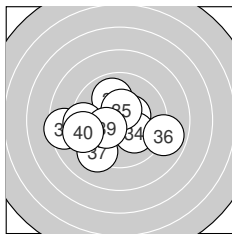

**Serie 4:**

10.4 \* 8.5 ← 9.9 ↑ 10.1 ↘ 10.5 \*  
 8.9 → 9.3 ↙ 9.3 ← 10.3 \* 9.3 ←  
 beste Teiler: 117.7 (35.), 129.0 (31.), 168.9 (39.)  
 Trefferlage: 1.09 mm links, 0.58 mm tief  
 Streuwert: 2.56, horizontal: 3.23, vertikal: 1.63

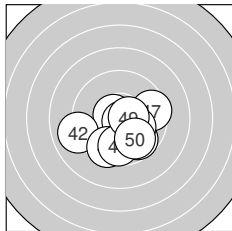

**Serie 5:**

10.6 \* 9.0 ← 9.7 ↘ 10.8 \* 9.6 ↙  
 9.7 ↓ 9.5 → 10.1 ↘ 10.6 \* 9.8 ↘  
 beste Teiler: 46.0 (44.), 76.9 (41.), 100.4 (49.)  
 Trefferlage: 0.34 mm rechts, 1.24 mm tief  
 Streuwert: 1.89, horizontal: 2.24, vertikal: 1.45

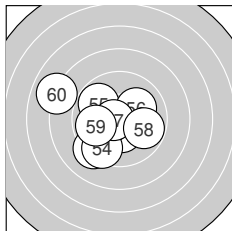

**Serie 6:**

10.4 \* 10.4 \* 9.2 ↙ 9.5 ↙ 9.8 ↘  
 10.1 ↗ 10.7 \* 9.8 → 9.9 ← 8.0 ←  
 beste Teiler: 67.0 (57.), 135.9 (52.), 147.1 (51.)  
 Trefferlage: 1.38 mm links, 0.45 mm tief  
 Streuwert: 2.36, horizontal: 2.70, vertikal: 1.96



Ergebnis: **614.3** (586)  
 Serien: 101.8 101.8 102.2 104.0 102.2 102.3  
 Zähler: 46 14 0 0 0 0 0 0 0  
 Innenzehner: 36  
 Weitester: 473 (27.), 441 (8.), 365 (28.)  
 beste Teiler: 30.0 (30.), 30.4 (32.), 39.0 (59.)  
 Trefferlage: 0.08 mm links, 0.37 mm hoch  
 Streuwert: 1.43, horizontal: 1.53, vertikal: 1.32

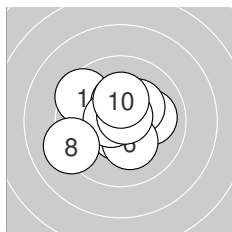
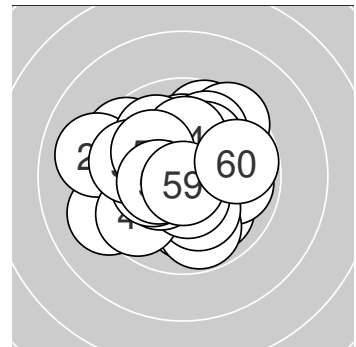

**Serie 1:**

9.5 ↘	10.0 →	10.6 *	10.4 *	10.3 *
10.2 *	10.6 *	9.2 ↙	10.7 *	10.3 *

beste Teiler: 52.6 (9.), 77.4 (7.), 91.2 (3.)  
 Trefferlage: 0.33 mm links, 0.26 mm hoch  
 Streuwert: 1.65, horizontal: 1.88, vertikal: 1.38

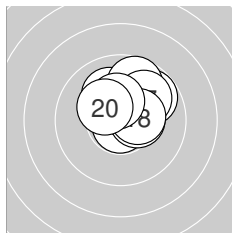

**Serie 2:**

10.8 *	9.8 ↗	10.1 ↑	10.1 ↘	10.4 *
9.7 ↑	9.9 ↗	10.4 *	10.3 *	10.3 *

beste Teiler: 39.3 (11.), 132.0 (15.), 140.2 (18.)  
 Trefferlage: 0.60 mm rechts, 1.29 mm hoch  
 Streuwert: 1.12, horizontal: 1.20, vertikal: 1.03

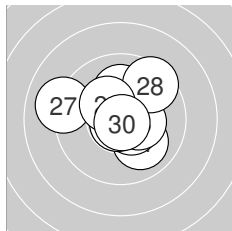

**Serie 3:**

10.0 ↘	10.5 *	10.4 *	10.1 ↑	10.7 *
10.8 *	9.1 ←	9.5 ↗	10.3 *	10.8 *

beste Teiler: 30.0 (30.), 41.6 (26.), 53.9 (25.)  
 Trefferlage: 0.00 mm, 0.43 mm hoch  
 Streuwert: 1.68, horizontal: 1.93, vertikal: 1.38

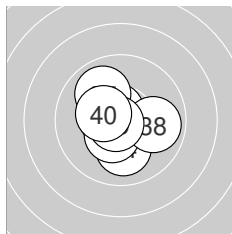

**Serie 4:**

10.6 *	10.8 *	10.6 *	10.1 ↓	10.5 *
10.4 *	9.9 ↘	9.9 →	10.8 *	10.4 *

beste Teiler: 30.4 (32.), 46.6 (39.), 83.1 (33.)  
 Trefferlage: 0.36 mm links, 0.02 mm tief  
 Streuwert: 1.16, horizontal: 1.17, vertikal: 1.15

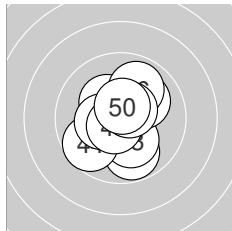

**Serie 5:**

9.8 ↓	10.3 *	10.2 *	9.7 ↙	10.1 ↗
9.9 ↑	10.4 *	10.6 *	10.6 *	10.6 *

beste Teiler: 79.6 (48.), 95.8 (50.), 96.9 (49.)  
 Trefferlage: 0.00 mm, 0.08 mm tief  
 Streuwert: 1.51, horizontal: 1.34, vertikal: 1.67

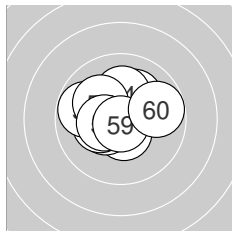

**Serie 6:**

10.5 *	10.4 *	10.1 ↑	10.1 ↑	10.3 *
9.8 ←	10.1 ↘	10.4 *	10.8 *	9.8 →

beste Teiler: 39.0 (59.), 111.3 (51.), 133.6 (58.)  
 Trefferlage: 0.41 mm links, 0.37 mm hoch  
 Streuwert: 1.39, horizontal: 1.63, vertikal: 1.08





Ergebnis: **597.2** (567)  
 Serien: 97.2 96.3 99.1 101.8 100.3 102.5  
 Zähler: 31 25 4 0 0 0 0 0 0  
 Innenzehner: 24  
 Weitester: 586 (11.), 553 (5.), 504 (14.)  
 beste Teiler: 38.6 (49.), 43.0 (57.), 56.5 (54.)  
 Trefferlage: 0.58 mm rechts, 1.42 mm hoch  
 Streuwert: 1.68, horizontal: 1.82, vertikal: 1.52

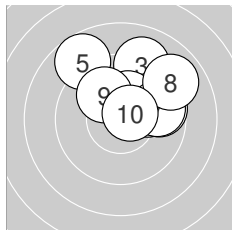
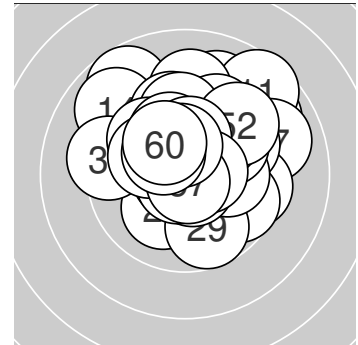

**Serie 1:**

10.0 ↗	10.2 *	9.1 ↑	10.3 *	8.7 ↘
9.7 ↗	9.7 ↗	8.9 ↗	10.0 ↘	10.6 *

beste Teiler: 90.4 (10.), 175.2 (4.), 189.4 (2.)  
 Trefferlage: 1.08 mm rechts, 2.04 mm hoch  
 Streuwert: 1.86, horizontal: 2.17, vertikal: 1.49

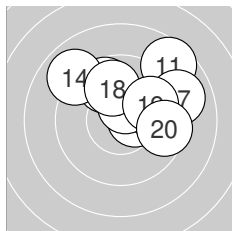

**Serie 2:**

8.6 ↗	10.5 *	9.7 ↘	8.9 ↘	9.8 →
10.5 *	9.0 ↗	9.9 ↑	9.9 ↗	9.5 →

beste Teiler: 116.3 (12.), 122.3 (16.), 266.3 (18.)  
 Trefferlage: 1.32 mm rechts, 1.75 mm hoch  
 Streuwert: 2.16, horizontal: 2.62, vertikal: 1.58

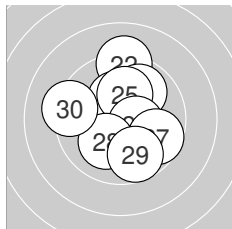

**Serie 3:**

10.4 *	9.2 ↑	9.9 ↗	10.3 *	10.1 ↑
10.4 *	9.7 ↘	10.1 ↗	9.7 ↘	9.3 ←

beste Teiler: 129.0 (26.), 137.4 (21.), 166.1 (24.)  
 Trefferlage: 0.18 mm rechts, 0.60 mm hoch  
 Streuwert: 2.04, horizontal: 1.87, vertikal: 2.19

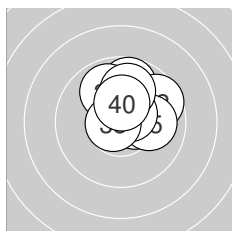

**Serie 4:**

9.7 ↑	9.7 ↗	10.5 *	10.5 *	10.0 →
10.6 *	9.9 ↘	10.7 *	9.9 ↑	10.3 *

beste Teiler: 61.0 (38.), 97.6 (36.), 111.5 (33.)  
 Trefferlage: 0.75 mm rechts, 1.22 mm hoch  
 Streuwert: 1.16, horizontal: 1.18, vertikal: 1.14

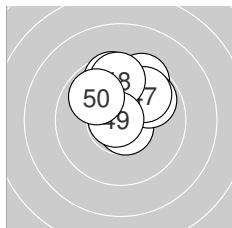

**Serie 5:**

9.5 ↗	10.7 *	10.2 *	10.3 *	9.6 ↑
9.8 ↗	9.8 ↗	9.7 ↑	10.8 *	9.9 ↘

beste Teiler: 38.6 (49.), 69.4 (42.), 154.1 (44.)  
 Trefferlage: 0.27 mm rechts, 1.78 mm hoch  
 Streuwert: 1.31, horizontal: 1.34, vertikal: 1.27

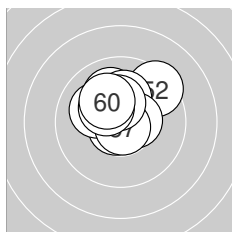

**Serie 6:**

10.0 ↘	9.4 ↗	10.2 *	10.7 *	10.1 ↘
10.5 *	10.8 *	10.3 *	10.3 *	10.2 *

beste Teiler: 43.0 (57.), 56.5 (54.), 112.8 (56.)  
 Trefferlage: 0.12 mm links, 1.13 mm hoch  
 Streuwert: 1.20, horizontal: 1.33, vertikal: 1.06



Ergebnis: **603.4** (574)  
 Serien: 101.3 98.2 101.0 100.7 101.9 100.3  
 Zähler: 37 20 3 0 0 0 0 0 0  
 Innenzehner: 30  
 Weitester: 583 (13.), 582 (21.), 533 (11.)  
 beste Teiler: 47.6 (4.), 62.0 (32.), 62.9 (43.)  
 Trefferlage: 0.19 mm rechts, 0.10 mm hoch  
 Streuwert: 1.81, horizontal: 2.14, vertikal: 1.40

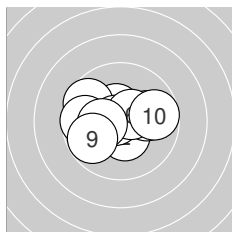
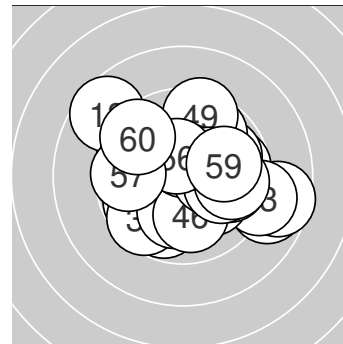

**Serie 1:**  
 10.5 \*                      10.4 \*                      9.6 ↘                      10.8 \*                      10.0 →  
 10.5 \*                      9.7 ←                      10.3 \*                      9.8 ↙                      9.7 →  
 beste Teiler: 47.6 (4.), 112.8 (6.), 118.9 (1.)  
 Trefferlage: 0.44 mm links, 0.14 mm hoch  
 Streuwert: 1.67, horizontal: 2.15, vertikal: 0.98

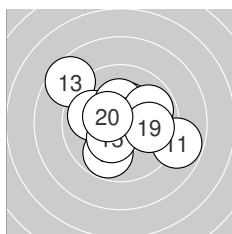

**Serie 2:**  
 8.8 →                      9.8 ↓                      8.6 ↘                      9.9 ←                      10.3 \*  
 10.3 \*                      10.3 \*                      9.9 →                      9.9 →                      10.4 \*  
 beste Teiler: 130.1 (20.), 152.3 (15.), 152.8 (16.)  
 Trefferlage: 0.03 mm rechts, 0.32 mm hoch  
 Streuwert: 2.36, horizontal: 2.75, vertikal: 1.88

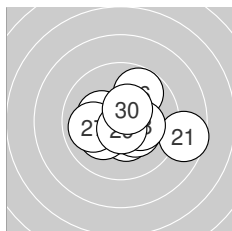

**Serie 3:**  
 8.6 →                      10.3 \*                      10.4 \*                      10.3 \*                      10.2 \*  
 9.8 ↗                      10.0 ←                      10.2 \*                      10.7 \*                      10.5 \*  
 beste Teiler: 67.7 (29.), 123.1 (30.), 143.9 (23.)  
 Trefferlage: 0.58 mm rechts, 0.24 mm tief  
 Streuwert: 1.85, horizontal: 2.31, vertikal: 1.25

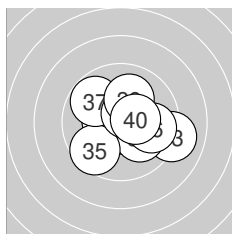

**Serie 4:**  
 10.5 \*                      10.7 \*                      9.1 →                      10.1 ↘                      9.6 ↙  
 9.8 →                      9.8 ↘                      10.6 \*                      10.1 ↗                      10.4 \*  
 beste Teiler: 62.0 (32.), 92.6 (38.), 121.1 (31.)  
 Trefferlage: 0.58 mm rechts, 0.12 mm tief  
 Streuwert: 1.84, horizontal: 2.17, vertikal: 1.43

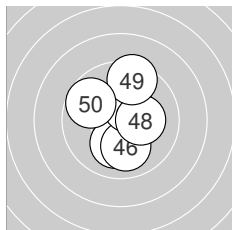

**Serie 5:**  
 10.6 \*                      10.6 \*                      10.7 \*                      10.2 \*                      10.1 ↓  
 10.0 ↓                      10.4 \*                      10.2 \*                      9.4 ↗                      9.7 ↘  
 beste Teiler: 62.9 (43.), 80.2 (42.), 94.4 (41.)  
 Trefferlage: 0.23 mm rechts, 0.13 mm tief  
 Streuwert: 1.56, horizontal: 1.21, vertikal: 1.85

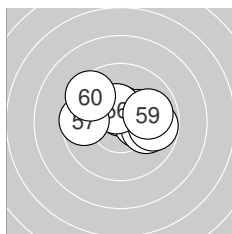

**Serie 6:**  
 10.6 \*                      10.3 \*                      9.8 ↘                      10.3 \*                      10.0 →  
 10.5 \*                      9.6 ←                      9.8 →                      9.9 →                      9.5 ↘  
 beste Teiler: 97.1 (51.), 124.6 (56.), 160.1 (54.)  
 Trefferlage: 0.19 mm rechts, 0.64 mm hoch  
 Streuwert: 1.77, horizontal: 2.34, vertikal: 0.88



Ergebnis: **600.2** (573)  
 Serien: 98.0 101.2 102.2 99.3 102.4 97.1  
 Zähler: 35 23 2 0 0 0 0 0 0  
 Innenzehner: 29  
 Weitestе: 528 (9.), 523 (60.), 495 (25.)  
 beste Teiler: 26.0 (26.), 26.2 (49.), 34.2 (24.)  
 Trefferlage: 0.76 mm links, 0.50 mm tief  
 Streuwert: 1.84, horizontal: 2.23, vertikal: 1.34

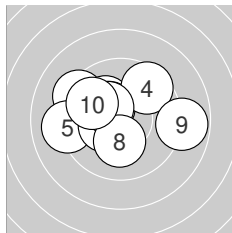
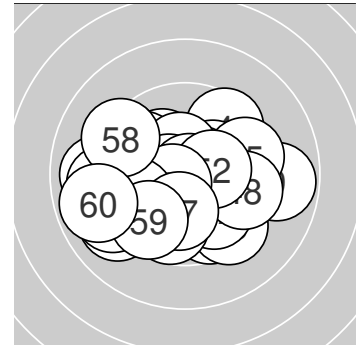

**Serie 1:**

9.3 ↘	10.2 *	10.4 *	9.5 ↗	9.1 ←
10.3 *	10.4 *	10.2 *	8.8 →	9.8 ↘

beste Teiler: 141.4 (3.), 150.0 (7.), 151.1 (6.)  
 Trefferlage: 0.79 mm links, 0.60 mm hoch  
 Streuwert: 2.24, horizontal: 2.84, vertikal: 1.42

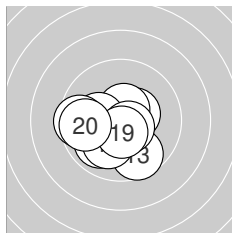

**Serie 2:**

10.4 *	10.6 *	9.7 ↘	10.2 *	9.5 ←
10.6 *	9.9 ↙	10.1 ↙	10.5 *	9.7 ←

beste Teiler: 89.9 (16.), 95.8 (12.), 103.4 (19.)  
 Trefferlage: 0.76 mm links, 0.72 mm tief  
 Streuwert: 1.51, horizontal: 1.75, vertikal: 1.21

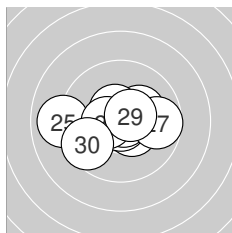

**Serie 3:**

10.2 *	10.5 *	10.5 *	10.8 *	9.0 ←
10.8 *	9.7 →	10.5 *	10.6 *	9.6 ↙

beste Teiler: 26.0 (26.), 34.2 (24.), 98.6 (29.)  
 Trefferlage: 0.26 mm links, 0.10 mm tief  
 Streuwert: 1.73, horizontal: 2.30, vertikal: 0.84

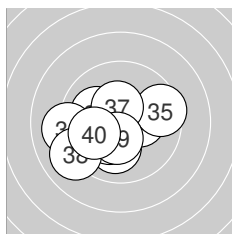

**Serie 4:**

10.1 ↓	10.1 ↘	10.3 *	10.3 *	9.5 →
9.1 ←	10.4 *	9.1 ↙	10.4 *	10.0 ←

beste Teiler: 133.1 (37.), 142.4 (39.), 162.3 (33.)  
 Trefferlage: 0.97 mm links, 0.60 mm tief  
 Streuwert: 1.95, horizontal: 2.39, vertikal: 1.38

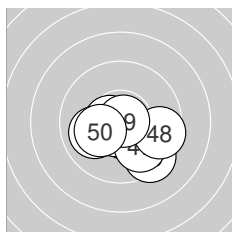

**Serie 5:**

10.6 *	10.8 *	10.5 *	10.6 *	9.4 ↘
10.0 ←	9.9 ↘	9.6 →	10.8 *	10.2 *

beste Teiler: 26.2 (49.), 50.9 (42.), 84.7 (44.)  
 Trefferlage: 0.28 mm rechts, 0.96 mm tief  
 Streuwert: 1.43, horizontal: 1.80, vertikal: 0.92

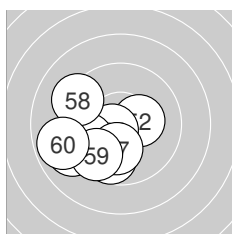

**Serie 6:**

9.8 ↙	10.3 *	9.1 ←	9.7 ↓	10.6 *
9.7 ←	10.1 ↓	9.3 ↘	9.6 ↙	8.9 ←

beste Teiler: 88.8 (55.), 159.4 (52.), 214.5 (57.)  
 Trefferlage: 2.05 mm links, 1.25 mm tief  
 Streuwert: 1.77, horizontal: 1.99, vertikal: 1.52



Ergebnis: **606.7** (580)  
 Serien: 100.7 102.0 101.0 101.1 99.9 102.0  
 Zähler: 41 18 1 0 0 0 0 0 0  
 Innenzehner: 25  
 Weitestе: 629 (50.), 459 (7.), 381 (52.)  
 beste Teiler: 11.0 (58.), 47.1 (57.), 51.0 (23.)  
 Trefferlage: 0.09 mm links, 0.42 mm tief  
 Streuwert: 1.65, horizontal: 1.78, vertikal: 1.50

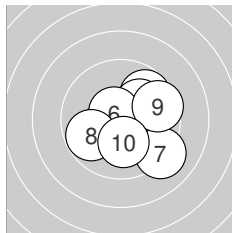
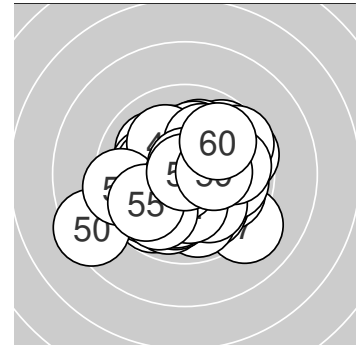

**Serie 1:**

9.8 ↗	10.1 ↗	10.7 *	10.3 *	10.6 *
10.6 *	9.1 ↘	9.8 ↖	9.6 →	10.1 ↓

beste Teiler: 52.6 (3.), 82.0 (6.), 83.8 (5.)  
 Trefferlage: 0.62 mm rechts, 0.33 mm tief  
 Streuwert: 1.80, horizontal: 1.99, vertikal: 1.60

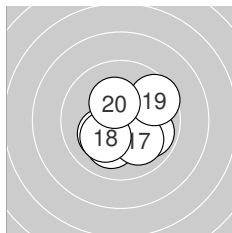

**Serie 2:**

10.5 *	10.5 *	10.7 *	10.1 ↓	10.2 *
9.9 ↘	10.0 ↘	10.2 *	9.6 →	10.3 *

beste Teiler: 71.6 (13.), 108.0 (12.), 111.6 (11.)  
 Trefferlage: 0.36 mm rechts, 0.54 mm tief  
 Streuwert: 1.45, horizontal: 1.59, vertikal: 1.30

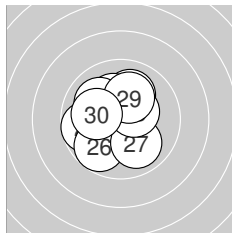

**Serie 3:**

10.0 ↑	10.2 *	10.7 *	9.7 ←	10.0 ↖
9.8 ↖	10.0 ↘	10.4 *	10.1 ↑	10.1 ←

beste Teiler: 51.0 (23.), 134.3 (28.), 188.9 (22.)  
 Trefferlage: 0.58 mm links, 0.32 mm hoch  
 Streuwert: 1.58, horizontal: 1.56, vertikal: 1.60

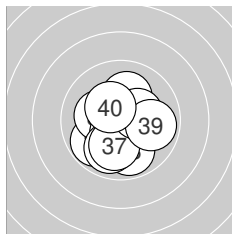

**Serie 4:**

10.1 ↑	9.8 ↖	9.9 ↓	10.2 *	10.5 *
9.9 ↓	10.1 ↓	10.3 *	9.9 →	10.4 *

beste Teiler: 116.4 (35.), 145.2 (40.), 157.5 (38.)  
 Trefferlage: 0.14 mm links, 0.64 mm tief  
 Streuwert: 1.56, horizontal: 1.50, vertikal: 1.63

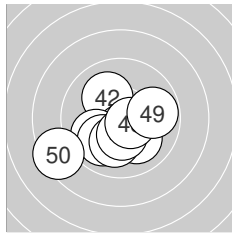

**Serie 5:**

10.1 ↘	10.1 ↖	10.5 *	9.9 ↖	10.0 ↖
10.1 ↓	10.4 *	10.6 *	9.8 →	8.4 ↖

beste Teiler: 97.0 (48.), 101.4 (43.), 145.5 (47.)  
 Trefferlage: 0.54 mm links, 1.09 mm tief  
 Streuwert: 1.89, horizontal: 2.26, vertikal: 1.41

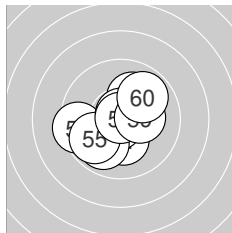

**Serie 6:**

10.2 *	9.4 ←	10.7 *	9.9 ↖	9.8 ↖
10.1 ↑	10.8 *	10.9 *	10.3 *	9.9 ↖

beste Teiler: 11.0 (58.), 47.1 (57.), 59.1 (53.)  
 Trefferlage: 0.28 mm links, 0.24 mm tief  
 Streuwert: 1.61, horizontal: 1.78, vertikal: 1.43



Ergebnis: **573.5** (549)  
 Serien: 96.1 96.2 95.2 95.8 91.8 98.4  
 Zähler: 22 25 13 0 0 0 0 0 0  
 Innenzehner: 14  
 Weitester: 746 (16.), 710 (44.), 661 (26.)  
 beste Teiler: 9.4 (5.), 46.3 (24.), 95.8 (12.)  
 Trefferlage: 0.71 mm links, 0.48 mm hoch  
 Streuwert: 2.75, horizontal: 2.70, vertikal: 2.80

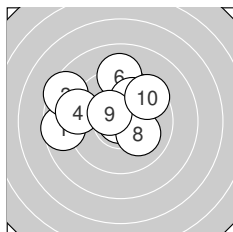
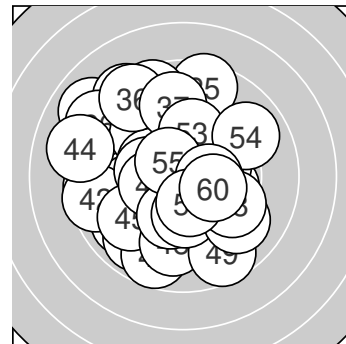

**Serie 1:**

8.6 ←	9.8 ↗	8.5 ↘	9.2 ←	10.9 *
9.1 ↑	10.0 ↗	10.1 ↘	10.4 *	9.5 ↗

beste Teiler: 9.4 (5.), 138.4 (9.), 214.4 (8.)  
 Trefferlage: 0.98 mm links, 1.43 mm hoch  
 Streuwert: 2.53, horizontal: 3.10, vertikal: 1.77

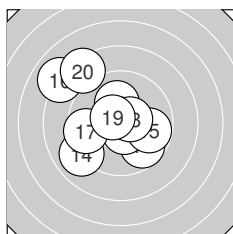

**Serie 2:**

9.7 ↘	10.6 *	10.1 ↑	9.0 ↙	9.8 →
8.0 ↘	9.5 ←	10.5 *	10.6 *	8.4 ↘

beste Teiler: 95.8 (12.), 98.8 (19.), 103.6 (18.)  
 Trefferlage: 1.20 mm links, 0.48 mm hoch  
 Streuwert: 2.82, horizontal: 2.96, vertikal: 2.68

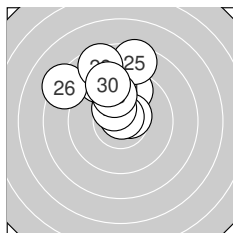

**Serie 3:**

9.7 ↑	10.5 *	9.1 ↘	10.8 *	8.5 ↑
8.3 ↘	10.4 *	9.9 ↑	8.6 ↗	9.4 ↗

beste Teiler: 46.3 (24.), 103.0 (22.), 143.5 (27.)  
 Trefferlage: 0.89 mm links, 3.06 mm hoch  
 Streuwert: 1.98, horizontal: 2.07, vertikal: 1.90

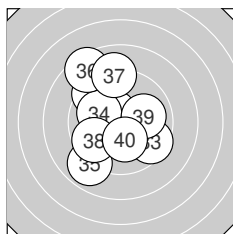

**Serie 4:**

10.5 *	9.4 ↘	9.5 ↘	10.0 ↘	8.9 ↙
8.5 ↘	9.1 ↑	9.7 ↙	10.0 →	10.2 *

beste Teiler: 110.9 (31.), 179.2 (40.), 234.2 (34.)  
 Trefferlage: 0.94 mm links, 0.56 mm hoch  
 Streuwert: 2.68, horizontal: 2.26, vertikal: 3.04

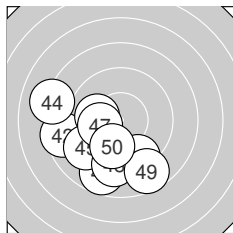

**Serie 5:**

8.7 ↓	8.6 ←	10.0 ←	8.1 ←	9.2 ↙
9.3 ↘	10.1 ←	9.2 ↓	8.7 ↘	9.9 ↓

beste Teiler: 212.2 (47.), 237.8 (43.), 274.1 (50.)  
 Trefferlage: 1.95 mm links, 2.35 mm tief  
 Streuwert: 2.69, horizontal: 2.96, vertikal: 2.39

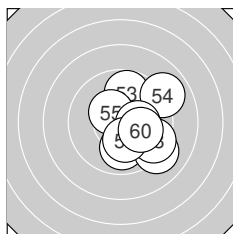

**Serie 6:**

10.2 *	9.9 ↓	9.8 ↑	9.0 ↗	10.4 *
10.3 *	9.1 ↘	9.4 ↘	10.2 *	10.1 ↘

beste Teiler: 137.9 (55.), 173.3 (56.), 180.2 (51.)  
 Trefferlage: 1.68 mm rechts, 0.29 mm tief  
 Streuwert: 1.87, horizontal: 1.66, vertikal: 2.06



Ergebnis: **400.9** (382)  
 Serien: 99.2 101.6 100.1 100.0  
 Zähler: 22 18 0 0 0 0 0 0 0 0  
 Innenzehner: 19  
 Weitestе: 485 (22.), 417 (28.), 378 (35.)  
 beste Teiler: 40.0 (14.), 70.0 (16.), 75.0 (21.)  
 Trefferlage: 0.17 mm rechts, 0.43 mm tief  
 Streuwert: 1.81, horizontal: 2.21, vertikal: 1.30

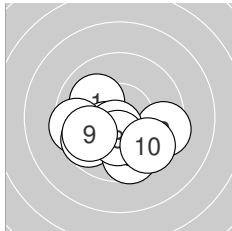
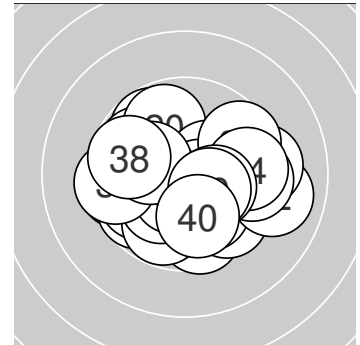

**Serie 1:**

10.1 ↖	9.5 →	10.4 *	9.5 ←	9.7 ↙
10.6 *	9.6 ↓	10.3 *	9.8 ↗	9.7 ↘

beste Teiler: 93.6 (6.), 145.9 (3.), 169.6 (8.)  
 Trefferlage: 0.52 mm links, 1.25 mm tief  
 Streuwert: 1.78, horizontal: 2.24, vertikal: 1.16

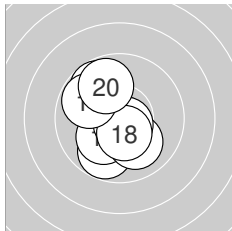

**Serie 2:**

10.4 *	9.8 ↙	10.2 *	10.8 *	10.0 ↓
10.7 *	9.7 ↖	10.4 *	9.8 ↗	9.8 ↗

beste Teiler: 40.0 (14.), 70.0 (16.), 126.8 (18.)  
 Trefferlage: 0.69 mm links, 0.13 mm tief  
 Streuwert: 1.53, horizontal: 1.18, vertikal: 1.82

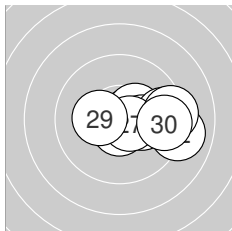

**Serie 3:**

10.7 *	9.0 →	10.6 *	10.4 *	10.2 *
9.5 →	10.6 *	9.3 →	10.3 *	9.5 →

beste Teiler: 75.0 (21.), 89.5 (27.), 93.7 (23.)  
 Trefferlage: 1.92 mm rechts, 0.08 mm tief  
 Streuwert: 1.50, horizontal: 2.04, vertikal: 0.58

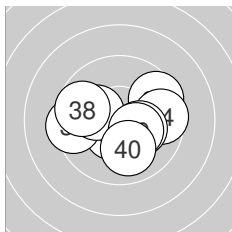

**Serie 4:**

10.5 *	9.6 ↗	10.5 *	9.6 →	9.4 ←
10.2 *	10.2 *	9.7 ↖	10.3 *	10.0 ↓

beste Teiler: 108.1 (31.), 116.2 (33.), 156.7 (39.)  
 Trefferlage: 0.00 mm, 0.24 mm tief  
 Streuwert: 1.89, horizontal: 2.42, vertikal: 1.14



Ergebnis: **385.4** (367)  
 Serien: 94.9 97.3 98.2 95.0  
 Zähler: 16 16 7 1 0 0 0 0 0 0  
 Innenzehner: 12  
 Weitester: 874 (4.), 698 (38.), 666 (32.)  
 beste Teiler: 33.0 (29.), 74.2 (2.), 112.0 (40.)  
 Trefferlage: 0.83 mm links, 0.54 mm hoch  
 Streuwert: 2.64, horizontal: 2.96, vertikal: 2.26

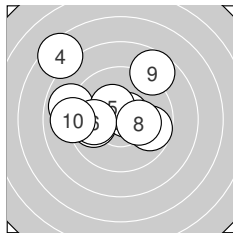
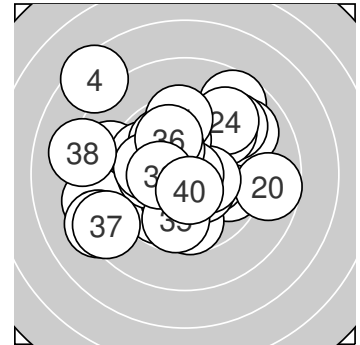

**Serie 1:**  
 9.9 ←                      10.7 \*                      8.9 ←                      7.5 ↘                      10.4 \*  
 9.9 ←                      9.7 →                      10.2 \*                      8.7 ↗                      9.0 ←  
 beste Teiler: 74.2 (2.), 147.8 (5.), 185.1 (8.)  
 Trefferlage: 1.34 mm links, 1.17 mm hoch  
 Streuwert: 2.94, horizontal: 3.38, vertikal: 2.42

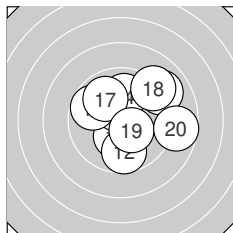

**Serie 2:**  
 10.3 \*                      9.7 ↓                      10.5 \*                      10.0 ↑                      9.7 ←  
 9.0 ↗                      9.9 ↘                      9.1 ↗                      10.4 \*                      8.7 →  
 beste Teiler: 117.3 (13.), 147.9 (19.), 165.8 (11.)  
 Trefferlage: 0.94 mm rechts, 0.63 mm hoch  
 Streuwert: 2.37, horizontal: 2.59, vertikal: 2.13

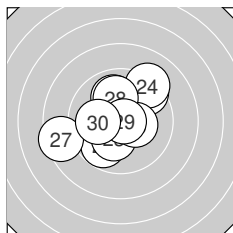

**Serie 3:**  
 9.4 ↗                      9.8 ↙                      10.2 \*                      9.2 ↗                      10.0 ↑  
 10.3 \*                      8.5 ←                      10.0 ↑                      10.8 \*                      10.0 ←  
 beste Teiler: 33.0 (29.), 151.3 (26.), 185.3 (23.)  
 Trefferlage: 0.48 mm links, 0.46 mm hoch  
 Streuwert: 2.35, horizontal: 2.55, vertikal: 2.14

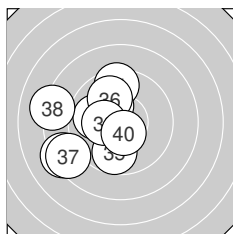

**Serie 4:**  
 9.5 ↑                      8.3 ←                      10.2 \*                      9.9 ←                      9.7 ↓  
 9.9 ↘                      8.5 ←                      8.2 ←                      10.3 \*                      10.5 \*  
 beste Teiler: 112.0 (40.), 165.1 (39.), 187.2 (33.)  
 Trefferlage: 2.47 mm links, 0.11 mm tief  
 Streuwert: 2.52, horizontal: 2.54, vertikal: 2.50



Ergebnis: **383.7** (368)  
 Serien: 94.2 97.2 96.1 96.2  
 Zähler: 15 18 7 0 0 0 0 0 0  
 Innenzehner: 11  
 Weitester: 693 (8.), 681 (2.), 679 (30.)  
 beste Teiler: 61.0 (31.), 69.3 (27.), 108.4 (14.)  
 Trefferlage: 0.55 mm rechts, 0.10 mm tief  
 Streuwert: 2.70, horizontal: 2.65, vertikal: 2.75

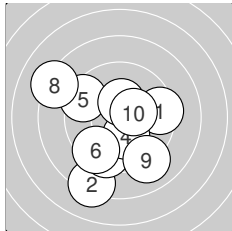
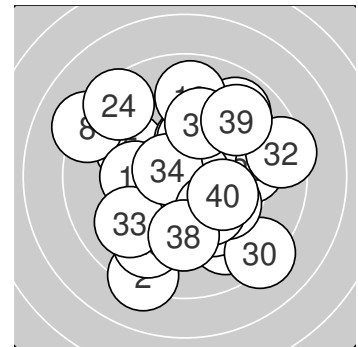

**Serie 1:**

9.4 →	8.2 ↙	9.5 ↘	10.2 *	9.4 ↖
9.4 ↙	10.4 *	8.2 ↖	9.1 ↘	10.4 *

beste Teiler: 141.7 (10.), 143.1 (7.), 185.3 (4.)  
 Trefferlage: 0.73 mm links, 1.11 mm tief  
 Streuwert: 3.03, horizontal: 3.02, vertikal: 3.04

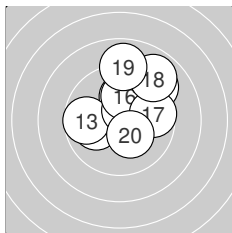

**Serie 2:**

10.1 ↑	10.0 ←	9.7 ←	10.5 *	9.1 ↗
10.0 ↑	9.7 →	8.9 ↗	8.9 ↑	10.3 *

beste Teiler: 108.4 (14.), 169.2 (20.), 225.0 (11.)  
 Trefferlage: 0.70 mm rechts, 1.63 mm hoch  
 Streuwert: 2.13, horizontal: 2.19, vertikal: 2.07

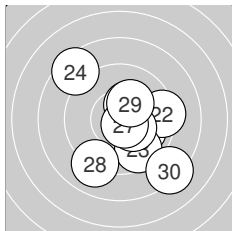

**Serie 3:**

10.0 ↘	9.3 →	9.6 ↘	8.5 ↖	10.3 *
10.3 *	10.7 *	9.0 ↙	10.2 *	8.2 ↘

beste Teiler: 69.3 (27.), 151.1 (25.), 153.4 (26.)  
 Trefferlage: 0.97 mm rechts, 0.63 mm tief  
 Streuwert: 2.75, horizontal: 2.67, vertikal: 2.83

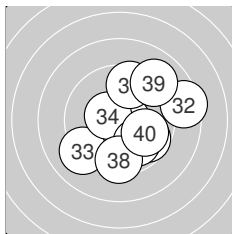

**Serie 4:**

10.7 *	8.4 →	9.1 ↙	10.5 *	9.7 ↘
9.6 ↑	9.9 ↘	9.4 ↓	9.0 ↗	9.9 ↘

beste Teiler: 61.0 (31.), 118.1 (34.), 267.4 (40.)  
 Trefferlage: 1.28 mm rechts, 0.28 mm tief  
 Streuwert: 2.56, horizontal: 2.61, vertikal: 2.52





Ergebnis: **372.7** (355)  
 Serien: 88.3 95.3 97.8 91.3  
 Zähler: 10 19 7 4 0 0 0 0 0 0  
 Innenzehner: 8  
 Weitester: 992 (5.), 986 (6.), 798 (13.)  
 beste Teiler: 118.6 (7.), 139.2 (26.), 144.7 (23.)  
 Trefferlage: 0.78 mm links, 0.83 mm hoch  
 Streuwert: 3.27, horizontal: 3.46, vertikal: 3.07

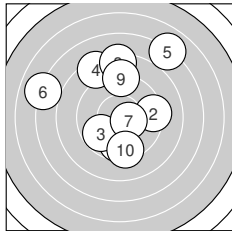
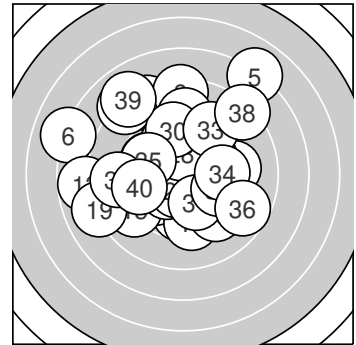

**Serie 1:**  
 9.7 ↓                      9.3 →                      9.8 ↙                      8.4 ↖                      7.0 ↗  
 7.0 ↖                      10.5 \*                      8.3 ↑                      9.0 ↑                      9.3 ↓  
 beste Teiler: 118.6 (7.), 297.3 (3.), 320.9 (1.)  
 Trefferlage: 0.30 mm links, 1.94 mm hoch  
 Streuwert: 4.22, horizontal: 4.12, vertikal: 4.31

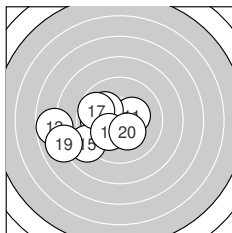

**Serie 2:**  
 10.3 \*                      9.9 ←                      7.8 ←                      10.0 ↖                      9.0 ↙  
 10.1 ↖                      9.7 ↖                      10.2 \*                      8.0 ↙                      10.3 \*  
 beste Teiler: 161.0 (11.), 167.5 (20.), 192.5 (18.)  
 Trefferlage: 2.71 mm links, 0.57 mm tief  
 Streuwert: 2.37, horizontal: 2.98, vertikal: 1.53

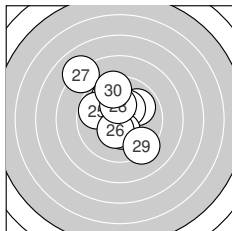

**Serie 3:**  
 9.9 ↗                      10.3 \*                      10.4 \*                      9.8 ↖                      9.8 ↖  
 10.4 \*                      8.1 ↖                      10.3 \*                      9.3 ↘                      9.5 ↑  
 beste Teiler: 139.2 (26.), 144.7 (23.), 159.5 (22.)  
 Trefferlage: 0.41 mm links, 1.13 mm hoch  
 Streuwert: 2.39, horizontal: 2.19, vertikal: 2.57

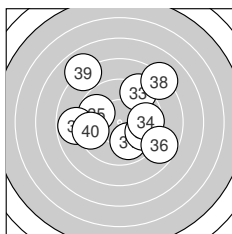

**Serie 4:**  
 9.9 ↓                      9.7 ↘                      9.2 ↗                      9.7 →                      9.7 ↖  
 8.7 ↘                      8.8 ←                      8.2 ↗                      7.9 ↖                      9.5 ←  
 beste Teiler: 255.0 (31.), 302.4 (35.), 313.0 (32.)  
 Trefferlage: 0.30 mm rechts, 0.82 mm hoch  
 Streuwert: 3.54, horizontal: 3.94, vertikal: 3.09



Ergebnis: **378.8** (362)  
 Serien: 94.2 95.5 92.2 96.9  
 Zähler: 9 24 7 0 0 0 0 0 0 0  
 Innenzehner: 5  
 Weitestе: 717 (31.), 688 (7.), 630 (25.)  
 beste Teiler: 81.8 (10.), 85.8 (2.), 98.3 (40.)  
 Trefferlage: 0.28 mm rechts, 0.31 mm tief  
 Streuwert: 2.87, horizontal: 3.51, vertikal: 2.04

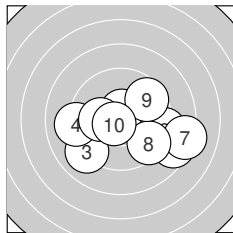
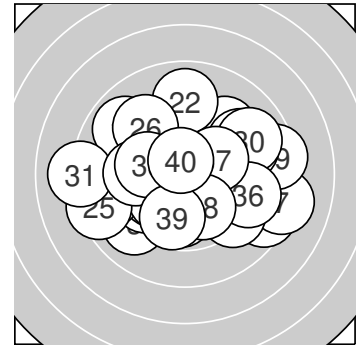

**Serie 1:**  
 8.5 ↘ 10.6 \* 9.0 ↙ 9.1 ← 10.1 ←  
 9.1 → 8.2 → 9.4 ↘ 9.6 ↗ 10.6 \*  
 beste Teiler: 81.8 (10.), 85.8 (2.), 208.0 (5.)  
 Trefferlage: 1.14 mm rechts, 0.95 mm tief  
 Streuwert: 2.97, horizontal: 3.85, vertikal: 1.67

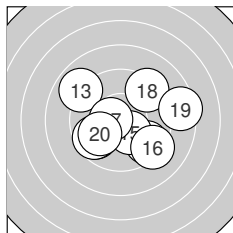

**Serie 2:**  
 9.5 ↘ 9.7 ↙ 8.9 ↘ 9.7 ↙ 10.3 \*  
 9.2 ↘ 10.6 \* 9.3 ↗ 8.4 → 9.9 ↗  
 beste Teiler: 100.3 (17.), 159.4 (15.), 254.8 (20.)  
 Trefferlage: 0.33 mm rechts, 0.38 mm tief  
 Streuwert: 2.80, horizontal: 3.32, vertikal: 2.16

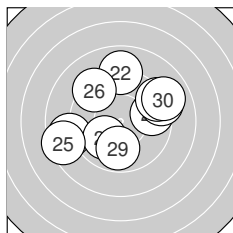

**Serie 3:**  
 8.8 ← 9.0 ↑ 10.0 ↙ 9.6 → 8.4 ←  
 9.3 ↘ 9.1 → 9.2 ↗ 9.8 ↓ 9.0 ↗  
 beste Teiler: 235.4 (23.), 278.4 (29.), 331.0 (24.)  
 Trefferlage: 0.01 mm links, 0.71 mm hoch  
 Streuwert: 3.30, horizontal: 3.86, vertikal: 2.62

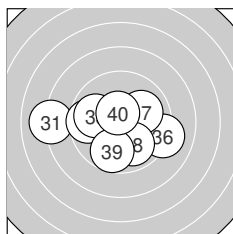

**Serie 4:**  
 8.1 ← 9.6 ← 9.9 ← 10.1 ↓ 9.9 →  
 9.1 → 10.0 ↗ 9.9 ↘ 9.7 ↓ 10.6 \*  
 beste Teiler: 98.3 (40.), 221.2 (34.), 234.3 (37.)  
 Trefferlage: 0.32 mm links, 0.64 mm tief  
 Streuwert: 2.58, horizontal: 3.35, vertikal: 1.43



Ergebnis: **186.1** (178)  
 Serien: 93.1 93.0  
 Zähler: 5 10 3 2 0 0 0 0 0 0  
 Innenzehner: 4  
 Weitester: 857 (3.), 799 (20.), 726 (14.)  
 beste Teiler: 65.1 (18.), 71.1 (2.), 157.0 (7.)  
 Trefferlage: 0.20 mm links, 0.07 mm hoch  
 Streuwert: 3.37, horizontal: 3.52, vertikal: 3.22

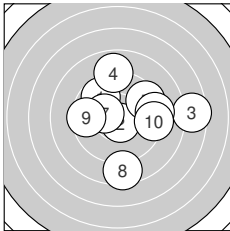
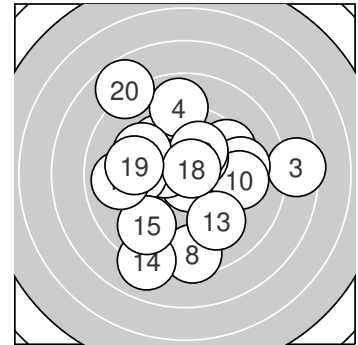

**Serie 1:**

9.7 ↘                      10.7 \*                      7.5 →                      8.9 ↑                      9.5 ↗  
 9.2 →                      10.3 \*                      8.5 ↓                      9.5 ←                      9.3 →

beste Teiler: 71.1 (2.), 157.0 (7.), 304.5 (1.)  
 Trefferlage: 1.35 mm rechts, 0.37 mm hoch  
 Streuwert: 3.28, horizontal: 3.66, vertikal: 2.84

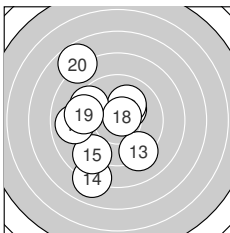

**Serie 2:**

10.3 \*                      10.1 ↗                      9.2 ↘                      8.0 ↓                      9.0 ↙  
 9.5 ↖                      9.0 ←                      10.7 \*                      9.4 ←                      7.8 ↘

beste Teiler: 65.1 (18.), 165.9 (11.), 208.3 (12.)  
 Trefferlage: 1.75 mm links, 0.22 mm tief  
 Streuwert: 3.24, horizontal: 2.71, vertikal: 3.69



Ergebnis: **189.2** (179)  
 Serien: 95.4 93.8  
 Zähler: 4 11 5 0 0 0 0 0 0 0  
 Innenzehner: 3  
 Weitesten: 735 (13.), 636 (11.), 600 (18.)  
 beste Teiler: 3.0 (3.), 44.6 (15.), 63.9 (20.)  
 Trefferlage: 0.59 mm rechts, 0.38 mm tief  
 Streuwert: 3.01, horizontal: 3.65, vertikal: 2.20

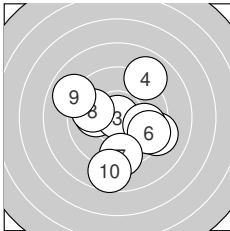
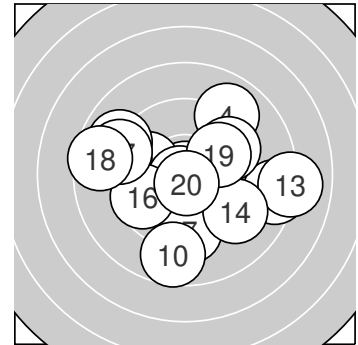

**Serie 1:**

10.1 ←                      9.2 ↘                      10.9 \*                      9.0 ↗                      9.8 →  
 9.5 ↘                      9.4 ↓                      9.9 ←                      8.9 ↖                      8.7 ↓

beste Teiler: 3.0 (3.), 225.9 (1.), 269.5 (8.)  
 Trefferlage: 0.31 mm rechts, 0.63 mm tief  
 Streuwert: 2.85, horizontal: 2.90, vertikal: 2.80

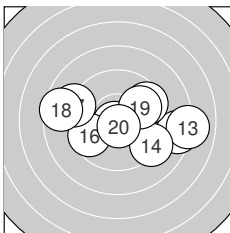

**Serie 2:**

8.4 →                      9.6 ↗                      8.0 →                      9.2 ↘                      10.8 \*  
 9.6 ←                      9.0 ←                      8.6 ←                      9.9 ↗                      10.7 \*

beste Teiler: 44.6 (15.), 63.9 (20.), 269.6 (19.)  
 Trefferlage: 0.88 mm rechts, 0.12 mm tief  
 Streuwert: 3.30, horizontal: 4.42, vertikal: 1.48



Ergebnis: **185.9** (176)  
 Serien: 95.5 90.4  
 Zähler: 4 10 4 2 0 0 0 0 0 0  
 Innenzehner: 2  
 Weitestе: 897 (14.), 773 (4.), 634 (11.)  
 beste Teiler: 103.0 (1.), 163.8 (18.), 236.8 (16.)  
 Trefferlage: 1.52 mm rechts, 0.26 mm tief  
 Streuwert: 3.13, horizontal: 3.98, vertikal: 1.94

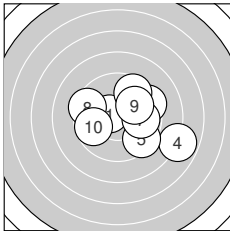
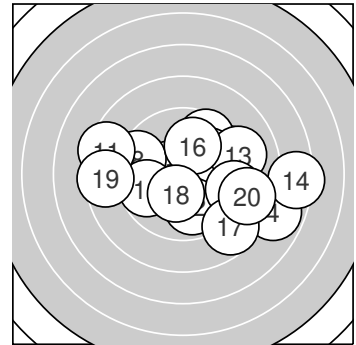

**Serie 1:**

10.5 *	9.8 →	9.4 ↗	7.9 ↘	9.4 ↘
9.6 ↗	9.8 →	9.4 ↖	10.0 ↗	9.7 ←

beste Teiler: 103.0 (1.), 247.7 (9.), 278.0 (7.)  
 Trefferlage: 1.55 mm rechts, 0.10 mm hoch  
 Streuwert: 2.62, horizontal: 3.20, vertikal: 1.87

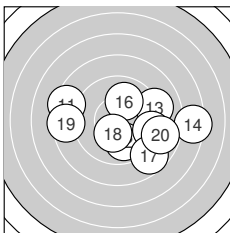

**Serie 2:**

8.4 ←	9.9 ↓	9.1 →	7.4 →	9.3 →
10.0 ↗	8.7 ↘	10.3 *	8.5 ←	8.8 →

beste Teiler: 163.8 (18.), 236.8 (16.), 265.2 (12.)  
 Trefferlage: 1.49 mm rechts, 0.63 mm tief  
 Streuwert: 3.70, horizontal: 4.82, vertikal: 2.05



**Ergebnis:** **203.0** (195)  
**Serien:** 101.7 101.3  
**Zähler:** 15 5 0 0 0 0 0 0 0 0  
**Innenzehner:** 11  
**Weiteste:** 431 (2.), 364 (13.), 331 (12.)  
**beste Teiler:** 38.2 (19.), 49.5 (4.), 63.0 (11.)  
**Trefferlage:** 1.35 mm links, 0.50 mm tief  
**Streuwert:** 1.29, horizontal: 1.64, vertikal: 0.78

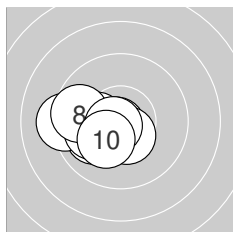
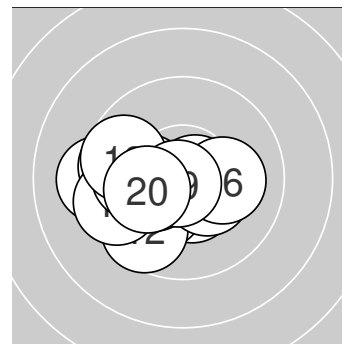

**Serie 1:**

10.0 ↙	9.2 ←	10.4 *	10.8 *	10.0 ↙
10.2 *	10.5 *	9.7 ←	10.7 *	10.2 *

**beste Teiler:** 49.5 (4.), 65.5 (9.), 120.0 (7.)  
**Trefferlage:** 1.63 mm links, 0.50 mm tief  
**Streuwert:** 1.08, horizontal: 1.40, vertikal: 0.61

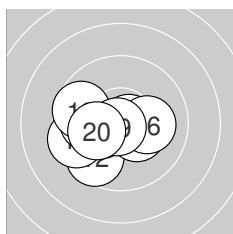

**Serie 2:**

10.7 *	9.6 ↙	9.5 ↙	10.0 ←	10.4 *
10.1 →	10.3 *	9.7 ↙	10.8 *	10.2 *

**beste Teiler:** 38.2 (19.), 63.0 (11.), 146.1 (15.)  
**Trefferlage:** 1.06 mm links, 0.50 mm tief  
**Streuwert:** 1.49, horizontal: 1.88, vertikal: 0.96



Ergebnis: **169.5** (157)  
 Serien: 86.5 83.0  
 Zähler: 1 6 6 4 2 1 0 0 0 0  
 Innenzehner: 1  
 Weitester: 1275 (12.), 1027 (16.), 1005 (13.)  
 beste Teiler: 171.4 (5.), 263.9 (20.), 280.7 (1.)  
 Trefferlage: 0.00 mm , 1.00 mm tief  
 Streuwert: 4.95, horizontal: 6.33, vertikal: 2.99

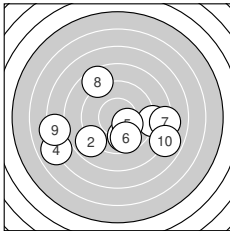
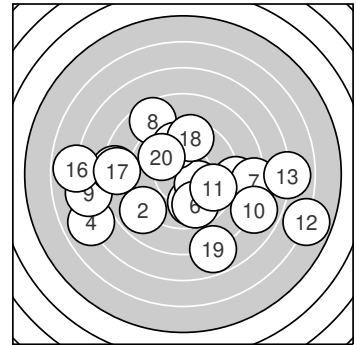

**Serie 1:**

9.8 ↓	8.9 ↙	8.9 →	7.0 ↙	10.3 *
9.7 ↓	8.2 →	8.6 ↖	7.2 ←	7.9 →

beste Teiler: 171.4 (5.), 280.7 (1.), 316.2 (6.)  
 Trefferlage: 0.25 mm links, 1.60 mm tief  
 Streuwert: 4.56, horizontal: 5.84, vertikal: 2.72

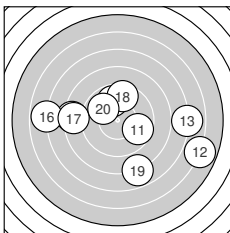

**Serie 2:**

9.7 →	5.9 →	6.9 →	8.3 ←	9.8 ↑
6.8 ←	8.4 ←	9.5 ↑	7.8 ↓	9.9 ↖

beste Teiler: 263.9 (20.), 283.5 (15.), 320.1 (11.)  
 Trefferlage: 0.24 mm rechts, 0.40 mm tief  
 Streuwert: 5.53, horizontal: 7.10, vertikal: 3.27



Ergebnis: **189.3** (182)  
 Serien: 97.7 91.6  
 Zähler: 8 8 2 2 0 0 0 0 0 0  
 Innenzehner: 3  
 Weitestе: 966 (14.), 831 (20.), 672 (15.)  
 beste Teiler: 112.0 (6.), 141.5 (19.), 153.9 (8.)  
 Trefferlage: 1.20 mm rechts, 0.81 mm hoch  
 Streuwert: 2.98, horizontal: 4.05, vertikal: 1.16

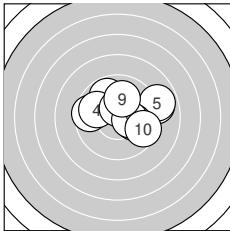
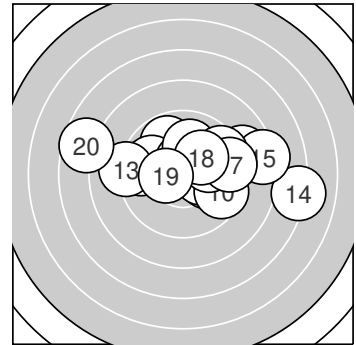

**Serie 1:**

9.8 ↘	9.6 ←	9.0 →	9.9 ←	8.9 →
10.5 *	10.1 →	10.3 *	10.0 ↑	9.6 →

beste Teiler: 112.0 (6.), 153.9 (8.), 206.2 (7.)  
 Trefferlage: 0.95 mm rechts, 0.82 mm hoch  
 Streuwert: 2.23, horizontal: 2.88, vertikal: 1.29

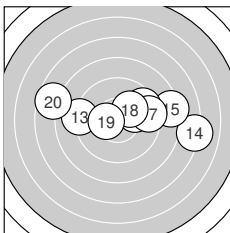

**Serie 2:**

10.1 ↗	10.0 →	9.1 ←	7.1 →	8.3 →
9.5 ↗	9.4 →	10.1 ↗	10.4 *	7.6 ←

beste Teiler: 141.5 (19.), 203.8 (18.), 212.9 (11.)  
 Trefferlage: 1.45 mm rechts, 0.81 mm hoch  
 Streuwert: 3.70, horizontal: 5.12, vertikal: 1.09





Ergebnis: **170.0** (162)  
 Serien: 80.2 89.8  
 Zähler: 5 4 4 4 2 0 1 0 0 0  
 Innenzehner: 3  
 Weitestе: 1561 (9.), 1129 (7.), 1075 (15.)  
 beste Teiler: 124.0 (2.), 152.8 (13.), 153.6 (19.)  
 Trefferlage: 1.58 mm rechts, 0.45 mm hoch  
 Streuwert: 5.07, horizontal: 6.75, vertikal: 2.44

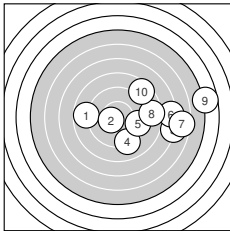
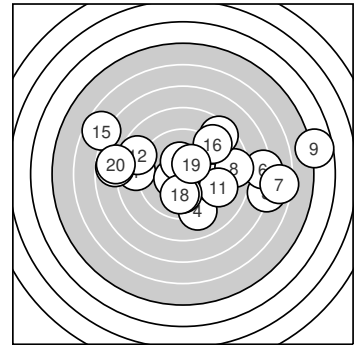

**Serie 1:**

8.8 ←	10.5 *	7.0 →	9.1 ↓	9.5 →
7.2 →	6.4 →	8.5 →	4.7 →	8.5 ↗

beste Teiler: 124.0 (2.), 371.4 (5.), 459.0 (4.)  
 Trefferlage: 5.44 mm rechts, 0.00 mm  
 Streuwert: 4.73, horizontal: 6.21, vertikal: 2.49

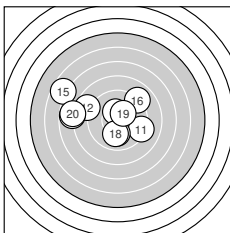

**Serie 2:**

9.2 ↘	8.7 ↖	10.3 *	10.0 ↓	6.7 ↖
9.0 ↗	7.8 ←	10.0 ↓	10.3 *	7.8 ←

beste Teiler: 152.8 (13.), 153.6 (19.), 228.0 (14.)  
 Trefferlage: 2.28 mm links, 0.91 mm hoch  
 Streuwert: 3.90, horizontal: 4.95, vertikal: 2.43



Ergebnis: **198.8** (191)  
 Serien: 99.0 99.8  
 Zähler: 12 7 1 0 0 0 0 0 0 0  
 Innenzehner: 6  
 Weitester: 637 (2.), 415 (18.), 340 (14.)  
 beste Teiler: 85.0 (11.), 104.0 (17.), 146.7 (10.)  
 Trefferlage: 1.09 mm rechts, 1.56 mm hoch  
 Streuwert: 1.50, horizontal: 1.87, vertikal: 1.01

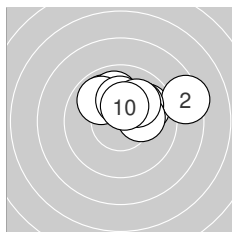
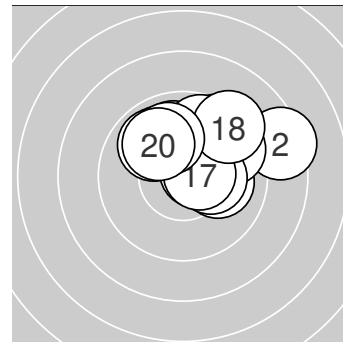

**Serie 1:**

9.9 ↗	8.4 →	9.9 ↘	10.0 ↗	10.2 *
10.0 ↑	9.9 ↙	10.2 *	10.1 ↗	10.4 *

beste Teiler: 146.7 (10.), 193.1 (5.), 195.1 (8.)  
 Trefferlage: 0.99 mm rechts, 1.66 mm hoch  
 Streuwert: 1.67, horizontal: 2.29, vertikal: 0.58

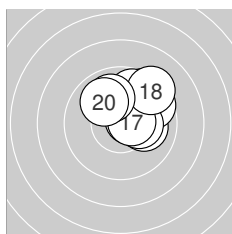

**Serie 2:**

10.6 *	10.1 →	9.6 ↗	9.6 ↗	9.8 ↑
10.3 *	10.5 *	9.3 ↗	10.0 ↑	10.0 ↘

beste Teiler: 85.0 (11.), 104.0 (17.), 173.3 (16.)  
 Trefferlage: 1.19 mm rechts, 1.45 mm hoch  
 Streuwert: 1.40, horizontal: 1.46, vertikal: 1.34



Ergebnis: **200.6** (191)  
 Serien: 100.6 100.0  
 Zähler: 12 7 1 0 0 0 0 0 0 0  
 Innenzehner: 9  
 Weitesten: 582 (17.), 405 (3.), 401 (7.)  
 beste Teiler: 40.7 (9.), 77.1 (1.), 89.3 (8.)  
 Trefferlage: 0.03 mm rechts, 0.24 mm tief  
 Streuwert: 1.89, horizontal: 2.32, vertikal: 1.34

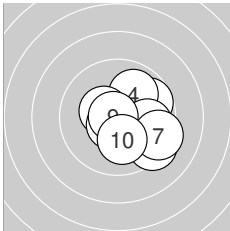
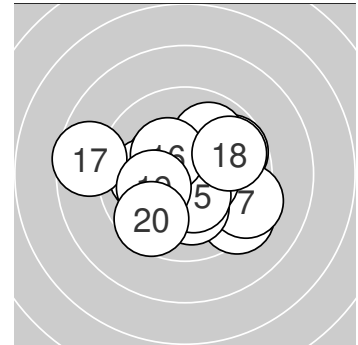

**Serie 1:**

10.6 *	9.7 ↗	9.3 ↘	9.9 ↗	10.4 *
9.9 →	9.3 →	10.6 *	10.8 *	10.1 ↓

beste Teiler: 40.7 (9.), 77.1 (1.), 89.3 (8.)  
 Trefferlage: 1.21 mm rechts, 0.41 mm tief  
 Streuwert: 1.62, horizontal: 1.76, vertikal: 1.46

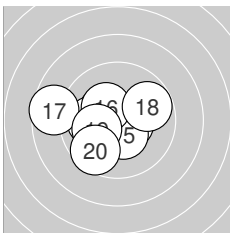

**Serie 2:**

10.3 *	10.4 *	10.5 *	10.0 ←	10.4 *
10.3 *	8.6 ←	9.8 ↗	10.1 ←	9.6 ↘

beste Teiler: 106.5 (13.), 138.1 (15.), 146.4 (12.)  
 Trefferlage: 1.15 mm links, 0.06 mm tief  
 Streuwert: 1.83, horizontal: 2.26, vertikal: 1.25



Ergebnis: **192.2** (180)  
 Serien: 94.0 98.2  
 Zähler: 4 13 2 1 0 0 0 0 0 0  
 Innenzehner: 4  
 Weitesten: 766 (6.), 712 (1.), 508 (2.)  
 beste Teiler: 116.0 (11.), 138.2 (8.), 152.8 (3.)  
 Trefferlage: 1.35 mm rechts, 0.79 mm tief  
 Streuwert: 2.46, horizontal: 3.24, vertikal: 1.27

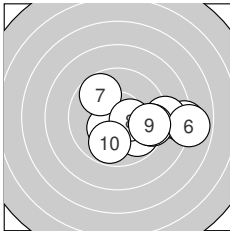
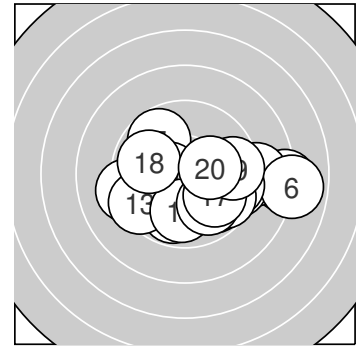

**Serie 1:**

8.1 →	8.9 →	10.3 *	9.8 ↘	9.5 →
7.9 →	9.7 ↖	10.4 *	9.6 →	9.8 ↓

beste Teiler: 138.2 (8.), 152.8 (3.), 280.2 (10.)  
 Trefferlage: 2.65 mm rechts, 0.66 mm tief  
 Streuwert: 2.54, horizontal: 3.33, vertikal: 1.33

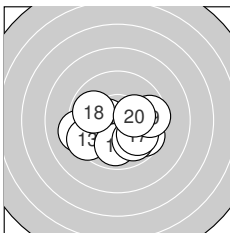

**Serie 2:**

10.5 *	9.2 ←	9.4 ←	9.7 ↘	9.9 ↓
9.9 ↘	9.9 ↘	9.9 ↖	9.6 →	10.2 *

beste Teiler: 116.0 (11.), 184.8 (20.), 260.2 (17.)  
 Trefferlage: 0.05 mm rechts, 0.92 mm tief  
 Streuwert: 2.10, horizontal: 2.69, vertikal: 1.25



Ergebnis: **196.7** (186)  
 Serien: 96.3 100.4  
 Zähler: 9 9 1 1 0 0 0 0 0 0  
 Innenzehner: 6  
 Weitestе: 763 (6.), 691 (8.), 466 (18.)  
 beste Teiler: 68.2 (17.), 96.8 (3.), 120.5 (4.)  
 Trefferlage: 0.60 mm links, 1.47 mm hoch  
 Streuwert: 2.09, horizontal: 2.47, vertikal: 1.64

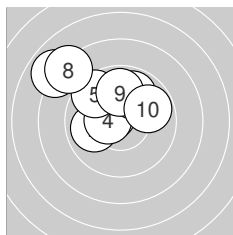
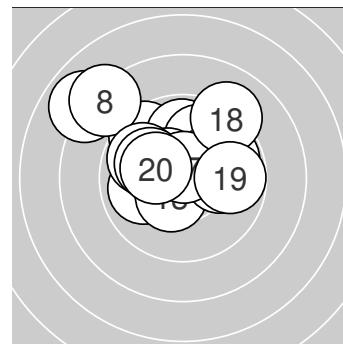

**Serie 1:**

10.1 ↗	9.9 ←	10.6 *	10.5 *	9.5 ↘
7.9 ↘	9.9 ↗	8.2 ↘	9.9 ↑	9.8 ↗

beste Teiler: 96.8 (3.), 120.5 (4.), 211.4 (1.)  
 Trefferlage: 1.31 mm links, 2.00 mm hoch  
 Streuwert: 2.33, horizontal: 2.75, vertikal: 1.80

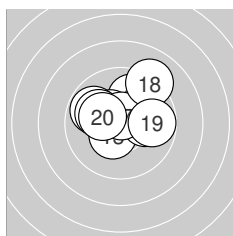

**Serie 2:**

9.9 ↗	10.4 *	10.4 *	9.8 ↘	10.0 →
10.1 ↘	10.7 *	9.1 ↗	9.8 →	10.2 *

beste Teiler: 68.2 (17.), 130.8 (12.), 134.2 (13.)  
 Trefferlage: 0.11 mm rechts, 0.94 mm hoch  
 Streuwert: 1.73, horizontal: 2.04, vertikal: 1.35



Ergebnis: **201.9** (193)  
 Serien: 100.4 101.5  
 Zähler: 13 7 0 0 0 0 0 0 0 0  
 Innenzehner: 12  
 Weitestе: 436 (9.), 417 (4.), 367 (14.)  
 beste Teiler: 58.3 (12.), 74.4 (20.), 87.3 (10.)  
 Trefferlage: 0.70 mm rechts, 0.54 mm hoch  
 Streuwert: 1.63, horizontal: 1.99, vertikal: 1.17

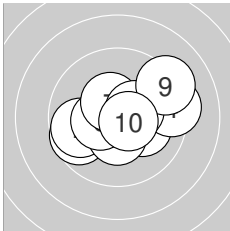
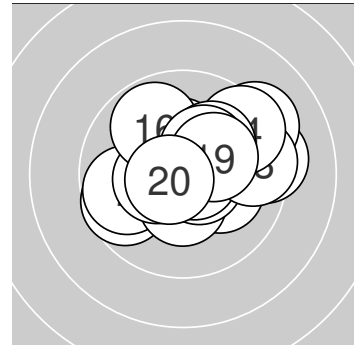

**Serie 1:**

9.7 ↙	9.8 ↙	10.2 *	9.3 →	10.4 *
10.4 *	10.4 *	10.4 *	9.2 ↗	10.6 *

beste Teiler: 87.3 (10.), 127.9 (7.), 133.3 (6.)  
 Trefferlage: 0.40 mm rechts, 0.00 mm  
 Streuwert: 1.91, horizontal: 2.42, vertikal: 1.21

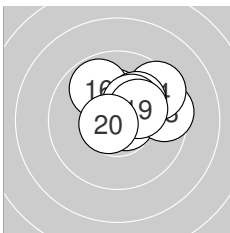

**Serie 2:**

10.4 *	10.7 *	9.5 →	9.5 ↗	10.3 *
9.8 ↘	10.1 ↗	10.3 *	10.2 *	10.7 *

beste Teiler: 58.3 (12.), 74.4 (20.), 132.6 (11.)  
 Trefferlage: 0.99 mm rechts, 1.07 mm hoch  
 Streuwert: 1.25, horizontal: 1.53, vertikal: 0.88



Ergebnis: **183.2** (172)  
 Serien: 88.5 94.7  
 Zähler: 4 7 6 3 0 0 0 0 0 0  
 Innenzehner: 4  
 Weitesten: 958 (6.), 892 (15.), 751 (18.)  
 beste Teiler: 96.4 (13.), 99.3 (11.), 135.9 (14.)  
 Trefferlage: 0.08 mm rechts, 1.95 mm hoch  
 Streuwert: 3.44, horizontal: 4.38, vertikal: 2.11

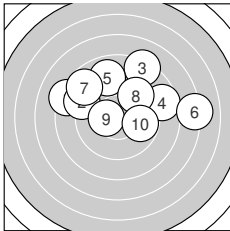
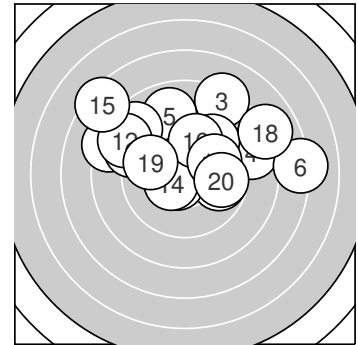

**Serie 1:**

8.3 ↖	9.0 ↖	8.2 ↗	8.6 →	8.9 ↑
7.1 →	8.7 ↖	9.5 ↗	10.4 *	9.8 →

beste Teiler: 140.4 (9.), 291.3 (10.), 352.1 (8.)  
 Trefferlage: 0.56 mm rechts, 2.34 mm hoch  
 Streuwert: 3.81, horizontal: 4.95, vertikal: 2.15

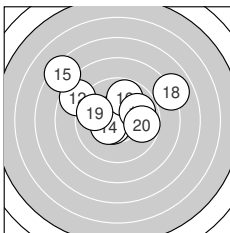

**Serie 2:**

10.6 *	8.7 ↖	10.6 *	10.4 *	7.4 ↖
9.8 ↗	9.9 →	7.9 ↗	9.7 ↖	9.7 →

beste Teiler: 96.4 (13.), 99.3 (11.), 135.9 (14.)  
 Trefferlage: 0.39 mm links, 1.57 mm hoch  
 Streuwert: 3.16, horizontal: 3.94, vertikal: 2.11

