

Ergebnis: **390** (404.2)  
 Serien: 100 96 95 99  
 Zähler: 30 10 0 0 0 0 0 0 0 0  
 Innenzehner: 21  
 Weitestе: 480 (21.), 449 (13.), 385 (17.)  
 beste Teiler: 57.4 (25.), 59.6 (1.), 98.0 (18.)  
 Trefferlage: 0.39 mm links, 0.14 mm tief  
 Streuwert: 1.66, horizontal: 1.90, vertikal: 1.37

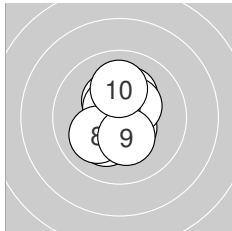
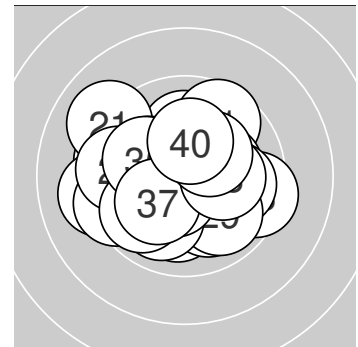

**Serie 1:**

10.7 *	10.2 *	10.5 *	10.4 *	10.2 *
10.4 *	10.6 *	10.1 ↙	10.3 *	10.1 ↑

beste Teiler: 59.6 (1.), 100.7 (7.), 105.7 (3.)  
 Trefferlage: 0.07 mm links, 0.12 mm hoch  
 Streuwert: 1.20, horizontal: 0.93, vertikal: 1.43

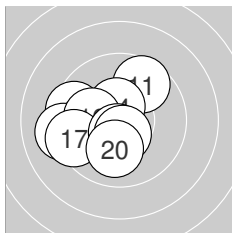

**Serie 2:**

9.6 ↗	9.5 ←	9.2 ←	10.5 *	10.3 *
10.1 ←	9.4 ←	10.6 *	10.5 *	10.0 ↓

beste Teiler: 98.0 (18.), 110.6 (19.), 110.8 (14.)  
 Trefferlage: 1.39 mm links, 0.25 mm tief  
 Streuwert: 1.75, horizontal: 1.98, vertikal: 1.49

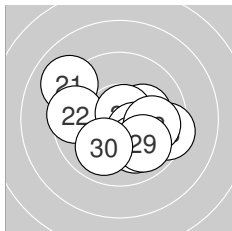

**Serie 3:**

9.0 ↘	9.6 ←	9.4 →	10.2 *	10.7 *
10.3 *	10.0 ↘	9.9 →	9.9 ↘	10.0 ↙

beste Teiler: 57.4 (25.), 152.0 (26.), 187.7 (24.)  
 Trefferlage: 0.39 mm rechts, 0.42 mm tief  
 Streuwert: 2.08, horizontal: 2.52, vertikal: 1.51

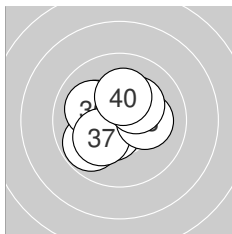

**Serie 4:**

10.1 ↙	10.5 *	10.5 *	9.8 ↙	10.1 ↘
10.1 ↘	10.2 *	10.2 *	10.3 *	10.2 *

beste Teiler: 108.9 (33.), 125.1 (32.), 174.8 (39.)  
 Trefferlage: 0.51 mm links, 0.03 mm tief  
 Streuwert: 1.42, horizontal: 1.60, vertikal: 1.21



Ergebnis: **395** (415.2)  
 Serien: 99 99 99 98  
 Zähler: 35 5 0 0 0 0 0 0 0 0  
 Innenzehner: 30  
 Weitestе: 302 (30.), 288 (10.), 277 (39.)  
 beste Teiler: 26.0 (16.), 33.0 (17.), 35.5 (20.)  
 Trefferlage: 0.00 mm , 0.02 mm tief  
 Streuwert: 1.15, horizontal: 1.35, vertikal: 0.91

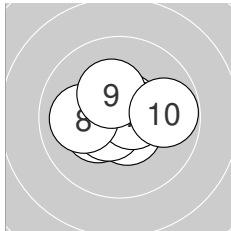
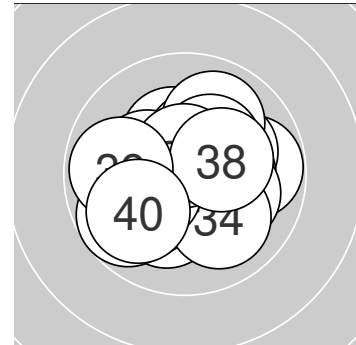

**Serie 1:**

10.3 *	10.6 *	10.5 *	10.7 *	10.3 *
10.6 *	10.6 *	10.0 ←	10.3 *	9.8 →

beste Teiler: 74.0 (4.), 84.3 (7.), 93.7 (6.)  
 Trefferlage: 0.29 mm links, 0.03 mm hoch  
 Streuwert: 1.18, horizontal: 1.50, vertikal: 0.73

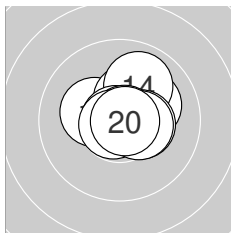

**Serie 2:**

10.3 *	10.1 ↗	10.4 *	9.9 ↗	10.4 *
10.8 *	10.8 *	10.8 *	10.4 *	10.8 *

beste Teiler: 26.0 (16.), 33.0 (17.), 35.5 (20.)  
 Trefferlage: 0.45 mm rechts, 0.41 mm hoch  
 Streuwert: 0.94, horizontal: 1.02, vertikal: 0.85

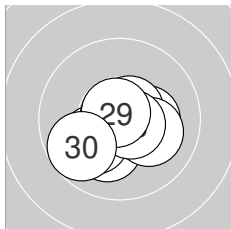

**Serie 3:**

10.2 *	10.5 *	10.3 *	10.1 ↙	10.6 *
10.8 *	10.1 ↘	10.6 *	10.8 *	9.7 ↙

beste Teiler: 35.7 (26.), 48.3 (29.), 80.5 (28.)  
 Trefferlage: 0.05 mm rechts, 0.48 mm tief  
 Streuwert: 1.18, horizontal: 1.41, vertikal: 0.89

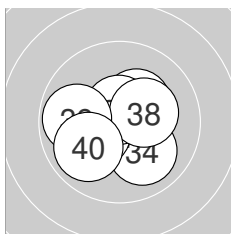

**Serie 4:**

10.6 *	10.6 *	10.7 *	10.0 ↘	10.3 *
10.3 *	10.6 *	10.3 *	9.8 ←	9.9 ↙

beste Teiler: 53.0 (33.), 76.0 (31.), 80.1 (37.)  
 Trefferlage: 0.18 mm links, 0.06 mm tief  
 Streuwert: 1.30, horizontal: 1.50, vertikal: 1.05



**Ergebnis:** **387** (404.4)  
**Serien:** 94 99 96 98  
**Zähler:** 28 11 1 0 0 0 0 0 0  
**Innenzehner:** 19  
**Weiteste:** 639 (5.), 385 (21.), 370 (28.)  
**beste Teiler:** 40.1 (39.), 61.7 (19.), 88.0 (34.)  
**Trefferlage:** 0.12 mm rechts, 0.08 mm hoch  
**Streuwert:** 1.68, horizontal: 1.87, vertikal: 1.47

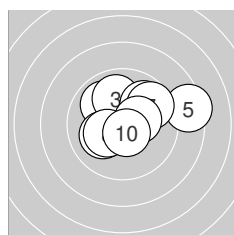
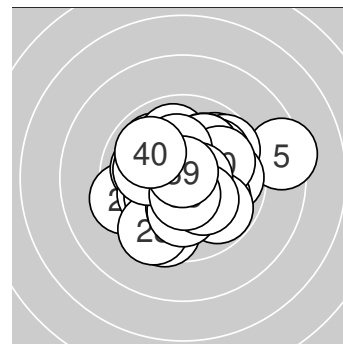

**Serie 1:**  
 10.4 \*                      9.9 ↘                      9.9 ↑                      10.1 ↙                      8.4 →  
    9.9 ↗                      9.7 ↗                      10.3 \*                      10.4 \*                      10.6 \*  
**beste Teiler:** 88.1 (10.), 139.6 (1.), 149.7 (9.)  
**Trefferlage:** 0.56 mm rechts, 0.77 mm hoch  
**Streuwert:** 2.03, horizontal: 2.56, vertikal: 1.29

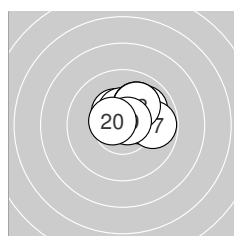

**Serie 2:**  
 10.4 \*                      10.0 ↗                      10.6 \*                      10.4 \*                      10.1 ↗  
    10.3 \*                      9.8 →                      10.1 ↗                      10.7 \*                      10.5 \*  
**beste Teiler:** 61.7 (19.), 94.0 (13.), 103.6 (20.)  
**Trefferlage:** 0.84 mm rechts, 0.96 mm hoch  
**Streuwert:** 0.97, horizontal: 1.20, vertikal: 0.65

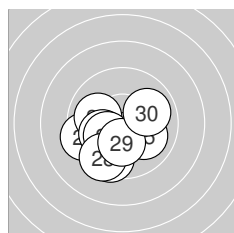

**Serie 3:**  
 9.4 ↙                      10.4 \*                      10.0 ↖                      10.1 ↙                      10.0 ↘  
    10.2 \*                      9.5 ↓                      9.5 ↓                      10.2 \*                      9.9 →  
**beste Teiler:** 126.0 (22.), 181.2 (29.), 186.4 (26.)  
**Trefferlage:** 0.80 mm links, 1.25 mm tief  
**Streuwert:** 1.65, horizontal: 1.89, vertikal: 1.38

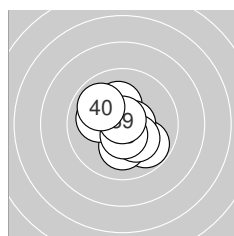

**Serie 4:**  
 9.8 ↘                      10.5 \*                      10.2 \*                      10.6 \*                      10.1 ↓  
    10.1 ↖                      10.2 \*                      10.5 \*                      10.8 \*                      9.9 ↘  
**beste Teiler:** 40.1 (39.), 88.0 (34.), 103.6 (38.)  
**Trefferlage:** 0.10 mm links, 0.12 mm tief  
**Streuwert:** 1.37, horizontal: 1.36, vertikal: 1.38



**Ergebnis:** **380** (395.5)  
**Serien:** 93 97 94 96  
**Zähler:** 23 14 3 0 0 0 0 0 0  
**Innenzehner:** 14  
**Weiteste:** 709 (24.), 613 (7.), 569 (16.)  
**beste Teiler:** 76.3 (22.), 86.9 (30.), 97.0 (19.)  
**Trefferlage:** 1.10 mm rechts, 0.66 mm hoch  
**Streuwert:** 1.96, horizontal: 1.80, vertikal: 2.10

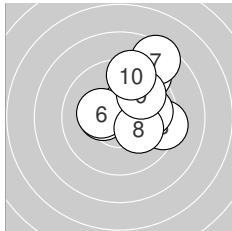
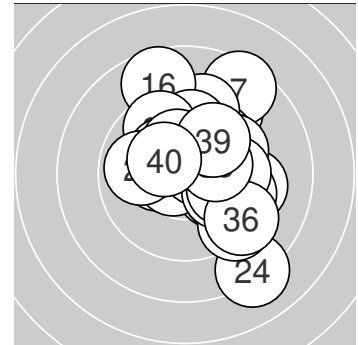

**Serie 1:**

10.5 *	9.1 ↗	9.3 →	9.9 →	10.4 *
10.3 *	8.5 ↗	10.1 ↘	9.8 ↗	9.4 ↑

**beste Teiler:** 103.3 (1.), 149.6 (5.), 169.8 (6.)  
**Trefferlage:** 1.44 mm rechts, 1.51 mm hoch  
**Streuwert:** 2.00, horizontal: 1.88, vertikal: 2.11

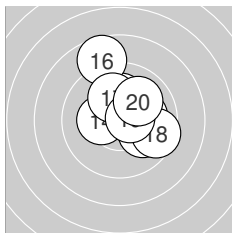

**Serie 2:**

10.1 →	10.0 ↘	10.4 *	10.3 *	10.1 ↑
8.7 ↑	10.1 ↑	9.6 ↘	10.6 *	10.0 ↗

**beste Teiler:** 97.0 (19.), 146.5 (13.), 165.0 (14.)  
**Trefferlage:** 0.73 mm rechts, 1.06 mm hoch  
**Streuwert:** 1.81, horizontal: 1.66, vertikal: 1.94

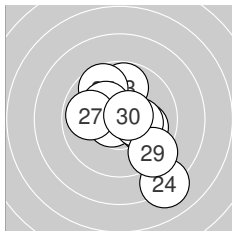

**Serie 3:**

10.0 ↘	10.6 *	9.8 ↑	8.1 ↘	9.7 ↘
10.3 *	9.9 ←	10.3 *	9.3 ↘	10.6 *

**beste Teiler:** 76.3 (22.), 86.9 (30.), 172.5 (26.)  
**Trefferlage:** 0.60 mm rechts, 0.25 mm tief  
**Streuwert:** 2.38, horizontal: 2.16, vertikal: 2.59

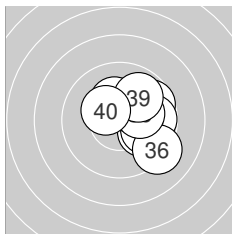

**Serie 4:**

10.0 ↘	10.3 *	9.7 ↗	10.0 ↘	9.8 →
9.2 ↘	10.3 *	10.2 *	9.9 ↗	10.3 *

**beste Teiler:** 151.4 (37.), 154.2 (40.), 174.4 (32.)  
**Trefferlage:** 1.64 mm rechts, 0.32 mm hoch  
**Streuwert:** 1.49, horizontal: 1.50, vertikal: 1.47



**Ergebnis:** **383** (403.4)  
**Serien:** 95 99 93 96  
**Zähler:** 24 15 1 0 0 0 0 0 0  
**Innenzehner:** 21  
**Weiteste:** 558 (29.), 494 (4.), 452 (7.)  
**beste Teiler:** 21.2 (18.), 57.9 (2.), 61.8 (30.)  
**Trefferlage:** 0.36 mm links, 0.24 mm hoch  
**Streuwert:** 1.79, horizontal: 2.20, vertikal: 1.26

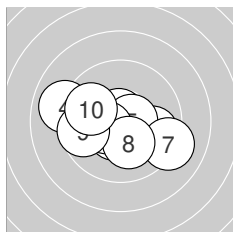
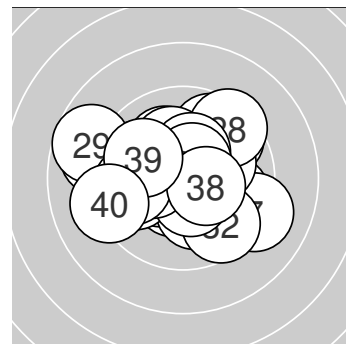

**Serie 1:**

10.5 *	10.7 *	9.8 ↘	9.0 ↖	10.6 *
10.4 *	9.1 ↘	10.2 *	9.6 ↖	9.9 ↖

**beste Teiler:** 57.9 (2.), 93.1 (5.), 122.9 (1.)  
**Trefferlage:** 0.40 mm links, 0.42 mm tief  
**Streuwert:** 2.06, horizontal: 2.69, vertikal: 1.12

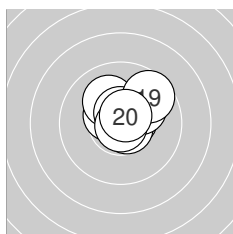

**Serie 2:**

10.7 *	10.6 *	10.7 *	10.5 *	10.1 ↗
10.1 ↖	10.6 *	10.9 *	9.6 ↗	10.6 *

**beste Teiler:** 21.2 (18.), 66.0 (13.), 75.6 (11.)  
**Trefferlage:** 0.44 mm rechts, 0.79 mm hoch  
**Streuwert:** 0.96, horizontal: 1.06, vertikal: 0.84

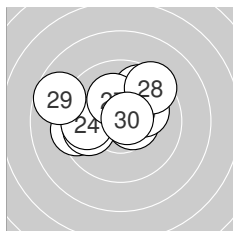

**Serie 3:**

10.5 *	9.4 ↖	9.8 ↖	9.8 ↖	9.7 ↗
10.1 ↗	10.2 *	9.4 ↗	8.7 ↖	10.7 *

**beste Teiler:** 61.8 (30.), 106.8 (21.), 196.0 (27.)  
**Trefferlage:** 0.75 mm links, 0.85 mm hoch  
**Streuwert:** 2.14, horizontal: 2.71, vertikal: 1.36

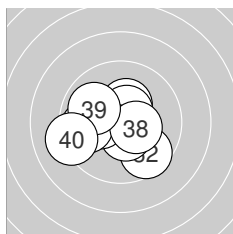

**Serie 4:**

10.3 *	9.6 ↘	10.4 *	10.5 *	10.5 *
10.3 *	9.8 ↖	10.4 *	9.9 ↖	9.2 ↖

**beste Teiler:** 104.8 (35.), 117.9 (34.), 131.7 (33.)  
**Trefferlage:** 0.75 mm links, 0.23 mm tief  
**Streuwert:** 1.70, horizontal: 2.04, vertikal: 1.26



Ergebnis: **376** (394.0)  
 Serien: 94 96 94 92  
 Zähler: 23 11 5 1 0 0 0 0 0 0  
 Innenzehner: 15  
 Weitester: 768 (35.), 695 (15.), 607 (23.)  
 beste Teiler: 51.7 (17.), 73.5 (39.), 113.4 (30.)  
 Trefferlage: 0.17 mm links, 0.01 mm hoch  
 Streuwert: 2.32, horizontal: 2.90, vertikal: 1.54

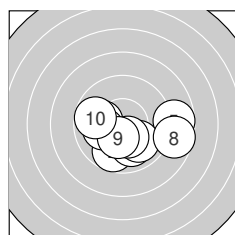
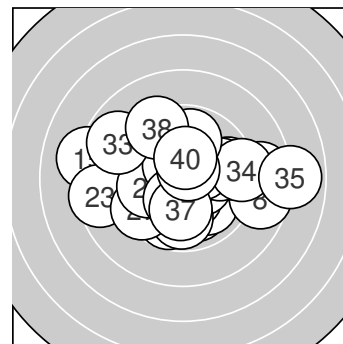

**Serie 1:**  
 10.1 ←                      9.7 ↓                      10.0 ↓  
 10.0 ↘                      10.4 \*                      8.7 →  
 beste Teiler: 149.3 (7.), 150.5 (9.), 213.4 (4.)  
 Trefferlage: 0.55 mm rechts, 1.03 mm tief  
 Streuwert: 2.29, horizontal: 3.01, vertikal: 1.20

10.1 ←                      8.7 →  
 10.4 \*                      9.7 ←

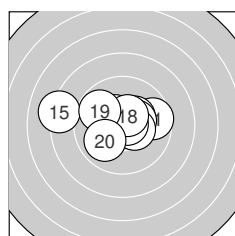

**Serie 2:**  
 9.6 →                      10.3 \*                      10.4 \*  
 10.4 \*                      10.7 \*                      10.5 \*  
 beste Teiler: 51.7 (17.), 115.8 (18.), 131.0 (14.)  
 Trefferlage: 0.37 mm links, 0.51 mm hoch  
 Streuwert: 2.10, horizontal: 2.82, vertikal: 0.96

10.4 \*                      8.2 ←  
 9.8 ↘                      10.0 ↙

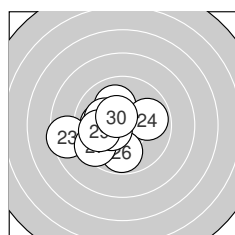

**Serie 3:**  
 10.0 ←                      10.1 ↖                      8.5 ←  
 9.8 ↓                      9.5 ↙                      10.4 \*  
 beste Teiler: 113.4 (30.), 130.1 (28.), 200.5 (25.)  
 Trefferlage: 1.56 mm links, 0.29 mm tief  
 Streuwert: 1.89, horizontal: 2.21, vertikal: 1.49

9.9 →                      10.2 \*  
 9.9 ←                      10.5 \*

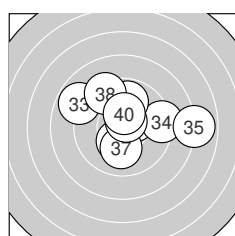

**Serie 4:**  
 10.4 \*                      10.3 \*                      8.8 ↘  
 9.9 ↑                      10.1 ↓                      9.3 ↖  
 beste Teiler: 73.5 (39.), 144.4 (31.), 145.9 (40.)  
 Trefferlage: 0.69 mm rechts, 0.85 mm hoch  
 Streuwert: 2.68, horizontal: 3.32, vertikal: 1.82

9.3 →                      7.9 →  
 10.7 \*                      10.4 \*



Ergebnis: **370** (386.7)  
 Serien: 93 92 93 92  
 Zähler: 15 20 5 0 0 0 0 0 0 0  
 Innenzehner: 8  
 Weitest: 695 (33.), 683 (21.), 641 (20.)  
 beste Teiler: 52.9 (6.), 115.2 (23.), 130.6 (14.)  
 Trefferlage: 0.31 mm rechts, 0.54 mm tief  
 Streuwert: 2.53, horizontal: 2.17, vertikal: 2.84

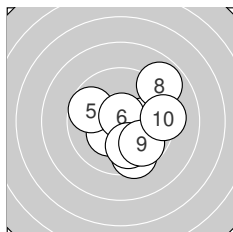
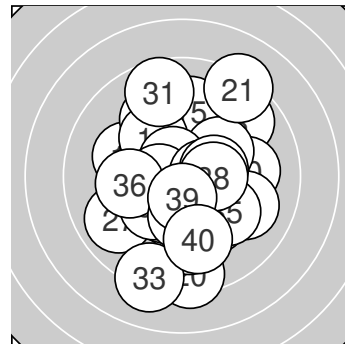

**Serie 1:**  
 10.3 \*                      10.1 →                      9.8 ↓                      9.5 ↓                      9.7 ↖  
 10.7 \*                      10.0 ↓                      8.9 ↗                      9.8 ↘                      9.3 →  
 beste Teiler: 52.9 (6.), 161.9 (1.), 218.0 (2.)  
 Trefferlage: 1.14 mm rechts, 0.60 mm tief  
 Streuwert: 2.12, horizontal: 2.13, vertikal: 2.11

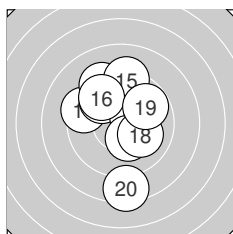

**Serie 2:**  
 9.4 ↖                      9.8 ↘                      9.3 ↘                      10.4 \*                      9.2 ↑  
 9.7 ↘                      10.3 \*                      10.1 ↘                      9.8 ↗                      8.4 ↓  
 beste Teiler: 130.6 (14.), 165.4 (17.), 222.5 (18.)  
 Trefferlage: 0.17 mm links, 0.72 mm hoch  
 Streuwert: 2.60, horizontal: 1.98, vertikal: 3.11

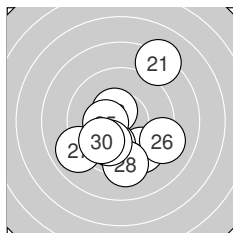

**Serie 3:**  
 8.2 ↗                      9.6 ↓                      10.5 \*                      10.0 ↓                      10.4 \*  
 9.1 ↘                      9.0 ↖                      9.3 ↓                      10.0 ↓                      9.9 ↖  
 beste Teiler: 115.2 (23.), 147.7 (25.), 240.2 (29.)  
 Trefferlage: 0.03 mm rechts, 1.14 mm tief  
 Streuwert: 2.70, horizontal: 2.57, vertikal: 2.81

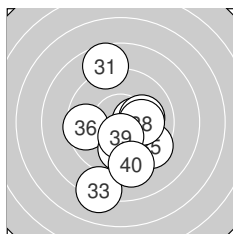

**Serie 4:**  
 8.7 ↑                      10.4 \*                      8.2 ↓                      10.1 →                      9.5 ↘  
 9.6 ←                      9.9 ↓                      10.1 →                      10.4 \*                      9.3 ↓  
 beste Teiler: 141.0 (39.), 142.6 (32.), 205.0 (38.)  
 Trefferlage: 0.25 mm rechts, 1.15 mm tief  
 Streuwert: 2.69, horizontal: 2.05, vertikal: 3.20



Ergebnis: **393** (406.7)  
 Serien: 97 98 99 99  
 Zähler: 33 7 0 0 0 0 0 0 0 0  
 Innenzehner: 25  
 Weitestе: 455 (18.), 406 (30.), 387 (3.)  
 beste Teiler: 11.3 (24.), 46.2 (27.), 59.9 (15.)  
 Trefferlage: 0.23 mm rechts, 0.02 mm tief  
 Streuwert: 1.57, horizontal: 1.73, vertikal: 1.39

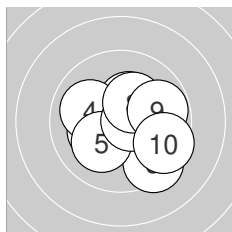
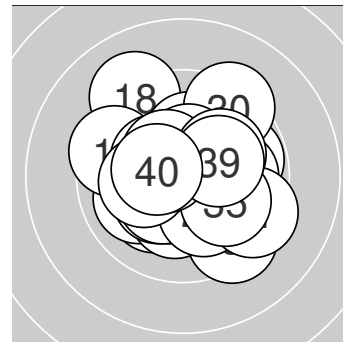

**Serie 1:**

10.3 *	10.2 *	9.4 ↘	10.0 ↖	10.1 ↗
10.0 →	10.6 *	10.3 *	9.8 →	9.5 ↘

beste Teiler: 78.0 (7.), 153.3 (1.), 165.8 (8.)  
 Trefferlage: 0.77 mm rechts, 0.23 mm tief  
 Streuwert: 1.74, horizontal: 1.98, vertikal: 1.47

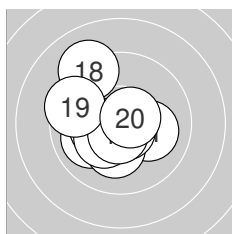

**Serie 2:**

10.1 ↘	10.0 ↖	10.2 *	10.3 *	10.7 *
10.3 *	10.6 *	9.1 ↘	9.5 ↖	10.6 *

beste Teiler: 59.9 (15.), 78.3 (17.), 83.3 (20.)  
 Trefferlage: 0.81 mm links, 0.06 mm tief  
 Streuwert: 1.63, horizontal: 1.63, vertikal: 1.62

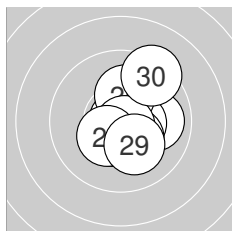

**Serie 3:**

10.0 →	10.5 *	10.5 *	10.9 *	10.2 *
10.3 *	10.8 *	10.4 *	10.2 *	9.3 ↗

beste Teiler: 11.3 (24.), 46.2 (27.), 115.9 (22.)  
 Trefferlage: 0.68 mm rechts, 0.02 mm tief  
 Streuwert: 1.37, horizontal: 1.13, vertikal: 1.56

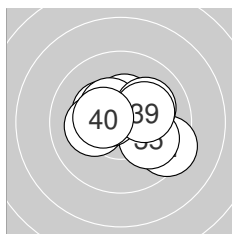

**Serie 4:**

9.4 ↘	10.3 *	10.2 *	10.4 *	10.0 ↘
10.6 *	10.4 *	10.1 ↗	10.2 *	10.4 *

beste Teiler: 97.4 (36.), 130.4 (37.), 133.1 (40.)  
 Trefferlage: 0.31 mm rechts, 0.24 mm hoch  
 Streuwert: 1.49, horizontal: 1.83, vertikal: 1.03

