

Ergebnis: **396** (411.3)  
 Serien: 99 98 100 99  
 Zähler: 36 4 0 0 0 0 0 0 0 0  
 Innenzehner: 28  
 weiteste: 355 (14), 306 (36), 293 (15)  
 beste Teiler 50.0 (21.) 59.2 (26.) 65.0 (23.)  
 Trefferlage 0.26 mm links, 0.09 mm tief  
 Streuwert 1.28, horizontal: 1.36, vertikal: 1.20

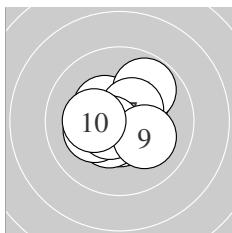

Serie 1:  
 10.6 \*                      10.1 ↗                      10.4 \*                      10.4 \*                      10.2 \*  
 9.8 ↗                      10.5 \*                      10.6 \*                      10.1 ↘                      10.2 \*  
 beste Teiler 81.5 (8.) 97.1 (1.) 118.8 (7.)  
 Trefferlage 0.02 mm links, 0.14 mm hoch  
 Streuwert 1.29, horizontal: 1.38, vertikal: 1.19

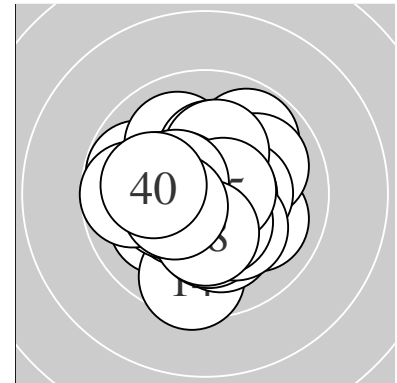
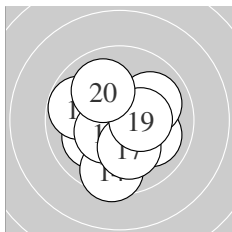

Serie 2:  
 10.0 ↘                      10.1 ↙                      10.5 \*                      9.5 ↓                      9.8 ↖  
 10.4 \*                      10.1 ↓                      10.0 ↗                      10.4 \*                      10.0 ↘  
 beste Teiler 107.7 (13.) 126.3 (16.) 148.0 (19.)  
 Trefferlage 0.01 mm rechts, 0.47 mm tief  
 Streuwert 1.67, horizontal: 1.72, vertikal: 1.62

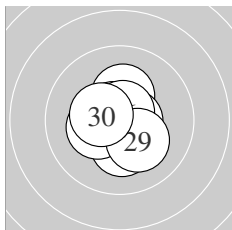

Serie 3:  
 10.8 \*                      10.3 \*                      10.7 \*                      10.5 \*                      10.6 \*  
 10.7 \*                      10.3 \*                      10.3 \*                      10.2 \*                      10.4 \*  
 beste Teiler 50.0 (21.) 59.2 (26.) 65.0 (23.)  
 Trefferlage 0.14 mm links, 0.06 mm tief  
 Streuwert 0.97, horizontal: 0.94, vertikal: 1.01

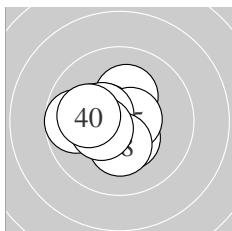

Serie 4:  
 10.2 \*                      10.2 \*                      10.5 \*                      10.4 \*                      10.6 \*  
 9.7 ←                      10.4 \*                      10.3 \*                      10.4 \*                      10.1 ←  
 beste Teiler 77.1 (35.) 114.5 (33.) 132.6 (37.)  
 Trefferlage 0.88 mm links, 0.01 mm hoch  
 Streuwert 1.14, horizontal: 1.31, vertikal: 0.95

Unterschrift des Schützen

Meyton Elektronik

Ergebnis: **398** (416.1)  
 Serien: 100 100 100 98  
 Zähler: 38 2 0 0 0 0 0 0 0 0  
 Innenzehner: 35  
 weiteste: 324 (37), 304 (34), 241 (4)  
 beste Teiler 13.0 (8.) 43.9 (28.) 50.4 (12.)  
 Trefferlage 0.14 mm rechts, 0.09 mm tief  
 Streuwert 1.08, horizontal: 1.15, vertikal: 1.00

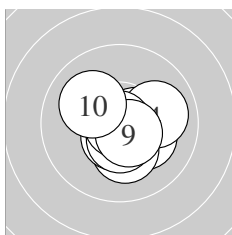
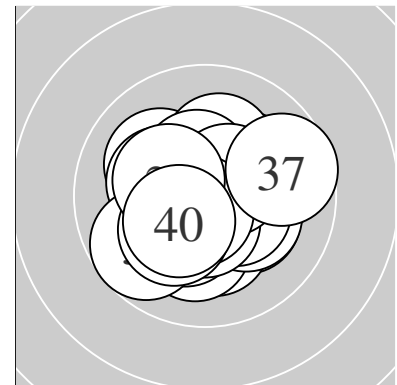

Serie 1:  
 10.5 \* 10.2 \* 10.2 \* 10.0 → 10.6 \*  
 10.6 \* 10.5 \* 10.9 \* 10.6 \* 10.1 ↖  
 beste Teiler 13.0 (8.) 76.0 (6.) 90.6 (9.)  
 Trefferlage 0.37 mm rechts, 0.41 mm tief  
 Streuwert 1.02, horizontal: 1.13, vertikal: 0.89

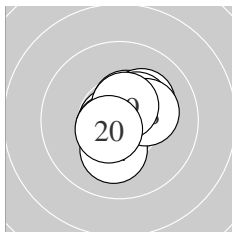

Serie 2:  
 10.5 \* 10.8 \* 10.7 \* 10.1 ↓ 10.2 \*  
 10.4 \* 10.6 \* 10.2 \* 10.5 \* 10.6 \*  
 beste Teiler 50.4 (12.) 70.6 (13.) 86.4 (17.)  
 Trefferlage 0.32 mm rechts, 0.21 mm hoch  
 Streuwert 0.95, horizontal: 0.90, vertikal: 1.01

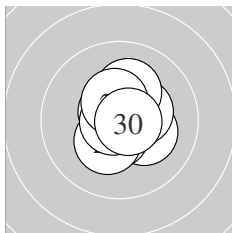

Serie 3:  
 10.2 \* 10.5 \* 10.5 \* 10.3 \* 10.6 \*  
 10.4 \* 10.2 \* 10.8 \* 10.5 \* 10.7 \*  
 beste Teiler 43.9 (28.) 59.0 (30.) 76.3 (25.)  
 Trefferlage 0.17 mm rechts, 0.20 mm hoch  
 Streuwert 0.95, horizontal: 0.82, vertikal: 1.05

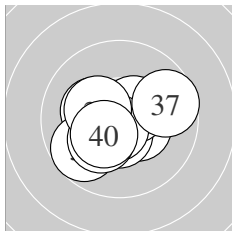

Serie 4:  
 10.4 \* 10.2 \* 10.5 \* 9.7 ↙ 10.5 \*  
 10.7 \* 9.7 → 10.2 \* 10.3 \* 10.4 \*  
 beste Teiler 65.7 (36.) 102.0 (33.) 112.8 (35.)  
 Trefferlage 0.29 mm links, 0.35 mm tief  
 Streuwert 1.36, horizontal: 1.64, vertikal: 1.01

Unterschrift des Schützen

Meyton Elektronik

Ergebnis:	<b>394</b>	(411.8)
Serien:	99 99 99 97	
Zähler:	34 6 0 0 0 0 0 0 0 0	
Innenzehner:	27	
weiteste:	341 (5), 307 (31), 289 (22)	
beste Teiler	52.8 (28.) 53.0 (21.) 66.5 (37.)	
Trefferlage	0.02 mm rechts, 0.10 mm tief	
Streuwert	1.29, horizontal: 1.48, vertikal: 1.06	

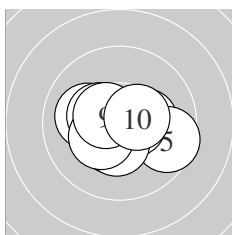
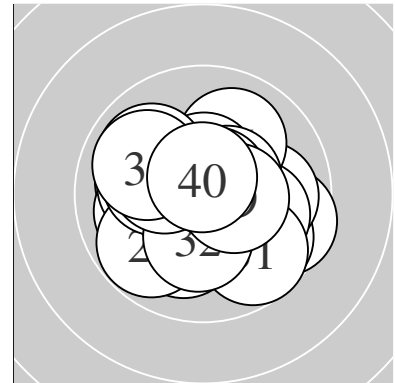

Serie 1:

10.4 *	10.1 ←	10.4 *	10.3 *	9.6 →
10.6 *	10.4 *	10.3 *	10.5 *	10.5 *
beste Teiler	93.0 (6.)	106.5 (9.)	124.5 (10.)	
Trefferlage	0.06 mm rechts, 0.25 mm tief			
Streuwert	1.30, horizontal: 1.66, vertikal: 0.79			

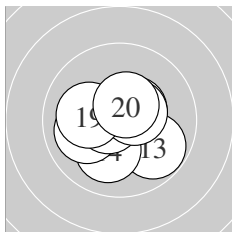

Serie 2:

10.3 *	10.4 *	9.8 ↘	10.1 ↓	10.0 ←
10.6 *	10.5 *	10.5 *	10.1 ←	10.5 *
beste Teiler	76.1 (16.)	112.9 (20.)	114.0 (18.)	
Trefferlage	0.07 mm rechts, 0.42 mm tief			
Streuwert	1.30, horizontal: 1.48, vertikal: 1.09			

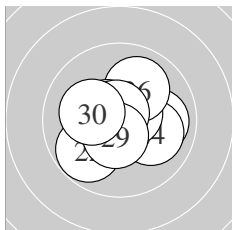

Serie 3:

10.7 *	9.8 ↙	10.0 →	10.0 →	10.6 *
10.0 ↗	10.6 *	10.7 *	10.5 *	10.2 *
beste Teiler	52.8 (28.)	53.0 (21.)	82.3 (25.)	
Trefferlage	0.10 mm rechts, 0.06 mm hoch			
Streuwert	1.34, horizontal: 1.54, vertikal: 1.12			

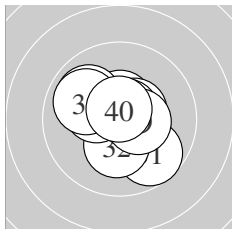

Serie 4:

9.7 ↘	10.2 *	10.5 *	10.3 *	9.9 ↘
10.5 *	10.7 *	9.9 ↘	10.4 *	10.7 *
beste Teiler	66.5 (37.)	68.1 (40.)	108.0 (33.)	
Trefferlage	0.14 mm links, 0.18 mm hoch			
Streuwert	1.35, horizontal: 1.45, vertikal: 1.25			

Unterschrift des Schützen

Meyton Elektronik

Ergebnis: **385** (405.3)  
 Serien: 93 98 98 96  
 Zähler: 28 10 1 1 0 0 0 0 0 0  
 Innenzehner: 21  
 weiteste: 525 (31), 452 (8), 288 (1)  
 beste Teiler 5.0 (35.) 48.0 (32.) 50.2 (11.)  
 Trefferlage 0.41 mm rechts, 0.43 mm hoch  
 Streuwert 1.50, horizontal: 1.73, vertikal: 1.22

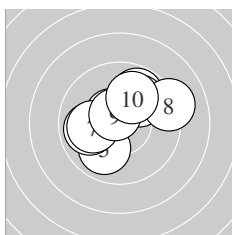
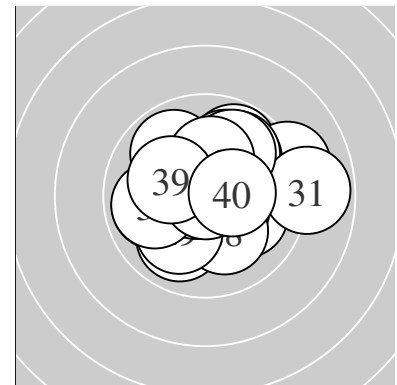

Serie 1:  
 7.8 ↗  
 9.9 ↖  
 9.9 ↖  
 9.9 ↖  
 10.0 ←  
 10.0 ←  
 10.0 ←  
 10.5 \*  
 9.1 →  
 10.6 \*  
 10.0 ←  
 9.9 ↘  
 10.0 ↗  
 beste Teiler 83.6 (9.) 102.5 (3.) 231.0 (7.)  
 Trefferlage 0.11 mm links, 0.60 mm hoch  
 Streuwert 1.88, horizontal: 2.20, vertikal: 1.49

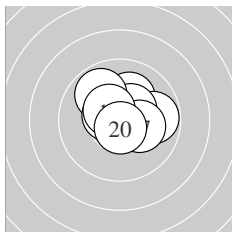

Serie 2:  
 10.8 \*  
 9.9 ↘  
 10.8 \*  
 10.2 \*  
 10.1 ↗  
 10.5 \*  
 9.8 →  
 10.5 \*  
 10.4 \*  
 10.7 \*  
 beste Teiler 50.2 (11.) 66.3 (20.) 107.5 (18.)  
 Trefferlage 0.41 mm rechts, 0.51 mm hoch  
 Streuwert 1.22, horizontal: 1.42, vertikal: 0.97

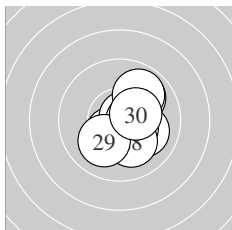

Serie 3:  
 10.4 \*  
 10.5 \*  
 10.4 \*  
 10.1 ↘  
 9.9 ↗  
 10.1 ↘  
 10.1 ↘  
 10.4 \*  
 10.1 ↘  
 10.4 \*  
 beste Teiler 54.5 (23.) 106.0 (26.) 126.9 (27.)  
 Trefferlage 0.83 mm rechts, 0.14 mm tief  
 Streuwert 1.24, horizontal: 1.08, vertikal: 1.39

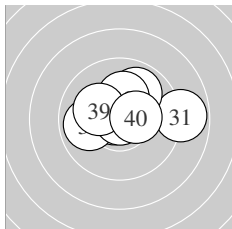

Serie 4:  
 8.9 →  
 9.9 ↗  
 10.8 \*  
 10.5 \*  
 9.9 ↖  
 10.2 \*  
 10.2 \*  
 10.2 \*  
 10.2 \*  
 10.9 \*  
 10.4 \*  
 beste Teiler 5.0 (35.) 48.0 (32.) 118.9 (37.)  
 Trefferlage 0.50 mm rechts, 0.76 mm hoch  
 Streuwert 1.62, horizontal: 2.11, vertikal: 0.90

DSB 0.11.4.1 – zu viele Schüsse im Wettkampf (-2)

Unterschrift des Schützen

Meyton Elektronik

Ergebnis:	<b>390</b>	(411.4)
Serien:	94 99 99 98	
Zähler:	32 6 2 0 0 0 0 0 0 0	
Innenzehner:	32	
weiteste:	581 (1), 535 (9), 442 (24)	
beste Teiler	38.8 (16.) 39.3 (27.) 42.0 (5.)	
Trefferlage	0.12 mm rechts, 0.32 mm hoch	
Streuwert	1.47, horizontal: 1.64, vertikal: 1.26	

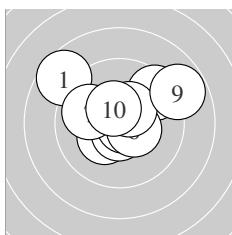
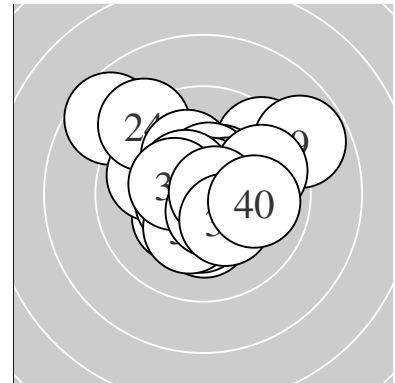

Serie 1:	8.6 ↘	10.3 *	9.4 ↗	10.6 *	10.8 *
	10.4 *	9.9 ↙	10.4 *	8.8 ↗	10.4 *
beste Teiler	42.0 (5.)	82.2 (4.)	127.2 (6.)		
Trefferlage	0.11 mm rechts, 0.92 mm hoch				
Streuwert	2.15, horizontal: 2.59, vertikal: 1.60				

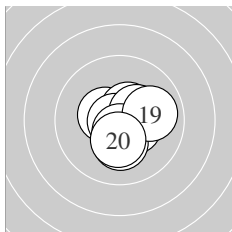

Serie 2:	10.7 *	10.4 *	10.2 *	10.5 *	10.5 *
	10.8 *	10.3 *	10.6 *	9.9 →	10.3 *
beste Teiler	38.8 (16.)	59.0 (11.)	92.0 (18.)		
Trefferlage	0.34 mm rechts, 0.25 mm tief				
Streuwert	1.01, horizontal: 1.07, vertikal: 0.94				

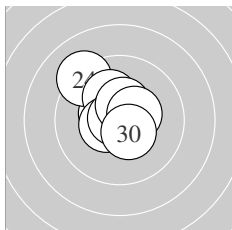

Serie 3:	10.5 *	10.7 *	10.6 *	9.2 ↘	10.2 *
	10.5 *	10.8 *	10.5 *	10.4 *	10.5 *
beste Teiler	39.3 (27.)	75.7 (22.)	93.9 (23.)		
Trefferlage	0.51 mm links, 0.73 mm hoch				
Streuwert	1.17, horizontal: 1.13, vertikal: 1.22				

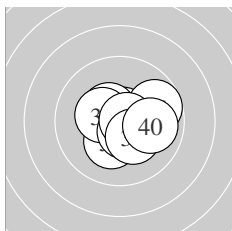

Serie 4:	10.7 *	10.2 *	10.7 *	10.5 *	10.4 *
	10.6 *	9.7 →	10.7 *	10.3 *	9.9 →
beste Teiler	56.3 (33.)	58.4 (38.)	66.4 (31.)		
Trefferlage	0.53 mm rechts, 0.09 mm tief				
Streuwert	1.16, horizontal: 1.36, vertikal: 0.91				

Unterschrift des Schützen

Ergebnis: **389** (408.6)  
 Serien: 97 98 98 96  
 Zähler: 29 11 0 0 0 0 0 0 0 0  
 Innenzehner: 25  
 weiteste: 460 (36), 422 (38), 418 (4)  
 beste Teiler 31.2 (1.) 32.3 (39.) 45.1 (17.)  
 Trefferlage 0.09 mm links, 0.07 mm tief  
 Streuwert 1.55, horizontal: 1.86, vertikal: 1.16

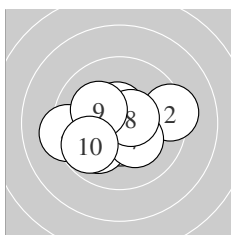
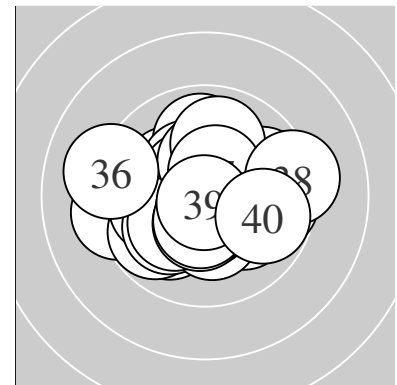

Serie 1:  
 10.8 \* 9.3 → 10.5 \* 9.3 ← 10.0 ↙  
 10.5 \* 10.3 \* 10.6 \* 10.2 \* 9.8 ↙  
 beste Teiler 31.2 (1.) 97.9 (8.) 102.7 (6.)  
 Trefferlage 0.40 mm links, 0.33 mm tief  
 Streuwert 1.76, horizontal: 2.23, vertikal: 1.12

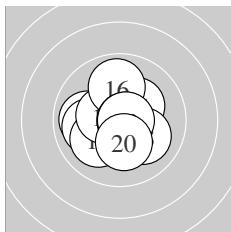

Serie 2:  
 9.9 ← 10.0 ← 10.1 ↙ 10.4 \* 10.3 \*  
 9.9 ↑ 10.8 \* 10.1 ↘ 10.8 \* 10.2 \*  
 beste Teiler 45.1 (17.) 50.0 (19.) 126.8 (14.)  
 Trefferlage 0.35 mm links, 0.08 mm tief  
 Streuwert 1.41, horizontal: 1.51, vertikal: 1.30

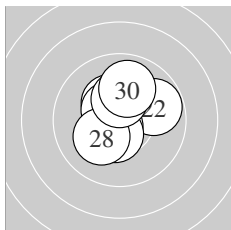

Serie 3:  
 10.3 \* 9.8 → 10.7 \* 10.7 \* 10.6 \*  
 10.5 \* 10.5 \* 10.2 \* 10.3 \* 9.9 ↑  
 beste Teiler 57.0 (23.) 64.8 (24.) 89.8 (25.)  
 Trefferlage 0.18 mm links, 0.40 mm hoch  
 Streuwert 1.20, horizontal: 1.14, vertikal: 1.25

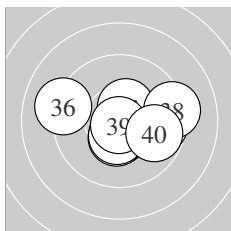

Serie 4:  
 10.5 \* 10.7 \* 9.7 → 10.4 \* 10.5 \*  
 9.1 ← 10.5 \* 9.3 → 10.8 \* 9.8 →  
 beste Teiler 32.3 (39.) 69.7 (32.) 112.1 (31.)  
 Trefferlage 0.55 mm rechts, 0.27 mm tief  
 Streuwert 1.83, horizontal: 2.40, vertikal: 0.97

Unterschrift des Schützen

Ergebnis: **382** (401.4)  
 Serien: 98 94 94 96  
 Zähler: 23 16 1 0 0 0 0 0 0 0  
 Innenzehner: 18  
 weiteste: 543 (17), 387 (22), 379 (23)  
 beste Teiler 12.7 (5.) 72.1 (31.) 76.8 (2.)  
 Trefferlage 0.04 mm links, 0.33 mm hoch  
 Streuwert 1.81, horizontal: 1.79, vertikal: 1.82

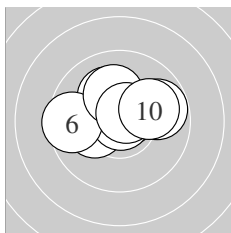
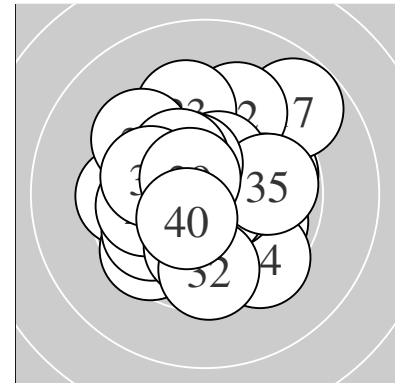

Serie 1:  
 10.4 \*                      10.6 \*                      10.1 ↗                      10.2 \*                      10.9 \*  
 9.5 ←                      10.2 \*                      10.6 \*                      9.8 →                      10.0 →  
 beste Teiler 12.7 (5.) 76.8 (2.) 78.2 (8.)  
 Trefferlage 0.15 mm links, 0.71 mm hoch  
 Streuwert 1.41, horizontal: 1.84, vertikal: 0.77

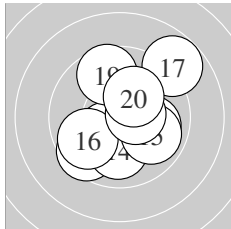

Serie 2:  
 10.0 →                      10.4 \*                      9.6 ↙                      10.0 ↓                      9.9 ↘  
 9.8 ↙                      8.8 ↗                      10.5 \*                      9.6 ↑                      10.2 \*  
 beste Teiler 121.0 (18.) 144.0 (12.) 184.1 (20.)  
 Trefferlage 0.40 mm rechts, 0.07 mm tief  
 Streuwert 2.16, horizontal: 2.11, vertikal: 2.21

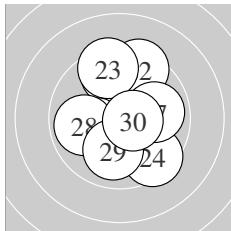

Serie 3:  
 9.6 ↑                      9.4 ↑                      9.4 ↑                      9.5 ↘                      10.4 \*  
 10.2 \*                      9.9 →                      9.9 ←                      10.0 ↓                      10.6 \*  
 beste Teiler 99.8 (30.) 146.5 (25.) 188.1 (26.)  
 Trefferlage 0.00 mm , 0.32 mm hoch  
 Streuwert 2.10, horizontal: 1.76, vertikal: 2.40

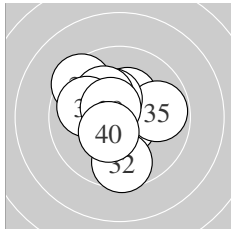

Serie 4:  
 10.7 \*                      9.6 ↓                      10.3 \*                      9.5 ↘                      9.8 →  
 10.4 \*                      10.2 \*                      9.9 ←                      10.6 \*                      10.4 \*  
 beste Teiler 72.1 (31.) 96.1 (39.) 136.6 (40.)  
 Trefferlage 0.44 mm links, 0.36 mm hoch  
 Streuwert 1.63, horizontal: 1.60, vertikal: 1.66

Unterschrift des Schützen

Ergebnis: **383** (400.1)  
 Serien: 96 94 95 98  
 Zähler: 24 15 1 0 0 0 0 0 0 0  
 Innenzehner: 15  
 weiteste: 550 (22), 432 (18), 415 (9)  
 beste Teiler 11.0 (24.) 92.5 (7.) 109.4 (11.)  
 Trefferlage 0.18 mm rechts, 0.03 mm hoch  
 Streuwert 1.85, horizontal: 1.92, vertikal: 1.77

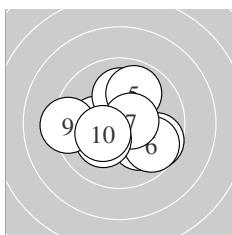
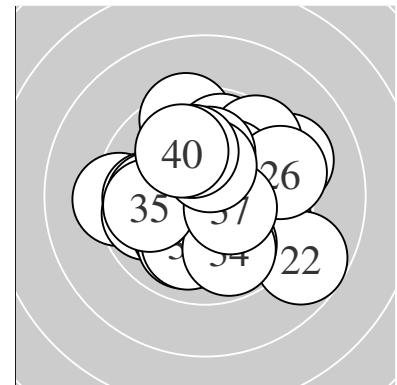

Serie 1:  
 10.2 \* 10.1 ↘ 9.7 ↘ 10.1 ↑ 9.9 ↗  
 9.7 ↘ 10.6 \* 10.2 \* 9.3 ← 10.3 \*  
 beste Teiler 92.5 (7.) 158.4 (10.) 185.1 (1.)  
 Trefferlage 0.04 mm rechts, 0.22 mm tief  
 Streuwert 1.88, horizontal: 2.21, vertikal: 1.48

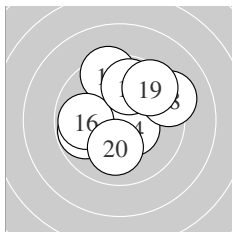

Serie 2:  
 10.5 \* 9.4 ↑ 10.2 \* 10.5 \* 9.8 ←  
 9.9 ← 9.8 ↑ 9.2 → 9.5 ↗ 10.1 ↓  
 beste Teiler 109.4 (11.) 118.4 (14.) 177.5 (13.)  
 Trefferlage 0.36 mm rechts, 0.86 mm hoch  
 Streuwert 1.98, horizontal: 2.11, vertikal: 1.85

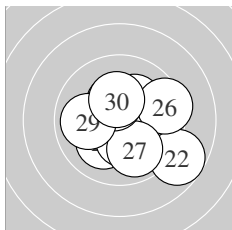

Serie 3:  
 10.2 \* 8.8 ↘ 10.1 ↙ 10.9 \* 10.3 \*  
 9.4 → 9.9 ↘ 10.4 \* 9.9 ← 10.3 \*  
 beste Teiler 11.0 (24.) 144.8 (28.) 155.7 (25.)  
 Trefferlage 0.63 mm rechts, 0.30 mm tief  
 Streuwert 1.95, horizontal: 2.15, vertikal: 1.72

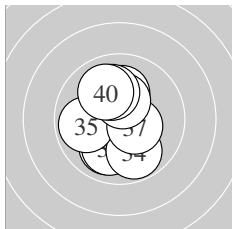

Serie 4:  
 10.2 \* 10.0 ↙ 10.0 ↙ 9.8 ↘ 9.9 ←  
 10.1 ↑ 10.4 \* 10.4 \* 10.1 ↑ 10.0 ↘  
 beste Teiler 134.6 (37.) 147.9 (38.) 187.5 (31.)  
 Trefferlage 0.32 mm links, 0.21 mm tief  
 Streuwert 1.64, horizontal: 1.18, vertikal: 2.00

Unterschrift des Schützen