

Ergebnis: **395.6** (378)
 Serien: 101.5 97.1 99.8 97.2
 Zähler: 19 20 1 0 0 0 0 0 0 0
 Innenzehner: 13
 Weitestе: 506 (38.), 452 (1.), 437 (39.)
 beste Teiler: 33.0 (9.), 63.2 (26.), 94.4 (7.)
 Trefferlage: 0.18 mm rechts, 0.21 mm hoch
 Streuwert: 2.09, horizontal: 2.24, vertikal: 1.93

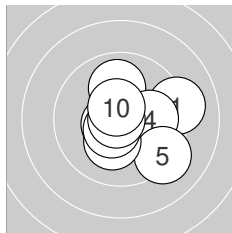
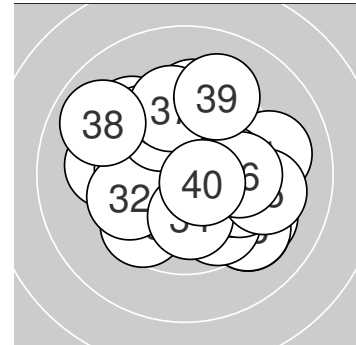

Serie 1: 101.5 (98)

9.1 →	10.5* ↙	10.0 ↑	10.0 →	9.2 ↘
10.2* ↓	10.6* ↙	10.5* ↙	10.8* ←	10.6* ↑

beste Teiler: 33.0 (9.), 94.4 (7.), 98.6 (10.)
 Trefferlage: 0.61 mm rechts, 0.20 mm tief
 Streuwert: 1.73, horizontal: 1.95, vertikal: 1.48

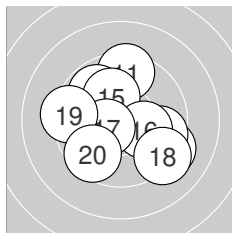

Serie 2: 97.1 (93)

9.4 ↑	9.8 ↘	9.2 ↘	9.7 →	10.2* ↑
10.2* →	10.5* ↙	9.2 ↘	9.3 ←	9.6 ↙

beste Teiler: 125.2 (17.), 196.8 (16.), 197.9 (15.)
 Trefferlage: 0.22 mm rechts, 0.19 mm tief
 Streuwert: 2.43, horizontal: 2.64, vertikal: 2.20

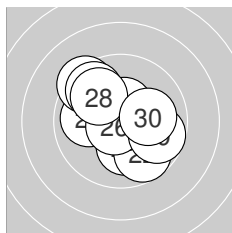

Serie 3: 99.8 (95)

10.1 ↓	9.7 ↘	10.0 ←	10.5* ↑	9.4 ↘
10.7* ↙	9.7 ↘	9.9 ↘	9.7 →	10.1 →

beste Teiler: 63.2 (26.), 122.2 (24.), 201.7 (21.)
 Trefferlage: 0.21 mm links, 0.30 mm hoch
 Streuwert: 1.93, horizontal: 2.02, vertikal: 1.83

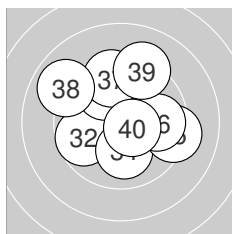

Serie 4: 97.2 (92)

10.2* ↑	9.7 ←	9.9 ↘	10.1 ↓	9.3 →
9.8 →	9.6 ↑	8.9 ↘	9.2 ↑	10.5* ↘

beste Teiler: 101.5 (40.), 186.5 (31.), 222.8 (34.)
 Trefferlage: 0.11 mm rechts, 0.95 mm hoch
 Streuwert: 2.36, horizontal: 2.53, vertikal: 2.17



Ergebnis: 398.2 (380)
Serien: 97.4 100.3 99.8 100.7
Zähler: 22 16 2 0 0 0 0 0 0 0
Innenzehner: 20
Weiteste: 643 (8.), 605 (24.), 437 (10.)
beste Teiler: 39.8 (25.), 40.7 (40.), 71.4 (17.)
Trefferlage: 0.02 mm rechts, 0.35 mm hoch
Streuwert: 2.04, horizontal: 2.56, vertikal: 1.34

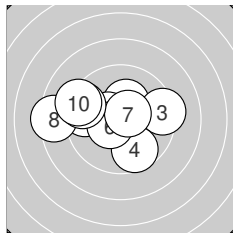
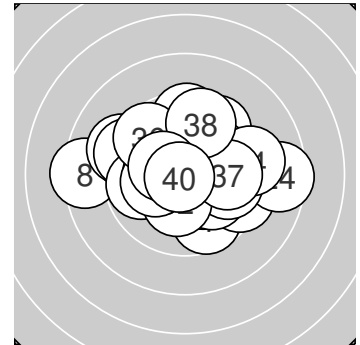

Serie 1: 97.4 (93)

10.3* ↗	10.4* ↖	9.3 →	9.7 ↘	9.6 ←
10.5* ↙	10.6* ↘	8.4 ←	9.4 ↖	9.2 ↙

beste Teiler: 88.4 (7.), 116.4 (6.), 127.7 (2.)
Trefferlage: 1.32 mm links, 0.33 mm hoch
Streuwert: 2.39, horizontal: 3.11, vertikal: 1.33

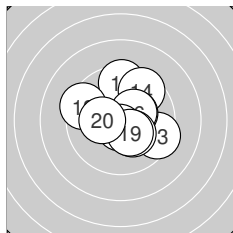

Serie 2: 100.3 (96)

9.5 ↑	9.4 ↖	9.4 ↘	9.6 ↗	10.4* ↘
10.4* ↗	10.7* ↓	10.3* ↘	10.4* ↘	10.2* ←

beste Teiler: 71.4 (17.), 145.2 (16.), 149.8 (15.)
Trefferlage: 0.48 mm rechts, 0.44 mm hoch
Streuwert: 1.88, horizontal: 2.00, vertikal: 1.75

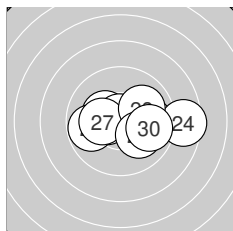

Serie 3: 99.8 (95)

9.9 →	10.4* ←	10.3* ↖	8.5 →	10.8* ↖
9.8 ←	10.2* ←	10.0 ↗	10.1 ↘	9.8 →

beste Teiler: 39.8 (25.), 130.0 (22.), 164.2 (23.)
Trefferlage: 0.78 mm rechts, 0.05 mm tief
Streuwert: 2.01, horizontal: 2.74, vertikal: 0.72

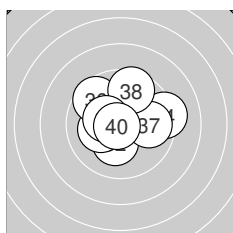

Serie 4: 100.7 (96)

10.3* ↖	10.2* ↓	10.5* ↗	9.2 →	10.2* ←
9.6 ↘	9.9 →	9.6 ↗	10.4* ↖	10.8* ↙

beste Teiler: 40.7 (40.), 107.4 (33.), 148.6 (39.)
Trefferlage: 0.14 mm rechts, 0.69 mm hoch
Streuwert: 1.78, horizontal: 2.06, vertikal: 1.45



Ergebnis: **409.9** (391)
Serien: 102.1 104.3 101.3 102.2
Zähler: 31 9 0 0 0 0 0 0 0 0
Innenzehner: 28
Weiteste: 433 (2.), 412 (30.), 387 (24.)
beste Teiler: 14.2 (32.), 50.1 (19.), 53.4 (10.)
Trefferlage: 0.03 mm rechts, 0.35 mm tief
Streuwert: 1.48, horizontal: 1.54, vertikal: 1.41

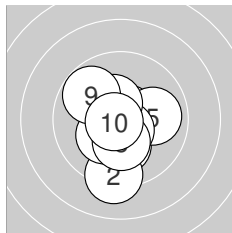
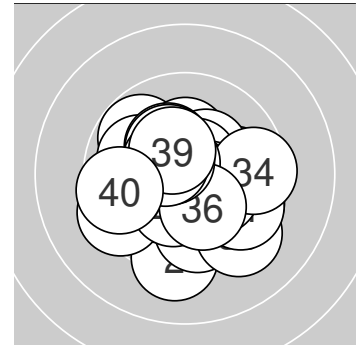

Serie 1: 102.1 (98)

10.1 ↓	9.2 ↓	10.3* ↗	10.7* ↗	10.0 →
10.6* ↓	10.4* ↖	10.3* ↓	9.8 ↘	10.7* ↖

beste Teiler: 53.4 (10.), 64.3 (4.), 91.3 (6.)
Trefferlage: 0.15 mm links, 0.65 mm tief
Streuwert: 1.54, horizontal: 1.24, vertikal: 1.79

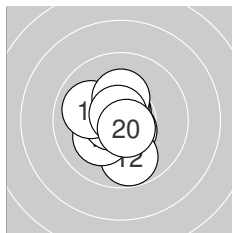

Serie 2: 104.3 (99)

10.6* ↓	9.8 ↓	10.2* ↗	10.7* ←	10.7* ↑
10.0 ↖	10.6* ↑	10.3* ↑	10.8* ↖	10.6* ↓

beste Teiler: 50.1 (19.), 61.3 (15.), 68.7 (14.)
Trefferlage: 0.28 mm links, 0.10 mm tief
Streuwert: 1.15, horizontal: 0.95, vertikal: 1.33

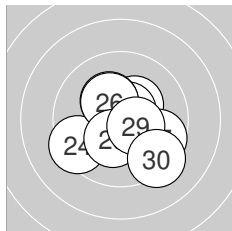

Serie 3: 101.3 (97)

10.3* ↗	10.7* ↓	10.6* ↗	9.4 ↖	10.3* ↖
10.3* ↖	9.7 ↘	10.3* ↓	10.4* ↘	9.3 ↓

beste Teiler: 71.0 (22.), 82.6 (23.), 129.3 (29.)
Trefferlage: 0.29 mm rechts, 0.46 mm tief
Streuwert: 1.71, horizontal: 1.86, vertikal: 1.55

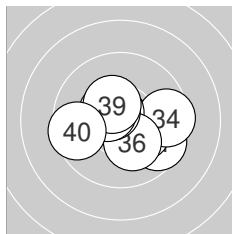

Serie 4: 102.2 (97)

9.6 ↘	10.9* ↘	10.2* ↘	9.5 →	10.7* ↖
10.2* ↓	10.6* ↖	10.5* ↖	10.4* ↖	9.6 ↖

beste Teiler: 14.2 (32.), 72.2 (35.), 99.0 (37.)
Trefferlage: 0.28 mm rechts, 0.19 mm tief
Streuwert: 1.61, horizontal: 2.03, vertikal: 1.02



Ergebnis: **388.1** (370)
 Serien: 96.7 97.7 97.2 96.5
 Zähler: 14 23 2 1 0 0 0 0 0 0
 Innenzehner: 12
 Weitestе: 909 (5.), 600 (32.), 576 (38.)
 beste Teiler: 54.8 (33.), 58.6 (7.), 87.7 (4.)
 Trefferlage: 0.37 mm links, 0.00 mm
 Streuwert: 2.52, horizontal: 2.94, vertikal: 2.01

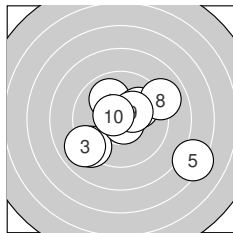
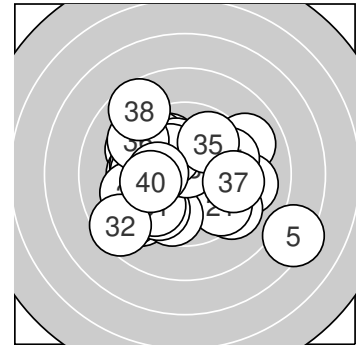

Serie 1: 96.7 (94)

10.0 ↘	9.2 ↙	9.0 ↙	10.6* ↗	7.3 ↘
10.0 ↗	10.7* ↘	9.0 ↗	10.3* ↗	10.6* ↘

beste Teiler: 58.6 (7.), 87.7 (4.), 89.5 (10.)
 Trefferlage: 0.75 mm rechts, 0.36 mm tief
 Streuwert: 2.97, horizontal: 3.49, vertikal: 2.33

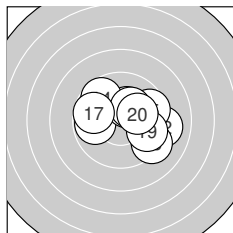

Serie 2: 97.7 (93)

9.8 ←	9.1 →	10.3* ↑	9.7 ↘	9.6 →
10.3* ↑	9.7 ←	9.3 ↘	9.7 →	10.2* →

beste Teiler: 157.4 (13.), 175.0 (16.), 197.2 (20.)
 Trefferlage: 0.98 mm rechts, 0.30 mm hoch
 Streuwert: 2.19, horizontal: 2.73, vertikal: 1.47

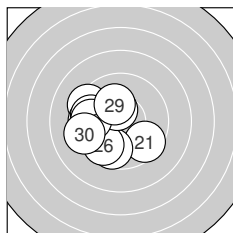

Serie 3: 97.2 (92)

9.6 ↘	9.4 ↘	9.6 ←	9.7 ↓	9.6 ←
9.7 ↙	10.4* ↑	9.7 ←	10.2* ↘	9.3 ←

beste Teiler: 128.7 (27.), 195.1 (29.), 314.0 (24.)
 Trefferlage: 1.86 mm links, 0.34 mm tief
 Streuwert: 1.95, horizontal: 2.07, vertikal: 1.82

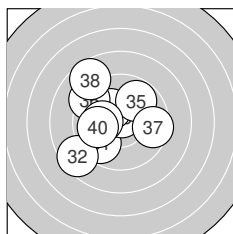

Serie 4: 96.5 (91)

9.7 ↙	8.6 ↙	10.7* ↑	10.2* ↘	9.8 ↗
9.3 ↘	9.5 →	8.6 ↘	10.2* ←	9.9 ←

beste Teiler: 54.8 (33.), 177.8 (34.), 199.1 (39.)
 Trefferlage: 1.38 mm links, 0.44 mm hoch
 Streuwert: 2.48, horizontal: 2.53, vertikal: 2.44



Ergebnis: **200.9** (192)
 Serien: 103.5 97.4
 Zähler: 13 6 1 0 0 0 0 0 0 0
 Innenzehner: 12
 Weitester: 517 (15.), 456 (16.), 428 (19.)
 beste Teiler: 61.0 (10.), 72.1 (3.), 80.6 (8.)
 Trefferlage: 0.02 mm rechts, 0.42 mm tief
 Streuwert: 1.89, horizontal: 1.97, vertikal: 1.79

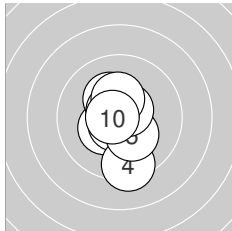
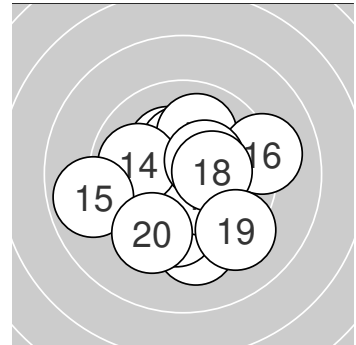

Serie 1: 103.5 (99)

10.5* ↖	10.3* ↙	10.7* ↘	9.3 ↓	10.2* ↘
10.6* ↗	10.3* ↖	10.6* ↖	10.3* ↑	10.7* ←

beste Teiler: 61.0 (10.), 72.1 (3.), 80.6 (8.)
 Trefferlage: 0.19 mm links, 0.16 mm tief
 Streuwert: 1.29, horizontal: 0.74, vertikal: 1.66

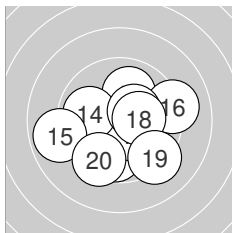

Serie 2: 97.4 (93)

9.8 ↓	10.0 ↑	10.3* ↘	9.9 ←	8.9 ←
9.1 →	10.4* ↗	10.3* →	9.2 ↘	9.5 ↘

beste Teiler: 143.4 (17.), 162.7 (18.), 166.1 (13.)
 Trefferlage: 0.25 mm rechts, 0.69 mm tief
 Streuwert: 2.39, horizontal: 2.75, vertikal: 1.96



Ergebnis: **389.2** (372)
 Serien: 97.8 98.7 97.1 95.6
 Zähler: 15 22 3 0 0 0 0 0 0 0
 Innenzehner: 8
 Weitest: 555 (27.), 527 (8.), 523 (37.)
 beste Teiler: 108.7 (3.), 112.2 (34.), 115.8 (7.)
 Trefferlage: 0.07 mm links, 0.47 mm tief
 Streuwert: 2.33, horizontal: 2.82, vertikal: 1.71

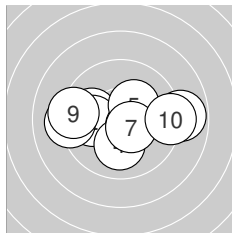
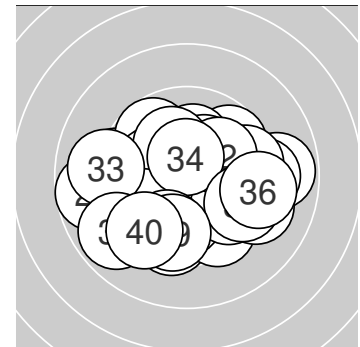

Serie 1: 97.8 (94)

9.9 ←	10.0 ←	10.5* ↘	10.1 ↓	10.3* ↗
9.2 ←	10.5* ↘	8.8 →	9.3 ←	9.2 →

beste Teiler: 108.7 (3.), 115.8 (7.), 169.0 (5.)
 Trefferlage: 0.09 mm links, 0.13 mm tief
 Streuwert: 2.44, horizontal: 3.32, vertikal: 0.93

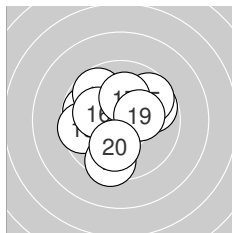

Serie 2: 98.7 (94)

9.8 →	9.8 ←	9.6 ←	9.7 ↖	9.7 ↗
10.1 ←	10.2* ↑	9.5 ↓	10.3* →	10.0 ↓

beste Teiler: 169.2 (19.), 200.8 (17.), 207.7 (16.)
 Trefferlage: 0.43 mm links, 0.28 mm hoch
 Streuwert: 2.05, horizontal: 2.17, vertikal: 1.92

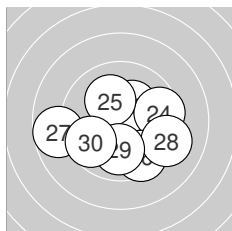

Serie 3: 97.1 (93)

10.5* ↑	9.5 ↘	10.3* ↗	9.6 →	10.1 ↖
9.5 ↘	8.7 ←	9.2 ↘	10.0 ↓	9.7 ↗

beste Teiler: 122.7 (21.), 168.0 (23.), 204.3 (25.)
 Trefferlage: 0.42 mm rechts, 0.62 mm tief
 Streuwert: 2.45, horizontal: 2.98, vertikal: 1.75

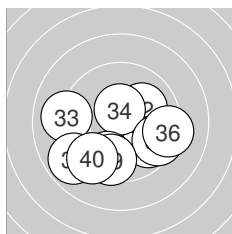

Serie 4: 95.6 (91)

9.8 ↘	10.1 ↗	9.0 ←	10.5* ↑	9.5 ↘
9.3 →	8.9 ↗	9.6 ↓	9.6 ↓	9.3 ↗

beste Teiler: 112.2 (34.), 221.3 (32.), 300.8 (31.)
 Trefferlage: 0.17 mm links, 1.41 mm tief
 Streuwert: 2.53, horizontal: 3.07, vertikal: 1.83



Ergebnis: 404.1 (384)
Serien: 101.7 99.5 101.1 101.8
Zähler: 26 12 2 0 0 0 0 0 0 0
Innenzehner: 21
Weiteste: 670 (11.), 533 (21.), 490 (3.)
beste Teiler: 29.1 (39.), 33.2 (30.), 47.2 (29.)
Trefferlage: 0.95 mm rechts, 0.02 mm tief
Streuwert: 1.70, horizontal: 1.96, vertikal: 1.38

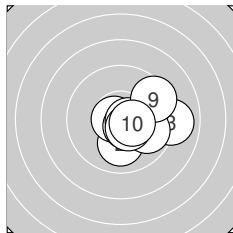
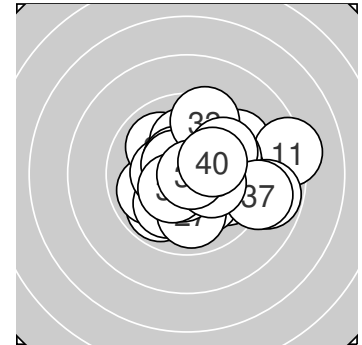

Serie 1: 101.7 (97)

10.5* ↘	10.0 ↓	9.0 →	10.7* ←	10.6* ↘
10.7* →	9.8 ↘	10.5* ↘	9.4 ↗	10.5* →

beste Teiler: 62.0 (4.), 75.5 (6.), 84.8 (5.)
Trefferlage: 1.40 mm rechts, 0.45 mm tief
Streuwert: 1.40, horizontal: 1.67, vertikal: 1.07

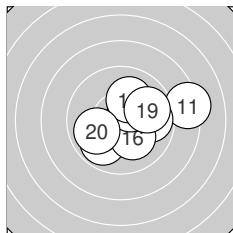

Serie 2: 99.5 (94)

8.3 →	10.4* ↗	9.9 ↘	9.8 →	10.7* ↘
10.2* ↘	10.4* ↗	10.1 ↑	9.8 →	9.9 ↘

beste Teiler: 64.8 (15.), 142.8 (12.), 146.7 (17.)
Trefferlage: 1.25 mm rechts, 0.08 mm hoch
Streuwert: 2.00, horizontal: 2.47, vertikal: 1.38

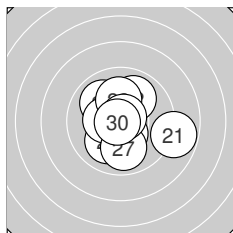

Serie 3: 101.1 (96)

8.8 →	9.9 ↗	10.4* ↓	10.0 ↘	10.0 ↘
10.4* ←	9.9 ↓	10.1 ↑	10.8* ↗	10.8* ←

beste Teiler: 33.2 (30.), 47.2 (29.), 129.0 (23.)
Trefferlage: 0.24 mm rechts, 0.05 mm tief
Streuwert: 1.83, horizontal: 1.97, vertikal: 1.69

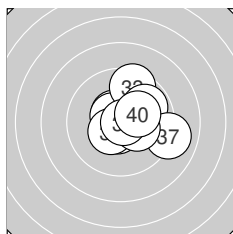

Serie 4: 101.8 (97)

10.5* ↘	10.6* ↘	9.5 ↑	9.9 ↗	10.6* ↓
10.4* ↘	9.0 →	10.3* →	10.8* →	10.2* →

beste Teiler: 29.1 (39.), 89.4 (35.), 96.5 (32.)
Trefferlage: 0.90 mm rechts, 0.34 mm hoch
Streuwert: 1.59, horizontal: 1.74, vertikal: 1.42



Ergebnis: 391.2 (373)
Serien: 99.2 100.2 96.7 95.1
Zähler: 17 19 4 0 0 0 0 0 0 0
Innenzehner: 12
Weiteste: 616 (37.), 524 (25.), 509 (34.)
beste Teiler: 43.8 (26.), 88.6 (14.), 100.6 (13.)
Trefferlage: 0.12 mm rechts, 0.63 mm hoch
Streuwert: 2.28, horizontal: 2.54, vertikal: 1.98

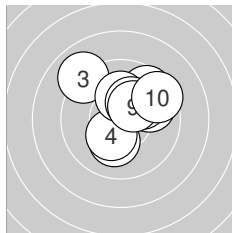
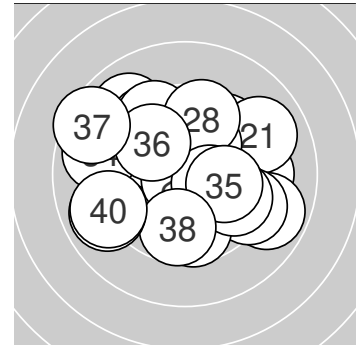

Serie 1: 99.2 (96)

9.8 ↗	10.2* ↓	9.0 ↘	10.3* ↙	9.6 ↗
10.2* ↑	10.0 ↗	10.3* ↗	10.3* ↗	9.5 ↗

beste Teiler: 158.3 (9.), 160.0 (4.), 173.2 (8.)
Trefferlage: 0.73 mm rechts, 1.18 mm hoch
Streuwert: 1.81, horizontal: 1.94, vertikal: 1.68

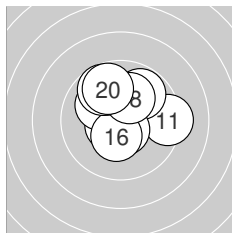

Serie 2: 100.2 (95)

9.3 →	9.8 ↗	10.6* ↖	10.6* ↓	10.1 ↘
10.4* ↓	9.8 ↘	10.1 ↗	9.7 ↘	9.8 ↗

beste Teiler: 88.6 (14.), 100.6 (13.), 141.9 (16.)
Trefferlage: 0.00 mm, 1.10 mm hoch
Streuwert: 1.72, horizontal: 1.83, vertikal: 1.61

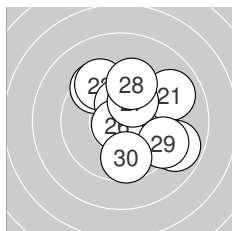

Serie 3: 96.7 (92)

9.0 ↗	9.5 ↘	9.5 ↘	10.3* ↑	8.9 ↘
10.8* ↖	10.1 ↗	9.6 ↑	9.3 ↘	9.7 ↓

beste Teiler: 43.8 (26.), 152.1 (24.), 203.4 (27.)
Trefferlage: 1.10 mm rechts, 0.74 mm hoch
Streuwert: 2.44, horizontal: 2.45, vertikal: 2.43

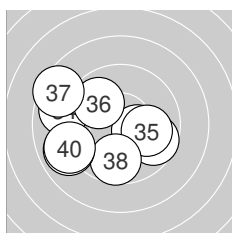

Serie 4: 95.1 (90)

10.2* ↘	9.7 ↘	10.3* ↘	8.9 ↖	10.0 →
9.9 ↘	8.5 ↖	9.7 ↓	8.9 ↖	9.0 ↖

beste Teiler: 155.0 (33.), 198.8 (31.), 237.2 (35.)
Trefferlage: 1.33 mm links, 0.47 mm tief
Streuwert: 2.72, horizontal: 3.33, vertikal: 1.92



LG 40 ZR

StandNr: 110

Preissler, Richard #70302101

Jungschützen

Wertung

StartNr: 10

12.02.2023 09:45

SG_Fieberbrunn

Ergebnis: **368.1** (350)
 Serien: 91.0 90.4 93.5 93.2
 Zähler: 9 17 10 3 1 0 0 0 0 0 0
 Innenzehner: 9
 Weitester: 1020 (18.), 913 (2.), 778 (3.)
 beste Teiler: 52.2 (21.), 72.1 (4.), 119.4 (34.)
 Trefferlage: 0.54 mm rechts, 0.15 mm hoch
 Streuwert: 3.54, horizontal: 4.59, vertikal: 1.99

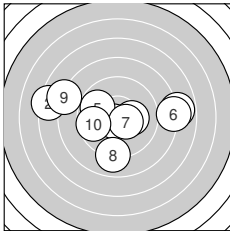
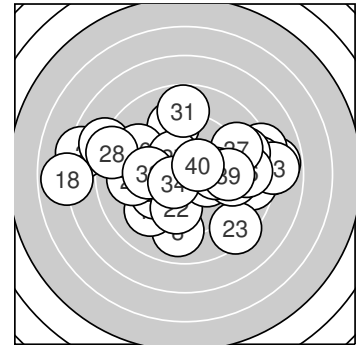

Serie 1: 91.0 (87)

10.2* → 7.3 ← 7.8 → 10.7* ↙ 9.8 ↖
 8.0 → 10.5* ↘ 9.0 ↓ 8.0 ↖ 9.7 ↖

beste Teiler: 72.1 (4.), 121.7 (7.), 184.2 (1.)
 Trefferlage: 0.48 mm links, 0.01 mm hoch
 Streuwert: 4.07, horizontal: 5.37, vertikal: 2.06

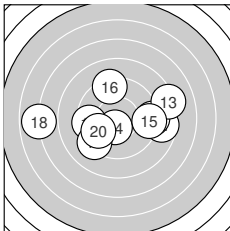

Serie 2: 90.4 (86)

8.6 → 9.1 → 8.2 → 10.5* ↓ 9.3 →
 9.3 ↑ 9.5 ← 6.9 ← 9.2 ↙ 9.8 ↙

beste Teiler: 123.0 (14.), 298.9 (20.), 373.2 (17.)
 Trefferlage: 0.01 mm rechts, 0.19 mm tief
 Streuwert: 3.97, horizontal: 5.24, vertikal: 2.00

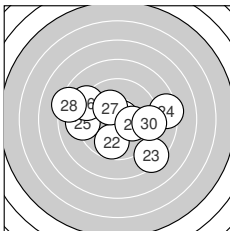

Serie 3: 93.5 (90)

10.7* → 9.8 ↓ 8.4 ↘ 8.4 → 9.1 ←
 9.1 ↖ 10.2* ↖ 8.3 ← 10.2* → 9.3 →

beste Teiler: 52.2 (21.), 178.9 (27.), 198.3 (29.)
 Trefferlage: 0.06 mm rechts, 0.24 mm tief
 Streuwert: 3.32, horizontal: 4.18, vertikal: 2.15

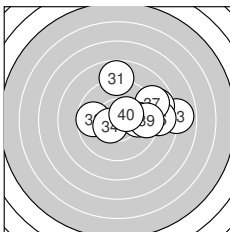

Serie 4: 93.2 (87)

8.8 ↑ 9.7 ← 7.9 → 10.5* ↙ 8.8 →
 8.8 → 9.0 ↗ 9.9 → 9.4 → 10.4* ↗

beste Teiler: 119.4 (34.), 136.4 (40.), 265.0 (38.)
 Trefferlage: 2.58 mm rechts, 1.04 mm hoch
 Streuwert: 2.67, horizontal: 3.32, vertikal: 1.78



Ergebnis: **395.4** (380)
Serien: 95.7 99.6 100.8 99.3
Zähler: 21 18 1 0 0 0 0 0 0 0
Innenzehner: 17
Weiteste: 721 (5.), 463 (10.), 459 (28.)
beste Teiler: 60.1 (13.), 77.2 (29.), 80.7 (35.)
Trefferlage: 0.28 mm rechts, 0.68 mm tief
Streuwert: 2.08, horizontal: 2.33, vertikal: 1.80

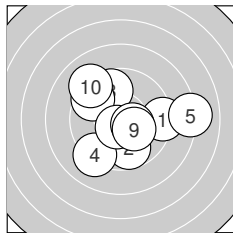
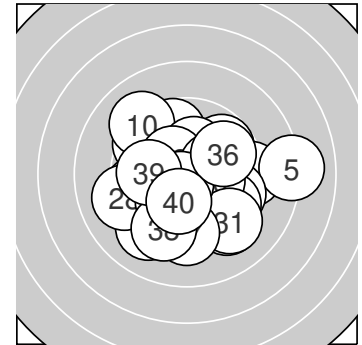

Serie 1: 95.7 (92)

9.2 → 9.7 ↓ 9.7 ↑
 9.5 ↖ 10.6* ↙ 10.4* →
beste Teiler: 89.0 (7.), 134.2 (8.), 171.8 (9.)
Trefferlage: 0.50 mm rechts, 0.00 mm
Streuwert: 2.86, horizontal: 3.31, vertikal: 2.33

9.1 ↙ 8.1 →
 10.3* → 9.1 ↖

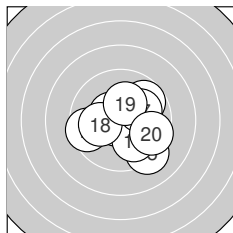

Serie 2: 99.6 (96)

9.7 ↗ 10.5* ↖ 10.7* ↙ 9.5 ← 9.2 ↘
 10.0 ↘ 10.1 ↗ 10.1 ← 10.2* ↑ 9.6 →
beste Teiler: 60.1 (13.), 120.1 (12.), 177.3 (19.)
Trefferlage: 0.51 mm rechts, 0.33 mm tief
Streuwert: 1.96, horizontal: 2.22, vertikal: 1.67

10.3* → 9.7 ↘
 10.6* ↓ 10.2* →

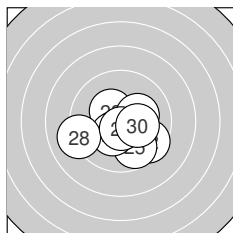

Serie 3: 100.8 (97)

10.5* → 9.5 ↘ 10.4* ↖ 10.3* → 9.7 ↘
 10.2* → 10.3* ↙ 9.1 ← 10.6* ↓ 10.2* →
beste Teiler: 77.2 (29.), 107.6 (21.), 144.3 (23.)
Trefferlage: 0.41 mm rechts, 0.84 mm tief
Streuwert: 1.65, horizontal: 2.05, vertikal: 1.13

10.6* ↙ 10.6* ↙
 9.9 ← 10.2* ↓

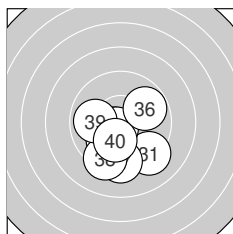

Serie 4: 99.3 (95)

9.2 ↘ 10.4* ← 10.0 ↙ 10.6* ↙ 10.6* ↙
 9.8 ↗ 9.3 ↓ 9.3 ↓ 9.9 ← 10.2* ↓
beste Teiler: 80.7 (35.), 95.4 (34.), 147.5 (32.)
Trefferlage: 0.30 mm links, 1.53 mm tief
Streuwert: 1.75, horizontal: 1.75, vertikal: 1.75

10.6* ↙ 10.6* ↙
 9.9 ← 10.2* ↓



Ergebnis: **370.1** (352)
 Serien: 94.5 92.8 93.5 89.3
 Zähler: 6 23 8 3 0 0 0 0 0 0
 Innenzehner: 6
 Weitester: 975 (26.), 881 (35.), 783 (1.)
 beste Teiler: 64.5 (7.), 77.0 (29.), 89.8 (28.)
 Trefferlage: 0.25 mm rechts, 2.06 mm tief
 Streuwert: 3.05, horizontal: 3.51, vertikal: 2.52

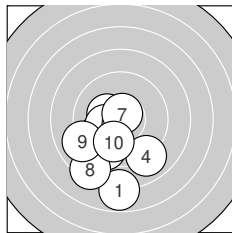
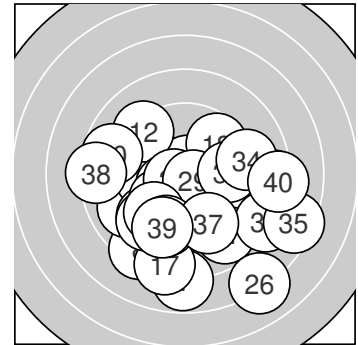

Serie 1: 94.5 (90)

7.8 ↓ 10.3* ↖ 9.8 ↙
 9.4 ↘ 10.7* ↑ 8.4 ↘

beste Teiler: 64.5 (7.), 160.1 (2.), 180.9 (5.)
 Trefferlage: 1.27 mm links, 2.68 mm tief
 Streuwert: 2.34, horizontal: 1.98, vertikal: 2.66

9.0 ↘ 10.2* ↖
 9.0 ↖ 9.9 ↓

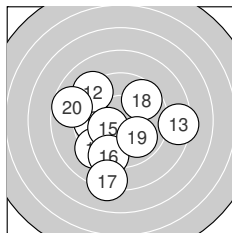

Serie 2: 92.8 (88)

9.8 ← 9.2 ↘ 8.4 → 9.3 ↖ 10.3* ↖
 9.3 ↓ 8.2 ↓ 9.7 ↗ 9.9 ↘ 8.7 ↖

beste Teiler: 161.8 (15.), 260.2 (19.), 295.8 (11.)
 Trefferlage: 0.78 mm links, 1.01 mm tief
 Streuwert: 3.21, horizontal: 3.41, vertikal: 2.99

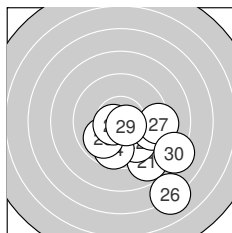

Serie 3: 93.5 (88)

8.8 ↘ 9.8 ↘ 9.5 → 9.7 ↓ 9.9 ↖
 7.1 ↘ 9.3 → 10.6* ↖ 10.6* ↘ 8.2 ↘

beste Teiler: 77.0 (29.), 89.8 (28.), 264.4 (25.)
 Trefferlage: 2.09 mm rechts, 2.52 mm tief
 Streuwert: 2.59, horizontal: 2.76, vertikal: 2.40

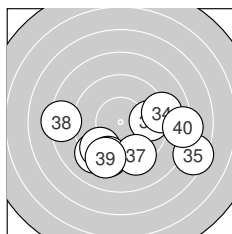

Serie 4: 89.3 (86)

9.7 → 9.2 ↖ 9.5 ↙ 9.1 → 7.4 ↘
 9.3 ↓ 9.4 ↘ 8.3 ← 9.2 ↓ 8.2 →

beste Teiler: 319.4 (31.), 362.6 (33.), 399.9 (37.)
 Trefferlage: 0.96 mm rechts, 2.04 mm tief
 Streuwert: 3.60, horizontal: 4.69, vertikal: 1.98



Ergebnis: **396.2** (379)
 Serien: 100.4 98.1 97.5 100.2
 Zähler: 21 17 2 0 0 0 0 0 0 0 0
 Innenzehner: 15
 Weitester: 744 (18.), 642 (29.), 477 (25.)
 beste Teiler: 42.5 (12.), 80.6 (39.), 86.1 (4.)
 Trefferlage: 0.20 mm links, 0.17 mm hoch
 Streuwert: 2.14, horizontal: 2.45, vertikal: 1.79

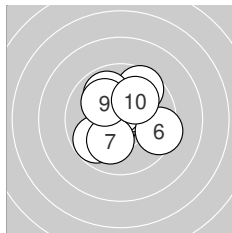
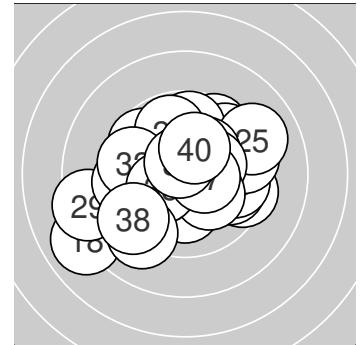

Serie 1: 100.4 (96)

10.5* ↙	10.4* ↗	9.8 ↙	10.6* ↑	9.6 ↗
9.4 →	10.1 ↙	9.9 ↘	10.1 ↘	10.0 ↗

beste Teiler: 86.1 (4.), 105.4 (1.), 143.6 (2.)
 Trefferlage: 0.07 mm rechts, 0.47 mm hoch
 Streuwert: 1.79, horizontal: 1.82, vertikal: 1.76

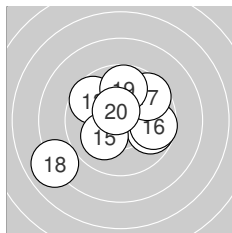

Serie 2: 98.1 (93)

10.0 ↗	10.8* ↑	9.7 ↘	9.8 →	10.1 ↙
9.7 →	9.6 ↗	8.0 ↙	9.8 ↑	10.6* ↘

beste Teiler: 42.5 (12.), 97.9 (20.), 213.5 (15.)
 Trefferlage: 0.09 mm links, 0.33 mm hoch
 Streuwert: 2.53, horizontal: 2.86, vertikal: 2.14

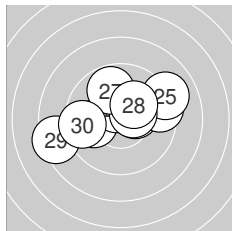

Serie 3: 97.5 (93)

10.4* →	9.9 ←	9.4 →	10.5* ↘	9.0 →
10.4* →	9.8 ↑	10.2* ↗	8.4 ←	9.5 ←

beste Teiler: 105.3 (24.), 128.6 (26.), 144.9 (21.)
 Trefferlage: 0.18 mm links, 0.63 mm hoch
 Streuwert: 2.48, horizontal: 3.24, vertikal: 1.37

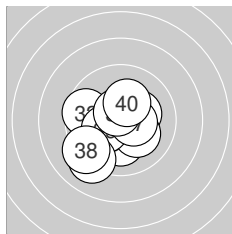

Serie 4: 100.2 (97)

10.1 ↓	9.6 ←	10.3* →	10.2* ↘	10.3* ↙
9.1 ↙	10.5* →	9.2 ↙	10.6* ↘	10.3* ↑

beste Teiler: 80.6 (39.), 124.6 (37.), 169.8 (35.)
 Trefferlage: 0.60 mm links, 0.72 mm tief
 Streuwert: 1.85, horizontal: 1.95, vertikal: 1.74



Ergebnis: 404.5 (387)
Serien: 102.3 101.6 99.3 101.3
Zähler: 27 13 0 0 0 0 0 0 0 0
Innenzehner: 21
Weiteste: 500 (24.), 444 (23.), 418 (19.)
beste Teiler: 11.0 (3.), 49.5 (16.), 52.6 (31.)
Trefferlage: 0.13 mm rechts, 0.17 mm hoch
Streuwert: 1.73, horizontal: 1.98, vertikal: 1.45

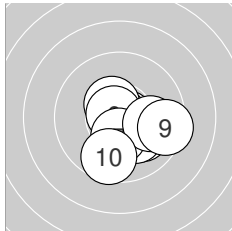
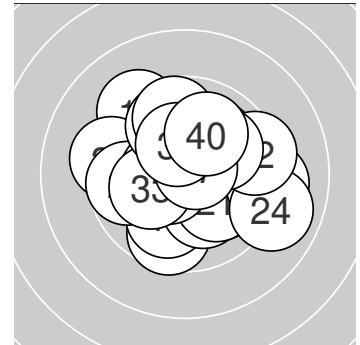

Serie 1: 102.3 (97)

10.7* →	10.1 ↘	10.9* →	10.5* ↖	10.2* ↘
10.7* ↖	10.3* ↓	9.9 →	9.4 →	9.6 ↓

beste Teiler: 11.0 (3.), 53.8 (6.), 54.5 (1.)
Trefferlage: 0.78 mm rechts, 0.75 mm tief
Streuwert: 1.35, horizontal: 1.49, vertikal: 1.19

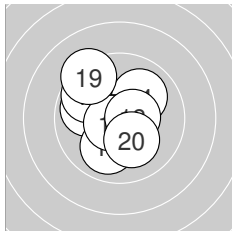

Serie 2: 101.6 (97)

9.9 ↖	10.6* ↖	9.7 ↖	10.0 ↗	10.0 ↓
10.8* ↗	10.6* ↗	10.5* →	9.3 ↖	10.2* ↘

beste Teiler: 49.5 (16.), 76.4 (12.), 77.1 (17.)
Trefferlage: 0.63 mm links, 0.36 mm hoch
Streuwert: 1.61, horizontal: 1.53, vertikal: 1.69

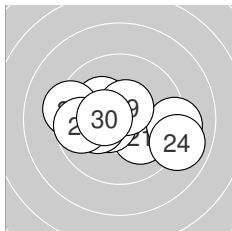

Serie 3: 99.3 (96)

10.1 ↘	10.2* ↖	9.2 →	9.0 →	10.6* ↖
10.2* ↖	9.3 ↖	9.7 ←	10.5* ↗	10.5* ←

beste Teiler: 98.3 (25.), 105.5 (29.), 122.5 (30.)
Trefferlage: 0.10 mm links, 0.21 mm tief
Streuwert: 2.18, horizontal: 2.91, vertikal: 1.00

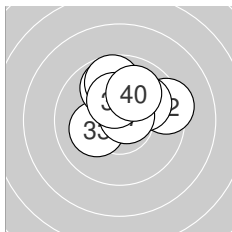

Serie 4: 101.3 (97)

10.7* ↗	9.4 →	10.2* ↖	9.9 ↖	10.4* ↗
10.0 ↗	10.7* ↗	9.7 ↑	10.3* ↑	10.0 ↗

beste Teiler: 52.6 (31.), 66.8 (37.), 138.4 (35.)
Trefferlage: 0.47 mm rechts, 1.30 mm hoch
Streuwert: 1.37, horizontal: 1.59, vertikal: 1.11



Ergebnis: 400.1 (381)
Serien: 99.5 99.6 101.0 100.0
Zähler: 22 17 1 0 0 0 0 0 0 0 0
Innenzehner: 16
Weiteste: 561 (1.), 433 (29.), 418 (25.)
beste Teiler: 21.0 (24.), 63.7 (9.), 69.2 (21.)
Trefferlage: 0.15 mm rechts, 0.03 mm tief
Streuwert: 1.90, horizontal: 2.03, vertikal: 1.75

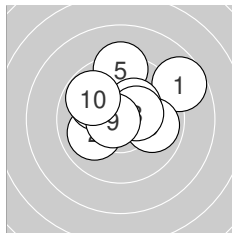
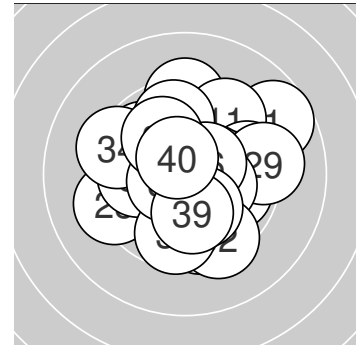

Serie 1: 99.5 (95)

8.7 ↗	10.0 ↖	10.0 ↘	10.4* ↗	9.3 ↑
9.9 →	10.3* ↗	10.4* →	10.7* ←	9.8 ↘

beste Teiler: 63.7 (9.), 133.7 (4.), 137.6 (8.)
Trefferlage: 0.39 mm rechts, 1.06 mm hoch
Streuwert: 1.95, horizontal: 2.27, vertikal: 1.57

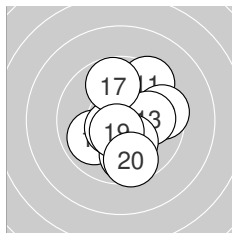

Serie 2: 99.6 (94)

9.5 ↗	9.6 →	10.0 →	9.9 ↖	9.8 ↓
10.6* ↖	9.8 ↑	10.2* ↓	10.6* ↓	9.6 ↓

beste Teiler: 95.6 (16.), 96.4 (19.), 195.0 (18.)
Trefferlage: 0.62 mm rechts, 0.40 mm tief
Streuwert: 1.92, horizontal: 1.67, vertikal: 2.14

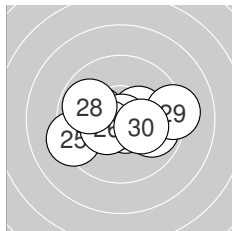

Serie 3: 101.0 (96)

10.7* ↓	10.3* →	10.2* ←	10.9* ↓	9.3 ↖
10.4* ↖	9.9 →	9.9 ↘	9.2 →	10.2* →

beste Teiler: 21.0 (24.), 69.2 (21.), 130.0 (26.)
Trefferlage: 0.11 mm rechts, 0.19 mm tief
Streuwert: 1.86, horizontal: 2.50, vertikal: 0.81

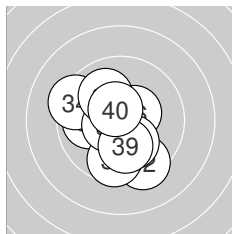

Serie 4: 100.0 (96)

9.9 ←	9.4 ↓	9.6 ↓	9.4 ↘	10.5* ↖
10.4* ↗	10.1 ↓	10.0 ↘	10.1 ↓	10.6* ↖

beste Teiler: 99.7 (40.), 102.6 (35.), 127.0 (36.)
Trefferlage: 0.51 mm links, 0.61 mm tief
Streuwert: 1.83, horizontal: 1.71, vertikal: 1.94



Ergebnis: **400.3** (384)
 Serien: 101.7 101.6 101.2 95.8
 Zähler: 28 9 2 1 0 0 0 0 0 0
 Innenzehner: 22
 Weitester: 756 (32.), 554 (10.), 517 (37.)
 beste Teiler: 2.0 (2.), 70.6 (1.), 73.4 (28.)
 Trefferlage: 0.42 mm rechts, 0.03 mm tief
 Streuwert: 1.99, horizontal: 2.40, vertikal: 1.48

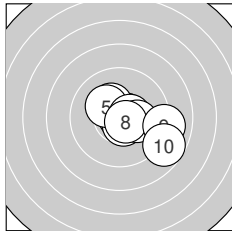
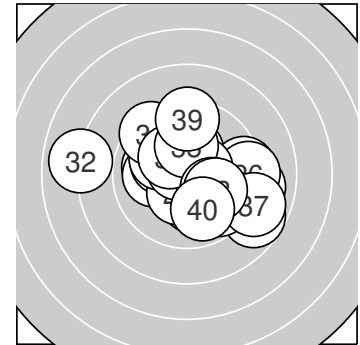

Serie 1: 101.7 (97)

10.7* ↗	10.9* ↓	10.3* ↖	10.6* ↓	10.2* ↖
10.5* →	10.2* →	10.6* ↘	9.0 →	8.7 ↘

beste Teiler: 2.0 (2.), 70.6 (1.), 80.8 (8.)
 Trefferlage: 1.17 mm rechts, 0.25 mm tief
 Streuwert: 1.70, horizontal: 2.08, vertikal: 1.21

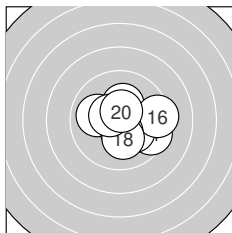

Serie 2: 101.6 (98)

9.5 ↘	10.6* ↓	10.0 ←	10.3* ↑	10.2* ↘
9.3 →	10.4* ↓	10.2* ↓	10.5* ↖	10.6* ↑

beste Teiler: 97.6 (20.), 100.1 (12.), 114.4 (19.)
 Trefferlage: 0.67 mm rechts, 0.27 mm tief
 Streuwert: 1.58, horizontal: 1.88, vertikal: 1.21

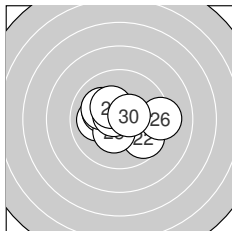

Serie 3: 101.2 (98)

10.1 ↖	9.7 ↘	10.0 ←	10.2* ↖	10.4* ↓
9.2 →	10.1 ↖	10.7* ↖	10.3* ↖	10.5* ↗

beste Teiler: 73.4 (28.), 107.3 (30.), 145.4 (25.)
 Trefferlage: 0.19 mm links, 0.18 mm hoch
 Streuwert: 1.70, horizontal: 2.17, vertikal: 1.06

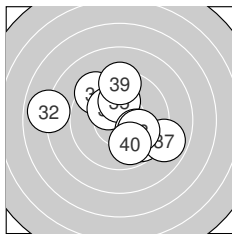

Serie 4: 95.8 (91)

9.4 ↖	7.9 ←	9.7 ↘	10.3* ↖	10.2* ↑
10.1 ↘	8.9 ↘	10.0 ↘	9.4 ↑	9.9 ↓

beste Teiler: 171.1 (34.), 200.0 (35.), 205.6 (36.)
 Trefferlage: 0.06 mm rechts, 0.19 mm hoch
 Streuwert: 2.86, horizontal: 3.33, vertikal: 2.29



Ergebnis: 400.2 (382)
Serien: 100.4 98.0 100.2 101.6
Zähler: 24 14 2 0 0 0 0 0 0 0
Innenzehner: 19
Weiteste: 590 (15.), 582 (11.), 467 (24.)
beste Teiler: 31.2 (36.), 31.3 (4.), 48.2 (19.)
Trefferlage: 0.95 mm links, 0.12 mm tief
Streuwert: 1.83, horizontal: 2.28, vertikal: 1.23

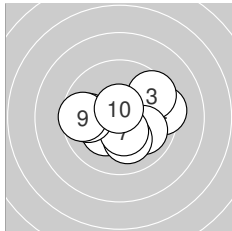
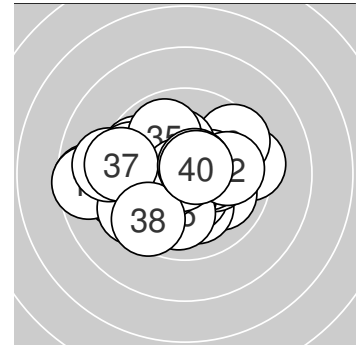

Serie 1: 100.4 (96)

10.2* ↙	9.4 →	9.5 ↗	10.8* ↖	10.0 ↘
10.1 ↓	10.4* ↓	9.8 ←	9.6 ←	10.6* ↑

beste Teiler: 31.3 (4.), 79.3 (10.), 134.1 (7.)
Trefferlage: 0.22 mm rechts, 0.21 mm tief
Streuwert: 1.87, horizontal: 2.35, vertikal: 1.21

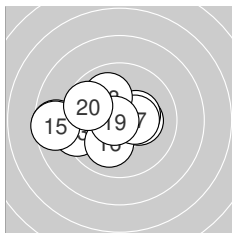

Serie 2: 98.0 (94)

8.6 ←	10.2* →	9.3 ←	10.3* →	8.6 ←
10.1 ↙	10.4* →	10.0 ↘	10.8* ←	9.7 ↖

beste Teiler: 48.2 (19.), 139.0 (17.), 156.2 (14.)
Trefferlage: 1.63 mm links, 0.01 mm tief
Streuwert: 2.19, horizontal: 2.88, vertikal: 1.16

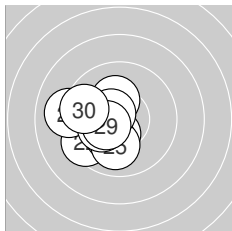

Serie 3: 100.2 (97)

10.4* ↓	9.5 ↙	10.2* ↙	9.1 ←	10.0 ↓
10.2* ↑	10.6* ↖	10.2* ←	10.4* ←	9.6 ←

beste Teiler: 92.9 (27.), 133.8 (29.), 139.4 (21.)
Trefferlage: 1.66 mm links, 0.48 mm tief
Streuwert: 1.44, horizontal: 1.49, vertikal: 1.38

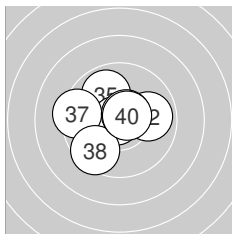

Serie 4: 101.6 (95)

9.7 ←	9.9 →	10.5* ←	10.7* ↗	9.9 ↘
10.8* ←	9.4 ←	9.5 ↙	10.6* ↗	10.6* ↗

beste Teiler: 31.2 (36.), 66.8 (34.), 78.5 (39.)
Trefferlage: 0.77 mm links, 0.22 mm hoch
Streuwert: 1.64, horizontal: 1.96, vertikal: 1.24



Ergebnis: 394.8 (379)
Serien: 101.7 97.7 94.2 101.2
Zähler: 24 11 5 0 0 0 0 0 0 0
Innenzehner: 15
Weiteste: 694 (25.), 585 (29.), 546 (27.)
beste Teiler: 26.4 (33.), 42.0 (9.), 47.2 (34.)
Trefferlage: 0.35 mm rechts, 0.34 mm hoch
Streuwert: 2.22, horizontal: 2.78, vertikal: 1.46

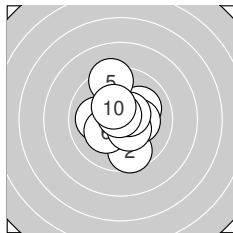
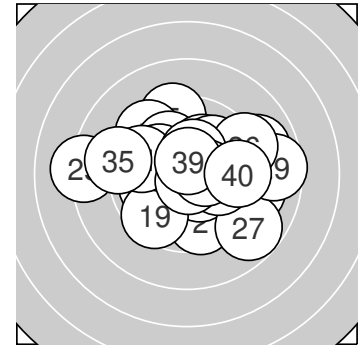

Serie 1: 101.7 (98)

10.1 ↗ 9.6 ↓ 10.0 ←
 10.2* ↖ 10.4* ↘ 10.6* ↗
beste Teiler: 42.0 (9.), 94.3 (8.), 128.8 (7.)
Trefferlage: 0.06 mm rechts, 0.16 mm hoch
Streuwert: 1.63, horizontal: 1.40, vertikal: 1.83

10.2* → 9.4 ↑
 10.8* ↑ 10.4* ↑

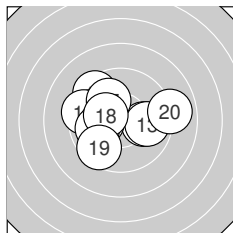

Serie 2: 97.7 (94)

9.4 ↘ 10.0 → 9.9 →
 10.0 ← 10.0 ↖ 10.3* ←
beste Teiler: 158.7 (18.), 189.9 (15.), 232.0 (17.)
Trefferlage: 0.54 mm links, 0.23 mm hoch
Streuwert: 2.28, horizontal: 2.83, vertikal: 1.54

9.4 ← 10.2* ←
 9.6 ↗ 8.9 →

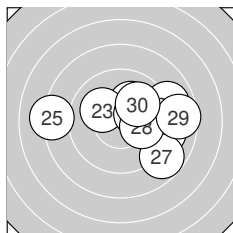

Serie 3: 94.2 (91)

10.1 ↗ 8.9 → 10.1 ↘ 9.1 → 8.2 ←
 10.3* ↗ 8.8 ↘ 10.1 → 8.6 → 10.0 ↗

beste Teiler: 170.4 (26.), 204.7 (21.), 216.2 (23.)
Trefferlage: 1.67 mm rechts, 0.26 mm hoch
Streuwert: 2.90, horizontal: 3.76, vertikal: 1.66

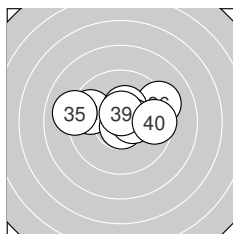

Serie 4: 101.2 (96)

9.7 ← 10.5* ↑ 10.8* → 10.8* ↓ 9.1 ←
 9.2 ↗ 10.4* ↑ 10.5* → 10.6* ↑ 9.6 →

beste Teiler: 26.4 (33.), 47.2 (34.), 88.3 (39.)
Trefferlage: 0.21 mm rechts, 0.69 mm hoch
Streuwert: 1.88, horizontal: 2.56, vertikal: 0.74



Ergebnis: **396.6** (379)
 Serien: 97.6 99.7 98.8 100.5
 Zähler: 23 13 4 0 0 0 0 0 0 0
 Innenzehner: 16
 Weitester: 690 (2.), 682 (25.), 545 (22.)
 beste Teiler: 54.4 (29.), 62.3 (5.), 73.1 (28.)
 Trefferlage: 0.18 mm rechts, 0.12 mm hoch
 Streuwert: 2.16, horizontal: 2.30, vertikal: 2.01

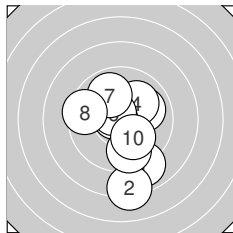
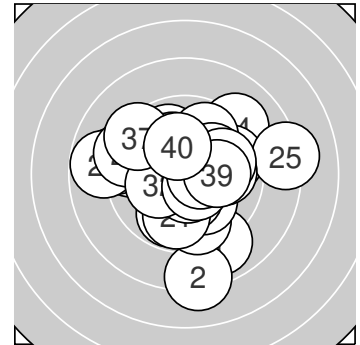

Serie 1: 97.6 (93)

8.9 ↓ 8.2 ↓ 10.0 →
 10.6* ↖ 9.9 ↗ 9.5 ←
 beste Teiler: 62.3 (5.), 89.9 (6.), 218.3 (10.)
 Trefferlage: 0.31 mm rechts, 0.97 mm tief
 Streuwert: 2.48, horizontal: 1.81, vertikal: 3.00

10.0 ↗ 10.7* ↖
 9.7 ↓ 10.1 ↓

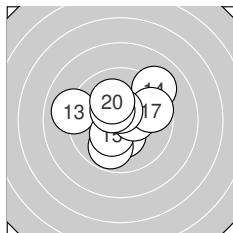

Serie 2: 99.7 (96)

10.3* ↓ 9.8 ↓ 9.0 ←
 10.4* → 9.7 → 10.6* ↑
 beste Teiler: 94.0 (18.), 128.5 (19.), 133.0 (16.)
 Trefferlage: 0.02 mm links, 0.35 mm hoch
 Streuwert: 2.03, horizontal: 2.30, vertikal: 1.73

9.1 ↗ 10.3* ↗
 10.4* ↖ 10.1 ↖

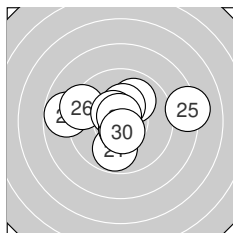

Serie 3: 98.8 (94)

9.8 ↓ 8.8 ← 10.0 ↗
 9.3 ← 10.5* ↖ 10.7* ↓
 beste Teiler: 54.4 (29.), 73.1 (28.), 102.5 (30.)
 Trefferlage: 0.22 mm links, 0.37 mm hoch
 Streuwert: 2.48, horizontal: 3.19, vertikal: 1.45

10.3* ↑ 8.2 →
 10.7* ↖ 10.5* ↓

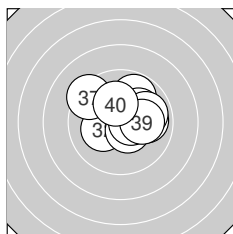

Serie 4: 100.5 (96)

9.8 ↗ 10.2* ← 10.1 ↗
 10.5* → 9.3 ↖ 9.9 →
 beste Teiler: 104.2 (36.), 109.9 (34.), 186.8 (32.)
 Trefferlage: 0.66 mm rechts, 0.74 mm hoch
 Streuwert: 1.60, horizontal: 1.90, vertikal: 1.24

10.5* ↓ 9.9 →
 10.1 → 10.2* ↗



Ergebnis: **385.3** (368)
 Serien: 93.8 95.6 98.5 97.4
 Zähler: 20 12 4 4 0 0 0 0 0 0
 Innenzehner: 17
 Weitester: 863 (18.), 848 (16.), 774 (21.)
 beste Teiler: 19.9 (33.), 55.1 (3.), 67.7 (13.)
 Trefferlage: 0.26 mm links, 0.64 mm tief
 Streuwert: 2.85, horizontal: 3.72, vertikal: 1.53

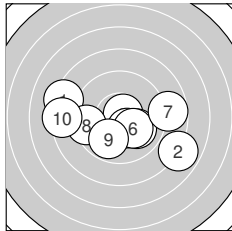
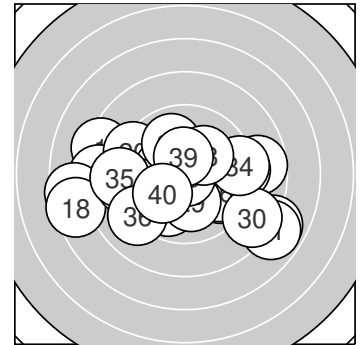

Serie 1: 93.8 (89)

8.3 ←	7.9 ↘	10.7* ↗	10.0 ↘	10.4* ↘
10.2* ↘	8.7 →	9.4 ←	9.9 ↙	8.3 ←

beste Teiler: 55.1 (3.), 148.9 (5.), 198.3 (6.)
 Trefferlage: 0.10 mm links, 0.79 mm tief
 Streuwert: 3.37, horizontal: 4.47, vertikal: 1.65

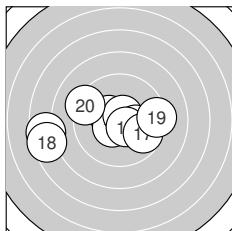

Serie 2: 95.6 (91)

10.4* ↘	10.5* ↙	10.7* ↗	10.2* →	10.5* ↘
7.6 ←	9.7 ↘	7.5 ←	9.3 →	9.2 ↖

beste Teiler: 67.7 (13.), 104.6 (15.), 115.2 (12.)
 Trefferlage: 1.28 mm links, 0.42 mm tief
 Streuwert: 3.18, horizontal: 4.32, vertikal: 1.24

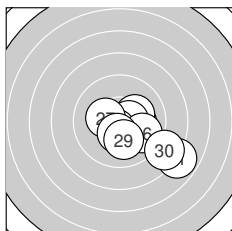

Serie 3: 98.5 (94)

7.9 ↘	10.2* →	10.2* →	10.5* →	10.6* ↙
9.8 ↘	10.3* ←	10.4* ↓	10.1 ↓	8.5 ↘

beste Teiler: 97.9 (25.), 105.3 (24.), 139.0 (28.)
 Trefferlage: 1.70 mm rechts, 1.21 mm tief
 Streuwert: 2.11, horizontal: 2.51, vertikal: 1.61

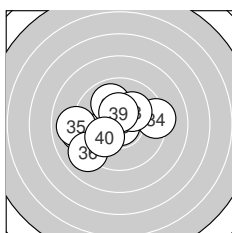

Serie 4: 97.4 (94)

9.1 ←	9.5 ←	10.9* ↓	9.3 →	9.0 ←
9.0 ↙	9.9 ↗	10.2* ↗	10.4* ↑	10.1 ↙

beste Teiler: 19.9 (33.), 131.5 (39.), 200.8 (38.)
 Trefferlage: 1.36 mm links, 0.12 mm tief
 Streuwert: 2.32, horizontal: 2.85, vertikal: 1.61



Ergebnis: **388.4** (367)
 Serien: 97.7 95.9 97.5 97.3
 Zähler: 13 22 4 1 0 0 0 0 0 0
 Innenzehner: 11
 Weitester: 816 (4.), 558 (11.), 532 (23.)
 beste Teiler: 47.2 (17.), 58.4 (24.), 96.4 (35.)
 Trefferlage: 0.63 mm links, 0.48 mm hoch
 Streuwert: 2.44, horizontal: 2.65, vertikal: 2.20

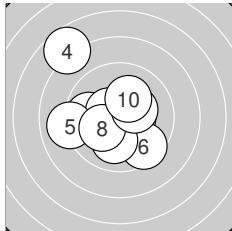
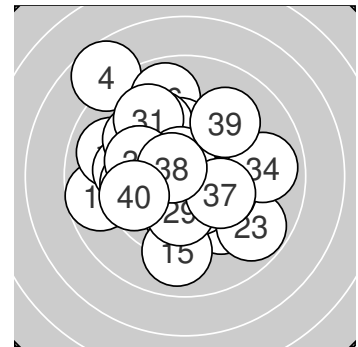

Serie 1: 97.7 (94)

9.8 ←	10.5* ↖	10.5* →	7.7 ↖	9.0 ←
9.5 ↘	10.0 ↓	10.2* ↙	10.3* →	10.2* ↑

beste Teiler: 119.0 (2.), 124.1 (3.), 160.9 (9.)
 Trefferlage: 1.01 mm links, 0.28 mm hoch
 Streuwert: 2.57, horizontal: 2.59, vertikal: 2.55

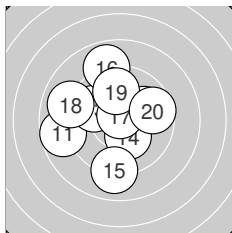

Serie 2: 95.9 (90)

8.7 ←	9.9 →	9.9 ↖	10.3* ↘	9.0 ↓
8.9 ↑	10.8* ↑	9.0 ↖	9.8 ↑	9.6 →

beste Teiler: 47.2 (17.), 174.8 (14.), 254.8 (12.)
 Trefferlage: 0.83 mm links, 0.52 mm hoch
 Streuwert: 2.71, horizontal: 2.77, vertikal: 2.65

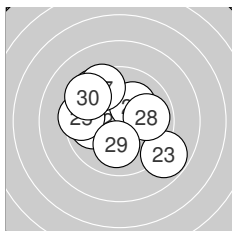

Serie 3: 97.5 (92)

9.5 ↖	9.9 ←	8.8 ↘	10.7* ←	9.5 ←
10.2* ↑	9.5 ↖	9.9 →	10.1 ↓	9.4 ↖

beste Teiler: 58.4 (24.), 198.3 (26.), 224.1 (29.)
 Trefferlage: 0.61 mm links, 0.50 mm hoch
 Streuwert: 2.36, horizontal: 2.60, vertikal: 2.09

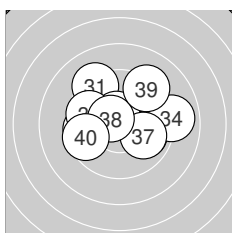

Serie 4: 97.3 (91)

9.2 ↖	9.7 ←	9.9 ↘	8.9 →	10.6* ↑
9.7 ↖	9.9 ↘	10.6* ↖	9.2 ↑	9.6 ↙

beste Teiler: 96.4 (35.), 99.3 (38.), 253.1 (37.)
 Trefferlage: 0.06 mm links, 0.62 mm hoch
 Streuwert: 2.42, horizontal: 2.94, vertikal: 1.76



Ergebnis: 378.9 (363)
Serien: 88.0 99.7 93.6 97.6
Zähler: 13 19 6 2 0 0 0 0 0 0 0
Innenzehner: 7
Weiteste: 890 (24.), 788 (4.), 737 (9.)
beste Teiler: 73.4 (39.), 75.8 (20.), 116.3 (32.)
Trefferlage: 1.18 mm rechts, 0.70 mm hoch
Streuwert: 2.83, horizontal: 3.20, vertikal: 2.41

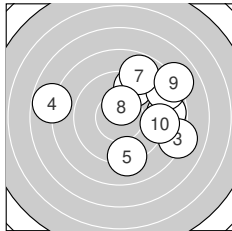
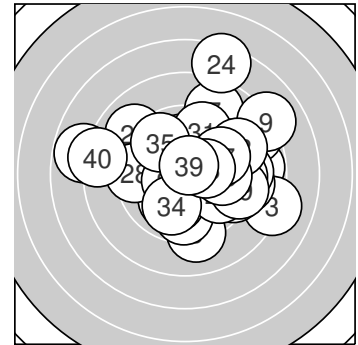

Serie 1: 88.0 (84)

8.8 →	9.4 ↗	8.1 ↘	7.8 ←	9.1 ↓
8.5 ↗	8.8 ↗	10.4* ↗	8.0 ↗	9.1 →

beste Teiler: 136.4 (8.), 376.3 (2.), 453.0 (5.)
Trefferlage: 2.51 mm rechts, 1.12 mm hoch
Streuwert: 3.67, horizontal: 4.27, vertikal: 2.96

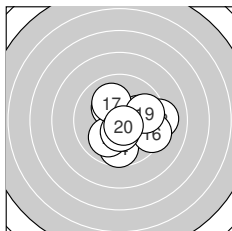

Serie 2: 99.7 (96)

10.3* ↖	10.1 →	9.2 →	9.7 ↓	10.0 ↗
9.4 →	10.1 ↖	10.4* ↓	9.8 →	10.7* ↘

beste Teiler: 75.8 (20.), 131.0 (18.), 173.9 (11.)
Trefferlage: 1.03 mm rechts, 0.35 mm tief
Streuwert: 1.87, horizontal: 2.10, vertikal: 1.61

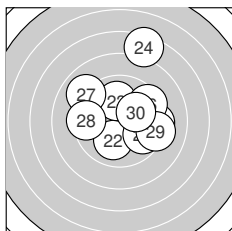

Serie 3: 93.6 (91)

9.3 →	10.0 ↓	10.0 ↑	7.4 ↗	9.7 ↘
9.5 ↗	9.0 ↖	9.4 ←	9.2 →	10.1 ↗

beste Teiler: 213.1 (30.), 228.0 (22.), 233.3 (23.)
Trefferlage: 0.99 mm rechts, 1.19 mm hoch
Streuwert: 3.05, horizontal: 3.02, vertikal: 3.08

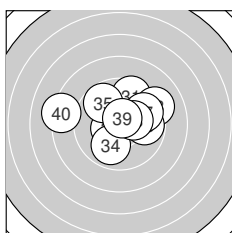

Serie 4: 97.6 (92)

9.6 ↗	10.5* ↖	9.2 →	9.9 ↓	9.7 ↖
9.8 →	9.7 ↗	10.3* →	10.7* ↗	8.2 ←

beste Teiler: 73.4 (39.), 116.3 (32.), 163.7 (38.)
Trefferlage: 0.21 mm rechts, 0.84 mm hoch
Streuwert: 2.46, horizontal: 3.09, vertikal: 1.61



Ergebnis: 396.0 (380)
Serien: 98.9 99.3 98.2 99.6
Zähler: 21 18 1 0 0 0 0 0 0 0
Innenzehner: 12
Weiteste: 540 (8.), 498 (26.), 494 (2.)
beste Teiler: 94.5 (39.), 102.3 (3.), 133.4 (9.)
Trefferlage: 0.05 mm links, 0.11 mm hoch
Streuwert: 2.04, horizontal: 2.45, vertikal: 1.53

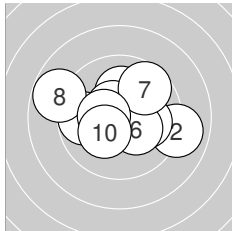
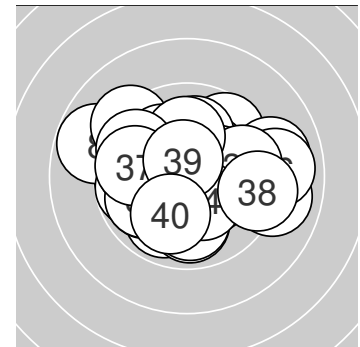

Serie 1: 98.9 (95)

10.1 ↑	9.0 →	10.5* ↘	9.8 ←	10.1 →
10.3* ↘	9.7 ↗	8.8 ↖	10.4* ←	10.2* ↘

beste Teiler: 102.3 (3.), 133.4 (9.), 168.6 (6.)
Trefferlage: 0.05 mm links, 0.35 mm hoch
Streuwert: 2.23, horizontal: 2.85, vertikal: 1.37

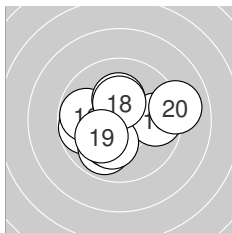

Serie 2: 99.3 (95)

9.8 ←	9.9 ↙	9.7 →	10.2* ↙	10.2* ↙
9.8 ←	10.2* ↑	10.4* ↑	10.1 ↗	9.0 →

beste Teiler: 148.0 (18.), 176.2 (17.), 195.8 (14.)
Trefferlage: 0.24 mm links, 0.31 mm tief
Streuwert: 2.01, horizontal: 2.42, vertikal: 1.49

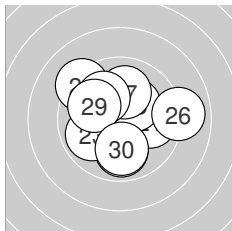

Serie 3: 98.2 (95)

9.9 →	9.9 ↓	9.9 ↙	9.2 ↘	10.3* ↗
9.0 →	10.0 ↑	10.0 ↘	10.0 ↖	10.0 ↓

beste Teiler: 172.5 (25.), 226.4 (28.), 231.0 (27.)
Trefferlage: 0.05 mm rechts, 0.31 mm hoch
Streuwert: 2.22, horizontal: 2.47, vertikal: 1.93

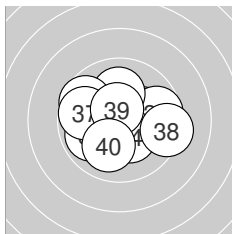

Serie 4: 99.6 (95)

9.9 ↙	10.2* →	9.7 →	10.3* ↘	10.1 ↑
9.7 ↖	9.8 ←	9.3 →	10.6* ↑	10.0 ↙

beste Teiler: 94.5 (39.), 162.2 (34.), 180.0 (32.)
Trefferlage: 0.02 mm rechts, 0.09 mm hoch
Streuwert: 1.98, horizontal: 2.42, vertikal: 1.41



Ergebnis: 412.4 (396)
Serien: 104.0 103.1 102.3 103.0
Zähler: 36 4 0 0 0 0 0 0 0 0 0
Innenzehner: 23
Weiteste: 378 (15.), 325 (36.), 281 (33.)
beste Teiler: 25.2 (12.), 35.1 (39.), 48.3 (37.)
Trefferlage: 0.74 mm rechts, 0.05 mm hoch
Streuwert: 1.20, horizontal: 1.13, vertikal: 1.26

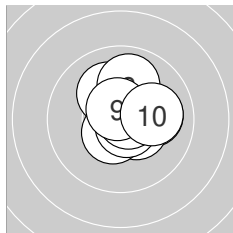
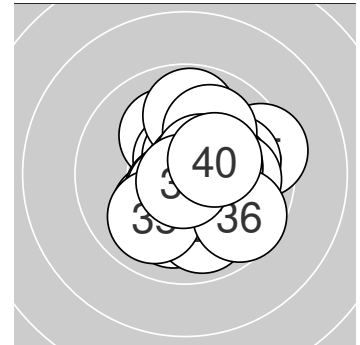

Serie 1: 104.0 (100)

10.1 →	10.4* ↘	10.5* ↙	10.7* →	10.7* ↘
10.7* →	10.1 ↖	10.0 ↑	10.7* ↖	10.1 →

beste Teiler: 57.0 (6.), 61.1 (4.), 64.5 (5.)
Trefferlage: 0.60 mm rechts, 0.35 mm hoch
Streuwert: 1.06, horizontal: 1.05, vertikal: 1.07

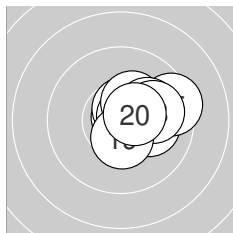

Serie 2: 103.1 (99)

10.1 →	10.9* ↗	10.6* ↑	10.7* ↗	9.4 →
10.3* ↗	10.1 →	10.0 →	10.5* ↓	10.5* ↗

beste Teiler: 25.2 (12.), 59.5 (14.), 85.3 (13.)
Trefferlage: 1.26 mm rechts, 0.39 mm hoch
Streuwert: 0.98, horizontal: 1.17, vertikal: 0.75

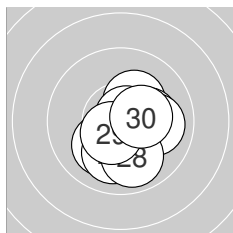

Serie 3: 102.3 (99)

10.3* ↗	10.8* ↗	10.2* →	10.1 ↙	10.1 ↓
10.0 ↓	10.0 →	9.9 ↓	10.5* ↙	10.4* →

beste Teiler: 48.8 (22.), 106.4 (29.), 150.4 (30.)
Trefferlage: 0.53 mm rechts, 0.75 mm tief
Streuwert: 1.26, horizontal: 1.18, vertikal: 1.34

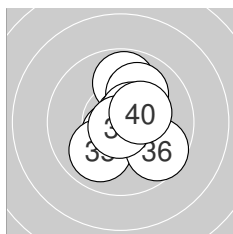

Serie 4: 103.0 (98)

10.4* ↗	10.6* ↙	9.8 ↑	10.0 ↗	10.0 ↙
9.7 ↘	10.8* ↗	10.6* ↗	10.8* ↓	10.3* ↗

beste Teiler: 35.1 (39.), 48.3 (37.), 99.6 (38.)
Trefferlage: 0.57 mm rechts, 0.21 mm hoch
Streuwert: 1.36, horizontal: 1.13, vertikal: 1.56



Ergebnis: 413.8 (395)
Serien: 103.0 104.0 102.4 104.4
Zähler: 35 5 0 0 0 0 0 0 0 0 0
Innenzehner: 30
Weiteste: 368 (3.), 349 (29.), 301 (15.)
beste Teiler: 27.2 (40.), 45.6 (10.), 51.4 (17.)
Trefferlage: 0.21 mm links, 0.28 mm hoch
Streuwert: 1.20, horizontal: 1.47, vertikal: 0.86

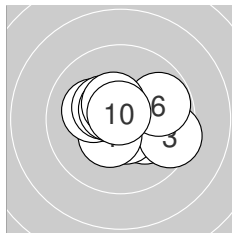
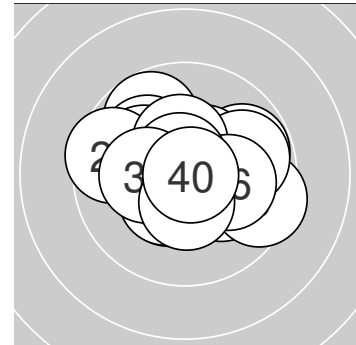

Serie 1: 103.0 (98)

10.2* ↘	10.6* ↓	9.5 →	10.4* ↙	10.2* ←
9.8 →	10.4* ↖	10.6* ↖	10.5* ↖	10.8* ↑

beste Teiler: 45.6 (10.), 98.2 (2.), 100.4 (8.)
Trefferlage: 0.30 mm rechts, 0.05 mm hoch
Streuwert: 1.42, horizontal: 1.76, vertikal: 0.96

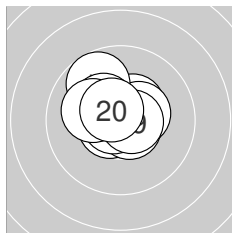

Serie 2: 104.0 (99)

10.6* ↙	10.4* ↗	10.4* →	10.6* ↘	9.7 ↖
10.3* ↖	10.7* ←	10.1 ↖	10.6* →	10.6* ↖

beste Teiler: 51.4 (17.), 77.6 (19.), 80.2 (14.)
Trefferlage: 0.30 mm links, 0.53 mm hoch
Streuwert: 1.02, horizontal: 1.12, vertikal: 0.92

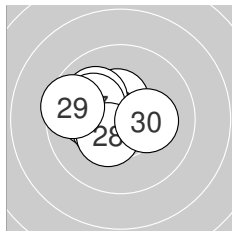

Serie 3: 102.4 (99)

10.7* ↗	10.5* ←	10.4* ↑	10.1 ←	10.4* ↙
10.0 ↖	10.1 ↖	10.4* ↙	9.6 ←	10.2* →

beste Teiler: 53.0 (21.), 124.0 (22.), 132.1 (23.)
Trefferlage: 1.05 mm links, 0.36 mm hoch
Streuwert: 1.17, horizontal: 1.44, vertikal: 0.81

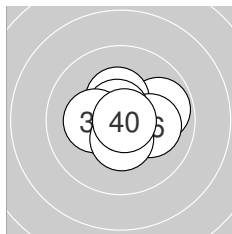

Serie 4: 104.4 (99)

10.7* ↑	10.6* ↙	9.8 →	10.7* ↑	10.4* ↑
10.1 →	10.7* ↖	10.2* ←	10.4* ↓	10.8* →

beste Teiler: 27.2 (40.), 58.0 (34.), 67.1 (31.)
Trefferlage: 0.21 mm rechts, 0.18 mm hoch
Streuwert: 1.07, horizontal: 1.28, vertikal: 0.80



Ergebnis: 414.7 (396)
Serien: 103.7 103.1 103.3 104.6
Zähler: 36 4 0 0 0 0 0 0 0 0 0
Innenzehner: 33
Weiteste: 392 (5.), 326 (16.), 299 (17.)
beste Teiler: 9.0 (14.), 9.8 (7.), 34.2 (1.)
Trefferlage: 0.39 mm rechts, 0.18 mm tief
Streuwert: 1.14, horizontal: 1.20, vertikal: 1.09

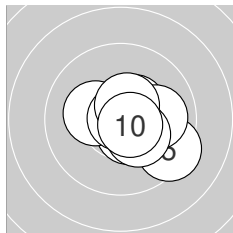
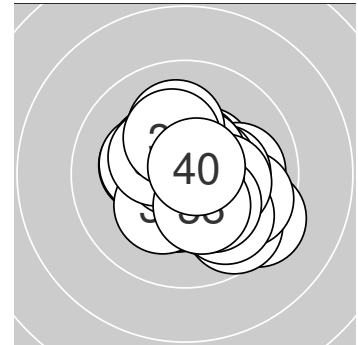

Serie 1: 103.7 (99)

10.8* ↑	10.5* ↓	10.2* ←	10.5* ↗	9.4 ↘
10.0 →	10.9* ↘	10.3* ↓	10.5* ↑	10.6* ↘

beste Teiler: 9.8 (7.), 34.2 (1.), 76.6 (10.)
Trefferlage: 0.78 mm rechts, 0.16 mm tief
Streuwert: 1.18, horizontal: 1.38, vertikal: 0.94

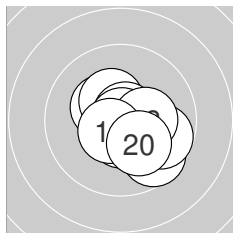

Serie 2: 103.1 (98)

10.3* ↘	10.4* ↖	10.7* ↗	10.9* →	10.5* ↓
9.6 ↘	9.8 ↘	10.3* →	10.5* ↗	10.1 ↘

beste Teiler: 9.0 (14.), 51.8 (13.), 102.5 (19.)
Trefferlage: 0.59 mm rechts, 0.42 mm tief
Streuwert: 1.26, horizontal: 1.35, vertikal: 1.16

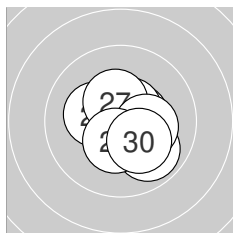

Serie 3: 103.3 (99)

10.5* →	10.4* ↓	10.6* ↗	9.9 ↘	10.5* ↘
10.2* ←	10.4* ↑	10.2* →	10.4* ↓	10.2* ↘

beste Teiler: 97.6 (23.), 111.9 (21.), 124.0 (25.)
Trefferlage: 0.44 mm rechts, 0.43 mm tief
Streuwert: 1.12, horizontal: 1.13, vertikal: 1.10

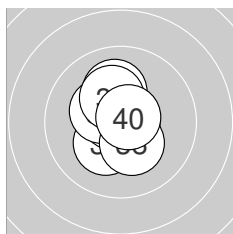

Serie 4: 104.6 (100)

10.7* ↗	10.6* ↖	10.2* ↘	10.7* ↖	10.8* →
10.3* ↖	10.1 ↑	10.3* ↓	10.2* ↖	10.7* ↗

beste Teiler: 49.7 (35.), 57.9 (34.), 58.8 (31.)
Trefferlage: 0.22 mm links, 0.29 mm hoch
Streuwert: 0.95, horizontal: 0.73, vertikal: 1.13



Ergebnis: **418.4** (399)
 Serien: 105.7 103.7 103.8 105.2
 Zähler: 39 1 0 0 0 0 0 0 0 0
 Innenzehner: 39
 Weitesten: 358 (24.), 194 (25.), 192 (18.)
 beste Teiler: 32.5 (20.), 39.2 (10.), 45.0 (9.)
 Trefferlage: 0.32 mm links, 0.20 mm tief
 Streuwert: 0.93, horizontal: 0.86, vertikal: 0.99

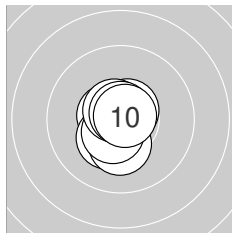
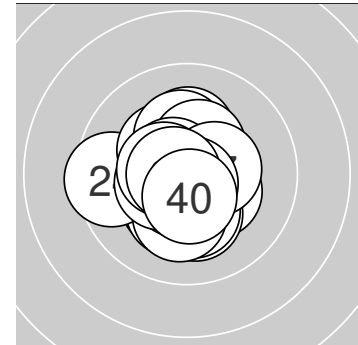

Serie 1: 105.7 (100)

10.7* ↖	10.6* ↖	10.3* ↗	10.5* ↓	10.3* ↓
10.6* ↗	10.5* ↘	10.6* ↘	10.8* ↑	10.8* ↗

beste Teiler: 39.2 (10.), 45.0 (9.), 71.5 (1.)
 Trefferlage: 0.28 mm links, 0.32 mm tief
 Streuwert: 0.71, horizontal: 0.48, vertikal: 0.89

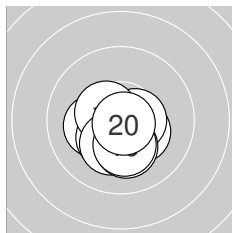

Serie 2: 103.7 (100)

10.5* ↓	10.2* ↖	10.3* ↗	10.3* ↘	10.5* →
10.5* ↘	10.2* ↘	10.2* ↓	10.2* ↓	10.8* ↘

beste Teiler: 32.5 (20.), 103.0 (15.), 116.2 (16.)
 Trefferlage: 0.16 mm links, 0.85 mm tief
 Streuwert: 0.90, horizontal: 0.99, vertikal: 0.81

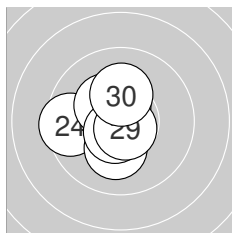

Serie 3: 103.8 (99)

10.6* ↖	10.7* ↓	10.5* ↑	9.5 ←	10.2* ↓
10.5* ↘	10.3* ↘	10.6* ↘	10.7* ↘	10.2* ↑

beste Teiler: 61.5 (29.), 61.6 (22.), 85.0 (21.)
 Trefferlage: 0.64 mm links, 0.08 mm hoch
 Streuwert: 1.13, horizontal: 1.13, vertikal: 1.13

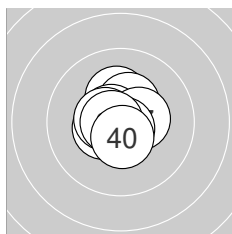

Serie 4: 105.2 (100)

10.2* ↑	10.4* ↖	10.7* ↑	10.4* ↗	10.6* ↘
10.5* ↖	10.4* →	10.8* ↓	10.7* ←	10.5* ↓

beste Teiler: 49.3 (38.), 57.2 (33.), 64.0 (39.)
 Trefferlage: 0.17 mm links, 0.25 mm hoch
 Streuwert: 0.80, horizontal: 0.77, vertikal: 0.83



Ergebnis: **420.3** (399)
 Serien: 104.4 104.7 105.5 105.7
 Zähler: 39 1 0 0 0 0 0 0 0 0
 Innenzehner: 34
 Weitesten: 364 (9.), 245 (39.), 223 (24.)
 beste Teiler: 11.6 (35.), 20.3 (30.), 21.9 (3.)
 Trefferlage: 0.02 mm rechts, 0.19 mm hoch
 Streuwert: 0.95, horizontal: 1.14, vertikal: 0.72

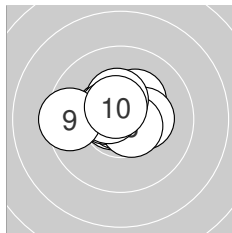
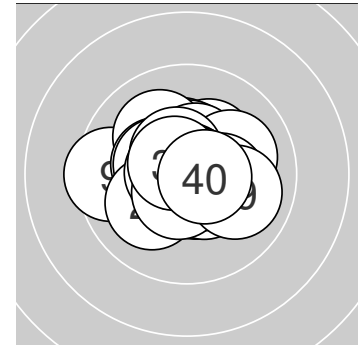

Serie 1: 104.4 (99)

10.7* ←	10.3* ↗	10.9* ↖	10.3* →	10.5* ↘
10.6* ↘	10.4* ↑	10.6* ↖	9.5 ←	10.6* ↗

beste Teiler: 21.9 (3.), 56.3 (1.), 91.5 (6.)
 Trefferlage: 0.34 mm links, 0.43 mm hoch
 Streuwert: 1.11, horizontal: 1.44, vertikal: 0.62

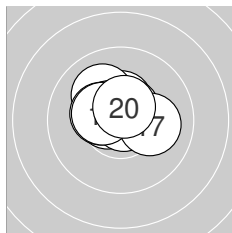

Serie 2: 104.7 (100)

10.4* ↑	10.6* ↗	10.1 ↘	10.6* ↘	10.6* ↖
10.9* →	10.1 →	10.4* ↖	10.4* ↖	10.6* ↑

beste Teiler: 23.0 (16.), 92.6 (12.), 93.7 (15.)
 Trefferlage: 0.24 mm links, 0.62 mm hoch
 Streuwert: 0.89, horizontal: 1.10, vertikal: 0.62

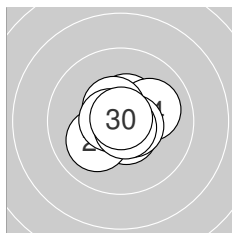

Serie 3: 105.5 (100)

10.5* ↑	10.8* ↘	10.6* ↘	10.1 →	10.5* ↘
10.1 ↖	10.6* ↘	10.7* ←	10.7* ↘	10.9* ↑

beste Teiler: 20.3 (30.), 43.6 (22.), 56.6 (29.)
 Trefferlage: 0.09 mm rechts, 0.05 mm hoch
 Streuwert: 0.92, horizontal: 1.00, vertikal: 0.82

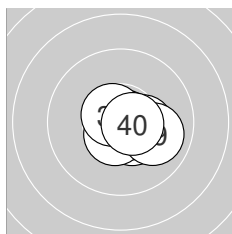

Serie 4: 105.7 (100)

10.5* ↘	10.6* ↘	10.3* →	10.8* →	10.9* ↗
10.8* ↘	10.6* ↘	10.6* ↖	10.0 →	10.6* →

beste Teiler: 11.6 (35.), 29.6 (34.), 46.8 (36.)
 Trefferlage: 0.59 mm rechts, 0.32 mm tief
 Streuwert: 0.70, horizontal: 0.87, vertikal: 0.47



Ergebnis: **418.2** (397)
 Serien: 106.0 105.2 103.9 103.1
 Zähler: 37 3 0 0 0 0 0 0 0 0
 Innenzehner: 34
 Weitestе: 343 (24.), 283 (39.), 282 (37.)
 beste Teiler: 5.0 (11.), 34.4 (5.), 42.0 (31.)
 Trefferlage: 0.14 mm rechts, 0.10 mm hoch
 Streuwert: 1.03, horizontal: 0.90, vertikal: 1.15

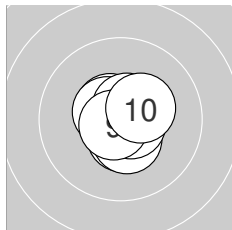
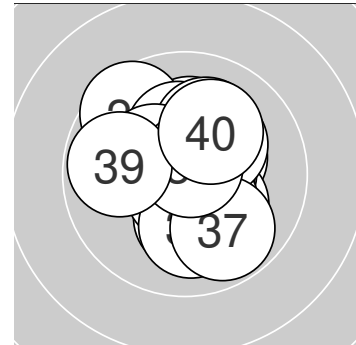

Serie 1: 106.0 (100)

10.5* ↓	10.7* ↓	10.4* ↓	10.6* ↖	10.8* ↑
10.6* ↖	10.7* ↘	10.6* ↗	10.7* ↗	10.4* ↗

beste Teiler: 34.4 (5.), 57.4 (9.), 69.1 (2.)
 Trefferlage: 0.10 mm rechts, 0.08 mm tief
 Streuwert: 0.71, horizontal: 0.64, vertikal: 0.77

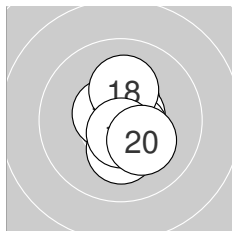

Serie 2: 105.2 (100)

10.9* ↗	10.5* ↑	10.7* ↗	10.7* ↑	10.6* ↘
10.6* ↖	10.2* ↓	10.2* ↑	10.6* ↓	10.2* ↘

beste Teiler: 5.0 (11.), 68.8 (13.), 72.2 (14.)
 Trefferlage: 0.25 mm rechts, 0.00 mm
 Streuwert: 0.91, horizontal: 0.58, vertikal: 1.14

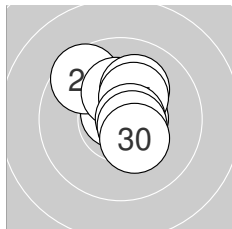

Serie 3: 103.9 (99)

10.7* ↗	10.6* →	10.7* ↖	9.6 ↖	10.3* ↑
10.1 ↑	10.3* ↗	10.7* →	10.6* ↘	10.3* ↘

beste Teiler: 51.0 (23.), 52.3 (21.), 62.1 (28.)
 Trefferlage: 0.23 mm rechts, 0.68 mm hoch
 Streuwert: 1.09, horizontal: 0.99, vertikal: 1.19

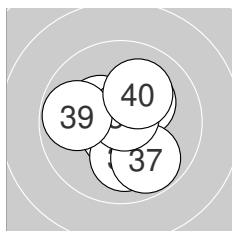

Serie 4: 103.1 (98)

10.8* ←	10.2* ↗	10.4* ↖	10.5* ↓	10.6* ↙
10.1 ↓	9.8 ↘	10.8* ↗	9.8 ←	10.1 ↗

beste Teiler: 42.0 (31.), 46.3 (38.), 77.0 (35.)
 Trefferlage: 0.02 mm links, 0.16 mm tief
 Streuwert: 1.35, horizontal: 1.31, vertikal: 1.39



Ergebnis: 416.8 (395)
Serien: 104.8 102.5 104.8 104.7
Zähler: 35 5 0 0 0 0 0 0 0 0 0
Innenzehner: 34
Weiteste: 274 (10.), 262 (17.), 256 (28.)
beste Teiler: 13.6 (9.), 23.5 (35.), 24.6 (24.)
Trefferlage: 0.15 mm rechts, 0.22 mm tief
Streuwert: 1.05, horizontal: 1.14, vertikal: 0.97

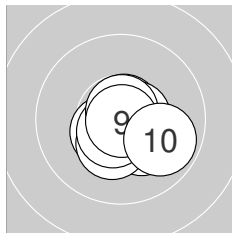
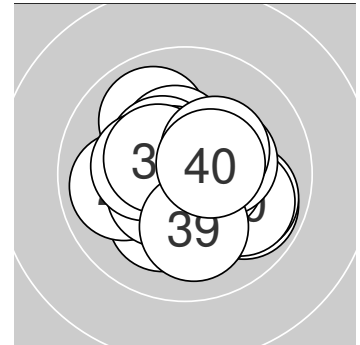

Serie 1: 104.8 (99)

10.5* ↙	10.4* ↘	10.2* ↘	10.3* ↓	10.7* ↑
10.6* ↓	10.6* →	10.7* ↑	10.9* ↘	9.9 ↘

beste Teiler: 13.6 (9.), 51.6 (8.), 57.9 (5.)
Trefferlage: 0.42 mm rechts, 0.49 mm tief
Streuwert: 0.89, horizontal: 1.02, vertikal: 0.74

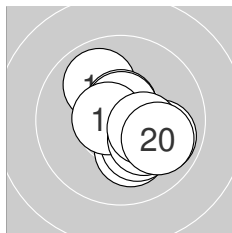

Serie 2: 102.5 (97)

9.9 ↘	10.6* ↑	10.6* ↑	10.2* ↓	10.2* ↓
10.6* ←	9.9 ↘	10.2* ↘	10.4* →	9.9 ↘

beste Teiler: 76.1 (13.), 77.7 (16.), 88.0 (12.)
Trefferlage: 0.72 mm rechts, 0.32 mm tief
Streuwert: 1.26, horizontal: 1.24, vertikal: 1.28

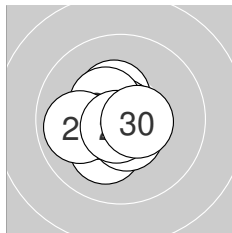

Serie 3: 104.8 (99)

10.4* ↑	10.5* ↙	10.2* ↓	10.9* ↗	10.8* ↑
10.4* ↘	10.5* ↓	9.9 ←	10.7* ↓	10.5* →

beste Teiler: 24.6 (24.), 30.4 (25.), 53.2 (29.)
Trefferlage: 0.44 mm links, 0.14 mm tief
Streuwert: 0.94, horizontal: 0.97, vertikal: 0.92

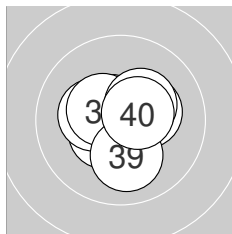

Serie 4: 104.7 (100)

10.8* ←	10.3* →	10.6* ↘	10.5* ↙	10.9* ←
10.3* ←	10.4* ↘	10.3* ↗	10.1 ↓	10.5* →

beste Teiler: 23.5 (35.), 45.6 (31.), 79.2 (33.)
Trefferlage: 0.07 mm links, 0.04 mm hoch
Streuwert: 1.00, horizontal: 1.09, vertikal: 0.91



Ergebnis: **414.8** (397)
 Serien: 102.7 104.0 103.5 104.6
 Zähler: 37 3 0 0 0 0 0 0 0 0
 Innenzehner: 29
 Weitester: 300 (15.), 262 (3.), 260 (38.)
 beste Teiler: 10.7 (24.), 28.1 (20.), 46.0 (32.)
 Trefferlage: 0.17 mm rechts, 0.14 mm tief
 Streuwert: 1.16, horizontal: 1.08, vertikal: 1.24

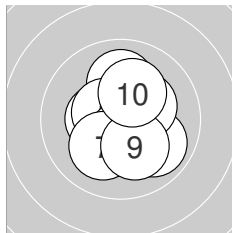
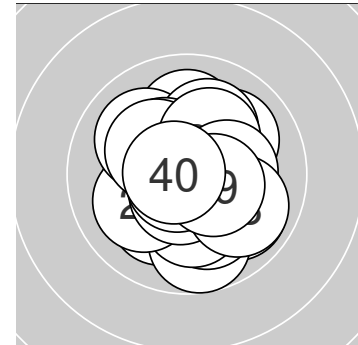

Serie 1: 102.7 (99)

10.4* ←	10.6* ↗	9.9 ↘	10.0 ↑	10.5* ↖
10.5* ↓	10.1 ↙	10.3* ↘	10.2* ↓	10.2* ↗

beste Teiler: 100.2 (2.), 107.8 (5.), 108.2 (6.)
 Trefferlage: 0.15 mm rechts, 0.02 mm hoch
 Streuwert: 1.34, horizontal: 1.17, vertikal: 1.49

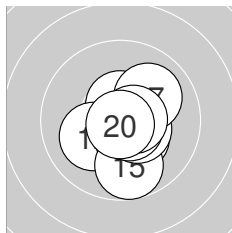

Serie 2: 104.0 (99)

10.6* ↑	10.1 ↙	10.4* ↘	10.5* ↓	9.8 ↓
10.5* ↘	10.0 ↗	10.7* ↘	10.6* →	10.8* ↓

beste Teiler: 28.1 (20.), 71.6 (18.), 83.1 (19.)
 Trefferlage: 0.44 mm rechts, 0.49 mm tief
 Streuwert: 1.10, horizontal: 0.95, vertikal: 1.23

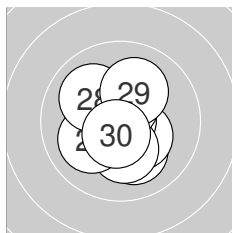

Serie 3: 103.5 (100)

10.1 ↓	10.3* ↘	10.7* ↙	10.9* →	10.2* ↓
10.5* ↑	10.1 ↙	10.0 ↘	10.1 ↑	10.6* ↙

beste Teiler: 10.7 (24.), 63.5 (23.), 88.8 (30.)
 Trefferlage: 0.07 mm links, 0.27 mm tief
 Streuwert: 1.22, horizontal: 1.05, vertikal: 1.36

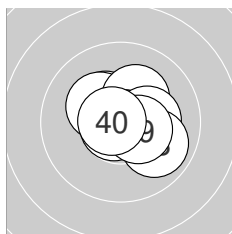

Serie 4: 104.6 (99)

10.8* ←	10.8* ←	10.4* ↘	10.3* ↖	10.2* ↗
10.7* ↙	10.3* →	9.9 ↘	10.5* ↘	10.7* ←

beste Teiler: 46.0 (32.), 48.0 (31.), 51.8 (36.)
 Trefferlage: 0.18 mm rechts, 0.18 mm hoch
 Streuwert: 1.06, horizontal: 1.23, vertikal: 0.85



Ergebnis: **419.4** (399)
 Serien: 105.0 104.8 103.9 105.7
 Zähler: 39 1 0 0 0 0 0 0 0 0
 Innenzehner: 35
 Weitestе: 369 (14.), 242 (26.), 223 (28.)
 beste Teiler: 41.4 (12.), 44.5 (39.), 45.0 (27.)
 Trefferlage: 0.44 mm links, 0.00 mm
 Streuwert: 0.92, horizontal: 1.09, vertikal: 0.70

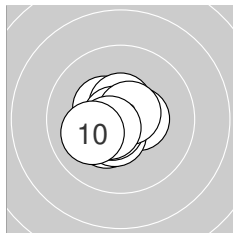
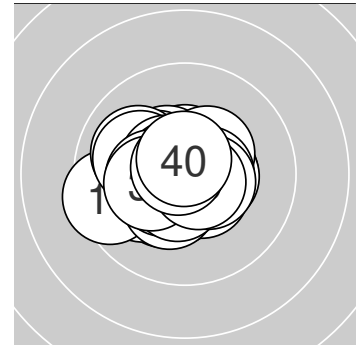

Serie 1: 105.0 (100)

10.5* →	10.3* ↙	10.5* ↓	10.4* ↘	10.5* ↑
10.6* ↘	10.8* ←	10.7* ↗	10.6* ↙	10.1 ↖

beste Teiler: 46.8 (7.), 75.8 (8.), 89.1 (6.)
 Trefferlage: 0.45 mm links, 0.21 mm tief
 Streuwert: 0.86, horizontal: 0.91, vertikal: 0.81

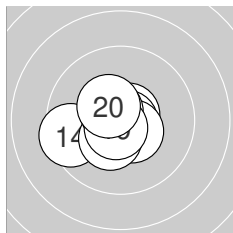

Serie 2: 104.8 (99)

10.7* ↗	10.8* →	10.6* ←	9.5 ←	10.6* ↘
10.5* ↘	10.4* ↙	10.6* ↘	10.7* ↙	10.4* ↘

beste Teiler: 41.4 (12.), 64.1 (19.), 65.8 (11.)
 Trefferlage: 0.48 mm links, 0.24 mm tief
 Streuwert: 1.03, horizontal: 1.24, vertikal: 0.75

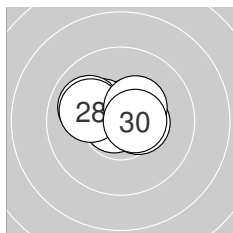

Serie 3: 103.9 (100)

10.6* ↗	10.4* →	10.7* ↗	10.1 ↘	10.3* ↖
10.0 ↖	10.8* ←	10.1 ↖	10.4* ↗	10.5* →

beste Teiler: 45.0 (27.), 60.8 (23.), 91.4 (21.)
 Trefferlage: 0.37 mm links, 0.53 mm hoch
 Streuwert: 1.05, horizontal: 1.42, vertikal: 0.42

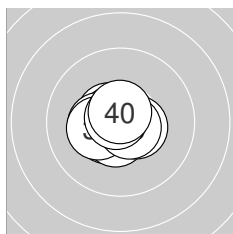

Serie 4: 105.7 (100)

10.6* ↘	10.5* ↙	10.7* ↘	10.3* ←	10.6* ↓
10.3* ←	10.5* →	10.7* ↘	10.8* ↘	10.7* ↑

beste Teiler: 44.5 (39.), 65.7 (33.), 72.1 (40.)
 Trefferlage: 0.45 mm links, 0.10 mm tief
 Streuwert: 0.72, horizontal: 0.86, vertikal: 0.55



LG 40 ZR

StandNr: 133

Penz, Irene #70218026

LG Seniorinnen 1 ST

Wertung

StartNr: 33

12.02.2023 10:10

SG_Matrei_a._B.

Ergebnis: **412.9** (396)
 Serien: 103.5 103.1 104.1 102.2
 Zähler: 36 4 0 0 0 0 0 0 0 0
 Innenzehner: 29
 Weitester: 340 (32.), 332 (24.), 261 (1.)
 beste Teiler: 18.3 (29.), 32.0 (5.), 70.2 (15.)
 Trefferlage: 0.12 mm links, 0.10 mm tief
 Streuwert: 1.23, horizontal: 1.45, vertikal: 0.97

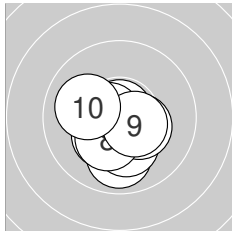
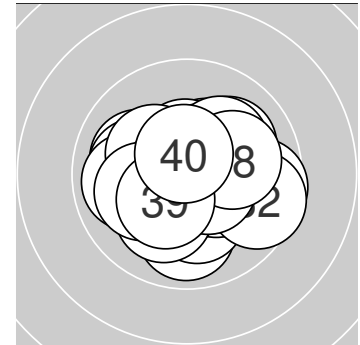
**Serie 1: 103.5 (99)**

9.9 ↓	10.2* ↓	10.4* ↘	10.5* ←	10.8* ↑
10.6* ←	10.3* ↙	10.3* ↙	10.5* ↘	10.0 ←

beste Teiler: 32.0 (5.), 76.1 (6.), 113.2 (9.)
 Trefferlage: 0.31 mm links, 0.75 mm tief
 Streuwert: 1.05, horizontal: 1.08, vertikal: 1.03

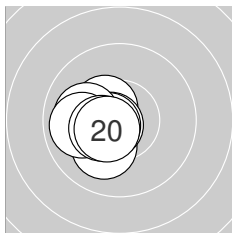
**Serie 2: 103.1 (99)**

10.4* ←	10.1 ←	10.4* ↘	10.1 ↙	10.7* ↙
10.6* ←	10.0 ←	9.9 ←	10.4* ←	10.5* ↙

beste Teiler: 70.2 (15.), 88.2 (16.), 106.2 (20.)
 Trefferlage: 1.37 mm links, 0.35 mm tief
 Streuwert: 0.67, horizontal: 0.66, vertikal: 0.68

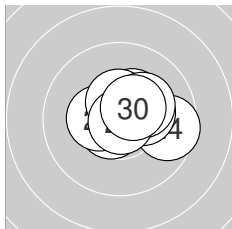
**Serie 3: 104.1 (99)**

10.7* ↙	10.4* ←	10.4* ↗	9.6 →	10.6* ↑
10.5* ↑	10.3* →	10.2* ↗	10.9* ↘	10.5* ↗

beste Teiler: 18.3 (29.), 75.2 (21.), 98.0 (25.)
 Trefferlage: 0.62 mm rechts, 0.44 mm hoch
 Streuwert: 1.05, horizontal: 1.32, vertikal: 0.69

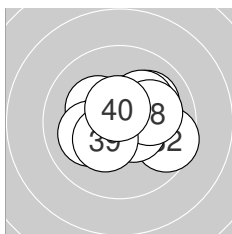
**Serie 4: 102.2 (99)**

10.3* ↘	9.6 →	10.5* ↗	10.0 ↗	10.5* ↘
10.1 ←	10.2* ↗	10.1 →	10.3* ↙	10.6* ↑

beste Teiler: 94.0 (40.), 107.3 (35.), 109.2 (33.)
 Trefferlage: 0.55 mm rechts, 0.24 mm hoch
 Streuwert: 1.39, horizontal: 1.68, vertikal: 1.02



Ergebnis: **419.7** (398)
 Serien: 103.9 105.4 104.9 105.5
 Zähler: 38 2 0 0 0 0 0 0 0 0
 Innenzehner: 37
 Weitestе: 274 (4.), 255 (27.), 247 (6.)
 beste Teiler: 30.8 (31.), 33.0 (23.), 40.3 (36.)
 Trefferlage: 0.16 mm links, 0.05 mm hoch
 Streuwert: 0.91, horizontal: 0.97, vertikal: 0.85

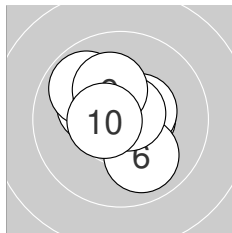
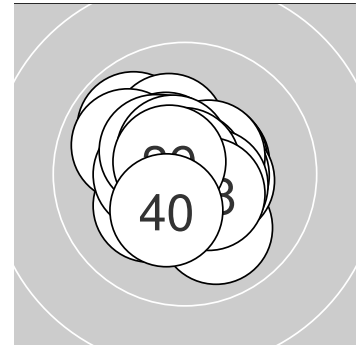

Serie 1: 103.9 (99)

10.2* ↖	10.5* →	10.5* →	9.9 ↖	10.8* ←
10.0 ↓	10.5* ↖	10.7* ↗	10.2* ↖	10.6* ←

beste Teiler: 45.0 (5.), 57.0 (8.), 96.4 (10.)
 Trefferlage: 0.24 mm links, 0.39 mm hoch
 Streuwert: 1.14, horizontal: 1.16, vertikal: 1.12

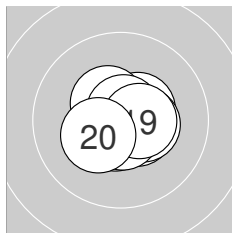

Serie 2: 105.4 (100)

10.5* ↗	10.5* ↘	10.4* →	10.6* ↓	10.7* ↓
10.4* ↖	10.7* ↓	10.8* ↑	10.5* →	10.3* ↗

beste Teiler: 50.3 (18.), 56.1 (15.), 73.8 (17.)
 Trefferlage: 0.23 mm rechts, 0.17 mm tief
 Streuwert: 0.78, horizontal: 0.88, vertikal: 0.66

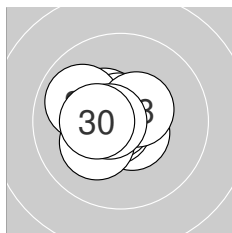

Serie 3: 104.9 (99)

10.6* ↘	10.7* ↗	10.8* ←	10.4* ↖	10.2* ↗
10.7* ↑	9.9 ↖	10.5* ↗	10.7* ←	10.4* ←

beste Teiler: 33.0 (23.), 52.4 (22.), 63.7 (26.)
 Trefferlage: 0.59 mm links, 0.10 mm hoch
 Streuwert: 0.88, horizontal: 0.98, vertikal: 0.75

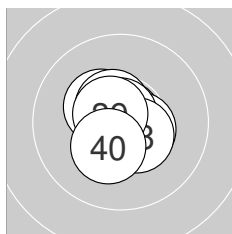

Serie 4: 105.5 (100)

10.8* ↗	10.6* ↘	10.4* ↖	10.5* ↖	10.5* →
10.8* ↑	10.5* ↓	10.5* ↘	10.6* ↖	10.3* ↓

beste Teiler: 30.8 (31.), 40.3 (36.), 78.7 (32.)
 Trefferlage: 0.06 mm links, 0.09 mm tief
 Streuwert: 0.79, horizontal: 0.76, vertikal: 0.81



LG 40 ZR

StandNr: 135

Felderer, Maria-Luise #70404042

LG Seniorinnen 1 ST

Wertung

StartNr: 35

12.02.2023 09:49

SG_Breitenbach

Ergebnis: **416.0** (398)
 Serien: 103.5 105.3 104.9 102.3
 Zähler: 38 2 0 0 0 0 0 0 0 0
 Innenzehner: 33
 Weitestе: 376 (35.), 252 (30.), 236 (1.)
 beste Teiler: 42.5 (25.), 49.0 (27.), 50.0 (24.)
 Trefferlage: 0.11 mm links, 0.03 mm tief
 Streuwert: 1.09, horizontal: 1.26, vertikal: 0.90

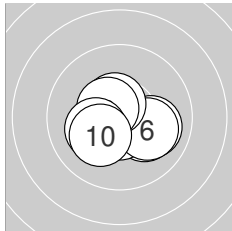
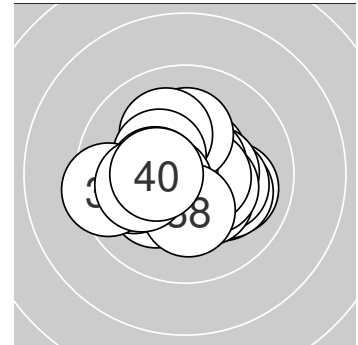
**Serie 1: 103.5 (100)**

10.0 →	10.1 →	10.7* ↘	10.6* ↙	10.6* ↓
10.1 →	10.5* ↑	10.5* ↖	10.2* ↙	10.2* ↘

beste Teiler: 70.8 (3.), 84.0 (5.), 87.0 (4.)
 Trefferlage: 0.15 mm rechts, 0.50 mm tief
 Streuwert: 1.13, horizontal: 1.43, vertikal: 0.72

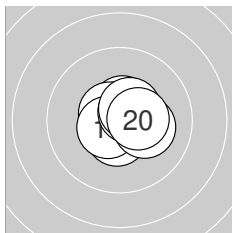
**Serie 2: 105.3 (100)**

10.5* ↓	10.6* ↗	10.6* ↑	10.7* ↑	10.6* ↖
10.6* ↙	10.6* ↗	10.2* →	10.5* ↗	10.4* →

beste Teiler: 55.0 (14.), 82.6 (12.), 88.2 (15.)
 Trefferlage: 0.32 mm rechts, 0.21 mm hoch
 Streuwert: 0.77, horizontal: 0.85, vertikal: 0.68

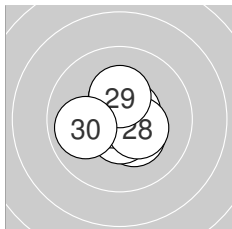
**Serie 3: 104.9 (99)**

10.3* ↘	10.4* ↑	10.6* ↓	10.8* →	10.8* ↗
10.6* ↗	10.8* ↖	10.4* ↘	10.3* ↑	9.9 ←

beste Teiler: 42.5 (25.), 49.0 (27.), 50.0 (24.)
 Trefferlage: 0.11 mm rechts, 0.05 mm hoch
 Streuwert: 0.99, horizontal: 1.04, vertikal: 0.93

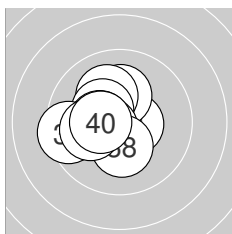
**Serie 4: 102.3 (99)**

10.6* →	10.2* ↑	10.1 ↘	10.3* ↖	9.4 ←
10.4* ←	10.5* ↙	10.3* ↓	10.1 ←	10.4* ←

beste Teiler: 95.0 (31.), 102.4 (37.), 137.0 (40.)
 Trefferlage: 1.04 mm links, 0.11 mm hoch
 Streuwert: 1.23, horizontal: 1.30, vertikal: 1.15



Ergebnis: **411.5** (395)
 Serien: 103.2 103.0 100.7 104.6
 Zähler: 35 5 0 0 0 0 0 0 0 0
 Innenzehner: 28
 Weitester: 461 (28.), 317 (24.), 308 (8.)
 beste Teiler: 34.2 (7.), 53.0 (20.), 64.0 (36.)
 Trefferlage: 0.43 mm links, 0.43 mm tief
 Streuwert: 1.28, horizontal: 1.35, vertikal: 1.22

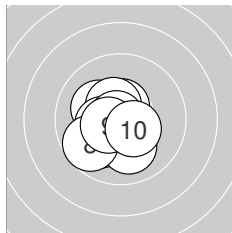
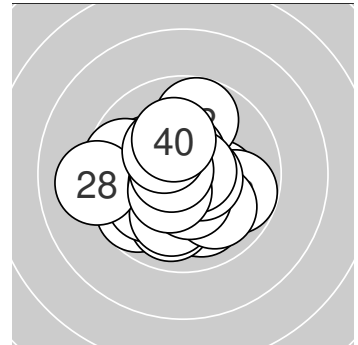

Serie 1: 103.2 (99)

10.2* ↖	10.6* ↑	10.5* ↘	10.0 ↙	10.4* ←
10.1 ↓	10.8* ←	9.7 ↗	10.5* ↘	10.4* ↘

beste Teiler: 34.2 (7.), 100.2 (2.), 108.6 (9.)
 Trefferlage: 0.73 mm links, 0.43 mm tief
 Streuwert: 1.16, horizontal: 1.10, vertikal: 1.21

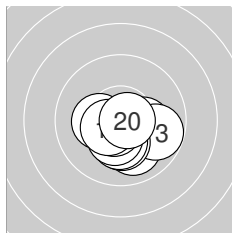

Serie 2: 103.0 (99)

10.2* →	10.0 ↓	9.8 →	10.3* ←	10.2* ↓
10.3* ↓	10.4* ↓	10.6* ↗	10.5* ↘	10.7* →

beste Teiler: 53.0 (20.), 83.8 (18.), 113.8 (19.)
 Trefferlage: 0.25 mm rechts, 0.97 mm tief
 Streuwert: 1.08, horizontal: 1.33, vertikal: 0.75

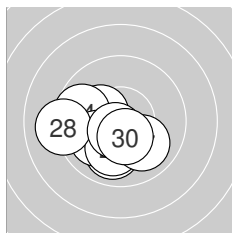

Serie 3: 100.7 (98)

10.0 ↓	10.3* ↖	10.5* ↗	9.7 ←	10.0 ↙
10.1 ↓	10.0 ↘	9.1 ←	10.6* ↗	10.4* ↓

beste Teiler: 86.8 (29.), 117.8 (23.), 129.1 (30.)
 Trefferlage: 1.14 mm links, 0.96 mm tief
 Streuwert: 1.45, horizontal: 1.76, vertikal: 1.06

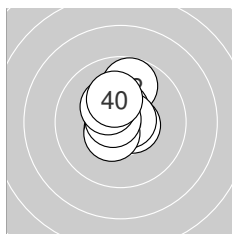

Serie 4: 104.6 (99)

10.6* ↑	9.8 ↑	10.6* ↗	10.6* ↑	10.6* →
10.7* →	10.5* ↗	10.7* ↖	10.3* ↘	10.2* ↑

beste Teiler: 64.0 (36.), 64.8 (38.), 84.2 (33.)
 Trefferlage: 0.12 mm links, 0.65 mm hoch
 Streuwert: 0.95, horizontal: 0.68, vertikal: 1.15



LG 40 ZR

StandNr: 137

Lettenbichler, Elisabeth #70404040**LG Seniorinnen 1 ST**

Wertung

StartNr: 37

12.02.2023 10:07

SG_Breitenbach

Ergebnis: **414.6** (394)
 Serien: 104.3 104.7 102.4 103.2
 Zähler: 34 6 0 0 0 0 0 0 0 0
 Innenzehner: 27
 Weitesten: 316 (26.), 298 (27.), 274 (32.)
 beste Teiler: 10.4 (3.), 14.3 (5.), 36.3 (36.)
 Trefferlage: 0.08 mm rechts, 0.14 mm hoch
 Streuwert: 1.20, horizontal: 1.42, vertikal: 0.93

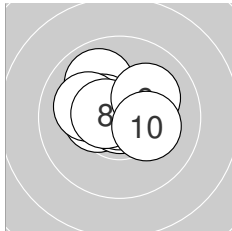
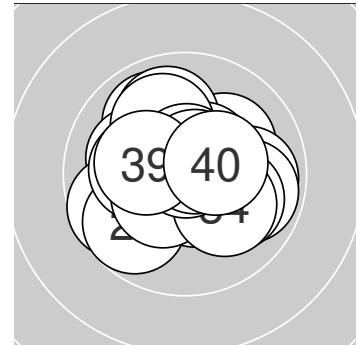
**Serie 1: 104.3 (99)**

10.7* ←	10.4* ←	10.9* ↓	9.9 ↖	10.9* ↑
10.5* ↖	10.1 ↖	10.6* ←	10.1 ↗	10.2* →

beste Teiler: 10.4 (3.), 14.3 (5.), 58.0 (1.)
 Trefferlage: 0.38 mm links, 0.44 mm hoch
 Streuwert: 1.06, horizontal: 1.27, vertikal: 0.79

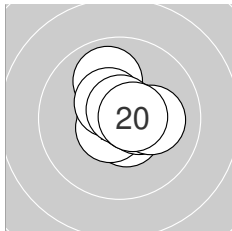
**Serie 2: 104.7 (99)**

10.6* ↓	10.7* ↖	10.6* ↗	10.6* →	9.9 ↑
10.4* →	10.1 →	10.5* ↖	10.7* ↑	10.6* →

beste Teiler: 55.5 (19.), 60.7 (12.), 76.4 (14.)
 Trefferlage: 0.28 mm rechts, 0.28 mm hoch
 Streuwert: 0.93, horizontal: 0.95, vertikal: 0.92

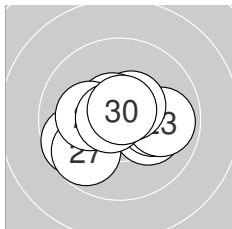
**Serie 3: 102.4 (97)**

10.2* →	10.1 →	9.9 →	10.5* ↗	10.6* ↖
9.7 ↖	9.8 ↗	10.2* ←	10.7* ←	10.7* ↑

beste Teiler: 61.4 (29.), 61.8 (30.), 89.0 (25.)
 Trefferlage: 0.04 mm links, 0.20 mm tief
 Streuwert: 1.51, horizontal: 1.91, vertikal: 0.95

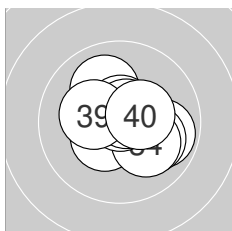
**Serie 4: 103.2 (99)**

10.4* ↗	9.9 →	10.0 →	10.1 →	10.0 ↖
10.8* ↑	10.6* ↑	10.7* ↗	10.3* ←	10.4* →

beste Teiler: 36.3 (36.), 69.0 (38.), 79.3 (37.)
 Trefferlage: 0.46 mm rechts, 0.07 mm hoch
 Streuwert: 1.26, horizontal: 1.43, vertikal: 1.06



Ergebnis: **412.4** (395)
 Serien: 102.4 102.8 103.0 104.2
 Zähler: 35 5 0 0 0 0 0 0 0 0
 Innenzehner: 28
 Weitestе: 324 (20.), 276 (22.), 265 (8.)
 beste Teiler: 8.0 (39.), 45.2 (13.), 53.6 (37.)
 Trefferlage: 0.37 mm links, 0.40 mm tief
 Streuwert: 1.19, horizontal: 1.30, vertikal: 1.08

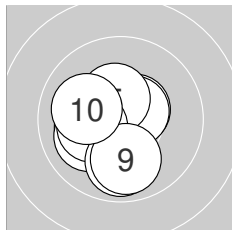
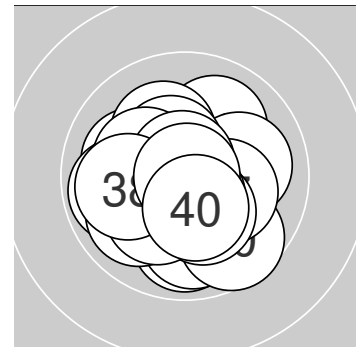

Serie 1: 102.4 (98)

10.6* ↙	10.5* ↗	10.6* ↗	10.1 ←	10.4* ↑
10.1 ←	10.2* ←	9.9 ↓	9.9 ↓	10.1 ↖

beste Teiler: 96.8 (3.), 100.1 (1.), 110.1 (2.)
 Trefferlage: 0.69 mm links, 0.48 mm tief
 Streuwert: 1.27, horizontal: 1.21, vertikal: 1.33

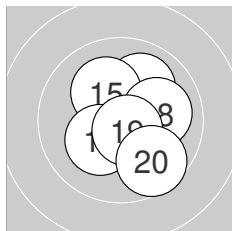

Serie 2: 102.8 (99)

10.6* ↗	10.0 ↗	10.8* ←	10.5* ↓	10.2* ↖
10.2* →	10.2* ↙	10.0 →	10.6* ↓	9.7 ↓

beste Teiler: 45.2 (13.), 77.9 (19.), 97.8 (11.)
 Trefferlage: 0.63 mm rechts, 0.12 mm tief
 Streuwert: 1.31, horizontal: 1.23, vertikal: 1.38

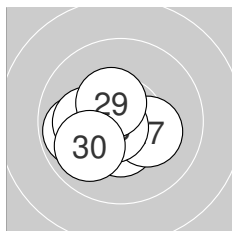

Serie 3: 103.0 (98)

10.5* ←	9.8 ←	10.6* ↓	10.4* ←	10.4* ↓
10.1 ←	10.2* ↘	10.7* ↙	10.4* ↖	9.9 ↙

beste Teiler: 61.8 (28.), 90.6 (23.), 121.0 (21.)
 Trefferlage: 0.86 mm links, 0.43 mm tief
 Streuwert: 1.06, horizontal: 1.29, vertikal: 0.77

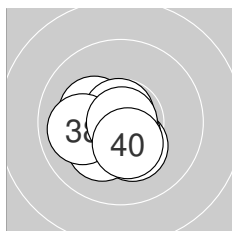

Serie 4: 104.2 (100)

10.3* ↓	10.2* ↖	10.5* ↙	10.6* ↓	10.4* ↙
10.2* ↙	10.7* ↑	10.0 ←	10.9* →	10.4* ↓

beste Teiler: 8.0 (39.), 53.6 (37.), 91.4 (34.)
 Trefferlage: 0.58 mm links, 0.58 mm tief
 Streuwert: 0.92, horizontal: 1.03, vertikal: 0.79



Ergebnis: 415.8 (397)
Serien: 103.3 104.1 103.8 104.6
Zähler: 37 3 0 0 0 0 0 0 0 0 0
Innenzehner: 34
Weiteste: 309 (8.), 281 (29.), 261 (16.)
beste Teiler: 51.5 (1.), 51.7 (31.), 62.1 (35.)
Trefferlage: 0.41 mm links, 0.25 mm hoch
Streuwert: 1.03, horizontal: 1.02, vertikal: 1.05

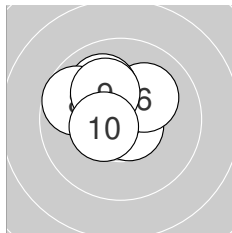
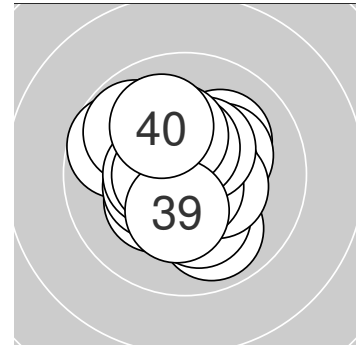

Serie 1: 103.3 (99)

10.7* ←	10.4* ↖	10.7* ↘	10.4* ↖	10.6* ↖
10.1 ↗	10.0 ↖	9.7 ↖	10.2* ↖	10.5* ↖

beste Teiler: 51.5 (1.), 69.6 (3.), 83.8 (5.)
Trefferlage: 0.70 mm links, 0.78 mm hoch
Streuwert: 1.02, horizontal: 1.15, vertikal: 0.88

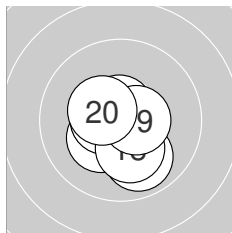

Serie 2: 104.1 (99)

10.6* ↖	10.5* ↓	10.3* ↗	10.5* ←	10.5* ←
9.9 ↘	10.7* ↑	10.2* ↓	10.5* →	10.4* ↖

beste Teiler: 68.5 (17.), 91.8 (11.), 101.0 (19.)
Trefferlage: 0.25 mm links, 0.46 mm tief
Streuwert: 1.01, horizontal: 0.93, vertikal: 1.09

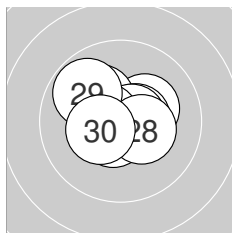

Serie 3: 103.8 (99)

10.2* ↗	10.2* ↖	10.6* →	10.4* ←	10.6* ↗
10.7* →	10.5* ←	10.4* ↘	9.8 ↖	10.4* ↖

beste Teiler: 72.5 (26.), 89.0 (25.), 98.6 (23.)
Trefferlage: 0.29 mm links, 0.31 mm hoch
Streuwert: 1.11, horizontal: 1.32, vertikal: 0.84

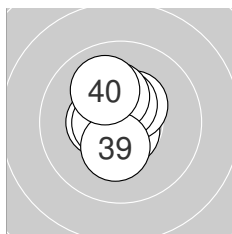

Serie 4: 104.6 (100)

10.7* ←	10.7* ←	10.4* ←	10.6* ←	10.7* ↘
10.4* ↗	10.5* ↑	10.3* ↑	10.3* ↓	10.0 ↖

beste Teiler: 51.7 (31.), 62.1 (35.), 64.6 (32.)
Trefferlage: 0.38 mm links, 0.39 mm hoch
Streuwert: 0.90, horizontal: 0.65, vertikal: 1.10



Ergebnis: **418.2** (398)
 Serien: 103.6 104.2 105.2 105.2
 Zähler: 38 2 0 0 0 0 0 0 0 0
 Innenzehner: 34
 Weitestе: 286 (11.), 274 (3.), 224 (40.)
 beste Teiler: 8.4 (13.), 36.0 (36.), 42.7 (38.)
 Trefferlage: 0.03 mm links, 0.21 mm hoch
 Streuwert: 1.00, horizontal: 1.07, vertikal: 0.92

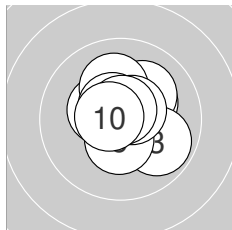
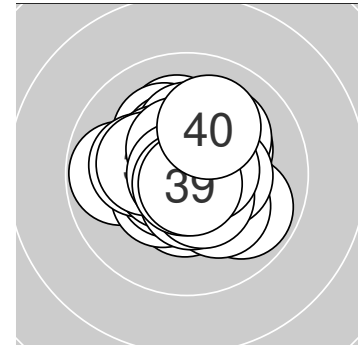

Serie 1: 103.6 (99)

10.2* ↗	10.1 ↗	9.9 ↘	10.4* ↖	10.4* ↓
10.1 ↑	10.6* ↗	10.6* ↘	10.7* ↑	10.6* ←

beste Teiler: 60.8 (9.), 76.1 (10.), 94.3 (8.)
 Trefferlage: 0.30 mm rechts, 0.46 mm hoch
 Streuwert: 1.13, horizontal: 1.15, vertikal: 1.11

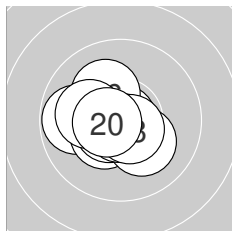

Serie 2: 104.2 (99)

9.8 ←	10.4* ↗	10.9* ↗	10.2* ↘	10.6* ↗
10.2* ↘	10.8* ↓	10.6* ↘	10.1 ←	10.6* ←

beste Teiler: 8.4 (13.), 49.3 (17.), 82.7 (18.)
 Trefferlage: 0.65 mm links, 0.18 mm tief
 Streuwert: 1.05, horizontal: 1.22, vertikal: 0.84

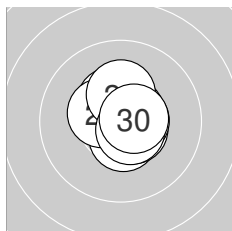

Serie 3: 105.2 (100)

10.4* ↘	10.5* ↓	10.6* ↘	10.6* ↘	10.6* ↗
10.6* →	10.4* ↖	10.3* ↑	10.6* ↘	10.6* →

beste Teiler: 81.3 (25.), 84.9 (29.), 87.4 (30.)
 Trefferlage: 0.15 mm rechts, 0.29 mm hoch
 Streuwert: 0.80, horizontal: 0.74, vertikal: 0.85

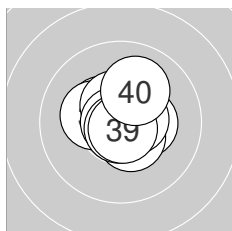

Serie 4: 105.2 (100)

10.4* ↘	10.4* →	10.5* ↘	10.3* ←	10.5* ↘
10.8* ←	10.6* →	10.8* ↓	10.8* ↓	10.1 ↑

beste Teiler: 36.0 (36.), 42.7 (38.), 44.2 (39.)
 Trefferlage: 0.03 mm rechts, 0.26 mm hoch
 Streuwert: 0.93, horizontal: 0.99, vertikal: 0.86



Ergebnis: 404.9 (386)
Serien: 99.9 101.3 101.6 102.1
Zähler: 27 12 1 0 0 0 0 0 0 0
Innenzehner: 22
Weiteste: 651 (7.), 486 (16.), 375 (25.)
beste Teiler: 21.9 (10.), 38.8 (27.), 67.2 (28.)
Trefferlage: 0.85 mm rechts, 0.35 mm hoch
Streuwert: 1.59, horizontal: 1.95, vertikal: 1.12

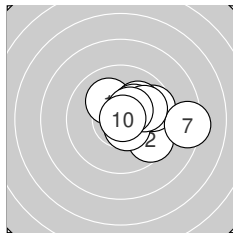
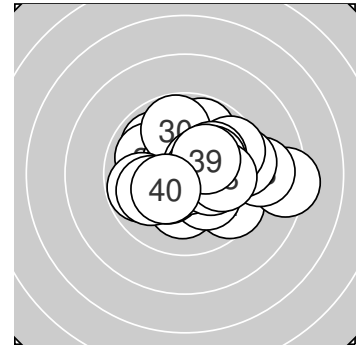

Serie 1: 99.9 (95)

10.1 ↘	9.6 ↘	9.7 →	10.1 ↗	10.3* ↗
10.5* ↘	8.3 →	9.9 →	10.5* ↗	10.9* ↗

beste Teiler: 21.9 (10.), 101.8 (6.), 125.1 (9.)
Trefferlage: 1.83 mm rechts, 0.41 mm hoch
Streuwert: 1.68, horizontal: 2.08, vertikal: 1.17

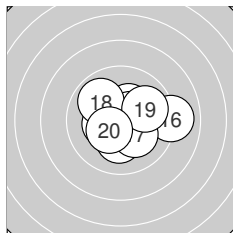

Serie 2: 101.3 (97)

10.6* ↘	10.3* ↗	10.3* ←	10.5* ↗	10.2* ↓
9.0 →	10.2* ↘	9.9 ↘	9.9 ↗	10.4* ↗

beste Teiler: 94.1 (11.), 104.4 (14.), 146.0 (20.)
Trefferlage: 0.49 mm rechts, 0.09 mm hoch
Streuwert: 1.68, horizontal: 2.05, vertikal: 1.22

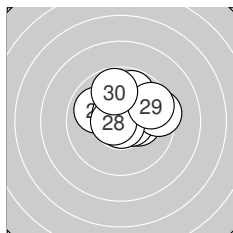

Serie 3: 101.6 (95)

10.3* →	10.6* →	9.8 ↑	9.9 ↘	9.5 →
10.6* ↘	10.8* ↓	10.7* ←	9.6 ↗	9.8 ↑

beste Teiler: 38.8 (27.), 67.2 (28.), 92.6 (26.)
Trefferlage: 0.63 mm rechts, 0.88 mm hoch
Streuwert: 1.52, horizontal: 1.81, vertikal: 1.17

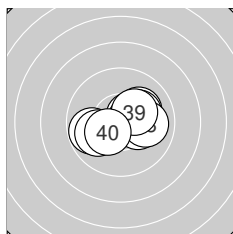

Serie 4: 102.1 (99)

9.8 ←	10.5* ↗	10.6* →	10.3* →	10.1 ↗
10.2* ↗	10.0 ←	10.0 →	10.3* ↗	10.3* ↗

beste Teiler: 90.7 (33.), 105.8 (32.), 156.8 (40.)
Trefferlage: 0.44 mm rechts, 0.02 mm hoch
Streuwert: 1.42, horizontal: 1.83, vertikal: 0.84



Ergebnis: **410.4** (392)
 Serien: 103.4 101.1 102.9 103.0
 Zähler: 32 8 0 0 0 0 0 0 0 0
 Innenzehner: 27
 Weitester: 462 (12.), 389 (16.), 318 (27.)
 beste Teiler: 40.1 (5.), 49.3 (18.), 59.6 (32.)
 Trefferlage: 0.13 mm links, 0.01 mm tief
 Streuwert: 1.41, horizontal: 1.64, vertikal: 1.12

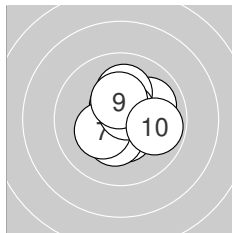
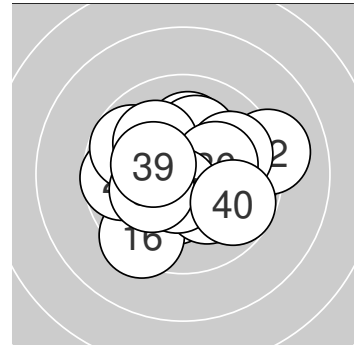

Serie 1: 103.4 (99)

10.0 →	10.1 ↑	10.5* ↓	10.5* ↑	10.8* ←
10.3* ↓	10.3* ↙	10.6* ↗	10.4* ↑	9.9 →

beste Teiler: 40.1 (5.), 78.2 (8.), 107.2 (4.)
 Trefferlage: 0.33 mm rechts, 0.23 mm hoch
 Streuwert: 1.22, horizontal: 1.23, vertikal: 1.22

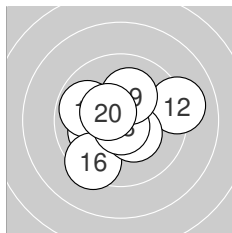

Serie 2: 101.1 (97)

10.6* ↙	9.1 →	10.3* ←	10.1 ←	9.8 ←
9.4 ↙	10.4* ↘	10.8* ↓	10.1 ↑	10.5* ↘

beste Teiler: 49.3 (18.), 95.8 (11.), 118.4 (20.)
 Trefferlage: 0.37 mm links, 0.21 mm tief
 Streuwert: 1.80, horizontal: 2.09, vertikal: 1.45

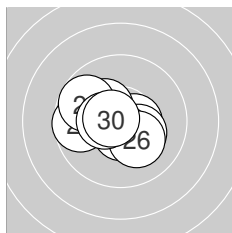

Serie 3: 102.9 (98)

10.5* →	10.3* ↘	10.6* ←	10.6* ↓	10.3* ↘
10.2* ↘	9.7 ←	9.7 ↘	10.4* ←	10.6* ←

beste Teiler: 76.9 (23.), 77.8 (30.), 88.2 (24.)
 Trefferlage: 0.60 mm links, 0.08 mm tief
 Streuwert: 1.28, horizontal: 1.58, vertikal: 0.87

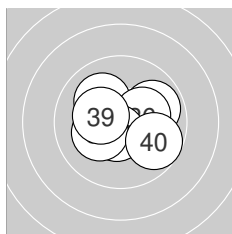

Serie 4: 103.0 (98)

10.7* ↘	10.7* ↘	9.9 →	10.1 ↘	10.6* ↙
10.2* →	10.6* ↓	10.2* ↙	10.3* ←	9.7 ↘

beste Teiler: 59.6 (32.), 73.5 (31.), 83.7 (35.)
 Trefferlage: 0.10 mm rechts, 0.00 mm
 Streuwert: 1.35, horizontal: 1.64, vertikal: 0.99



Ergebnis: **412.8** (395)
 Serien: 103.1 101.7 104.1 103.9
 Zähler: 35 5 0 0 0 0 0 0 0 0
 Innenzehner: 28
 Weitest: 318 (14.), 305 (17.), 292 (38.)
 beste Teiler: 9.0 (30.), 39.2 (16.), 44.9 (7.)
 Trefferlage: 0.14 mm rechts, 0.01 mm hoch
 Streuwert: 1.25, horizontal: 1.48, vertikal: 0.97

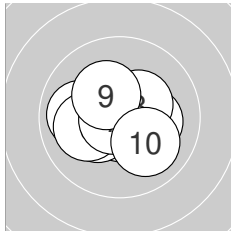
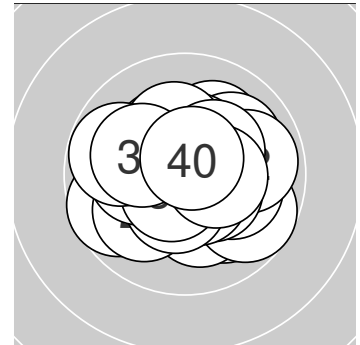

Serie 1: 103.1 (99)

10.7* ↓	10.3* ↙	9.9 ←	10.4* ↘	10.2* →
10.1 ←	10.8* ↙	10.4* ↗	10.3* ↖	10.0 ↘

beste Teiler: 44.9 (7.), 65.1 (1.), 134.1 (4.)
 Trefferlage: 0.12 mm links, 0.21 mm tief
 Streuwert: 1.28, horizontal: 1.59, vertikal: 0.86

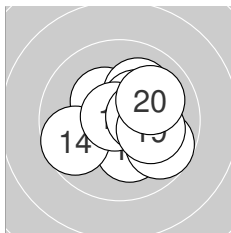

Serie 2: 101.7 (98)

10.3* ↖	10.2* ↓	10.1 ↗	9.7 ↙	10.4* ↗
10.8* ↖	9.7 ↘	10.4* →	10.1 →	10.0 ↗

beste Teiler: 39.2 (16.), 136.1 (18.), 149.9 (15.)
 Trefferlage: 0.67 mm rechts, 0.05 mm hoch
 Streuwert: 1.49, horizontal: 1.65, vertikal: 1.31

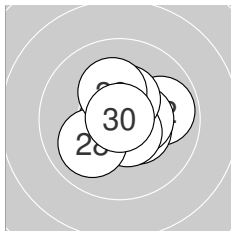

Serie 3: 104.1 (99)

10.6* ↘	9.9 →	10.4* ↘	10.4* →	10.7* ↙
10.6* ↘	10.4* ↑	10.0 ↙	10.2* ↖	10.9* ↑

beste Teiler: 9.0 (30.), 66.4 (25.), 83.8 (21.)
 Trefferlage: 0.40 mm rechts, 0.00 mm
 Streuwert: 1.10, horizontal: 1.21, vertikal: 0.99

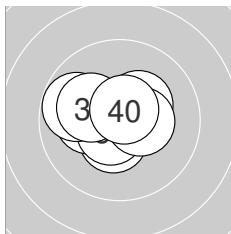

Serie 4: 103.9 (99)

10.6* ↗	10.5* ↓	10.3* ↗	10.2* ←	10.7* ↗
10.6* ↗	10.4* →	9.8 ←	10.1 ↖	10.7* ↑

beste Teiler: 51.6 (35.), 75.2 (40.), 79.2 (31.)
 Trefferlage: 0.38 mm links, 0.23 mm hoch
 Streuwert: 1.12, horizontal: 1.42, vertikal: 0.72



Ergebnis: 409.7 (390)
Serien: 102.3 101.1 103.7 102.6
Zähler: 31 8 1 0 0 0 0 0 0 0
Innenzehner: 27
Weiteste: 564 (20.), 404 (14.), 372 (7.)
beste Teiler: 17.2 (18.), 68.0 (30.), 69.8 (6.)
Trefferlage: 0.20 mm links, 0.06 mm hoch
Streuwert: 1.47, horizontal: 1.62, vertikal: 1.31

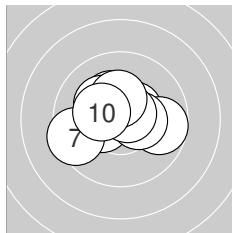
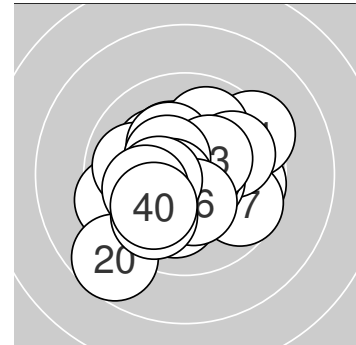

Serie 1: 102.3 (98)

10.5* ↗	10.3* ↖	9.7 →	10.4* ←	10.4* →
10.7* ↗	9.5 ←	10.2* ↘	10.3* ↑	10.3* ↘

beste Teiler: 69.8 (6.), 120.1 (1.), 140.4 (5.)
Trefferlage: 0.28 mm links, 0.36 mm hoch
Streuwert: 1.46, horizontal: 1.84, vertikal: 0.94

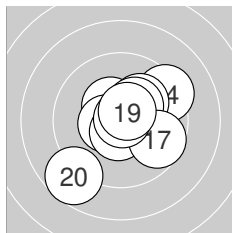

Serie 2: 101.1 (96)

10.4* ↖	10.5* ←	10.6* ↓	9.3 ↗	10.1 ↗
10.3* ↗	9.7 ↘	10.9* ↗	10.6* ↗	8.7 ↘

beste Teiler: 17.2 (18.), 85.8 (19.), 91.7 (13.)
Trefferlage: 0.38 mm rechts, 0.05 mm tief
Streuwert: 1.95, horizontal: 2.04, vertikal: 1.85

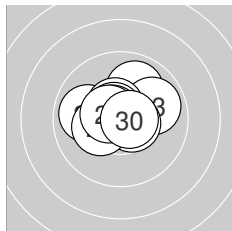

Serie 3: 103.7 (97)

9.9 ↑	9.9 ←	9.9 →	10.5* ↖	10.6* ↖
10.6* →	10.7* ↘	10.3* ←	10.6* ↘	10.7* →

beste Teiler: 68.0 (30.), 75.4 (27.), 80.1 (25.)
Trefferlage: 0.15 mm links, 0.51 mm hoch
Streuwert: 1.17, horizontal: 1.45, vertikal: 0.80

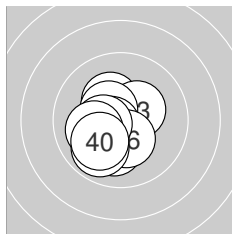

Serie 4: 102.6 (99)

10.1 ↓	10.3* ↖	10.4* ↗	10.5* ↖	10.6* ↖
10.3* ↓	10.4* ←	10.1 ←	9.9 ↘	10.0 ↘

beste Teiler: 83.2 (35.), 121.9 (34.), 138.0 (37.)
Trefferlage: 0.78 mm links, 0.56 mm tief
Streuwert: 1.15, horizontal: 1.01, vertikal: 1.29



Ergebnis: 417.1 (396)
Serien: 103.8 103.3 104.7 105.3
Zähler: 36 4 0 0 0 0 0 0 0 0 0
Innenzehner: 34
Weiteste: 318 (13.), 313 (20.), 266 (4.)
beste Teiler: 7.0 (34.), 29.7 (30.), 46.1 (33.)
Trefferlage: 0.01 mm rechts, 0.24 mm tief
Streuwert: 1.07, horizontal: 1.19, vertikal: 0.94

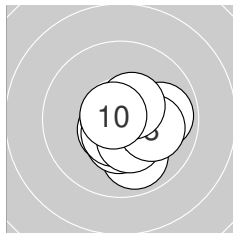
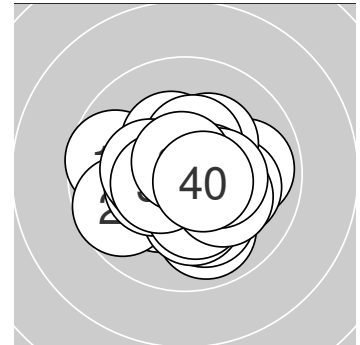

Serie 1: 103.8 (98)

9.9 ↓	10.6* ↗	10.8* ←	9.9 →	10.4* ↓
10.5* ↓	10.4* ↓	10.1 →	10.5* ↗	10.7* ↖

beste Teiler: 49.3 (3.), 55.0 (10.), 95.4 (2.)
Trefferlage: 0.48 mm rechts, 0.58 mm tief
Streuwert: 1.08, horizontal: 1.15, vertikal: 1.00

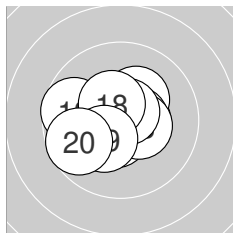

Serie 2: 103.3 (98)

10.5* →	10.3* ↗	9.7 ←	10.6* →	10.6* ↓
10.4* →	10.7* ↗	10.5* ↘	10.3* ↗	9.7 ↖

beste Teiler: 68.5 (17.), 97.1 (14.), 100.9 (15.)
Trefferlage: 0.31 mm links, 0.03 mm tief
Streuwert: 1.32, horizontal: 1.60, vertikal: 0.97

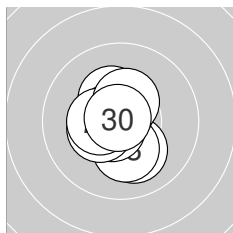

Serie 3: 104.7 (100)

10.1 ↓	10.3* ↖	10.2* ↓	10.7* ↑	10.7* ↗
10.4* ←	10.7* ↖	10.4* ←	10.4* ↑	10.8* ↖

beste Teiler: 29.7 (30.), 70.0 (24.), 72.8 (27.)
Trefferlage: 0.32 mm links, 0.08 mm tief
Streuwert: 0.97, horizontal: 0.75, vertikal: 1.15

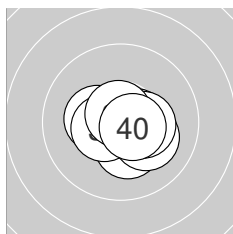

Serie 4: 105.3 (100)

10.3* ↓	10.3* ←	10.8* ←	10.9* ↖	10.2* ↘
10.6* →	10.4* →	10.5* ←	10.7* ↖	10.6* ↘

beste Teiler: 7.0 (34.), 46.1 (33.), 57.0 (39.)
Trefferlage: 0.21 mm rechts, 0.27 mm tief
Streuwert: 0.87, horizontal: 1.06, vertikal: 0.61



Ergebnis: 414.6 (395)
Serien: 103.7 103.3 103.7 103.9
Zähler: 35 5 0 0 0 0 0 0 0 0 0
Innenzehner: 32
Weiteste: 325 (4.), 312 (14.), 294 (9.)
beste Teiler: 35.6 (8.), 46.0 (11.), 51.1 (39.)
Trefferlage: 0.73 mm links, 0.12 mm hoch
Streuwert: 1.06, horizontal: 1.16, vertikal: 0.95

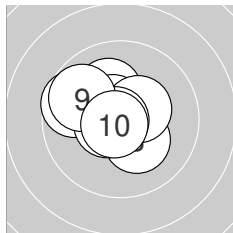
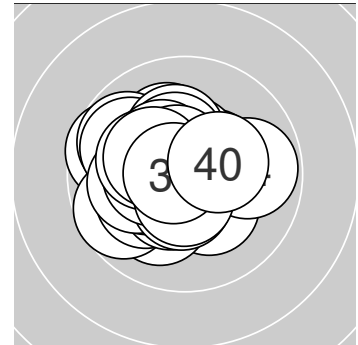

Serie 1: 103.7 (98)

10.6* ↘	10.2* ↘	10.3* ↘	9.7 ↖	10.6* ↘
10.4* ↗	10.6* ↖	10.8* ←	9.8 ↖	10.7* ↗

beste Teiler: 35.6 (8.), 54.0 (10.), 90.4 (5.)
Trefferlage: 0.69 mm links, 0.44 mm hoch
Streuwert: 1.17, horizontal: 1.34, vertikal: 0.96

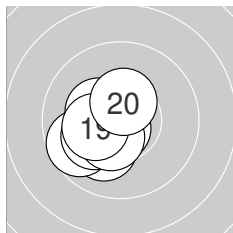

Serie 2: 103.3 (99)

10.8* ↗	10.1 ↘	10.4* ↗	9.7 ↖	10.1 ↖
10.7* ↘	10.4* ↗	10.3* ↖	10.3* ↖	10.5* ↑

beste Teiler: 46.0 (11.), 58.3 (16.), 124.4 (20.)
Trefferlage: 1.07 mm links, 0.60 mm tief
Streuwert: 0.90, horizontal: 0.87, vertikal: 0.93

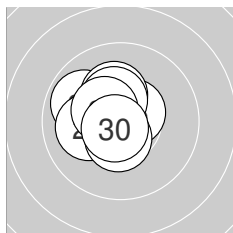

Serie 3: 103.7 (99)

9.9 ↖	10.6* ↖	10.3* ←	10.1 ←	10.6* ↗
10.2* ↗	10.5* ↓	10.4* ↗	10.4* ↖	10.7* ↗

beste Teiler: 61.8 (30.), 96.2 (25.), 99.1 (22.)
Trefferlage: 0.87 mm links, 0.28 mm hoch
Streuwert: 0.97, horizontal: 0.97, vertikal: 0.97

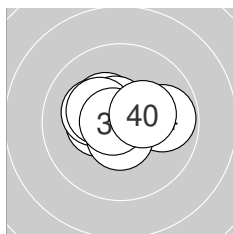

Serie 4: 103.9 (99)

10.4* ↘	10.4* ←	10.2* ↖	9.8 →	10.6* ↘
10.6* ↘	10.3* ↖	10.6* ↓	10.7* ←	10.3* ↗

beste Teiler: 51.1 (39.), 90.4 (36.), 93.3 (35.)
Trefferlage: 0.28 mm links, 0.37 mm hoch
Streuwert: 1.08, horizontal: 1.41, vertikal: 0.59



LG 40 ZR

StandNr: 147

Pfandler, Elisabeth #70515056

LG Seniorinnen 2 ST

Wertung

StartNr: 47

12.02.2023 09:49

SG_Zams

Ergebnis: **411.4** (393)
 Serien: 103.7 102.5 102.6 102.6
 Zähler: 33 7 0 0 0 0 0 0 0 0
 Innenzehner: 26
 Weitestе: 406 (20.), 394 (32.), 315 (27.)
 beste Teiler: 14.4 (30.), 15.0 (3.), 15.6 (34.)
 Trefferlage: 0.17 mm rechts, 0.14 mm tief
 Streuwert: 1.38, horizontal: 1.51, vertikal: 1.23

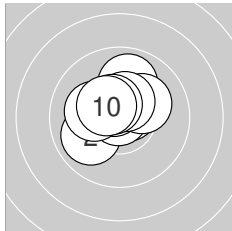
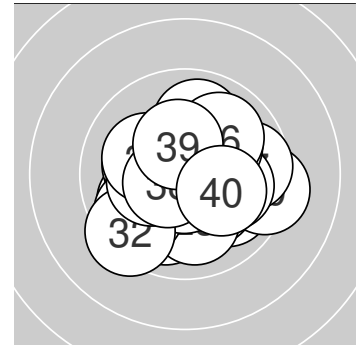
**Serie 1: 103.7 (98)**

10.6* ↗	9.9 ↙	10.9* ↘	9.9 ↑	10.6* ↖
10.2* ←	10.2* ↗	10.5* ↑	10.5* ↘	10.4* ↖

beste Teiler: 15.0 (3.), 77.2 (1.), 92.1 (5.)
 Trefferlage: 0.28 mm links, 0.70 mm hoch
 Streuwert: 1.07, horizontal: 1.18, vertikal: 0.96

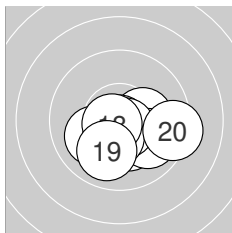
**Serie 2: 102.5 (98)**

10.3* ↓	10.3* →	10.8* ↓	9.9 ↘	10.1 ↙
10.7* ↓	10.4* ↓	10.7* ↙	10.0 ↓	9.3 →

beste Teiler: 36.1 (13.), 63.5 (18.), 71.0 (16.)
 Trefferlage: 0.50 mm rechts, 0.94 mm tief
 Streuwert: 1.31, horizontal: 1.71, vertikal: 0.73

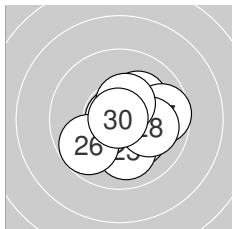
**Serie 3: 102.6 (98)**

10.2* ↓	10.5* ↓	10.0 ↓	10.8* ←	10.2* ↗
9.8 ↙	9.7 →	10.0 →	10.5* ↑	10.9* ↘

beste Teiler: 14.4 (30.), 33.7 (24.), 113.4 (22.)
 Trefferlage: 0.68 mm rechts, 0.38 mm tief
 Streuwert: 1.36, horizontal: 1.48, vertikal: 1.23

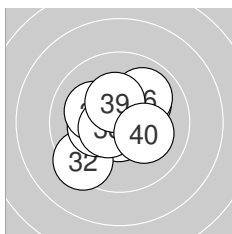
**Serie 4: 102.6 (99)**

10.7* ↓	9.4 ↙	10.3* ←	10.9* ↘	10.1 ↗
10.0 ↗	10.1 ↖	10.6* ↙	10.3* ↑	10.2* ↘

beste Teiler: 15.6 (34.), 71.1 (31.), 95.7 (38.)
 Trefferlage: 0.22 mm links, 0.03 mm hoch
 Streuwert: 1.51, horizontal: 1.60, vertikal: 1.40



Ergebnis: 412.4 (395)
Serien: 101.4 103.8 103.7 103.5
Zähler: 35 5 0 0 0 0 0 0 0 0 0
Innenzehner: 29
Weiteste: 376 (9.), 322 (37.), 284 (3.)
beste Teiler: 46.6 (25.), 74.2 (1.), 78.4 (22.)
Trefferlage: 0.21 mm links, 0.20 mm hoch
Streuwert: 1.24, horizontal: 1.36, vertikal: 1.10

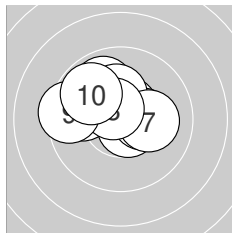
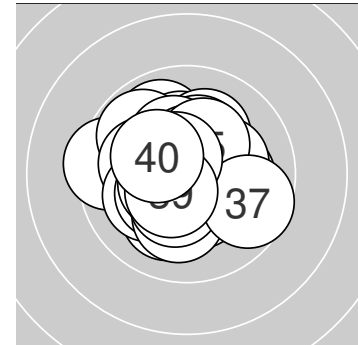

Serie 1: 101.4 (96)

10.7* ↘	10.6* ↗	9.8 ←	9.9 ↖	10.3* →
10.2* ↑	10.1 →	10.6* ↘	9.4 ←	9.8 ↘

beste Teiler: 74.2 (1.), 93.2 (8.), 95.7 (2.)
Trefferlage: 0.61 mm links, 0.81 mm hoch
Streuwert: 1.47, horizontal: 1.87, vertikal: 0.92

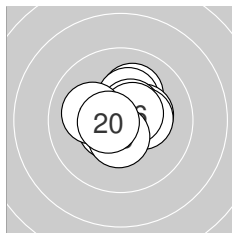

Serie 2: 103.8 (100)

10.1 ↗	10.3* ↗	10.3* →	10.5* ↗	10.3* →
10.6* ↗	10.5* ↘	10.1 ←	10.5* ↓	10.6* ←

beste Teiler: 90.0 (20.), 98.9 (16.), 101.7 (17.)
Trefferlage: 0.22 mm rechts, 0.38 mm hoch
Streuwert: 1.05, horizontal: 1.18, vertikal: 0.92

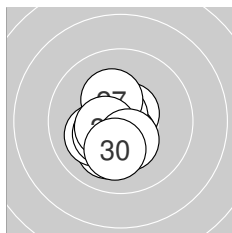

Serie 3: 103.7 (100)

10.1 ↘	10.6* ↗	10.1 ←	10.5* ↓	10.8* ↘
10.3* ↘	10.3* ↘	10.5* ←	10.4* ↓	10.1 ↓

beste Teiler: 46.6 (25.), 78.4 (22.), 111.6 (24.)
Trefferlage: 0.50 mm links, 0.62 mm tief
Streuwert: 0.99, horizontal: 0.81, vertikal: 1.15

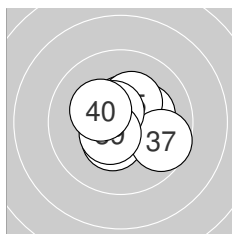

Serie 4: 103.5 (99)

10.4* ↘	10.6* ↘	10.5* ↑	10.2* →	10.3* ↗
10.4* ↓	9.7 ↘	10.6* ↘	10.5* ↘	10.3* ↘

beste Teiler: 93.2 (38.), 100.8 (32.), 111.5 (33.)
Trefferlage: 0.03 mm rechts, 0.25 mm hoch
Streuwert: 1.21, horizontal: 1.39, vertikal: 1.01

