

Ergebnis: **379.3** (364)
 Serien: 94.6 97.3 94.0 93.4
 Zähler: 16 15 6 3 0 0 0 0 0 0
 Innenzehner: 10
 Weitester: 844 (15.), 791 (36.), 789 (3.)
 beste Teiler: 51.0 (6.), 56.0 (38.), 100.0 (14.)
 Trefferlage: 0.22 mm rechts, 0.71 mm hoch
 Streuwert: 2.96, horizontal: 3.31, vertikal: 2.57

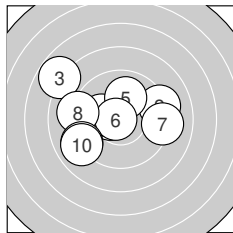
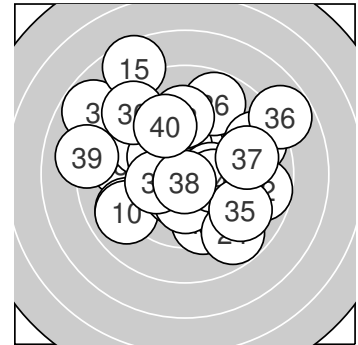

Serie 1: 94.6 (92)

10.5* ←	9.2 →	7.8 ↘	10.1 ←	10.0 ↑
10.7* ←	9.2 →	9.1 ←	9.0 ↗	9.0 ↙

beste Teiler: 51.0 (6.), 111.0 (1.), 210.8 (4.)
 Trefferlage: 1.39 mm links, 0.36 mm hoch
 Streuwert: 3.01, horizontal: 3.68, vertikal: 2.12

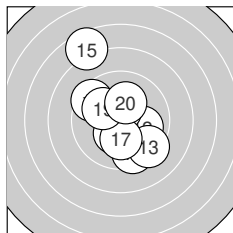

Serie 2: 97.3 (94)

9.5 ↓	10.0 →	9.3 ↘	10.6* ↑	7.6 ↖
10.3* ↙	10.2* ↓	9.5 ↘	10.1 ↘	10.2* ↑

beste Teiler: 100.0 (14.), 153.4 (16.), 193.9 (20.)
 Trefferlage: 0.20 mm links, 0.34 mm hoch
 Streuwert: 2.75, horizontal: 2.17, vertikal: 3.22

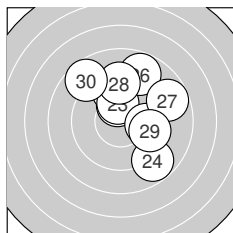

Serie 3: 94.0 (88)

10.3* ↑	9.6 ↑	10.2* ↑	8.8 ↘	9.9 →
8.8 ↑	8.8 ↗	9.3 ↑	9.6 →	8.7 ↘

beste Teiler: 169.2 (21.), 194.1 (23.), 272.2 (25.)
 Trefferlage: 1.10 mm rechts, 1.68 mm hoch
 Streuwert: 2.71, horizontal: 2.59, vertikal: 2.83

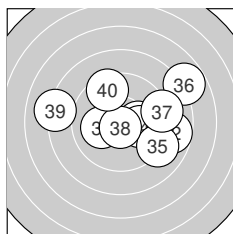

Serie 4: 93.4 (90)

10.2* →	8.7 →	10.1 ←	10.1 →	9.1 ↘
7.8 ↗	9.1 →	10.7* ↓	8.1 ←	9.5 ↑

beste Teiler: 56.0 (38.), 186.0 (31.), 210.8 (33.)
 Trefferlage: 1.40 mm rechts, 0.46 mm hoch
 Streuwert: 3.26, horizontal: 4.13, vertikal: 2.04



Ergebnis: **380.7** (362)
 Serien: 91.7 94.2 99.2 95.6
 Zähler: 10 23 6 1 0 0 0 0 0 0
 Innenzehner: 7
 Weitester: 784 (36.), 671 (10.), 634 (3.)
 beste Teiler: 32.5 (21.), 38.6 (31.), 67.5 (27.)
 Trefferlage: 0.14 mm rechts, 0.25 mm tief
 Streuwert: 2.82, horizontal: 3.15, vertikal: 2.45

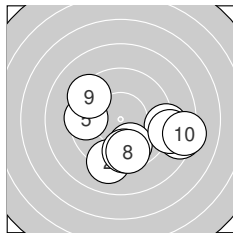
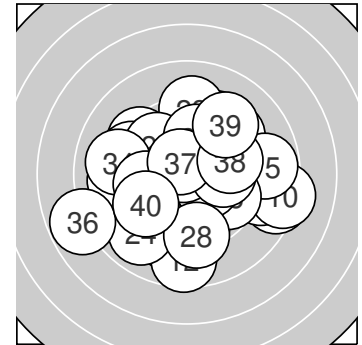

Serie 1: 91.7 (87)

9.1 →	9.1 ↓	8.4 →	9.8 ↓	9.5 ←
9.6 ↓	8.9 →	9.6 ↓	9.4 ↖	8.3 →

beste Teiler: 280.0 (4.), 326.8 (6.), 338.1 (8.)
 Trefferlage: 1.64 mm rechts, 1.62 mm tief
 Streuwert: 2.98, horizontal: 3.75, vertikal: 1.94

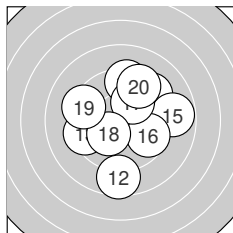

Serie 2: 94.2 (90)

9.3 ↗	8.6 ↓	9.4 ←	9.4 ↑	8.8 →
9.7 ↘	10.1 ↗	10.2* ↘	9.3 ↖	9.4 ↗

beste Teiler: 186.3 (18.), 222.1 (17.), 321.3 (16.)
 Trefferlage: 0.60 mm rechts, 0.37 mm hoch
 Streuwert: 2.94, horizontal: 2.92, vertikal: 2.96

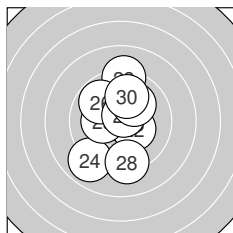

Serie 3: 99.2 (94)

10.8* →	10.3* ↘	9.2 ↑	8.9 ↙	10.2* ←
9.8 ↖	10.7* ↗	9.3 ↓	10.1 ↗	9.9 ↑

beste Teiler: 32.5 (21.), 67.5 (27.), 158.1 (22.)
 Trefferlage: 0.20 mm links, 0.24 mm hoch
 Streuwert: 2.22, horizontal: 1.56, vertikal: 2.72

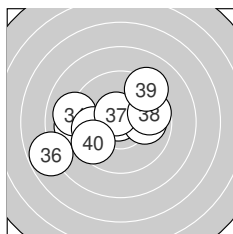

Serie 4: 95.6 (91)

10.8* ↖	9.1 ←	10.0 →	9.0 ←	9.8 ←
7.8 ←	10.6* ↖	9.7 →	9.2 ↗	9.6 ↙

beste Teiler: 38.6 (31.), 95.7 (37.), 248.0 (33.)
 Trefferlage: 1.46 mm links, 0.01 mm tief
 Streuwert: 2.78, horizontal: 3.50, vertikal: 1.80



Ergebnis: 366.2 (348)
Serien: 88.2 90.2 94.0 93.8
Zähler: 9 16 10 4 1 0 0 0 0 0 0
Innenzehner: 5
Weiteste: 1086 (15.), 919 (22.), 819 (5.)
beste Teiler: 61.0 (21.), 93.2 (40.), 137.9 (13.)
Trefferlage: 1.85 mm rechts, 0.93 mm hoch
Streuwert: 3.32, horizontal: 3.04, vertikal: 3.57

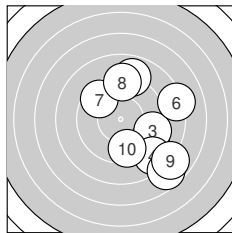
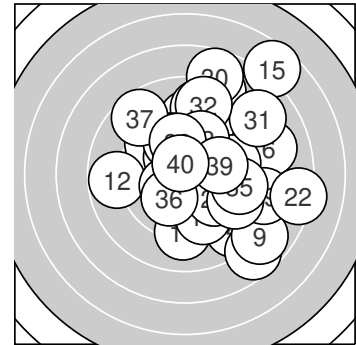

Serie 1: 88.2 (83)

8.9 ↑	9.3 ↘	9.3 →	8.6 ↘	7.7 ↘
8.2 →	9.6 ↘	9.2 ↑	7.9 ↘	9.5 ↓

beste Teiler: 350.8 (7.), 355.4 (10.), 405.8 (3.)
Trefferlage: 2.90 mm rechts, 0.86 mm tief
Streuwert: 3.52, horizontal: 2.90, vertikal: 4.04

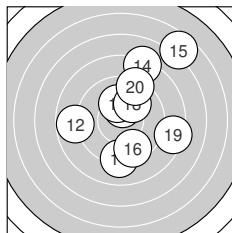

Serie 2: 90.2 (87)

9.1 ↓	8.8 ←	10.4* ↑	8.1 ↑	6.6 ↗
9.5 ↓	10.1 ↑	10.0 ↗	8.4 →	9.2 ↑

beste Teiler: 137.9 (13.), 201.6 (17.), 241.6 (18.)
Trefferlage: 1.46 mm rechts, 1.41 mm hoch
Streuwert: 3.83, horizontal: 3.48, vertikal: 4.14

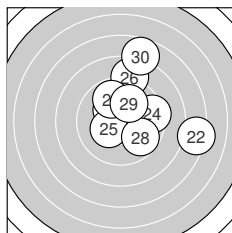

Serie 3: 94.0 (89)

10.7* →	7.3 →	10.3* ↘	9.4 →	10.3* ↗
8.8 ↑	9.8 ↗	9.7 ↘	10.0 ↑	7.7 ↑

beste Teiler: 61.0 (21.), 166.1 (25.), 169.4 (23.)
Trefferlage: 1.67 mm rechts, 1.54 mm hoch
Streuwert: 3.08, horizontal: 3.09, vertikal: 3.08

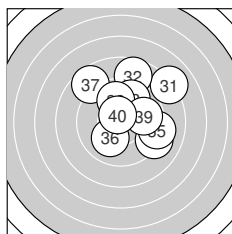

Serie 4: 93.8 (89)

8.0 ↗	8.7 ↑	9.7 ↑	9.1 ↘	9.2 →
10.1 ↗	8.7 ↘	9.9 ↑	9.8 →	10.6* ↗

beste Teiler: 93.2 (40.), 224.3 (36.), 265.4 (38.)
Trefferlage: 1.38 mm rechts, 1.64 mm hoch
Streuwert: 2.82, horizontal: 2.90, vertikal: 2.74



Ergebnis: **196.3** (191)
 Serien: 96.5 99.8
 Zähler: 14 3 3 0 0 0 0 0 0 0
 Innenzehner: 8
 Weitesten: 746 (10.), 709 (13.), 658 (6.)
 beste Teiler: 85.4 (16.), 92.9 (15.), 111.1 (14.)
 Trefferlage: 0.63 mm links, 0.30 mm hoch
 Streuwert: 2.47, horizontal: 3.19, vertikal: 1.40

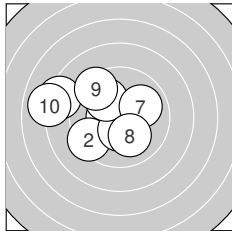
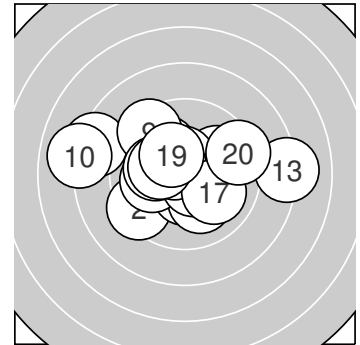

Serie 1: 96.5 (94)

10.4* ← 9.4 ↙ 10.5* ↘ 10.4* ↓ 10.0 ↖
 8.3 ← 10.0 ↗ 10.1 ↘ 9.4 ↖ 8.0 ←
 beste Teiler: 111.8 (3.), 126.0 (1.), 131.0 (4.)
 Trefferlage: 1.81 mm links, 0.27 mm hoch
 Streuwert: 2.54, horizontal: 3.10, vertikal: 1.83

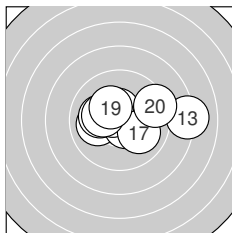

Serie 2: 99.8 (97)

10.0 ← 10.1 ← 8.1 → 10.5* ↑ 10.6* ↘
 10.6* ↖ 10.0 ↘ 10.2* ← 10.3* ↖ 9.4 →
 beste Teiler: 85.4 (16.), 92.9 (15.), 111.1 (14.)
 Trefferlage: 0.55 mm rechts, 0.32 mm hoch
 Streuwert: 2.19, horizontal: 2.97, vertikal: 0.89



Ergebnis: 397.3 (380)
Serien: 96.5 101.6 101.8 97.4
Zähler: 21 18 1 0 0 0 0 0 0 0 0
Innenzehner: 19
Weiteste: 682 (3.), 497 (5.), 462 (37.)
beste Teiler: 27.2 (18.), 51.1 (11.), 59.1 (29.)
Trefferlage: 0.05 mm links, 0.49 mm tief
Streuwert: 2.09, horizontal: 2.70, vertikal: 1.21

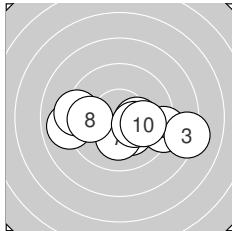
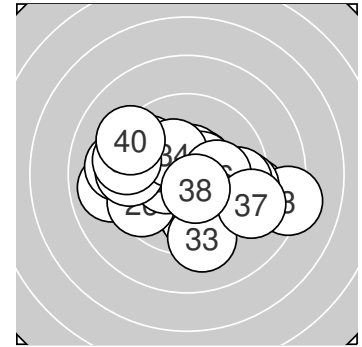

Serie 1: 96.5 (94)

10.3* →	9.2 →	8.2 →	10.2* ↓	9.0 ←
9.3 ←	10.2* ↓	9.8 ←	10.3* →	10.0 →

beste Teiler: 161.0 (9.), 171.3 (1.), 181.3 (4.)
Trefferlage: 0.52 mm rechts, 0.86 mm tief
Streuwert: 2.64, horizontal: 3.66, vertikal: 0.74

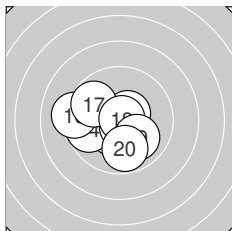

Serie 2: 101.6 (96)

10.7* →	10.4* ↓	10.5* ↗	9.7 ←	10.7* ↓
9.2 ←	9.8 ↘	10.8* ↗	10.0 ↘	9.8 ↓

beste Teiler: 27.2 (18.), 51.1 (11.), 70.3 (15.)
Trefferlage: 0.66 mm links, 0.42 mm tief
Streuwert: 1.66, horizontal: 1.97, vertikal: 1.28

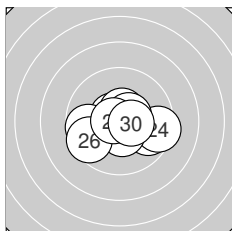

Serie 3: 101.8 (96)

10.6* ↖	9.7 ←	9.8 →	9.4 →	10.5* ↓
9.6 ←	10.5* ↑	10.5* ↗	10.7* ←	10.5* →

beste Teiler: 59.1 (29.), 85.6 (21.), 101.6 (27.)
Trefferlage: 0.17 mm rechts, 0.36 mm tief
Streuwert: 1.67, horizontal: 2.18, vertikal: 0.90

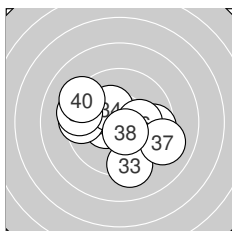

Serie 4: 97.4 (94)

10.4* ←	9.5 ←	9.3 ↓	10.3* ↖	9.6 →
10.2* →	9.1 →	10.5* ↓	9.3 ←	9.2 ↘

beste Teiler: 110.2 (38.), 137.0 (31.), 161.1 (34.)
Trefferlage: 0.25 mm links, 0.32 mm tief
Streuwert: 2.44, horizontal: 2.95, vertikal: 1.78



Ergebnis: 390.0 (371)
Serien: 96.9 97.2 101.1 94.8
Zähler: 14 23 3 0 0 0 0 0 0 0 0
Innenzehner: 10
Weiteste: 591 (14.), 580 (38.), 527 (39.)
beste Teiler: 18.6 (2.), 71.6 (21.), 103.4 (29.)
Trefferlage: 0.60 mm links, 0.38 mm tief
Streuwert: 2.29, horizontal: 2.05, vertikal: 2.51

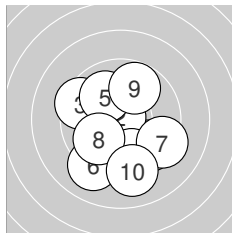
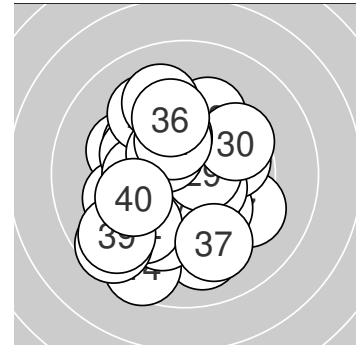

Serie 1: 96.9 (92)

9.6 ↘	10.9* ↑	9.5 ↖	9.7 ↓	10.0 ↗
9.1 ↙	9.3 ↘	9.9 ↗	9.8 ↑	9.1 ↓

beste Teiler: 18.6 (2.), 237.4 (5.), 254.8 (8.)
Trefferlage: 0.01 mm rechts, 1.12 mm tief
Streuwert: 2.40, horizontal: 2.26, vertikal: 2.53

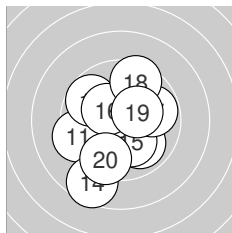

Serie 2: 97.2 (92)

9.4 ↖	9.9 ↘	9.7 ↖	8.6 ↙	10.1 ↓
10.4* ↖	9.8 →	9.5 ↑	10.3* →	9.5 ↙

beste Teiler: 150.7 (16.), 160.9 (19.), 202.5 (15.)
Trefferlage: 0.31 mm links, 0.63 mm tief
Streuwert: 2.41, horizontal: 2.19, vertikal: 2.61

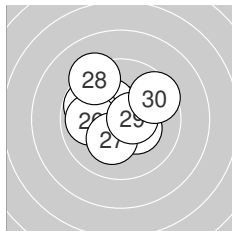

Serie 3: 101.1 (96)

10.7* ↗	10.3* ↘	10.5* ↖	10.3* ↖	9.8 ↖
9.9 ←	10.2* ↙	9.3 ↖	10.5* →	9.6 ↗

beste Teiler: 71.6 (21.), 103.4 (29.), 125.1 (23.)
Trefferlage: 0.46 mm links, 0.55 mm hoch
Streuwert: 1.69, horizontal: 1.87, vertikal: 1.48

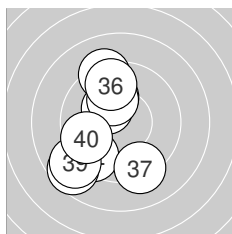

Serie 4: 94.8 (91)

10.0 ↑	9.4 ↗	10.3* ↖	10.1 ↑	9.2 ↑
9.6 ↑	9.2 ↓	8.6 ↗	8.8 ↗	9.6 ↗

beste Teiler: 166.8 (33.), 205.3 (34.), 227.1 (31.)
Trefferlage: 1.65 mm links, 0.31 mm tief
Streuwert: 2.58, horizontal: 1.75, vertikal: 3.19



Ergebnis: **383.5** (368)
 Serien: 98.0 95.8 96.5 93.2
 Zähler: 15 20 4 0 1 0 0 0 0 0 0
 Innenzehner: 11
 Weitester: 1127 (34.), 661 (15.), 656 (40.)
 beste Teiler: 67.1 (38.), 83.2 (7.), 100.6 (26.)
 Trefferlage: 0.05 mm links, 0.26 mm tief
 Streuwert: 2.84, horizontal: 3.67, vertikal: 1.64

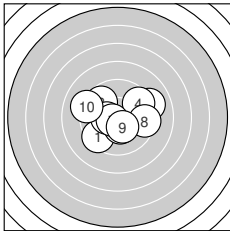
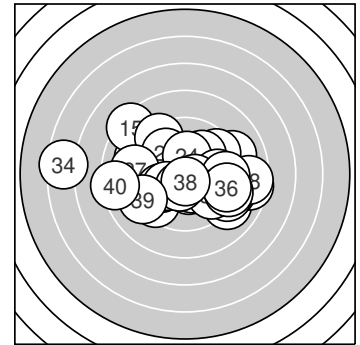

Serie 1: 98.0 (94)

9.4 ↙	9.1 →	9.7 ↘	9.6 ↗	10.3* ↓
10.4* ←	10.6* ↙	9.4 →	10.4* ↓	9.1 ↖

beste Teiler: 83.2 (7.), 149.3 (9.), 150.4 (6.)
 Trefferlage: 0.05 mm rechts, 0.07 mm hoch
 Streuwert: 2.37, horizontal: 2.91, vertikal: 1.66

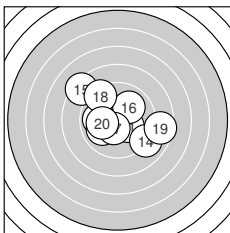

Serie 2: 95.8 (93)

10.3* ↘	9.9 ←	10.0 ↙	9.0 ↘	8.3 ↖
10.0 ↗	10.4* ↙	9.3 ↘	8.5 →	10.1 ←

beste Teiler: 126.2 (17.), 166.7 (11.), 215.3 (20.)
 Trefferlage: 0.19 mm links, 0.20 mm hoch
 Streuwert: 2.86, horizontal: 3.36, vertikal: 2.26

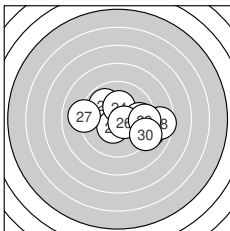

Serie 3: 96.5 (92)

9.9 ↘	10.5* ↙	9.1 →	10.3* ↑	9.7 →
10.6* ↘	9.1 ←	8.6 →	9.5 →	9.2 ↘

beste Teiler: 100.6 (26.), 125.5 (22.), 172.0 (24.)
 Trefferlage: 1.48 mm rechts, 0.18 mm tief
 Streuwert: 2.48, horizontal: 3.25, vertikal: 1.33

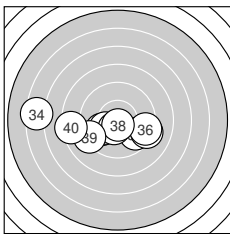

Serie 4: 93.2 (89)

9.7 ↘	9.2 ↘	9.9 ↙	6.4 ←	10.1 ↙
9.3 →	10.5* ↙	10.7* ↓	9.1 ↙	8.3 ←

beste Teiler: 67.1 (38.), 125.9 (37.), 202.4 (35.)
 Trefferlage: 1.56 mm links, 1.15 mm tief
 Streuwert: 3.43, horizontal: 4.77, vertikal: 0.86



Ergebnis: 402.0 (384)
Serien: 100.6 102.3 100.3 98.8
Zähler: 25 14 1 0 0 0 0 0 0 0 0
Innenzehner: 18
Weiteste: 570 (32.), 412 (30.), 398 (13.)
beste Teiler: 5.0 (8.), 50.0 (15.), 63.0 (3.)
Trefferlage: 0.11 mm rechts, 0.50 mm hoch
Streuwert: 1.79, horizontal: 2.12, vertikal: 1.38

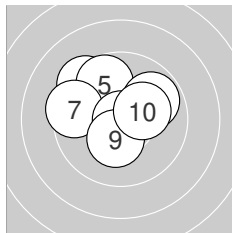
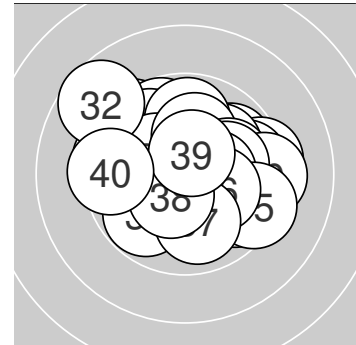

Serie 1: 100.6 (96)

9.4 ↖	10.1 ↖	10.7* ←	10.0 ↖	9.7 ↖
9.8 ↗	9.5 ←	10.9* ↘	10.3* ↓	10.2* ↗

beste Teiler: 5.0 (8.), 63.0 (3.), 155.9 (9.)
Trefferlage: 0.82 mm links, 0.94 mm hoch
Streuwert: 1.60, horizontal: 1.86, vertikal: 1.29

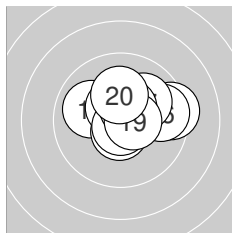

Serie 2: 102.3 (98)

10.0 ↖	10.6* ↓	9.4 →	10.5* ↖	10.8* ↓
9.7 →	10.0 ↗	10.5* ↗	10.6* →	10.2* ↑

beste Teiler: 50.0 (15.), 89.4 (12.), 97.2 (19.)
Trefferlage: 0.74 mm rechts, 0.60 mm hoch
Streuwert: 1.42, horizontal: 1.82, vertikal: 0.87

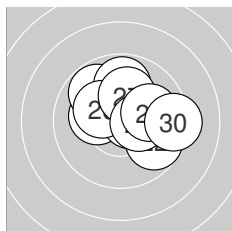

Serie 3: 100.3 (96)

10.2* ←	9.7 ↘	10.7* →	9.8 ↖	9.8 ↑
10.3* ↖	10.1 ↑	10.4* →	10.0 →	9.3 →

beste Teiler: 75.6 (23.), 142.4 (28.), 173.1 (26.)
Trefferlage: 0.66 mm rechts, 0.73 mm hoch
Streuwert: 1.69, horizontal: 2.00, vertikal: 1.30

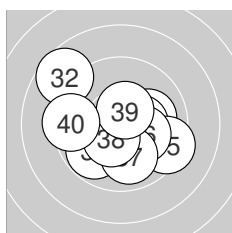

Serie 4: 98.8 (94)

10.1 →	8.7 ↖	9.8 ↗	10.4* →	9.4 ↘
10.2* ↘	9.9 ↓	10.4* ↗	10.5* ↑	9.4 ←

beste Teiler: 114.4 (39.), 131.1 (38.), 148.0 (34.)
Trefferlage: 0.11 mm links, 0.25 mm tief
Streuwert: 2.24, horizontal: 2.62, vertikal: 1.79



Ergebnis: **396.0** (377)
 Serien: 99.4 98.2 100.4 98.0
 Zähler: 21 15 4 0 0 0 0 0 0 0
 Innenzehner: 16
 Weitester: 729 (14.), 539 (6.), 529 (31.)
 beste Teiler: 33.1 (21.), 35.2 (8.), 54.3 (22.)
 Trefferlage: 0.53 mm links, 0.09 mm hoch
 Streuwert: 2.18, horizontal: 2.09, vertikal: 2.27

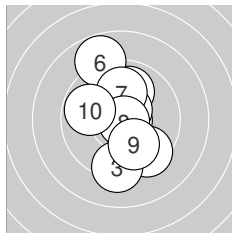
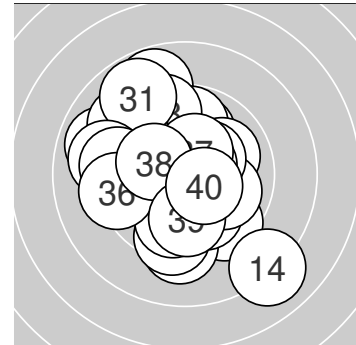

Serie 1: 99.4 (94)

10.7* →	9.5 ↘	9.3 ↓	9.9 ↑	10.6* ↗
8.8 ↗	10.0 ↑	10.8* ↘	10.0 ↓	9.8 ↖

beste Teiler: 35.2 (8.), 54.9 (1.), 96.7 (5.)
 Trefferlage: 0.08 mm rechts, 0.19 mm hoch
 Streuwert: 2.20, horizontal: 1.43, vertikal: 2.76

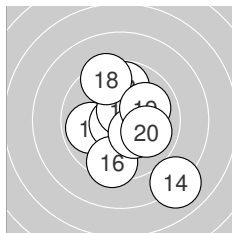

Serie 2: 98.2 (94)

9.9 ↖	10.7* ↙	9.8 ↑	8.0 ↘	10.6* ↑
9.5 ↓	10.3* ↘	9.4 ↗	10.0 →	10.0 ↘

beste Teiler: 60.0 (12.), 88.8 (15.), 159.8 (17.)
 Trefferlage: 0.56 mm rechts, 0.37 mm tief
 Streuwert: 2.46, horizontal: 2.12, vertikal: 2.75

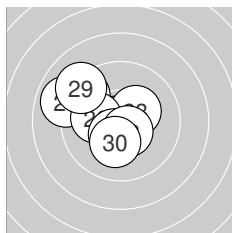

Serie 3: 100.4 (96)

10.8* →	10.7* ←	10.3* ↗	9.4 ↖	8.9 ↖
10.1 ←	10.4* ↙	10.5* ↘	9.1 ↖	10.2* ↓

beste Teiler: 33.1 (21.), 54.3 (22.), 108.1 (28.)
 Trefferlage: 1.29 mm links, 0.41 mm hoch
 Streuwert: 1.78, horizontal: 2.00, vertikal: 1.53

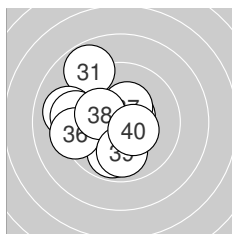

Serie 4: 98.0 (93)

8.8 ↘	9.1 ↖	10.6* ↗	9.9 ↓	9.4 ↖
9.3 ←	10.4* ↑	10.2* ↖	9.9 ↓	10.4* ↘

beste Teiler: 95.9 (33.), 132.4 (40.), 141.9 (37.)
 Trefferlage: 1.51 mm links, 0.15 mm hoch
 Streuwert: 2.14, horizontal: 2.19, vertikal: 2.08



Ergebnis: **391.3** (371)
 Serien: 97.3 97.7 97.0 99.3
 Zähler: 15 21 4 0 0 0 0 0 0 0
 Innenzehner: 13
 Weitester: 682 (16.), 536 (24.), 515 (28.)
 beste Teiler: 61.7 (2.), 63.5 (27.), 67.4 (12.)
 Trefferlage: 0.16 mm rechts, 1.23 mm tief
 Streuwert: 2.20, horizontal: 2.60, vertikal: 1.71

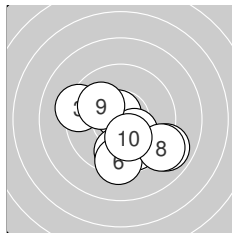
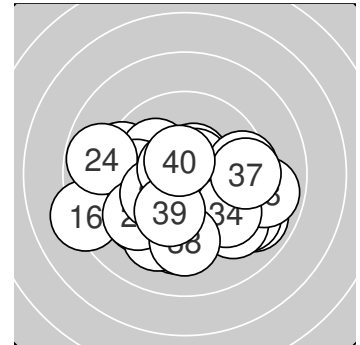

Serie 1: 97.3 (93)

8.9 ↘	10.7* ↖	9.3 ←	9.8 ↘	9.7 ↓
9.4 ↓	10.2* ↘	9.1 ↘	10.0 ↖	10.2* ↘

beste Teiler: 61.7 (2.), 179.0 (7.), 187.2 (10.)
 Trefferlage: 0.49 mm rechts, 1.50 mm tief
 Streuwert: 2.19, horizontal: 2.47, vertikal: 1.86

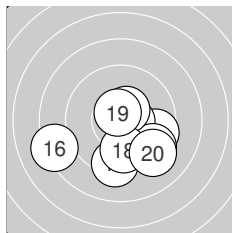

Serie 2: 97.7 (93)

9.5 ↘	10.7* ↑	10.5* →	9.4 ↘	9.3 ↓
8.2 ←	10.5* ↗	9.8 ↓	10.6* ↖	9.2 ↘

beste Teiler: 67.4 (12.), 78.1 (19.), 103.6 (13.)
 Trefferlage: 0.41 mm rechts, 1.41 mm tief
 Streuwert: 2.37, horizontal: 2.78, vertikal: 1.86

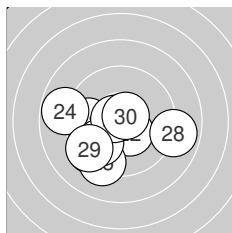

Serie 3: 97.0 (91)

9.4 ↙	10.4* ↘	9.7 ←	8.8 ←	9.2 ↓
9.8 ↙	10.7* ↖	8.9 →	9.4 ↙	10.7* ↗

beste Teiler: 63.5 (27.), 70.0 (30.), 138.5 (22.)
 Trefferlage: 1.20 mm links, 1.18 mm tief
 Streuwert: 2.31, horizontal: 2.85, vertikal: 1.61

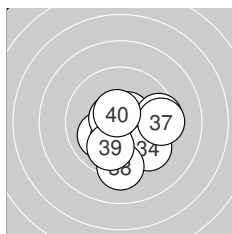

Serie 4: 99.3 (94)

10.6* ↗	9.8 →	9.5 →	9.5 ↘	10.1 ↙
10.6* ↖	9.4 →	9.3 ↓	9.9 ↓	10.6* ↖

beste Teiler: 86.8 (36.), 91.2 (31.), 91.9 (40.)
 Trefferlage: 0.95 mm rechts, 0.83 mm tief
 Streuwert: 1.90, horizontal: 2.09, vertikal: 1.68



Ergebnis: **397.4** (381)
 Serien: 101.5 97.8 99.5 98.6
 Zähler: 23 15 2 0 0 0 0 0 0 0
 Innenzehner: 18
 Weitester: 562 (32.), 537 (27.), 478 (8.)
 beste Teiler: 66.7 (21.), 73.8 (20.), 78.2 (3.)
 Trefferlage: 0.48 mm links, 0.10 mm tief
 Streuwert: 2.06, horizontal: 2.29, vertikal: 1.81

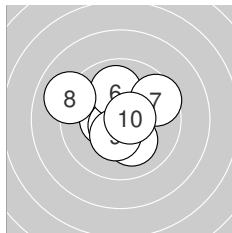
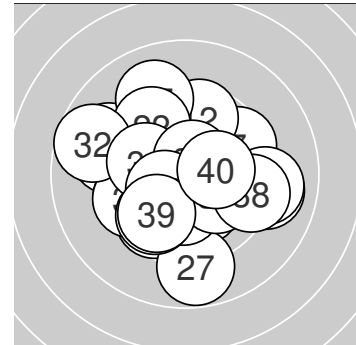

Serie 1: 101.5 (98)

10.4* ←	10.2* ↑	10.6* ↑	10.1 ↓	10.6* ↙
10.0 ↑	9.6 ↗	9.0 ↘	10.4* ↓	10.6* →

beste Teiler: 78.2 (3.), 78.5 (5.), 81.6 (10.)
 Trefferlage: 0.26 mm links, 0.50 mm hoch
 Streuwert: 1.69, horizontal: 1.89, vertikal: 1.47

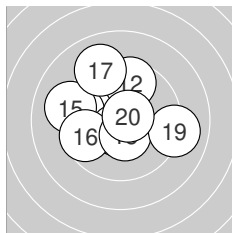

Serie 2: 97.8 (94)

10.0 ↘	9.6 ↑	9.5 ←	10.6* ↓	9.2 ←
9.6 ↙	9.1 ↑	10.4* ↓	9.1 →	10.7* ↗

beste Teiler: 73.8 (20.), 93.1 (14.), 133.8 (18.)
 Trefferlage: 0.89 mm links, 0.61 mm hoch
 Streuwert: 2.33, horizontal: 2.69, vertikal: 1.92

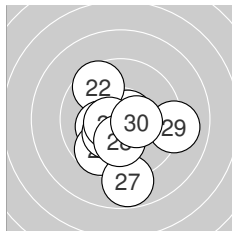

Serie 3: 99.5 (95)

10.7* ↗	9.6 ↘	10.2* ←	9.7 ↙	10.3* ↙
10.5* ←	8.8 ↓	10.2* ↓	9.1 →	10.4* →

beste Teiler: 66.7 (21.), 102.7 (26.), 139.7 (30.)
 Trefferlage: 0.03 mm links, 0.98 mm tief
 Streuwert: 2.05, horizontal: 2.00, vertikal: 2.10

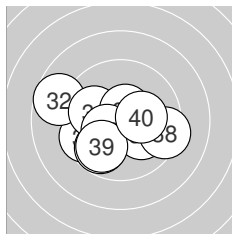

Serie 4: 98.6 (94)

9.6 ↙	8.7 ↘	9.8 ↙	10.0 ↘	10.6* ↑
10.4* ↙	10.1 ↘	9.4 →	9.8 ↙	10.2* →

beste Teiler: 96.1 (35.), 147.2 (36.), 181.8 (40.)
 Trefferlage: 0.74 mm links, 0.56 mm tief
 Streuwert: 2.16, horizontal: 2.71, vertikal: 1.40



Ergebnis: 414.6 (394)
Serien: 103.0 102.2 105.3 104.1
Zähler: 34 6 0 0 0 0 0 0 0 0 0
Innenzehner: 31
Weiteste: 312 (19.), 293 (8.), 293 (11.)
beste Teiler: 47.1 (9.), 58.8 (2.), 65.2 (22.)
Trefferlage: 0.17 mm rechts, 0.08 mm hoch
Streuwert: 1.16, horizontal: 1.34, vertikal: 0.95

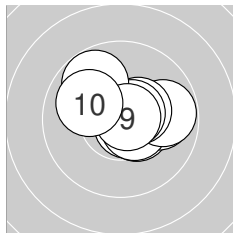
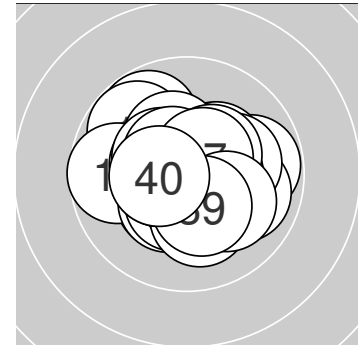

Serie 1: 103.0 (97)

10.5* ↘	10.7* ↘	9.9 →	10.5* ↘	9.8 →
10.4* ↗	10.6* ↗	9.8 ↖	10.8* ↗	10.0 ↖

beste Teiler: 47.1 (9.), 58.8 (2.), 85.4 (7.)
Trefferlage: 0.64 mm rechts, 0.37 mm hoch
Streuwert: 1.27, horizontal: 1.57, vertikal: 0.88

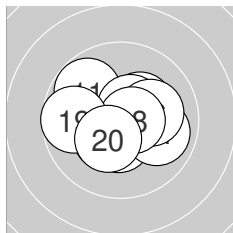

Serie 2: 102.2 (97)

9.8 ↖	10.4* ↓	10.3* ↗	9.9 ↘	10.5* ↗
10.1 →	10.4* ↗	10.7* →	9.7 ←	10.4* ↗

beste Teiler: 75.0 (18.), 105.2 (15.), 127.6 (12.)
Trefferlage: 0.01 mm links, 0.01 mm tief
Streuwert: 1.48, horizontal: 1.79, vertikal: 1.09

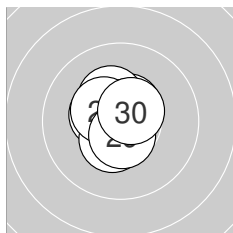

Serie 3: 105.3 (100)

10.4* ↖	10.7* ↗	10.5* ↗	10.4* ↗	10.3* ↖
10.7* ↗	10.7* ↖	10.4* ↖	10.6* ↓	10.6* ↗

beste Teiler: 65.2 (22.), 73.2 (26.), 74.8 (27.)
Trefferlage: 0.28 mm links, 0.26 mm hoch
Streuwert: 0.77, horizontal: 0.68, vertikal: 0.86

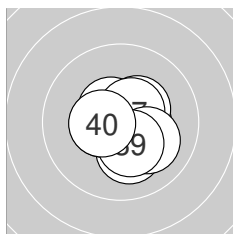

Serie 4: 104.1 (100)

10.5* →	10.6* ↘	10.2* ↓	10.5* ←	10.4* ↗
10.5* ↖	10.5* ↗	10.1 ↘	10.3* ↓	10.5* ←

beste Teiler: 76.0 (32.), 101.5 (36.), 102.5 (37.)
Trefferlage: 0.35 mm rechts, 0.27 mm tief
Streuwert: 1.00, horizontal: 1.03, vertikal: 0.97



Ergebnis: 410.7 (392)
Serien: 103.2 103.9 101.5 102.1
Zähler: 32 8 0 0 0 0 0 0 0 0
Innenzehner: 27
Weiteste: 413 (38.), 392 (9.), 371 (28.)
beste Teiler: 18.3 (5.), 23.3 (10.), 31.7 (7.)
Trefferlage: 0.68 mm links, 0.09 mm hoch
Streuwert: 1.35, horizontal: 1.60, vertikal: 1.05

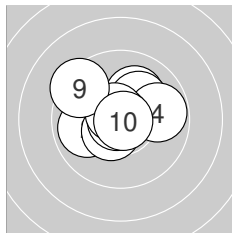
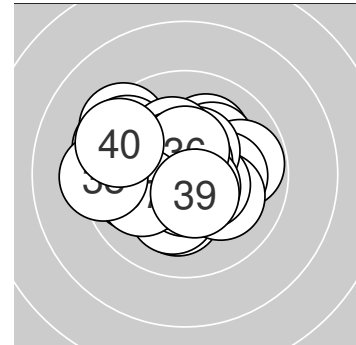

Serie 1: 103.2 (97)

10.1 ↗	9.9 ←	10.2* ↗	9.8 →	10.9* ↘
10.5* ↘	10.8* ←	10.7* ↘	9.4 ↘	10.9* ↘

beste Teiler: 18.3 (5.), 23.3 (10.), 31.7 (7.)
Trefferlage: 0.18 mm links, 0.50 mm hoch
Streuwert: 1.45, horizontal: 1.75, vertikal: 1.07

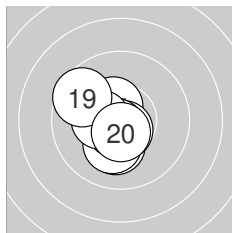

Serie 2: 103.9 (99)

10.7* ↘	10.5* ↓	10.2* ↓	10.2* ↓	10.5* ↘
10.6* ↓	10.7* ↘	10.3* ←	9.6 ↘	10.6* ↓

beste Teiler: 70.1 (17.), 71.8 (11.), 77.8 (16.)
Trefferlage: 0.68 mm links, 0.47 mm tief
Streuwert: 1.04, horizontal: 0.91, vertikal: 1.15

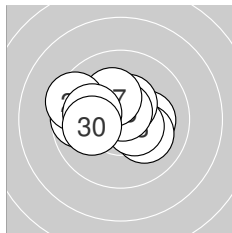

Serie 3: 101.5 (98)

10.2* →	10.1 ↘	10.5* ↘	10.4* ↗	10.7* ↗
9.7 ←	10.2* ↗	9.5 ↘	10.1 ←	10.1 ←

beste Teiler: 60.4 (25.), 119.8 (23.), 128.8 (24.)
Trefferlage: 0.60 mm links, 0.30 mm hoch
Streuwert: 1.56, horizontal: 2.01, vertikal: 0.90

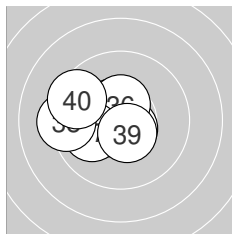

Serie 4: 102.1 (98)

10.5* ↘	10.4* ↘	10.6* ↘	10.3* ←	10.5* ↘
10.5* ↑	10.0 ←	9.3 ←	10.5* ↓	9.5 ↘

beste Teiler: 85.7 (33.), 106.6 (31.), 109.0 (35.)
Trefferlage: 1.28 mm links, 0.06 mm hoch
Streuwert: 1.29, horizontal: 1.56, vertikal: 0.94



Ergebnis: 412.2 (393)
Serien: 103.0 103.0 103.1 103.1
Zähler: 33 7 0 0 0 0 0 0 0 0 0
Innenzehner: 25
Weiteste: 340 (35.), 296 (2.), 291 (24.)
beste Teiler: 13.9 (5.), 53.0 (29.), 60.8 (28.)
Trefferlage: 0.19 mm links, 0.48 mm tief
Streuwert: 1.24, horizontal: 1.43, vertikal: 1.02

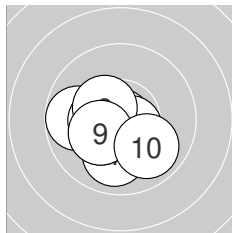
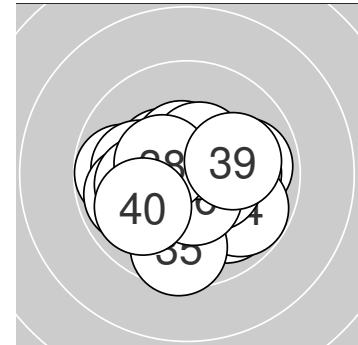

Serie 1: 103.0 (98)

10.0 ↓	9.8 ←	10.4* ←	10.3* ↖	10.9* ↓
10.4* ←	10.6* ↘	10.4* ↘	10.3* ↖	9.9 ↘

beste Teiler: 13.9 (5.), 86.3 (7.), 126.0 (3.)
Trefferlage: 0.75 mm links, 0.61 mm tief
Streuwert: 1.15, horizontal: 1.31, vertikal: 0.96

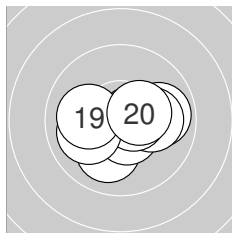

Serie 2: 103.0 (99)

10.5* ↓	10.7* →	10.1 ↓	10.6* ↓	9.9 →
10.1 →	10.6* →	10.0 ←	10.1 ←	10.4* →

beste Teiler: 68.3 (12.), 90.5 (17.), 97.0 (14.)
Trefferlage: 0.25 mm rechts, 0.35 mm tief
Streuwert: 1.31, horizontal: 1.65, vertikal: 0.84

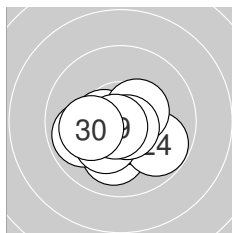

Serie 3: 103.1 (98)

10.1 ↓	9.9 ←	10.6* ↘	9.8 ↘	10.5* ←
10.4* ↗	10.3* ↖	10.7* ↘	10.7* ↖	10.1 ←

beste Teiler: 53.0 (29.), 60.8 (28.), 88.3 (23.)
Trefferlage: 0.31 mm links, 0.75 mm tief
Streuwert: 1.20, horizontal: 1.49, vertikal: 0.82

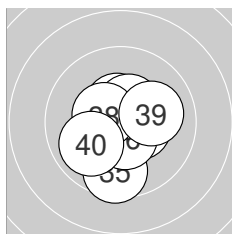

Serie 4: 103.1 (98)

10.5* ↗	10.4* →	10.5* ↑	10.6* ←	9.6 ↓
10.5* ↓	10.5* ↗	10.5* ↖	10.1 →	9.9 ↖

beste Teiler: 91.5 (34.), 109.4 (36.), 117.6 (33.)
Trefferlage: 0.03 mm rechts, 0.22 mm tief
Streuwert: 1.33, horizontal: 1.23, vertikal: 1.43



Ergebnis: **408.0** (391)
 Serien: 101.2 101.5 102.6 102.7
 Zähler: 31 9 0 0 0 0 0 0 0 0
 Innenzehner: 23
 Weitest: 431 (36.), 420 (12.), 355 (2.)
 beste Teiler: 47.0 (5.), 52.6 (33.), 55.0 (15.)
 Trefferlage: 0.09 mm rechts, 0.23 mm tief
 Streuwert: 1.50, horizontal: 1.76, vertikal: 1.18

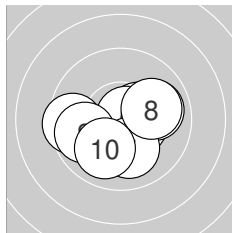
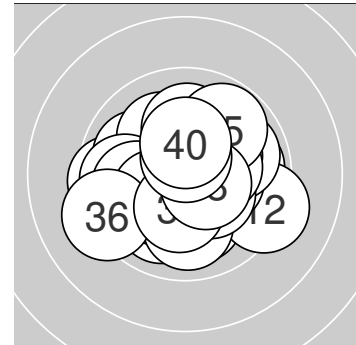

Serie 1: 101.2 (97)

10.4* →	9.5 ←	10.3* ↓	10.4* →	10.8* →
9.9 →	10.1 ↓	10.0 →	9.8 ←	10.0 ↙

beste Teiler: 47.0 (5.), 128.0 (4.), 137.9 (1.)
 Trefferlage: 0.14 mm rechts, 0.55 mm tief
 Streuwert: 1.62, horizontal: 1.99, vertikal: 1.13

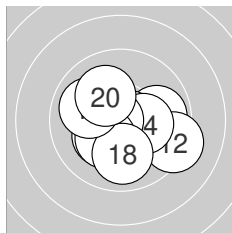

Serie 2: 101.5 (98)

9.9 →	9.3 ↘	10.7* →	10.3* →	10.7* ←
10.2* ↗	10.3* ↗	10.0 ↓	10.0 ↖	10.1 ↘

beste Teiler: 55.0 (15.), 60.2 (13.), 169.1 (14.)
 Trefferlage: 0.25 mm rechts, 0.38 mm tief
 Streuwert: 1.65, horizontal: 1.96, vertikal: 1.28

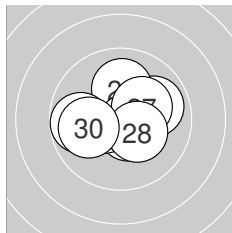

Serie 3: 102.6 (98)

10.6* ↗	10.6* ↘	10.4* ←	9.9 →	10.1 ↑
10.7* ↘	10.2* ↗	10.3* ↘	9.8 ←	10.0 ←

beste Teiler: 65.8 (26.), 94.7 (21.), 100.9 (22.)
 Trefferlage: 0.06 mm rechts, 0.14 mm hoch
 Streuwert: 1.41, horizontal: 1.73, vertikal: 1.01

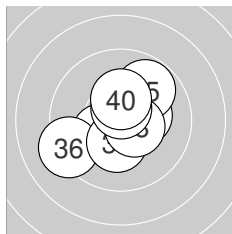

Serie 4: 102.7 (98)

10.7* ↓	10.3* ↗	10.7* ↘	10.3* →	9.8 ↗
9.2 ←	10.3* ↓	10.5* ↘	10.6* ↑	10.3* ↑

beste Teiler: 52.6 (33.), 65.1 (31.), 86.1 (39.)
 Trefferlage: 0.06 mm links, 0.12 mm tief
 Streuwert: 1.49, horizontal: 1.61, vertikal: 1.36



Ergebnis: 410.2 (392)
Serien: 102.6 102.3 103.5 101.8
Zähler: 32 8 0 0 0 0 0 0 0 0 0
Innenzehner: 27
Weiteste: 338 (19.), 337 (37.), 336 (6.)
beste Teiler: 48.0 (15.), 54.2 (21.), 68.9 (5.)
Trefferlage: 0.19 mm links, 0.24 mm hoch
Streuwert: 1.36, horizontal: 1.33, vertikal: 1.39

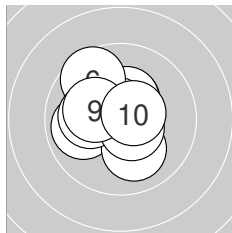
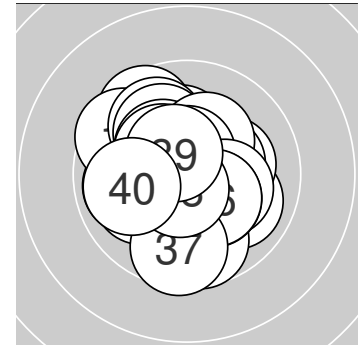

Serie 1: 102.6 (98)

9.9 ←	10.4* ↑	10.4* ↑	10.1 ↓	10.7* ↖
9.6 ↘	10.1 ←	10.6* ↘	10.2* ←	10.6* ↗

beste Teiler: 68.9 (5.), 98.4 (10.), 98.8 (8.)
Trefferlage: 0.50 mm links, 0.42 mm hoch
Streuwert: 1.36, horizontal: 1.41, vertikal: 1.30

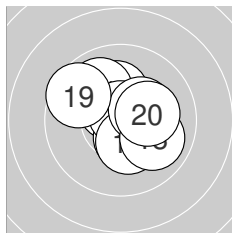

Serie 2: 102.3 (98)

10.2* ↑	10.5* ↘	10.5* ↓	9.9 ↘	10.8* ↑
10.3* ↓	10.3* ↗	10.0 ↘	9.6 ↘	10.2* →

beste Teiler: 48.0 (15.), 109.6 (12.), 125.2 (13.)
Trefferlage: 0.10 mm rechts, 0.43 mm hoch
Streuwert: 1.44, horizontal: 1.55, vertikal: 1.33

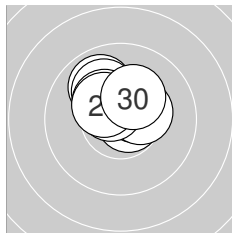

Serie 3: 103.5 (99)

10.7* →	9.9 ↘	10.4* ↘	10.1 ↘	10.5* ↗
10.3* ↘	10.4* ↗	10.6* ↘	10.4* ↘	10.2* ↑

beste Teiler: 54.2 (21.), 99.0 (28.), 115.9 (25.)
Trefferlage: 0.25 mm links, 1.08 mm hoch
Streuwert: 0.89, horizontal: 1.06, vertikal: 0.68

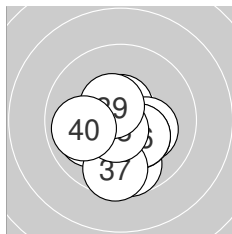

Serie 4: 101.8 (97)

10.6* ↑	9.7 ↓	10.0 ←	10.2* →	10.3* ↘
10.3* ↘	9.6 ↓	10.7* ↓	10.5* ↘	9.9 ←

beste Teiler: 73.8 (38.), 91.0 (31.), 114.0 (39.)
Trefferlage: 0.11 mm links, 0.96 mm tief
Streuwert: 1.40, horizontal: 1.40, vertikal: 1.40



Ergebnis: **416.5** (399)
 Serien: 104.0 103.5 104.6 104.4
 Zähler: 39 1 0 0 0 0 0 0 0 0
 Innenzehner: 33
 Weitester: 273 (37.), 245 (38.), 232 (13.)
 beste Teiler: 11.7 (17.), 49.0 (35.), 52.6 (32.)
 Trefferlage: 0.28 mm rechts, 0.28 mm tief
 Streuwert: 1.03, horizontal: 1.04, vertikal: 1.02

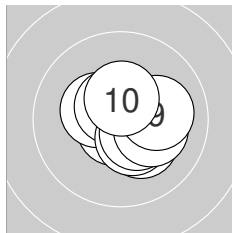
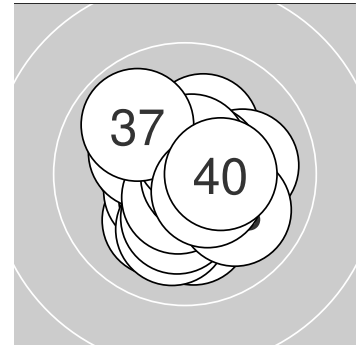

Serie 1: 104.0 (100)

10.2* ↘	10.7* ↙	10.5* →	10.4* ←	10.6* ↘
10.4* ↘	10.4* ↘	10.2* →	10.1 →	10.5* ↑

beste Teiler: 64.6 (2.), 92.6 (5.), 122.1 (3.)
 Trefferlage: 0.58 mm rechts, 0.16 mm tief
 Streuwert: 0.99, horizontal: 1.12, vertikal: 0.86

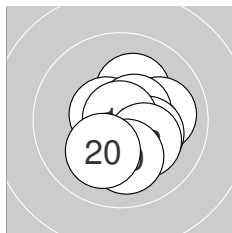

Serie 2: 103.5 (100)

10.2* ↑	10.5* ↘	10.0 →	10.6* ←	10.6* ↗
10.3* ↘	10.9* ↑	10.2* ↘	10.1 ↓	10.1 ↙

beste Teiler: 11.7 (17.), 91.0 (14.), 95.7 (15.)
 Trefferlage: 0.58 mm rechts, 0.38 mm tief
 Streuwert: 1.13, horizontal: 1.04, vertikal: 1.21

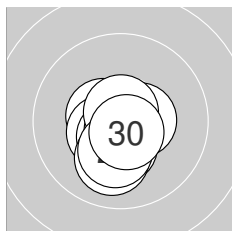

Serie 3: 104.6 (100)

10.5* ←	10.5* ↙	10.5* →	10.5* ↙	10.3* ↓
10.7* ↓	10.0 ↓	10.7* ↑	10.2* ↓	10.7* ↘

beste Teiler: 53.0 (28.), 57.3 (26.), 74.7 (30.)
 Trefferlage: 0.17 mm links, 0.73 mm tief
 Streuwert: 0.78, horizontal: 0.64, vertikal: 0.89

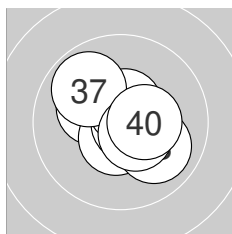

Serie 4: 104.4 (99)

10.7* ↑	10.7* ↗	10.2* ←	10.6* ↓	10.8* →
10.6* ↑	9.9 ↘	10.0 ↘	10.5* ↘	10.4* →

beste Teiler: 49.0 (35.), 52.6 (32.), 57.0 (31.)
 Trefferlage: 0.16 mm rechts, 0.15 mm hoch
 Streuwert: 1.12, horizontal: 1.22, vertikal: 1.01



Ergebnis: **411.3** (389)
 Serien: 102.3 102.5 103.2 103.3
 Zähler: 29 11 0 0 0 0 0 0 0 0
 Innenzehner: 24
 Weitest: 374 (7.), 331 (34.), 330 (12.)
 beste Teiler: 5.8 (24.), 6.7 (37.), 34.7 (32.)
 Trefferlage: 0.02 mm rechts, 0.11 mm hoch
 Streuwert: 1.40, horizontal: 1.65, vertikal: 1.09

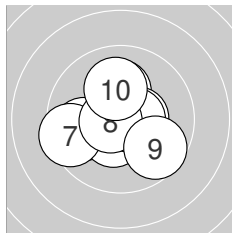
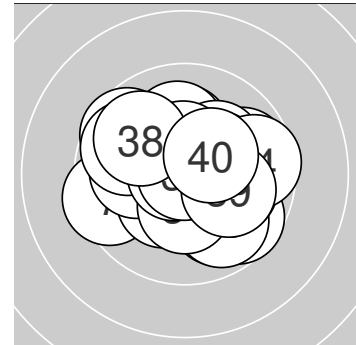

Serie 1: 102.3 (97)

9.9 ←	10.4* ↓	10.2* ↑	10.7* →	10.5* →
10.6* →	9.5 ←	10.7* ←	9.7 ↘	10.1 ↑

beste Teiler: 61.6 (4.), 72.5 (8.), 94.0 (6.)
 Trefferlage: 0.26 mm links, 0.10 mm tief
 Streuwert: 1.57, horizontal: 1.78, vertikal: 1.33

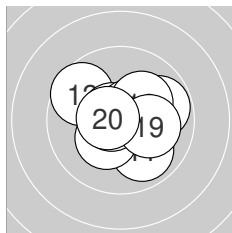

Serie 2: 102.5 (97)

9.9 ↘	9.6 ↖	9.8 →	10.3* ↓	10.7* ↖
10.6* ↗	10.7* ←	10.2* ↗	10.1 →	10.6* ←

beste Teiler: 64.1 (17.), 72.4 (15.), 91.9 (16.)
 Trefferlage: 0.24 mm rechts, 0.15 mm hoch
 Streuwert: 1.46, horizontal: 1.69, vertikal: 1.17

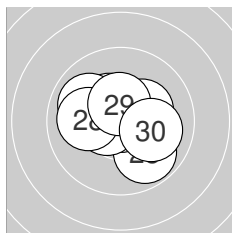

Serie 3: 103.2 (98)

10.4* ↖	10.7* →	9.8 ↘	10.9* ↗	10.3* ↗
9.9 ↖	10.6* ←	10.0 ←	10.5* ↑	10.1 →

beste Teiler: 5.8 (24.), 75.1 (22.), 97.8 (27.)
 Trefferlage: 0.02 mm links, 0.12 mm hoch
 Streuwert: 1.34, horizontal: 1.57, vertikal: 1.04

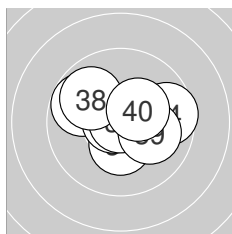

Serie 4: 103.3 (97)

10.3* ↓	10.8* →	9.8 ↖	9.6 →	10.8* ←
10.8* ↑	10.9* ↖	9.9 ↖	10.1 →	10.3* ↗

beste Teiler: 6.7 (37.), 34.7 (32.), 43.9 (36.)
 Trefferlage: 0.14 mm rechts, 0.27 mm hoch
 Streuwert: 1.42, horizontal: 1.77, vertikal: 0.93



Ergebnis: **421.0** (398)
 Serien: 104.7 104.6 105.9 105.8
 Zähler: 38 2 0 0 0 0 0 0 0 0
 Innenzehner: 37
 Weitestе: 280 (3.), 275 (14.), 237 (12.)
 beste Teiler: 17.2 (17.), 27.8 (35.), 38.3 (21.)
 Trefferlage: 0.07 mm links, 0.02 mm tief
 Streuwert: 0.88, horizontal: 1.06, vertikal: 0.67

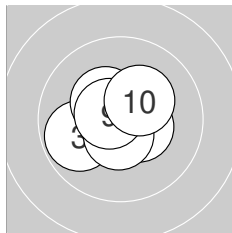
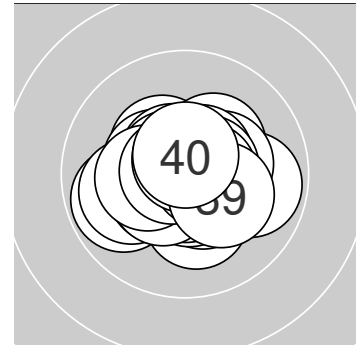

Serie 1: 104.7 (99)

10.7* ←	10.5* ←	9.8 ←	10.5* →	10.7* ↖
10.6* ↘	10.6* ↓	10.4* ↘	10.6* ↖	10.3* ↗

beste Teiler: 61.2 (1.), 72.9 (5.), 79.1 (9.)
 Trefferlage: 0.49 mm links, 0.12 mm hoch
 Streuwert: 0.95, horizontal: 1.10, vertikal: 0.78

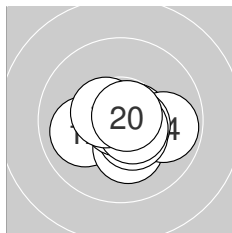

Serie 2: 104.6 (99)

10.6* →	10.0 ←	10.2* ↓	9.9 →	10.6* →
10.5* ↘	10.9* ←	10.6* ↘	10.5* ↖	10.8* ↗

beste Teiler: 17.2 (17.), 48.2 (20.), 84.5 (11.)
 Trefferlage: 0.35 mm rechts, 0.38 mm tief
 Streuwert: 1.03, horizontal: 1.30, vertikal: 0.66

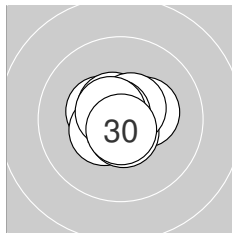

Serie 3: 105.9 (100)

10.8* ←	10.4* ↖	10.5* ↗	10.3* →	10.6* ↓
10.6* ↘	10.6* ↗	10.8* ↘	10.6* ↖	10.7* ↓

beste Teiler: 38.3 (21.), 46.0 (28.), 65.1 (30.)
 Trefferlage: 0.17 mm links, 0.10 mm hoch
 Streuwert: 0.72, horizontal: 0.82, vertikal: 0.60

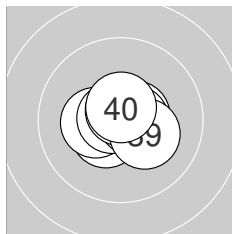

Serie 4: 105.8 (100)

10.8* ↘	10.6* →	10.5* ↗	10.3* ←	10.8* ↑
10.7* ←	10.6* →	10.7* ↑	10.2* →	10.6* ↑

beste Teiler: 27.8 (35.), 40.8 (31.), 55.5 (36.)
 Trefferlage: 0.00 mm, 0.06 mm hoch
 Streuwert: 0.76, horizontal: 0.92, vertikal: 0.55



Ergebnis: **408.1** (394)
 Serien: 100.5 101.1 102.2 104.3
 Zähler: 34 6 0 0 0 0 0 0 0 0
 Innenzehner: 25
 Weitest: 347 (4.), 334 (8.), 326 (11.)
 beste Teiler: 38.2 (34.), 46.8 (5.), 60.2 (36.)
 Trefferlage: 0.16 mm rechts, 0.32 mm hoch
 Streuwert: 1.43, horizontal: 1.53, vertikal: 1.32

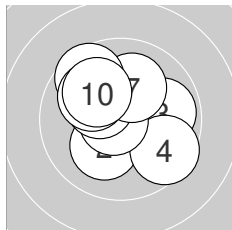
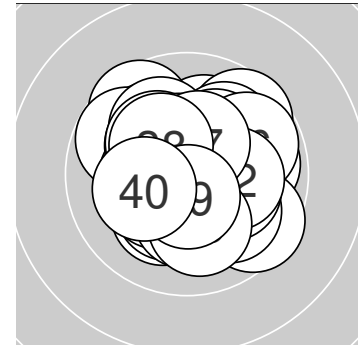

Serie 1: 100.5 (97)

10.0 →	10.2* ↙	9.9 →	9.6 ↘	10.8* ←
10.3* ↘	10.1 ↑	9.6 ↘	10.0 ↘	10.0 ↘

beste Teiler: 46.8 (5.), 167.4 (6.), 198.4 (2.)
 Trefferlage: 0.02 mm rechts, 0.51 mm hoch
 Streuwert: 1.76, horizontal: 1.94, vertikal: 1.57

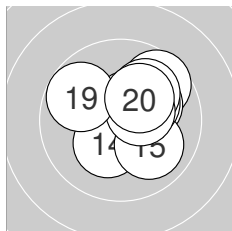

Serie 2: 101.1 (98)

9.6 ↗	10.1 ↗	10.5* ↗	10.3* ↙	10.0 ↘
10.2* ↗	10.0 ↗	10.4* ↗	9.8 ↘	10.2* ↗

beste Teiler: 109.1 (13.), 140.9 (18.), 169.6 (14.)
 Trefferlage: 0.87 mm rechts, 0.75 mm hoch
 Streuwert: 1.40, horizontal: 1.49, vertikal: 1.29

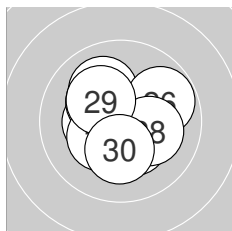

Serie 3: 102.2 (99)

10.1 ↘	10.3* ←	10.2* ↘	10.3* ↙	10.6* →
9.8 ↗	10.3* ↘	10.2* →	10.2* ↘	10.2* ↓

beste Teiler: 86.6 (25.), 153.6 (27.), 155.1 (22.)
 Trefferlage: 0.04 mm links, 0.08 mm hoch
 Streuwert: 1.40, horizontal: 1.49, vertikal: 1.30

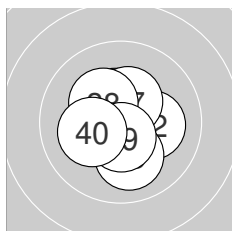

Serie 4: 104.3 (100)

10.4* ↑	10.2* →	10.6* ←	10.8* ←	10.1 ↓
10.7* ↙	10.4* ↑	10.3* ↘	10.6* ↓	10.2* ←

beste Teiler: 38.2 (34.), 60.2 (36.), 96.7 (33.)
 Trefferlage: 0.19 mm links, 0.05 mm tief
 Streuwert: 1.08, horizontal: 1.05, vertikal: 1.12



Ergebnis: **406.0** (388)
 Serien: 100.8 101.7 101.0 102.5
 Zähler: 28 12 0 0 0 0 0 0 0 0
 Innenzehner: 19
 Weitester: 410 (22.), 365 (8.), 359 (6.)
 beste Teiler: 19.1 (35.), 21.0 (31.), 24.1 (15.)
 Trefferlage: 0.82 mm rechts, 0.08 mm hoch
 Streuwert: 1.49, horizontal: 1.77, vertikal: 1.13

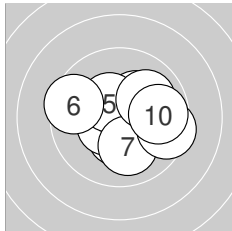
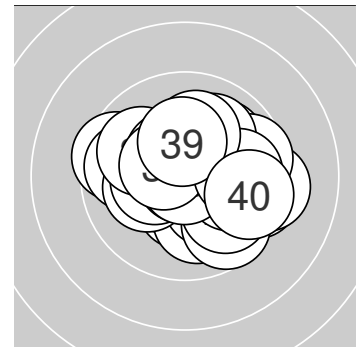

Serie 1: 100.8 (97)

10.4* ↓	10.4* ↘	10.2* ↗	10.5* ↖	10.4* ↗
9.5 ←	10.1 ↓	9.5 →	10.0 ↗	9.8 →

beste Teiler: 116.8 (4.), 135.3 (5.), 144.1 (1.)
 Trefferlage: 0.61 mm rechts, 0.09 mm tief
 Streuwert: 1.70, horizontal: 2.06, vertikal: 1.25

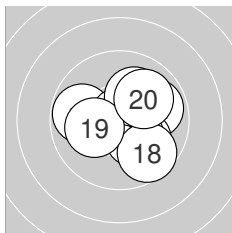

Serie 2: 101.7 (97)

9.8 ←	9.9 →	10.1 ↘	10.3* ↘	10.9* ↑
10.7* →	10.1 ↗	9.7 ↘	10.2* ↖	10.0 ↗

beste Teiler: 24.1 (15.), 55.7 (16.), 172.1 (14.)
 Trefferlage: 0.62 mm rechts, 0.06 mm tief
 Streuwert: 1.57, horizontal: 1.75, vertikal: 1.37

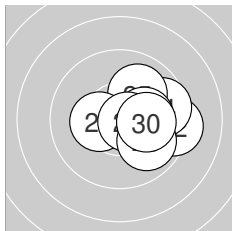

Serie 3: 101.0 (97)

10.4* →	9.3 →	10.5* →	9.6 →	10.0 ↗
10.3* ←	10.2* →	10.7* →	9.9 ↘	10.1 →

beste Teiler: 63.2 (28.), 123.6 (23.), 142.5 (21.)
 Trefferlage: 1.62 mm rechts, 0.01 mm hoch
 Streuwert: 1.24, horizontal: 1.49, vertikal: 0.92

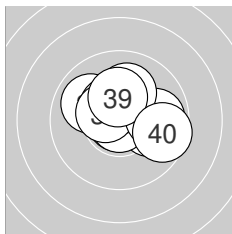

Serie 4: 102.5 (97)

10.9* ↖	9.9 ↖	10.0 →	10.4* ↖	10.9* ↓
10.5* ↖	9.9 →	10.1 ↑	10.3* ↑	9.6 →

beste Teiler: 19.1 (35.), 21.0 (31.), 120.3 (36.)
 Trefferlage: 0.43 mm rechts, 0.50 mm hoch
 Streuwert: 1.43, horizontal: 1.76, vertikal: 0.99



Ergebnis: 415.1 (396)
Serien: 103.1 105.2 102.8 104.0
Zähler: 36 4 0 0 0 0 0 0 0 0
Innenzehner: 32
Weiteste: 324 (28.), 288 (6.), 287 (2.)
beste Teiler: 49.9 (11.), 51.5 (38.), 52.3 (9.)
Trefferlage: 0.22 mm rechts, 0.05 mm hoch
Streuwert: 1.13, horizontal: 1.28, vertikal: 0.94

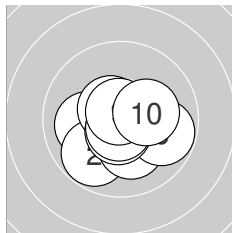
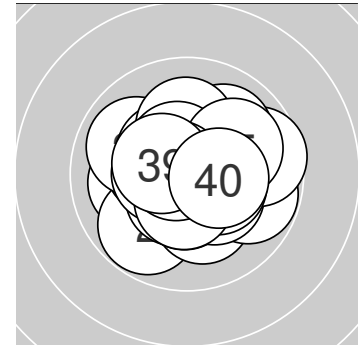

Serie 1: 103.1 (98)

10.1 ←	9.8 ↗	10.2* ↓	10.6* ↖	10.4* →
9.8 →	10.6* ↓	10.7* ↓	10.7* ↑	10.2* →

beste Teiler: 52.3 (9.), 58.0 (8.), 83.5 (7.)
Trefferlage: 0.15 mm rechts, 0.51 mm tief
Streuwert: 1.29, horizontal: 1.53, vertikal: 0.98

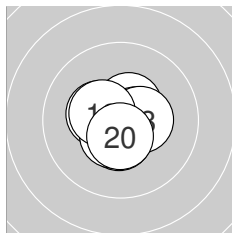

Serie 2: 105.2 (100)

10.8* →	10.5* ↗	10.7* ←	10.4* ←	10.5* →
10.5* ↓	10.5* ↘	10.4* →	10.4* ↖	10.5* ↓

beste Teiler: 49.9 (11.), 67.4 (13.), 102.0 (15.)
Trefferlage: 0.06 mm links, 0.13 mm tief
Streuwert: 0.82, horizontal: 0.92, vertikal: 0.72

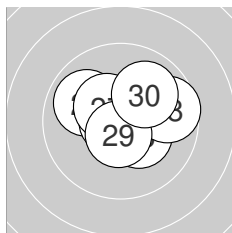

Serie 3: 102.8 (98)

9.9 ↖	10.5* →	10.4* ↗	10.3* ↗	10.3* ↘
10.7* ←	10.4* ↖	9.7 →	10.6* ↓	10.0 ↗

beste Teiler: 56.0 (26.), 89.1 (29.), 107.3 (22.)
Trefferlage: 0.56 mm rechts, 0.46 mm hoch
Streuwert: 1.27, horizontal: 1.54, vertikal: 0.91

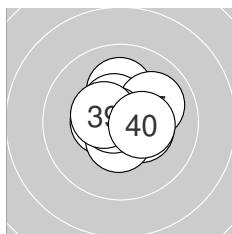

Serie 4: 104.0 (100)

10.1 ↑	10.5* ←	10.4* ↗	10.5* ↖	10.0 ↗
10.4* →	10.5* ↓	10.7* ↖	10.5* ↖	10.4* →

beste Teiler: 51.5 (38.), 111.0 (34.), 114.7 (37.)
Trefferlage: 0.27 mm rechts, 0.39 mm hoch
Streuwert: 1.05, horizontal: 1.16, vertikal: 0.92



Ergebnis: 409.8 (397)
Serien: 101.2 103.0 101.9 103.7
Zähler: 37 3 0 0 0 0 0 0 0 0 0
Innenzehner: 26
Weiteste: 326 (7.), 323 (36.), 256 (5.)
beste Teiler: 56.7 (32.), 57.6 (9.), 67.2 (16.)
Trefferlage: 0.22 mm rechts, 0.17 mm tief
Streuwert: 1.33, horizontal: 1.35, vertikal: 1.32

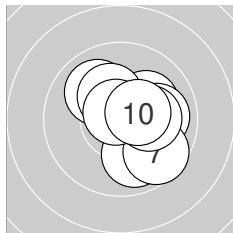
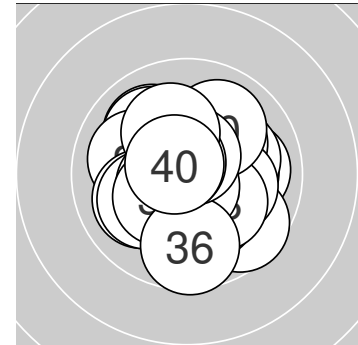

Serie 1: 101.2 (98)

10.1 ↗	10.0 ↘	10.0 →	10.0 →	9.9 ↓
10.3* ↘	9.6 ↘	10.2* →	10.7* ↘	10.4* ↗

beste Teiler: 57.6 (9.), 126.6 (10.), 171.3 (6.)
Trefferlage: 1.03 mm rechts, 0.11 mm hoch
Streuwert: 1.42, horizontal: 1.43, vertikal: 1.41

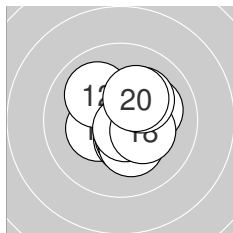

Serie 2: 103.0 (100)

10.3* ↖	10.0 ↘	10.4* ↓	10.5* ↓	10.3* ↓
10.7* ↓	10.1 →	10.3* ↘	10.2* ↗	10.2* ↗

beste Teiler: 67.2 (16.), 123.5 (14.), 135.3 (13.)
Trefferlage: 0.48 mm rechts, 0.05 mm tief
Streuwert: 1.23, horizontal: 1.19, vertikal: 1.26

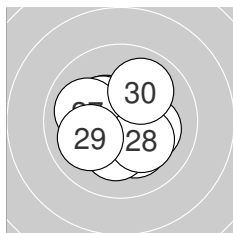

Serie 3: 101.9 (100)

10.2* ↓	10.4* ↘	10.4* ↘	10.2* →	10.3* ↓
10.2* ↓	10.0 ↖	10.2* ↓	10.0 ↖	10.0 ↗

beste Teiler: 133.9 (22.), 147.5 (23.), 162.6 (25.)
Trefferlage: 0.01 mm links, 0.31 mm tief
Streuwert: 1.44, horizontal: 1.55, vertikal: 1.32

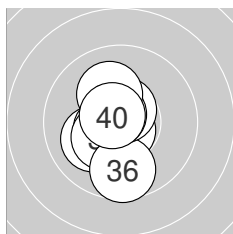

Serie 4: 103.7 (99)

10.3* ↓	10.7* ↓	10.1 ↖	10.5* ↖	10.3* ↖
9.7 ↓	10.6* ↑	10.7* ↘	10.1 ↘	10.7* ↘

beste Teiler: 56.7 (32.), 71.5 (38.), 72.0 (40.)
Trefferlage: 0.58 mm links, 0.42 mm tief
Streuwert: 1.11, horizontal: 0.64, vertikal: 1.44



LG 40 ZR

StandNr: 138

Kreisser, Christine #70402038

LG Seniorinnen 2 ST

Wertung

StartNr: 182

12.02.2023 14:04

SG_Bad-Häring

Ergebnis: **416.6** (396)
 Serien: 104.2 105.0 103.8 103.6
 Zähler: 36 4 0 0 0 0 0 0 0 0
 Innenzehner: 34
 Weitestе: 346 (40.), 303 (7.), 282 (36.)
 beste Teiler: 32.0 (6.), 32.1 (15.), 41.6 (18.)
 Trefferlage: 0.21 mm rechts, 0.09 mm hoch
 Streuwert: 1.08, horizontal: 1.16, vertikal: 1.00

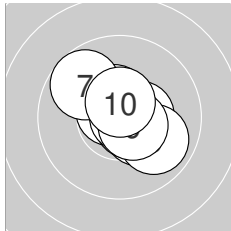
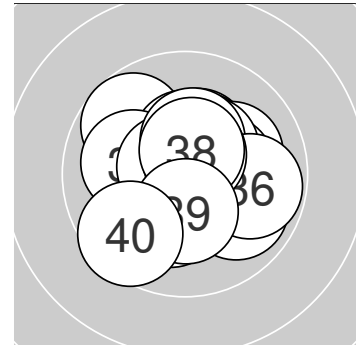
**Serie 1: 104.2 (98)**

10.5* ↑	10.7* ↘	10.3* ↘	10.7* ↘	10.4* →
10.8* →	9.7 ↘	9.9 ↘	10.6* ↘	10.6* ↑

beste Teiler: 32.0 (6.), 69.4 (2.), 75.4 (4.)
 Trefferlage: 0.34 mm rechts, 0.14 mm hoch
 Streuwert: 1.13, horizontal: 1.22, vertikal: 1.04

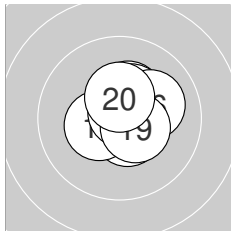
**Serie 2: 105.0 (100)**

10.3* ↑	10.6* ↘	10.7* ↑	10.4* ↑	10.8* ←
10.1 →	10.4* ←	10.8* ↑	10.5* ↘	10.4* ↑

beste Teiler: 32.1 (15.), 41.6 (18.), 65.9 (13.)
 Trefferlage: 0.35 mm rechts, 0.38 mm hoch
 Streuwert: 0.85, horizontal: 0.86, vertikal: 0.85

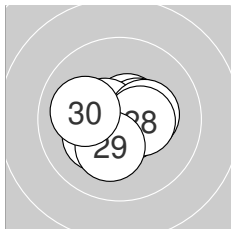
**Serie 3: 103.8 (100)**

10.6* ↑	10.3* ↙	10.5* →	10.2* ↙	10.7* ↘
10.6* ↖	10.3* →	10.4* →	10.2* ↓	10.0 ←

beste Teiler: 70.2 (25.), 83.0 (21.), 100.4 (26.)
 Trefferlage: 0.12 mm links, 0.20 mm tief
 Streuwert: 1.10, horizontal: 1.32, vertikal: 0.81

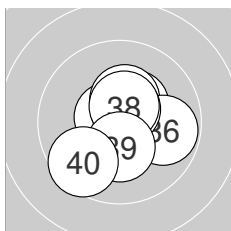
**Serie 4: 103.6 (98)**

10.7* ↑	10.4* ↑	10.6* →	10.7* ↖	10.4* ↑
9.8 →	10.6* ↑	10.5* ↑	10.3* ↓	9.6 ↙

beste Teiler: 74.2 (34.), 74.7 (31.), 90.7 (33.)
 Trefferlage: 0.29 mm rechts, 0.04 mm hoch
 Streuwert: 1.29, horizontal: 1.28, vertikal: 1.29



Ergebnis: 194.3 (184)
Serien: 99.8 94.5
Zähler: 10 6 2 2 0 0 0 0 0 0 0
Innenzehner: 5
Weiteste: 831 (19.), 776 (13.), 610 (2.)
beste Teiler: 13.1 (10.), 55.4 (16.), 91.4 (15.)
Trefferlage: 0.24 mm links, 0.15 mm tief
Streuwert: 2.73, horizontal: 3.36, vertikal: 1.89

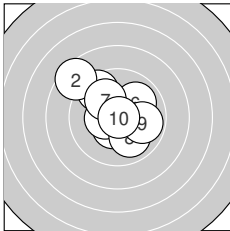
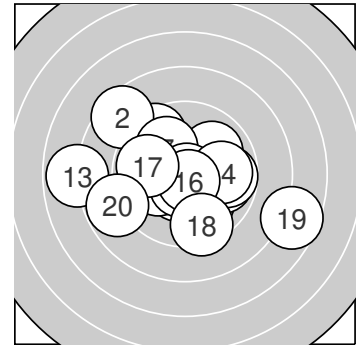

Serie 1: 99.8 (96)

9.5 ↖ 8.5 ↖ 10.1 ↗
 10.0 ↗ 10.0 ↖ 10.0 ↘
beste Teiler: 13.1 (10.), 125.8 (4.), 135.4 (5.)
Trefferlage: 0.20 mm links, 0.76 mm hoch
Streuwert: 2.06, horizontal: 2.21, vertikal: 1.90

10.5* ↓ 10.4* ←
 9.9 → 10.9* →

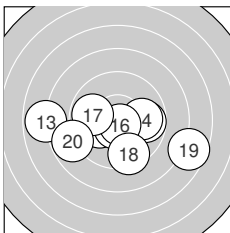

Serie 2: 94.5 (88)

10.1 ← 9.8 → 7.8 ←
 10.7* ↓ 9.8 ← 9.4 ↓
beste Teiler: 55.4 (16.), 91.4 (15.), 207.4 (11.)
Trefferlage: 0.27 mm links, 1.07 mm tief
Streuwert: 3.25, horizontal: 4.36, vertikal: 1.44

9.9 → 10.6* ↓
 7.6 → 8.8 ←



Ergebnis: **207.0** (196)
 Serien: 105.0 102.0
 Zähler: 16 4 0 0 0 0 0 0 0 0 0
 Innenzehner: 15
 Weitestе: 363 (17.), 328 (14.), 295 (10.)
 beste Teiler: 41.6 (7.), 44.9 (16.), 47.7 (18.)
 Trefferlage: 0.06 mm links, 0.32 mm tief
 Streuwert: 1.29, horizontal: 1.55, vertikal: 0.97

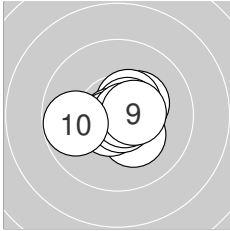
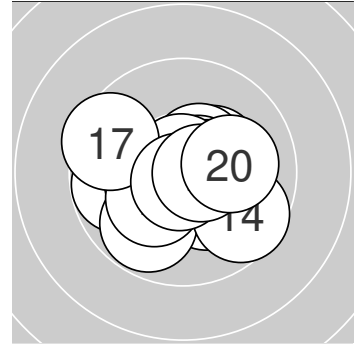

Serie 1: 105.0 (99)

10.3* ↗	10.3* ↘	10.5* ↗	10.6* ↗	10.8* ↙
10.6* ↙	10.8* ↘	10.8* →	10.5* →	9.8 ←

beste Teiler: 41.6 (7.), 48.7 (5.), 50.0 (8.)
 Trefferlage: 0.19 mm rechts, 0.09 mm tief
 Streuwert: 1.01, horizontal: 1.25, vertikal: 0.70

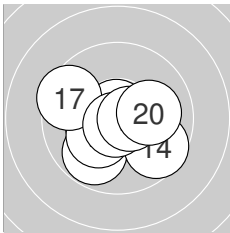

Serie 2: 102.0 (97)

10.2* ↙	9.8 ↙	10.4* ←	9.6 ↘	10.2* ↙
10.8* ↑	9.5 ↖	10.8* ↓	10.6* →	10.1 →

beste Teiler: 44.9 (16.), 47.7 (18.), 83.0 (19.)
 Trefferlage: 0.33 mm links, 0.56 mm tief
 Streuwert: 1.53, horizontal: 1.83, vertikal: 1.17



Ergebnis: **203.6** (194)
 Serien: 101.6 102.0
 Zähler: 14 6 0 0 0 0 0 0 0 0 0
 Innenzehner: 12
 Weitestе: 465 (15.), 328 (1.), 323 (7.)
 beste Teiler: 3.1 (5.), 33.0 (18.), 78.6 (10.)
 Trefferlage: 0.30 mm links, 0.46 mm hoch
 Streuwert: 1.55, horizontal: 1.93, vertikal: 1.05

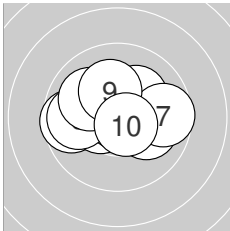
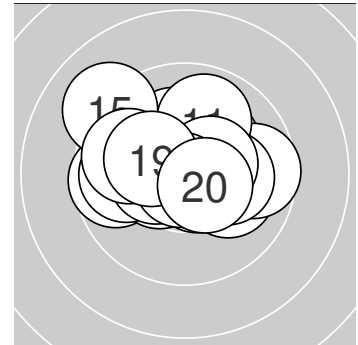

Serie 1: 101.6 (97)

9.6 ←	10.5* ←	10.2* ↗	10.1 →	10.9* ↓
9.8 ←	9.7 →	10.0 ↘	10.2* ↑	10.6* ↘

beste Teiler: 3.1 (5.), 78.6 (10.), 124.4 (2.)
 Trefferlage: 0.25 mm links, 0.27 mm hoch
 Streuwert: 1.62, horizontal: 2.11, vertikal: 0.91

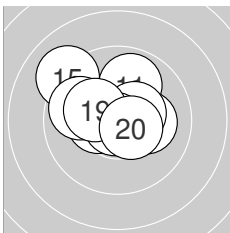

Serie 2: 102.0 (97)

9.9 ↑	10.2* →	10.6* →	10.4* ←	9.1 ↘
10.4* →	9.8 ←	10.8* ↙	10.3* ↖	10.5* ↘

beste Teiler: 33.0 (18.), 88.4 (13.), 108.7 (20.)
 Trefferlage: 0.34 mm links, 0.66 mm hoch
 Streuwert: 1.55, horizontal: 1.84, vertikal: 1.20

