

Ergebnis: **208.4** (197)
 Serien: 103.8 104.6
 Zähler: 17 3 0 0 0 0 0 0 0 0 0
 Innenzehner: 17
 Weitesten: 329 (10.), 290 (13.), 261 (4.)
 beste Teiler: 31.5 (20.), 36.4 (5.), 54.7 (14.)
 Trefferlage: 0.35 mm rechts, 0.28 mm tief
 Streuwert: 1.07, horizontal: 1.21, vertikal: 0.91

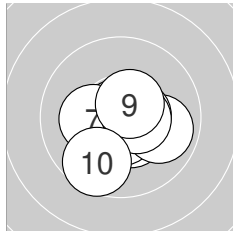
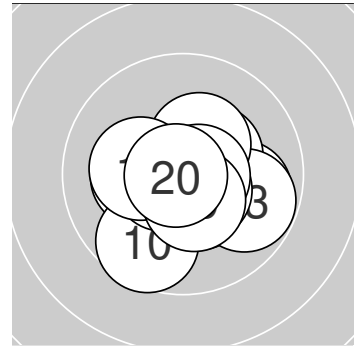

Serie 1: 103.8 (98)

10.5* ↘	10.6* ↓	10.7* →	9.9 →	10.8* ↖
10.5* →	10.2* ←	10.5* →	10.5* ↗	9.6 ↙

beste Teiler: 36.4 (5.), 72.8 (3.), 89.6 (2.)
 Trefferlage: 0.30 mm rechts, 0.43 mm tief
 Streuwert: 1.17, horizontal: 1.27, vertikal: 1.05

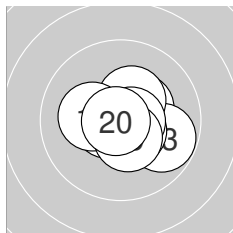

Serie 2: 104.6 (99)

10.4* ↗	10.6* ←	9.8 →	10.7* ↘	10.4* ↗
10.5* ↘	10.7* →	10.2* ←	10.5* ↘	10.8* ←

beste Teiler: 31.5 (20.), 54.7 (14.), 68.4 (17.)
 Trefferlage: 0.40 mm rechts, 0.12 mm tief
 Streuwert: 1.02, horizontal: 1.21, vertikal: 0.77



Ergebnis: 203.5 (193)
Serien: 100.3 103.2
Zähler: 15 3 2 0 0 0 0 0 0 0 0
Innenzehner: 13
Weiteste: 636 (1.), 539 (7.), 312 (12.)
beste Teiler: 19.1 (16.), 40.1 (13.), 52.0 (4.)
Trefferlage: 0.78 mm links, 0.81 mm hoch
Streuwert: 1.62, horizontal: 1.79, vertikal: 1.43

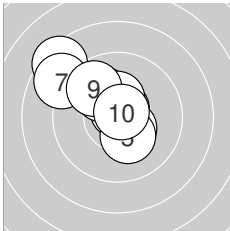
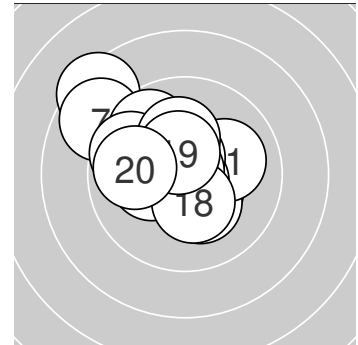

Serie 1: 100.3 (95)

8.4 ↘	10.7* ↗	10.4* ↘	10.7* ↑	10.3* ↘
10.1 ↘	8.8 ↘	10.4* ↑	9.8 ↘	10.7* ↗

beste Teiler: 52.0 (4.), 52.2 (10.), 74.2 (2.)
Trefferlage: 1.00 mm links, 1.21 mm hoch
Streuwert: 1.93, horizontal: 2.09, vertikal: 1.75

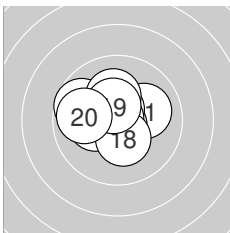

Serie 2: 103.2 (98)

10.1 →	9.7 ↘	10.8* ↓	10.6* ↑	10.2* ↑
10.9* ↘	10.2* ←	10.3* ↓	10.5* ↑	9.9 ←

beste Teiler: 19.1 (16.), 40.1 (13.), 88.3 (14.)
Trefferlage: 0.56 mm links, 0.42 mm hoch
Streuwert: 1.27, horizontal: 1.52, vertikal: 0.96



Ergebnis: **200.9** (192)
 Serien: 98.6 102.3
 Zähler: 14 4 2 0 0 0 0 0 0 0
 Innenzehner: 10
 Weitestе: 644 (19.), 528 (2.), 422 (7.)
 beste Teiler: 13.0 (11.), 39.5 (15.), 62.3 (16.)
 Trefferlage: 0.73 mm links, 0.13 mm hoch
 Streuwert: 1.94, horizontal: 2.39, vertikal: 1.35

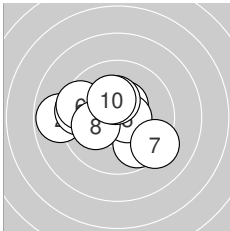
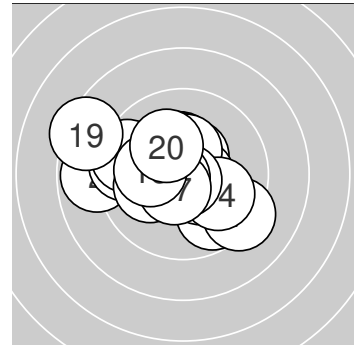

Serie 1: 98.6 (94)

10.5* ↗	8.8 ←	9.5 ←	9.7 ↘	10.6* →
9.5 ←	9.3 ↘	10.1 ←	10.3* ↑	10.3* ↑

beste Teiler: 91.5 (5.), 123.4 (1.), 158.9 (9.)
 Trefferlage: 0.82 mm links, 0.02 mm hoch
 Streuwert: 2.19, horizontal: 2.71, vertikal: 1.50

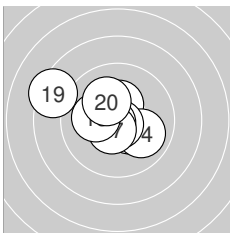

Serie 2: 102.3 (98)

10.9* ↗	10.4* ↘	10.4* ↑	10.0 ↘	10.8* ↘
10.7* ←	10.5* ↙	10.1 ←	8.4 ←	10.1 ↖

beste Teiler: 13.0 (11.), 39.5 (15.), 62.3 (16.)
 Trefferlage: 0.64 mm links, 0.24 mm hoch
 Streuwert: 1.77, horizontal: 2.18, vertikal: 1.24



Ergebnis: 192.7 (183)
Serien: 96.2 96.5
Zähler: 9 5 6 0 0 0 0 0 0 0 0
Innenzehner: 5
Weiteste: 657 (4.), 603 (13.), 560 (7.)
beste Teiler: 16.4 (5.), 125.9 (14.), 134.4 (2.)
Trefferlage: 0.70 mm links, 1.31 mm hoch
Streuwert: 2.50, horizontal: 3.15, vertikal: 1.61

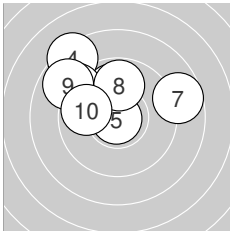
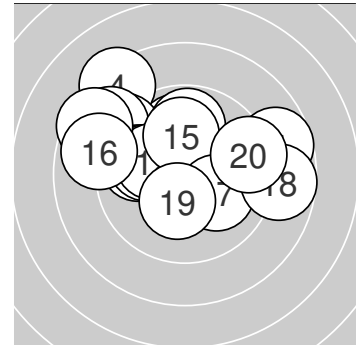

Serie 1: 96.2 (90)

9.9 ↑	10.4* ↖	10.3* ↘	8.3 ↖	10.9* ↙
9.2 ↘	8.7 →	9.8 ↑	8.9 ↘	9.8 ←

beste Teiler: 16.4 (5.), 134.4 (2.), 156.1 (3.)
Trefferlage: 1.12 mm links, 2.07 mm hoch
Streuwert: 2.27, horizontal: 2.85, vertikal: 1.48

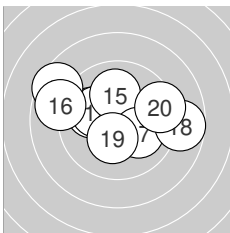

Serie 2: 96.5 (93)

10.0 ←	10.1 ↖	8.5 ↘	10.5* →	10.0 ↑
8.9 ←	10.1 ↘	8.7 →	10.3* ↓	9.4 →

beste Teiler: 125.9 (14.), 165.2 (19.), 202.0 (12.)
Trefferlage: 0.28 mm links, 0.55 mm hoch
Streuwert: 2.69, horizontal: 3.53, vertikal: 1.43



Ergebnis: **200.9** (190)
 Serien: 101.1 99.8
 Zähler: 12 6 2 0 0 0 0 0 0 0
 Innenzehner: 10
 Weitestе: 596 (20.), 515 (2.), 359 (18.)
 beste Teiler: 82.0 (14.), 94.0 (4.), 97.7 (13.)
 Trefferlage: 0.22 mm rechts, 0.12 mm hoch
 Streuwert: 1.94, horizontal: 2.47, vertikal: 1.20

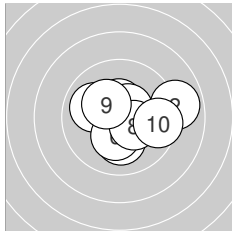
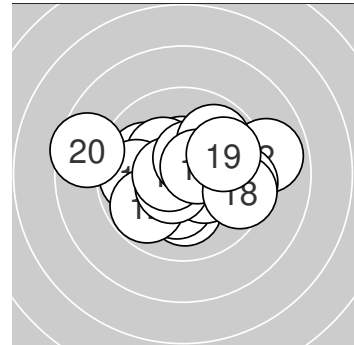

Serie 1: 101.1 (97)

10.0 ↖	8.9 →	10.1 ↓	10.6* →	10.5* ↑
10.3* ↓	10.5* ↗	10.4* ↘	10.3* ↖	9.5 →

beste Teiler: 94.0 (4.), 108.9 (7.), 124.1 (5.)
 Trefferlage: 0.76 mm rechts, 0.01 mm hoch
 Streuwert: 1.75, horizontal: 2.15, vertikal: 1.23

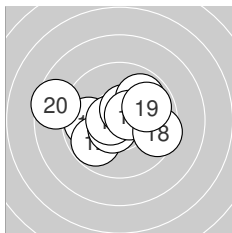

Serie 2: 99.8 (93)

9.8 ←	9.8 ↙	10.6* ↘	10.6* ←	10.5* ↗
9.9 ↗	10.6* ↗	9.5 →	9.9 ↗	8.6 ←

beste Teiler: 82.0 (14.), 97.7 (13.), 98.4 (17.)
 Trefferlage: 0.31 mm links, 0.22 mm hoch
 Streuwert: 2.13, horizontal: 2.76, vertikal: 1.22



Ergebnis: **199.5** (189)
 Serien: 98.6 100.9
 Zähler: 10 9 1 0 0 0 0 0 0 0
 Innenzehner: 7
 Weitestе: 636 (4.), 470 (13.), 406 (20.)
 beste Teiler: 43.6 (14.), 49.7 (18.), 97.5 (2.)
 Trefferlage: 0.36 mm rechts, 0.49 mm tief
 Streuwert: 2.02, horizontal: 2.38, vertikal: 1.59

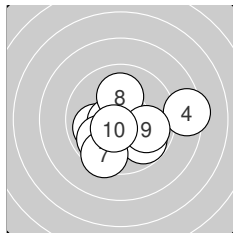
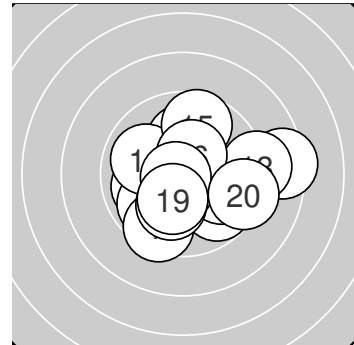

Serie 1: 98.6 (93)

10.0 ← 10.6* ← 9.9 ↘
 9.9 ↙ 9.5 ↘ 10.1 ↑
 beste Teiler: 97.5 (2.), 108.8 (10.), 217.0 (8.)
 Trefferlage: 0.22 mm rechts, 0.94 mm tief
 Streuwert: 2.20, horizontal: 2.68, vertikal: 1.58

8.4 → 9.8 ↘
 9.9 → 10.5* ↘

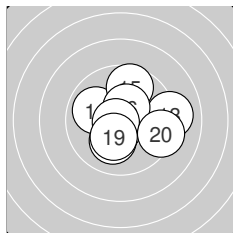

Serie 2: 100.9 (96)

9.9 ↘ 10.5* ↘ 9.1 →
 10.4* ↑ 10.1 ↘ 10.8* ←
 beste Teiler: 43.6 (14.), 49.7 (18.), 102.4 (12.)
 Trefferlage: 0.50 mm rechts, 0.04 mm tief
 Streuwert: 1.88, horizontal: 2.17, vertikal: 1.54

10.8* ← 9.7 ↑
 10.3* ↘ 9.3 →



Ergebnis: **197.9** (189)
 Serien: 100.1 97.8
 Zähler: 11 7 2 0 0 0 0 0 0 0
 Innenzehner: 8
 Weitester: 506 (3.), 506 (17.), 440 (13.)
 beste Teiler: 15.2 (1.), 89.6 (5.), 118.1 (12.)
 Trefferlage: 0.36 mm rechts, 1.02 mm hoch
 Streuwert: 2.01, horizontal: 2.42, vertikal: 1.50

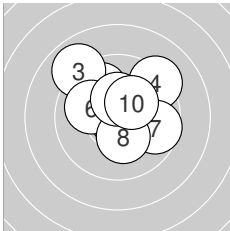
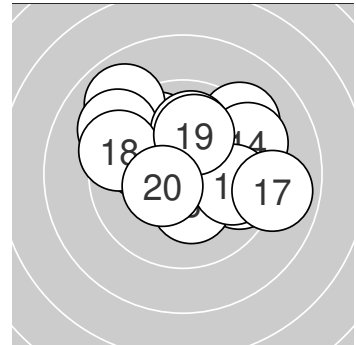

Serie 1: 100.1 (95)

10.9* ↙	9.9 ↖	8.9 ↘	9.2 ↗	10.6* →
10.0 ↖	9.7 →	10.3* ↓	10.3* ↑	10.3* ↗

beste Teiler: 15.2 (1.), 89.6 (5.), 151.0 (9.)
 Trefferlage: 0.18 mm rechts, 1.00 mm hoch
 Streuwert: 1.91, horizontal: 2.09, vertikal: 1.72

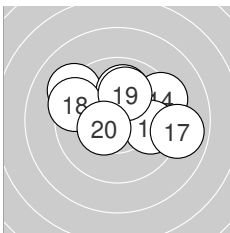

Serie 2: 97.8 (94)

10.2* ↑	10.5* ↗	9.2 ↘	9.4 ↗	10.0 ↑
9.8 →	8.9 →	9.4 ↖	10.0 ↑	10.4* ↙

beste Teiler: 118.1 (12.), 131.7 (20.), 194.8 (11.)
 Trefferlage: 0.54 mm rechts, 1.05 mm hoch
 Streuwert: 2.20, horizontal: 2.81, vertikal: 1.34



Ergebnis: **206.5** (197)
 Serien: 103.0 103.5
 Zähler: 17 3 0 0 0 0 0 0 0 0 0
 Innenzehner: 16
 Weitestе: 350 (5.), 295 (19.), 278 (16.)
 beste Teiler: 65.2 (15.), 83.2 (4.), 84.5 (18.)
 Trefferlage: 0.68 mm rechts, 0.39 mm hoch
 Streuwert: 1.13, horizontal: 1.17, vertikal: 1.10

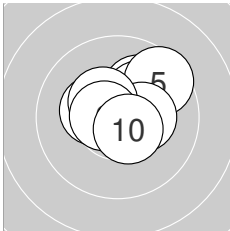
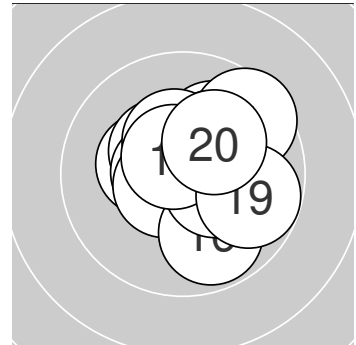

Serie 1: 103.0 (99)

10.4* ↗	10.1 ↗	10.2* ↗	10.6* →	9.6 ↗
10.3* ←	10.3* →	10.4* ↘	10.6* ←	10.5* ↘

beste Teiler: 83.2 (4.), 86.4 (9.), 101.9 (10.)
 Trefferlage: 0.59 mm rechts, 0.73 mm hoch
 Streuwert: 1.13, horizontal: 1.31, vertikal: 0.93

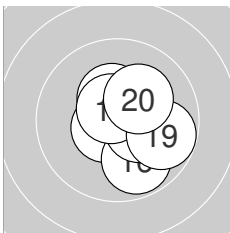

Serie 2: 103.5 (98)

10.6* ↖	10.4* →	10.6* ↗	10.4* ↑	10.7* ↗
9.8 ↘	10.4* ↘	10.6* ↘	9.8 →	10.2* ↗

beste Teiler: 65.2 (15.), 84.5 (18.), 89.8 (11.)
 Trefferlage: 0.77 mm rechts, 0.05 mm hoch
 Streuwert: 1.14, horizontal: 1.08, vertikal: 1.19



Ergebnis: **193.2** (184)
 Serien: 96.2 97.0
 Zähler: 9 7 3 1 0 0 0 0 0 0 0
 Innenzehner: 7
 Weitestе: 893 (3.), 674 (18.), 575 (13.)
 beste Teiler: 97.0 (17.), 100.6 (8.), 121.6 (7.)
 Trefferlage: 0.90 mm links, 0.20 mm hoch
 Streuwert: 2.72, horizontal: 3.02, vertikal: 2.38

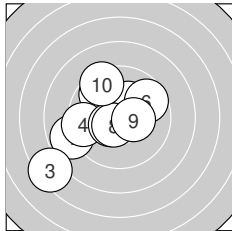
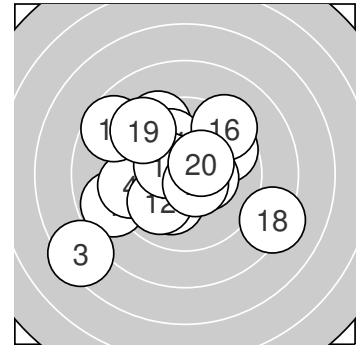

Serie 1: 96.2 (91)

8.8 ↙ 9.7 ↘ 7.4 ↙ 9.4 ↙ 10.3* ↗
 9.7 ↗ 10.5* ↗ 10.6* ↙ 10.4* → 9.4 ↘
 beste Teiler: 100.6 (8.), 121.6 (7.), 144.1 (9.)
 Trefferlage: 1.59 mm links, 0.11 mm tief
 Streuwert: 2.77, horizontal: 3.00, vertikal: 2.52

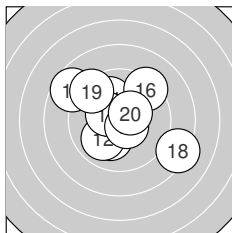

Serie 2: 97.0 (93)

10.1 ↙ 9.9 ↙ 8.7 ↘ 10.0 ↘ 10.4* ↘
 9.3 ↗ 10.6* ↘ 8.3 ↘ 9.3 ↘ 10.4* ↗
 beste Teiler: 97.0 (17.), 132.5 (20.), 139.0 (15.)
 Trefferlage: 0.21 mm links, 0.52 mm hoch
 Streuwert: 2.70, horizontal: 3.02, vertikal: 2.33



Ergebnis: **199.2** (191)
 Serien: 100.3 98.9
 Zähler: 13 5 2 0 0 0 0 0 0 0
 Innenzehner: 9
 Weitesten: 638 (17.), 539 (3.), 414 (12.)
 beste Teiler: 36.8 (18.), 125.3 (16.), 128.7 (8.)
 Trefferlage: 0.78 mm rechts, 0.27 mm tief
 Streuwert: 1.97, horizontal: 2.54, vertikal: 1.13

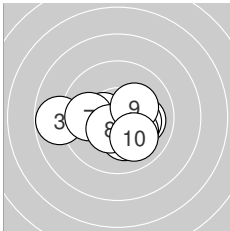
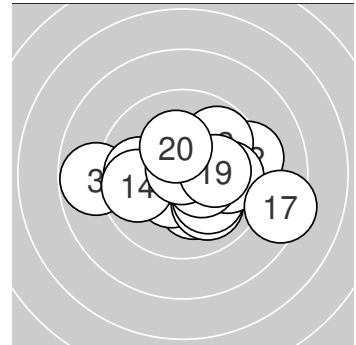

Serie 1: 100.3 (97)

10.2* ↓	10.1 →	8.8 ←	10.4* ←	10.2* →
10.1 ↘	9.9 ←	10.4* ↙	10.2* ↗	10.0 ↘

beste Teiler: 128.7 (8.), 133.0 (4.), 182.1 (9.)
 Trefferlage: 0.07 mm links, 0.59 mm tief
 Streuwert: 1.85, horizontal: 2.46, vertikal: 0.89

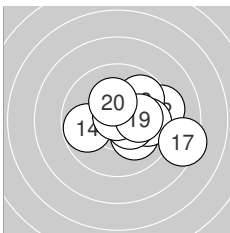

Serie 2: 98.9 (94)

10.1 ↘	9.3 →	9.8 ↗	9.8 ←	9.8 →
10.5* →	8.4 →	10.8* ↑	10.2* →	10.2* ↑

beste Teiler: 36.8 (18.), 125.3 (16.), 176.5 (20.)
 Trefferlage: 1.63 mm rechts, 0.04 mm hoch
 Streuwert: 1.96, horizontal: 2.45, vertikal: 1.29



Ergebnis: **195.3** (187)
 Serien: 99.1 96.2
 Zähler: 9 9 2 0 0 0 0 0 0 0 0
 Innenzehner: 5
 Weitester: 641 (6.), 503 (12.), 416 (11.)
 beste Teiler: 142.1 (14.), 161.9 (8.), 182.1 (20.)
 Trefferlage: 0.75 mm links, 0.21 mm hoch
 Streuwert: 2.27, horizontal: 2.71, vertikal: 1.72

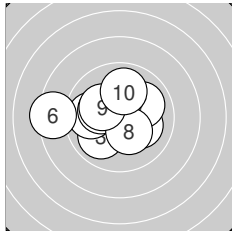
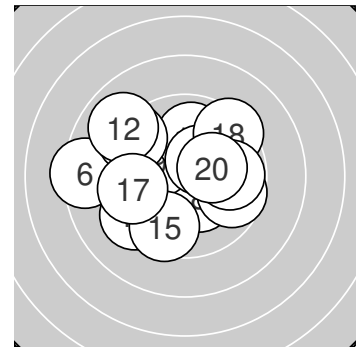

Serie 1: 99.1 (96)

10.1 ← 10.1 → 10.0 ↙
 8.4 ← 10.0 ↗ 10.3* ↘
 beste Teiler: 161.9 (8.), 190.4 (5.), 191.7 (9.)
 Trefferlage: 1.12 mm links, 0.19 mm hoch
 Streuwert: 2.02, horizontal: 2.56, vertikal: 1.25

9.9 ← 10.2* ↖
 10.2* ↖ 9.9 ↑

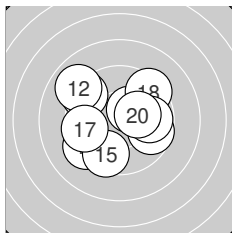

Serie 2: 96.2 (91)

9.3 ↘ 8.9 ↘ 9.3 ↙
 9.7 → 9.6 ← 9.4 ↗
 beste Teiler: 142.1 (14.), 182.1 (20.), 287.1 (19.)
 Trefferlage: 0.38 mm links, 0.23 mm hoch
 Streuwert: 2.59, horizontal: 2.95, vertikal: 2.17

10.4* ↗ 9.6 ↓
 9.8 → 10.2* →



Ergebnis: 183.6 (175)
Serien: 97.2 86.4
Zähler: 7 8 2 1 0 2 0 0 0 0 0
Innenzehner: 3
Weiteste: 1498 (20.), 1284 (11.), 920 (12.)
beste Teiler: 49.2 (16.), 81.3 (2.), 176.4 (7.)
Trefferlage: 1.89 mm links, 0.09 mm hoch
Streuwert: 3.94, horizontal: 4.98, vertikal: 2.49

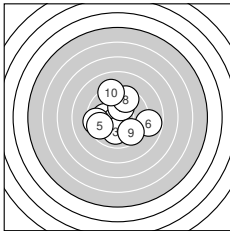
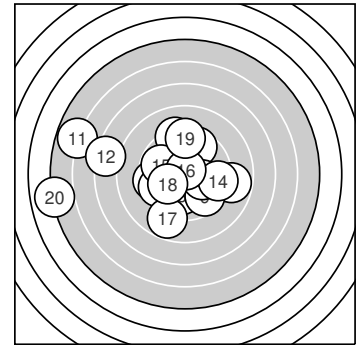

Serie 1: 97.2 (93)

10.1 ← 10.6* ↙ 10.0 ↓
 8.8 → 10.2* ↑ 9.6 ↗
beste Teiler: 81.3 (2.), 176.4 (7.), 214.1 (1.)
Trefferlage: 0.12 mm links, 0.03 mm hoch
Streuwert: 2.46, horizontal: 2.65, vertikal: 2.25

9.5 ← 9.6 ←
 9.6 ↘ 9.2 ↑

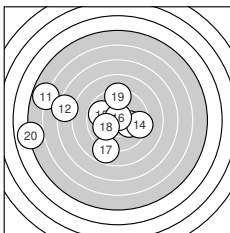

Serie 2: 86.4 (82)

5.8 ← 7.3 ← 10.1 →
 10.8* ↑ 8.8 ↙ 10.1 ←
beste Teiler: 49.2 (16.), 207.1 (13.), 225.2 (18.)
Trefferlage: 3.67 mm links, 0.15 mm hoch
Streuwert: 4.81, horizontal: 6.19, vertikal: 2.83

9.4 → 9.8 ←
 9.3 ↑ 5.0 ←



Ergebnis: **192.2** (181)
 Serien: 98.4 93.8
 Zähler: 5 13 1 0 1 0 0 0 0 0 0
 Innenzehner: 4
 Weitesten: 1062 (18.), 524 (17.), 412 (2.)
 beste Teiler: 69.6 (10.), 135.2 (12.), 156.0 (5.)
 Trefferlage: 1.05 mm rechts, 0.89 mm tief
 Streuwert: 2.64, horizontal: 3.42, vertikal: 1.48

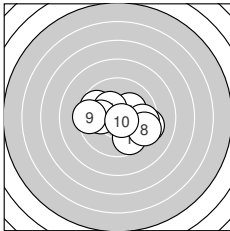
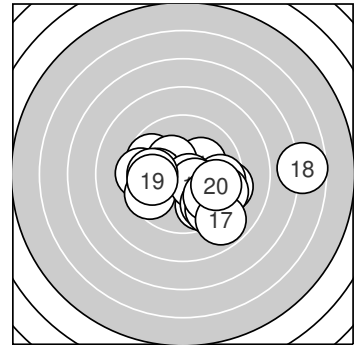

Serie 1: 98.4 (94)

9.7 ↘ 9.3 → 9.7 ↙ 10.2* ↗ 10.3* ↖
 9.6 → 10.1 ← 9.4 → 9.4 ← 10.7* ↘

beste Teiler: 69.6 (10.), 156.0 (5.), 188.3 (4.)
 Trefferlage: 0.47 mm rechts, 0.26 mm tief
 Streuwert: 2.18, horizontal: 2.80, vertikal: 1.29

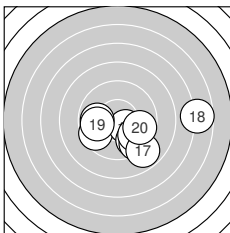

Serie 2: 93.8 (87)

9.6 ↙ 10.4* ↘ 9.6 ↘ 9.4 ↘ 9.8 ↘
 9.9 ← 8.9 ↘ 6.7 → 9.8 ← 9.7 →

beste Teiler: 135.2 (12.), 272.0 (16.), 276.5 (19.)
 Trefferlage: 1.63 mm rechts, 1.52 mm tief
 Streuwert: 3.02, horizontal: 4.02, vertikal: 1.44



Ergebnis: **174.5** (166)
 Serien: 91.8 82.7
 Zähler: 1 8 7 4 0 0 0 0 0 0 0
 Innenzehner: 1
 Weitester: 877 (13.), 851 (19.), 811 (15.)
 beste Teiler: 81.8 (8.), 292.1 (6.), 323.6 (2.)
 Trefferlage: 3.01 mm links, 2.94 mm tief
 Streuwert: 3.04, horizontal: 2.47, vertikal: 3.52

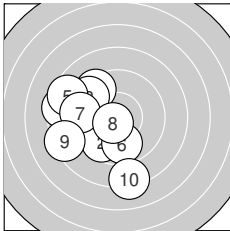
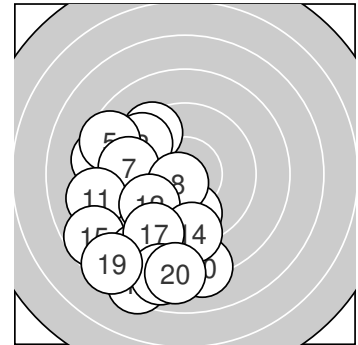

Serie 1: 91.8 (87)

9.4 ↘ 9.7 ↙ 9.4 ↘
 9.8 ↓ 9.3 ← 10.6* ↙

8.5 ← 8.5 ↘
 8.4 ← 8.2 ↓

beste Teiler: 81.8 (8.), 292.1 (6.), 323.6 (2.)
 Trefferlage: 2.77 mm links, 0.63 mm tief
 Streuwert: 2.90, horizontal: 2.67, vertikal: 3.12

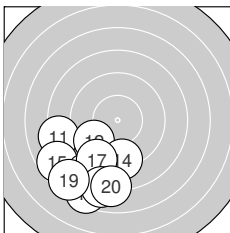

Serie 2: 82.7 (79)

8.2 ← 9.6 ↙ 7.4 ↓
 8.2 ↙ 9.0 ↙ 7.9 ↓

9.2 ↓ 7.7 ↙
 7.5 ↙ 8.0 ↓

beste Teiler: 345.3 (12.), 435.8 (14.), 493.4 (17.)
 Trefferlage: 3.24 mm links, 5.25 mm tief
 Streuwert: 2.27, horizontal: 2.38, vertikal: 2.16



Ergebnis: **191.0** (180)
 Serien: 99.4 91.6
 Zähler: 7 9 3 0 0 1 0 0 0 0 0
 Innenzehner: 6
 Weitester: 1295 (15.), 633 (13.), 575 (14.)
 beste Teiler: 26.0 (20.), 26.4 (7.), 38.1 (3.)
 Trefferlage: 2.36 mm rechts, 0.96 mm tief
 Streuwert: 2.64, horizontal: 3.50, vertikal: 1.30

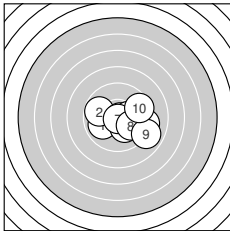
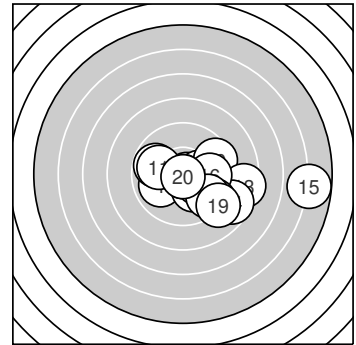

Serie 1: 99.4 (94)

9.9 ← 9.8 ← 10.8* → 10.3* → 10.2* ↘
 9.2 → 10.8* ↓ 10.0 ↘ 8.9 ↘ 9.5 →

beste Teiler: 26.4 (7.), 38.1 (3.), 169.0 (4.)
 Trefferlage: 1.20 mm rechts, 0.52 mm tief
 Streuwert: 1.94, horizontal: 2.46, vertikal: 1.20

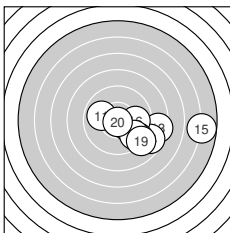

Serie 2: 91.6 (86)

9.9 ← 10.2* ↘ 8.4 → 8.7 ↘ 5.8 →
 9.9 → 9.3 ↘ 9.6 ↘ 9.0 ↘ 10.8* ↓

beste Teiler: 26.0 (20.), 178.1 (12.), 255.4 (11.)
 Trefferlage: 3.52 mm rechts, 1.40 mm tief
 Streuwert: 3.04, horizontal: 4.10, vertikal: 1.30



Ergebnis: 194.6 (186)
Serien: 98.5 96.1
Zähler: 9 8 3 0 0 0 0 0 0 0 0
Innenzehner: 7
Weiteste: 703 (15.), 521 (10.), 501 (14.)
beste Teiler: 78.4 (8.), 126.3 (11.), 135.0 (3.)
Trefferlage: 0.21 mm rechts, 0.01 mm hoch
Streuwert: 2.49, horizontal: 2.84, vertikal: 2.10

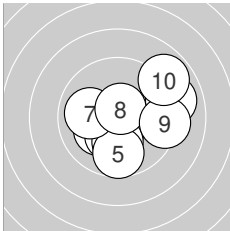
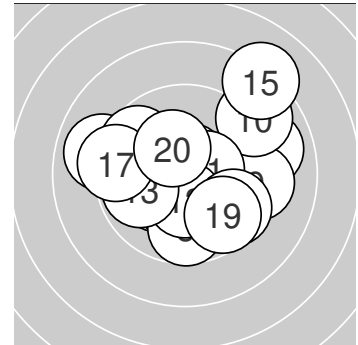

Serie 1: 98.5 (95)

10.2* ↖ 10.3* ↓ 10.4* ↓ 10.1 ↓ 9.7 ↓
 9.0 → 10.0 ← 10.6* ↑ 9.3 → 8.9 ↗
beste Teiler: 78.4 (8.), 135.0 (3.), 170.8 (2.)
Trefferlage: 0.85 mm rechts, 0.39 mm tief
Streuwert: 2.23, horizontal: 2.53, vertikal: 1.89

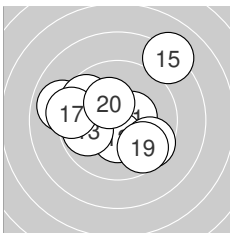

Serie 2: 96.1 (91)

10.4* → 10.4* ↓ 9.8 ← 8.9 ← 8.1 ↗
 9.6 ↖ 9.3 ← 9.6 ↘ 9.7 ↘ 10.3* ↖
beste Teiler: 126.3 (11.), 148.0 (12.), 168.1 (20.)
Trefferlage: 0.43 mm links, 0.42 mm hoch
Streuwert: 2.74, horizontal: 3.11, vertikal: 2.31



Ergebnis: 189.7 (182)
Serien: 93.3 96.4
Zähler: 8 7 4 1 0 0 0 0 0 0 0
Innenzehner: 6
Weiteste: 779 (5.), 727 (18.), 681 (6.)
beste Teiler: 50.2 (12.), 113.7 (14.), 134.0 (7.)
Trefferlage: 1.47 mm links, 0.12 mm tief
Streuwert: 2.91, horizontal: 3.91, vertikal: 1.29

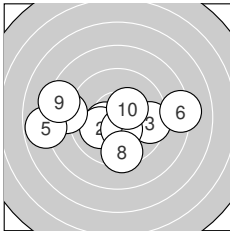
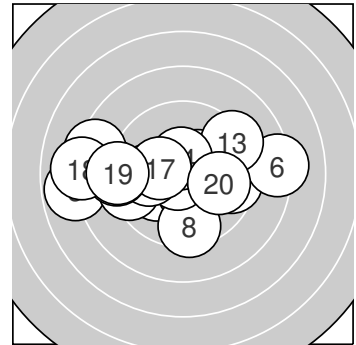

Serie 1: 93.3 (89)

10.4* ←	10.1 ←	9.5 →	8.7 ←	7.8 ←
8.2 →	10.4* ↓	9.5 ↓	8.3 ←	10.4* ↗

beste Teiler: 134.0 (7.), 141.5 (10.), 146.8 (1.)
Trefferlage: 1.05 mm links, 0.46 mm tief
Streuwert: 3.37, horizontal: 4.52, vertikal: 1.52

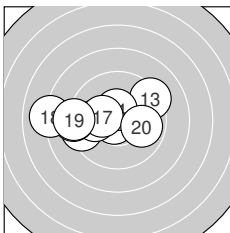

Serie 2: 96.4 (93)

9.4 ←	10.8* ↙	9.3 ↗	10.5* ↑	10.0 ←
9.1 ←	10.3* ←	8.0 ←	9.1 ←	9.9 →

beste Teiler: 50.2 (12.), 113.7 (14.), 171.2 (17.)
Trefferlage: 1.90 mm links, 0.22 mm hoch
Streuwert: 2.49, horizontal: 3.40, vertikal: 0.95



Ergebnis: **193.4** (184)
 Serien: 96.5 96.9
 Zähler: 8 10 0 2 0 0 0 0 0 0
 Innenzehner: 4
 Weitestе: 854 (12.), 796 (4.), 466 (7.)
 beste Teiler: 82.0 (20.), 102.8 (3.), 156.9 (1.)
 Trefferlage: 1.24 mm links, 1.12 mm tief
 Streuwert: 2.43, horizontal: 3.19, vertikal: 1.28

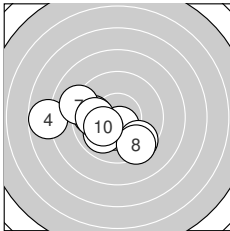
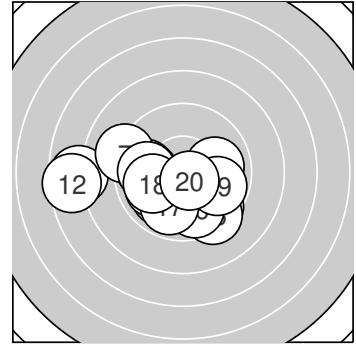

Serie 1: 96.5 (92)

10.3* ↓ 9.8 ← 10.5* ↓
 10.0 ↙ 9.1 ↖ 9.4 ↘

7.8 ← 9.5 ↘
 9.9 ← 10.2* ↙

beste Teiler: 102.8 (3.), 156.9 (1.), 195.0 (10.)
 Trefferlage: 1.68 mm links, 0.96 mm tief
 Streuwert: 2.39, horizontal: 3.08, vertikal: 1.39

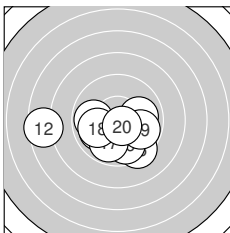

Serie 2: 96.9 (92)

9.9 ← 7.5 ← 10.0 →
 9.8 ↓ 9.9 ↙ 10.0 ↖

10.0 ↖ 9.4 ↘
 9.8 → 10.6* ↘

beste Teiler: 82.0 (20.), 245.7 (13.), 246.8 (18.)
 Trefferlage: 0.80 mm links, 1.27 mm tief
 Streuwert: 2.55, horizontal: 3.39, vertikal: 1.22



Ergebnis: 200.3 (190)
Serien: 99.4 100.9
Zähler: 13 5 1 1 0 0 0 0 0 0 0
Innenzehner: 11
Weiteste: 752 (17.), 513 (6.), 465 (3.)
beste Teiler: 33.2 (2.), 40.1 (16.), 88.1 (12.)
Trefferlage: 1.54 mm links, 0.05 mm hoch
Streuwert: 1.78, horizontal: 2.40, vertikal: 0.77

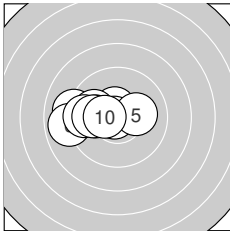
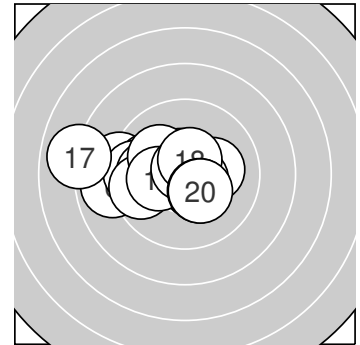

Serie 1: 99.4 (94)

10.6* ↑ 10.8* ← 9.1 ← 9.9 ← 10.2* →
 8.9 ← 10.0 ← 9.6 ← 9.9 ← 10.4* ←
beste Teiler: 33.2 (2.), 99.6 (1.), 136.0 (10.)
Trefferlage: 2.05 mm links, 0.21 mm hoch
Streuwert: 1.54, horizontal: 2.12, vertikal: 0.49

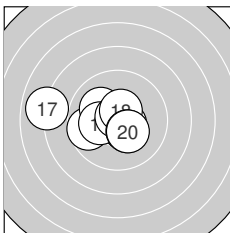

Serie 2: 100.9 (96)

9.7 ← 10.6* ↘ 10.1 ↘ 10.5* ↘ 10.2* ←
 10.8* ↑ 7.9 ← 10.5* ↑ 10.3* ↘ 10.3* ↘
beste Teiler: 40.1 (16.), 88.1 (12.), 106.5 (18.)
Trefferlage: 1.03 mm links, 0.09 mm tief
Streuwert: 2.01, horizontal: 2.66, vertikal: 0.98



Ergebnis: 192.8 (182)
Serien: 98.3 94.5
Zähler: 8 7 4 1 0 0 0 0 0 0 0
Innenzehner: 6
Weiteste: 752 (19.), 702 (14.), 559 (18.)
beste Teiler: 67.0 (8.), 78.1 (3.), 82.0 (4.)
Trefferlage: 0.21 mm links, 0.06 mm tief
Streuwert: 2.76, horizontal: 3.25, vertikal: 2.15

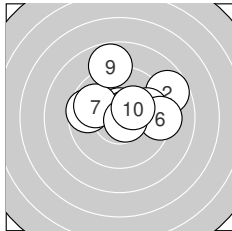
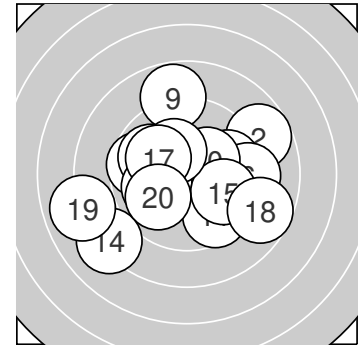

Serie 1: 98.3 (92)

9.6 ← 8.7 ↗ 10.6* ↑
 9.3 → 9.9 ↖ 10.7* ↘

10.6* ↗ 9.8 →
 8.8 ↑ 10.3* ↗

beste Teiler: 67.0 (8.), 78.1 (3.), 82.0 (4.)
Trefferlage: 0.77 mm rechts, 1.23 mm hoch
Streuwert: 2.20, horizontal: 2.66, vertikal: 1.62

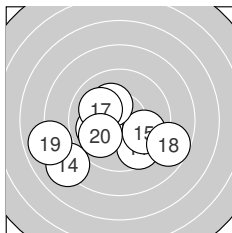

Serie 2: 94.5 (90)

9.6 ↘ 10.2* ← 10.0 ←
 10.2* ↖ 10.1 ↖ 8.7 ↘

8.1 ↖ 9.8 ↘
 7.9 ← 9.9 ↖

beste Teiler: 178.7 (16.), 196.9 (12.), 225.2 (17.)
Trefferlage: 1.20 mm links, 1.36 mm tief
Streuwert: 2.87, horizontal: 3.62, vertikal: 1.83



Ergebnis: 202.4 (192)
Serien: 105.0 97.4
Zähler: 14 5 0 1 0 0 0 0 0 0 0
Innenzehner: 12
Weiteste: 824 (15.), 467 (19.), 440 (8.)
beste Teiler: 24.7 (10.), 29.4 (4.), 67.0 (11.)
Trefferlage: 0.98 mm links, 0.12 mm hoch
Streuwert: 1.94, horizontal: 2.56, vertikal: 0.99

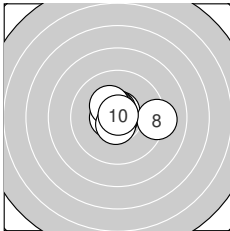
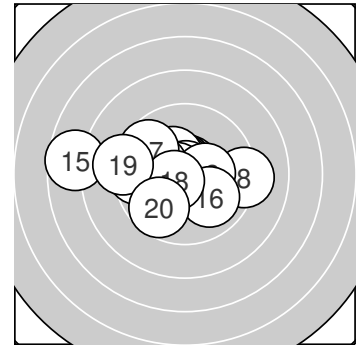

Serie 1: 105.0 (99)

10.7* ↘	10.7* ↑	10.6* ↑	10.8* ↓	10.6* ←
10.6* ↘	10.3* ↘	9.2 →	10.6* ↓	10.9* ↑

beste Teiler: 24.7 (10.), 29.4 (4.), 67.7 (2.)
Trefferlage: 0.15 mm rechts, 0.29 mm hoch
Streuwert: 1.18, horizontal: 1.54, vertikal: 0.64

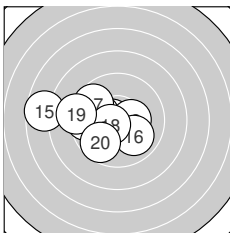

Serie 2: 97.4 (93)

10.7* ←	10.1 ←	10.3* →	9.5 ←	7.7 ←
10.0 ↘	9.7 ↘	10.6* ↙	9.1 ←	9.7 ✓

beste Teiler: 67.0 (11.), 93.8 (18.), 151.1 (13.)
Trefferlage: 2.11 mm links, 0.03 mm tief
Streuwert: 2.27, horizontal: 2.94, vertikal: 1.27



Ergebnis: 198.1 (189)
Serien: 101.0 97.1
Zähler: 10 9 1 0 0 0 0 0 0 0 0
Innenzehner: 8
Weiteste: 695 (14.), 427 (11.), 422 (12.)
beste Teiler: 69.6 (4.), 70.2 (8.), 103.2 (16.)
Trefferlage: 0.05 mm links, 0.18 mm tief
Streuwert: 2.16, horizontal: 2.87, vertikal: 1.04

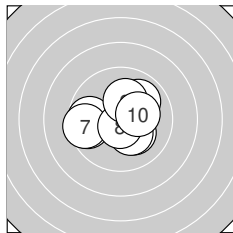
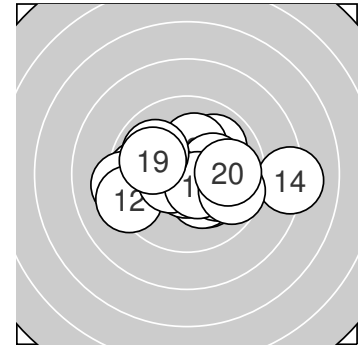

Serie 1: 101.0 (96)

9.6 ← 9.7 ← 9.9 ↗
 10.3* ↘ 9.5 ← 10.7* ↓
beste Teiler: 69.6 (4.), 70.2 (8.), 172.4 (6.)
Trefferlage: 0.31 mm links, 0.02 mm tief
Streuwert: 1.74, horizontal: 2.16, vertikal: 1.17

10.7* ↗ 10.2* ↘
 10.2* ↑ 10.2* →

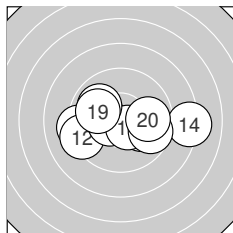

Serie 2: 97.1 (93)

9.2 ← 9.3 ← 10.5* ←
 10.5* ↘ 9.9 ↖ 9.7 →
beste Teiler: 103.2 (16.), 113.8 (13.), 226.6 (15.)
Trefferlage: 0.19 mm rechts, 0.35 mm tief
Streuwert: 2.59, horizontal: 3.55, vertikal: 0.94

8.2 → 10.0 ↘
 10.0 ← 9.8 →



Ergebnis: 196.1 (187)
Serien: 98.5 97.6
Zähler: 9 9 2 0 0 0 0 0 0 0 0
Innenzehner: 6
Weiteste: 614 (4.), 527 (19.), 486 (11.)
beste Teiler: 101.7 (10.), 103.0 (12.), 116.0 (17.)
Trefferlage: 1.04 mm links, 0.01 mm tief
Streuwert: 2.20, horizontal: 2.70, vertikal: 1.56

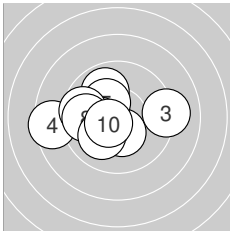
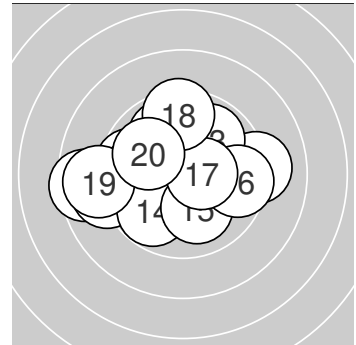

Serie 1: 98.5 (94)

9.9 ↖	10.4* ↓	9.1 →	8.5 ←	10.3* ↗
10.3* ←	9.6 ←	9.8 ←	10.1 ↙	10.5* ↘

beste Teiler: 101.7 (10.), 148.7 (2.), 171.2 (5.)
Trefferlage: 1.36 mm links, 0.00 mm
Streuwert: 2.12, horizontal: 2.73, vertikal: 1.24

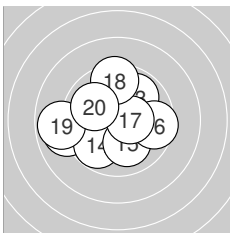

Serie 2: 97.6 (93)

9.0 ←	10.5* ↓	9.9 ↗	9.8 ↙	10.0 ↓
9.6 →	10.5* →	9.5 ↑	8.8 ←	10.0 ↖

beste Teiler: 103.0 (12.), 116.0 (17.), 226.3 (15.)
Trefferlage: 0.72 mm links, 0.02 mm tief
Streuwert: 2.37, horizontal: 2.78, vertikal: 1.89



Ergebnis: 193.9 (185)
Serien: 99.1 94.8
Zähler: 7 11 2 0 0 0 0 0 0 0
Innenzehner: 5
Weiteste: 542 (10.), 511 (17.), 441 (15.)
beste Teiler: 59.8 (8.), 115.2 (3.), 124.3 (1.)
Trefferlage: 1.57 mm links, 0.36 mm hoch
Streuwert: 2.20, horizontal: 2.06, vertikal: 2.33

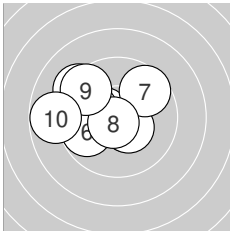
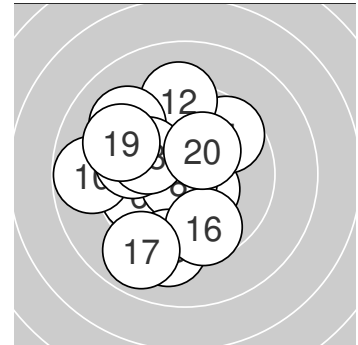

Serie 1: 99.1 (94)

10.5* ←	9.3 ↘	10.5* ↘	10.4* ↘	10.0 ←
9.8 ←	9.6 ↗	10.7* ↗	9.5 ↘	8.8 ←

beste Teiler: 59.8 (8.), 115.2 (3.), 124.3 (1.)
Trefferlage: 1.39 mm links, 0.48 mm hoch
Streuwert: 1.95, horizontal: 2.37, vertikal: 1.43

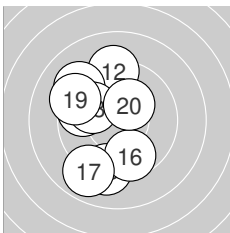

Serie 2: 94.8 (91)

9.4 ↘	9.2 ↑	9.2 ↓	9.7 ←	9.2 ↘
9.6 ↓	8.9 ↙	10.0 ↖	9.3 ↖	10.3* ↗

beste Teiler: 170.2 (20.), 243.7 (18.), 314.1 (14.)
Trefferlage: 1.74 mm links, 0.24 mm hoch
Streuwert: 2.52, horizontal: 1.82, vertikal: 3.07



Ergebnis: 188.2 (179)
Serien: 93.4 94.8
Zähler: 5 12 0 3 0 0 0 0 0 0
Innenzehner: 3
Weiteste: 896 (16.), 836 (5.), 763 (12.)
beste Teiler: 40.3 (15.), 63.2 (7.), 87.6 (13.)
Trefferlage: 0.92 mm rechts, 0.59 mm hoch
Streuwert: 3.15, horizontal: 3.26, vertikal: 3.04

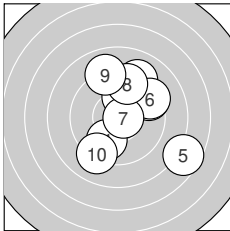
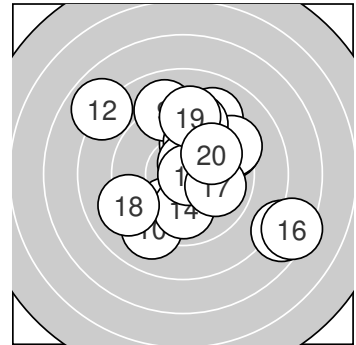

Serie 1: 93.4 (90)

9.4 ↗	9.1 ↗	10.0 ↑	9.8 ↘	7.6 ↘
9.3 ↗	10.7* →	9.4 ↑	9.0 ↖	9.1 ↘

beste Teiler: 63.2 (7.), 229.9 (3.), 277.3 (4.)
Trefferlage: 1.38 mm rechts, 0.79 mm hoch
Streuwert: 3.09, horizontal: 2.85, vertikal: 3.31

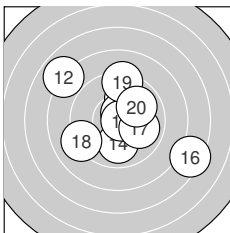

Serie 2: 94.8 (89)

9.9 ↑	7.9 ↘	10.6* ↗	10.0 ↓	10.8* →
7.4 ↘	9.9 ↘	9.1 ↙	9.3 ↑	9.9 ↗

beste Teiler: 40.3 (15.), 87.6 (13.), 250.0 (14.)
Trefferlage: 0.47 mm rechts, 0.39 mm hoch
Streuwert: 3.34, horizontal: 3.72, vertikal: 2.91



Ergebnis: **187.2** (179)
Serien: 101.0 86.2
Zähler: 8 7 4 0 0 0 1 0 0 0 0
Innenzehner: 7
Weiteste: 1591 (14.), 694 (13.), 689 (20.)
beste Teiler: 33.5 (3.), 67.2 (5.), 122.0 (6.)
Trefferlage: 0.47 mm rechts, 0.26 mm hoch
Streuwert: 3.78, horizontal: 4.88, vertikal: 2.18

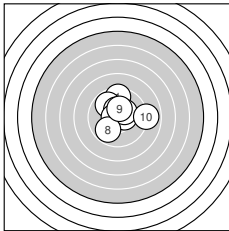
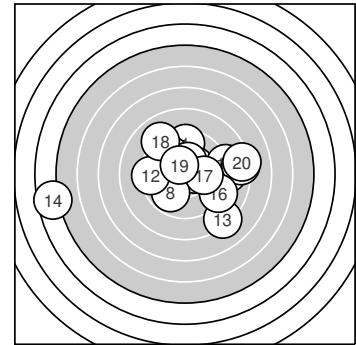

Serie 1: 101.0 (95)

9.5 ↑ 9.8 ↘ 10.8* →
 10.5* → 10.3* ↗ 9.8 ↙
beste Teiler: 33.5 (3.), 67.2 (5.), 122.0 (6.)
Trefferlage: 0.39 mm rechts, 0.76 mm hoch
Streuwert: 1.76, horizontal: 1.94, vertikal: 1.56

10.4* ↑ 10.7* ←
 10.3* ↑ 8.9 →

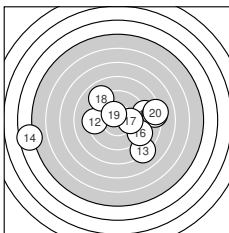

Serie 2: 86.2 (84)

9.0 → 9.3 ← 8.2 ↘ 4.6 ←
 9.1 ↘ 10.1 → 9.0 ↙ 10.4* ↘ 8.2 →
beste Teiler: 126.5 (19.), 225.3 (17.), 406.3 (12.)
Trefferlage: 0.55 mm rechts, 0.23 mm tief
Streuwert: 5.18, horizontal: 6.82, vertikal: 2.65

4.6 ← 8.3 →
 10.4* ↘ 8.2 →



Ergebnis: **180.4** (172)
 Serien: 88.7 91.7
 Zähler: 5 6 5 4 0 0 0 0 0 0 0
 Innenzehner: 5
 Weitester: 984 (9.), 959 (8.), 816 (16.)
 beste Teiler: 49.4 (20.), 59.0 (6.), 133.1 (12.)
 Trefferlage: 1.97 mm links, 1.15 mm hoch
 Streuwert: 3.69, horizontal: 4.64, vertikal: 2.38

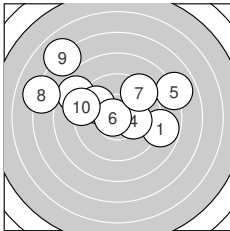
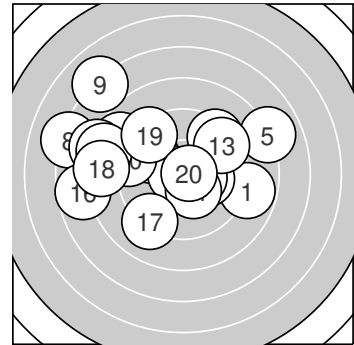

Serie 1: 88.7 (84)

8.8 →	8.7 ↖	9.8 ↖	10.2* →	7.9 →
10.7* ←	9.4 ↗	7.1 ←	7.0 ↘	9.1 ←

beste Teiler: 59.0 (6.), 193.5 (4.), 298.5 (3.)
 Trefferlage: 1.19 mm links, 1.99 mm hoch
 Streuwert: 4.10, horizontal: 5.26, vertikal: 2.41

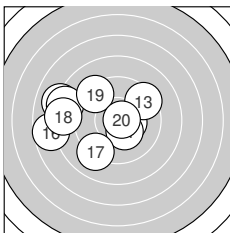

Serie 2: 91.7 (88)

8.1 ↖	10.4* →	9.4 ↗	10.3* ↓	8.3 ↖
7.7 ←	9.1 ↙	8.3 ←	9.3 ↘	10.8* →

beste Teiler: 49.4 (20.), 133.1 (12.), 157.3 (14.)
 Trefferlage: 2.75 mm links, 0.31 mm hoch
 Streuwert: 3.23, horizontal: 4.04, vertikal: 2.13



Ergebnis: 180.0 (170)
Serien: 93.4 86.6
Zähler: 4 7 6 1 2 0 0 0 0 0 0
Innenzehner: 3
Weiteste: 1041 (6.), 1006 (13.), 802 (12.)
beste Teiler: 130.6 (1.), 149.7 (20.), 159.1 (4.)
Trefferlage: 1.25 mm links, 1.68 mm tief
Streuwert: 3.71, horizontal: 4.21, vertikal: 3.13

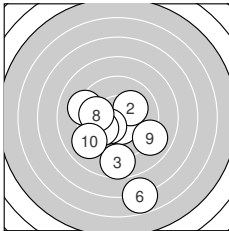
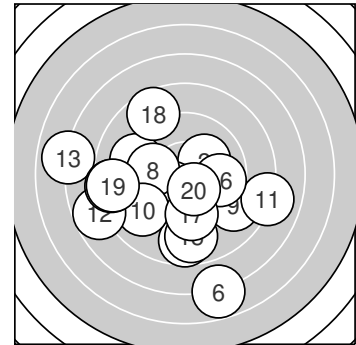

Serie 1: 93.4 (89)

10.4* ↓ 10.1 ↗ 8.7 ↓ 10.3* ↙ 9.2 ←
 6.8 ↓ 9.9 ↖ 9.9 ← 9.0 ↘ 9.1 ↗
beste Teiler: 130.6 (1.), 159.1 (4.), 201.6 (2.)
Trefferlage: 0.45 mm links, 2.23 mm tief
Streuwert: 3.12, horizontal: 2.78, vertikal: 3.43

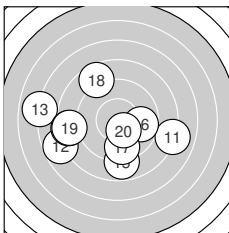

Serie 2: 86.6 (81)

8.0 → 7.7 ← 6.9 ← 8.4 ← 8.8 ↓
 9.7 → 9.6 ↓ 8.6 ↘ 8.5 ← 10.4* ↓
beste Teiler: 149.7 (20.), 301.5 (16.), 345.7 (17.)
Trefferlage: 2.05 mm links, 1.14 mm tief
Streuwert: 4.28, horizontal: 5.32, vertikal: 2.88



Ergebnis: 206.9 (197)
Serien: 103.2 103.7
Zähler: 17 3 0 0 0 0 0 0 0 0 0
Innenzehner: 14
Weiteste: 321 (3.), 298 (12.), 285 (1.)
beste Teiler: 7.0 (13.), 48.0 (9.), 52.3 (10.)
Trefferlage: 0.89 mm links, 0.02 mm hoch
Streuwert: 1.09, horizontal: 1.03, vertikal: 1.15

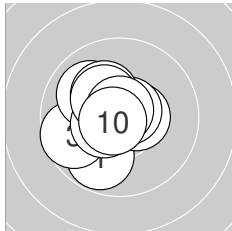
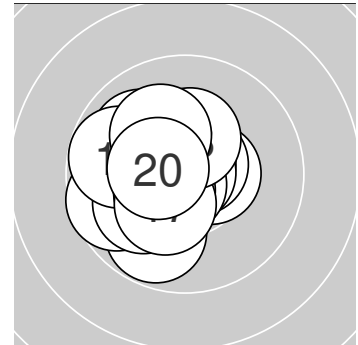

Serie 1: 103.2 (98)

9.8 ↙	10.5* →	9.7 ↙	10.0 ↘	10.7* ↗
10.2* ↘	10.5* ↙	10.3* ↘	10.8* ↑	10.7* ↙

beste Teiler: 48.0 (9.), 52.3 (10.), 69.8 (5.)
Trefferlage: 0.80 mm links, 0.07 mm hoch
Streuwert: 1.23, horizontal: 1.19, vertikal: 1.26

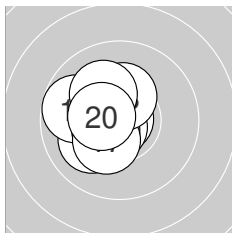

Serie 2: 103.7 (99)

10.1 ↙	9.8 ↙	10.9* ↑	10.5* ↙	10.7* ↙
10.5* ↙	10.3* ↙	10.3* ↑	10.1 ↘	10.5* ↙

beste Teiler: 7.0 (13.), 61.6 (15.), 115.4 (16.)
Trefferlage: 0.98 mm links, 0.02 mm tief
Streuwert: 1.00, horizontal: 0.89, vertikal: 1.10



Ergebnis: 192.2 (185)
Serien: 96.1 96.1
Zähler: 7 11 2 0 0 0 0 0 0 0 0
Innenzehner: 4
Weiteste: 649 (19.), 597 (6.), 468 (8.)
beste Teiler: 109.6 (1.), 141.6 (7.), 174.6 (14.)
Trefferlage: 0.33 mm rechts, 1.19 mm tief
Streuwert: 2.51, horizontal: 2.66, vertikal: 2.34

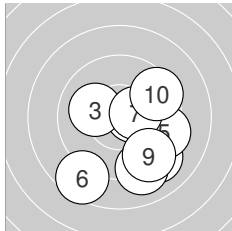
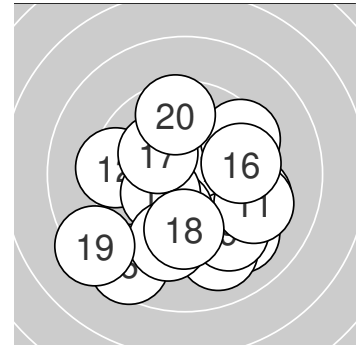

Serie 1: 96.1 (93)

10.5* → 10.1 → 10.1 ← 9.1 ↘ 9.4 →
 8.6 ↙ 10.4* → 9.1 ↘ 9.3 ↘ 9.5 ↗
beste Teiler: 109.6 (1.), 141.6 (7.), 213.7 (2.)
Trefferlage: 1.36 mm rechts, 1.37 mm tief
Streuwert: 2.34, horizontal: 2.26, vertikal: 2.42

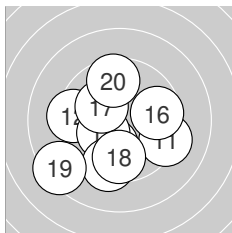

Serie 2: 96.1 (92)

9.3 ↘ 9.4 ← 10.1 ↓ 10.3* ↙ 9.4 ↓
 9.7 → 10.2* ↖ 9.7 ↓ 8.4 ↙ 9.6 ↑
beste Teiler: 174.6 (14.), 191.2 (17.), 217.8 (13.)
Trefferlage: 0.70 mm links, 1.02 mm tief
Streuwert: 2.56, horizontal: 2.73, vertikal: 2.38



Ergebnis: **202.6** (197)
 Serien: 100.2 102.4
 Zähler: 17 3 0 0 0 0 0 0 0 0 0
 Innenzehner: 10
 Weitestе: 375 (6.), 355 (16.), 350 (2.)
 beste Teiler: 97.1 (11.), 101.7 (17.), 104.5 (13.)
 Trefferlage: 0.24 mm rechts, 0.50 mm hoch
 Streuwert: 1.56, horizontal: 1.62, vertikal: 1.50

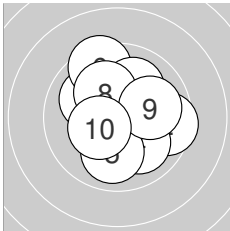
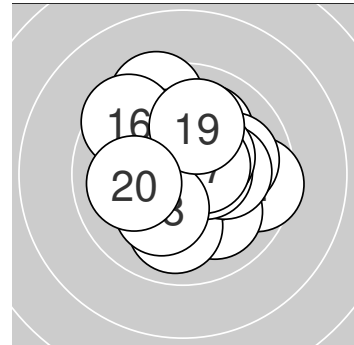

Serie 1: 100.2 (98)

10.0 ↘ 9.6 → 10.5* ↗
 9.5 ↖ 10.0 ↗ 10.2* ↖
 beste Teiler: 114.8 (3.), 148.7 (10.), 195.4 (8.)
 Trefferlage: 0.35 mm rechts, 0.45 mm hoch
 Streuwert: 1.80, horizontal: 1.77, vertikal: 1.83

10.0 ↘ 10.0 ↓
 10.0 → 10.4* ↙

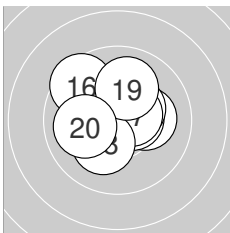

Serie 2: 102.4 (99)

10.6* ↗ 10.2* → 10.5* →
 9.5 ↖ 10.5* ↗ 10.2* ↙
 beste Teiler: 97.1 (11.), 101.7 (17.), 104.5 (13.)
 Trefferlage: 0.12 mm rechts, 0.56 mm hoch
 Streuwert: 1.38, horizontal: 1.54, vertikal: 1.19

10.5* ↗ 10.4* ↗
 10.0 ↗ 10.0 ←



Ergebnis: 125.0 (114)
Serien: 60.6 64.4
Zähler: 0 0 3 4 5 4 2 0 2 0 0
Innenzehner: 0
Weiteste: 2156 (7.), 2041 (14.), 1746 (15.)
beste Teiler: 582.8 (1.), 669.1 (11.), 732.4 (16.)
Trefferlage: 3.32 mm links, 2.93 mm hoch
Streuwert: 8.52, horizontal: 10.43, vertikal: 6.02

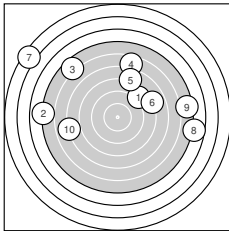
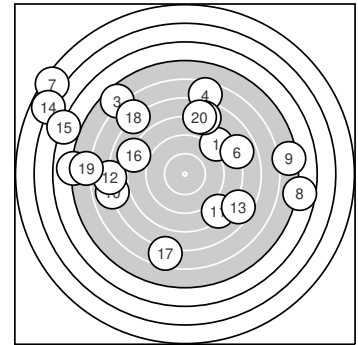

Serie 1: 60.6 (55)

8.6 ↗	5.0 ←	5.6 ↘	6.5 ↑	7.8 ↑
7.9 →	2.3 ↖	4.7 →	5.3 →	6.9 ←

beste Teiler: 582.8 (1.), 760.5 (6.), 799.7 (5.)
Trefferlage: 0.57 mm links, 4.50 mm hoch
Streuwert: 9.08, horizontal: 11.69, vertikal: 5.31

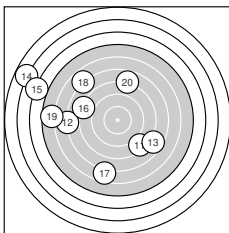

Serie 2: 64.4 (59)

8.3 ↘	6.9 ←	7.6 ↘	2.8 ↖	4.0 ↖
8.0 ↖	6.6 ↓	6.8 ↘	5.6 ←	7.8 ↑

beste Teiler: 669.1 (11.), 732.4 (16.), 792.8 (20.)
Trefferlage: 6.08 mm links, 1.35 mm hoch
Streuwert: 7.72, horizontal: 8.74, vertikal: 6.54



Ergebnis: 190.4 (182)
Serien: 97.2 93.2
Zähler: 7 10 1 2 0 0 0 0 0 0 0
Innenzehner: 4
Weiteste: 822 (16.), 775 (18.), 742 (2.)
beste Teiler: 104.2 (5.), 151.6 (10.), 191.5 (3.)
Trefferlage: 0.08 mm rechts, 0.65 mm tief
Streuwert: 2.95, horizontal: 3.35, vertikal: 2.47

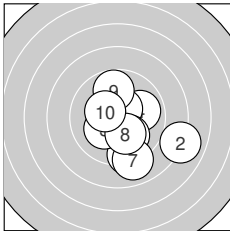
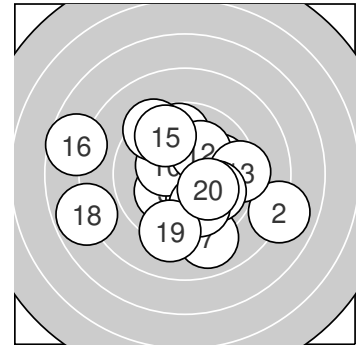

Serie 1: 97.2 (94)

9.3 ↓ 8.0 → 10.2* ↙
 10.0 ↓ 9.0 ↓ 10.2* ↓
beste Teiler: 104.2 (5.), 151.6 (10.), 191.5 (3.)
Trefferlage: 1.14 mm rechts, 1.13 mm tief
Streuwert: 2.39, horizontal: 2.38, vertikal: 2.40

9.9 → 10.5* ↗
 9.8 ↑ 10.3* ↖

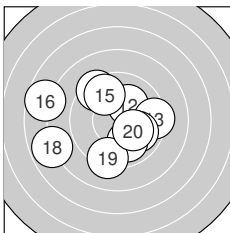

Serie 2: 93.2 (88)

9.4 ↖ 10.1 ↗ 9.3 →
 7.7 ← 9.9 ↓ 7.9 ←
beste Teiler: 201.3 (12.), 201.6 (20.), 256.1 (14.)
Trefferlage: 0.97 mm links, 0.17 mm tief
Streuwert: 3.33, horizontal: 3.94, vertikal: 2.57

9.9 → 9.7 ↖
 9.2 ↓ 10.1 →



Ergebnis: 186.6 (177)
Serien: 89.0 97.6
Zähler: 6 6 7 1 0 0 0 0 0 0 0
Innenzehner: 5
Weiteste: 764 (3.), 644 (6.), 632 (2.)
beste Teiler: 84.1 (14.), 96.7 (15.), 129.0 (12.)
Trefferlage: 0.00 mm , 0.07 mm hoch
Streuwert: 3.31, horizontal: 4.06, vertikal: 2.33

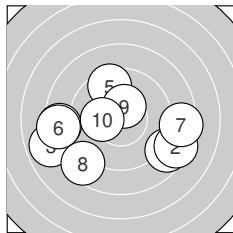
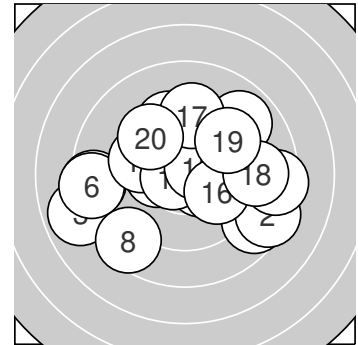

Serie 1: 89.0 (84)

8.7 ↘ 8.4 ↘ 7.9 ←
 8.4 ← 8.5 → 8.6 ↙
beste Teiler: 138.0 (9.), 190.0 (10.), 362.0 (5.)
Trefferlage: 0.97 mm links, 1.03 mm tief
Streuwert: 3.98, horizontal: 5.12, vertikal: 2.35

8.4 ← 9.5 ↑
 10.4* ↑ 10.2* ←

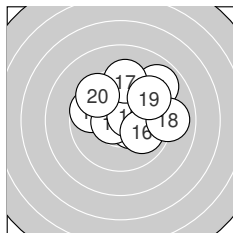

Serie 2: 97.6 (93)

8.9 ↗ 10.4* ↘ 9.7 ← 10.6* ←
 10.0 ↘ 9.3 ↑ 9.0 → 9.5 ↗ 9.6 ↘
beste Teiler: 84.1 (14.), 96.7 (15.), 129.0 (12.)
Trefferlage: 0.99 mm rechts, 1.18 mm hoch
Streuwert: 2.21, horizontal: 2.55, vertikal: 1.80

10.6* ← 10.6* ↗
 9.5 ↗ 9.6 ↘



Ergebnis: 193.1 (184)
Serien: 95.5 97.6
Zähler: 8 9 2 1 0 0 0 0 0 0 0
Innenzehner: 7
Weiteste: 777 (14.), 607 (13.), 553 (1.)
beste Teiler: 21.9 (12.), 74.7 (18.), 149.0 (20.)
Trefferlage: 0.76 mm rechts, 0.46 mm hoch
Streuwert: 2.62, horizontal: 2.28, vertikal: 2.91

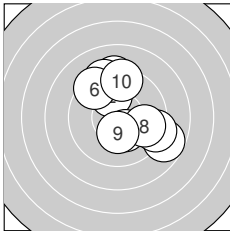
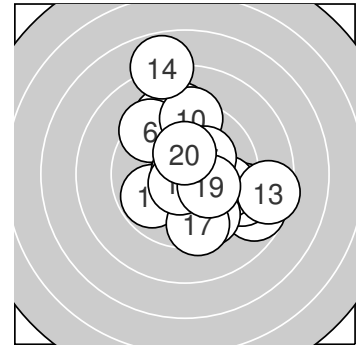

Serie 1: 95.5 (92)

8.7 ↘ 10.0 ↑ 9.2 →
 9.4 ↙ 10.3* ↓ 9.7 →
beste Teiler: 162.0 (9.), 164.8 (7.), 237.2 (2.)
Trefferlage: 0.81 mm rechts, 0.96 mm hoch
Streuwert: 2.59, horizontal: 2.40, vertikal: 2.77

9.2 ↑ 9.3 ↙
 10.3* ↓ 9.4 ↑

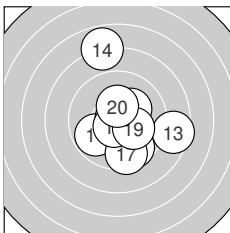

Serie 2: 97.6 (92)

9.8 ↙ 10.9* ↙ 8.5 →
 9.6 ↓ 9.5 ↓ 10.7* ↙
beste Teiler: 21.9 (12.), 74.7 (18.), 149.0 (20.)
Trefferlage: 0.71 mm rechts, 0.03 mm tief
Streuwert: 2.73, horizontal: 2.29, vertikal: 3.12

7.8 ↑ 10.2* ↗
 10.2* → 10.4* ↑



Ergebnis: **200.7** (191)
 Serien: 99.6 101.1
 Zähler: 12 7 1 0 0 0 0 0 0 0 0
 Innenzehner: 8
 Weitesten: 587 (9.), 380 (8.), 330 (6.)
 beste Teiler: 42.1 (2.), 77.6 (4.), 99.1 (12.)
 Trefferlage: 0.59 mm links, 0.25 mm tief
 Streuwert: 1.83, horizontal: 2.11, vertikal: 1.50

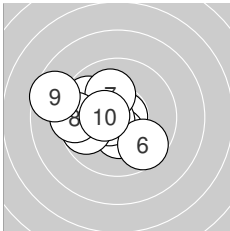
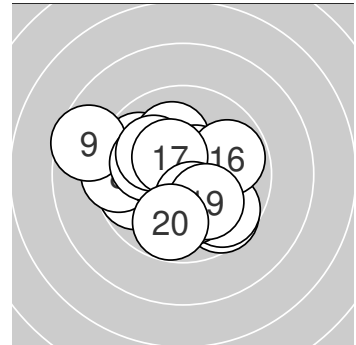

Serie 1: 99.6 (94)

9.8 ↖	10.8* →	10.4* ↓	10.6* ←	9.8 ←
9.6 ↘	10.1 ↑	9.4 ←	8.6 ←	10.5* ←

beste Teiler: 42.1 (2.), 77.6 (4.), 117.7 (10.)
 Trefferlage: 1.44 mm links, 0.02 mm hoch
 Streuwert: 1.90, horizontal: 2.28, vertikal: 1.44

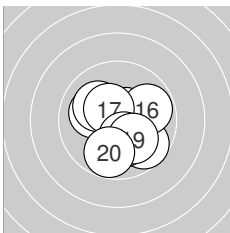

Serie 2: 101.1 (97)

10.1 ↖	10.6* ↗	10.1 ↖	9.7 ↘	10.2* ↓
9.8 →	10.4* ↖	10.3* ↓	10.1 ↘	9.8 ↓

beste Teiler: 99.1 (12.), 128.4 (17.), 160.7 (18.)
 Trefferlage: 0.26 mm rechts, 0.54 mm tief
 Streuwert: 1.59, horizontal: 1.60, vertikal: 1.58



Ergebnis: **176.1** (166)
 Serien: 91.2 84.9
 Zähler: 3 7 6 2 1 1 0 0 0 0 0
 Innenzehner: 3
 Weitestе: 1379 (18.), 1041 (12.), 940 (10.)
 beste Teiler: 18.1 (5.), 120.0 (8.), 160.2 (11.)
 Trefferlage: 1.49 mm rechts, 2.17 mm tief
 Streuwert: 4.15, horizontal: 4.31, vertikal: 3.98

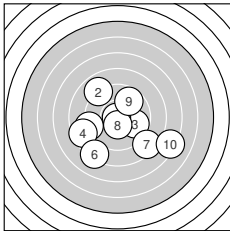
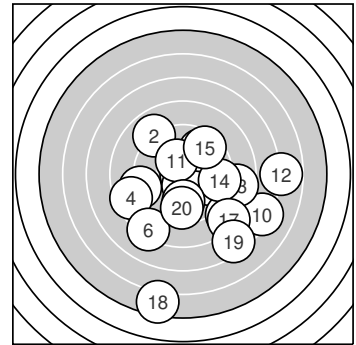

Serie 1: 91.2 (86)

9.1 ←	8.9 ↖	9.8 →	8.5 ←	10.9* ←
8.2 ↙	8.4 ↘	10.5* ↓	9.7 ↗	7.2 ↘

beste Teiler: 18.1 (5.), 120.0 (8.), 295.2 (3.)
 Trefferlage: 0.06 mm rechts, 1.40 mm tief
 Streuwert: 3.81, horizontal: 4.43, vertikal: 3.08

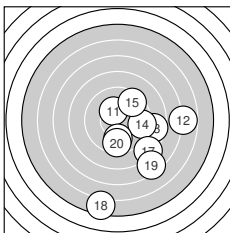

Serie 2: 84.9 (80)

10.3* ↖	6.8 →	8.6 →	9.4 →	9.5 ↗
9.8 ↓	8.2 ↘	5.4 ↓	7.4 ↘	9.5 ↓

beste Teiler: 160.2 (11.), 286.0 (16.), 357.2 (20.)
 Trefferlage: 2.91 mm rechts, 2.94 mm tief
 Streuwert: 4.35, horizontal: 3.90, vertikal: 4.76



Ergebnis: 196.8 (189)
Serien: 96.4 100.4
Zähler: 10 9 1 0 0 0 0 0 0 0 0
Innenzehner: 8
Weiteste: 645 (7.), 499 (5.), 494 (2.)
beste Teiler: 101.1 (18.), 102.9 (4.), 120.8 (3.)
Trefferlage: 1.19 mm rechts, 1.03 mm tief
Streuwert: 1.97, horizontal: 1.87, vertikal: 2.07

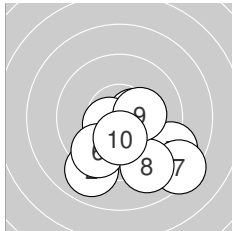
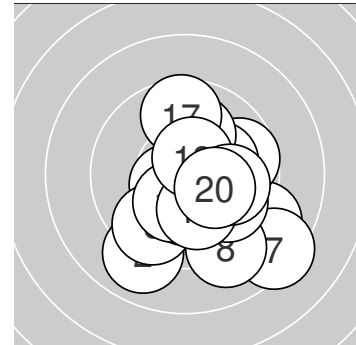

Serie 1: 96.4 (93)

9.7 ↘	9.0 ✓	10.5* →	10.5* ←	9.0 ↘
9.6 ✓	8.4 ↘	9.1 ↘	10.3* →	10.3* ↓

beste Teiler: 102.9 (4.), 120.8 (3.), 169.5 (9.)
Trefferlage: 1.16 mm rechts, 2.22 mm tief
Streuwert: 2.10, horizontal: 2.42, vertikal: 1.72

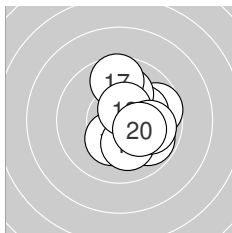

Serie 2: 100.4 (96)

9.8 ↘	9.7 →	10.3* ↓	10.2* →	10.1 ↑
10.1 ↓	9.6 ↑	10.5* ↑	9.9 →	10.2* ↘

beste Teiler: 101.1 (18.), 166.2 (13.), 182.5 (20.)
Trefferlage: 1.21 mm rechts, 0.15 mm hoch
Streuwert: 1.49, horizontal: 1.23, vertikal: 1.72



Ergebnis: 182.7 (174)
Serien: 91.6 91.1
Zähler: 5 7 6 1 1 0 0 0 0 0 0
Innenzehner: 1
Weiteste: 1036 (19.), 921 (20.), 604 (6.)
beste Teiler: 149.3 (14.), 214.4 (10.), 222.5 (17.)
Trefferlage: 0.00 mm , 0.20 mm hoch
Streuwert: 3.64, horizontal: 4.06, vertikal: 3.18

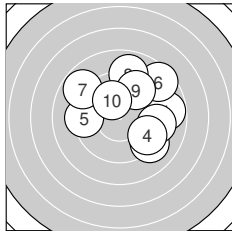
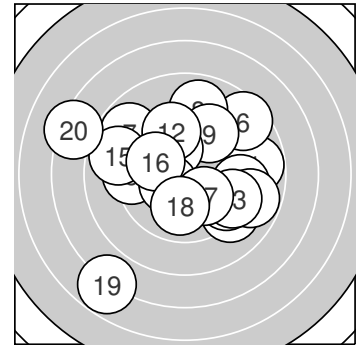

Serie 1: 91.6 (87)

8.8 →	9.1 ↘	9.2 →	9.4 ↘	9.3 ←
8.5 ↗	8.8 ↙	8.9 ↑	9.5 ↗	10.1 ↖

beste Teiler: 214.4 (10.), 364.6 (9.), 380.2 (4.)
Trefferlage: 1.44 mm rechts, 1.22 mm hoch
Streuwert: 3.10, horizontal: 3.47, vertikal: 2.68

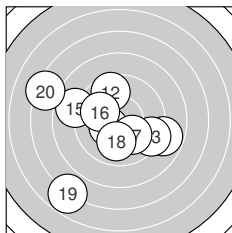

Serie 2: 91.1 (87)

8.8 ↘	9.6 ↑	9.3 ↘	10.4* ↖	8.8 ←
10.0 ↖	10.1 ↘	10.0 ↓	6.8 ↗	7.3 ↖

beste Teiler: 149.3 (14.), 222.5 (17.), 245.9 (16.)
Trefferlage: 1.45 mm links, 0.80 mm tief
Streuwert: 3.87, horizontal: 4.25, vertikal: 3.44



Ergebnis: **176.0** (169)
 Serien: 89.9 86.1
 Zähler: 4 4 9 3 0 0 0 0 0 0 0
 Innenzehner: 2
 Weitester: 960 (14.), 948 (13.), 800 (20.)
 beste Teiler: 38.0 (6.), 182.8 (15.), 235.0 (4.)
 Trefferlage: 1.28 mm rechts, 1.19 mm hoch
 Streuwert: 4.10, horizontal: 5.16, vertikal: 2.63

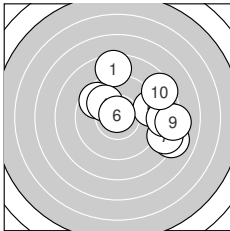
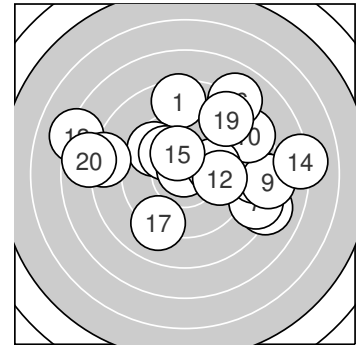

Serie 1: 89.9 (86)

8.5 ↑ 9.6 ↘ 8.1 →
 10.8* ↑ 8.4 → 8.6 →
 beste Teiler: 38.0 (6.), 235.0 (4.), 327.6 (2.)
 Trefferlage: 2.97 mm rechts, 0.87 mm hoch
 Streuwert: 3.21, horizontal: 3.71, vertikal: 2.60

10.0 ↖ 9.2 →
 8.2 → 8.5 ↗

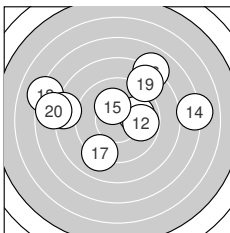

Serie 2: 86.1 (83)

10.0 → 9.8 → 7.2 ← 7.1 → 10.2* ↑
 8.0 ↗ 9.1 ↙ 8.2 ← 8.7 ↗ 7.8 ←
 beste Teiler: 182.8 (15.), 243.2 (11.), 289.6 (12.)
 Trefferlage: 0.41 mm links, 1.52 mm hoch
 Streuwert: 4.67, horizontal: 6.01, vertikal: 2.75

7.1 → 10.2* ↑
 8.7 ↗ 7.8 ←



Ergebnis: **169.7** (159)
 Serien: 86.6 83.1
 Zähler: 3 5 2 8 2 0 0 0 0 0 0
 Innenzehner: 2
 Weitester: 1197 (20.), 1059 (5.), 961 (7.)
 beste Teiler: 106.7 (12.), 173.6 (8.), 214.9 (4.)
 Trefferlage: 1.76 mm rechts, 2.46 mm tief
 Streuwert: 4.56, horizontal: 5.36, vertikal: 3.58

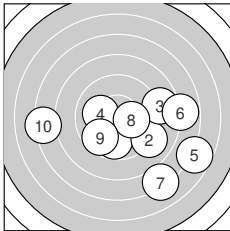
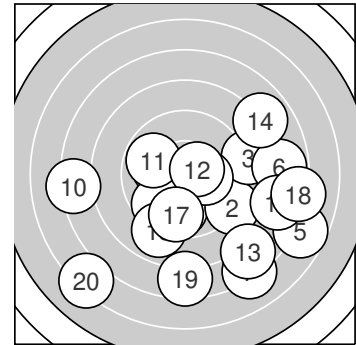

Serie 1: 86.6 (82)

9.8 ↓ 9.1 ↘ 8.8 →
 7.8 → 7.1 ↘ 10.3* →

10.1 ← 6.7 ↘
 9.6 ↙ 7.3 ←

beste Teiler: 173.6 (8.), 214.9 (4.), 295.7 (1.)
 Trefferlage: 1.95 mm rechts, 1.95 mm tief
 Streuwert: 4.43, horizontal: 5.58, vertikal: 2.85

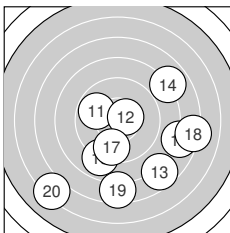

Serie 2: 83.1 (77)

9.8 ↖ 10.5* → 7.7 ↘
 7.8 → 9.6 ↓ 7.2 →

7.9 ↗ 8.9 ↓
 7.5 ↓ 6.2 ↙

beste Teiler: 106.7 (12.), 283.4 (11.), 340.1 (17.)
 Trefferlage: 1.57 mm rechts, 2.97 mm tief
 Streuwert: 4.89, horizontal: 5.43, vertikal: 4.28



Ergebnis: 190.0 (179)
Serien: 93.6 96.4
Zähler: 8 5 6 0 1 0 0 0 0 0 0
Innenzehner: 6
Weiteste: 1182 (9.), 616 (1.), 588 (5.)
beste Teiler: 41.3 (16.), 78.2 (6.), 90.3 (3.)
Trefferlage: 0.14 mm rechts, 0.11 mm tief
Streuwert: 3.25, horizontal: 4.12, vertikal: 2.05

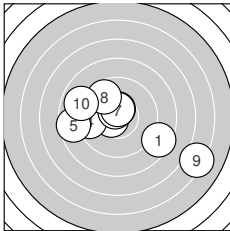
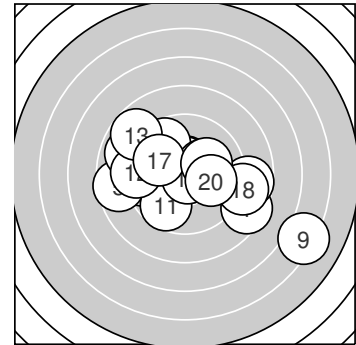

Serie 1: 93.6 (88)

8.5 ↘ 10.5* ↑ 10.6* ←
 10.6* ↙ 10.5* ↑ 9.7 ↘
beste Teiler: 78.2 (6.), 90.3 (3.), 102.0 (7.)
Trefferlage: 0.12 mm links, 0.32 mm tief
Streuwert: 3.84, horizontal: 4.84, vertikal: 2.45

9.5 ← 8.6 ←
 6.2 ↘ 8.9 ↙

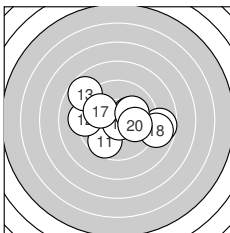

Serie 2: 96.4 (91)

9.7 ↙ 9.2 ← 8.8 ↘ 10.3* ↗
 10.8* ↘ 9.9 ↙ 8.9 → 10.1 ↗
beste Teiler: 41.3 (16.), 175.7 (14.), 210.6 (19.)
Trefferlage: 0.40 mm rechts, 0.09 mm hoch
Streuwert: 2.74, horizontal: 3.50, vertikal: 1.67

8.7 →
 10.0 →



Ergebnis: 191.6 (183)
Serien: 93.5 98.1
Zähler: 6 11 3 0 0 0 0 0 0 0 0
Innenzehner: 4
Weiteste: 635 (13.), 573 (8.), 530 (7.)
beste Teiler: 8.0 (14.), 178.9 (16.), 188.7 (12.)
Trefferlage: 1.19 mm links, 0.03 mm hoch
Streuwert: 2.58, horizontal: 3.18, vertikal: 1.79

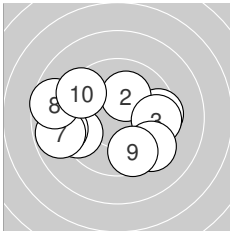
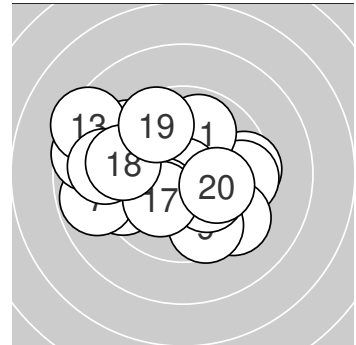

Serie 1: 93.5 (89)

9.5 →	10.1 ↑	9.6 →	9.4 ↘	9.4 ←
9.0 ←	8.8 ←	8.7 ←	9.6 ↓	9.4 ↙

beste Teiler: 202.0 (2.), 333.9 (9.), 347.7 (3.)
Trefferlage: 1.02 mm links, 0.41 mm tief
Streuwert: 2.98, horizontal: 3.82, vertikal: 1.80

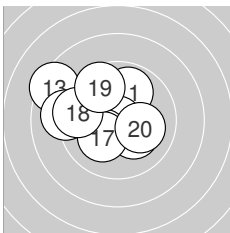

Serie 2: 98.1 (94)

9.9 ↑	10.2* ↘	8.4 ↖	10.9* ↓	9.1 ←
10.2* ↙	10.2* ↘	9.5 ←	9.6 ↘	10.1 →

beste Teiler: 8.0 (14.), 178.9 (16.), 188.7 (12.)
Trefferlage: 1.36 mm links, 0.48 mm hoch
Streuwert: 2.21, horizontal: 2.59, vertikal: 1.75



Ergebnis: 183.5 (176)
Serien: 95.6 87.9
Zähler: 5 7 7 1 0 0 0 0 0 0 0
Innenzehner: 4
Weiteste: 911 (13.), 737 (20.), 692 (14.)
beste Teiler: 145.7 (6.), 184.3 (4.), 184.7 (1.)
Trefferlage: 0.50 mm links, 0.29 mm tief
Streuwert: 3.55, horizontal: 3.67, vertikal: 3.41

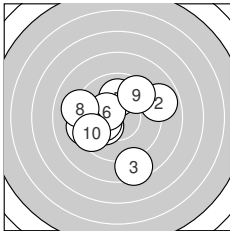
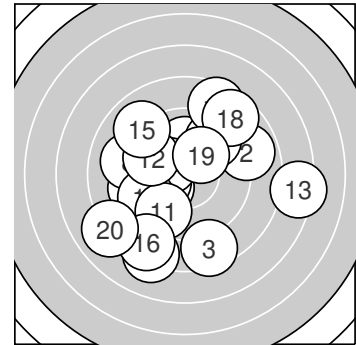

Serie 1: 95.6 (92)

10.2* ↙ 8.9 → 8.5 ↓ 10.2* ↙ 10.0 ↑
 10.4* ↖ 9.3 ← 9.1 ← 9.5 ↗ 9.5 ↖
beste Teiler: 145.7 (6.), 184.3 (4.), 184.7 (1.)
Trefferlage: 0.69 mm links, 0.19 mm tief
Streuwert: 2.76, horizontal: 2.98, vertikal: 2.53

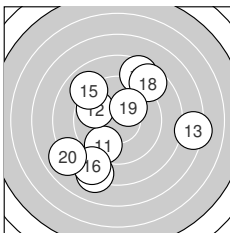

Serie 2: 87.9 (84)

9.6 ↙ 9.8 ↖ 7.3 → 8.2 ↙ 9.0 ↖
 8.5 ↙ 8.6 ↗ 8.7 ↗ 10.2* ↗ 8.0 ↖
beste Teiler: 198.7 (19.), 298.7 (12.), 340.9 (11.)
Trefferlage: 0.31 mm links, 0.39 mm tief
Streuwert: 4.34, horizontal: 4.42, vertikal: 4.27



Ergebnis: 189.3 (179)
Serien: 98.5 90.8
Zähler: 6 9 4 0 1 0 0 0 0 0 0
Innenzehner: 5
Weiteste: 1003 (15.), 572 (19.), 553 (3.)
beste Teiler: 63.8 (2.), 141.1 (1.), 153.6 (9.)
Trefferlage: 0.49 mm rechts, 0.91 mm hoch
Streuwert: 3.00, horizontal: 3.36, vertikal: 2.58

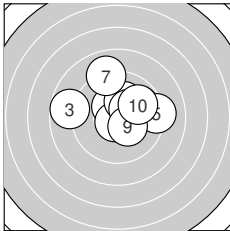
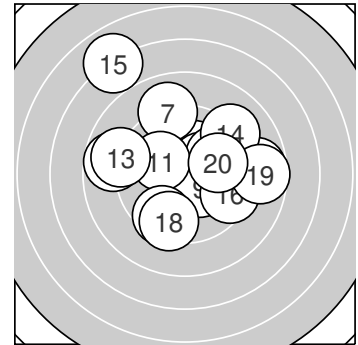

Serie 1: 98.5 (94)

10.4* ↖ 10.7* ↙ 8.7 ← 9.8 ↗ 9.2 →
 10.2* ↗ 9.0 ↑ 10.3* ↘ 10.3* ↘ 9.9 ↗
beste Teiler: 63.8 (2.), 141.1 (1.), 153.6 (9.)
Trefferlage: 0.45 mm rechts, 1.12 mm hoch
Streuwert: 2.18, horizontal: 2.68, vertikal: 1.55

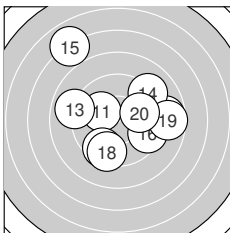

Serie 2: 90.8 (85)

10.1 ↖ 8.8 → 8.9 ← 9.1 ↗ 6.9 ↖
 9.5 ↘ 9.5 ↙ 9.4 ↓ 8.7 → 9.9 →
beste Teiler: 210.7 (11.), 265.3 (20.), 358.1 (17.)
Trefferlage: 0.53 mm rechts, 0.69 mm hoch
Streuwert: 3.76, horizontal: 4.09, vertikal: 3.40



Ergebnis: **191.9** (181)
 Serien: 98.1 93.8
 Zähler: 8 6 5 1 0 0 0 0 0 0 0
 Innenzehner: 6
 Weitesten: 817 (17.), 646 (19.), 607 (16.)
 beste Teiler: 36.8 (12.), 109.0 (10.), 124.5 (3.)
 Trefferlage: 0.49 mm links, 0.19 mm tief
 Streuwert: 2.86, horizontal: 3.77, vertikal: 1.45

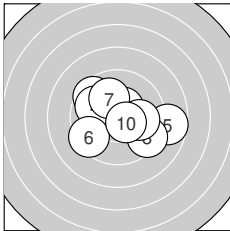
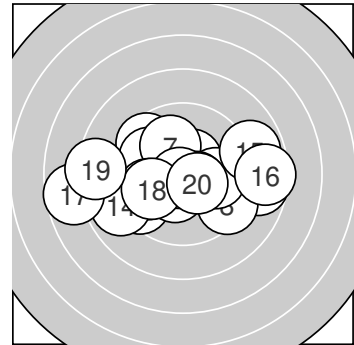

Serie 1: 98.1 (94)

10.2* ↖ 9.5 ↘ 10.5* ↗ 9.9 ↖ 8.7 →
 9.4 ↙ 10.0 ↖ 9.4 ↘ 10.0 → 10.5* ↘
 beste Teiler: 109.0 (10.), 124.5 (3.), 181.4 (1.)
 Trefferlage: 0.28 mm rechts, 0.23 mm hoch
 Streuwert: 2.32, horizontal: 2.83, vertikal: 1.67

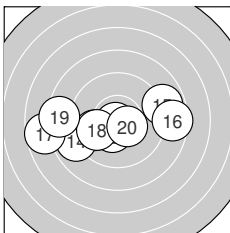

Serie 2: 93.8 (87)

10.4* ↙ 10.8* ↙ 9.8 ↖ 8.9 ↖ 8.9 →
 8.5 → 7.7 ↖ 9.9 ↖ 8.4 ← 10.5* ↘
 beste Teiler: 36.8 (12.), 125.9 (20.), 144.1 (11.)
 Trefferlage: 1.26 mm links, 0.61 mm tief
 Streuwert: 3.31, horizontal: 4.54, vertikal: 1.12



Ergebnis: **206.7** (197)
 Serien: 102.2 104.5
 Zähler: 17 3 0 0 0 0 0 0 0 0 0
 Innenzehner: 14
 Weitesten: 401 (5.), 337 (8.), 300 (4.)
 beste Teiler: 9.0 (3.), 43.6 (16.), 53.0 (17.)
 Trefferlage: 0.23 mm links, 0.02 mm hoch
 Streuwert: 1.33, horizontal: 1.78, vertikal: 0.62

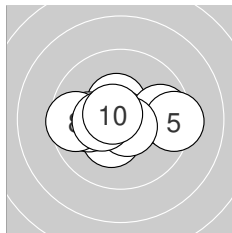
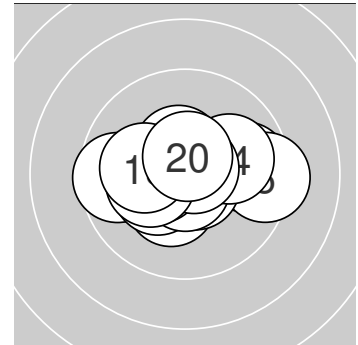

Serie 1: 102.2 (97)

10.3* ↙	10.5* ↑	10.9* ←	9.8 →	9.3 →
10.0 ←	10.7* ↘	9.6 ←	10.4* ←	10.7* ↘

beste Teiler: 9.0 (3.), 71.0 (10.), 74.2 (7.)
 Trefferlage: 0.13 mm links, 0.06 mm tief
 Streuwert: 1.65, horizontal: 2.24, vertikal: 0.66

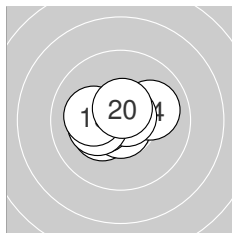

Serie 2: 104.5 (100)

10.3* ↙	10.7* ↓	10.4* ←	10.0 →	10.7* ↑
10.8* ↑	10.7* ↗	10.2* ←	10.1 ←	10.6* ↑

beste Teiler: 43.6 (16.), 53.0 (17.), 61.0 (12.)
 Trefferlage: 0.33 mm links, 0.12 mm hoch
 Streuwert: 1.00, horizontal: 1.28, vertikal: 0.59



Ergebnis: 187.8 (179)
Serien: 94.3 93.5
Zähler: 6 9 3 2 0 0 0 0 0 0 0
Innenzehner: 4
Weiteste: 971 (3.), 792 (6.), 748 (15.)
beste Teiler: 20.1 (19.), 51.7 (8.), 91.9 (4.)
Trefferlage: 0.97 mm rechts, 1.06 mm tief
Streuwert: 3.19, horizontal: 3.80, vertikal: 2.43

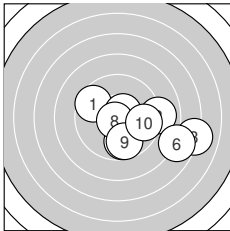
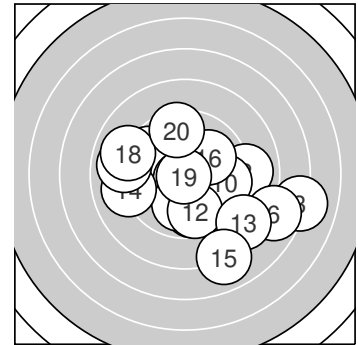

Serie 1: 94.3 (89)

9.6 ↖ 9.0 → 7.1 →
 7.8 → 10.4* ↓ 10.7* ↙
beste Teiler: 51.7 (8.), 91.9 (4.), 145.3 (7.)
Trefferlage: 2.42 mm rechts, 1.13 mm tief
Streuwert: 2.93, horizontal: 3.78, vertikal: 1.70

10.6* ↗ 9.8 ↓
 9.7 ↓ 9.6 →

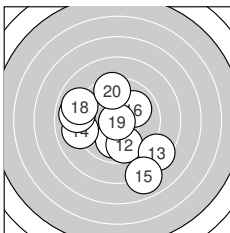

Serie 2: 93.5 (90)

10.0 ↓ 9.7 ↓ 8.5 ↘ 9.0 ←
 10.0 ↗ 8.9 ← 9.0 ↖ 10.9* ↙ 9.5 ↑
beste Teiler: 20.1 (19.), 236.6 (16.), 245.5 (11.)
Trefferlage: 0.47 mm links, 1.00 mm tief
Streuwert: 3.25, horizontal: 3.39, vertikal: 3.09

9.0 ← 8.0 ↓
 10.9* ↙ 9.5 ↑



Ergebnis: 182.6 (173)
Serien: 92.0 90.6
Zähler: 4 8 5 3 0 0 0 0 0 0 0
Innenzehner: 4
Weiteste: 885 (7.), 840 (15.), 790 (18.)
beste Teiler: 58.8 (20.), 96.0 (3.), 142.0 (10.)
Trefferlage: 1.64 mm links, 0.90 mm hoch
Streuwert: 3.44, horizontal: 4.22, vertikal: 2.42

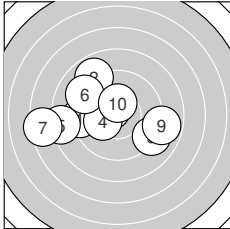
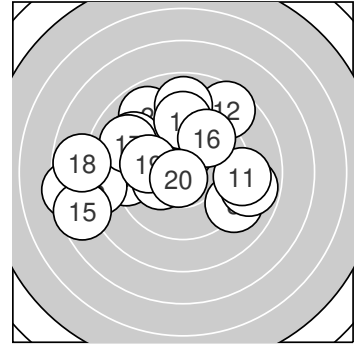

Serie 1: 92.0 (88)

9.2 ←	8.9 ↖	10.6* ↖	10.2* ←	8.3 ←
9.1 ↖	7.4 ←	9.1 ↗	8.8 →	10.4* ↑

beste Teiler: 96.0 (3.), 142.0 (10.), 185.5 (4.)
Trefferlage: 1.97 mm links, 0.16 mm hoch
Streuwert: 3.40, horizontal: 4.33, vertikal: 2.07

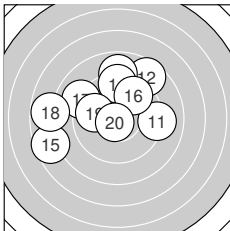

Serie 2: 90.6 (85)

9.1 →	8.6 ↗	8.9 ↑	9.3 ↑	7.6 ←
9.7 ↗	9.0 ↖	7.8 ←	9.9 ←	10.7* ↘

beste Teiler: 58.8 (20.), 274.5 (19.), 321.7 (16.)
Trefferlage: 1.31 mm links, 1.63 mm hoch
Streuwert: 3.57, horizontal: 4.32, vertikal: 2.62



Ergebnis: 186.9 (177)
Serien: 91.0 95.9
Zähler: 6 8 4 1 1 0 0 0 0 0 0
Innenzehner: 5
Weiteste: 1021 (4.), 881 (15.), 628 (8.)
beste Teiler: 85.0 (11.), 146.3 (12.), 150.4 (10.)
Trefferlage: 0.08 mm links, 1.10 mm tief
Streuwert: 3.32, horizontal: 3.03, vertikal: 3.59

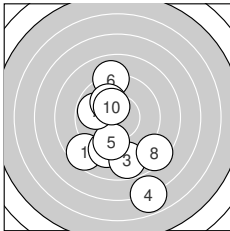
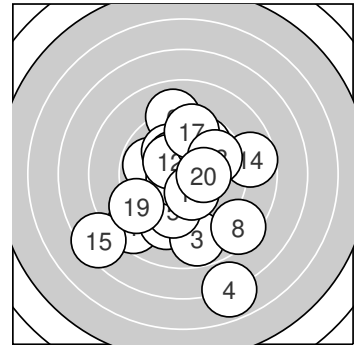

Serie 1: 91.0 (86)

8.6 ↙	9.3 ↓	8.8 ↓	6.9 ↓	9.7 ↓
9.0 ↑	9.8 ←	8.4 ↘	10.1 ↖	10.4* ↖

beste Teiler: 150.4 (10.), 219.2 (9.), 280.4 (7.)
Trefferlage: 0.21 mm links, 2.16 mm tief
Streuwert: 3.54, horizontal: 2.69, vertikal: 4.22

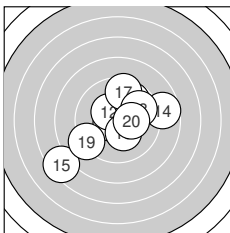

Serie 2: 95.9 (91)

10.6* ↙	10.4* ↖	9.8 ↗	8.7 →	7.4 ↙
10.3* ↓	9.5 ↑	9.8 ↗	9.1 ↙	10.3* →

beste Teiler: 85.0 (11.), 146.3 (12.), 168.1 (16.)
Trefferlage: 0.03 mm rechts, 0.04 mm tief
Streuwert: 3.08, horizontal: 3.48, vertikal: 2.62

