

Ergebnis:	<b>386</b>	(402.0)
Serien:	98 95 97 96	
Zähler:	27 12 1 0 0 0 0 0 0 0	
Innenzehner:	19	
weiteste:	519 (33), 481 (31), 476 (3)	
beste Teiler	56.0 (37.) 67.3 (25.) 69.7 (10.)	
Trefferlage	0.46 mm links, 0.32 mm tief	
Streuwert	1.82, horizontal: 1.67, vertikal: 1.95	

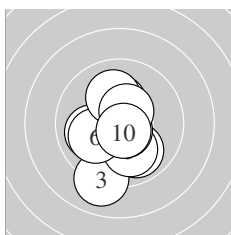

Serie 1:

9.9 ↘	10.3 *	9.0 ↓	10.0 ←	10.0 ↓
10.1 ↙	10.1 ↑	10.7 *	10.5 *	10.7 *
beste Teiler	69.7 (10.) 74.4 (8.) 111.5 (9.)			
Trefferlage	0.27 mm links, 0.70 mm tief			
Streuwert	1.66, horizontal: 1.24, vertikal: 1.99			

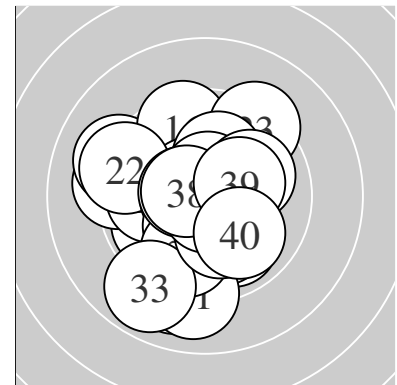
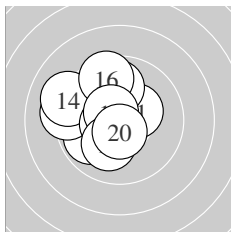

Serie 2:

10.3 *	9.9 ↙	9.2 ←	9.1 ↖	9.9 ↑
9.5 ↑	10.5 *	10.6 *	10.1 ↓	10.6 *
beste Teiler	94.0 (20.) 95.5 (18.) 108.2 (17.)			
Trefferlage	1.34 mm links, 0.53 mm hoch			
Streuwert	1.76, horizontal: 1.79, vertikal: 1.72			

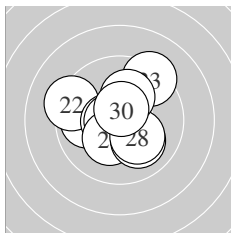

Serie 3:

9.9 ←	9.3 ↖	9.3 ↗	10.6 *	10.7 *
10.3 *	10.0 ↘	10.2 *	10.2 *	10.6 *
beste Teiler	67.3 (25.) 92.0 (30.) 95.5 (24.)			
Trefferlage	0.28 mm links, 0.28 mm hoch			
Streuwert	1.79, horizontal: 1.95, vertikal: 1.62			

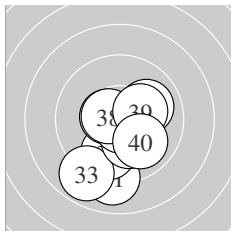

Serie 4:

9.0 ↓	9.8 ↓	8.9 ↓	10.0 →	10.2 *
10.5 *	10.7 *	10.6 *	10.2 *	10.0 ↘
beste Teiler	56.0 (37.) 92.8 (38.) 104.7 (36.)			
Trefferlage	0.02 mm rechts, 1.40 mm tief			
Streuwert	1.83, horizontal: 1.54, vertikal: 2.07			

Unterschrift des Schützen

Ergebnis: **389** (409.3)  
 Serien: 97 98 98 96  
 Zähler: 29 11 0 0 0 0 0 0 0 0  
 Innenzehner: 25  
 weiteste: 436 (34), 416 (27), 354 (3)  
 beste Teiler 19.8 (28.) 53.3 (7.) 60.0 (2.)  
 Trefferlage 0.12 mm links, 0.25 mm hoch  
 Streuwert 1.48, horizontal: 1.89, vertikal: 0.89

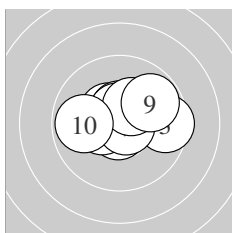
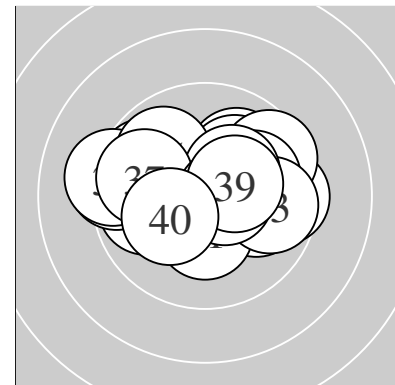

Serie 1:  
 10.5 \*                      10.7 \*                      9.5 →                      10.4 \*                      10.5 \*  
 10.6 \*                      10.7 \*                      10.3 \*                      9.8 ↗                      9.9 ←  
 beste Teiler 53.3 (7.) 60.0 (2.) 88.1 (6.)  
 Trefferlage 0.20 mm rechts, 0.45 mm hoch  
 Streuwert 1.37, horizontal: 1.79, vertikal: 0.75

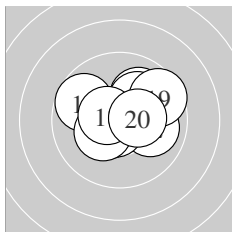

Serie 2:  
 10.0 ↗                      10.0 →                      10.1 ↗                      10.5 \*                      10.7 \*  
 9.7 ↖                      10.3 \*                      10.5 \*                      9.6 ↗                      10.4 \*  
 beste Teiler 70.7 (15.) 103.4 (18.) 115.7 (14.)  
 Trefferlage 0.33 mm rechts, 0.41 mm hoch  
 Streuwert 1.52, horizontal: 1.84, vertikal: 1.11

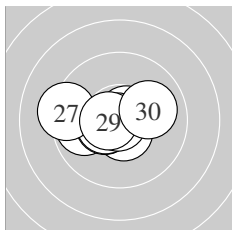

Serie 3:  
 10.7 \*                      10.7 \*                      10.6 \*                      9.8 ←                      10.5 \*  
 10.5 \*                      9.3 ←                      10.9 \*                      10.6 \*                      10.0 →  
 beste Teiler 19.8 (28.) 62.4 (21.) 65.6 (22.)  
 Trefferlage 0.73 mm links, 0.10 mm tief  
 Streuwert 1.30, horizontal: 1.75, vertikal: 0.56

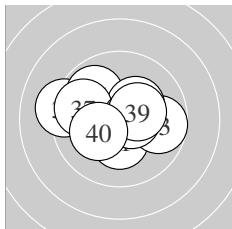

Serie 4:  
 10.3 \*                      10.6 \*                      9.7 →                      9.2 ←                      9.9 ↖  
 10.3 \*                      9.8 ←                      10.6 \*                      10.4 \*                      10.2 \*  
 beste Teiler 92.0 (38.) 96.8 (32.) 148.9 (39.)  
 Trefferlage 0.31 mm links, 0.24 mm hoch  
 Streuwert 1.76, horizontal: 2.26, vertikal: 1.04

Unterschrift des Schützen

Meyton Elektronik

Ergebnis: **387** (404.6)  
 Serien: 97 98 97 95  
 Zähler: 28 11 1 0 0 0 0 0 0 0  
 Innenzehner: 23  
 weiteste: 528 (5), 460 (34), 439 (28)  
 beste Teiler 46.6 (14.) 69.3 (22.) 76.6 (8.)  
 Trefferlage 0.12 mm rechts, 0.54 mm hoch  
 Streuwert 1.70, horizontal: 1.90, vertikal: 1.46

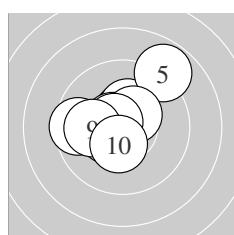
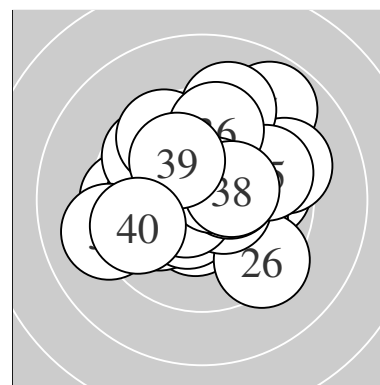

Serie 1:  
 10.5 \* 10.4 \* 10.3 \* 10.6 \* 8.8 ↗  
 9.6 ← 10.4 \* 10.6 \* 10.0 ← 10.4 \*  
 beste Teiler 76.6 (8.) 91.9 (4.) 112.0 (1.)  
 Trefferlage 0.43 mm links, 0.67 mm hoch  
 Streuwert 1.66, horizontal: 1.80, vertikal: 1.50

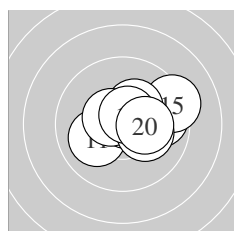

Serie 2:  
 10.0 ↙ 10.3 \* 9.8 → 10.8 \* 9.3 →  
 10.3 \* 10.5 \* 10.2 \* 10.6 \* 10.3 \*  
 beste Teiler 46.6 (14.) 81.8 (19.) 105.3 (17.)  
 Trefferlage 1.01 mm rechts, 0.41 mm hoch  
 Streuwert 1.35, horizontal: 1.71, vertikal: 0.84

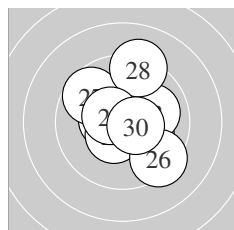

Serie 3:  
 10.1 ↘ 10.7 \* 10.0 → 10.5 \* 10.5 \*  
 9.4 ↘ 9.7 ↘ 9.2 ↑ 10.5 \* 10.5 \*  
 beste Teiler 69.3 (22.) 105.7 (30.) 106.0 (29.)  
 Trefferlage 0.33 mm rechts, 0.30 mm hoch  
 Streuwert 1.80, horizontal: 1.72, vertikal: 1.89

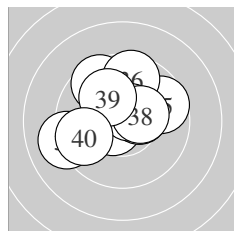

Serie 4:  
 9.6 ↘ 10.6 \* 10.4 \* 9.1 ← 9.7 →  
 9.6 ↑ 10.6 \* 10.4 \* 10.1 ↘ 9.7 ←  
 beste Teiler 87.4 (32.) 88.2 (37.) 136.9 (33.)  
 Trefferlage 0.42 mm links, 0.78 mm hoch  
 Streuwert 1.94, horizontal: 2.22, vertikal: 1.60

Unterschrift des Schützen

Meyton Elektronik

Ergebnis:	<b>389</b>	(404.6)
Serien:	98 96 96 99	
Zähler:	29 11 0 0 0 0 0 0 0 0	
Innenzehner:	21	
weiteste:	493 (21), 405 (34), 396 (18)	
beste Teiler	56.4 (36.) 68.4 (7.) 74.9 (1.)	
Trefferlage	0.02 mm rechts, 0.48 mm hoch	
Streuwert	1.66, horizontal: 1.97, vertikal: 1.29	

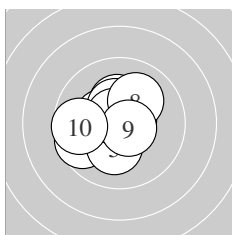
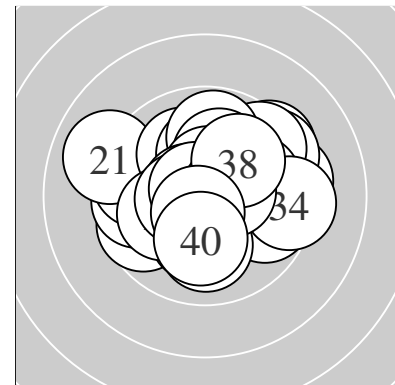

Serie 1:	10.7 *	10.3 *	10.4 *	9.6 ↙	10.2 *
	10.4 *	10.7 *	10.1 ↗	10.6 *	9.7 ←
beste Teiler	68.4 (7.) 74.9 (1.) 81.4 (9.)				
Trefferlage	0.62 mm links, 0.21 mm hoch				
Streuwert	1.37, horizontal: 1.50, vertikal: 1.22				

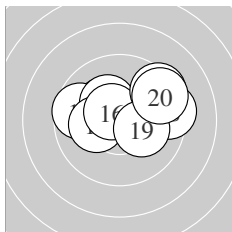

Serie 2:	10.3 *	9.7 ←	10.6 *	10.3 *	10.2 *
	10.6 *	9.4 ↗	9.4 →	10.2 *	9.4 ↗
beste Teiler	91.9 (16.) 99.6 (13.) 168.1 (14.)				
Trefferlage	0.31 mm rechts, 0.81 mm hoch				
Streuwert	1.86, horizontal: 2.46, vertikal: 0.94				

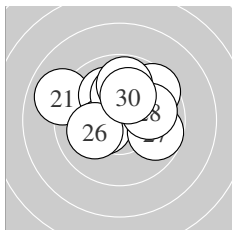

Serie 3:	9.0 ↖	10.1 ↖	10.4 *	9.6 ↗	10.2 *
	10.1 ←	9.7 →	10.0 →	9.8 ↑	10.1 ↑
beste Teiler	136.8 (23.) 200.2 (25.) 206.5 (30.)				
Trefferlage	0.00 mm , 1.12 mm hoch				
Streuwert	1.93, horizontal: 2.33, vertikal: 1.41				

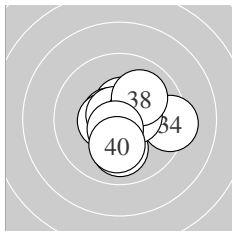

Serie 4:	10.5 *	10.6 *	10.5 *	9.3 →	10.0 ↓
	10.7 *	10.5 *	10.0 ↗	10.6 *	10.1 ↓
beste Teiler	56.4 (36.) 83.1 (32.) 87.3 (39.)				
Trefferlage	0.40 mm rechts, 0.20 mm tief				
Streuwert	1.40, horizontal: 1.52, vertikal: 1.26				

Unterschrift des Schützen

Ergebnis:	<b>377</b>	(394.4)
Serien:	95 93 96 93	
Zähler:	18 21 1 0 0 0 0 0 0 0	
Innenzehner:	13	
weiteste:	539 (1), 489 (3), 489 (40)	
beste Teiler	54.0 (5.) 73.6 (33.) 140.2 (36.)	
Trefferlage	1.03 mm rechts, 0.12 mm hoch	
Streuwert	1.97, horizontal: 1.65, vertikal: 2.25	

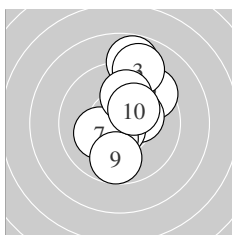
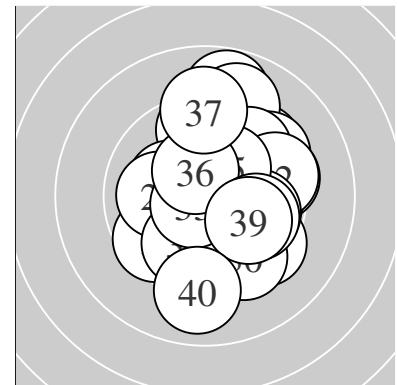

Serie 1:

8.8 ↑	9.5 ↗	9.0 ↑	10.3 *	10.7 *
10.4 *	10.2 *	10.0 ↑	9.8 ↓	10.3 *
beste Teiler	54.0 (5.)	146.6 (6.)	168.9 (4.)	
Trefferlage	0.61 mm rechts, 1.08 mm hoch			
Streuwert	2.09, horizontal: 1.31, vertikal: 2.64			

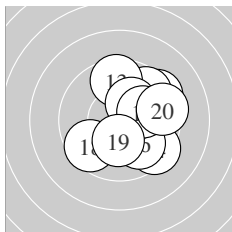

Serie 2:

9.4 ↗	9.6 ↗	9.6 ↑	9.4 ↘	10.2 *
9.9 ↘	10.1 →	9.6 ↖	10.2 *	9.4 →
beste Teiler	176.4 (19.)	176.7 (15.)	212.2 (17.)	
Trefferlage	1.39 mm rechts, 0.26 mm hoch			
Streuwert	2.05, horizontal: 1.92, vertikal: 2.17			

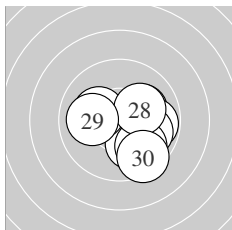

Serie 3:

10.1 →	10.2 *	10.0 ↘	9.8 →	10.2 *
9.9 ↘	9.8 ↘	10.2 *	10.0 ←	9.5 ↘
beste Teiler	189.7 (25.)	197.2 (28.)	200.3 (22.)	
Trefferlage	1.14 mm rechts, 0.57 mm tief			
Streuwert	1.61, horizontal: 1.76, vertikal: 1.46			

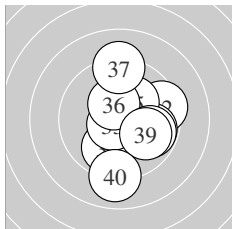

Serie 4:

9.9 ↓	9.4 →	10.7 *	9.8 →	10.2 *
10.4 *	9.2 ↑	9.8 ↘	9.9 ↘	9.0 ↓
beste Teiler	73.6 (33.)	140.2 (36.)	185.6 (35.)	
Trefferlage	0.97 mm rechts, 0.27 mm tief			
Streuwert	2.15, horizontal: 1.70, vertikal: 2.52			

Unterschrift des Schützen

Meyton Elektronik

Ergebnis: **380** (397.6)  
 Serien: 94 96 95 95  
 Zähler: 20 20 0 0 0 0 0 0 0 0  
 Innenzehner: 12  
 weiteste: 439 (16), 399 (4), 396 (25)  
 beste Teiler 84.4 (11.) 87.4 (31.) 102.5 (15.)  
 Trefferlage 0.14 mm rechts, 0.47 mm tief  
 Streuwert 1.91, horizontal: 1.81, vertikal: 2.00

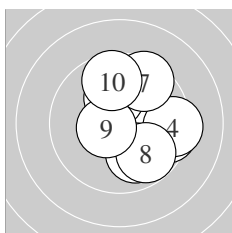
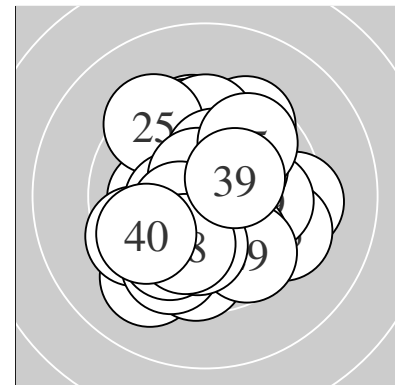

Serie 1:  
 9.5 → 10.1 ↘ 10.5 \* 9.4 → 10.2 \*  
 9.9 ↘ 9.5 ↗ 9.8 ↘ 10.5 \* 9.7 ↑  
 beste Teiler 104.6 (9.) 107.3 (3.) 193.8 (5.)  
 Trefferlage 1.31 mm rechts, 0.06 mm hoch  
 Streuwert 1.84, horizontal: 1.67, vertikal: 2.00

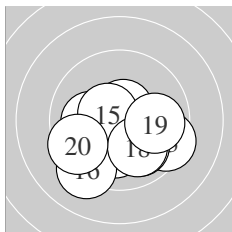

Serie 2:  
 10.6 \* 10.1 ← 9.4 ↘ 10.1 ↓ 10.5 \*  
 9.2 ↙ 10.0 ↘ 10.0 ↘ 9.9 → 9.5 ↖  
 beste Teiler 84.4 (11.) 102.5 (15.) 210.4 (14.)  
 Trefferlage 0.02 mm rechts, 1.20 mm tief  
 Streuwert 1.86, horizontal: 2.22, vertikal: 1.39

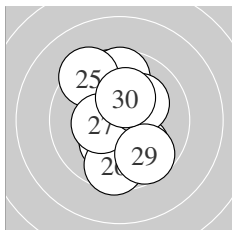

Serie 3:  
 10.0 ↘ 9.7 ↑ 9.7 ↑ 10.2 \* 9.4 ↖  
 9.6 ↓ 10.4 \* 10.2 \* 9.7 ↘ 10.3 \*  
 beste Teiler 140.2 (27.) 173.6 (30.) 179.3 (24.)  
 Trefferlage 0.03 mm links, 0.26 mm hoch  
 Streuwert 2.03, horizontal: 1.36, vertikal: 2.53

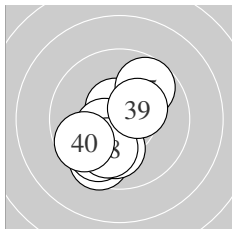

Serie 4:  
 10.6 \* 9.8 ↙ 10.4 \* 9.6 ↙ 9.7 ↗  
 9.8 ↙ 10.1 ↓ 10.0 ↓ 10.3 \* 9.7 ↖  
 beste Teiler 87.4 (31.) 132.0 (33.) 156.0 (39.)  
 Trefferlage 0.73 mm links, 1.01 mm tief  
 Streuwert 1.62, horizontal: 1.45, vertikal: 1.77

Unterschrift des Schützen

Meyton Elektronik

Ergebnis: **365** (382.1)  
 Serien: 92 93 91 89  
 Zähler: 13 20 6 1 0 0 0 0 0 0  
 Innenzehner: 8  
 weiteste: 799 (39), 744 (23), 716 (15)  
 beste Teiler 85.3 (29.) 105.6 (26.) 136.2 (25.)  
 Trefferlage 1.48 mm rechts, 0.23 mm tief  
 Streuwert 2.62, horizontal: 3.20, vertikal: 1.86

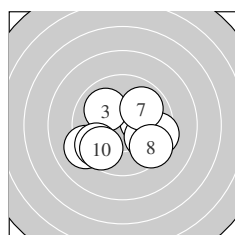
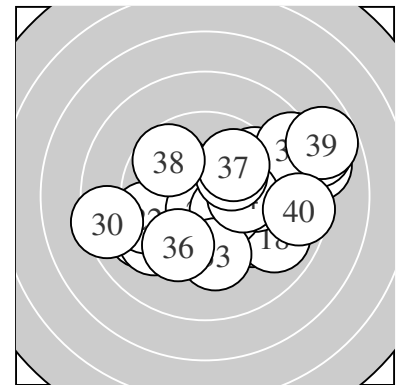

Serie 1:  
 9.6 ↘ 10.2 \* 10.0 ↘ 9.9 ↘ 9.5 ↘  
 9.2 ↙ 9.9 ↗ 9.5 ↘ 9.6 ↙ 9.6 ↙  
 beste Teiler 199.4 (2.) 237.1 (3.) 261.4 (7.)  
 Trefferlage 0.52 mm rechts, 0.91 mm tief  
 Streuwert 2.28, horizontal: 2.81, vertikal: 1.59

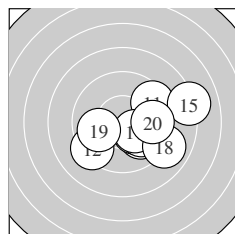

Serie 2:  
 9.5 ↗ 9.3 ↙ 10.0 ↘ 10.3 \* 8.1 →  
 10.0 ↘ 10.3 \* 9.0 ↘ 9.9 ← 9.7 →  
 beste Teiler 158.8 (17.) 163.6 (14.) 237.1 (16.)  
 Trefferlage 1.81 mm rechts, 0.70 mm tief  
 Streuwert 2.39, horizontal: 2.97, vertikal: 1.62

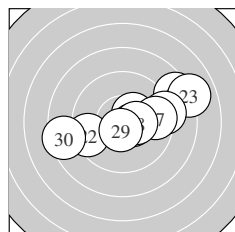

Serie 3:  
 8.5 ↗ 9.4 ← 8.0 ↗ 9.2 → 10.4 \*  
 10.5 \* 9.6 → 10.4 \* 10.6 \* 8.4 ←  
 beste Teiler 85.3 (29.) 105.6 (26.) 136.2 (25.)  
 Trefferlage 1.37 mm rechts, 0.36 mm hoch  
 Streuwert 3.04, horizontal: 4.00, vertikal: 1.56

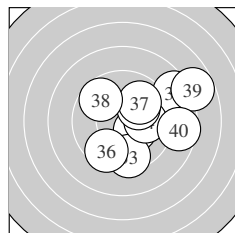

Serie 4:  
 10.3 \* 8.5 ↗ 9.5 ↓ 10.0 → 10.1 ↗  
 9.6 ↙ 9.9 ↗ 9.7 ↘ 7.8 → 8.6 →  
 beste Teiler 159.0 (31.) 212.5 (35.) 237.0 (34.)  
 Trefferlage 2.22 mm rechts, 0.32 mm hoch  
 Streuwert 2.80, horizontal: 3.13, vertikal: 2.43

Unterschrift des Schützen

Meyton Elektronik

Ergebnis: **377** (393.9)

Serien: 97 94 93 93

Zähler: 20 17 3 0 0 0 0 0 0 0

Innenzehner: 13

weiteste: 561 (25), 550 (12), 524 (32)

beste Teiler 54.7 (20.) 105.1 (4.) 117.0 (24.)

Trefferlage 0.33 mm rechts, 0.68 mm hoch

Streuwert 2.11, horizontal: 2.57, vertikal: 1.50

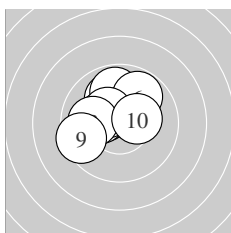
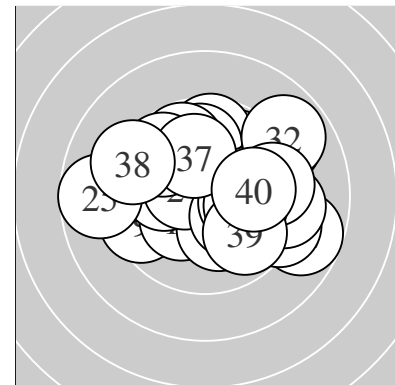

Serie 1:

10.0 ↖	9.8 ↑	10.4 *	10.5 *	10.2 *
9.8 ↗	10.4 *	10.0 ←	9.5 ←	10.3 *

beste Teiler 105.1 (4.) 143.0 (7.) 146.3 (3.)

Trefferlage 0.75 mm links, 0.94 mm hoch

Streuwert 1.43, horizontal: 1.62, vertikal: 1.22

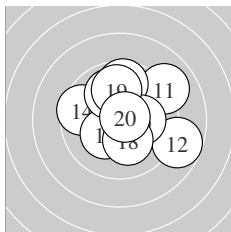

Serie 2:

9.0 ↗	8.8 ↘	9.7 ↑	9.6 ←	10.3 *
10.2 *	10.0 ↖	10.2 *	9.9 ↑	10.7 *

beste Teiler 54.7 (20.) 175.4 (15.) 188.0 (16.)

Trefferlage 0.66 mm rechts, 0.72 mm hoch

Streuwert 2.25, horizontal: 2.49, vertikal: 1.97

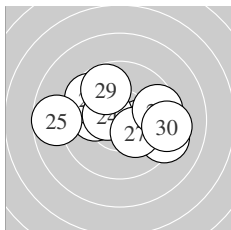

Serie 3:

10.1 ←	10.2 *	9.6 ↘	10.5 *	8.7 ←
9.2 ↘	10.2 *	9.6 →	9.8 ↖	9.3 →

beste Teiler 117.0 (24.) 177.6 (27.) 195.3 (22.)

Trefferlage 0.21 mm rechts, 0.28 mm hoch

Streuwert 2.49, horizontal: 3.27, vertikal: 1.32

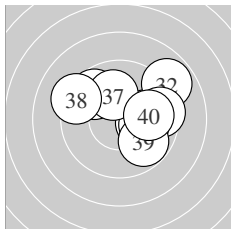

Serie 4:

10.0 →	8.9 ↗	9.5 →	10.2 *	9.7 ↖
10.1 →	10.1 ↖	9.2 ↘	9.8 ↘	9.9 →

beste Teiler 191.2 (34.) 221.7 (37.) 222.9 (36.)

Trefferlage 1.23 mm rechts, 0.77 mm hoch

Streuwert 2.14, horizontal: 2.61, vertikal: 1.54

Unterschrift des Schützen



Ergebnis: **389** (408.3)  
 Serien: 95 98 99 97  
 Zähler: 29 11 0 0 0 0 0 0 0 0  
 Innenzehner: 24  
 weiteste: 420 (17), 407 (10), 388 (5)  
 beste Teiler 25.0 (12.) 26.6 (40.) 40.5 (16.)  
 Trefferlage 0.08 mm rechts, 0.01 mm tief  
 Streuwert 1.53, horizontal: 1.77, vertikal: 1.24

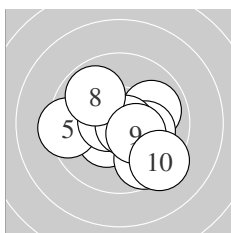
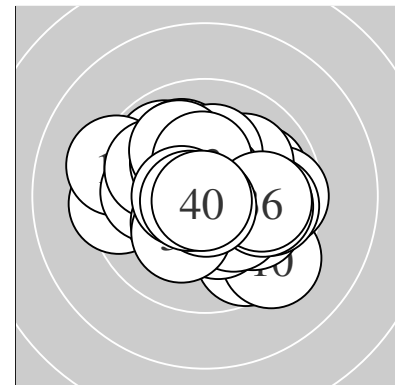

Serie 1:  
 9.9 → 10.2 \* 10.4 \* 9.7 ↘ 9.4 ←  
 10.6 \* 10.8 \* 9.9 ↖ 10.4 \* 9.3 ↘  
 beste Teiler 44.9 (7.) 90.0 (6.) 142.2 (3.)  
 Trefferlage 0.31 mm rechts, 0.52 mm tief  
 Streuwert 1.85, horizontal: 2.16, vertikal: 1.47

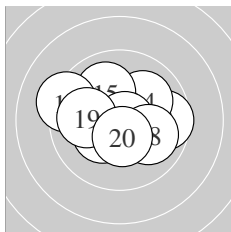

Serie 2:  
 9.6 → 10.9 \* 10.3 \* 10.1 ↗ 10.0 ↖  
 10.8 \* 9.3 ← 10.0 ↘ 10.0 ← 10.5 \*  
 beste Teiler 25.0 (12.) 40.5 (16.) 124.6 (20.)  
 Trefferlage 0.07 mm links, 0.15 mm hoch  
 Streuwert 1.75, horizontal: 2.19, vertikal: 1.14

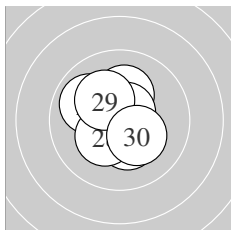

Serie 3:  
 10.6 \* 10.3 \* 10.5 \* 9.9 ↖ 10.3 \*  
 10.2 \* 10.7 \* 10.3 \* 10.2 \* 10.3 \*  
 beste Teiler 73.6 (27.) 89.8 (21.) 101.2 (23.)  
 Trefferlage 0.30 mm links, 0.33 mm hoch  
 Streuwert 1.16, horizontal: 1.04, vertikal: 1.28

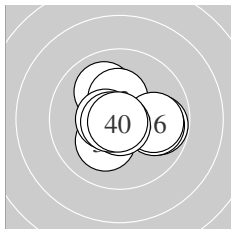

Serie 4:  
 9.8 → 10.0 ↖ 10.3 \* 9.9 → 10.2 \*  
 9.9 → 10.5 \* 10.8 \* 10.7 \* 10.8 \*  
 beste Teiler 26.6 (40.) 48.2 (38.) 70.5 (39.)  
 Trefferlage 0.38 mm rechts, 0.01 mm tief  
 Streuwert 1.38, horizontal: 1.63, vertikal: 1.06

Unterschrift des Schützen

Ergebnis: **395** (415.2)  
 Serien: 98 99 99 99  
 Zähler: 35 5 0 0 0 0 0 0 0 0  
 Innenzehner: 34  
 weiteste: 352 (2), 298 (27), 289 (6)  
 beste Teiler 49.6 (28.) 62.2 (3.) 65.7 (26.)  
 Trefferlage 0.34 mm rechts, 0.02 mm hoch  
 Streuwert 1.12, horizontal: 1.22, vertikal: 1.00

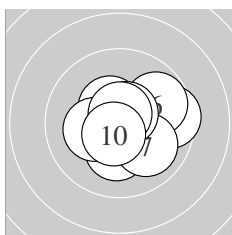
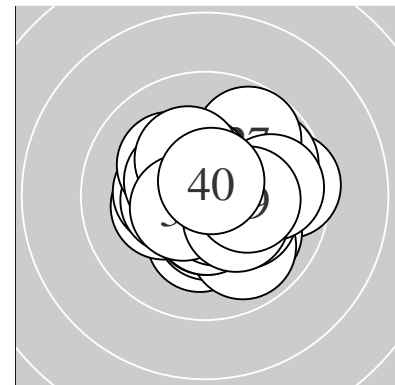

Serie 1:  
 10.4 \* 9.5 → 10.7 \* 10.2 \* 10.2 \*  
 9.8 ↗ 10.0 ↘ 10.6 \* 10.7 \* 10.6 \*  
 beste Teiler 62.2 (3.) 66.0 (9.) 82.6 (8.)  
 Trefferlage 0.59 mm rechts, 0.02 mm tief  
 Streuwert 1.36, horizontal: 1.59, vertikal: 1.08

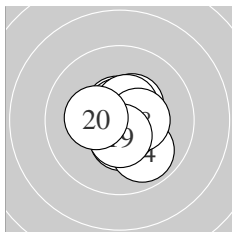

Serie 2:  
 10.4 \* 10.4 \* 10.6 \* 9.9 ↘ 10.7 \*  
 10.6 \* 10.5 \* 10.4 \* 10.5 \* 10.3 \*  
 beste Teiler 70.5 (15.) 80.5 (16.) 87.0 (13.)  
 Trefferlage 0.28 mm rechts, 0.15 mm tief  
 Streuwert 1.01, horizontal: 0.90, vertikal: 1.10

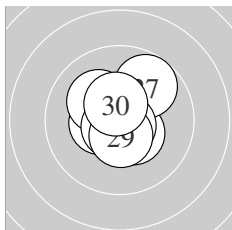

Serie 3:  
 10.6 \* 10.6 \* 10.4 \* 10.4 \* 10.2 \*  
 10.7 \* 9.8 ↗ 10.8 \* 10.5 \* 10.5 \*  
 beste Teiler 49.6 (28.) 65.7 (26.) 82.8 (21.)  
 Trefferlage 0.09 mm links, 0.25 mm hoch  
 Streuwert 1.06, horizontal: 1.02, vertikal: 1.10

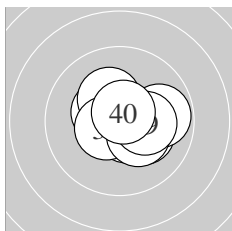

Serie 4:  
 10.7 \* 10.4 \* 10.6 \* 10.2 \* 10.3 \*  
 10.5 \* 9.8 → 10.3 \* 10.2 \* 10.7 \*  
 beste Teiler 68.1 (40.) 70.2 (31.) 85.4 (33.)  
 Trefferlage 0.61 mm rechts, 0.01 mm hoch  
 Streuwert 1.08, horizontal: 1.30, vertikal: 0.79

Unterschrift des Schützen

Meyton Elektronik

Ergebnis: **385** (403.2)  
 Serien: 96 94 95 100  
 Zähler: 25 15 0 0 0 0 0 0 0 0  
 Innenzehner: 16  
 weiteste: 405 (10), 355 (30), 354 (9)  
 beste Teiler 29.9 (23.) 63.6 (2.) 70.6 (3.)  
 Trefferlage 0.22 mm links, 0.53 mm hoch  
 Streuwert 1.62, horizontal: 1.96, vertikal: 1.17

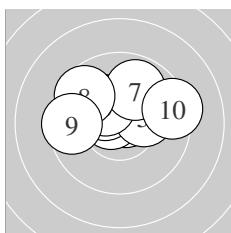
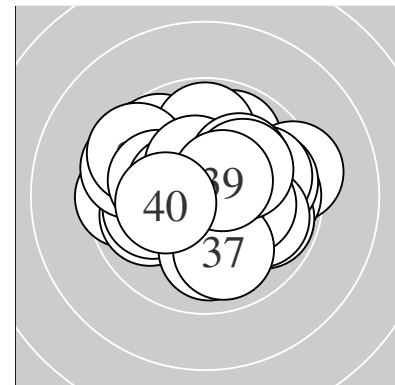

Serie 1:  
 10.1 ↖                      10.7 \*                      10.7 \*                      10.4 \*                      10.2 \*  
 10.3 \*                      9.9 ↗                      9.6 ↖                      9.5 ←                      9.3 →  
 beste Teiler 63.6 (2.) 70.6 (3.) 143.7 (4.)  
 Trefferlage 0.31 mm links, 1.04 mm hoch  
 Streuwert 1.65, horizontal: 2.20, vertikal: 0.79

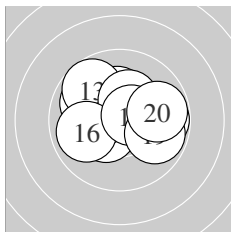

Serie 2:  
 9.9 ↖                      10.3 \*                      9.7 ↖                      10.4 \*                      10.3 \*  
 9.9 ←                      10.6 \*                      9.8 →                      9.8 →                      9.8 →  
 beste Teiler 95.0 (17.) 133.8 (14.) 161.6 (15.)  
 Trefferlage 0.20 mm rechts, 0.50 mm hoch  
 Streuwert 1.70, horizontal: 2.10, vertikal: 1.18

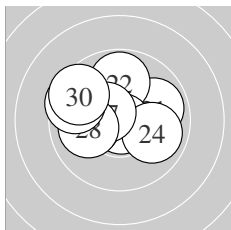

Serie 3:  
 9.9 →                      9.8 ↑                      10.8 \*                      9.9 ↘                      10.1 ←  
 10.0 ←                      10.5 \*                      10.0 ←                      9.5 ↖                      9.5 ↖  
 beste Teiler 29.9 (23.) 117.7 (27.) 220.1 (25.)  
 Trefferlage 0.91 mm links, 0.56 mm hoch  
 Streuwert 1.71, horizontal: 2.12, vertikal: 1.17

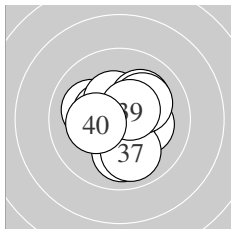

Serie 4:  
 10.1 ↖                      10.4 \*                      10.2 \*                      10.4 \*                      10.1 ↗  
 10.0 ↓                      10.0 ↓                      10.1 ↗                      10.5 \*                      10.2 \*  
 beste Teiler 102.7 (39.) 131.5 (32.) 140.4 (34.)  
 Trefferlage 0.12 mm rechts, 0.02 mm hoch  
 Streuwert 1.43, horizontal: 1.44, vertikal: 1.41

Unterschrift des Schützen

Meyton Elektronik

Ergebnis:	<b>382</b>	(399.4)
Serien:	96 94 95 97	
Zähler:	23 16 1 0 0 0 0 0 0 0	
Innenzehner:	16	
weiteste:	564 (29), 462 (11), 450 (13)	
beste Teiler	47.2 (16.) 53.3 (34.) 58.4 (40.)	
Trefferlage	0.21 mm rechts, 0.46 mm hoch	
Streuwert	1.93, horizontal: 2.21, vertikal: 1.61	

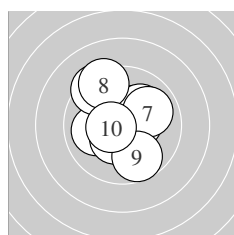
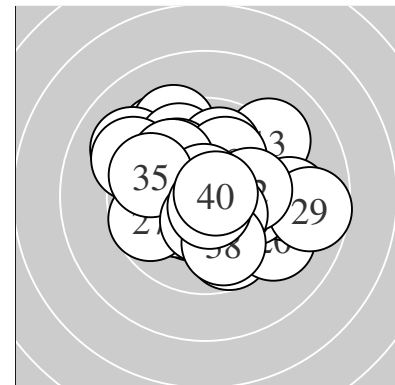

Serie 1:	10.0 ←	10.4 *	10.5 *	9.4 ↘	10.3 *
	10.1 ↗	9.9 ↗	9.3 ↘	9.7 ↓	10.5 *
beste Teiler	104.5 (10.)	124.7 (3.)	140.1 (2.)		
Trefferlage	0.08 mm links, 0.62 mm hoch				
Streuwert	1.84, horizontal: 1.73, vertikal: 1.95				

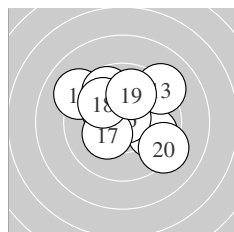

Serie 2:	9.1 ↘	9.8 ↘	9.2 ↗	9.7 ↘	10.3 *
	10.8 *	10.3 *	10.0 ↘	9.9 ↑	9.2 ↘
beste Teiler	47.2 (16.)	169.8 (15.)	171.2 (17.)		
Trefferlage	0.09 mm rechts, 0.94 mm hoch				
Streuwert	2.20, horizontal: 2.50, vertikal: 1.85				

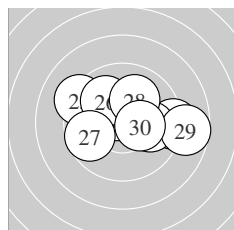

Serie 3:	9.2 →	10.0 →	9.2 ↘	10.7 *	10.3 *
	10.0 ↘	9.7 ←	10.1 ↑	8.7 →	10.3 *
beste Teiler	75.4 (24.)	158.2 (30.)	161.0 (25.)		
Trefferlage	0.68 mm rechts, 0.51 mm hoch				
Streuwert	2.31, horizontal: 3.03, vertikal: 1.24				

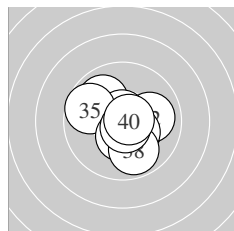

Serie 4:	10.4 *	10.0 →	9.9 ↘	10.7 *	9.7 ↘
	10.4 *	10.4 *	9.9 ↓	10.7 *	10.7 *
beste Teiler	53.3 (34.)	58.4 (40.)	62.7 (39.)		
Trefferlage	0.17 mm rechts, 0.21 mm tief				
Streuwert	1.41, horizontal: 1.54, vertikal: 1.27				

Unterschrift des Schützen

Meyton Elektronik

Ergebnis:	<b>385</b>	(401.9)
Serien:	95	97 98 95
Zähler:	26 13 1 0 0 0 0 0 0 0	
Innenzehner:	15	
weiteste:	524 (14), 429 (13), 407 (34)	
beste Teiler	42.5 (11.) 49.4 (22.) 55.5 (10.)	
Trefferlage	0.24 mm rechts, 0.17 mm tief	
Streuwert	1.80, horizontal: 1.80, vertikal: 1.81	

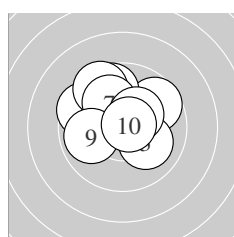
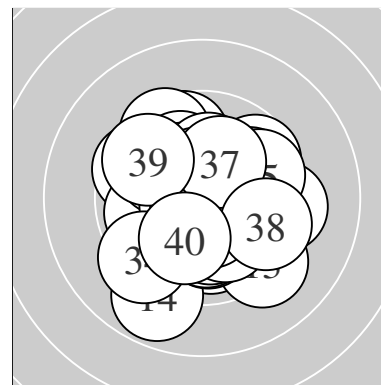

Serie 1:	10.4 *	9.7 ↗	10.1 ↘	9.6 ↖	9.7 ↑
	9.5 ↘	10.0 ↘	10.3 *	9.9 ←	10.7 *
beste Teiler	55.5 (10.)	148.9 (1.)	152.8 (8.)		
Trefferlage	0.40 mm links, 1.20 mm hoch				
Streuwert	1.68, horizontal: 1.89, vertikal: 1.43				

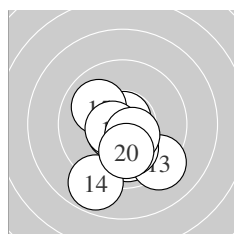

Serie 2:	10.8 *	10.0 ↓	9.2 ↘	8.9 ↙	10.0 ↘
	10.6 *	10.6 *	10.1 ↓	10.5 *	10.1 ↓
beste Teiler	42.5 (11.)	89.9 (17.)	91.9 (16.)		
Trefferlage	0.04 mm links, 1.45 mm tief				
Streuwert	1.65, horizontal: 1.48, vertikal: 1.81				

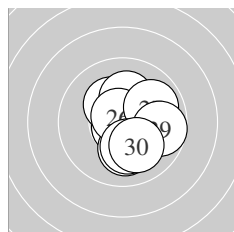

Serie 3:	10.2 *	10.8 *	10.3 *	10.1 ↓	10.2 *
	10.7 *	9.9 ↗	10.1 ↓	9.7 →	10.1 ↓
beste Teiler	49.4 (22.)	61.2 (26.)	173.0 (23.)		
Trefferlage	0.75 mm rechts, 0.19 mm tief				
Streuwert	1.38, horizontal: 1.27, vertikal: 1.48				

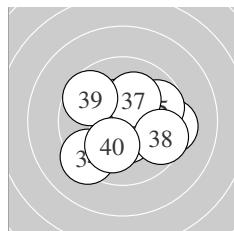

Serie 4:	10.1 →	9.4 →	10.5 *	9.3 ↙	9.7 →
	10.5 *	10.2 *	9.6 ↘	9.7 ↖	10.1 ↙
beste Teiler	122.9 (36.)	124.6 (33.)	197.2 (37.)		
Trefferlage	0.67 mm rechts, 0.23 mm tief				
Streuwert	2.04, horizontal: 2.36, vertikal: 1.66				

Unterschrift des Schützen

Ergebnis: **385** (404.1)  
 Serien: 97 94 98 96  
 Zähler: 25 15 0 0 0 0 0 0 0 0  
 Innenzehner: 22  
 weiteste: 468 (5), 446 (6), 421 (34)  
 beste Teiler 43.0 (37.) 45.3 (19.) 47.0 (40.)  
 Trefferlage 0.68 mm rechts, 0.34 mm tief  
 Streuwert 1.67, horizontal: 1.95, vertikal: 1.31

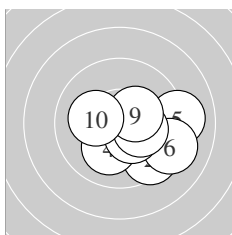
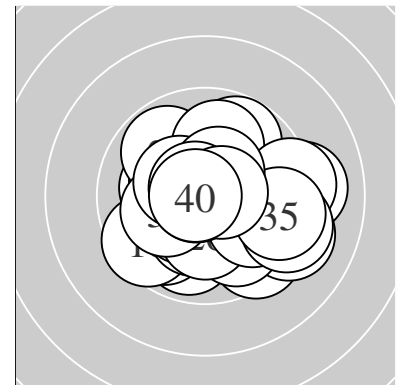

Serie 1:  
 10.2 \*                      9.5 ↘                      10.6 \*                      10.1 ↓                      9.1 →  
 9.2 ↘                      10.4 \*                      10.3 \*                      10.4 \*                      10.2 \*  
 beste Teiler 99.2 (3.) 141.4 (7.) 147.8 (9.)  
 Trefferlage 1.37 mm rechts, 0.74 mm tief  
 Streuwert 1.68, horizontal: 2.07, vertikal: 1.15

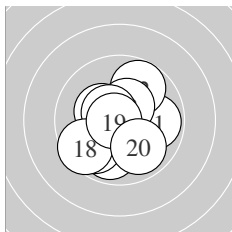

Serie 2:  
 9.9 →                      9.8 ↗                      10.4 \*                      9.9 ↓                      10.3 \*  
 9.8 ↙                      10.5 \*                      9.6 ↙                      10.8 \*                      9.9 ↘  
 beste Teiler 45.3 (19.) 105.4 (17.) 127.0 (13.)  
 Trefferlage 0.19 mm links, 0.40 mm tief  
 Streuwert 1.74, horizontal: 1.74, vertikal: 1.74

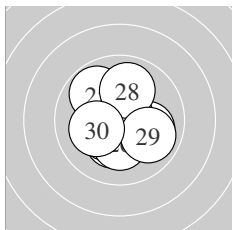

Serie 3:  
 10.3 \*                      10.5 \*                      10.4 \*                      10.0 →                      9.8 ↖  
 10.2 \*                      10.7 \*                      10.0 ↑                      9.9 →                      10.2 \*  
 beste Teiler 60.8 (27.) 106.0 (22.) 145.7 (23.)  
 Trefferlage 0.12 mm rechts, 0.28 mm tief  
 Streuwert 1.47, horizontal: 1.47, vertikal: 1.48

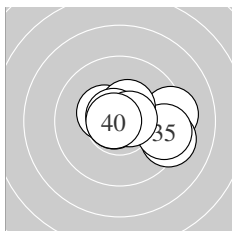

Serie 4:  
 9.4 →                      10.4 \*                      9.3 →                      9.3 →                      9.5 →  
 10.4 \*                      10.8 \*                      10.7 \*                      10.6 \*                      10.8 \*  
 beste Teiler 43.0 (37.) 47.0 (40.) 62.6 (38.)  
 Trefferlage 1.42 mm rechts, 0.08 mm hoch  
 Streuwert 1.63, horizontal: 2.18, vertikal: 0.75

Unterschrift des Schützen

Meyton Elektronik

Ergebnis: **382** (401.7)  
 Serien: 94 97 95 96  
 Zähler: 23 16 1 0 0 0 0 0 0 0  
 Innenzehner: 19  
 weiteste: 538 (1), 485 (27), 423 (40)  
 beste Teiler 29.9 (15.) 38.8 (17.) 56.7 (5.)  
 Trefferlage 0.29 mm rechts, 0.25 mm hoch  
 Streuwert 1.81, horizontal: 1.98, vertikal: 1.62

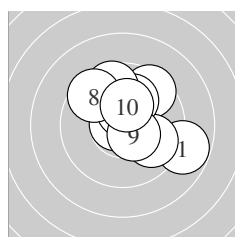
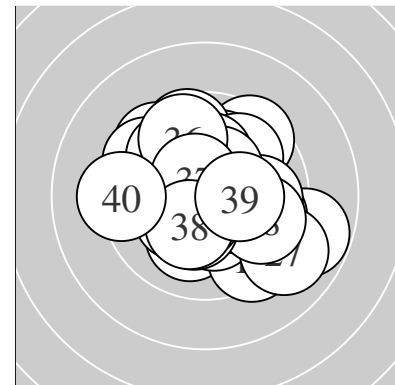

Serie 1:  
 8.8 ↘ 9.5 ↗ 9.8 ↘ 10.1 ↗ 10.7 \*  
 9.6 ↗ 10.5 \* 9.6 ↗ 10.5 \* 10.3 \*  
 beste Teiler 56.7 (5.) 121.5 (9.) 122.1 (7.)  
 Trefferlage 0.80 mm rechts, 0.95 mm hoch  
 Streuwert 1.94, horizontal: 2.07, vertikal: 1.81

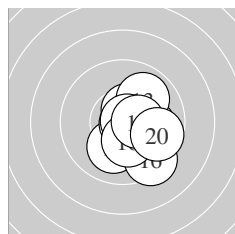

Serie 2:  
 10.5 \* 10.1 → 9.9 ↗ 10.1 ↓ 10.8 \*  
 9.4 ↘ 10.8 \* 10.3 \* 10.4 \* 9.7 →  
 beste Teiler 29.9 (15.) 38.8 (17.) 111.0 (11.)  
 Trefferlage 1.12 mm rechts, 0.50 mm tief  
 Streuwert 1.33, horizontal: 1.16, vertikal: 1.48

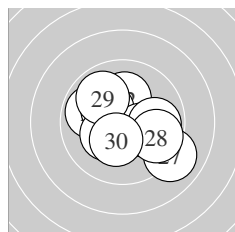

Serie 3:  
 9.9 ↖ 10.2 \* 10.3 \* 10.3 \* 9.9 →  
 10.3 \* 9.0 ↘ 9.7 → 9.9 ↖ 10.3 \*  
 beste Teiler 157.8 (30.) 165.5 (23.) 168.0 (24.)  
 Trefferlage 0.37 mm rechts, 0.13 mm tief  
 Streuwert 1.94, horizontal: 2.25, vertikal: 1.58

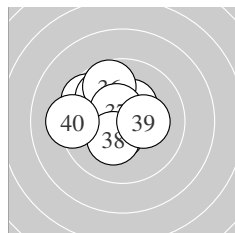

Serie 4:  
 9.6 ↖ 10.5 \* 10.0 ↖ 10.4 \* 9.9 ↖  
 9.7 ↗ 10.5 \* 10.3 \* 10.3 \* 9.3 ←  
 beste Teiler 103.4 (37.) 107.7 (32.) 145.4 (34.)  
 Trefferlage 1.14 mm links, 0.69 mm hoch  
 Streuwert 1.55, horizontal: 1.73, vertikal: 1.35

Unterschrift des Schützen

Meyton Elektronik

Ergebnis: **368** (386.7)  
 Serien: 89 90 94 95  
 Zähler: 14 20 6 0 0 0 0 0 0 0  
 Innenzehner: 11  
 weiteste: 651 (13), 648 (19), 646 (25)  
 beste Teiler 38.6 (26.) 45.3 (21.) 78.4 (28.)  
 Trefferlage 0.37 mm rechts, 0.26 mm tief  
 Streuwert 2.57, horizontal: 2.96, vertikal: 2.11

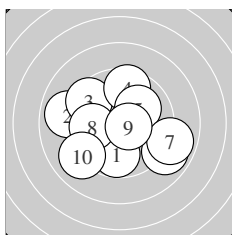
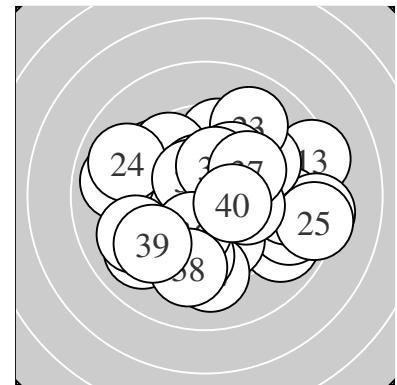

Serie 1:  
 9.8 ↓                      8.9 ←                      9.5 ↘                      9.6 ↑                      10.1 ↗  
 8.9 ↘                      8.9 →                      9.9 ←                      10.6 \*                      9.0 ↙  
 beste Teiler 91.7 (9.) 225.5 (5.) 263.4 (8.)  
 Trefferlage 0.18 mm links, 0.34 mm tief  
 Streuwert 2.85, horizontal: 3.33, vertikal: 2.27

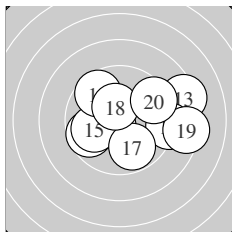

Serie 2:  
 10.6 \*                      9.7 ←                      8.3 →                      9.0 →                      9.9 ←  
 9.6 ↘                      9.8 ↓                      10.4 \*                      8.4 →                      9.4 ↗  
 beste Teiler 85.0 (11.) 135.6 (18.) 256.7 (15.)  
 Trefferlage 1.32 mm rechts, 0.11 mm hoch  
 Streuwert 2.81, horizontal: 3.58, vertikal: 1.72

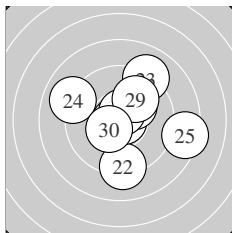

Serie 3:  
 10.8 \*                      9.2 ↓                      9.0 ↗                      9.0 ↘                      8.4 →  
 10.8 \*                      10.2 \*                      10.6 \*                      9.9 ↗                      10.4 \*  
 beste Teiler 38.6 (26.) 45.3 (21.) 78.4 (28.)  
 Trefferlage 0.66 mm rechts, 0.30 mm hoch  
 Streuwert 2.53, horizontal: 2.74, vertikal: 2.31

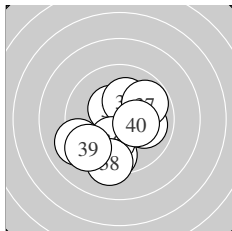

Serie 4:  
 9.1 ↙                      10.4 \*                      10.2 \*                      10.0 →                      9.6 ↓  
 10.1 ↓                      9.8 ↗                      9.3 ↓                      9.3 ↙                      10.3 \*  
 beste Teiler 128.6 (32.) 163.4 (40.) 183.0 (33.)  
 Trefferlage 0.31 mm links, 1.13 mm tief  
 Streuwert 2.12, horizontal: 2.14, vertikal: 2.10

Unterschrift des Schützen

Meyton Elektronik



Ergebnis: **373** (392.1)  
 Serien: 98 93 91 91  
 Zähler: 17 19 4 0 0 0 0 0 0 0  
 Innenzehner: 12  
 weiteste: 555 (32), 549 (39), 548 (26)  
 beste Teiler 38.4 (4.) 51.2 (40.) 64.7 (2.)  
 Trefferlage 0.30 mm links, 0.31 mm tief  
 Streuwert 2.31, horizontal: 2.64, vertikal: 1.92

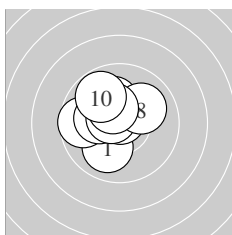
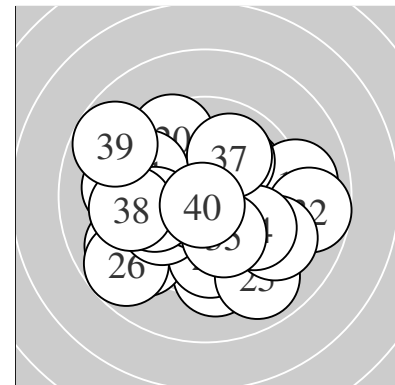

Serie 1:  
 10.0 ↙ 10.7 \* 9.7 ← 10.8 \* 10.2 \*  
 10.6 \* 10.2 \* 10.0 ↗ 10.4 \* 9.8 ↘  
 beste Teiler 38.4 (4.) 64.7 (2.) 84.9 (6.)  
 Trefferlage 0.78 mm links, 0.66 mm hoch  
 Streuwert 1.28, horizontal: 1.34, vertikal: 1.21

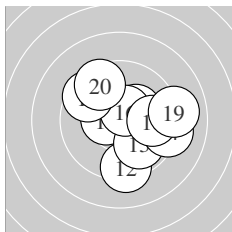

Serie 2:  
 10.5 \* 9.3 ↓ 9.9 ↘ 9.2 → 10.3 \*  
 10.6 \* 9.6 ↖ 9.8 → 9.0 → 9.5 ↘  
 beste Teiler 96.8 (16.) 118.1 (11.) 170.3 (15.)  
 Trefferlage 1.04 mm rechts, 0.05 mm hoch  
 Streuwert 2.29, horizontal: 2.50, vertikal: 2.07

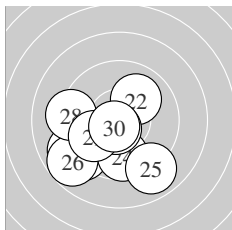

Serie 3:  
 9.0 ↙ 10.0 ↗ 9.2 ↙ 9.7 ↓ 8.9 ↘  
 8.8 ↙ 10.6 \* 9.2 ← 9.9 ↙ 10.7 \*  
 beste Teiler 73.7 (30.) 84.3 (27.) 232.8 (22.)  
 Trefferlage 1.43 mm links, 1.71 mm tief  
 Streuwert 2.26, horizontal: 2.53, vertikal: 1.95

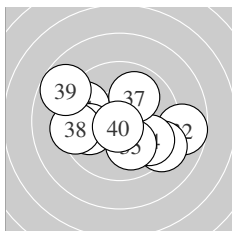

Serie 4:  
 9.6 ↖ 8.7 → 9.2 ↘ 9.7 ↘ 10.0 ↓  
 9.9 ← 10.0 ↗ 9.4 ← 8.8 ↖ 10.7 \*  
 beste Teiler 51.2 (40.) 228.9 (35.) 247.3 (37.)  
 Trefferlage 0.04 mm links, 0.24 mm tief  
 Streuwert 2.74, horizontal: 3.46, vertikal: 1.72

Unterschrift des Schützen

Meyton Elektronik

Ergebnis: **393** (410.6)  
 Serien: 98 98 99 98  
 Zähler: 33 7 0 0 0 0 0 0 0 0  
 Innenzehner: 28  
 weiteste: 289 (8), 282 (17), 282 (33)  
 beste Teiler 57.4 (6.) 78.5 (30.) 85.7 (37.)  
 Trefferlage 0.08 mm rechts, 0.06 mm hoch  
 Streuwert 1.32, horizontal: 1.52, vertikal: 1.10

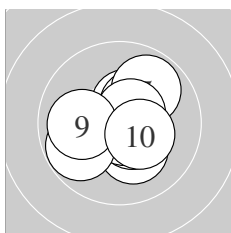
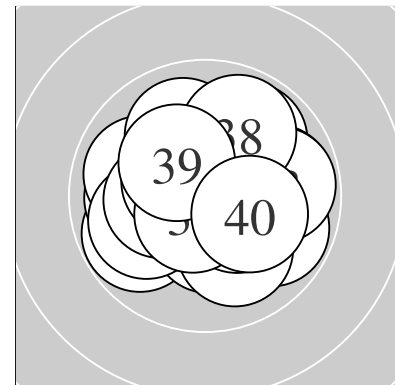

Serie 1:  
 10.4 \*                      10.2 \*                      10.3 \*                      10.5 \*                      9.9 ↗  
 10.7 \*                      10.6 \*                      9.8 ↙                      10.0 ←                      10.4 \*  
 beste Teiler 57.4 (6.) 92.9 (7.) 107.6 (4.)  
 Trefferlage 0.21 mm rechts, 0.00 mm  
 Streuwert 1.36, horizontal: 1.47, vertikal: 1.24

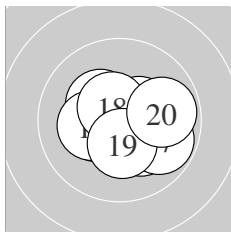

Serie 2:  
 10.2 \*                      10.6 \*                      10.3 \*                      10.4 \*                      10.4 \*  
 10.2 \*                      9.8 ↘                      10.6 \*                      10.4 \*                      9.9 →  
 beste Teiler 88.7 (12.) 97.6 (18.) 136.9 (14.)  
 Trefferlage 0.24 mm rechts, 0.13 mm tief  
 Streuwert 1.34, horizontal: 1.63, vertikal: 0.97

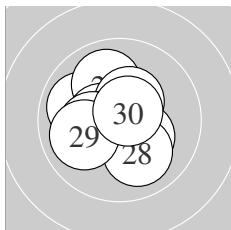

Serie 3:  
 9.9 ↖                      10.0 ↗                      10.5 \*                      10.4 \*                      10.6 \*  
 10.2 \*                      10.3 \*                      10.0 ↘                      10.0 ←                      10.6 \*  
 beste Teiler 78.5 (30.) 89.6 (25.) 116.5 (23.)  
 Trefferlage 0.56 mm links, 0.02 mm hoch  
 Streuwert 1.32, horizontal: 1.38, vertikal: 1.25

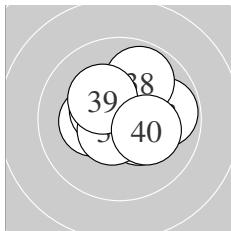

Serie 4:  
 10.0 →                      10.3 \*                      9.8 →                      10.5 \*                      10.5 \*  
 10.4 \*                      10.6 \*                      9.9 ↗                      10.3 \*                      10.2 \*  
 beste Teiler 85.7 (37.) 113.3 (34.) 124.9 (35.)  
 Trefferlage 0.43 mm rechts, 0.37 mm hoch  
 Streuwert 1.34, horizontal: 1.61, vertikal: 1.01

Unterschrift des Schützen

Meyton Elektronik

Ergebnis: **372** (390.3)  
 Serien: 90 94 95 93  
 Zähler: 19 15 5 1 0 0 0 0 0 0  
 Innenzehner: 12  
 weiteste: 810 (7), 648 (1), 613 (3)  
 beste Teiler 33.1 (26.) 85.0 (10.) 98.4 (15.)  
 Trefferlage 0.25 mm rechts, 0.01 mm tief  
 Streuwert 2.45, horizontal: 2.73, vertikal: 2.14

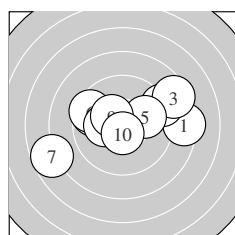
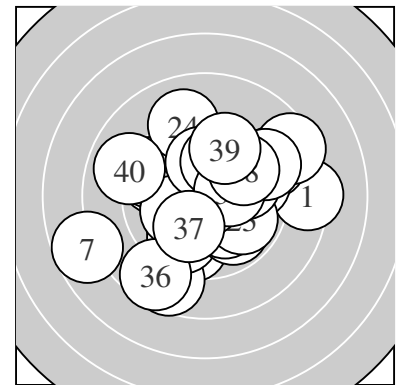

Serie 1:  
 8.4 → 9.1 ↗ 8.5 ↗ 9.6 ↖ 10.0 →  
 9.5 ↖ 7.7 ← 10.2 \* 10.4 \* 10.6 \*  
 beste Teiler 85.0 (10.) 148.9 (9.) 186.0 (8.)  
 Trefferlage 0.14 mm rechts, 0.54 mm hoch  
 Streuwert 3.34, horizontal: 4.40, vertikal: 1.72

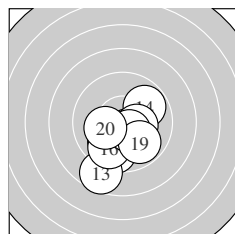

Serie 2:  
 10.0 ↙ 9.6 ↓ 8.6 ↓ 9.8 ↗ 10.6 \*  
 9.8 ↙ 10.3 \* 10.5 \* 9.9 ↘ 10.2 \*  
 beste Teiler 98.4 (15.) 117.8 (18.) 152.3 (17.)  
 Trefferlage 0.10 mm links, 1.63 mm tief  
 Streuwert 1.77, horizontal: 1.65, vertikal: 1.87

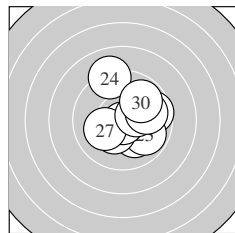

Serie 3:  
 9.7 → 10.1 ↘ 9.9 ↘ 9.1 ↑ 10.3 \*  
 10.8 \* 10.1 ← 10.3 \* 9.9 → 9.8 ↗  
 beste Teiler 33.1 (26.) 152.1 (28.) 156.7 (25.)  
 Trefferlage 0.85 mm rechts, 0.27 mm hoch  
 Streuwert 1.83, horizontal: 1.75, vertikal: 1.90

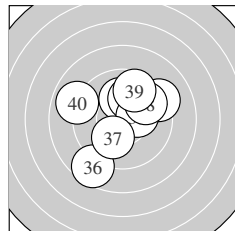

Serie 4:  
 10.3 \* 10.1 ↑ 10.0 ↑ 9.2 ↗ 10.3 \*  
 8.6 ↙ 10.1 ↓ 9.8 ↗ 9.7 ↑ 8.9 ↖  
 beste Teiler 156.5 (31.) 158.4 (35.) 213.4 (32.)  
 Trefferlage 0.13 mm rechts, 0.74 mm hoch  
 Streuwert 2.49, horizontal: 2.56, vertikal: 2.42

Unterschrift des Schützen

Meyton Elektronik

Ergebnis: **370** (388.2)  
 Serien: 91 93 92 94  
 Zähler: 14 22 4 0 0 0 0 0 0 0  
 Innenzehner: 7  
 weiteste: 648 (7), 622 (13), 589 (8)  
 beste Teiler 31.7 (27.) 122.4 (36.) 125.8 (24.)  
 Trefferlage 0.45 mm links, 0.19 mm tief  
 Streuwert 2.42, horizontal: 2.70, vertikal: 2.10

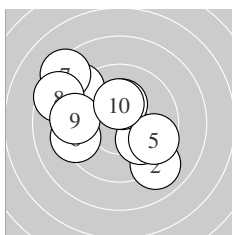
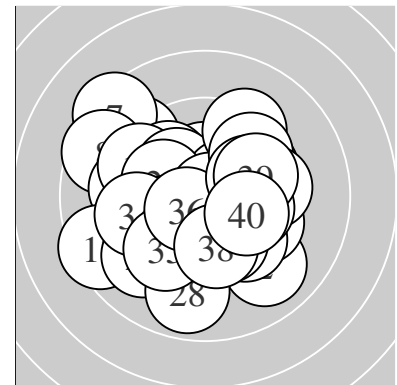

Serie 1:  
 9.1 ↘ 9.0 ↘ 10.0 ↘ 10.3 \* 9.6 ↘  
 9.3 ← 8.4 ↘ 8.6 ↘ 9.4 ← 10.3 \*  
 beste Teiler 169.5 (4.) 170.1 (10.) 235.4 (3.)  
 Trefferlage 1.34 mm links, 0.58 mm hoch  
 Streuwert 2.95, horizontal: 3.35, vertikal: 2.48

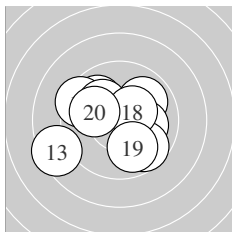

Serie 2:  
 9.9 ↗ 9.9 ↘ 8.5 ← 10.1 → 9.4 ↘  
 9.7 ↘ 10.1 ↘ 10.4 \* 9.9 ↓ 10.0 ←  
 beste Teiler 137.6 (18.) 204.5 (17.) 214.7 (14.)  
 Trefferlage 0.62 mm links, 0.00 mm  
 Streuwert 2.31, horizontal: 2.71, vertikal: 1.83

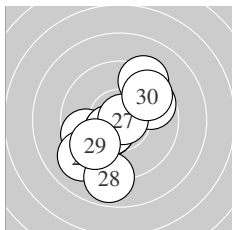

Serie 3:  
 9.7 ← 9.1 ↗ 10.4 \* 10.5 \* 9.3 ↗  
 9.7 ↗ 10.8 \* 8.9 ↓ 9.7 ↗ 9.6 ↗  
 beste Teiler 31.7 (27.) 125.8 (24.) 131.5 (23.)  
 Trefferlage 0.35 mm links, 0.63 mm tief  
 Streuwert 2.39, horizontal: 2.21, vertikal: 2.55

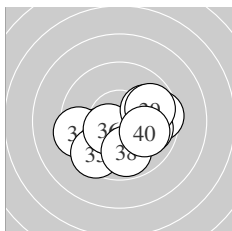

Serie 4:  
 10.1 ← 9.5 → 9.9 → 9.4 ← 9.5 ↗  
 10.5 \* 10.0 → 9.9 ↓ 9.8 → 10.0 →  
 beste Teiler 122.4 (36.) 215.4 (31.) 240.6 (40.)  
 Trefferlage 0.52 mm rechts, 0.73 mm tief  
 Streuwert 2.00, horizontal: 2.49, vertikal: 1.34

Unterschrift des Schützen

Ergebnis: **388** (405.1)  
 Serien: 98 96 97 97  
 Zähler: 28 12 0 0 0 0 0 0 0 0  
 Innenzehner: 22  
 weiteste: 476 (16), 427 (12), 424 (28)  
 beste Teiler 38.0 (29.) 58.6 (3.) 59.9 (35.)  
 Trefferlage 0.29 mm links, 0.25 mm hoch  
 Streuwert 1.65, horizontal: 1.88, vertikal: 1.37

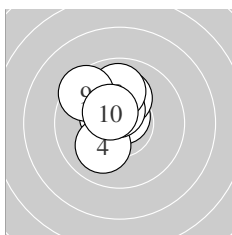
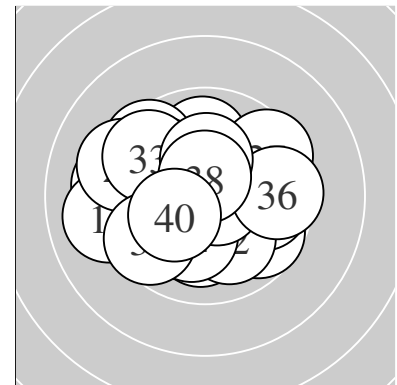

Serie 1:  
 10.2 \*                      10.5 \*                      10.7 \*                      10.1 ↙                      10.2 \*  
 10.1 ↑                      10.5 \*                      9.9 ↑                      9.5 ↘                      10.5 \*  
 beste Teiler 58.6 (3.) 108.5 (7.) 115.9 (2.)  
 Trefferlage 0.56 mm links, 1.20 mm hoch  
 Streuwert 1.12, horizontal: 0.93, vertikal: 1.28

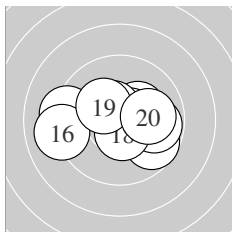

Serie 2:  
 10.3 \*                      9.2 ←                      9.7 ↘                      10.6 \*                      9.8 →  
 9.0 ←                      10.5 \*                      10.5 \*                      10.3 \*                      10.0 →  
 beste Teiler 86.8 (14.) 104.3 (18.) 110.7 (17.)  
 Trefferlage 0.05 mm links, 0.00 mm  
 Streuwert 2.01, horizontal: 2.67, vertikal: 0.98

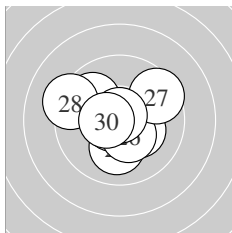

Serie 3:  
 10.3 \*                      10.4 \*                      10.1 ↓                      10.7 \*                      9.9 ↘  
 10.4 \*                      9.5 ↗                      9.3 ←                      10.8 \*                      10.5 \*  
 beste Teiler 38.0 (29.) 66.2 (24.) 106.0 (30.)  
 Trefferlage 0.24 mm links, 0.03 mm tief  
 Streuwert 1.67, horizontal: 1.92, vertikal: 1.38

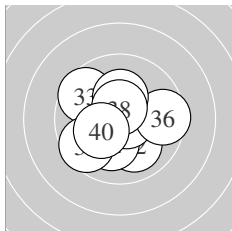

Serie 4:  
 10.4 \*                      10.0 ↘                      9.6 ↘                      10.1 ↓                      10.7 \*  
 9.6 →                      10.2 \*                      10.6 \*                      9.6 ↙                      10.3 \*  
 beste Teiler 59.9 (35.) 92.0 (38.) 130.4 (31.)  
 Trefferlage 0.32 mm links, 0.15 mm tief  
 Streuwert 1.70, horizontal: 1.86, vertikal: 1.53

Unterschrift des Schützen

Meyton Elektronik

Ergebnis: **385** (405.6)  
 Serien: 94 97 97 97  
 Zähler: 26 13 1 0 0 0 0 0 0 0  
 Innenzehner: 23  
 weiteste: 508 (3), 428 (35), 405 (23)  
 beste Teiler 63.0 (39.) 66.8 (33.) 71.4 (27.)  
 Trefferlage 0.23 mm links, 0.26 mm hoch  
 Streuwert 1.65, horizontal: 1.79, vertikal: 1.48

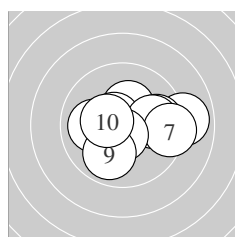
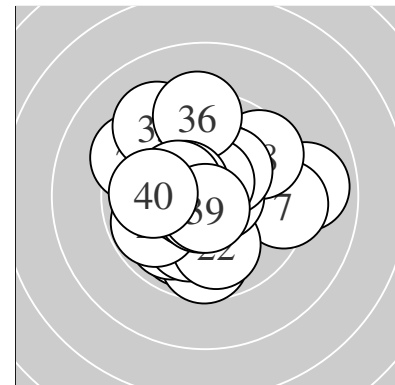

Serie 1:  
 10.3 \*                      10.0 ←                      8.9 →                      10.6 \*                      9.8 →  
 9.9 →                      9.4 →                      10.6 \*                      9.9 ↓                      10.4 \*  
 beste Teiler 83.3 (8.) 88.8 (4.) 137.0 (10.)  
 Trefferlage 0.92 mm rechts, 0.01 mm tief  
 Streuwert 1.92, horizontal: 2.51, vertikal: 1.02

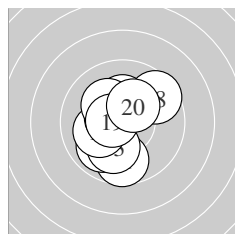

Serie 2:  
 9.7 ↓                      9.9 ↙                      10.1 ↓                      10.1 ←                      10.5 \*  
 10.3 \*                      10.2 \*                      9.6 ↗                      10.6 \*                      10.3 \*  
 beste Teiler 88.9 (19.) 103.1 (15.) 165.0 (20.)  
 Trefferlage 0.39 mm links, 0.08 mm tief  
 Streuwert 1.63, horizontal: 1.38, vertikal: 1.84

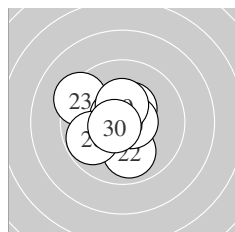

Serie 3:  
 10.2 \*                      9.9 ↓                      9.3 ↖                      10.5 \*                      10.4 \*  
 10.7 \*                      10.7 \*                      9.8 ↙                      10.4 \*                      10.6 \*  
 beste Teiler 71.4 (27.) 75.0 (26.) 76.9 (30.)  
 Trefferlage 0.69 mm links, 0.14 mm hoch  
 Streuwert 1.42, horizontal: 1.50, vertikal: 1.34

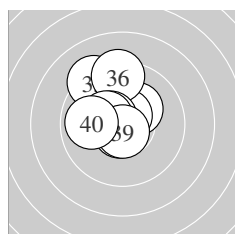

Serie 4:  
 10.3 \*                      10.4 \*                      10.7 \*                      10.6 \*                      9.2 ↗  
 9.3 ↑                      10.5 \*                      10.4 \*                      10.7 \*                      9.9 ←  
 beste Teiler 63.0 (39.) 66.8 (33.) 76.2 (34.)  
 Trefferlage 0.79 mm links, 0.99 mm hoch  
 Streuwert 1.40, horizontal: 1.18, vertikal: 1.59

Unterschrift des Schützen

Meyton Elektronik

Ergebnis: **371** (385.1)

Serien: 94 93 92 92

Zähler: 16 19 5 0 0 0 0 0 0 0

Innenzehner: 6

weiteste: 737 (19), 669 (21), 625 (39)

beste Teiler 47.1 (16.) 61.1 (26.) 121.4 (8.)

Trefferlage 0.24 mm links, 0.12 mm tief

Streuwert 2.61, horizontal: 2.67, vertikal: 2.55

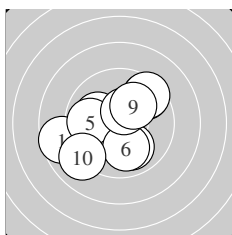
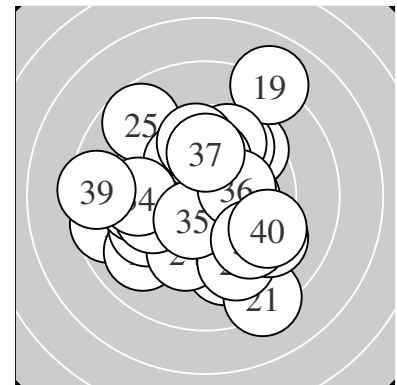

Serie 1:

8.7 ←	10.1 ↖	9.5 ↗	10.0 ↓	9.8 ←
10.0 ↓	9.5 ↗	10.5 *	10.1 ↗	9.0 ←

beste Teiler 121.4 (8.) 212.2 (9.) 221.7 (2.)

Trefferlage 0.55 mm links, 0.05 mm tief

Streuwert 2.48, horizontal: 2.76, vertikal: 2.15

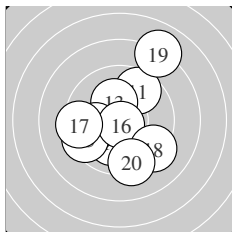

Serie 2:

9.6 ↗	10.1 ↓	10.2 *	10.0 ←	9.4 ←
10.8 *	9.4 ←	9.3 ↘	8.0 ↗	9.3 ↓

beste Teiler 47.1 (16.) 180.6 (13.) 224.2 (12.)

Trefferlage 0.08 mm links, 0.11 mm tief

Streuwert 2.83, horizontal: 2.59, vertikal: 3.05

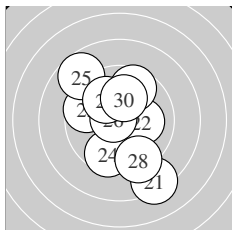

Serie 3:

8.3 ↓	10.1 →	9.6 ↖	9.6 ↓	8.7 ↖
10.7 *	9.6 ↗	9.3 ↓	10.0 ↖	10.1 ↑

beste Teiler 61.1 (26.) 207.4 (22.) 213.9 (30.)

Trefferlage 0.09 mm links, 0.04 mm tief

Streuwert 2.80, horizontal: 2.28, vertikal: 3.24

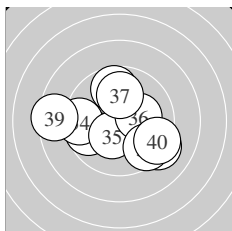

Serie 4:

9.2 ↘	9.7 ←	9.7 ↑	9.4 ←	10.3 *
10.2 *	10.0 ↑	9.5 ↘	8.5 ←	9.3 ↘

beste Teiler 154.7 (35.) 187.0 (36.) 249.0 (37.)

Trefferlage 0.26 mm links, 0.29 mm tief

Streuwert 2.72, horizontal: 3.32, vertikal: 1.94

Unterschrift des Schützen

Meyton Elektronik

Ergebnis: **338** (357.3)  
 Serien: 79 84 85 90  
 Zähler: 6 16 11 5 1 1 0 0 0 0  
 Innenzehner: 5  
 weiteste: 1259 (1), 1027 (11), 897 (12)  
 beste Teiler 38.4 (39.) 93.4 (4.) 109.8 (30.)  
 Trefferlage 2.46 mm rechts, 0.39 mm tief  
 Streuwert 3.67, horizontal: 4.35, vertikal: 2.84

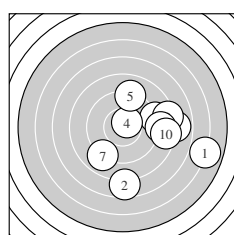
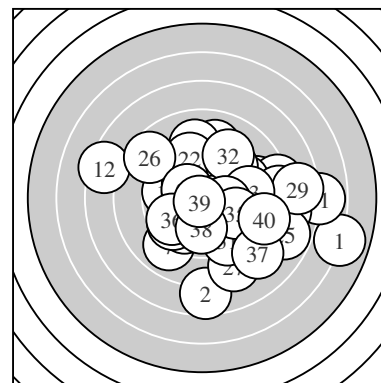

Serie 1:  
 5.9 → 7.6 ↓ 9.0 → 10.6 \* 9.1 ↑  
 7.9 → 8.9 ↙ 8.2 → 8.7 → 8.4 →  
 beste Teiler 93.4 (4.) 472.4 (5.) 495.7 (3.)  
 Trefferlage 4.21 mm rechts, 0.87 mm tief  
 Streuwert 4.04, horizontal: 4.39, vertikal: 3.64

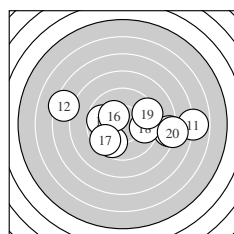

Serie 2:  
 6.8 → 7.4 ← 9.7 ← 9.7 ↙ 8.2 →  
 10.3 \* 9.6 ↙ 9.6 → 9.4 → 8.0 →  
 beste Teiler 174.0 (16.) 304.2 (14.) 305.0 (13.)  
 Trefferlage 1.42 mm rechts, 0.17 mm tief  
 Streuwert 4.26, horizontal: 5.78, vertikal: 1.70

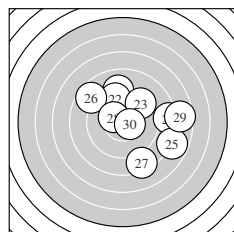

Serie 3:  
 9.1 ↑ 9.5 ↑ 9.4 ↗ 8.3 → 7.8 →  
 8.6 ↖ 8.3 ↓ 10.4 \* 7.6 → 10.5 \*  
 beste Teiler 109.8 (30.) 148.6 (28.) 363.1 (22.)  
 Trefferlage 2.11 mm rechts, 0.71 mm hoch  
 Streuwert 3.78, horizontal: 4.25, vertikal: 3.25

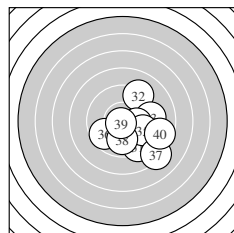

Serie 4:  
 9.2 ↘ 9.2 ↗ 9.3 → 10.1 → 9.7 →  
 9.7 ↙ 8.2 ↘ 9.9 ↓ 10.8 \* 8.7 →  
 beste Teiler 38.4 (39.) 206.8 (34.) 263.0 (38.)  
 Trefferlage 2.09 mm rechts, 1.25 mm tief  
 Streuwert 2.44, horizontal: 2.50, vertikal: 2.38

Unterschrift des Schützen

Meyton Elektronik



Ergebnis: **396** (413.8)  
 Serien: 98 99 100 99  
 Zähler: 36 4 0 0 0 0 0 0 0 0  
 Innenzehner: 30  
 weiteste: 329 (40), 304 (9), 270 (18)  
 beste Teiler 16.1 (24.) 37.0 (27.) 37.3 (21.)  
 Trefferlage 0.15 mm links, 0.03 mm tief  
 Streuwert 1.20, horizontal: 1.16, vertikal: 1.25

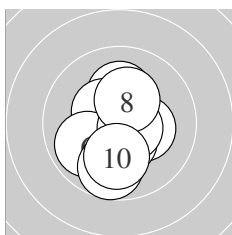
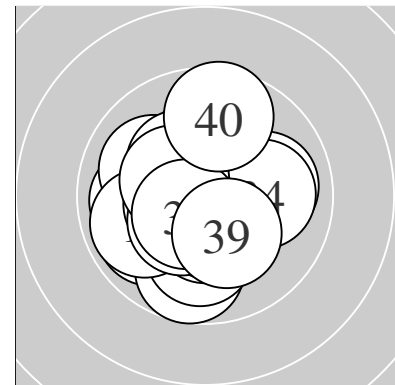

Serie 1:  
 10.7 \*                      10.3 \*                      10.2 \*                      10.4 \*                      10.4 \*  
 9.9 ↙                      10.6 \*                      10.3 \*                      9.7 ↓                      10.0 ↓  
 beste Teiler 73.2 (1.) 78.2 (7.) 127.3 (5.)  
 Trefferlage 0.03 mm links, 0.38 mm tief  
 Streuwert 1.37, horizontal: 1.06, vertikal: 1.62

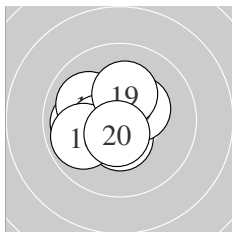

Serie 2:  
 10.0 ←                      10.4 \*                      10.7 \*                      10.5 \*                      10.4 \*  
 10.0 ↖                      10.4 \*                      9.9 ↙                      10.2 \*                      10.6 \*  
 beste Teiler 57.2 (13.) 93.9 (20.) 122.1 (14.)  
 Trefferlage 0.84 mm links, 0.12 mm tief  
 Streuwert 1.15, horizontal: 1.28, vertikal: 1.00

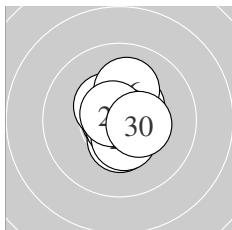

Serie 3:  
 10.8 \*                      10.4 \*                      10.4 \*                      10.9 \*                      10.5 \*  
 10.1 ↑                      10.8 \*                      10.5 \*                      10.7 \*                      10.4 \*  
 beste Teiler 16.1 (24.) 37.0 (27.) 37.3 (21.)  
 Trefferlage 0.12 mm rechts, 0.12 mm hoch  
 Streuwert 0.85, horizontal: 0.65, vertikal: 1.02

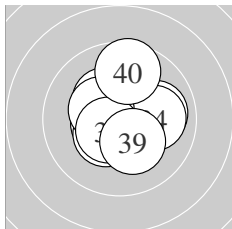

Serie 4:  
 10.8 \*                      10.0 →                      10.3 \*                      10.0 →                      10.5 \*  
 10.4 \*                      10.4 \*                      10.5 \*                      10.2 \*                      9.6 ↑  
 beste Teiler 42.4 (31.) 106.7 (38.) 114.5 (35.)  
 Trefferlage 0.11 mm rechts, 0.24 mm hoch  
 Streuwert 1.37, horizontal: 1.39, vertikal: 1.35

Unterschrift des Schützen

Meyton Elektronik

Ergebnis: **384** (400.0)  
 Serien: 96 97 95 96  
 Zähler: 24 16 0 0 0 0 0 0 0 0  
 Innenzehner: 15  
 weiteste: 462 (14), 436 (2), 421 (30)  
 beste Teiler 42.0 (27.) 77.8 (21.) 86.9 (12.)  
 Trefferlage 0.67 mm links, 0.19 mm hoch  
 Streuwert 1.79, horizontal: 2.09, vertikal: 1.43

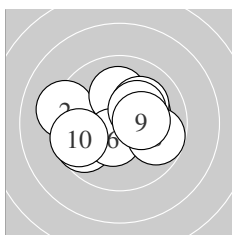
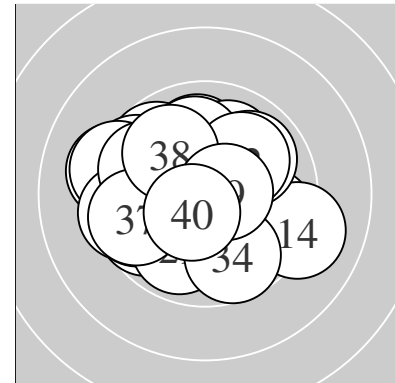

Serie 1:  
 10.2 \* 9.2 ↖ 9.7 ↙ 10.1 ↑ 10.1 ↗  
 10.5 \* 10.3 \* 9.8 → 10.3 \* 9.6 ↙  
 beste Teiler 121.2 (6.) 169.1 (9.) 171.6 (7.)  
 Trefferlage 0.15 mm links, 0.17 mm hoch  
 Streuwert 1.95, horizontal: 2.44, vertikal: 1.29

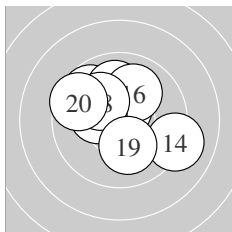

Serie 2:  
 9.7 ↘ 10.6 \* 10.5 \* 9.1 → 10.0 ↑  
 10.0 ↗ 10.3 \* 10.1 ↘ 10.1 ↓ 9.6 ↖  
 beste Teiler 86.9 (12.) 120.3 (13.) 172.2 (17.)  
 Trefferlage 0.27 mm links, 0.82 mm hoch  
 Streuwert 1.83, horizontal: 2.10, vertikal: 1.52

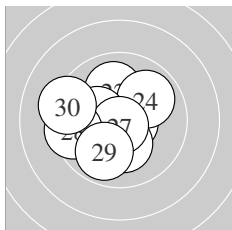

Serie 3:  
 10.6 \* 10.0 ↑ 9.7 ↙ 9.9 ↗ 10.2 \*  
 10.2 \* 10.8 \* 9.5 ↙ 9.9 ↓ 9.3 ↖  
 beste Teiler 42.0 (27.) 77.8 (21.) 176.7 (26.)  
 Trefferlage 1.10 mm links, 0.09 mm tief  
 Streuwert 1.76, horizontal: 2.00, vertikal: 1.48

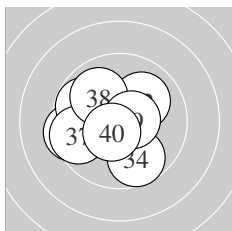

Serie 4:  
 9.4 ↙ 10.0 ↗ 9.8 ↘ 9.7 ↓ 10.2 \*  
 10.3 \* 9.6 ↙ 10.0 ↘ 10.6 \* 10.5 \*  
 beste Teiler 92.4 (39.) 105.4 (40.) 174.9 (36.)  
 Trefferlage 1.14 mm links, 0.12 mm tief  
 Streuwert 1.68, horizontal: 1.90, vertikal: 1.41

Unterschrift des Schützen

Meyton Elektronik

Ergebnis: **389** (410.9)  
 Serien: 94 99 97 99  
 Zähler: 29 11 0 0 0 0 0 0 0 0  
 Innenzehner: 28  
 weiteste: 367 (6), 347 (5), 328 (2)  
 beste Teiler 26.5 (16.) 45.8 (8.) 50.9 (12.)  
 Trefferlage 0.64 mm links, 0.24 mm tief  
 Streuwert 1.29, horizontal: 1.22, vertikal: 1.35

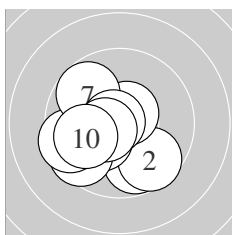
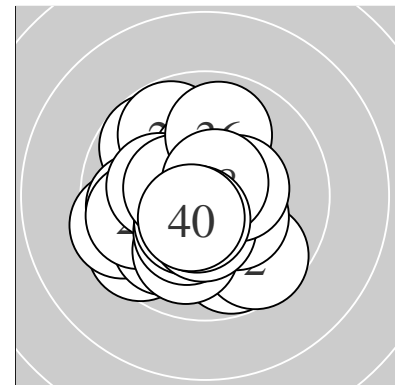

Serie 1:  
 9.8 ↘                      9.6 ↘                      10.6 \*                      10.3 \*                      9.6 ↙  
 9.5 ←                      9.7 ↖                      10.8 \*                      10.5 \*                      9.9 ←  
 beste Teiler 45.8 (8.) 85.2 (3.) 112.3 (9.)  
 Trefferlage 0.98 mm links, 0.83 mm tief  
 Streuwert 1.65, horizontal: 1.80, vertikal: 1.49

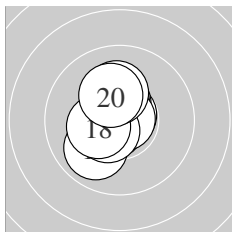

Serie 2:  
 9.9 ↗                      10.8 \*                      10.5 \*                      10.5 \*                      10.7 \*  
 10.8 \*                      10.5 \*                      10.3 \*                      10.2 \*                      10.2 \*  
 beste Teiler 26.5 (16.) 50.9 (12.) 65.8 (15.)  
 Trefferlage 0.48 mm links, 0.27 mm hoch  
 Streuwert 0.99, horizontal: 0.68, vertikal: 1.22

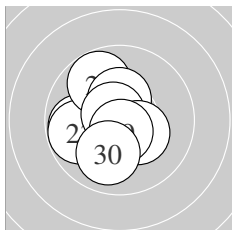

Serie 3:  
 9.8 ←                      10.6 \*                      9.8 ←                      10.4 \*                      9.8 ↖  
 10.4 \*                      10.7 \*                      10.3 \*                      10.6 \*                      10.0 ↙  
 beste Teiler 62.2 (27.) 79.6 (29.) 88.1 (22.)  
 Trefferlage 0.77 mm links, 0.25 mm tief  
 Streuwert 1.34, horizontal: 1.27, vertikal: 1.40

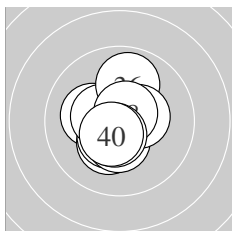

Serie 4:  
 10.2 \*                      10.3 \*                      10.4 \*                      10.5 \*                      10.4 \*  
 9.9 ↑                      10.4 \*                      10.7 \*                      10.5 \*                      10.5 \*  
 beste Teiler 70.0 (38.) 103.7 (39.) 108.7 (40.)  
 Trefferlage 0.33 mm links, 0.16 mm tief  
 Streuwert 1.10, horizontal: 0.93, vertikal: 1.25

Unterschrift des Schützen

Meyton Elektronik

Ergebnis: **375** (391.6)  
 Serien: 93 96 92 94  
 Zähler: 20 16 3 1 0 0 0 0 0 0  
 Innenzehner: 11  
 weiteste: 766 (23), 554 (34), 532 (27)  
 beste Teiler 56.3 (33.) 94.3 (31.) 115.5 (24.)  
 Trefferlage 0.40 mm links, 0.04 mm hoch  
 Streuwert 2.32, horizontal: 2.72, vertikal: 1.82

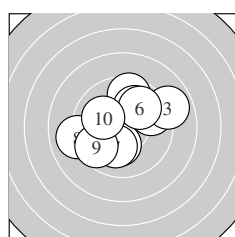
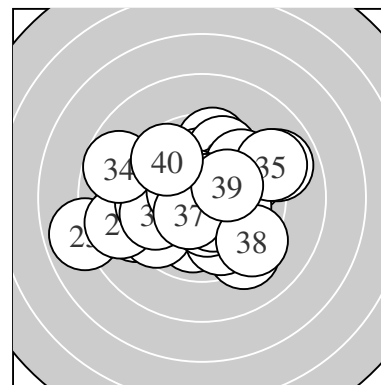

Serie 1:  
 9.6 ↑                      9.6 ↗                      8.9 ↗                      10.0 ↗                      10.2 \*  
 9.9 ↗                      10.1 ↓                      9.0 ←                      9.6 ↙                      10.1 ↖  
 beste Teiler 184.4 (5.) 211.6 (7.) 225.8 (10.)  
 Trefferlage 0.08 mm rechts, 0.50 mm hoch  
 Streuwert 2.44, horizontal: 2.80, vertikal: 2.02

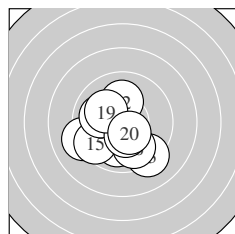

Serie 2:  
 10.0 ↓                      10.1 ↑                      9.2 ↘                      9.2 ↙                      9.5 ↙  
 9.8 ↘                      10.0 ←                      10.4 \*                      10.1 ↖                      10.4 \*  
 beste Teiler 131.7 (20.) 146.5 (18.) 205.2 (19.)  
 Trefferlage 0.67 mm links, 1.10 mm tief  
 Streuwert 1.93, horizontal: 2.05, vertikal: 1.80

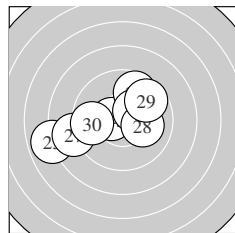

Serie 3:  
 10.2 \*                      10.1 ↗                      7.9 ←                      10.5 \*                      9.7 ↑  
 10.3 \*                      8.8 ←                      10.1 →                      9.7 ↗                      9.7 ←  
 beste Teiler 115.5 (24.) 154.4 (26.) 181.5 (21.)  
 Trefferlage 0.65 mm links, 0.33 mm hoch  
 Streuwert 2.67, horizontal: 3.42, vertikal: 1.58

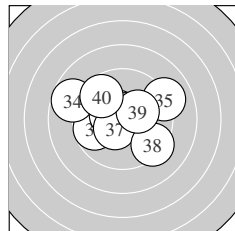

Serie 4:  
 10.6 \*                      9.7 ←                      10.7 \*                      8.7 ↖                      9.0 ↗  
 10.4 \*                      10.5 \*                      9.3 ↘                      10.3 \*                      9.7 ↖  
 beste Teiler 56.3 (33.) 94.3 (31.) 123.5 (37.)  
 Trefferlage 0.35 mm links, 0.42 mm hoch  
 Streuwert 2.29, horizontal: 2.83, vertikal: 1.58

Unterschrift des Schützen

Meyton Elektronik

Ergebnis: **387** (406.4)  
 Serien: 96 97 97 97  
 Zähler: 27 13 0 0 0 0 0 0 0 0  
 Innenzehner: 23  
 weiteste: 401 (13), 372 (32), 356 (20)  
 beste Teiler 20.5 (37.) 26.6 (39.) 45.2 (30.)  
 Trefferlage 0.01 mm links, 0.65 mm hoch  
 Streuwert 1.52, horizontal: 1.73, vertikal: 1.27

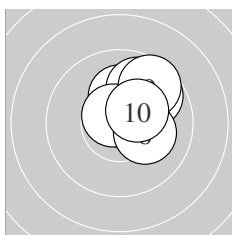
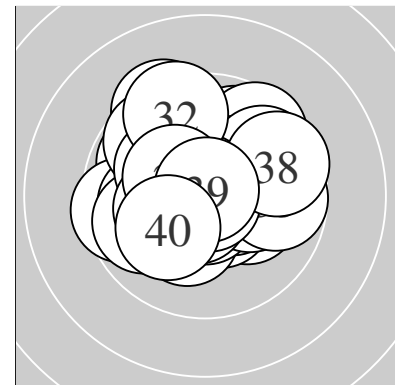

Serie 1:  
 9.8 ↗ 10.2 \* 10.7 \* 9.8 ↗ 10.2 \*  
 9.8 ↗ 10.7 \* 10.2 \* 9.6 ↗ 10.3 \*  
 beste Teiler 71.7 (7.) 75.5 (3.) 154.0 (10.)  
 Trefferlage 1.26 mm rechts, 1.31 mm hoch  
 Streuwert 1.00, horizontal: 0.92, vertikal: 1.07

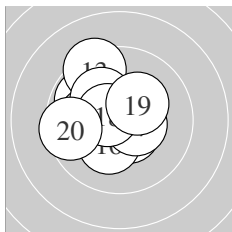

Serie 2:  
 9.8 ↘ 10.5 \* 9.3 ↖ 10.1 ← 10.2 \*  
 10.2 \* 10.5 \* 10.6 \* 10.3 \* 9.5 ←  
 beste Teiler 93.2 (18.) 105.6 (12.) 118.8 (17.)  
 Trefferlage 0.97 mm links, 0.48 mm hoch  
 Streuwert 1.55, horizontal: 1.59, vertikal: 1.50

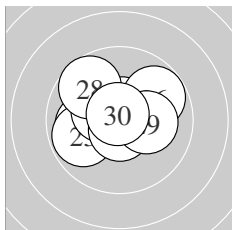

Serie 3:  
 10.0 ← 10.6 \* 9.8 ← 10.2 \* 10.4 \*  
 9.8 ↗ 10.7 \* 9.7 ↘ 10.2 \* 10.8 \*  
 beste Teiler 45.2 (30.) 69.0 (27.) 85.7 (22.)  
 Trefferlage 0.20 mm links, 0.38 mm hoch  
 Streuwert 1.50, horizontal: 1.85, vertikal: 1.04

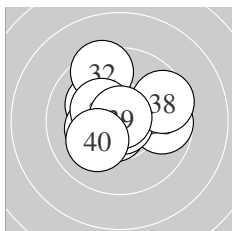

Serie 4:  
 10.1 ↘ 9.5 ↖ 10.2 \* 10.3 \* 9.7 →  
 10.7 \* 10.9 \* 9.6 ↗ 10.8 \* 10.1 ↙  
 beste Teiler 20.5 (37.) 26.6 (39.) 75.6 (36.)  
 Trefferlage 0.15 mm links, 0.43 mm hoch  
 Streuwert 1.61, horizontal: 1.82, vertikal: 1.37

Unterschrift des Schützen

Meyton Elektronik

Ergebnis: **377** (395.4)  
 Serien: 91 96 93 97  
 Zähler: 19 19 2 0 0 0 0 0 0 0  
 Innenzehner: 12  
 weiteste: 546 (23), 545 (9), 494 (22)  
 beste Teiler 69.0 (30.) 71.5 (20.) 81.2 (28.)  
 Trefferlage 0.74 mm rechts, 0.25 mm hoch  
 Streuwert 2.04, horizontal: 2.10, vertikal: 1.98

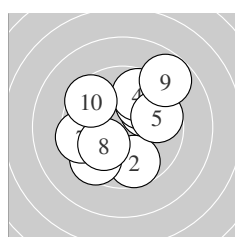
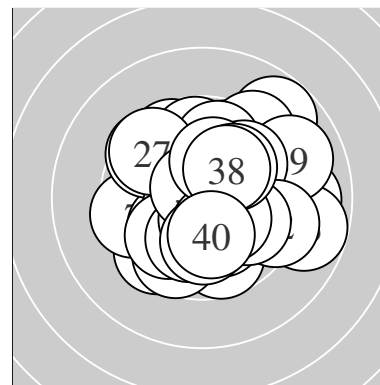

Serie 1:  
 10.0 ↗ 9.7 ↓ 9.9 ↗ 9.7 ↗ 9.7 →  
 9.5 ↙ 9.5 ← 10.1 ↖ 8.8 ↗ 9.5 ↘  
 beste Teiler 218.0 (8.) 244.6 (1.) 261.4 (3.)  
 Trefferlage 0.23 mm rechts, 0.54 mm hoch  
 Streuwert 2.48, horizontal: 2.56, vertikal: 2.40

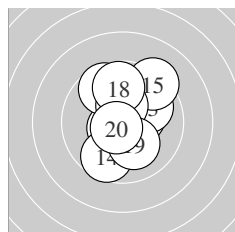

Serie 2:  
 10.4 \* 10.6 \* 10.0 ↗ 9.7 ↓ 9.3 ↗  
 9.7 ↘ 10.4 \* 9.8 ↑ 10.1 ↓ 10.7 \*  
 beste Teiler 71.5 (20.) 97.4 (12.) 142.1 (17.)  
 Trefferlage 0.24 mm rechts, 0.64 mm hoch  
 Streuwert 1.81, horizontal: 1.45, vertikal: 2.10

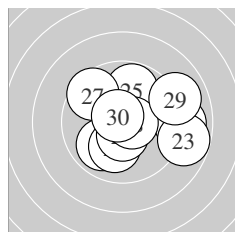

Serie 3:  
 9.9 ↖ 9.0 → 8.8 ↘ 10.1 ↓ 9.8 ↗  
 10.5 \* 9.6 ↘ 10.6 \* 9.0 → 10.7 \*  
 beste Teiler 69.0 (30.) 81.2 (28.) 111.0 (26.)  
 Trefferlage 1.09 mm rechts, 0.09 mm hoch  
 Streuwert 2.37, horizontal: 2.83, vertikal: 1.80

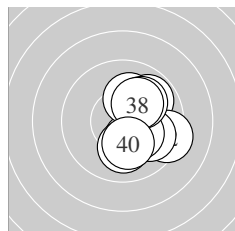

Serie 4:  
 9.8 ↗ 9.3 ↘ 10.3 \* 9.9 ↘ 10.3 \*  
 10.2 \* 10.0 ↗ 10.2 \* 10.1 ↓ 10.2 \*  
 beste Teiler 166.7 (33.) 170.6 (35.) 195.7 (40.)  
 Trefferlage 1.42 mm rechts, 0.25 mm tief  
 Streuwert 1.44, horizontal: 1.11, vertikal: 1.70

Unterschrift des Schützen

Meyton Elektronik

Ergebnis: **377** (396.4)  
 Serien: 93 91 95 98  
 Zähler: 19 19 2 0 0 0 0 0 0 0  
 Innenzehner: 13  
 weiteste: 637 (16), 559 (13), 481 (15)  
 beste Teiler 21.9 (33.) 48.2 (2.) 60.2 (39.)  
 Trefferlage 0.01 mm rechts, 0.62 mm hoch  
 Streuwert 2.07, horizontal: 2.19, vertikal: 1.94

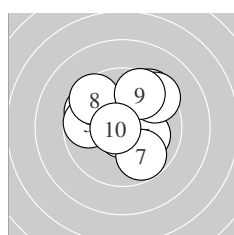
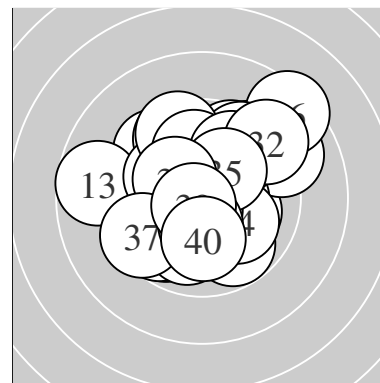

Serie 1:  
 9.7 ↖ 10.8 \* 9.7 ← 9.5 ↗ 10.1 →  
 9.4 ↗ 9.8 ↘ 9.6 ↖ 9.6 ↗ 10.7 \*  
 beste Teiler 48.2 (2.) 64.9 (10.) 211.2 (5.)  
 Trefferlage 0.12 mm rechts, 0.89 mm hoch  
 Streuwert 2.07, horizontal: 2.28, vertikal: 1.85

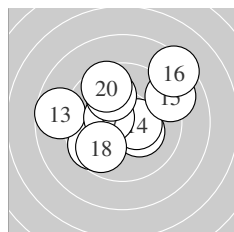

Serie 2:  
 9.6 ↙ 10.3 \* 8.7 ← 10.4 \* 9.0 →  
 8.4 ↗ 10.4 \* 9.8 ↙ 9.9 ↖ 9.6 ↖  
 beste Teiler 126.2 (14.) 126.8 (17.) 170.5 (12.)  
 Trefferlage 0.22 mm links, 0.82 mm hoch  
 Streuwert 2.70, horizontal: 3.12, vertikal: 2.22

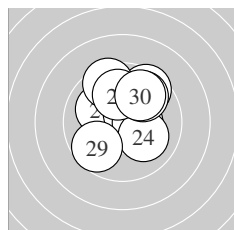

Serie 3:  
 10.1 ↖ 10.6 \* 10.4 \* 10.1 ↘ 9.5 ↗  
 9.5 ↖ 9.8 ↗ 10.0 ↑ 9.7 ↙ 9.8 ↗  
 beste Teiler 89.2 (22.) 133.1 (23.) 222.4 (24.)  
 Trefferlage 0.32 mm rechts, 1.17 mm hoch  
 Streuwert 1.76, horizontal: 1.67, vertikal: 1.85

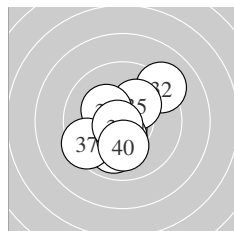

Serie 4:  
 10.0 ↓ 9.1 ↗ 10.9 \* 10.7 \* 10.2 \*  
 10.3 \* 9.5 ↙ 10.4 \* 10.7 \* 10.1 ↓  
 beste Teiler 21.9 (33.) 60.2 (39.) 64.6 (34.)  
 Trefferlage 0.14 mm links, 0.37 mm tief  
 Streuwert 1.72, horizontal: 1.69, vertikal: 1.75

Unterschrift des Schützen

Meyton Elektronik

Ergebnis: **367** (385.6)  
 Serien: 91 91 91 94  
 Zähler: 13 21 6 0 0 0 0 0 0 0  
 Innenzehner: 11  
 weiteste: 688 (17), 643 (19), 548 (25)  
 beste Teiler 74.9 (13.) 101.0 (27.) 111.2 (30.)  
 Trefferlage 0.61 mm links, 0.63 mm tief  
 Streuwert 2.52, horizontal: 3.02, vertikal: 1.90

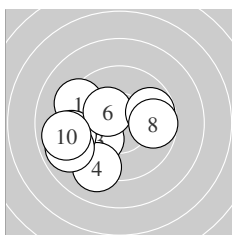
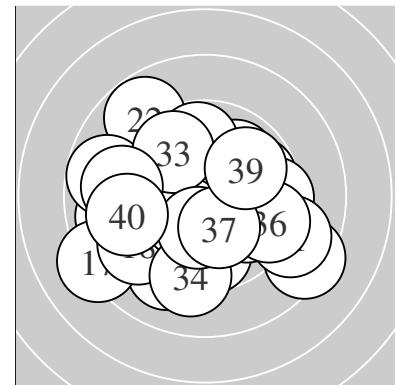

Serie 1:  
 9.3 ↖ 9.8 ↙ 10.0 ↙ 9.1 ↓ 9.1 ←  
 10.3 \* 9.8 → 9.7 → 8.9 ← 9.0 ←  
 beste Teiler 151.3 (6.) 234.2 (3.) 296.1 (2.)  
 Trefferlage 1.89 mm links, 0.80 mm tief  
 Streuwert 2.38, horizontal: 2.85, vertikal: 1.78

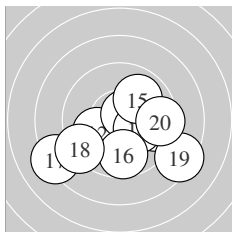

Serie 2:  
 9.7 → 10.0 ↙ 10.7 \* 10.2 \* 9.9 ↗  
 9.7 ↓ 8.2 ↙ 9.2 ↙ 8.4 ↘ 9.5 →  
 beste Teiler 74.9 (13.) 184.3 (14.) 233.9 (12.)  
 Trefferlage 0.49 mm rechts, 1.28 mm tief  
 Streuwert 2.79, horizontal: 3.49, vertikal: 1.85

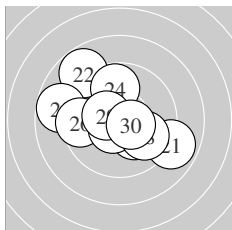

Serie 3:  
 8.9 ↘ 8.8 ↖ 10.2 \* 9.8 ↑ 8.8 ←  
 9.5 ← 10.5 \* 9.9 ↘ 10.4 \* 10.5 \*  
 beste Teiler 101.0 (27.) 111.2 (30.) 127.1 (29.)  
 Trefferlage 0.51 mm links, 0.22 mm hoch  
 Streuwert 2.58, horizontal: 3.02, vertikal: 2.04

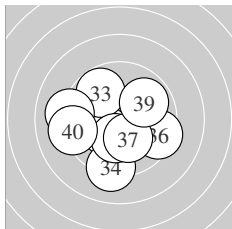

Serie 4:  
 10.5 \* 10.3 \* 9.8 ↖ 9.2 ↓ 10.2 \*  
 9.4 → 10.2 \* 9.1 ← 9.9 ↗ 9.2 ←  
 beste Teiler 115.0 (31.) 164.7 (32.) 179.5 (35.)  
 Trefferlage 0.52 mm links, 0.70 mm tief  
 Streuwert 2.28, horizontal: 2.60, vertikal: 1.91

Unterschrift des Schützen

Meyton Elektronik



Ergebnis: **395** (411.2)  
 Serien: 97 100 98 100  
 Zähler: 35 5 0 0 0 0 0 0 0 0  
 Innenzehner: 26  
 weiteste: 404 (22), 343 (2), 327 (26)  
 beste Teiler 15.0 (31.) 47.0 (13.) 54.0 (17.)  
 Trefferlage 0.36 mm rechts, 0.51 mm hoch  
 Streuwert 1.27, horizontal: 1.39, vertikal: 1.14

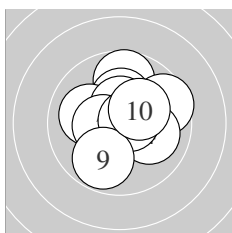
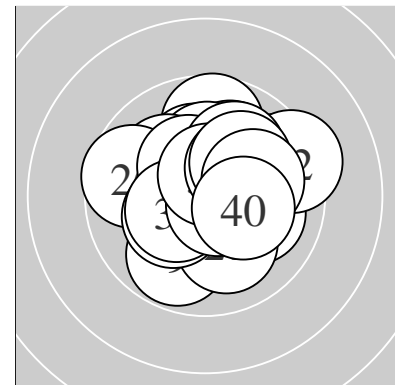

Serie 1:  
 9.7 ↑                      9.6 →                      10.2 \*                      10.0 →                      10.0 ↖  
 10.5 \*                      10.5 \*                      10.7 \*                      9.8 ↓                      10.3 \*  
 beste Teiler 70.3 (8.) 118.2 (6.) 122.1 (7.)  
 Trefferlage 0.33 mm rechts, 0.57 mm hoch  
 Streuwert 1.58, horizontal: 1.63, vertikal: 1.53

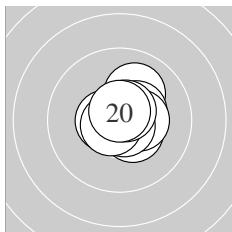

Serie 2:  
 10.1 ↗                      10.4 \*                      10.8 \*                      10.4 \*                      10.4 \*  
 10.6 \*                      10.7 \*                      10.7 \*                      10.6 \*                      10.7 \*  
 beste Teiler 47.0 (13.) 54.0 (17.) 65.0 (20.)  
 Trefferlage 0.33 mm rechts, 0.22 mm hoch  
 Streuwert 0.81, horizontal: 0.83, vertikal: 0.78

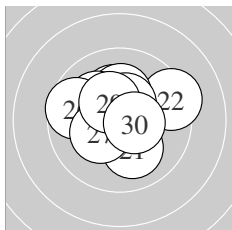

Serie 3:  
 10.1 ↓                      9.3 →                      10.2 \*                      10.2 \*                      10.1 ↘  
 9.6 ←                      10.3 \*                      10.4 \*                      10.4 \*                      10.5 \*  
 beste Teiler 108.8 (30.) 126.5 (28.) 147.7 (29.)  
 Trefferlage 0.10 mm links, 0.67 mm hoch  
 Streuwert 1.61, horizontal: 1.87, vertikal: 1.29

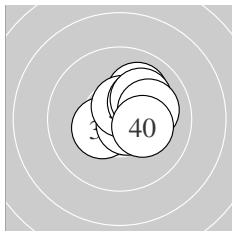

Serie 4:  
 10.9 \*                      10.4 \*                      10.7 \*                      10.1 ↗                      10.0 ↗  
 10.6 \*                      10.2 \*                      10.1 ↗                      10.1 →                      10.3 \*  
 beste Teiler 15.0 (31.) 66.0 (33.) 93.7 (36.)  
 Trefferlage 0.89 mm rechts, 0.58 mm hoch  
 Streuwert 0.97, horizontal: 1.01, vertikal: 0.93

Unterschrift des Schützen

Meyton Elektronik

Ergebnis: **375** (395.7)  
 Serien: 92 93 95 95  
 Zähler: 16 23 1 0 0 0 0 0 0 0  
 Innenzehner: 14  
 weiteste: 670 (7), 497 (38), 481 (10)  
 beste Teiler 7.2 (22.) 13.4 (1.) 40.2 (19.)  
 Trefferlage 0.72 mm links, 1.00 mm hoch  
 Streuwert 2.03, horizontal: 2.35, vertikal: 1.64

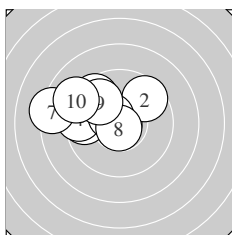
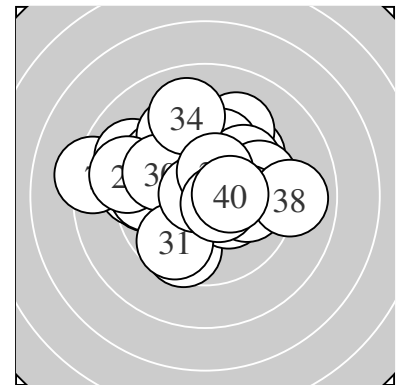

Serie 1:  
 10.9 \*                      9.6 ↗                      9.6 ←                      9.4 ←                      9.5 ↘  
 10.5 \*                      8.3 ←                      10.8 \*                      9.8 ↘                      9.0 ↘  
 beste Teiler 13.4 (1.) 47.6 (8.) 108.2 (6.)  
 Trefferlage 2.11 mm links, 1.12 mm hoch  
 Streuwert 2.00, horizontal: 2.60, vertikal: 1.14

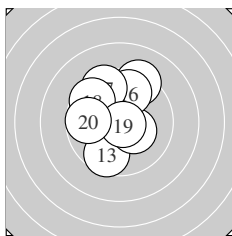

Serie 2:  
 9.7 ↘                      9.3 ↗                      9.6 ↓                      10.0 ↑                      10.3 \*  
 9.7 ↑                      9.5 ↘                      9.6 ↘                      10.8 \*                      9.7 ←  
 beste Teiler 40.2 (19.) 161.5 (15.) 242.1 (14.)  
 Trefferlage 0.75 mm links, 1.22 mm hoch  
 Streuwert 1.98, horizontal: 1.77, vertikal: 2.17

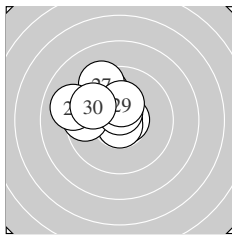

Serie 3:  
 10.7 \*                      10.9 \*                      10.8 \*                      9.6 ←                      10.6 \*  
 9.7 ↘                      9.4 ↘                      9.1 ←                      10.3 \*                      9.8 ↘  
 beste Teiler 7.2 (22.) 48.0 (23.) 68.1 (21.)  
 Trefferlage 1.28 mm links, 1.12 mm hoch  
 Streuwert 1.54, horizontal: 1.76, vertikal: 1.28

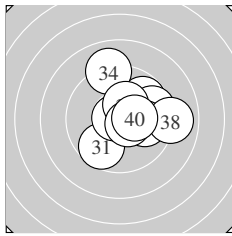

Serie 4:  
 9.7 ↓                      9.8 ↗                      9.6 →                      9.0 ↑                      10.8 \*  
 10.0 →                      10.3 \*                      9.0 →                      10.6 \*                      10.4 \*  
 beste Teiler 49.2 (35.) 93.1 (39.) 147.3 (40.)  
 Trefferlage 1.24 mm rechts, 0.55 mm hoch  
 Streuwert 1.99, horizontal: 2.06, vertikal: 1.91

Unterschrift des Schützen

Meyton Elektronik

Ergebnis: **380** (396.4)  
 Serien: 93 96 94 97  
 Zähler: 24 12 4 0 0 0 0 0 0 0  
 Innenzehner: 16  
 weiteste: 608 (19), 577 (5), 506 (6)  
 beste Teiler 26.5 (28.) 71.1 (10.) 74.8 (3.)  
 Trefferlage 0.17 mm links, 0.32 mm hoch  
 Streuwert 2.12, horizontal: 2.42, vertikal: 1.77

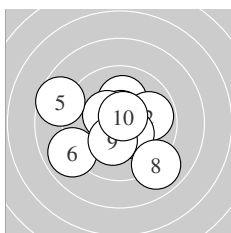
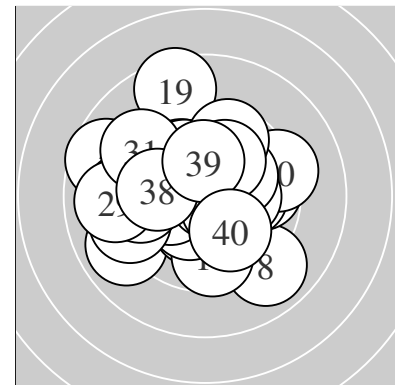

Serie 1:  
 10.1 ↑                      9.9 →                      10.7 \*                      10.4 \*                      8.6 ↖  
 8.9 ↙                      10.4 \*                      8.9 ↘                      10.3 \*                      10.7 \*  
 beste Teiler 71.1 (10.) 74.8 (3.) 131.5 (7.)  
 Trefferlage 0.39 mm links, 0.21 mm tief  
 Streuwert 2.38, horizontal: 2.74, vertikal: 1.96

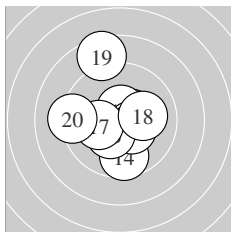

Serie 2:  
 10.5 \*                      10.6 \*                      10.5 \*                      9.6 ↓                      10.4 \*  
 10.3 \*                      10.2 \*                      10.1 →                      8.5 ↑                      9.2 ←  
 beste Teiler 95.7 (12.) 117.8 (11.) 119.4 (13.)  
 Trefferlage 0.28 mm links, 0.16 mm hoch  
 Streuwert 2.13, horizontal: 1.91, vertikal: 2.33

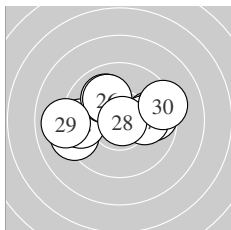

Serie 3:  
 9.2 ↙                      9.5 ←                      9.8 →                      10.0 ↘                      9.7 →  
 10.1 ↘                      10.0 →                      10.8 \*                      9.0 ←                      9.3 →  
 beste Teiler 26.5 (28.) 223.6 (26.) 229.0 (27.)  
 Trefferlage 0.26 mm links, 0.38 mm hoch  
 Streuwert 2.41, horizontal: 3.23, vertikal: 1.08

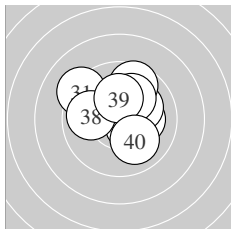

Serie 4:  
 9.2 ↘                      10.5 \*                      10.2 \*                      10.1 ↗                      9.6 ↗  
 10.4 \*                      10.1 ↗                      9.9 ←                      10.2 \*                      10.0 ↘  
 beste Teiler 110.3 (32.) 133.1 (36.) 191.2 (39.)  
 Trefferlage 0.25 mm rechts, 0.95 mm hoch  
 Streuwert 1.69, horizontal: 1.85, vertikal: 1.52

Unterschrift des Schützen

Meyton Elektronik

Ergebnis: **376** (392.0)  
 Serien: 95 94 95 92  
 Zähler: 17 22 1 0 0 0 0 0 0 0  
 Innenzehner: 9  
 weiteste: 638 (34), 487 (18), 478 (11)  
 beste Teiler 30.4 (23.) 59.2 (9.) 67.6 (40.)  
 Trefferlage 0.47 mm links, 0.35 mm tief  
 Streuwert 2.23, horizontal: 2.64, vertikal: 1.72

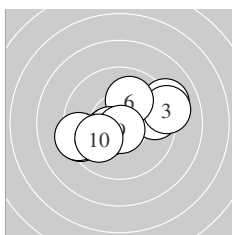
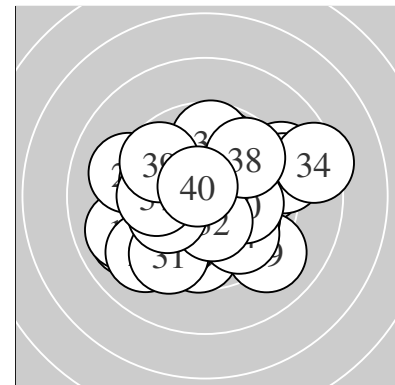

Serie 1:  
 9.6 → 9.1 ↗ 9.1 → 9.4 ← 10.4 \*  
 10.0 ↑ 10.5 \* 9.3 ← 10.7 \* 10.0 ←  
 beste Teiler 59.2 (9.) 112.4 (7.) 137.6 (5.)  
 Trefferlage 0.16 mm rechts, 0.00 mm  
 Streuwert 2.35, horizontal: 3.03, vertikal: 1.38

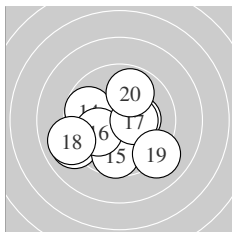

Serie 2:  
 9.0 ← 10.0 ← 10.3 \* 9.7 ↖ 9.7 ↓  
 10.0 ← 10.4 \* 9.0 ← 9.1 ↘ 9.9 ↑  
 beste Teiler 135.0 (17.) 163.1 (13.) 226.0 (12.)  
 Trefferlage 0.87 mm links, 0.81 mm tief  
 Streuwert 2.31, horizontal: 2.69, vertikal: 1.85

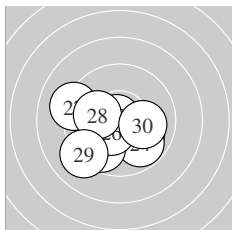

Serie 3:  
 10.0 ↘ 9.8 ↙ 10.8 \* 9.8 ↘ 9.7 ↙  
 10.4 \* 9.2 ↖ 10.1 ← 9.1 ↙ 10.1 →  
 beste Teiler 30.4 (23.) 129.6 (26.) 213.9 (28.)  
 Trefferlage 0.83 mm links, 1.06 mm tief  
 Streuwert 1.91, horizontal: 2.28, vertikal: 1.44

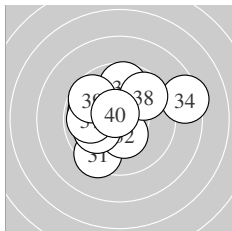

Serie 4:  
 9.4 ↙ 10.4 \* 10.0 ← 8.4 → 9.7 ↑  
 9.9 ↖ 9.9 ← 9.7 ↗ 9.7 ↖ 10.7 \*  
 beste Teiler 67.6 (40.) 148.0 (32.) 231.8 (33.)  
 Trefferlage 0.33 mm links, 0.47 mm hoch  
 Streuwert 2.41, horizontal: 2.81, vertikal: 1.93

Unterschrift des Schützen

Meyton Elektronik

Ergebnis: **384** (400.8)  
 Serien: 99 93 98 94  
 Zähler: 25 14 1 0 0 0 0 0 0 0  
 Innenzehner: 21  
 weiteste: 534 (31), 476 (39), 438 (3)  
 beste Teiler 47.4 (6.) 88.2 (4.) 91.9 (23.)  
 Trefferlage 0.40 mm rechts, 0.82 mm hoch  
 Streuwert 1.76, horizontal: 2.13, vertikal: 1.30

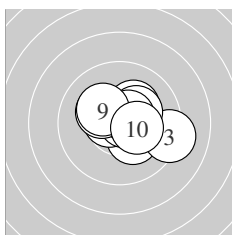
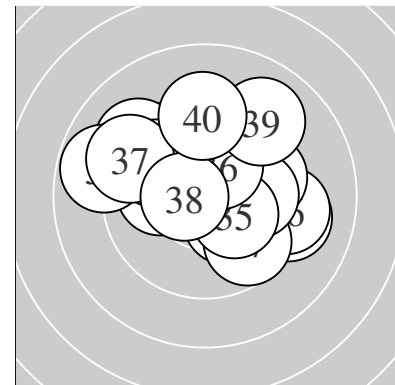

Serie 1:  
 10.3 \*                      10.2 \*                      9.2 →                      10.6 \*                      10.3 \*  
 10.8 \*                      10.6 \*                      10.2 \*                      10.2 \*                      10.3 \*  
 beste Teiler 47.4 (6.) 88.2 (4.) 92.6 (7.)  
 Trefferlage 0.68 mm rechts, 0.26 mm hoch  
 Streuwert 1.37, horizontal: 1.70, vertikal: 0.93

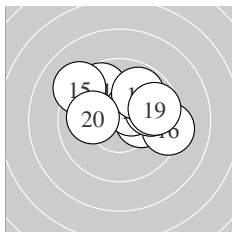

Serie 2:  
 9.7 ↖                      9.9 →                      10.2 \*                      10.4 \*                      9.2 ↗  
 9.3 →                      9.8 →                      9.9 ↗                      9.7 →                      10.0 ←  
 beste Teiler 135.2 (14.) 186.2 (13.) 229.1 (20.)  
 Trefferlage 0.96 mm rechts, 0.99 mm hoch  
 Streuwert 1.97, horizontal: 2.53, vertikal: 1.19

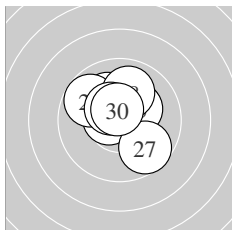

Serie 3:  
 10.6 \*                      10.1 ↖                      10.6 \*                      10.3 \*                      10.3 \*  
 9.8 ↖                      9.7 ↖                      10.0 ↑                      10.5 \*                      10.6 \*  
 beste Teiler 91.9 (23.) 93.3 (30.) 94.7 (21.)  
 Trefferlage 0.11 mm rechts, 0.76 mm hoch  
 Streuwert 1.36, horizontal: 1.43, vertikal: 1.29

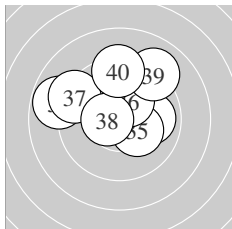

Serie 4:  
 8.8 ↖                      10.0 →                      9.9 →                      10.3 \*                      10.2 \*  
 10.3 \*                      9.2 ↖                      10.5 \*                      9.0 ↗                      9.3 ↑  
 beste Teiler 105.0 (38.) 158.3 (34.) 171.8 (36.)  
 Trefferlage 0.14 mm links, 1.29 mm hoch  
 Streuwert 2.25, horizontal: 2.72, vertikal: 1.64

Unterschrift des Schützen

Meyton Elektronik

Ergebnis:	<b>368</b>	(386.2)
Serien:	94 92 93 89	
Zähler:	16 18 4 2 0 0 0 0 0 0	
Innenzehner:	11	
weiteste:	767 (3), 751 (32), 744 (16)	
beste Teiler	68.6 (4.) 107.0 (25.) 125.8 (14.)	
Trefferlage	0.16 mm links, 0.09 mm hoch	
Streuwert	2.66, horizontal: 3.45, vertikal: 1.49	

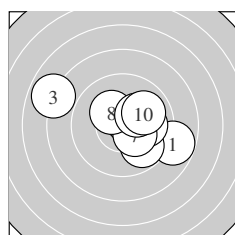
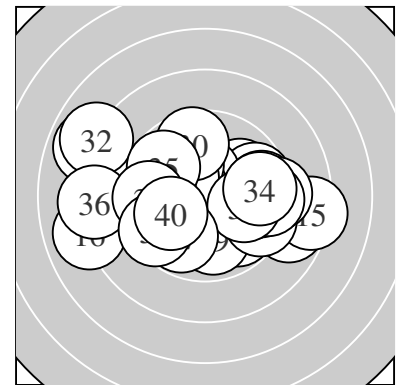

Serie 1:	8.8 →	9.8 ↘	7.9 ↖	10.7 *	10.4 *
	10.0 →	10.3 *	10.3 *	10.2 *	10.0 ↗
beste Teiler	68.6 (4.)	141.7 (5.)	157.8 (7.)		
Trefferlage	0.78 mm rechts, 0.15 mm hoch				
Streuwert	2.51, horizontal: 3.18, vertikal: 1.57				

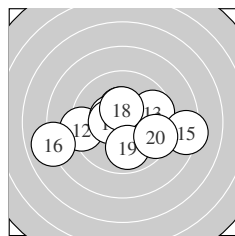

Serie 2:	10.4 *	9.3 ←	9.7 →	10.5 *	8.3 →
	8.0 ←	10.4 *	10.4 *	9.9 ↓	9.5 ↘
beste Teiler	125.8 (14.)	126.0 (17.)	135.7 (11.)		
Trefferlage	0.05 mm links, 0.37 mm tief				
Streuwert	2.92, horizontal: 3.86, vertikal: 1.46				

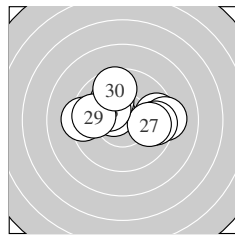

Serie 3:	9.6 →	9.2 →	9.6 →	9.3 ←	10.5 *
	10.1 ↘	9.8 →	10.2 *	9.8 ←	9.6 ↑
beste Teiler	107.0 (25.)	178.6 (28.)	221.2 (26.)		
Trefferlage	0.26 mm rechts, 0.72 mm hoch				
Streuwert	2.23, horizontal: 2.95, vertikal: 1.10				

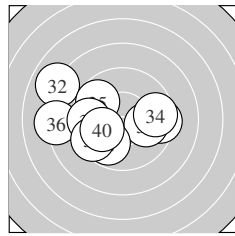

Serie 4:	9.4 →	7.9 ↖	10.0 →	9.6 →	9.7 ↘
	8.2 ←	9.8 ↙	9.6 ←	9.5 ↙	10.0 ←
beste Teiler	235.6 (40.)	246.1 (33.)	285.2 (37.)		
Trefferlage	1.64 mm links, 0.12 mm tief				
Streuwert	2.95, horizontal: 3.79, vertikal: 1.74				

Unterschrift des Schützen

Meyton Elektronik

Ergebnis: **391** (406.4)  
 Serien: 97 97 98 99  
 Zähler: 32 7 1 0 0 0 0 0 0 0  
 Innenzehner: 23  
 weiteste: 657 (9), 398 (28), 324 (40)  
 beste Teiler 54.1 (33.) 54.7 (37.) 69.5 (3.)  
 Trefferlage 0.06 mm rechts, 0.01 mm hoch  
 Streuwert 1.62, horizontal: 1.87, vertikal: 1.33

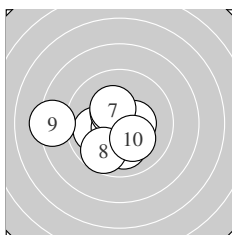
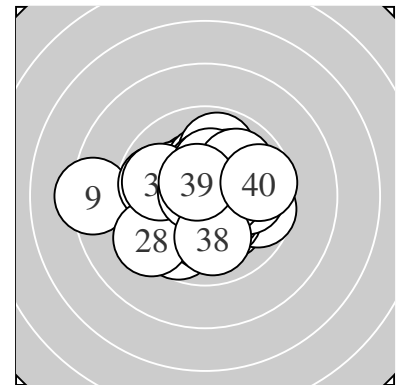

Serie 1:  
 10.0 ← 10.4 \* 10.7 \* 10.0 ↓ 10.5 \*  
 10.4 \* 10.3 \* 9.7 ↙ 8.3 ← 10.2 \*  
 beste Teiler 69.5 (3.) 123.3 (5.) 130.2 (2.)  
 Trefferlage 0.82 mm links, 0.58 mm tief  
 Streuwert 1.90, horizontal: 2.35, vertikal: 1.30

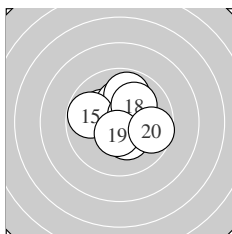

Serie 2:  
 10.2 \* 10.2 \* 9.9 ↑ 10.3 \* 9.8 ←  
 10.4 \* 10.3 \* 10.1 ↗ 10.5 \* 9.7 →  
 beste Teiler 112.3 (19.) 128.4 (16.) 160.1 (14.)  
 Trefferlage 0.39 mm rechts, 0.53 mm hoch  
 Streuwert 1.52, horizontal: 1.70, vertikal: 1.33

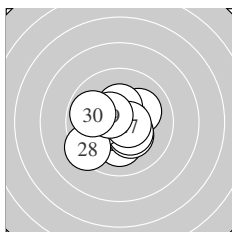

Serie 3:  
 10.1 ↗ 10.4 \* 10.1 ↓ 10.3 \* 10.4 \*  
 10.2 \* 10.6 \* 9.4 ↙ 10.5 \* 9.9 ←  
 beste Teiler 87.0 (27.) 116.0 (29.) 142.2 (25.)  
 Trefferlage 0.38 mm links, 0.32 mm tief  
 Streuwert 1.54, horizontal: 1.71, vertikal: 1.35

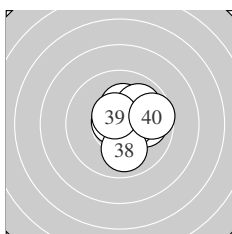

Serie 4:  
 10.1 ↗ 10.0 → 10.7 \* 10.5 \* 10.3 \*  
 10.0 ↗ 10.7 \* 10.0 ↓ 10.6 \* 9.7 →  
 beste Teiler 54.1 (33.) 54.7 (37.) 92.7 (39.)  
 Trefferlage 1.07 mm rechts, 0.41 mm hoch  
 Streuwert 1.20, horizontal: 1.22, vertikal: 1.18

Unterschrift des Schützen

Meyton Elektronik

Ergebnis: **381** (399.2)  
 Serien: 92 95 96 98  
 Zähler: 23 15 2 0 0 0 0 0 0 0  
 Innenzehner: 19  
 weiteste: 586 (4), 536 (19), 470 (31)  
 beste Teiler 5.8 (38.) 56.8 (33.) 60.2 (21.)  
 Trefferlage 0.16 mm links, 0.54 mm tief  
 Streuwert 1.96, horizontal: 2.18, vertikal: 1.72

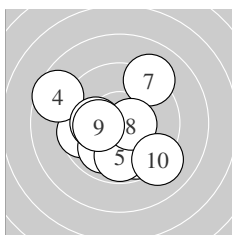
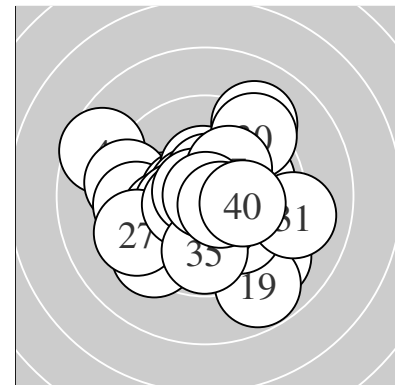

Serie 1:  
 9.6 ← 9.8 ↘ 9.9 ✓ 8.6 ↖ 9.8 ↓  
 10.1 ← 9.1 ↗ 10.6 \* 10.2 \* 9.1 ↘  
 beste Teiler 100.4 (8.) 184.2 (9.) 208.0 (6.)  
 Trefferlage 0.56 mm links, 0.56 mm tief  
 Streuwert 2.50, horizontal: 2.71, vertikal: 2.27

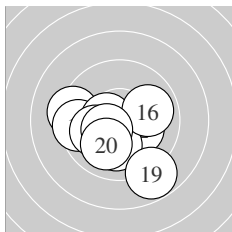

Serie 2:  
 9.3 ← 10.2 \* 9.5 ← 10.1 ↓ 10.5 \*  
 9.9 → 10.0 ← 10.4 \* 8.8 ↘ 10.0 ✓  
 beste Teiler 113.7 (15.) 138.8 (18.) 180.2 (12.)  
 Trefferlage 0.66 mm links, 1.01 mm tief  
 Streuwert 2.02, horizontal: 2.35, vertikal: 1.61

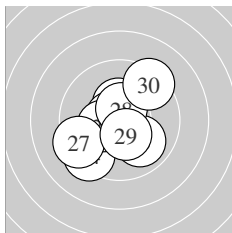

Serie 3:  
 10.7 \* 10.4 \* 9.9 ↘ 9.3 ✓ 10.6 \*  
 10.3 \* 9.3 ← 10.5 \* 10.4 \* 9.3 ↗  
 beste Teiler 60.2 (21.) 76.8 (25.) 102.2 (28.)  
 Trefferlage 0.35 mm links, 0.33 mm tief  
 Streuwert 1.84, horizontal: 1.86, vertikal: 1.83

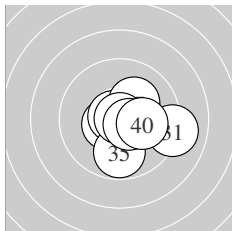

Serie 4:  
 9.1 → 10.5 \* 10.7 \* 10.4 \* 9.8 ↓  
 10.6 \* 10.2 \* 10.9 \* 10.6 \* 10.2 \*  
 beste Teiler 5.8 (38.) 56.8 (33.) 89.5 (36.)  
 Trefferlage 0.91 mm rechts, 0.25 mm tief  
 Streuwert 1.38, horizontal: 1.58, vertikal: 1.15

Unterschrift des Schützen

Meyton Elektronik