

Ergebnis: **392.5** (377)  
 Serien: 97.4 97.2 98.5 99.4  
 Zähler: 19 19 2 0 0 0 0 0 0 0  
 Innenzehner: 11  
 weiteste: 717 (19), 529 (17), 464 (35)  
 beste Teiler 13.9 (33.) 29.0 (13.) 34.6 (31.)  
 Trefferlage 0.36 mm links, 1.12 mm tief  
 Streuwert 2.17, horizontal: 2.28, vertikal: 2.05

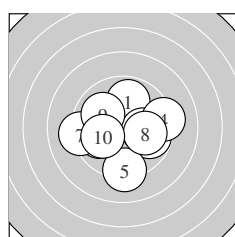

Serie 1:  
 9.9 ↑                      10.1 →                      9.8 ↘                      9.2 →                      9.2 ↓  
 9.9 ←                      9.2 ←                      10.0 →                      10.0 ↖                      10.1 ←  
 beste Teiler 208.7 (2.) 225.5 (10.) 239.8 (8.)  
 Trefferlage 0.13 mm rechts, 0.40 mm tief  
 Streuwert 2.34, horizontal: 2.75, vertikal: 1.85

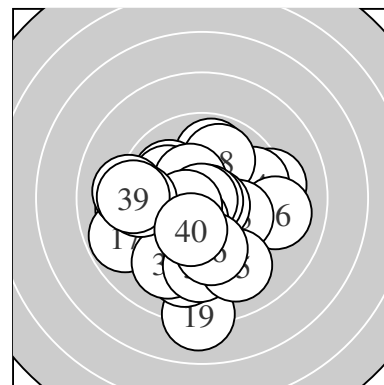
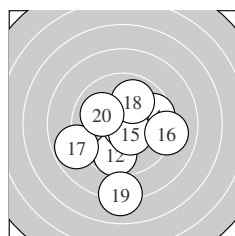

Serie 2:  
 10.6 \*                      9.7 ↓                      10.8 \*                      9.7 →                      10.5 \*  
 9.1 →                      8.8 ←                      9.9 ↑                      8.1 ↓                      10.0 ↖  
 beste Teiler 29.0 (13.) 85.0 (11.) 122.6 (15.)  
 Trefferlage 0.22 mm rechts, 1.11 mm tief  
 Streuwert 2.61, horizontal: 2.57, vertikal: 2.66

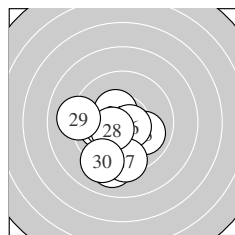

Serie 3:  
 10.0 ←                      9.1 ↓                      10.0 ↘                      10.3 \*                      10.4 \*  
 10.6 \*                      9.4 ↓                      10.4 \*                      9.1 ←                      9.2 ↙  
 beste Teiler 84.5 (26.) 128.4 (28.) 132.0 (25.)  
 Trefferlage 1.03 mm links, 1.39 mm tief  
 Streuwert 1.91, horizontal: 1.84, vertikal: 1.98

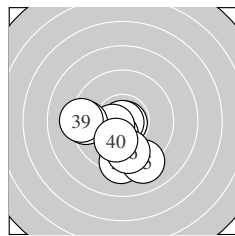

Serie 4:  
 10.8 \*                      9.3 ↓                      10.9 \*                      10.3 \*                      9.1 ↓  
 9.7 ↓                      10.5 \*                      9.4 ←                      9.3 ←                      10.1 ↙  
 beste Teiler 13.9 (33.) 34.6 (31.) 113.6 (37.)  
 Trefferlage 0.76 mm links, 1.57 mm tief  
 Streuwert 1.81, horizontal: 1.92, vertikal: 1.70

Unterschrift des Schützen

Meyton Elektronik

Ergebnis: **415.7** (398)  
 Serien: 103.8 103.6 104.2 104.1  
 Zähler: 38 2 0 0 0 0 0 0 0 0  
 Innenzehner: 34  
 weiteste: 283 (1), 262 (17), 245 (9)  
 beste Teiler 31.2 (28.) 39.5 (2.) 48.6 (26.)  
 Trefferlage 0.17 mm links, 0.25 mm hoch  
 Streuwert 1.07, horizontal: 1.01, vertikal: 1.12

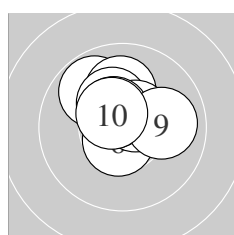
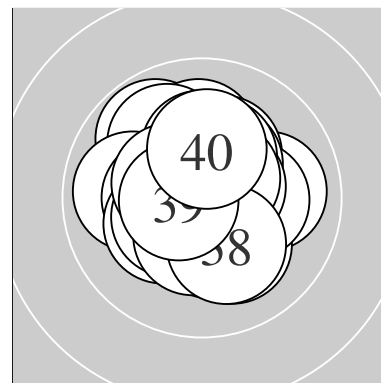

Serie 1:  
 9.8 ↘ 10.8 \* 10.7 \* 10.1 ↑ 10.3 \*  
 10.6 \* 10.5 \* 10.5 \* 10.0 → 10.5 \*  
 beste Teiler 39.5 (2.) 70.7 (3.) 86.3 (6.)  
 Trefferlage 0.08 mm links, 0.89 mm hoch  
 Streuwert 1.01, horizontal: 1.10, vertikal: 0.92

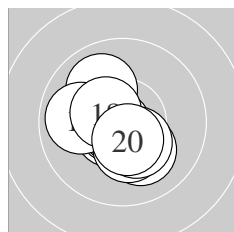

Serie 2:  
 10.6 \* 10.1 ↘ 10.0 ↘ 10.7 \* 10.7 \*  
 10.3 \* 9.9 ← 10.5 \* 10.3 \* 10.5 \*  
 beste Teiler 53.0 (15.) 66.7 (14.) 95.0 (11.)  
 Trefferlage 0.40 mm links, 0.39 mm tief  
 Streuwert 1.13, horizontal: 1.12, vertikal: 1.14

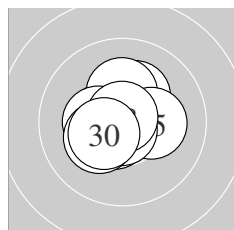

Serie 3:  
 10.2 \* 10.4 \* 10.6 \* 10.2 \* 10.2 \*  
 10.8 \* 10.3 \* 10.8 \* 10.3 \* 10.4 \*  
 beste Teiler 31.2 (28.) 48.6 (26.) 88.0 (23.)  
 Trefferlage 0.35 mm links, 0.09 mm hoch  
 Streuwert 1.01, horizontal: 1.07, vertikal: 0.94

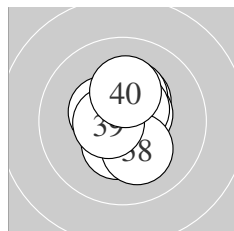

Serie 4:  
 10.4 \* 10.6 \* 10.3 \* 10.5 \* 10.4 \*  
 10.5 \* 10.4 \* 10.2 \* 10.6 \* 10.2 \*  
 beste Teiler 88.5 (39.) 99.7 (32.) 101.1 (36.)  
 Trefferlage 0.16 mm rechts, 0.42 mm hoch  
 Streuwert 1.00, horizontal: 0.75, vertikal: 1.20

Unterschrift des Schützen

Meyton Elektronik



Ergebnis: **374.4** (357)  
 Serien: 93.0 94.7 95.3 91.4  
 Zähler: 15 12 11 1 0 0 1 0 0 0  
 Innenzehner: 9  
 weiteste: 1564 (38), 776 (10), 683 (6)  
 beste Teiler 51.7 (33.) 76.5 (18.) 116.0 (26.)  
 Trefferlage 0.54 mm links, 0.35 mm tief  
 Streuwert 3.39, horizontal: 4.17, vertikal: 2.37

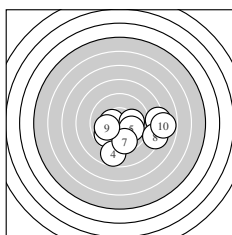
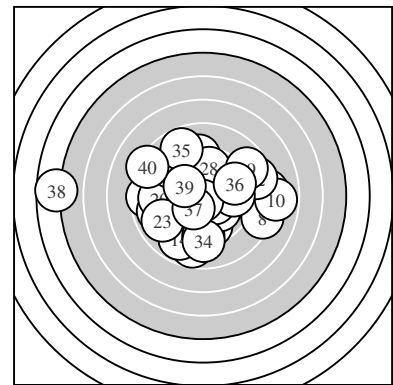

Serie 1:  
 10.4 \*                      10.1 →                      9.8 ↙                      8.8 ↓                      10.0 ↘  
 8.2 →                      9.6 ↓                      8.3 ↘                      10.0 ←                      7.8 →  
 beste Teiler 136.3 (1.) 216.2 (2.) 232.1 (5.)  
 Trefferlage 1.90 mm rechts, 1.39 mm tief  
 Streuwert 3.02, horizontal: 3.85, vertikal: 1.85

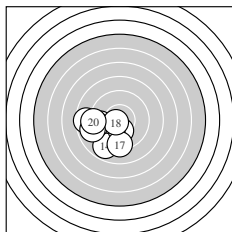

Serie 2:  
 10.3 \*                      8.6 ←                      9.6 ←                      8.9 ↙                      9.3 ←  
 10.2 \*                      9.2 ↓                      10.6 \*                      8.9 ←                      9.1 ←  
 beste Teiler 76.5 (18.) 168.6 (11.) 187.5 (16.)  
 Trefferlage 2.66 mm links, 1.58 mm tief  
 Streuwert 1.96, horizontal: 2.25, vertikal: 1.61

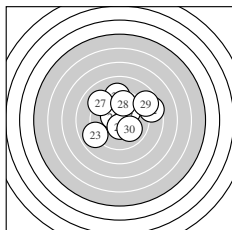

Serie 3:  
 9.2 ↑                      8.6 →                      8.9 ↙                      10.1 ↗                      10.4 \*  
 10.5 \*                      9.1 ↘                      9.7 ↑                      8.8 ↗                      10.0 ↘  
 beste Teiler 116.0 (26.) 131.6 (25.) 207.8 (24.)  
 Trefferlage 0.49 mm rechts, 1.19 mm hoch  
 Streuwert 2.75, horizontal: 3.14, vertikal: 2.30

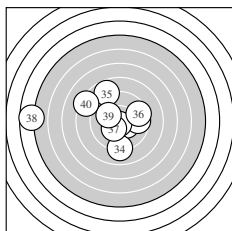

Serie 4:  
 10.4 \*                      9.6 →                      10.7 \*                      9.0 ↓                      8.8 ↖  
 9.5 →                      10.3 \*                      4.7 ←                      10.1 ↘                      8.3 ↖  
 beste Teiler 51.7 (33.) 146.1 (31.) 166.2 (37.)  
 Trefferlage 1.90 mm links, 0.36 mm hoch  
 Streuwert 4.34, horizontal: 5.55, vertikal: 2.62

Unterschrift des Schützen

Meyton Elektronik

Ergebnis: **396.9** (379)  
 Serien: 98.5 100.6 100.9 96.9  
 Zähler: 19 21 0 0 0 0 0 0 0 0  
 Innenzehner: 14  
 weiteste: 472 (5), 464 (4), 449 (37)  
 beste Teiler 61.1 (1.) 80.7 (20.) 104.0 (7.)  
 Trefferlage 0.51 mm links, 0.17 mm tief  
 Streuwert 1.98, horizontal: 2.13, vertikal: 1.82

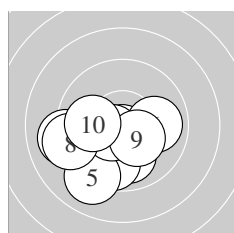
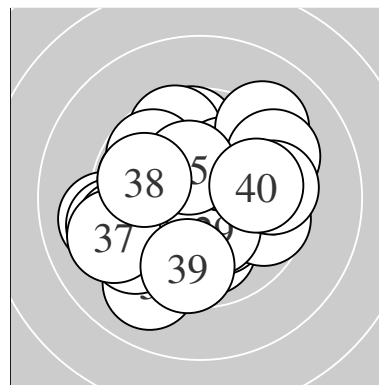

Serie 1:  
 10.7 \*                      10.0 ↓                      9.7 ↓                      9.1 ←                      9.1 ↓  
 9.9 →                      10.5 \*                      9.2 ←                      10.3 \*                      10.0 ←  
 beste Teiler 61.1 (1.) 104.0 (7.) 155.0 (9.)  
 Trefferlage 1.10 mm links, 1.37 mm tief  
 Streuwert 1.87, horizontal: 2.27, vertikal: 1.36

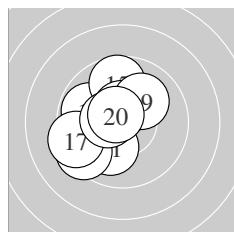

Serie 2:  
 10.1 ↓                      9.4 ↙                      10.5 \*                      9.8 ↖                      9.7 ↑  
 10.5 \*                      9.4 ←                      10.5 \*                      10.1 ↗                      10.6 \*  
 beste Teiler 80.7 (20.) 106.1 (13.) 106.6 (16.)  
 Trefferlage 1.17 mm links, 0.27 mm hoch  
 Streuwert 1.63, horizontal: 1.55, vertikal: 1.70

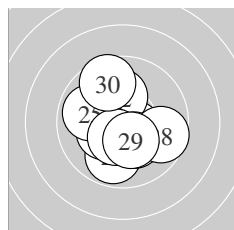

Serie 3:  
 10.5 \*                      10.1 ↑                      9.8 ↓                      10.3 \*                      9.9 ↖  
 10.3 \*                      10.4 \*                      9.7 →                      10.3 \*                      9.6 ↗  
 beste Teiler 104.9 (21.) 132.4 (27.) 159.3 (29.)  
 Trefferlage 0.12 mm links, 0.31 mm tief  
 Streuwert 1.67, horizontal: 1.57, vertikal: 1.76

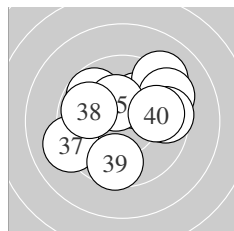

Serie 4:  
 10.2 \*                      9.8 ↖                      9.2 ↗                      9.3 ↗                      10.3 \*  
 9.6 →                      9.2 ←                      9.8 ↖                      9.6 ↓                      9.9 →  
 beste Teiler 154.3 (35.) 198.6 (31.) 275.3 (40.)  
 Trefferlage 0.35 mm rechts, 0.72 mm hoch  
 Streuwert 2.40, horizontal: 2.78, vertikal: 1.94

Unterschrift des Schützen

Meyton Elektronik

Ergebnis: **408.7** (390)  
 Serien: 103.0 102.8 102.6 100.3  
 Zähler: 30 10 0 0 0 0 0 0 0 0  
 Innenzehner: 26  
 weiteste: 389 (35), 367 (33), 311 (9)  
 beste Teiler 13.4 (12.) 51.4 (39.) 53.3 (1.)  
 Trefferlage 0.66 mm rechts, 0.28 mm hoch  
 Streuwert 1.36, horizontal: 1.52, vertikal: 1.17

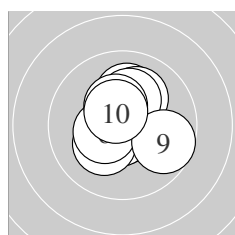
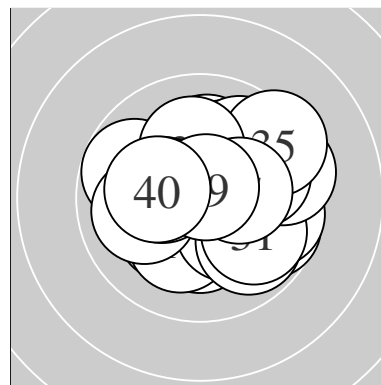

Serie 1:  
 10.7 \*                      10.7 \*                      10.1 ↑                      10.1 ↗                      10.2 \*  
 10.4 \*                      10.2 \*                      10.4 \*                      9.7 →                      10.5 \*  
 beste Teiler 53.3 (1.) 69.2 (2.) 108.2 (10.)  
 Trefferlage 0.09 mm rechts, 0.40 mm hoch  
 Streuwert 1.28, horizontal: 1.21, vertikal: 1.35

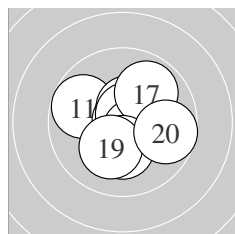

Serie 2:  
 9.8 ↖                      10.9 \*                      10.5 \*                      10.4 \*                      10.7 \*  
 10.5 \*                      9.9 ↗                      10.2 \*                      10.2 \*                      9.7 →  
 beste Teiler 13.4 (12.) 65.0 (15.) 101.4 (16.)  
 Trefferlage 0.40 mm rechts, 0.03 mm hoch  
 Streuwert 1.41, horizontal: 1.55, vertikal: 1.25

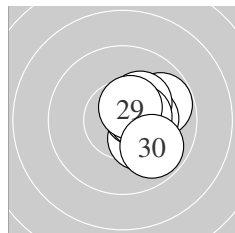

Serie 3:  
 10.4 \*                      9.8 →                      10.3 \*                      10.3 \*                      10.3 \*  
 10.5 \*                      10.3 \*                      10.4 \*                      10.5 \*                      9.8 ↘  
 beste Teiler 101.5 (26.) 105.4 (29.) 126.4 (28.)  
 Trefferlage 1.41 mm rechts, 0.09 mm hoch  
 Streuwert 0.86, horizontal: 0.60, vertikal: 1.05

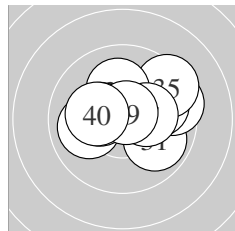

Serie 4:  
 9.9 ↘                      10.0 ←                      9.5 →                      9.9 →                      9.4 ↗  
 10.1 ↑                      10.3 \*                      10.3 \*                      10.7 \*                      10.2 \*  
 beste Teiler 51.4 (39.) 162.5 (38.) 169.8 (37.)  
 Trefferlage 0.72 mm rechts, 0.59 mm hoch  
 Streuwert 1.73, horizontal: 2.17, vertikal: 1.11

Unterschrift des Schützen

Meyton Elektronik

Ergebnis: **366.6** (349)  
 Serien: 91.9 93.9 92.7 88.1  
 Zähler: 6 22 8 3 1 0 0 0 0 0  
 Innenzehner: 6  
 weiteste: 1179 (38), 836 (34), 793 (19)  
 beste Teiler 98.6 (21.) 107.7 (35.) 136.9 (8.)  
 Trefferlage 1.06 mm links, 0.80 mm tief  
 Streuwert 3.45, horizontal: 3.33, vertikal: 3.57

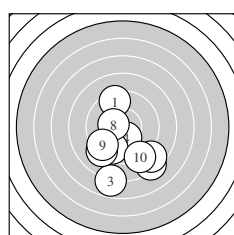
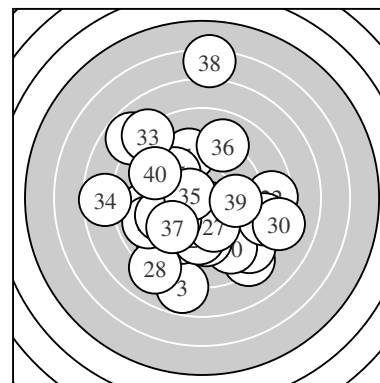

Serie 1:  
 9.4 ↑                      8.3 ↘                      7.8 ↓                      10.3 \*                      9.6 ↓  
 8.6 ↘                      9.1 ↙                      10.4 \*                      9.4 ↗                      9.0 ↘  
 beste Teiler 136.9 (8.) 158.1 (4.) 338.5 (5.)  
 Trefferlage 0.03 mm links, 2.78 mm tief  
 Streuwert 2.92, horizontal: 2.68, vertikal: 3.15

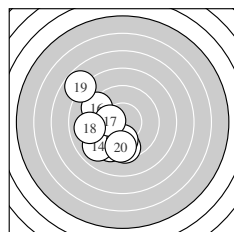

Serie 2:  
 10.2 \*                      9.5 ↓                      9.4 ↗                      9.0 ↗                      9.9 ↓  
 9.3 ↖                      10.2 \*                      9.0 ←                      7.8 ↖                      9.6 ↓  
 beste Teiler 181.2 (17.) 198.3 (11.) 258.0 (15.)  
 Trefferlage 2.35 mm links, 0.98 mm tief  
 Streuwert 2.55, horizontal: 2.11, vertikal: 2.92

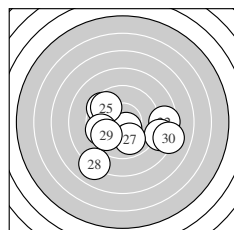

Serie 3:  
 10.6 \*                      8.6 →                      8.7 ↗                      9.5 ↖                      9.7 ↖  
 9.6 ←                      9.9 ↓                      8.1 ↙                      9.8 ↗                      8.2 →  
 beste Teiler 98.6 (21.) 259.4 (27.) 295.4 (29.)  
 Trefferlage 0.47 mm rechts, 1.20 mm tief  
 Streuwert 3.35, horizontal: 4.12, vertikal: 2.34

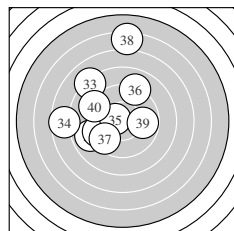

Serie 4:  
 8.9 ←                      9.4 ←                      8.1 ↖                      7.6 ←                      10.5 \*  
 9.0 ↑                      9.5 ↗                      6.2 ↑                      9.8 →                      9.1 ↖  
 beste Teiler 107.7 (35.) 291.0 (39.) 358.5 (37.)  
 Trefferlage 2.35 mm links, 1.75 mm hoch  
 Streuwert 3.95, horizontal: 3.44, vertikal: 4.41

Unterschrift des Schützen

Meyton Elektronik

Ergebnis: **353.6** (335)  
 Serien: 87.5 89.4 91.4 85.3  
 Zähler: 7 14 10 7 1 0 1 0 0 0  
 Innenzehner: 4  
 weiteste: 1695 (32), 1167 (16), 919 (40)  
 beste Teiler 109.6 (12.) 171.1 (18.) 184.1 (11.)  
 Trefferlage 0.13 mm links, 0.36 mm hoch  
 Streuwert 4.40, horizontal: 4.18, vertikal: 4.61

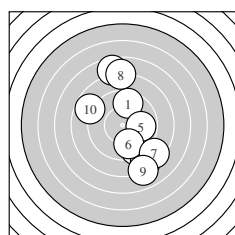
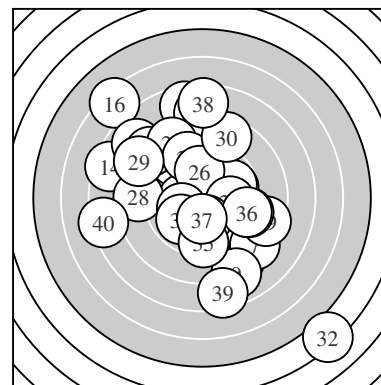

Serie 1:  
 9.6 ↑                      7.6 ↑                      9.3 ↓                      8.3 ↓                      9.8 →  
 9.8 ↓                      8.4 ↘                      7.9 ↑                      8.0 ↓                      8.8 ↖  
 beste Teiler 276.6 (5.) 294.7 (6.) 339.7 (1.)  
 Trefferlage 1.09 mm rechts, 0.16 mm tief  
 Streuwert 4.30, horizontal: 2.82, vertikal: 5.38

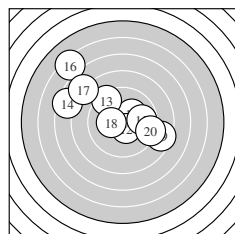

Serie 2:  
 10.2 \*                      10.5 \*                      9.3 ↖                      7.4 ↖                      9.8 →  
 6.3 ↖                      7.9 ↖                      10.3 \*                      8.5 →                      9.2 →  
 beste Teiler 109.6 (12.) 171.1 (18.) 184.1 (11.)  
 Trefferlage 1.14 mm links, 1.67 mm hoch  
 Streuwert 4.22, horizontal: 4.99, vertikal: 3.29

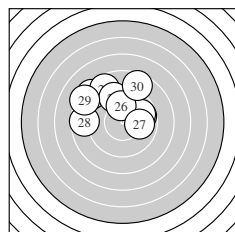

Serie 3:  
 9.7 →                      8.4 ↖                      8.7 ↖                      9.4 ↑                      9.8 →  
 10.0 ↑                      9.9 →                      8.6 ←                      8.3 ↖                      8.6 ↑  
 beste Teiler 247.0 (26.) 256.7 (27.) 294.6 (25.)  
 Trefferlage 1.01 mm links, 2.61 mm hoch  
 Streuwert 2.90, horizontal: 3.56, vertikal: 2.05

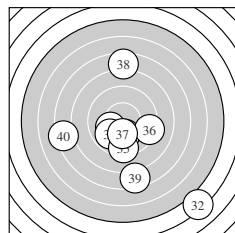

Serie 4:  
 10.1 ↖                      4.2 ↘                      9.9 ↗                      10.1 ↓                      9.3 ↓  
 9.3 →                      10.2 \*                      7.5 ↑                      7.4 ↓                      7.3 ←  
 beste Teiler 189.0 (37.) 202.9 (34.) 204.3 (31.)  
 Trefferlage 0.52 mm rechts, 2.68 mm tief  
 Streuwert 5.28, horizontal: 5.09, vertikal: 5.46

Unterschrift des Schützen

Meyton Elektronik



Ergebnis: **361.4** (344)  
 Serien: 83.8 96.4 91.2 90.0  
 Zähler: 6 18 12 2 2 0 0 0 0 0  
 Innenzehner: 4  
 weiteste: 1160 (9), 1140 (6), 825 (27)  
 beste Teiler 125.0 (39.) 160.0 (18.) 166.3 (11.)  
 Trefferlage 0.10 mm rechts, 0.91 mm tief  
 Streuwert 3.76, horizontal: 4.45, vertikal: 2.90

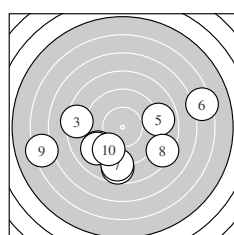
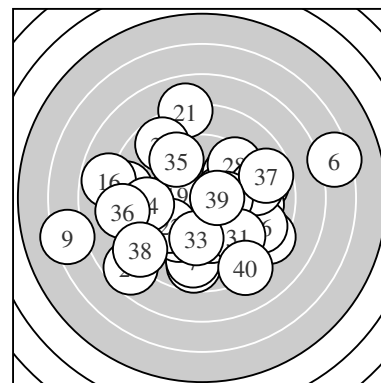

Serie 1:  
 8.7 ↓                      9.2 ↙                      8.4 ←                      9.1 ↘                      8.9 →  
 6.4 →                      8.9 ↓                      8.4 ↘                      6.3 ←                      9.5 ↘  
 beste Teiler 360.9 (10.) 439.3 (2.) 461.5 (4.)  
 Trefferlage 0.64 mm links, 2.09 mm tief  
 Streuwert 4.92, horizontal: 6.36, vertikal: 2.84

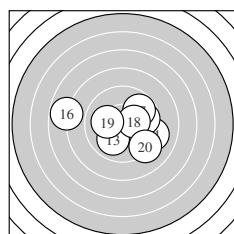

Serie 2:  
 10.3 \*                      9.9 →                      10.0 ↘                      9.2 →                      9.8 →  
 7.8 ←                      9.8 ↗                      10.3 \*                      10.1 ←                      9.2 ↘  
 beste Teiler 160.0 (18.) 166.3 (11.) 213.4 (19.)  
 Trefferlage 0.70 mm rechts, 0.29 mm tief  
 Streuwert 2.74, horizontal: 3.55, vertikal: 1.56

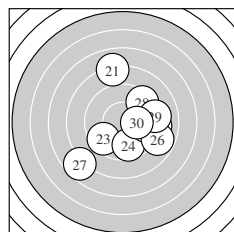

Serie 3:  
 8.0 ↑                      9.1 →                      9.6 ↙                      9.7 ↓                      9.6 →  
 8.8 ↘                      7.7 ↙                      9.4 ↗                      9.1 →                      10.2 \*  
 beste Teiler 196.1 (30.) 323.7 (24.) 335.0 (25.)  
 Trefferlage 1.26 mm rechts, 0.39 mm tief  
 Streuwert 3.56, horizontal: 3.56, vertikal: 3.55

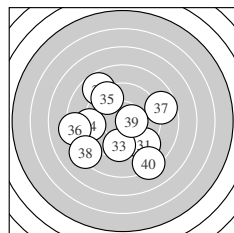

Serie 4:  
 9.2 ↘                      8.7 ↖                      9.6 ↓                      9.1 ←                      9.4 ↖  
 8.3 ←                      8.7 →                      8.3 ↙                      10.5 \*                      8.2 ↘  
 beste Teiler 125.0 (39.) 336.3 (33.) 381.3 (35.)  
 Trefferlage 0.90 mm links, 0.87 mm tief  
 Streuwert 3.72, horizontal: 4.07, vertikal: 3.33

Unterschrift des Schützen

Meyton Elektronik

Ergebnis: **381.7** (362)  
 Serien: 97.5 95.7 98.4 90.1  
 Zähler: 13 18 7 2 0 0 0 0 0 0  
 Innenzehner: 9  
 weiteste: 912 (35), 830 (19), 696 (16)  
 beste Teiler 23.6 (6.) 64.8 (12.) 93.6 (21.)  
 Trefferlage 0.20 mm links, 0.25 mm hoch  
 Streuwert 2.91, horizontal: 3.56, vertikal: 2.07

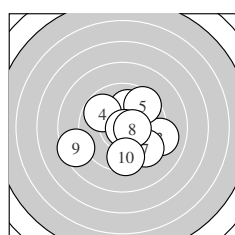
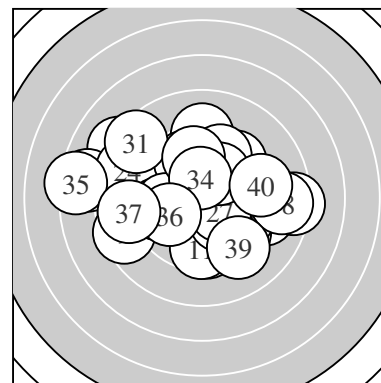

Serie 1:  
 10.0 ↑ 10.2 \* 9.1 → 9.8 ↘ 9.5 ↗  
 10.9 \* 9.5 ↘ 10.5 \* 8.5 ← 9.5 ↓  
 beste Teiler 23.6 (6.) 118.0 (8.) 180.3 (2.)  
 Trefferlage 0.51 mm rechts, 0.47 mm tief  
 Streuwert 2.48, horizontal: 2.80, vertikal: 2.12

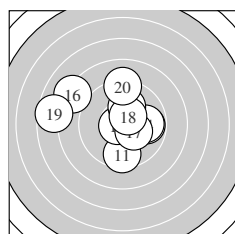

Serie 2:  
 9.5 ↓ 10.7 \* 9.8 → 9.9 → 10.1 ↑  
 8.2 ↘ 10.3 \* 10.5 \* 7.6 ← 9.1 ↑  
 beste Teiler 64.8 (12.) 115.3 (18.) 157.8 (17.)  
 Trefferlage 0.68 mm links, 0.77 mm hoch  
 Streuwert 3.02, horizontal: 3.60, vertikal: 2.30

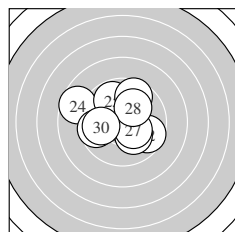

Serie 3:  
 10.6 \* 9.7 → 10.1 ↘ 8.7 ↘ 9.8 ↗  
 9.6 ↑ 10.3 \* 10.1 ↗ 9.6 ← 9.9 ←  
 beste Teiler 93.6 (21.) 157.8 (27.) 206.9 (23.)  
 Trefferlage 0.35 mm links, 0.35 mm hoch  
 Streuwert 2.23, horizontal: 2.61, vertikal: 1.78

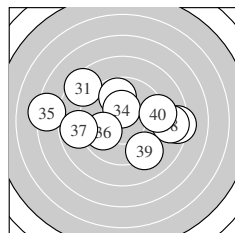

Serie 4:  
 8.5 ↘ 9.8 ↑ 8.3 → 10.4 \* 7.3 ←  
 9.9 ← 8.8 ← 8.7 → 9.2 ↘ 9.2 →  
 beste Teiler 142.5 (34.) 261.1 (36.) 296.3 (32.)  
 Trefferlage 0.29 mm links, 0.38 mm hoch  
 Streuwert 3.94, horizontal: 5.13, vertikal: 2.18

Unterschrift des Schützen

Meyton Elektronik

Ergebnis: **384.9** (367)  
 Serien: 97.9 95.9 93.9 97.2  
 Zähler: 14 21 4 0 1 0 0 0 0 0  
 Innenzehner: 8  
 weiteste: 1107 (22), 660 (16), 635 (2)  
 beste Teiler 57.4 (11.) 110.6 (24.) 112.2 (1.)  
 Trefferlage 0.30 mm links, 0.33 mm hoch  
 Streuwert 2.68, horizontal: 3.19, vertikal: 2.04

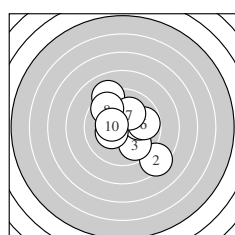
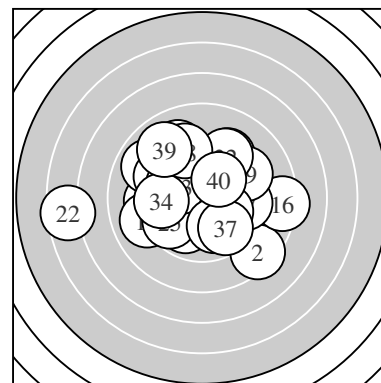

Serie 1:  
 10.5 \*                      8.4 ↘                      9.8 ↘                      9.1 ↖                      10.0 →  
 9.8 →                      10.1 ↗                      9.6 ↖                      10.3 \*                      10.3 \*  
 beste Teiler 112.2 (1.) 151.8 (10.) 165.1 (9.)  
 Trefferlage 0.63 mm rechts, 0.24 mm hoch  
 Streuwert 2.36, horizontal: 2.31, vertikal: 2.41

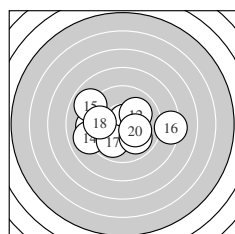

Serie 2:  
 10.7 \*                      10.0 ↗                      9.3 ←                      9.0 ←                      8.9 ↖  
 8.3 →                      9.9 ↙                      9.7 ←                      9.9 ↘                      10.2 \*  
 beste Teiler 57.4 (11.) 191.8 (20.) 226.4 (12.)  
 Trefferlage 0.53 mm links, 0.27 mm tief  
 Streuwert 2.78, horizontal: 3.63, vertikal: 1.53

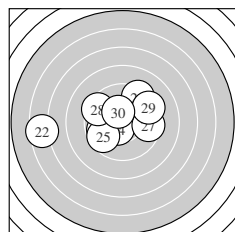

Serie 3:  
 9.8 ←                      6.5 ←                      9.7 ↗                      10.5 \*                      9.6 ↙  
 9.3 ↗                      9.5 →                      9.4 ↖                      9.3 →                      10.3 \*  
 beste Teiler 110.6 (24.) 153.2 (30.) 286.5 (21.)  
 Trefferlage 0.95 mm links, 0.51 mm hoch  
 Streuwert 3.36, horizontal: 4.38, vertikal: 1.82

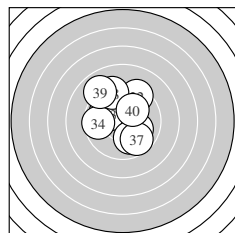

Serie 4:  
 9.9 ↖                      9.4 ↗                      10.2 \*                      9.6 ←                      10.1 ↘  
 10.0 ↘                      9.7 ↘                      9.3 ↖                      8.9 ↖                      10.1 ↗  
 beste Teiler 197.2 (33.) 204.6 (40.) 224.3 (35.)  
 Trefferlage 0.37 mm links, 0.88 mm hoch  
 Streuwert 2.30, horizontal: 2.21, vertikal: 2.40

Unterschrift des Schützen

Meyton Elektronik

Ergebnis: **400.8** (384)  
 Serien: 98.8 102.5 97.6 101.9  
 Zähler: 25 14 1 0 0 0 0 0 0 0  
 Innenzehner: 16  
 weiteste: 626 (22), 422 (25), 411 (10)  
 beste Teiler 38.9 (33.) 54.2 (18.) 59.2 (4.)  
 Trefferlage 0.00 mm , 0.77 mm tief  
 Streuwert 1.80, horizontal: 2.08, vertikal: 1.47

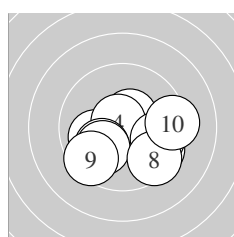
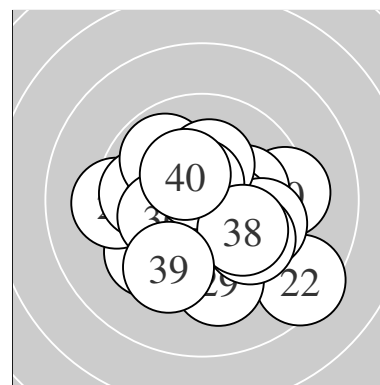

Serie 1:  
 10.0 ←                      10.5 \*                      9.6 ↘                      10.7 \*                      10.0 ↙  
 9.7 →                      10.0 ↙                      9.5 ↘                      9.5 ↙                      9.3 →  
 beste Teiler 59.2 (4.) 108.7 (2.) 229.4 (5.)  
 Trefferlage 0.45 mm rechts, 1.02 mm tief  
 Streuwert 1.97, horizontal: 2.50, vertikal: 1.25

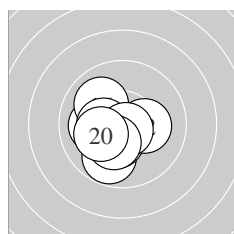

Serie 2:  
 9.8 ↓                      10.2 \*                      10.5 \*                      10.1 ←                      10.0 ↖  
 10.4 \*                      10.3 \*                      10.7 \*                      10.3 \*                      10.2 \*  
 beste Teiler 54.2 (18.) 124.8 (13.) 147.6 (16.)  
 Trefferlage 0.86 mm links, 0.62 mm tief  
 Streuwert 1.16, horizontal: 1.18, vertikal: 1.13

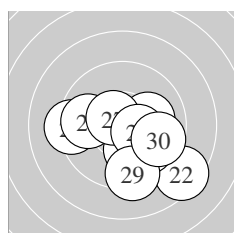

Serie 3:  
 10.1 →                      8.4 ↘                      9.9 ↘                      10.1 ↓                      9.3 ←  
 9.8 ←                      10.6 \*                      10.4 \*                      9.3 ↓                      9.7 →  
 beste Teiler 97.6 (27.) 138.9 (28.) 211.8 (24.)  
 Trefferlage 0.68 mm rechts, 1.22 mm tief  
 Streuwert 2.25, horizontal: 2.69, vertikal: 1.71

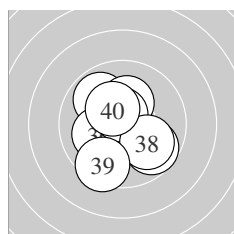

Serie 4:  
 10.7 \*                      9.9 ↖                      10.8 \*                      9.7 ↘                      10.2 \*  
 10.1 ←                      10.6 \*                      10.0 ↘                      9.5 ↙                      10.4 \*  
 beste Teiler 38.9 (33.) 73.4 (31.) 80.6 (37.)  
 Trefferlage 0.26 mm links, 0.21 mm tief  
 Streuwert 1.62, horizontal: 1.50, vertikal: 1.72

Unterschrift des Schützen

Meyton Elektronik

Ergebnis: **372.7** (356)  
 Serien: 93.2 94.0 92.6 92.9  
 Zähler: 11 19 5 5 0 0 0 0 0 0  
 Innenzehner: 6  
 weiteste: 873 (34), 853 (20), 799 (23)  
 beste Teiler 50.2 (19.) 92.3 (9.) 133.1 (17.)  
 Trefferlage 0.50 mm links, 0.75 mm hoch  
 Streuwert 3.24, horizontal: 3.36, vertikal: 3.11

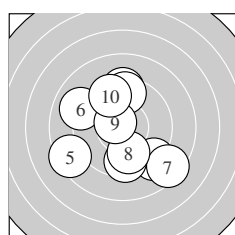
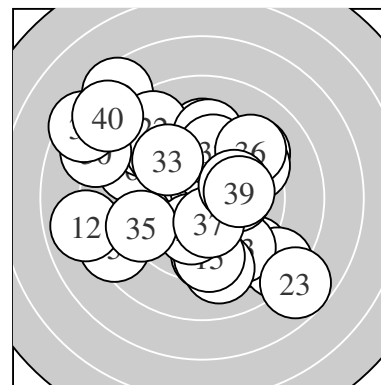

Serie 1:  
 9.3 ↑                      9.1 ↘                      9.5 ↑                      9.5 ↓                      8.4 ↙  
 9.0 ↖                      8.4 ↘                      9.9 ↓                      10.6 \*                      9.5 ↗  
 beste Teiler 92.3 (9.) 274.1 (8.) 357.2 (10.)  
 Trefferlage 0.28 mm links, 0.34 mm tief  
 Streuwert 3.23, horizontal: 3.10, vertikal: 3.35

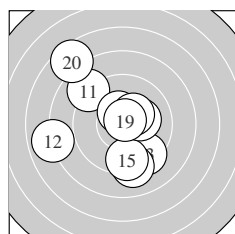

Serie 2:  
 8.9 ↘                      7.9 ←                      9.4 ↘                      9.1 ↓                      9.5 ↓  
 10.2 \*                      10.4 \*                      10.3 \*                      10.8 \*                      7.5 ↘  
 beste Teiler 50.2 (19.) 133.1 (17.) 152.1 (18.)  
 Trefferlage 0.96 mm links, 0.03 mm hoch  
 Streuwert 3.38, horizontal: 3.32, vertikal: 3.44

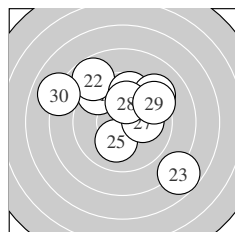

Serie 3:  
 9.4 ↘                      8.8 ↘                      7.8 ↘                      9.7 ↑                      10.1 ↓  
 9.2 ↗                      10.1 →                      10.1 ↑                      9.4 ↗                      8.0 ↖  
 beste Teiler 208.0 (25.) 211.8 (28.) 213.1 (27.)  
 Trefferlage 0.27 mm rechts, 1.32 mm hoch  
 Streuwert 3.36, horizontal: 3.71, vertikal: 2.97

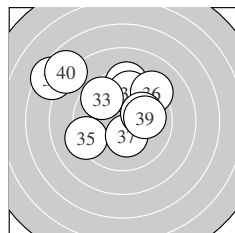

Serie 4:  
 9.3 ↑                      9.7 ↑                      9.7 ↘                      7.5 ↖                      9.3 ↙  
 9.2 ↗                      10.3 \*                      10.1 →                      10.0 →                      7.8 ↘  
 beste Teiler 159.8 (37.) 218.1 (38.) 238.3 (39.)  
 Trefferlage 1.05 mm links, 2.00 mm hoch  
 Streuwert 3.11, horizontal: 3.65, vertikal: 2.44

Unterschrift des Schützen

Meyton Elektronik

Ergebnis: **400.0** (383)  
 Serien: 100.0 100.1 99.5 100.4  
 Zähler: 26 12 1 1 0 0 0 0 0 0  
 Innenzehner: 19  
 weiteste: 772 (21), 597 (8), 469 (40)  
 beste Teiler 42.4 (6.) 58.6 (34.) 70.8 (2.)  
 Trefferlage 0.71 mm links, 0.15 mm tief  
 Streuwert 1.95, horizontal: 2.46, vertikal: 1.23

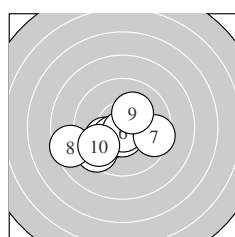
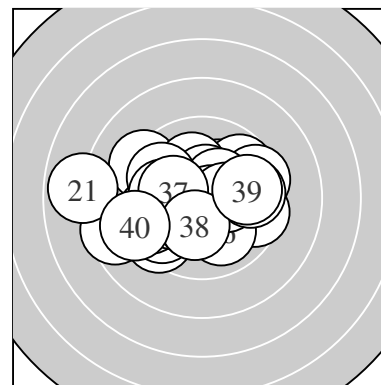

Serie 1:  
 10.1 ↙ 10.7 \* 10.4 \* 9.4 ↘ 10.6 \*  
 10.8 \* 9.5 → 8.6 ↙ 10.2 \* 9.7 ↘  
 beste Teiler 42.4 (6.) 70.8 (2.) 95.0 (5.)  
 Trefferlage 0.86 mm links, 0.96 mm tief  
 Streuwert 1.95, horizontal: 2.50, vertikal: 1.16

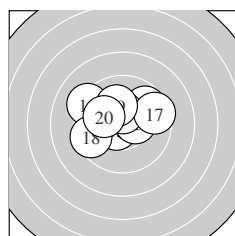

Serie 2:  
 9.2 ↘ 9.7 ↗ 10.6 \* 10.5 \* 10.4 \*  
 10.5 \* 9.5 → 9.5 ↙ 10.1 ↑ 10.1 ↘  
 beste Teiler 86.5 (13.) 121.0 (16.) 123.7 (14.)  
 Trefferlage 0.20 mm links, 0.76 mm hoch  
 Streuwert 1.87, horizontal: 2.39, vertikal: 1.15

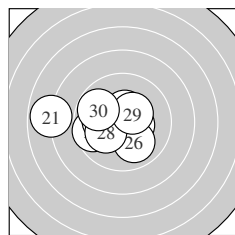

Serie 3:  
 7.9 ← 10.6 \* 10.5 \* 9.6 ↙ 10.5 \*  
 10.0 ↘ 10.1 ← 10.1 ↙ 10.4 \* 9.8 ↘  
 beste Teiler 99.5 (22.) 121.2 (25.) 123.9 (23.)  
 Trefferlage 1.46 mm links, 0.03 mm tief  
 Streuwert 2.09, horizontal: 2.74, vertikal: 1.11

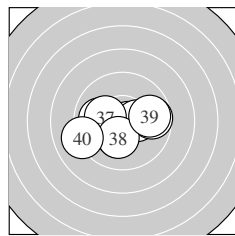

Serie 4:  
 10.2 \* 10.0 ← 10.2 \* 10.7 \* 10.3 \*  
 9.7 → 10.2 \* 10.2 \* 9.8 → 9.1 ↙  
 beste Teiler 58.6 (34.) 152.0 (35.) 178.7 (31.)  
 Trefferlage 0.33 mm links, 0.39 mm tief  
 Streuwert 1.83, horizontal: 2.40, vertikal: 0.96

Unterschrift des Schützen

Meyton Elektronik

Ergebnis: **399.6** (384)  
 Serien: 99.5 100.3 99.6 100.2  
 Zähler: 25 14 1 0 0 0 0 0 0 0  
 Innenzehner: 21  
 weiteste: 604 (1), 492 (16), 468 (35)  
 beste Teiler 38.9 (40.) 50.4 (39.) 74.7 (17.)  
 Trefferlage 0.15 mm links, 0.72 mm hoch  
 Streuwert 1.92, horizontal: 2.17, vertikal: 1.64

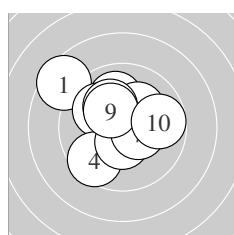
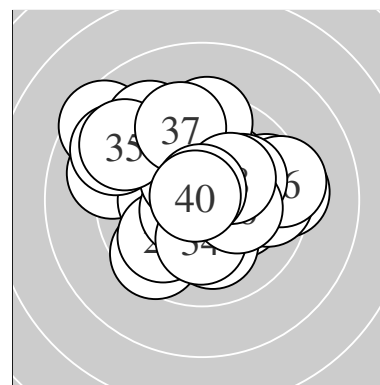

Serie 1:  
 8.5 ↘ 10.0 ↑ 10.0 ↘ 9.6 ↙ 10.2 \*  
 10.5 \* 10.4 \* 10.2 \* 10.3 \* 9.8 →  
 beste Teiler 122.0 (6.) 133.4 (7.) 167.8 (9.)  
 Trefferlage 0.61 mm links, 0.81 mm hoch  
 Streuwert 2.00, horizontal: 2.17, vertikal: 1.82

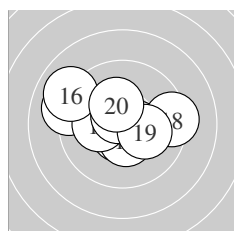

Serie 2:  
 10.5 \* 9.1 ← 10.6 \* 10.4 \* 10.2 \*  
 9.0 ↘ 10.7 \* 9.3 → 10.2 \* 10.3 \*  
 beste Teiler 74.7 (17.) 91.7 (13.) 118.4 (11.)  
 Trefferlage 0.45 mm links, 0.33 mm hoch  
 Streuwert 2.02, horizontal: 2.60, vertikal: 1.19

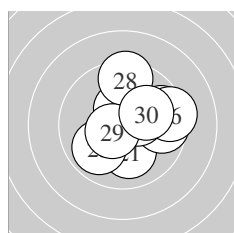

Serie 3:  
 10.1 ↓ 9.6 → 9.9 ↙ 9.7 → 10.4 \*  
 9.4 → 10.4 \* 9.4 ↑ 10.6 \* 10.1 →  
 beste Teiler 97.7 (29.) 131.8 (25.) 133.5 (27.)  
 Trefferlage 1.13 mm rechts, 0.40 mm hoch  
 Streuwert 1.81, horizontal: 1.91, vertikal: 1.70

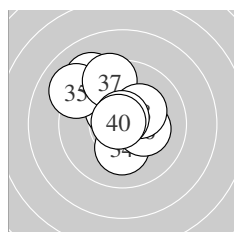

Serie 4:  
 9.7 ↖ 9.2 ↖ 10.4 \* 10.2 \* 9.1 ↘  
 10.2 \* 9.5 ↑ 10.3 \* 10.8 \* 10.8 \*  
 beste Teiler 38.9 (40.) 50.4 (39.) 142.4 (33.)  
 Trefferlage 0.69 mm links, 1.33 mm hoch  
 Streuwert 1.75, horizontal: 1.66, vertikal: 1.83

Unterschrift des Schützen

Meyton Elektronik

Ergebnis: **397.5** (384)  
 Serien: 99.7 99.1 101.1 97.6  
 Zähler: 24 16 0 0 0 0 0 0 0 0  
 Innenzehner: 13  
 weiteste: 455 (37), 454 (3), 428 (39)  
 beste Teiler 81.5 (22.) 95.1 (10.) 109.1 (23.)  
 Trefferlage 0.16 mm links, 0.40 mm hoch  
 Streuwert 1.93, horizontal: 2.04, vertikal: 1.82

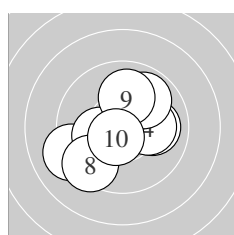
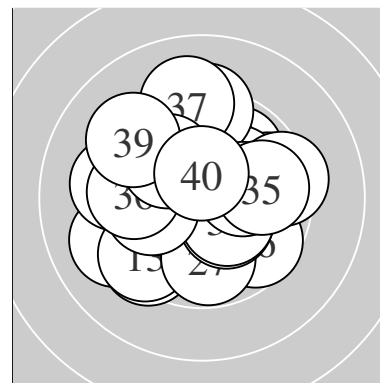

Serie 1:  
 10.0 ↗ 10.0 → 9.1 ↙ 10.1 → 10.4 \*  
 10.2 \* 9.9 ↗ 9.4 ↙ 10.0 ↑ 10.6 \*  
 beste Teiler 95.1 (10.) 126.2 (5.) 190.7 (6.)  
 Trefferlage 0.25 mm links, 0.04 mm tief  
 Streuwert 1.96, horizontal: 2.13, vertikal: 1.76

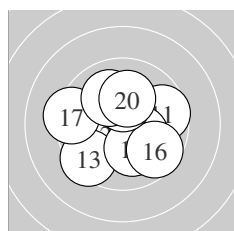

Serie 2:  
 9.7 → 10.2 \* 9.4 ↙ 10.3 \* 10.1 ↓  
 9.7 ↘ 9.3 ← 10.3 \* 10.0 ↘ 10.1 ↑  
 beste Teiler 158.1 (14.) 164.0 (18.) 197.0 (12.)  
 Trefferlage 0.14 mm links, 0.08 mm tief  
 Streuwert 2.04, horizontal: 2.28, vertikal: 1.77

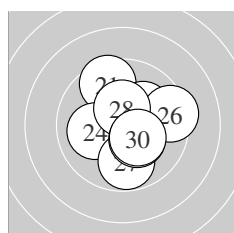

Serie 3:  
 9.6 ↖ 10.6 \* 10.5 \* 10.1 ← 10.1 ↗  
 9.4 → 9.8 ↓ 10.4 \* 10.3 \* 10.3 \*  
 beste Teiler 81.5 (22.) 109.1 (23.) 133.0 (28.)  
 Trefferlage 0.59 mm rechts, 0.09 mm hoch  
 Streuwert 1.66, horizontal: 1.61, vertikal: 1.71

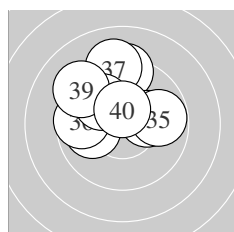

Serie 4:  
 10.0 ← 9.3 ↑ 10.2 \* 9.8 ↘ 9.8 →  
 9.7 ← 9.1 ↑ 10.0 ↘ 9.2 ↘ 10.5 \*  
 beste Teiler 117.0 (40.) 198.4 (33.) 239.8 (38.)  
 Trefferlage 0.86 mm links, 1.66 mm hoch  
 Streuwert 1.90, horizontal: 2.11, vertikal: 1.67

Unterschrift des Schützen

Meyton Elektronik



Ergebnis: **405.9** (388)  
 Serien: 102.1 101.2 102.6 100.0  
 Zähler: 28 12 0 0 0 0 0 0 0 0  
 Innenzehner: 22  
 weiteste: 453 (17), 382 (32), 326 (38)  
 beste Teiler 30.8 (13.) 42.7 (21.) 69.3 (23.)  
 Trefferlage 0.20 mm rechts, 0.16 mm hoch  
 Streuwert 1.57, horizontal: 1.62, vertikal: 1.53

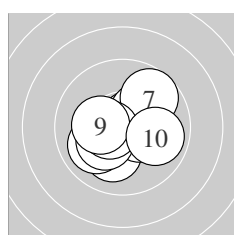
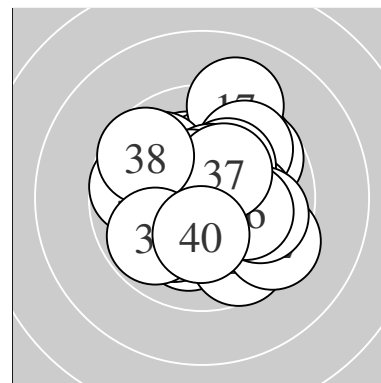

Serie 1:  
 10.6 \*                      10.1 ↘                      10.3 \*                      10.4 \*                      10.0 ↙  
 10.3 \*                      9.7 ↗                      10.5 \*                      10.3 \*                      9.9 →  
 beste Teiler 82.7 (1.) 101.4 (8.) 137.8 (4.)  
 Trefferlage 0.09 mm rechts, 0.16 mm tief  
 Streuwert 1.47, horizontal: 1.65, vertikal: 1.26

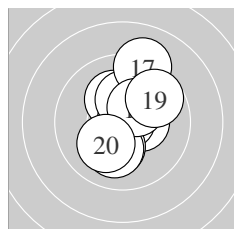

Serie 2:  
 10.2 \*                      10.4 \*                      10.8 \*                      10.3 \*                      10.2 \*  
 10.1 ↘                      9.1 ↑                      10.3 \*                      9.7 ↗                      10.1 ↙  
 beste Teiler 30.8 (13.) 138.0 (12.) 153.5 (18.)  
 Trefferlage 0.37 mm rechts, 0.52 mm hoch  
 Streuwert 1.66, horizontal: 1.20, vertikal: 2.02

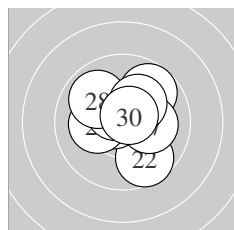

Serie 3:  
 10.8 \*                      9.7 ↘                      10.7 \*                      9.8 ↗                      10.2 \*  
 10.5 \*                      10.1 →                      9.9 ↖                      10.2 \*                      10.7 \*  
 beste Teiler 42.7 (21.) 69.3 (23.) 72.8 (30.)  
 Trefferlage 0.27 mm rechts, 0.40 mm hoch  
 Streuwert 1.45, horizontal: 1.50, vertikal: 1.39

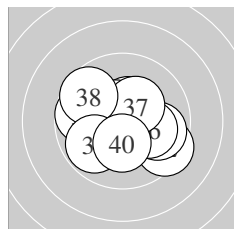

Serie 4:  
 10.5 \*                      9.4 ↘                      9.7 ←                      9.8 →                      10.5 \*  
 10.1 →                      10.3 \*                      9.6 ↖                      9.8 ↙                      10.3 \*  
 beste Teiler 106.5 (35.) 125.8 (31.) 157.6 (37.)  
 Trefferlage 0.10 mm rechts, 0.11 mm tief  
 Streuwert 1.86, horizontal: 2.21, vertikal: 1.44

Unterschrift des Schützen

Meyton Elektronik

Ergebnis: **396.9** (377)  
 Serien: 100.8 99.3 97.2 99.6  
 Zähler: 19 19 2 0 0 0 0 0 0 0  
 Innenzehner: 17  
 weiteste: 624 (32), 504 (30), 497 (6)  
 beste Teiler 19.6 (3.) 32.5 (36.) 36.0 (33.)  
 Trefferlage 0.61 mm rechts, 0.21 mm tief  
 Streuwert 2.07, horizontal: 2.42, vertikal: 1.65

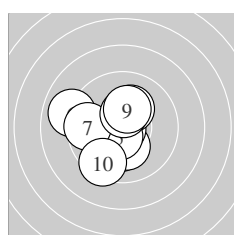
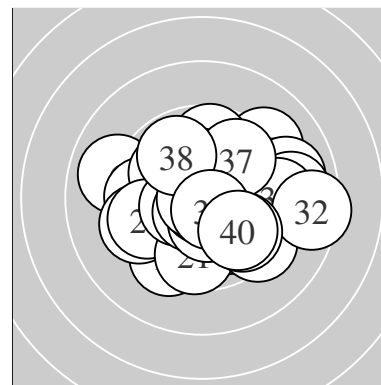

Serie 1:  
 10.2 \*                      10.2 \*                      10.9 \*                      10.2 \*                      10.6 \*  
 9.0 ↖                      9.6 ←                      10.4 \*                      10.3 \*                      9.4 ↘  
 beste Teiler 19.6 (3.) 92.4 (5.) 126.4 (8.)  
 Trefferlage 0.89 mm links, 0.20 mm tief  
 Streuwert 1.80, horizontal: 1.84, vertikal: 1.75

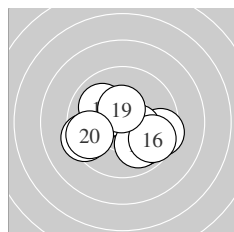

Serie 2:  
 9.9 ↘                      9.5 →                      10.4 \*                      10.4 \*                      9.9 ↘  
 9.7 ↘                      9.4 ←                      10.0 ↖                      10.5 \*                      9.6 ←  
 beste Teiler 124.4 (19.) 144.9 (14.) 147.4 (13.)  
 Trefferlage 0.12 mm rechts, 0.61 mm tief  
 Streuwert 1.99, horizontal: 2.48, vertikal: 1.32

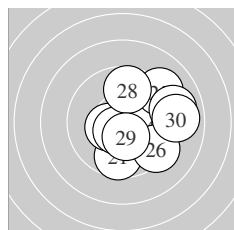

Serie 3:  
 9.7 ↓                      10.4 \*                      10.6 \*                      10.1 →                      9.1 ↗  
 9.3 ↘                      9.0 →                      9.7 ↑                      10.4 \*                      8.9 →  
 beste Teiler 97.6 (23.) 140.4 (22.) 141.4 (29.)  
 Trefferlage 1.69 mm rechts, 0.12 mm tief  
 Streuwert 2.20, horizontal: 2.31, vertikal: 2.08

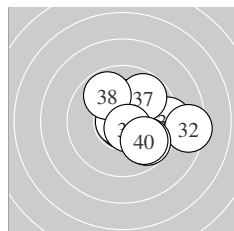

Serie 4:  
 9.3 →                      8.5 →                      10.8 \*                      9.8 ↘                      10.3 \*  
 10.8 \*                      9.8 ↗                      9.8 ↘                      10.6 \*                      9.9 ↘  
 beste Teiler 32.5 (36.) 36.0 (33.) 83.0 (39.)  
 Trefferlage 1.52 mm rechts, 0.08 mm hoch  
 Streuwert 1.98, horizontal: 2.33, vertikal: 1.56

Unterschrift des Schützen

Meyton Elektronik

Ergebnis: **409.0** (391)  
 Serien: 100.5 101.4 103.3 103.8  
 Zähler: 31 9 0 0 0 0 0 0 0 0  
 Innenzehner: 25  
 weiteste: 448 (3), 412 (14), 376 (16)  
 beste Teiler 17.0 (22.) 36.2 (32.) 44.6 (17.)  
 Trefferlage 0.19 mm rechts, 0.47 mm hoch  
 Streuwert 1.50, horizontal: 1.88, vertikal: 0.98

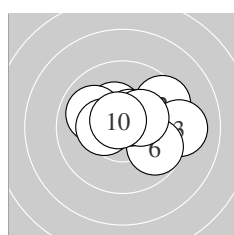
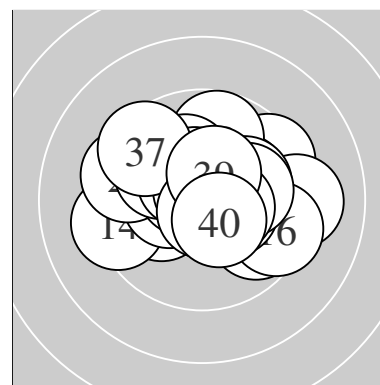

Serie 1:  
 9.6 → 9.5 ↗ 9.2 → 10.4 \* 10.0 ↘  
 9.8 ↘ 10.4 \* 10.6 \* 10.3 \* 10.7 \*  
 beste Teiler 64.8 (10.) 96.0 (8.) 146.0 (7.)  
 Trefferlage 1.08 mm rechts, 0.50 mm hoch  
 Streuwert 1.73, horizontal: 2.27, vertikal: 0.92

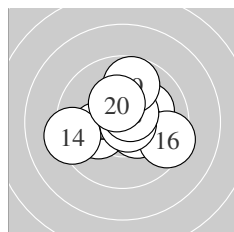

Serie 2:  
 10.7 \* 10.1 ← 10.1 ↗ 9.3 ← 10.4 \*  
 9.4 ↘ 10.8 \* 10.6 \* 9.7 ↑ 10.3 \*  
 beste Teiler 44.6 (17.) 66.6 (11.) 93.6 (18.)  
 Trefferlage 0.18 mm rechts, 0.28 mm hoch  
 Streuwert 1.72, horizontal: 2.04, vertikal: 1.32

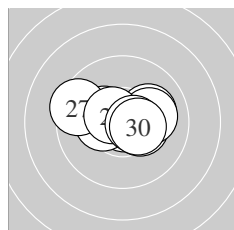

Serie 3:  
 10.3 \* 10.9 \* 10.4 \* 10.1 → 10.3 \*  
 10.1 → 9.5 ← 10.6 \* 10.6 \* 10.5 \*  
 beste Teiler 17.0 (22.) 86.9 (29.) 98.1 (28.)  
 Trefferlage 0.03 mm rechts, 0.25 mm hoch  
 Streuwert 1.35, horizontal: 1.83, vertikal: 0.54

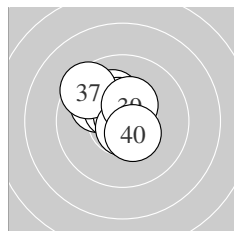

Serie 4:  
 10.2 \* 10.8 \* 10.0 ↘ 10.5 \* 10.4 \*  
 10.8 \* 9.5 ↘ 10.7 \* 10.4 \* 10.5 \*  
 beste Teiler 36.2 (32.) 49.6 (36.) 54.9 (38.)  
 Trefferlage 0.52 mm links, 0.83 mm hoch  
 Streuwert 1.06, horizontal: 1.09, vertikal: 1.03

Unterschrift des Schützen

Meyton Elektronik

Ergebnis: **393.6** (377)  
 Serien: 97.0 97.6 101.0 98.0  
 Zähler: 23 11 6 0 0 0 0 0 0 0  
 Innenzehner: 15  
 weiteste: 749 (10), 609 (32), 597 (13)  
 beste Teiler 72.8 (28.) 89.8 (8.) 93.7 (26.)  
 Trefferlage 0.81 mm rechts, 0.15 mm tief  
 Streuwert 2.24, horizontal: 2.59, vertikal: 1.82

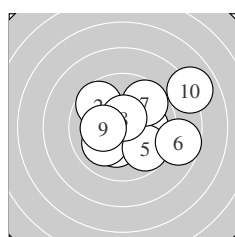
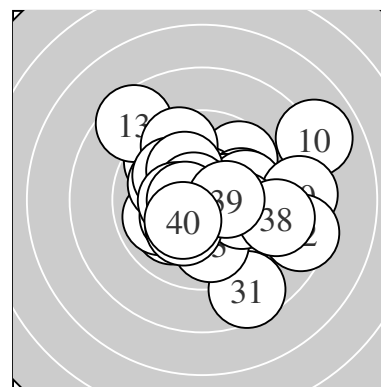

Serie 1:  
 10.1 → 9.7 ↘ 10.2 \* 10.0 ↙ 9.8 ↘  
 8.7 → 9.7 ↗ 10.6 \* 10.2 \* 8.0 →  
 beste Teiler 89.8 (8.) 177.5 (3.) 189.2 (9.)  
 Trefferlage 1.21 mm rechts, 0.23 mm hoch  
 Streuwert 2.58, horizontal: 3.07, vertikal: 1.98

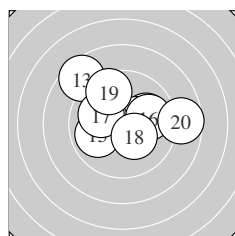

Serie 2:  
 10.0 → 10.4 \* 8.6 ↘ 10.2 \* 9.9 ↙  
 9.9 → 10.0 ↖ 10.3 \* 9.6 ↗ 8.7 →  
 beste Teiler 141.0 (12.) 164.1 (18.) 179.7 (14.)  
 Trefferlage 0.14 mm rechts, 0.90 mm hoch  
 Streuwert 2.41, horizontal: 2.94, vertikal: 1.72

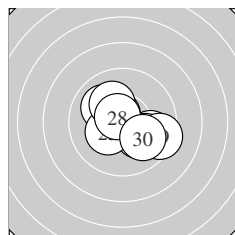

Serie 3:  
 10.2 \* 10.0 ↖ 9.8 ↘ 9.9 ↘ 10.3 \*  
 10.6 \* 10.1 ↖ 10.7 \* 9.4 ↘ 10.0 ↘  
 beste Teiler 72.8 (28.) 93.7 (26.) 170.0 (25.)  
 Trefferlage 0.67 mm rechts, 0.32 mm tief  
 Streuwert 1.65, horizontal: 1.94, vertikal: 1.29

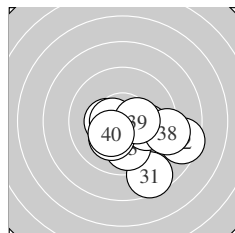

Serie 4:  
 8.6 ↘ 8.5 → 9.9 ↓ 10.3 \* 10.0 →  
 10.6 \* 10.2 \* 9.2 → 10.4 \* 10.3 \*  
 beste Teiler 99.0 (36.) 141.0 (39.) 151.0 (34.)  
 Trefferlage 1.23 mm rechts, 1.41 mm tief  
 Streuwert 2.11, horizontal: 2.53, vertikal: 1.60

Unterschrift des Schützen

Meyton Elektronik

Ergebnis: **394.7** (376)  
 Serien: 102.1 95.9 96.4 100.3  
 Zähler: 21 14 5 0 0 0 0 0 0 0  
 Innenzehner: 17  
 weiteste: 665 (13), 602 (12), 587 (21)  
 beste Teiler 48.1 (3.) 54.9 (4.) 60.2 (36.)  
 Trefferlage 0.24 mm rechts, 0.56 mm tief  
 Streuwert 2.26, horizontal: 2.70, vertikal: 1.71

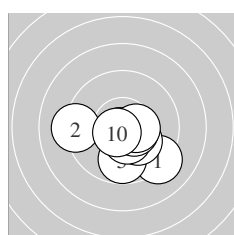
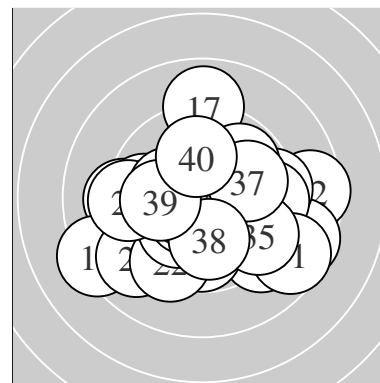

Serie 1:  
 9.2 ↘ 9.2 ← 10.8 \* 10.7 \* 9.8 ↓  
 10.2 \* 10.5 \* 10.5 \* 10.5 \* 10.7 \*  
 beste Teiler 48.1 (3.) 54.9 (4.) 72.1 (10.)  
 Trefferlage 0.20 mm rechts, 1.04 mm tief  
 Streuwert 1.59, horizontal: 1.96, vertikal: 1.10

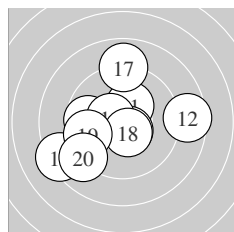

Serie 2:  
 10.3 \* 8.5 → 8.3 ↙ 9.7 ← 10.6 \*  
 10.5 \* 8.9 ↑ 10.5 \* 9.6 ← 9.0 ↙  
 beste Teiler 95.8 (15.) 107.7 (18.) 118.3 (16.)  
 Trefferlage 0.92 mm links, 0.17 mm tief  
 Streuwert 2.88, horizontal: 3.30, vertikal: 2.40

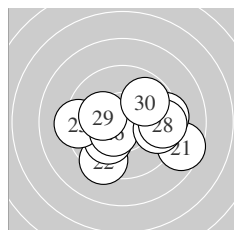

Serie 3:  
 8.6 ↘ 9.4 ↙ 10.1 ↙ 9.4 → 9.3 ←  
 10.5 \* 9.6 → 9.5 → 10.2 \* 9.8 ↗  
 beste Teiler 123.1 (26.) 191.6 (29.) 211.1 (23.)  
 Trefferlage 0.84 mm rechts, 0.62 mm tief  
 Streuwert 2.51, horizontal: 3.19, vertikal: 1.55

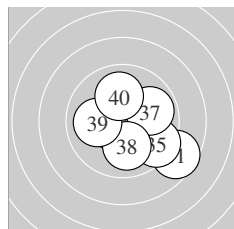

Serie 4:  
 8.6 ↘ 10.6 \* 10.6 \* 10.4 \* 9.5 ↘  
 10.7 \* 9.9 → 10.0 ↓ 10.0 ← 10.0 ↑  
 beste Teiler 60.2 (36.) 78.8 (33.) 97.1 (32.)  
 Trefferlage 0.84 mm rechts, 0.42 mm tief  
 Streuwert 1.92, horizontal: 2.11, vertikal: 1.71

Unterschrift des Schützen

Meyton Elektronik

Ergebnis:	<b>400.5</b>	(382)
Serien:	97.8	98.5 101.6 102.6
Zähler:	25	12 3 0 0 0 0 0 0 0
Innenzehner:	18	
weiteste:	613 (11),	558 (18), 534 (5)
beste Teiler	5.0 (37.)	27.5 (17.) 49.9 (31.)
Trefferlage	0.30 mm links, 0.74 mm hoch	
Streuwert	1.89, horizontal: 2.07, vertikal: 1.70	

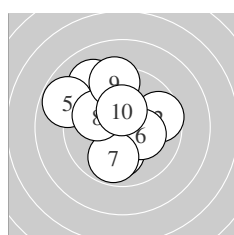
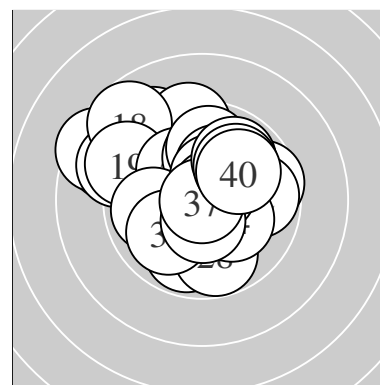

Serie 1:	9.1 ↘	9.6 →	10.1 ↓	10.4 *	8.8 ↙
	10.3 *	9.8 ↓	10.0 ↖	9.3 ↑	10.4 *
beste Teiler	135.5 (4.) 149.2 (10.) 172.5 (6.)				
Trefferlage	0.71 mm links, 0.92 mm hoch				
Streuwert	2.22, horizontal: 2.22, vertikal: 2.22				

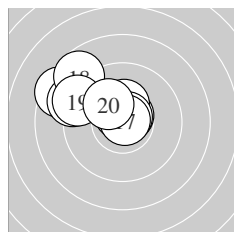

Serie 2:	8.5 ↖	10.6 *	10.6 *	10.3 *	10.7 *
	9.0 ↖	10.8 *	8.7 ↘	9.2 ↖	10.1 ↘
beste Teiler	27.5 (17.) 58.8 (15.) 76.5 (13.)				
Trefferlage	1.80 mm links, 1.55 mm hoch				
Streuwert	1.86, horizontal: 2.36, vertikal: 1.17				

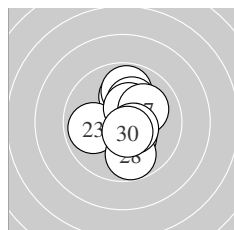

Serie 3:	10.0 ↑	10.3 *	9.9 ←	9.8 ↑	10.2 *
	10.4 *	10.1 ↗	9.8 ↓	10.5 *	10.6 *
beste Teiler	95.2 (30.) 109.0 (29.) 135.6 (26.)				
Trefferlage	0.39 mm rechts, 0.30 mm hoch				
Streuwert	1.50, horizontal: 1.14, vertikal: 1.79				

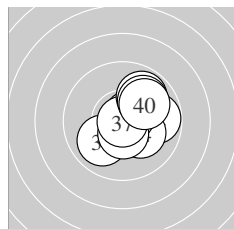

Serie 4:	10.8 *	9.8 →	10.0 ↙	10.2 *	10.6 *
	10.5 *	10.9 *	9.9 ↗	9.9 ↗	10.0 ↗
beste Teiler	5.0 (37.) 49.9 (31.) 78.6 (35.)				
Trefferlage	0.92 mm rechts, 0.20 mm hoch				
Streuwert	1.32, horizontal: 1.33, vertikal: 1.30				

Unterschrift des Schützen

Ergebnis: **362.4** (341)  
 Serien: 86.0 91.8 92.2 92.4  
 Zähler: 8 15 10 4 3 0 0 0 0 0  
 Innenzehner: 7  
 weiteste: 1093 (13), 1055 (24), 1049 (2)  
 beste Teiler 103.6 (12.) 108.0 (25.) 127.0 (6.)  
 Trefferlage 1.99 mm links, 0.66 mm tief  
 Streuwert 3.63, horizontal: 4.26, vertikal: 2.86

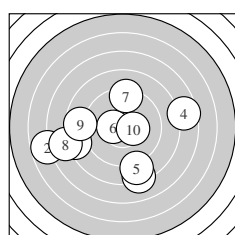
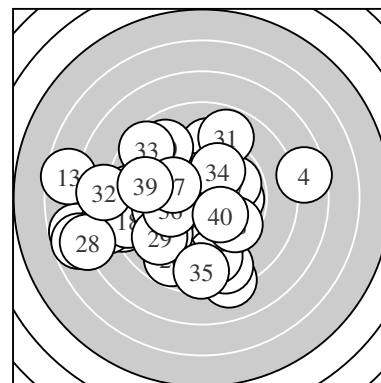

Serie 1:  
 8.3 ←                      6.8 ←                      8.2 ↓                      7.6 →                      8.6 ↓  
 10.4 \*                      9.3 ↑                      7.7 ←                      8.7 ←                      10.4 \*  
 beste Teiler 127.0 (6.) 142.5 (10.) 423.5 (7.)  
 Trefferlage 1.70 mm links, 1.28 mm tief  
 Streuwert 4.61, horizontal: 5.65, vertikal: 3.26

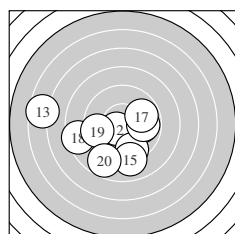

Serie 2:  
 9.9 →                      10.5 \*                      6.6 ←                      9.5 ↓                      9.0 ↓  
 9.8 →                      9.8 →                      8.4 ←                      9.5 ←                      8.8 ↓  
 beste Teiler 103.6 (12.) 252.1 (11.) 278.1 (16.)  
 Trefferlage 1.34 mm links, 1.38 mm tief  
 Streuwert 3.53, horizontal: 4.43, vertikal: 2.30

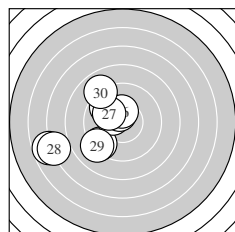

Serie 3:  
 9.3 ↙                      9.8 ↘                      10.4 \*                      6.7 ←                      10.5 \*  
 10.4 \*                      10.1 ↘                      7.0 ←                      9.1 ↙                      8.9 ↘  
 beste Teiler 108.0 (25.) 138.5 (23.) 143.5 (26.)  
 Trefferlage 3.45 mm links, 0.30 mm tief  
 Streuwert 3.11, horizontal: 3.43, vertikal: 2.75

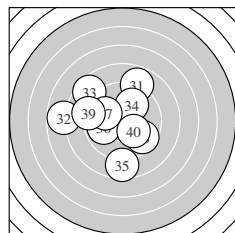

Serie 4:  
 8.8 ↑                      7.8 ←                      8.6 ↘                      9.9 ↑                      8.6 ↓  
 9.9 ←                      9.9 ↘                      9.6 ↘                      9.1 ←                      10.2 \*  
 beste Teiler 200.3 (40.) 252.1 (34.) 255.1 (37.)  
 Trefferlage 1.46 mm links, 0.32 mm hoch  
 Streuwert 3.31, horizontal: 3.49, vertikal: 3.12

Unterschrift des Schützen

Meyton Elektronik

Ergebnis: **364.4** (347)  
 Serien: 91.2 93.9 86.5 92.8  
 Zähler: 9 14 13 3 1 0 0 0 0 0  
 Innenzehner: 7  
 weiteste: 1093 (5), 895 (21), 869 (29)  
 beste Teiler 66.4 (18.) 98.5 (19.) 124.9 (4.)  
 Trefferlage 1.65 mm links, 1.30 mm hoch  
 Streuwert 3.41, horizontal: 4.00, vertikal: 2.68

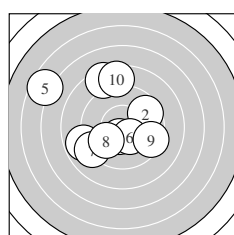
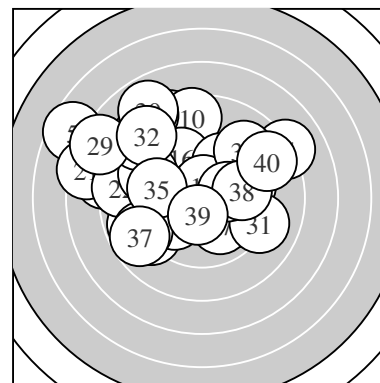

Serie 1:  
 8.8 ↙ 9.6 ↗ 8.4 ↖ 10.5 \* 6.6 ↘  
 10.4 \* 9.1 ↙ 9.9 ↙ 9.4 → 8.5 ↑  
 beste Teiler 124.9 (4.) 149.6 (6.) 264.5 (8.)  
 Trefferlage 1.67 mm links, 0.82 mm hoch  
 Streuwert 3.72, horizontal: 3.92, vertikal: 3.52

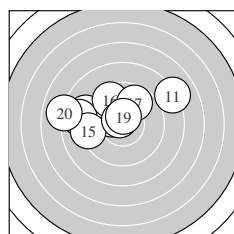

Serie 2:  
 8.1 ↗ 9.0 ↖ 10.3 \* 8.7 ↖ 9.2 ←  
 9.6 ↘ 9.7 ↗ 10.7 \* 10.6 \* 8.0 ←  
 beste Teiler 66.4 (18.) 98.5 (19.) 151.2 (13.)  
 Trefferlage 1.72 mm links, 1.43 mm hoch  
 Streuwert 2.95, horizontal: 3.95, vertikal: 1.34

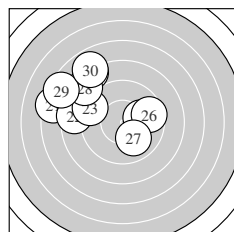

Serie 3:  
 7.4 ↖ 8.5 ↖ 9.2 ↖ 10.0 → 8.0 ↘  
 9.6 → 10.0 ↘ 8.4 ↘ 7.5 ↖ 7.9 ↘  
 beste Teiler 235.5 (24.) 241.0 (27.) 346.0 (26.)  
 Trefferlage 3.24 mm links, 2.54 mm hoch  
 Streuwert 3.52, horizontal: 4.18, vertikal: 2.71

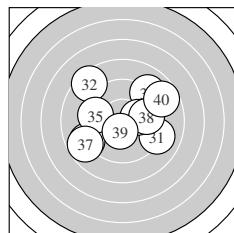

Serie 4:  
 9.1 ↘ 8.4 ↘ 9.1 ↗ 8.9 ↙ 9.6 ←  
 10.2 \* 8.7 ↙ 9.7 → 10.4 \* 8.7 →  
 beste Teiler 131.9 (39.) 196.6 (36.) 306.3 (38.)  
 Trefferlage 0.02 mm rechts, 0.42 mm hoch  
 Streuwert 3.32, horizontal: 3.89, vertikal: 2.61

Unterschrift des Schützen

Meyton Elektronik