

Ergebnis: **383** (402.4)  
 Serien: 94 96 97 96  
 Zähler: 24 15 1 0 0 0 0 0 0 0  
 Innenzehner: 21  
 Weitester: 659 (31.), 463 (37.), 432 (12.)  
 beste Teiler: 4.1 (21.), 13.3 (38.), 23.4 (4.)  
 Trefferlage: 0.57 mm rechts, 0.54 mm tief  
 Streuwert: 1.82, horizontal: 2.01, vertikal: 1.61

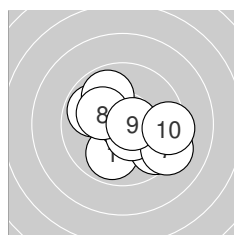

**Serie 1:**  
 9.9 ↙ 9.9 ↖ 9.6 ↘ 10.9 \* 9.9 ↖  
 10.5 \* 9.2 ↘ 10.2 \* 10.6 \* 9.4 →  
 beste Teiler: 23.4 (4.), 84.0 (9.), 115.4 (6.)  
 Trefferlage: 0.58 mm rechts, 0.30 mm tief  
 Streuwert: 1.96, horizontal: 2.28, vertikal: 1.58

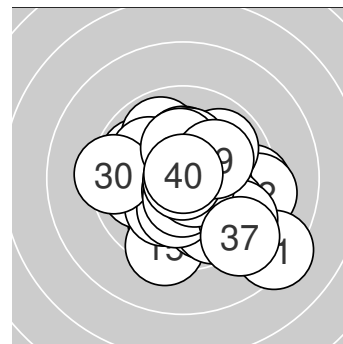
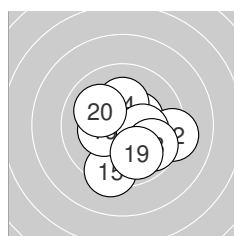

**Serie 2:**  
 10.4 \* 9.2 → 10.6 \* 10.2 \* 9.4 ↓  
 10.3 \* 10.2 \* 9.8 ↘ 9.9 ↘ 10.0 ↖  
 beste Teiler: 90.1 (13.), 137.2 (11.), 165.1 (16.)  
 Trefferlage: 0.57 mm rechts, 0.52 mm tief  
 Streuwert: 1.85, horizontal: 1.95, vertikal: 1.75

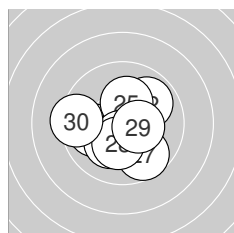

**Serie 3:**  
 10.9 \* 9.9 ↗ 10.0 ← 10.2 \* 10.2 \*  
 10.5 \* 9.7 ↘ 10.3 \* 10.4 \* 9.4 ←  
 beste Teiler: 4.1 (21.), 116.9 (26.), 137.3 (29.)  
 Trefferlage: 0.24 mm links, 0.43 mm tief  
 Streuwert: 1.66, horizontal: 1.86, vertikal: 1.43

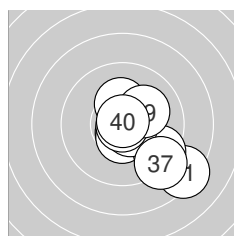

**Serie 4:**  
 8.3 ↘ 10.7 \* 10.3 \* 10.5 \* 9.4 ↘  
 10.6 \* 9.1 ↘ 10.9 \* 10.1 ↗ 10.9 \*  
 beste Teiler: 13.3 (38.), 25.0 (40.), 71.5 (32.)  
 Trefferlage: 1.37 mm rechts, 0.91 mm tief  
 Streuwert: 1.87, horizontal: 1.89, vertikal: 1.85



Ergebnis: **359** (377.1)  
 Serien: 89 92 89 89  
 Zähler: 11 20 6 3 0 0 0 0 0 0  
 Innenzehner: 7  
 Weitester: 826 (5.), 777 (25.), 759 (37.)  
 beste Teiler: 59.9 (38.), 69.1 (33.), 88.1 (20.)  
 Trefferlage: 0.37 mm rechts, 0.10 mm hoch  
 Streuwert: 3.04, horizontal: 3.46, vertikal: 2.56

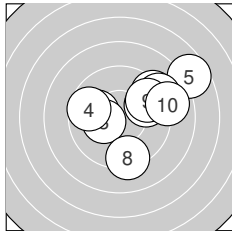
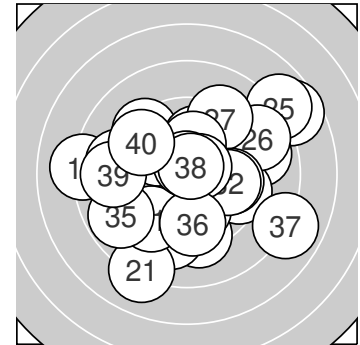

**Serie 1:**

9.8 ↗	10.0 ←	10.3 *	9.7 ←	7.6 ↗
9.3 ↗	9.1 ↗	9.3 ↓	9.6 ↗	8.9 →

beste Teiler: 166.9 (3.), 236.4 (2.), 298.4 (1.)  
 Trefferlage: 1.87 mm rechts, 1.01 mm hoch  
 Streuwert: 2.84, horizontal: 3.35, vertikal: 2.21

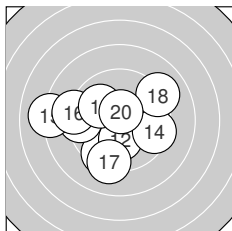

**Serie 2:**

9.4 ↘	10.2 *	9.3 ←	9.5 →	8.1 ←
9.1 ←	9.2 ↓	9.1 ↗	10.0 ↖	10.6 *

beste Teiler: 88.1 (20.), 192.2 (12.), 244.0 (19.)  
 Trefferlage: 1.28 mm links, 0.45 mm tief  
 Streuwert: 2.90, horizontal: 3.47, vertikal: 2.19

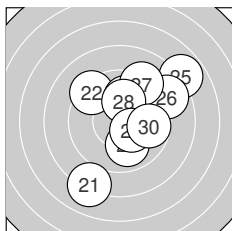

**Serie 3:**

8.1 ↘	9.3 ↖	10.0 ↑	9.9 ↓	7.8 ↗
8.8 ↗	9.2 ↗	10.1 ↑	10.3 *	9.7 →

beste Teiler: 154.2 (29.), 208.2 (28.), 250.5 (23.)  
 Trefferlage: 1.34 mm rechts, 0.79 mm hoch  
 Streuwert: 3.18, horizontal: 2.97, vertikal: 3.39

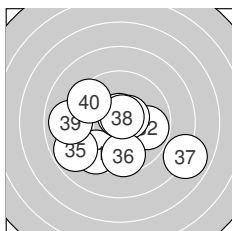

**Serie 4:**

9.4 ↘	9.8 →	10.7 *	10.6 *	8.8 ↖
9.6 ↓	7.9 →	10.7 *	8.9 ←	9.4 ↖

beste Teiler: 59.9 (38.), 69.1 (33.), 95.7 (34.)  
 Trefferlage: 0.41 mm links, 0.94 mm tief  
 Streuwert: 2.90, horizontal: 3.55, vertikal: 2.05



Ergebnis: **374** (392.4)  
 Serien: 91 95 94 94  
 Zähler: 16 22 2 0 0 0 0 0 0 0  
 Innenzehner: 13  
 Weitestе: 557 (9.), 548 (2.), 484 (25.)  
 beste Teiler: 67.2 (11.), 69.3 (24.), 77.8 (33.)  
 Trefferlage: 0.20 mm rechts, 0.28 mm tief  
 Streuwert: 2.23, horizontal: 2.35, vertikal: 2.10

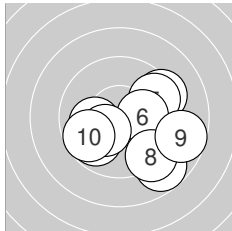
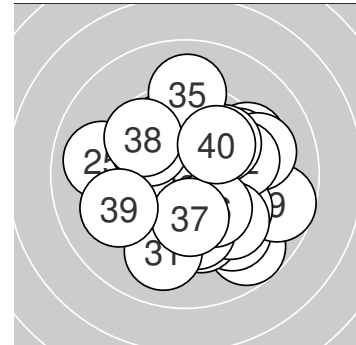

**Serie 1:**

10.1 ←	8.8 ↘	9.3 ↗	9.8 ↙	9.6 ↗
10.2 *	10.3 *	9.2 ↘	8.7 →	9.7 ↗

beste Teiler: 169.1 (7.), 198.4 (6.), 219.7 (1.)  
 Trefferlage: 1.21 mm rechts, 1.07 mm tief  
 Streuwert: 2.48, horizontal: 2.93, vertikal: 1.93

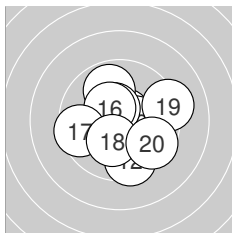

**Serie 2:**

10.7 *	9.5 ↓	10.4 *	9.9 ↑	10.5 *
10.4 *	9.5 ←	10.2 *	9.2 →	9.6 ↘

beste Teiler: 67.2 (11.), 110.4 (15.), 135.0 (16.)  
 Trefferlage: 0.34 mm rechts, 0.18 mm tief  
 Streuwert: 1.99, horizontal: 2.14, vertikal: 1.83

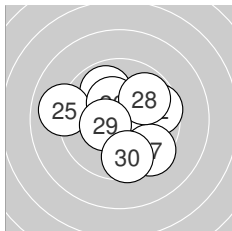

**Serie 3:**

10.3 *	9.6 →	9.9 ↑	10.7 *	9.0 ←
10.3 *	9.5 ↘	9.8 ↗	10.4 *	9.6 ↓

beste Teiler: 69.3 (24.), 132.7 (29.), 153.6 (21.)  
 Trefferlage: 0.03 mm links, 0.09 mm hoch  
 Streuwert: 2.13, horizontal: 2.36, vertikal: 1.86

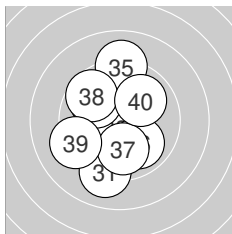

**Serie 4:**

9.1 ↓	10.2 *	10.6 *	9.9 ↘	9.1 ↑
9.9 ↘	10.0 ↓	9.7 ↘	9.2 ↙	10.0 ↗

beste Teiler: 77.8 (33.), 196.4 (32.), 249.0 (40.)  
 Trefferlage: 0.70 mm links, 0.01 mm hoch  
 Streuwert: 2.32, horizontal: 1.78, vertikal: 2.76



Ergebnis: **364** (379.1)  
 Serien: 98 89 87 90  
 Zähler: 15 15 9 1 0 0 0 0 0 0  
 Innenzehner: 10  
 Weitester: 968 (18.), 694 (13.), 650 (25.)  
 beste Teiler: 65.7 (6.), 83.4 (5.), 88.8 (1.)  
 Trefferlage: 0.48 mm links, 0.58 mm hoch  
 Streuwert: 2.99, horizontal: 3.24, vertikal: 2.72

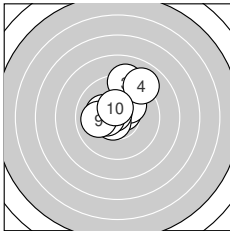
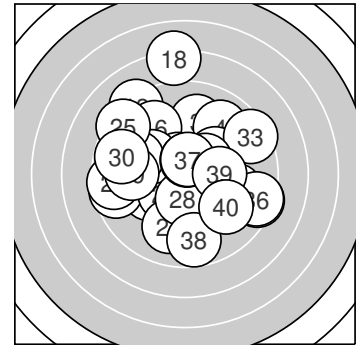

**Serie 1:**

10.6 *	10.1 ↗	9.2 ↑	9.0 ↗	10.6 *
10.7 *	10.4 *	10.2 *	10.0 ←	10.5 *

beste Teiler: 65.7 (6.), 83.4 (5.), 88.8 (1.)  
 Trefferlage: 0.08 mm links, 1.16 mm hoch  
 Streuwert: 1.65, horizontal: 1.60, vertikal: 1.69

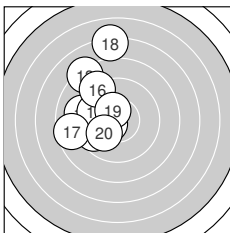

**Serie 2:**

9.6 ←	10.5 *	8.2 ↘	9.2 ←	9.7 ↘
9.1 ↘	8.6 ←	7.1 ↑	10.4 *	10.0 ↘

beste Teiler: 111.8 (12.), 135.5 (19.), 231.2 (20.)  
 Trefferlage: 2.67 mm links, 1.72 mm hoch  
 Streuwert: 2.85, horizontal: 1.69, vertikal: 3.66

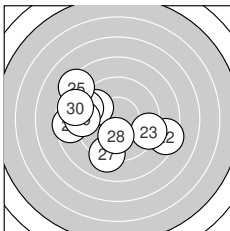

**Serie 3:**

9.7 ↖	8.4 →	9.3 →	9.3 ←	8.4 ↖
8.6 ←	9.1 ↓	10.1 ↓	9.2 ←	8.8 ←

beste Teiler: 205.0 (28.), 311.7 (21.), 416.5 (23.)  
 Trefferlage: 1.91 mm links, 0.23 mm tief  
 Streuwert: 3.34, horizontal: 4.06, vertikal: 2.40

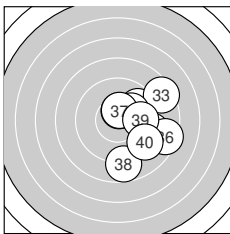

**Serie 4:**

9.2 →	9.7 ↗	8.4 ↗	10.1 ↗	10.5 *
8.4 →	10.5 *	8.7 ↓	9.8 →	9.2 ↘

beste Teiler: 118.3 (35.), 124.1 (37.), 203.8 (34.)  
 Trefferlage: 2.72 mm rechts, 0.32 mm tief  
 Streuwert: 2.33, horizontal: 2.06, vertikal: 2.56



**Ergebnis: 380 (397.7)**  
**Serien: 96 93 97 94**  
**Zähler: 22 16 2 0 0 0 0 0 0 0**  
**Innenzehner: 15**  
**Weiteste: 580 (20.), 514 (32.), 498 (38.)**  
**beste Teiler: 60.4 (1.), 97.1 (9.), 102.1 (4.)**  
**Trefferlage: 0.14 mm links, 0.16 mm hoch**  
**Streuwert: 2.02, horizontal: 2.45, vertikal: 1.49**

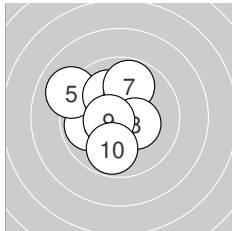
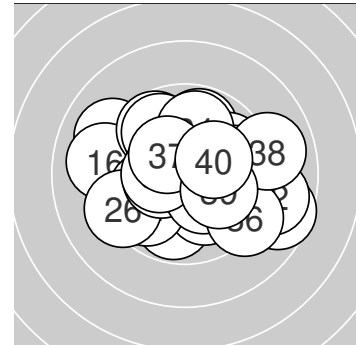

**Serie 1:**

10.7 *	10.2 *	9.9 ←	10.5 *	9.1 ↖
10.1 ↘	9.8 ↑	10.4 *	10.6 *	9.8 ↓

**beste Teiler: 60.4 (1.), 97.1 (9.), 102.1 (4.)**  
**Trefferlage: 0.75 mm links, 0.23 mm hoch**  
**Streuwert: 1.69, horizontal: 1.76, vertikal: 1.62**

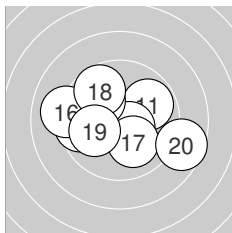

**Serie 2:**

9.8 ↗	9.8 ←	9.6 ←	10.5 *	10.0 ↘
9.1 ←	10.1 ↘	9.7 ↘	10.0 ←	8.6 →

**beste Teiler: 104.4 (14.), 221.4 (17.), 236.6 (19.)**  
**Trefferlage: 0.68 mm links, 0.05 mm hoch**  
**Streuwert: 2.44, horizontal: 3.08, vertikal: 1.55**

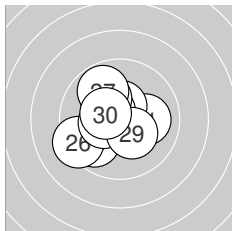

**Serie 3:**

10.1 →	10.5 *	10.5 *	9.8 ↙	10.1 ↘
9.3 ↙	9.8 ↘	10.4 *	10.3 *	10.4 *

**beste Teiler: 109.0 (23.), 112.8 (22.), 131.8 (30.)**  
**Trefferlage: 0.84 mm links, 0.10 mm hoch**  
**Streuwert: 1.58, horizontal: 1.65, vertikal: 1.51**

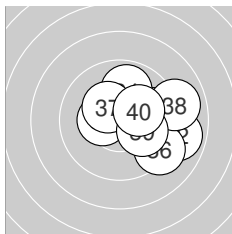

**Serie 4:**

9.8 →	8.9 →	10.4 *	9.9 ↑	10.4 *
9.2 ↘	10.3 *	9.0 →	10.1 ↘	10.2 *

**beste Teiler: 132.8 (33.), 147.0 (35.), 152.8 (37.)**  
**Trefferlage: 1.70 mm rechts, 0.28 mm hoch**  
**Streuwert: 1.97, horizontal: 2.35, vertikal: 1.50**



Ergebnis: **355** (374.5)  
 Serien: 89 89 85 92  
 Zähler: 12 13 13 2 0 0 0 0 0 0  
 Innenzehner: 10  
 Weitestе: 914 (30.), 782 (25.), 704 (4.)  
 beste Teiler: 60.0 (15.), 95.4 (37.), 96.5 (36.)  
 Trefferlage: 0.39 mm rechts, 0.42 mm tief  
 Streuwert: 3.24, horizontal: 4.23, vertikal: 1.76

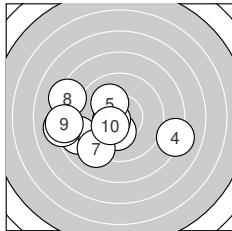
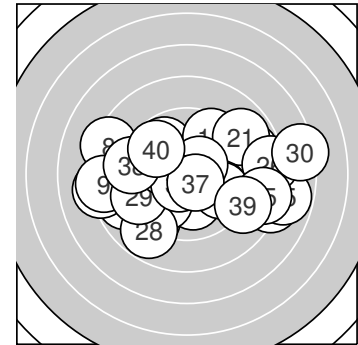

**Serie 1:**

8.8 ←	10.3 *	10.6 *	8.1 →	10.1 ↘
8.2 ←	9.1 ↙	8.3 ↖	8.3 ←	10.4 *

beste Teiler: 100.2 (3.), 150.1 (10.), 171.3 (2.)  
 Trefferlage: 2.41 mm links, 0.92 mm tief  
 Streuwert: 3.15, horizontal: 4.07, vertikal: 1.81

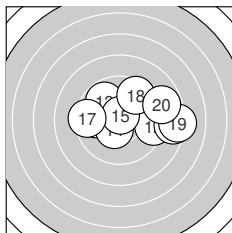

**Serie 2:**

9.8 ←	9.3 →	9.8 ↘	10.4 *	10.7 *
8.4 →	9.4 ←	9.5 ↗	8.2 →	8.8 →

beste Teiler: 60.0 (15.), 128.5 (14.), 281.4 (11.)  
 Trefferlage: 1.52 mm rechts, 0.52 mm hoch  
 Streuwert: 2.92, horizontal: 3.89, vertikal: 1.38

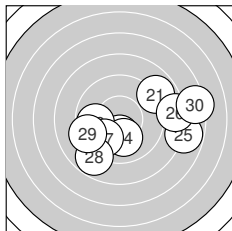

**Serie 3:**

8.9 ↗	10.2 *	9.8 ←	10.1 ↓	7.8 →
8.3 →	9.8 ↙	8.8 ↙	9.3 ←	7.3 →

beste Teiler: 176.0 (22.), 222.4 (24.), 286.5 (27.)  
 Trefferlage: 1.65 mm rechts, 0.90 mm tief  
 Streuwert: 3.74, horizontal: 4.82, vertikal: 2.18

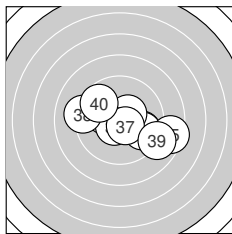

**Serie 4:**

10.2 *	9.8 →	9.8 →	10.5 *	8.4 →
10.6 *	10.6 *	9.2 ←	8.9 →	9.7 ↘

beste Teiler: 95.4 (37.), 96.5 (36.), 123.4 (34.)  
 Trefferlage: 0.82 mm rechts, 0.39 mm tief  
 Streuwert: 2.48, horizontal: 3.22, vertikal: 1.36



Ergebnis: **377** (395.0)  
 Serien: 93 94 96 94  
 Zähler: 21 15 4 0 0 0 0 0 0 0  
 Innenzehner: 17  
 Weitester: 663 (32.), 532 (5.), 531 (16.)  
 beste Teiler: 19.1 (7.), 19.3 (3.), 44.2 (33.)  
 Trefferlage: 1.20 mm links, 0.73 mm hoch  
 Streuwert: 1.99, horizontal: 2.42, vertikal: 1.43

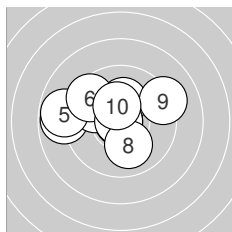
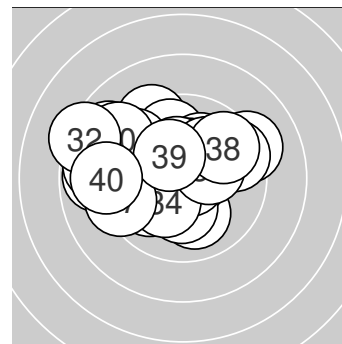

**Serie 1:**

10.2 *	8.8 ←	10.9 *	9.9 ↖	8.8 ←
9.5 ↘	10.9 *	10.0 ↓	9.2 ↗	10.4 *

beste Teiler: 19.1 (7.), 19.3 (3.), 149.1 (10.)  
 Trefferlage: 1.15 mm links, 0.72 mm hoch  
 Streuwert: 2.22, horizontal: 2.85, vertikal: 1.32

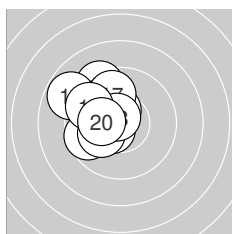

**Serie 2:**

10.4 *	10.5 *	9.6 ←	10.1 ←	9.3 ↘
8.8 ↘	9.8 ↗	10.7 *	9.6 ↖	10.2 *

beste Teiler: 67.9 (18.), 106.8 (12.), 127.0 (11.)  
 Trefferlage: 1.85 mm links, 0.96 mm hoch  
 Streuwert: 1.52, horizontal: 1.38, vertikal: 1.66

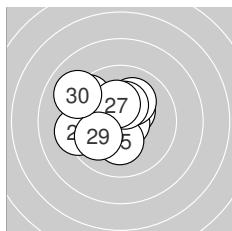

**Serie 3:**

10.4 *	10.7 *	10.1 ↗	9.5 ↘	10.2 *
10.3 *	10.3 *	9.3 ←	9.9 ↗	9.1 ↘

beste Teiler: 52.9 (22.), 138.6 (21.), 154.4 (26.)  
 Trefferlage: 1.06 mm links, 0.61 mm hoch  
 Streuwert: 1.82, horizontal: 2.03, vertikal: 1.58

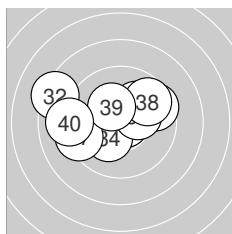

**Serie 4:**

10.1 ↗	8.3 ↘	10.8 *	10.2 *	9.6 ↗
10.3 *	9.3 ←	9.7 ↗	10.3 *	9.0 ←

beste Teiler: 44.2 (33.), 166.3 (39.), 172.7 (36.)  
 Trefferlage: 0.75 mm links, 0.64 mm hoch  
 Streuwert: 2.48, horizontal: 3.23, vertikal: 1.36



**Ergebnis: 378 (395.0)**  
**Serien: 93 92 98 95**  
**Zähler: 19 20 1 0 0 0 0 0 0 0**  
**Innenzehner: 13**  
**Weiteste: 626 (20.), 493 (3.), 446 (18.)**  
**beste Teiler: 13.0 (34.), 50.0 (14.), 52.6 (38.)**  
**Trefferlage: 0.39 mm rechts, 0.02 mm tief**  
**Streuwert: 2.13, horizontal: 2.28, vertikal: 1.98**

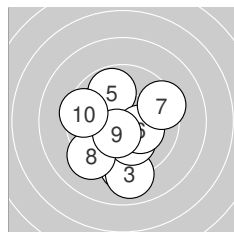
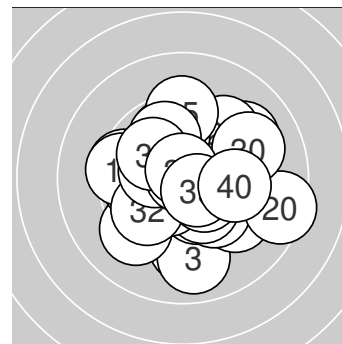

**Serie 1:**

9.8 ←	9.3 ↓	9.0 ↓	10.1 ↓	9.8 ↑
10.2 *	9.4 →	9.2 ↗	10.5 *	9.5 ←

**beste Teiler: 125.2 (9.), 179.0 (6.), 201.3 (4.)**  
**Trefferlage: 0.40 mm links, 1.02 mm tief**  
**Streuwert: 2.39, horizontal: 2.26, vertikal: 2.51**

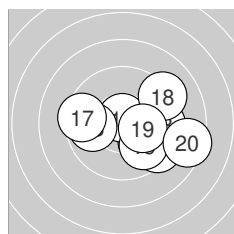

**Serie 2:**

9.4 ↘	10.0 ↘	9.5 →	10.8 *	9.8 ↓
9.8 ←	9.4 ←	9.2 ↗	10.2 *	8.4 →

**beste Teiler: 50.0 (14.), 191.8 (19.), 247.6 (12.)**  
**Trefferlage: 1.55 mm rechts, 0.52 mm tief**  
**Streuwert: 2.37, horizontal: 3.00, vertikal: 1.49**

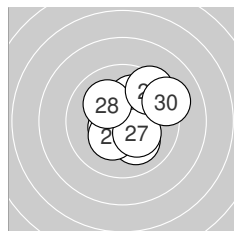

**Serie 3:**

10.5 *	10.1 ↓	10.2 *	10.6 *	10.3 *
10.1 ↗	10.3 *	10.1 ↘	9.4 ↗	9.2 →

**beste Teiler: 83.6 (24.), 112.5 (21.), 164.5 (25.)**  
**Trefferlage: 0.78 mm rechts, 0.58 mm hoch**  
**Streuwert: 1.65, horizontal: 1.67, vertikal: 1.64**

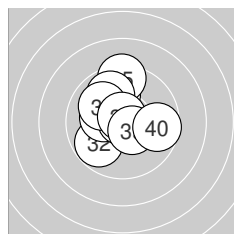

**Serie 4:**

9.9 ↑	9.8 ↗	10.2 *	10.9 *	9.3 ↑
9.9 ↓	10.0 ↘	10.7 *	10.5 *	9.7 →

**beste Teiler: 13.0 (34.), 52.6 (38.), 115.6 (39.)**  
**Trefferlage: 0.36 mm links, 0.85 mm hoch**  
**Streuwert: 1.69, horizontal: 1.58, vertikal: 1.79**





Ergebnis: **383** (398.7)  
 Serien: 96 97 95 95  
 Zähler: 24 15 1 0 0 0 0 0 0  
 Innenzehner: 18  
 Weitester: 518 (37.), 464 (20.), 454 (16.)  
 beste Teiler: 65.2 (25.), 84.2 (17.), 85.4 (2.)  
 Trefferlage: 0.29 mm links, 0.39 mm hoch  
 Streuwert: 1.93, horizontal: 2.28, vertikal: 1.49

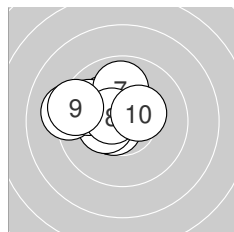
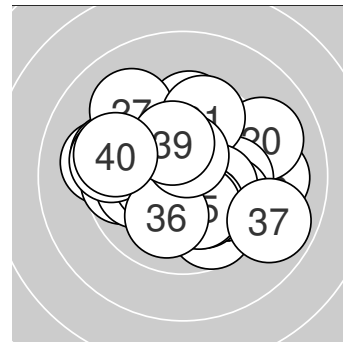

**Serie 1:**  
 10.5 \*                      10.6 \*                      10.4 \*                      10.2 \*                      9.2 ←  
 9.8 ↙                      9.9 ↑                      10.6 \*                      9.4 ↙                      10.4 \*  
 beste Teiler: 85.4 (2.), 96.6 (8.), 102.9 (1.)  
 Trefferlage: 1.48 mm links, 0.68 mm hoch  
 Streuwert: 1.37, horizontal: 1.68, vertikal: 0.96

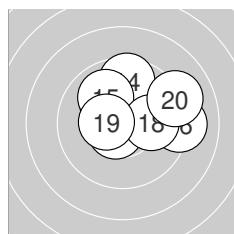

**Serie 2:**  
 10.2 \*                      10.0 →                      10.2 \*                      9.6 ↑                      10.0 ↘  
 9.1 →                      10.6 \*                      10.0 →                      10.4 \*                      9.1 →  
 beste Teiler: 84.2 (17.), 130.3 (19.), 179.5 (13.)  
 Trefferlage: 0.82 mm rechts, 0.97 mm hoch  
 Streuwert: 1.87, horizontal: 2.32, vertikal: 1.27

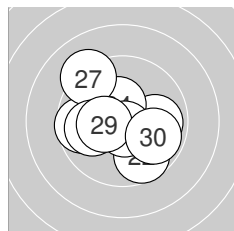

**Serie 3:**  
 10.0 ←                      9.7 ↘                      9.9 →                      10.4 \*                      10.7 \*  
 9.7 ←                      9.2 ↘                      10.0 ←                      10.4 \*                      9.9 →  
 beste Teiler: 65.2 (25.), 137.7 (24.), 149.1 (29.)  
 Trefferlage: 0.58 mm links, 0.05 mm tief  
 Streuwert: 1.94, horizontal: 2.20, vertikal: 1.63

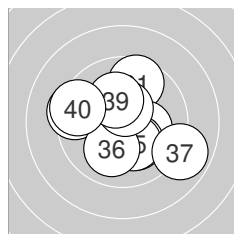

**Serie 4:**  
 9.6 ↑                      10.2 \*                      9.4 ←                      10.2 \*                      10.2 \*  
 10.0 ↓                      8.9 ↘                      10.5 \*                      10.2 \*                      9.4 ←  
 beste Teiler: 111.9 (38.), 182.5 (32.), 185.6 (39.)  
 Trefferlage: 0.06 mm rechts, 0.03 mm tief  
 Streuwert: 2.21, horizontal: 2.50, vertikal: 1.89



Ergebnis: **384** (401.1)  
 Serien: 96 97 96 95  
 Zähler: 25 14 1 0 0 0 0 0 0 0  
 Innenzehner: 20  
 Weitester: 686 (39.), 487 (23.), 478 (19.)  
 beste Teiler: 37.3 (13.), 39.0 (11.), 51.2 (29.)  
 Trefferlage: 0.31 mm rechts, 0.09 mm tief  
 Streuwert: 1.92, horizontal: 2.11, vertikal: 1.70

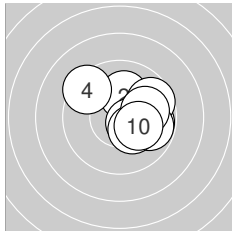
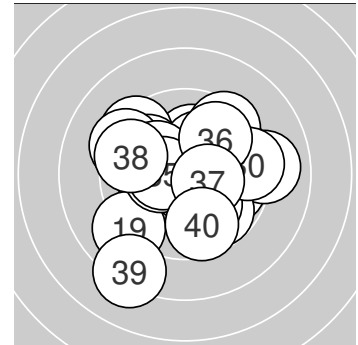

**Serie 1:**

10.4 *	10.1 ↑	9.8 →	9.4 ↘	9.7 →
10.5 *	9.8 →	10.3 *	10.0 →	10.2 *

beste Teiler: 108.7 (6.), 138.7 (1.), 162.6 (8.)  
 Trefferlage: 1.33 mm rechts, 0.34 mm hoch  
 Streuwert: 1.54, horizontal: 1.75, vertikal: 1.30

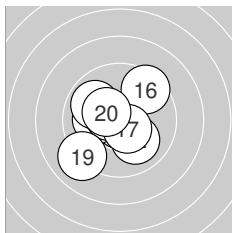

**Serie 2:**

10.8 *	10.0 ↘	10.8 *	10.1 ←	10.5 *
9.5 ↗	10.5 *	9.9 ↘	9.0 ↗	10.4 *

beste Teiler: 37.3 (13.), 39.0 (11.), 101.9 (15.)  
 Trefferlage: 0.57 mm links, 0.07 mm tief  
 Streuwert: 1.74, horizontal: 1.79, vertikal: 1.69

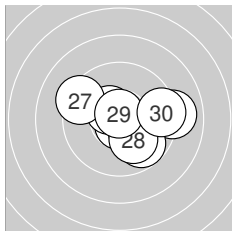

**Serie 3:**

10.7 *	10.5 *	9.0 →	10.3 *	9.8 ↘
10.2 *	9.3 ↘	10.1 ↘	10.7 *	9.4 →

beste Teiler: 51.2 (29.), 56.2 (21.), 124.5 (22.)  
 Trefferlage: 1.00 mm rechts, 0.23 mm tief  
 Streuwert: 1.93, horizontal: 2.40, vertikal: 1.29

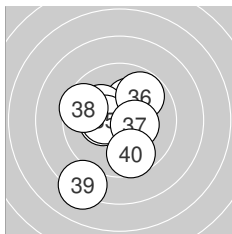

**Serie 4:**

10.5 *	10.4 *	10.2 *	10.2 *	10.4 *
9.8 ↗	10.4 *	9.6 ↘	8.2 ↗	9.7 ↘

beste Teiler: 122.0 (31.), 135.1 (35.), 145.8 (37.)  
 Trefferlage: 0.51 mm links, 0.42 mm tief  
 Streuwert: 2.22, horizontal: 1.98, vertikal: 2.44



Ergebnis: **375** (391.5)  
 Serien: 93 94 94 94  
 Zähler: 20 15 5 0 0 0 0 0 0 0  
 Innenzehner: 16  
 Weitestе: 594 (34.), 583 (5.), 570 (39.)  
 beste Teiler: 55.9 (33.), 84.5 (37.), 109.0 (38.)  
 Trefferlage: 0.91 mm links, 0.70 mm hoch  
 Streuwert: 2.19, horizontal: 2.70, vertikal: 1.52

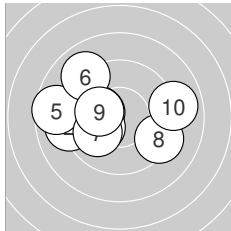
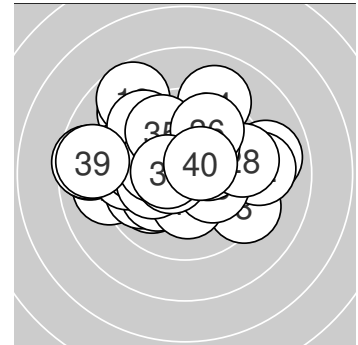

**Serie 1:**

10.2 \*                      9.1 ←                      10.2 \*  
 9.0 ↘                      10.0 ↗                      9.3 ↘  
 beste Teiler: 181.4 (1.), 193.1 (9.), 196.4 (3.)  
 Trefferlage: 1.42 mm links, 0.19 mm hoch  
 Streuwert: 2.61, horizontal: 3.32, vertikal: 1.61

10.1 ↖                      8.6 ←  
 10.2 \*                      8.9 →

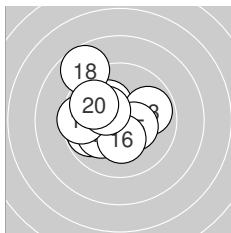

**Serie 2:**

9.8 ↙                      10.2 \*                      9.9 →  
 10.3 \*                      9.6 ←                      8.7 ↘  
 beste Teiler: 141.4 (15.), 152.0 (19.), 170.8 (16.)  
 Trefferlage: 1.16 mm links, 0.46 mm hoch  
 Streuwert: 1.91, horizontal: 1.98, vertikal: 1.84

10.1 ↗                      10.4 \*  
 10.3 \*                      9.9 ↖

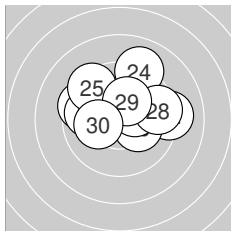

**Serie 3:**

9.5 ↖                      9.1 →                      9.8 ←  
 10.2 \*                      10.3 \*                      9.5 →  
 beste Teiler: 153.9 (27.), 177.5 (29.), 184.0 (26.)  
 Trefferlage: 0.28 mm rechts, 1.13 mm hoch  
 Streuwert: 2.26, horizontal: 2.80, vertikal: 1.54

9.1 ↗                      9.4 ↘  
 10.2 \*                      10.2 \*

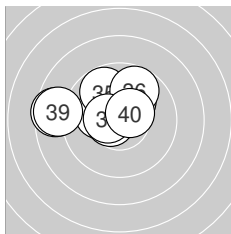

**Serie 4:**

10.1 ↗                      10.2 \*                      10.7 \*  
 9.7 ↗                      10.6 \*                      10.5 \*  
 beste Teiler: 55.9 (33.), 84.5 (37.), 109.0 (38.)  
 Trefferlage: 1.37 mm links, 1.00 mm hoch  
 Streuwert: 1.95, horizontal: 2.57, vertikal: 0.99

8.6 ←                      9.8 ↘  
 8.7 ←                      10.5 \*



**Ergebnis: 381 (400.3)**  
**Serien: 92 96 97 96**  
**Zähler: 22 17 1 0 0 0 0 0 0 0**  
**Innenzehner: 16**  
**Weiteste: 609 (37.), 447 (8.), 422 (28.)**  
**beste Teiler: 12.6 (23.), 78.2 (24.), 78.3 (31.)**  
**Trefferlage: 0.39 mm links, 0.63 mm hoch**  
**Streuwert: 1.81, horizontal: 1.81, vertikal: 1.81**

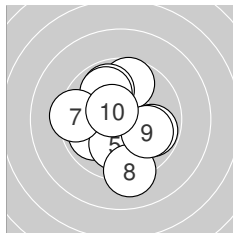
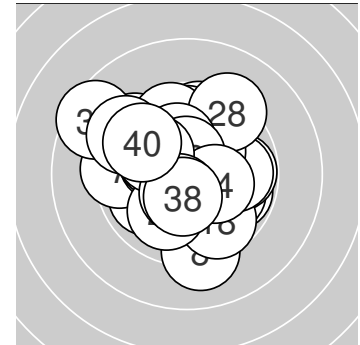

**Serie 1:**

9.7 ↑	9.9 ↘	9.9 ↘	9.9 ↙	10.1 ↓
9.8 →	9.4 ←	9.2 ↓	9.9 →	10.5 *

**beste Teiler: 104.6 (10.), 216.3 (5.), 251.8 (9.)**  
**Trefferlage: 0.32 mm links, 0.09 mm tief**  
**Streuwert: 2.17, horizontal: 1.99, vertikal: 2.33**

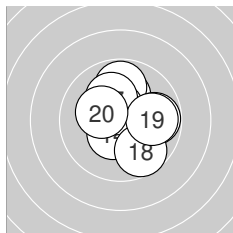

**Serie 2:**

10.0 ↑	10.1 ↑	9.8 ↑	10.4 *	10.5 *
9.8 →	10.1 ↘	9.7 ↘	9.9 →	10.2 *

**beste Teiler: 103.5 (15.), 130.3 (14.), 177.0 (20.)**  
**Trefferlage: 0.42 mm rechts, 0.73 mm hoch**  
**Streuwert: 1.60, horizontal: 1.52, vertikal: 1.69**

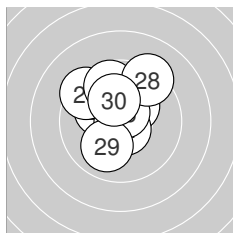

**Serie 3:**

10.3 *	10.2 *	10.9 *	10.6 *	10.6 *
9.4 ↘	9.7 ↑	9.3 ↗	10.0 ↙	10.2 *

**beste Teiler: 12.6 (23.), 78.2 (24.), 80.6 (25.)**  
**Trefferlage: 0.33 mm links, 1.08 mm hoch**  
**Streuwert: 1.61, horizontal: 1.50, vertikal: 1.73**

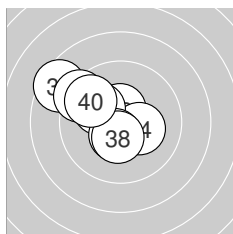

**Serie 4:**

10.6 *	10.4 *	10.5 *	10.3 *	10.1 ↘
10.5 *	8.5 ↘	10.4 *	9.3 ↘	9.7 ↘

**beste Teiler: 78.3 (31.), 106.1 (33.), 118.5 (36.)**  
**Trefferlage: 1.33 mm links, 0.81 mm hoch**  
**Streuwert: 1.73, horizontal: 1.99, vertikal: 1.43**



**Ergebnis:** **370** (389.2)  
**Serien:** 94 94 90 92  
**Zähler:** 16 19 4 1 0 0 0 0 0 0  
**Innenzehner:** 8  
**Weiteste:** 762 (2.), 682 (28.), 667 (17.)  
**beste Teiler:** 48.1 (35.), 49.6 (26.), 92.8 (15.)  
**Trefferlage:** 1.04 mm links, 0.70 mm hoch  
**Streuwert:** 2.32, horizontal: 2.41, vertikal: 2.23

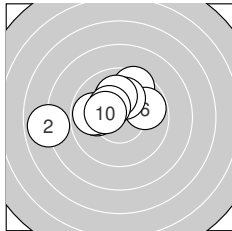
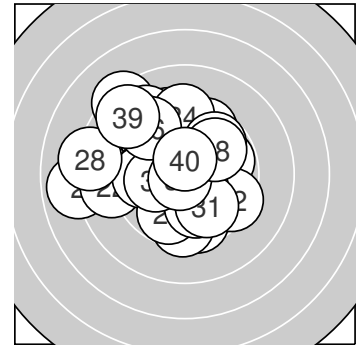

**Serie 1:**

10.0 ←	7.9 ←	9.8 ←	10.1 ↑	9.6 ↗
9.8 →	10.1 ↑	10.1 ↑	10.3 *	10.3 *

**beste Teiler:** 156.2 (9.), 160.0 (10.), 205.4 (4.)  
**Trefferlage:** 1.15 mm links, 1.16 mm hoch  
**Streuwert:** 2.16, horizontal: 2.81, vertikal: 1.19

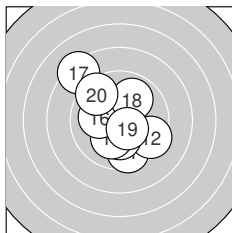

**Serie 2:**

9.6 ↓	9.4 ↘	10.2 *	10.1 ↓	10.6 *
10.1 ←	8.3 ↘	9.9 ↗	10.5 *	9.5 ↘

**beste Teiler:** 92.8 (15.), 121.7 (19.), 196.0 (13.)  
**Trefferlage:** 0.32 mm links, 0.13 mm hoch  
**Streuwert:** 2.42, horizontal: 2.20, vertikal: 2.61

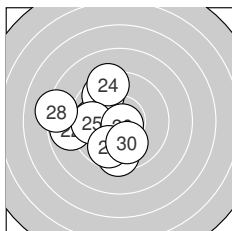

**Serie 3:**

9.9 ←	8.8 ←	9.7 ↘	9.3 ↑	9.8 ←
10.8 *	9.5 ↓	8.2 ←	9.8 ↓	10.0 ↓

**beste Teiler:** 49.6 (26.), 240.9 (30.), 266.4 (21.)  
**Trefferlage:** 2.07 mm links, 0.22 mm tief  
**Streuwert:** 2.37, horizontal: 2.39, vertikal: 2.35

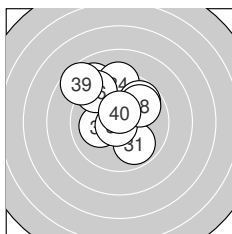

**Serie 4:**

9.9 ↘	10.1 ←	9.0 ↘	9.3 ↑	10.8 *
9.3 ↘	9.7 ↗	9.9 ↗	8.7 ↘	10.5 *

**beste Teiler:** 48.1 (35.), 106.0 (40.), 212.3 (32.)  
**Trefferlage:** 0.61 mm links, 1.74 mm hoch  
**Streuwert:** 2.20, horizontal: 2.17, vertikal: 2.22



Ergebnis: **371** (389.8)  
 Serien: 94 91 90 96  
 Zähler: 16 19 5 0 0 0 0 0 0 0  
 Innenzehner: 8  
 Weitester: 621 (14.), 610 (28.), 586 (25.)  
 beste Teiler: 44.6 (40.), 82.2 (6.), 91.4 (35.)  
 Trefferlage: 0.44 mm rechts, 0.18 mm tief  
 Streuwert: 2.38, horizontal: 2.66, vertikal: 2.06

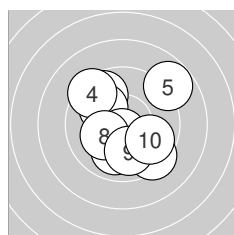
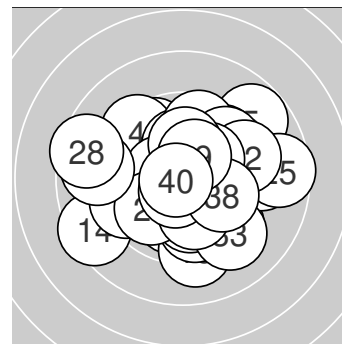

**Serie 1:**  
 9.7 ↘ 10.0 ↓ 10.0 ↘ 9.4 ↘ 8.8 ↗  
 10.6 \* 9.4 ↘ 10.2 \* 10.0 ↓ 9.8 ↘  
 beste Teiler: 82.2 (6.), 192.6 (8.), 230.6 (3.)  
 Trefferlage: 0.12 mm rechts, 0.04 mm tief  
 Streuwert: 2.37, horizontal: 2.31, vertikal: 2.43

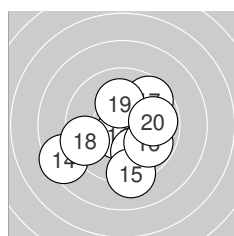

**Serie 2:**  
 10.6 \* 9.9 ↓ 9.9 ↗ 8.5 ↖ 9.2 ↓  
 9.8 ↘ 9.6 ↗ 9.5 ↖ 10.1 ↑ 9.8 →  
 beste Teiler: 95.0 (11.), 201.8 (19.), 260.9 (13.)  
 Trefferlage: 0.18 mm rechts, 0.73 mm tief  
 Streuwert: 2.50, horizontal: 2.69, vertikal: 2.29

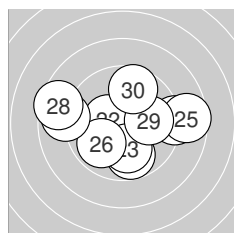

**Serie 3:**  
 9.8 ↓ 10.4 \* 10.0 ↓ 9.0 → 8.6 →  
 9.9 ↗ 8.9 ← 8.5 ← 10.0 → 9.7 ↑  
 beste Teiler: 138.4 (22.), 234.1 (23.), 242.3 (29.)  
 Trefferlage: 0.07 mm rechts, 0.03 mm tief  
 Streuwert: 3.00, horizontal: 3.83, vertikal: 1.83

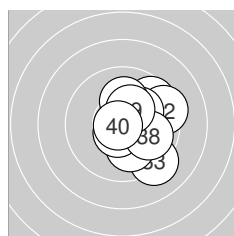

**Serie 4:**  
 9.6 ↗ 9.4 → 9.2 ↘ 10.1 ↓ 10.6 \*  
 10.2 \* 10.1 ↑ 9.9 ↘ 10.3 \* 10.8 \*  
 beste Teiler: 44.6 (40.), 91.4 (35.), 151.1 (39.)  
 Trefferlage: 1.37 mm rechts, 0.05 mm hoch  
 Streuwert: 1.67, horizontal: 1.47, vertikal: 1.86



Ergebnis: **376** (394.9)  
 Serien: 94 94 93 95  
 Zähler: 19 18 3 0 0 0 0 0 0  
 Innenzehner: 12  
 Weitester: 561 (39.), 525 (19.), 515 (26.)  
 beste Teiler: 66.0 (10.), 88.4 (30.), 131.2 (3.)  
 Trefferlage: 0.26 mm links, 0.59 mm hoch  
 Streuwert: 2.04, horizontal: 2.10, vertikal: 1.98

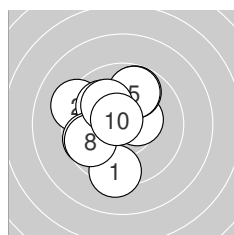
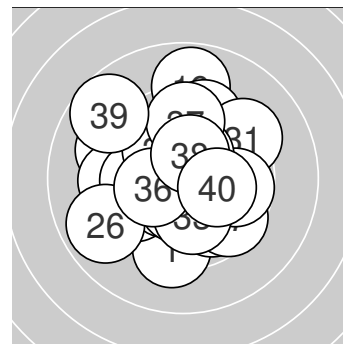

**Serie 1:**

9.3 ↓	9.3 ↖	10.4 *	9.8 ↑	9.8 ↑
10.0 ↘	9.7 ↙	9.7 ↙	10.1 ↘	10.7 *

beste Teiler: 66.0 (10.), 131.2 (3.), 210.8 (9.)  
 Trefferlage: 1.05 mm links, 0.44 mm hoch  
 Streuwert: 1.97, horizontal: 1.81, vertikal: 2.13

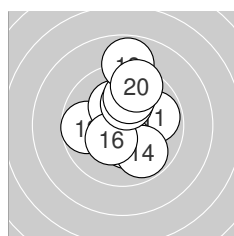

**Serie 2:**

9.8 →	10.3 *	9.7 ←	9.8 ↘	10.2 *
10.3 *	10.2 *	10.0 ↑	8.9 ↑	9.5 ↑

beste Teiler: 151.2 (16.), 152.3 (12.), 176.8 (15.)  
 Trefferlage: 0.25 mm rechts, 1.00 mm hoch  
 Streuwert: 2.00, horizontal: 1.57, vertikal: 2.35

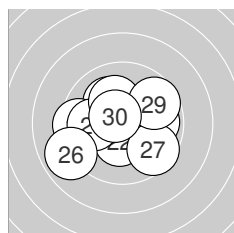

**Serie 3:**

10.1 ↘	10.4 *	9.4 ←	9.9 →	9.9 ←
8.9 ↙	9.6 ↘	10.2 *	9.7 ↗	10.6 *

beste Teiler: 88.4 (30.), 148.2 (22.), 197.1 (28.)  
 Trefferlage: 0.55 mm links, 0.05 mm tief  
 Streuwert: 2.17, horizontal: 2.60, vertikal: 1.62

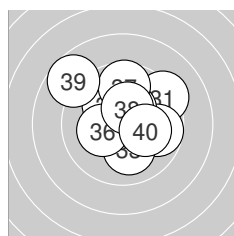

**Serie 4:**

9.3 ↗	9.7 →	10.1 ↓	10.1 ↘	10.4 *
10.2 *	9.7 ↑	10.4 *	8.7 ↘	10.1 →

beste Teiler: 143.0 (38.), 145.3 (35.), 178.0 (36.)  
 Trefferlage: 0.29 mm rechts, 0.98 mm hoch  
 Streuwert: 2.08, horizontal: 2.28, vertikal: 1.87



**Ergebnis:** **372** (390.4)  
**Serien:** 94 95 94 89  
**Zähler:** 19 14 7 0 0 0 0 0 0  
**Innenzehner:** 13  
**Weiteste:** 696 (7.), 648 (1.), 584 (22.)  
**beste Teiler:** 35.4 (3.), 66.4 (9.), 72.0 (14.)  
**Trefferlage:** 0.71 mm rechts, 0.10 mm hoch  
**Streuwert:** 2.43, horizontal: 2.45, vertikal: 2.42

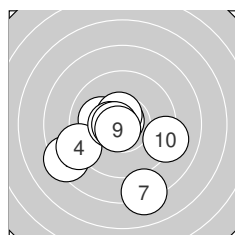
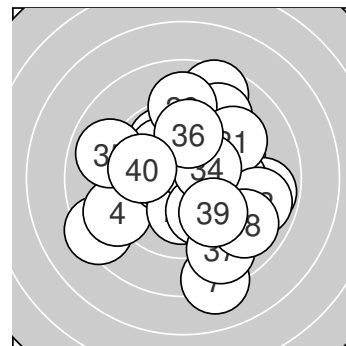

**Serie 1:**

8.4 ↙	10.1 ←	10.8 *	9.0 ↙	10.6 *
10.5 *	8.2 ↓	10.6 *	10.7 *	9.2 →

**beste Teiler:** 35.4 (3.), 66.4 (9.), 79.0 (8.)  
**Trefferlage:** 0.84 mm links, 1.25 mm tief  
**Streuwert:** 2.57, horizontal: 2.81, vertikal: 2.32

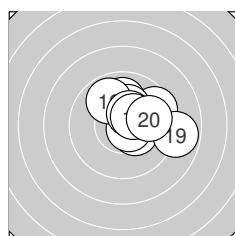

**Serie 2:**

9.6 ↗	10.4 *	10.0 ↑	10.7 *	10.2 *
9.9 ↘	10.4 *	10.4 *	8.8 →	9.9 →

**beste Teiler:** 72.0 (14.), 131.7 (17.), 135.0 (18.)  
**Trefferlage:** 1.36 mm rechts, 0.87 mm hoch  
**Streuwert:** 1.56, horizontal: 1.84, vertikal: 1.22

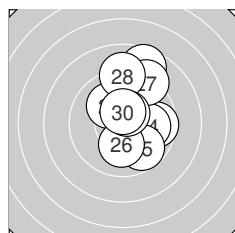

**Serie 3:**

10.1 ↘	8.6 ↗	9.6 →	10.0 →	9.7 ↘
10.1 ↓	9.1 ↗	9.1 ↑	10.5 *	10.5 *

**beste Teiler:** 105.1 (29.), 113.0 (30.), 208.3 (26.)  
**Trefferlage:** 1.09 mm rechts, 1.30 mm hoch  
**Streuwert:** 2.18, horizontal: 1.48, vertikal: 2.71

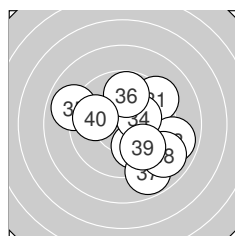

**Serie 4:**

9.3 ↗	10.0 ↓	8.9 →	10.3 *	8.9 ↙
9.8 ↑	8.8 ↓	9.0 ↘	9.8 ↘	9.9 ↙

**beste Teiler:** 171.2 (34.), 241.5 (32.), 274.3 (40.)  
**Trefferlage:** 1.22 mm rechts, 0.52 mm tief  
**Streuwert:** 2.76, horizontal: 2.98, vertikal: 2.53





Ergebnis: **380** (400.4)  
 Serien: 97 95 94 94  
 Zähler: 21 18 1 0 0 0 0 0 0 0  
 Innenzehner: 17  
 Weitest: 540 (23.), 443 (11.), 399 (4.)  
 beste Teiler: 16.4 (18.), 57.7 (25.), 64.4 (21.)  
 Trefferlage: 0.32 mm rechts, 0.21 mm hoch  
 Streuwert: 1.85, horizontal: 2.17, vertikal: 1.46

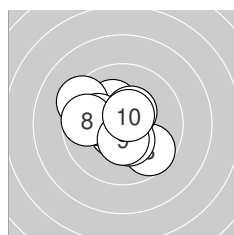
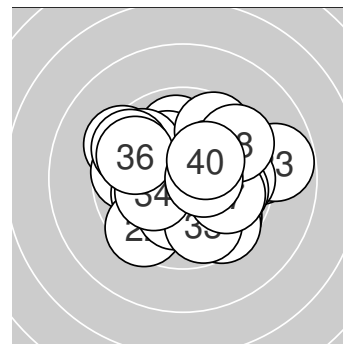

**Serie 1:**  
 10.2 \*                      10.6 \*                      9.7 ↘                      9.4 ↖                      10.4 \*  
 10.1 ←                      10.4 \*                      9.7 ←                      10.4 \*                      10.6 \*  
 beste Teiler: 88.3 (2.), 91.5 (10.), 128.7 (5.)  
 Trefferlage: 0.60 mm links, 0.06 mm hoch  
 Streuwert: 1.62, horizontal: 1.83, vertikal: 1.38

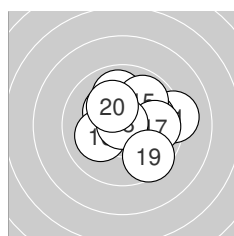

**Serie 2:**  
 9.2 →                      9.9 ↑                      10.3 \*                      10.0 →                      9.9 ↗  
 10.1 ←                      9.8 →                      10.9 \*                      9.6 ↘                      10.2 \*  
 beste Teiler: 16.4 (18.), 167.6 (13.), 186.5 (20.)  
 Trefferlage: 0.89 mm rechts, 0.52 mm hoch  
 Streuwert: 1.81, horizontal: 2.06, vertikal: 1.52

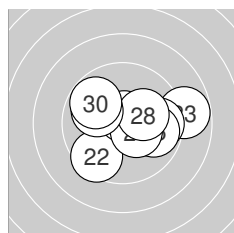

**Serie 3:**  
 10.7 \*                      9.5 ↙                      8.8 →                      9.7 →                      10.7 \*  
 9.8 →                      10.4 \*                      10.2 \*                      10.0 ↖                      9.8 ↖  
 beste Teiler: 57.7 (25.), 64.4 (21.), 139.6 (27.)  
 Trefferlage: 0.69 mm rechts, 0.02 mm hoch  
 Streuwert: 2.05, horizontal: 2.59, vertikal: 1.30

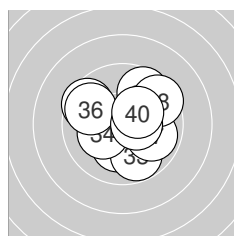

**Serie 4:**  
 10.2 \*                      9.6 ↖                      9.8 ↘                      10.2 \*                      9.7 ↗  
 9.7 ↖                      9.9 →                      9.5 ↗                      10.5 \*                      10.3 \*  
 beste Teiler: 121.0 (39.), 166.0 (40.), 186.1 (34.)  
 Trefferlage: 0.30 mm rechts, 0.25 mm hoch  
 Streuwert: 1.98, horizontal: 2.16, vertikal: 1.79



**Ergebnis: 391 (407.4)**  
**Serien: 98 96 100 97**  
**Zähler: 31 9 0 0 0 0 0 0 0 0**  
**Innenzehner: 22**  
**Weiteste: 410 (12.), 380 (14.), 360 (6.)**  
**beste Teiler: 41.1 (13.), 50.2 (22.), 63.0 (23.)**  
**Trefferlage: 0.42 mm links, 0.33 mm hoch**  
**Streuwert: 1.47, horizontal: 1.69, vertikal: 1.21**

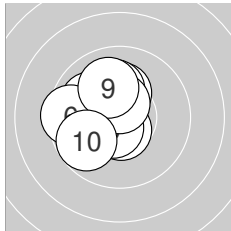
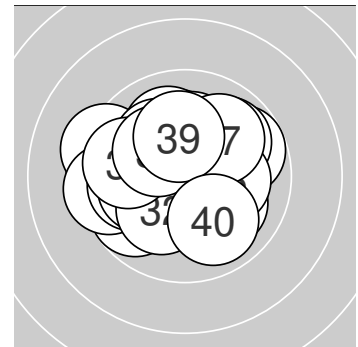

**Serie 1:**

10.6 *	10.2 *	10.1 ←	10.0 ↖	10.6 *
9.5 ←	10.1 ↑	10.5 *	10.0 ↑	9.8 ↙

**beste Teiler: 91.0 (5.), 94.7 (1.), 103.0 (8.)**  
**Trefferlage: 1.17 mm links, 0.48 mm hoch**  
**Streuwert: 1.33, horizontal: 1.30, vertikal: 1.35**

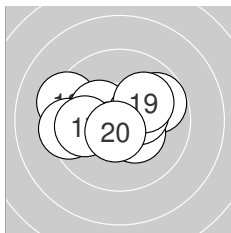

**Serie 2:**

9.8 ↗	9.3 ↖	10.8 *	9.4 ←	10.4 *
10.3 *	9.9 ←	10.4 *	10.1 ↗	10.6 *

**beste Teiler: 41.1 (13.), 89.8 (20.), 145.4 (18.)**  
**Trefferlage: 0.54 mm links, 0.22 mm hoch**  
**Streuwert: 1.77, horizontal: 2.34, vertikal: 0.91**

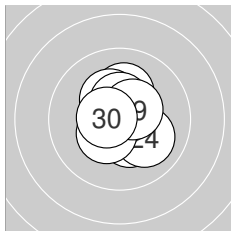

**Serie 3:**

10.3 *	10.8 *	10.7 *	10.1 ↘	10.4 *
10.2 *	10.3 *	10.5 *	10.5 *	10.6 *

**beste Teiler: 50.2 (22.), 63.0 (23.), 95.7 (30.)**  
**Trefferlage: 0.21 mm rechts, 0.19 mm hoch**  
**Streuwert: 1.04, horizontal: 0.90, vertikal: 1.16**

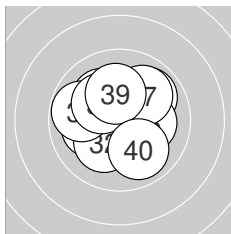

**Serie 4:**

10.1 ←	10.2 *	10.1 ↘	9.9 ↗	10.2 *
9.8 ←	10.0 ↗	10.2 *	10.2 *	9.9 ↘

**beste Teiler: 181.8 (38.), 197.2 (39.), 198.6 (32.)**  
**Trefferlage: 0.18 mm links, 0.44 mm hoch**  
**Streuwert: 1.66, horizontal: 1.81, vertikal: 1.49**



Ergebnis: **375** (392.6)  
 Serien: 95 93 90 97  
 Zähler: 20 16 3 1 0 0 0 0 0 0  
 Innenzehner: 14  
 Weitestе: 783 (27.), 655 (22.), 652 (19.)  
 beste Teiler: 33.1 (12.), 49.0 (3.), 53.3 (32.)  
 Trefferlage: 0.57 mm rechts, 0.45 mm tief  
 Streuwert: 2.32, horizontal: 2.56, vertikal: 2.06

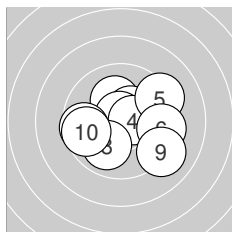
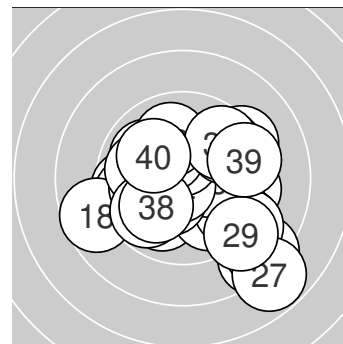

**Serie 1:**

10.2 *	10.4 *	10.8 *	10.5 *	9.3 ↗
9.4 ↘	9.6 ←	10.0 ↙	9.1 ↘	9.6 ←

beste Teiler: 49.0 (3.), 112.4 (4.), 133.0 (2.)  
 Trefferlage: 0.46 mm rechts, 0.15 mm tief  
 Streuwert: 2.19, horizontal: 2.64, vertikal: 1.61

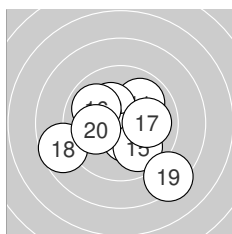

**Serie 2:**

9.9 ↗	10.8 *	10.3 *	10.4 *	9.9 ↘
9.9 ↘	10.0 →	8.7 ←	8.3 ↘	10.0 ←

beste Teiler: 33.1 (12.), 140.7 (14.), 170.9 (13.)  
 Trefferlage: 0.02 mm links, 0.66 mm tief  
 Streuwert: 2.44, horizontal: 2.76, vertikal: 2.06

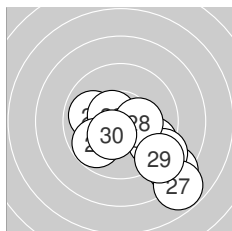

**Serie 3:**

9.9 ←	8.3 ↘	10.6 *	9.8 ↙	9.6 ↘
9.0 ↘	7.8 ↘	10.3 *	9.0 ↘	10.4 *

beste Teiler: 95.4 (23.), 146.1 (30.), 162.5 (28.)  
 Trefferlage: 1.57 mm rechts, 2.07 mm tief  
 Streuwert: 2.55, horizontal: 2.92, vertikal: 2.12

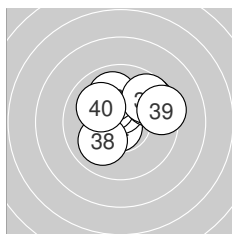

**Serie 4:**

10.4 *	10.7 *	10.5 *	10.3 *	9.7 ↗
10.0 ↑	9.7 ↗	10.0 ↙	9.4 →	10.1 ↘

beste Teiler: 53.3 (32.), 117.1 (33.), 133.9 (31.)  
 Trefferlage: 0.29 mm rechts, 1.05 mm hoch  
 Streuwert: 1.60, horizontal: 1.91, vertikal: 1.23



Ergebnis: **392** (409.8)  
 Serien: 98 98 99 97  
 Zähler: 32 8 0 0 0 0 0 0 0 0  
 Innenzehner: 25  
 Weitestе: 422 (4.), 387 (37.), 337 (10.)  
 beste Teiler: 41.4 (29.), 66.4 (12.), 72.0 (14.)  
 Trefferlage: 0.05 mm links, 0.00 mm  
 Streuwert: 1.41, horizontal: 1.58, vertikal: 1.23

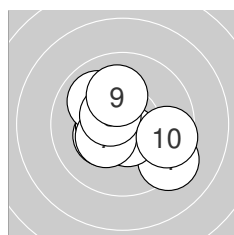
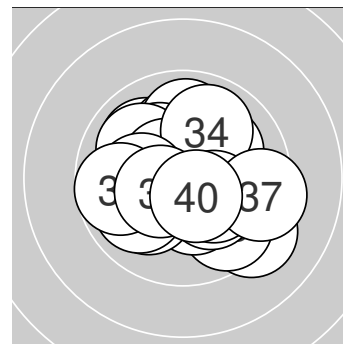

**Serie 1:**

10.3 *	10.5 *	10.6 *	9.3 ↘	10.0 ↘
10.6 *	10.3 *	10.5 *	10.1 ↑	9.6 →

beste Teiler: 92.7 (6.), 99.0 (3.), 111.0 (8.)  
 Trefferlage: 0.09 mm links, 0.17 mm tief  
 Streuwert: 1.65, horizontal: 1.88, vertikal: 1.38

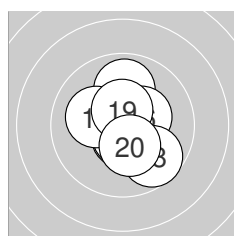

**Serie 2:**

9.9 ↑	10.7 *	10.6 *	10.7 *	10.6 *
10.4 *	10.1 ←	9.7 ↘	10.5 *	10.3 *

beste Teiler: 66.4 (12.), 72.0 (14.), 79.0 (15.)  
 Trefferlage: 0.17 mm rechts, 0.07 mm tief  
 Streuwert: 1.26, horizontal: 1.07, vertikal: 1.42

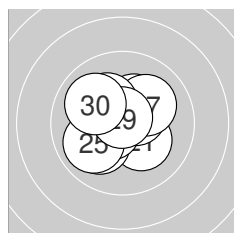

**Serie 3:**

10.2 *	10.1 ↙	10.5 *	10.5 *	9.9 ↙
10.3 *	10.1 ↗	10.2 *	10.8 *	10.0 ↘

beste Teiler: 41.4 (29.), 101.5 (23.), 112.8 (24.)  
 Trefferlage: 0.30 mm links, 0.19 mm hoch  
 Streuwert: 1.34, horizontal: 1.44, vertikal: 1.23

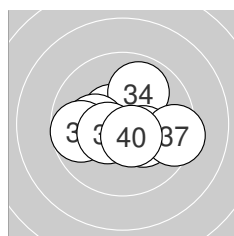

**Serie 4:**

10.6 *	10.5 *	10.5 *	9.9 ↗	10.1 ←
10.3 *	9.4 →	9.7 ←	10.4 *	10.5 *

beste Teiler: 100.8 (31.), 102.9 (33.), 108.8 (40.)  
 Trefferlage: 0.00 mm, 0.02 mm hoch  
 Streuwert: 1.57, horizontal: 1.97, vertikal: 1.03



**Ergebnis:** **376** (391.8)  
**Serien:** 96 92 94 94  
**Zähler:** 17 22 1 0 0 0 0 0 0 0  
**Innenzehner:** 11  
**Weiteste:** 697 (3.), 500 (29.), 493 (12.)  
**beste Teiler:** 42.9 (9.), 50.0 (30.), 66.2 (13.)  
**Trefferlage:** 0.44 mm rechts, 0.56 mm hoch  
**Streuwert:** 2.28, horizontal: 2.73, vertikal: 1.70

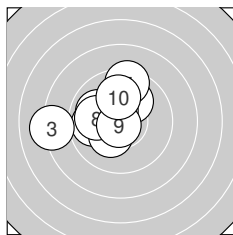
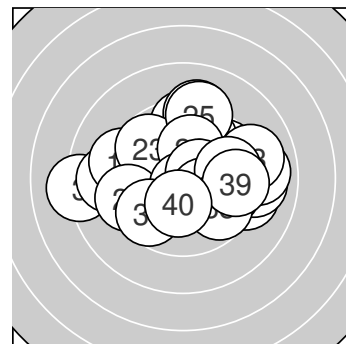

**Serie 1:**

10.0 ↖	9.9 ←	8.2 ←	10.0 ↗	10.5 *
10.3 *	9.4 ↑	10.0 ←	10.8 *	10.0 ↑

**beste Teiler:** 42.9 (9.), 112.7 (5.), 172.0 (6.)  
**Trefferlage:** 1.45 mm links, 0.78 mm hoch  
**Streuwert:** 2.00, horizontal: 2.32, vertikal: 1.61

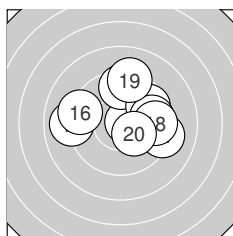

**Serie 2:**

9.2 →	9.0 ←	10.7 *	9.5 ↑	9.7 ↗
9.3 ↖	9.7 →	9.6 →	9.2 ↑	10.3 *

**beste Teiler:** 66.2 (13.), 171.6 (20.), 320.4 (17.)  
**Trefferlage:** 0.75 mm rechts, 0.91 mm hoch  
**Streuwert:** 2.55, horizontal: 3.09, vertikal: 1.85

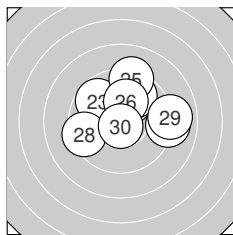

**Serie 3:**

10.5 *	10.1 ↗	9.7 ↘	9.8 ↗	9.2 ↑
10.1 ↑	9.0 →	9.4 ←	9.0 →	10.8 *

**beste Teiler:** 50.0 (30.), 122.4 (21.), 206.9 (26.)  
**Trefferlage:** 0.73 mm rechts, 1.21 mm hoch  
**Streuwert:** 2.25, horizontal: 2.70, vertikal: 1.68

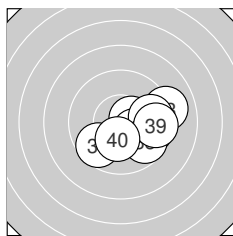

**Serie 4:**

9.7 →	10.4 *	9.1 →	10.5 *	10.3 *
9.7 ↙	9.7 →	9.7 ↘	9.5 →	10.3 *

**beste Teiler:** 113.2 (34.), 130.1 (32.), 165.8 (35.)  
**Trefferlage:** 1.74 mm rechts, 0.66 mm tief  
**Streuwert:** 1.65, horizontal: 2.01, vertikal: 1.17



Ergebnis: **392** (410.7)  
 Serien: 99 97 98 98  
 Zähler: 32 8 0 0 0 0 0 0 0 0  
 Innenzehner: 28  
 Weitest: 436 (21.), 341 (11.), 315 (10.)  
 beste Teiler: 16.4 (28.), 48.7 (9.), 62.1 (30.)  
 Trefferlage: 0.40 mm rechts, 0.29 mm hoch  
 Streuwert: 1.32, horizontal: 1.41, vertikal: 1.21

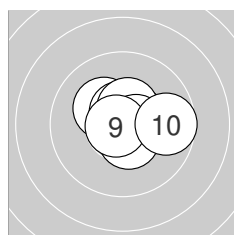
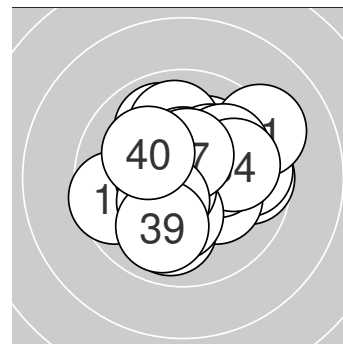

**Serie 1:**  
 10.2 \*                      10.7 \*                      10.5 \*                      10.6 \*                      10.5 \*  
 10.6 \*                      10.6 \*                      10.5 \*                      10.8 \*                      9.7 →  
 beste Teiler: 48.7 (9.), 68.5 (2.), 79.6 (6.)  
 Trefferlage: 0.52 mm rechts, 0.18 mm hoch  
 Streuwert: 0.96, horizontal: 1.17, vertikal: 0.70

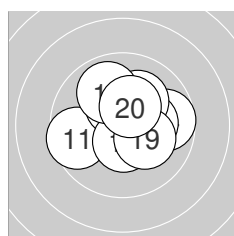

**Serie 2:**  
 9.6 ←                      10.3 \*                      10.3 \*                      9.7 →                      10.2 \*  
 10.5 \*                      10.1 ↗                      9.9 ↘                      10.2 \*                      10.4 \*  
 beste Teiler: 116.2 (16.), 145.7 (20.), 152.7 (12.)  
 Trefferlage: 0.45 mm rechts, 0.55 mm hoch  
 Streuwert: 1.53, horizontal: 1.77, vertikal: 1.25

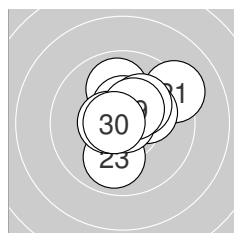

**Serie 3:**  
 9.2 ↗                      10.0 ↑                      9.9 ↓                      10.5 \*                      10.5 \*  
 10.2 \*                      10.2 \*                      10.9 \*                      10.4 \*                      10.7 \*  
 beste Teiler: 16.4 (28.), 62.1 (30.), 103.1 (25.)  
 Trefferlage: 0.50 mm rechts, 0.68 mm hoch  
 Streuwert: 1.42, horizontal: 1.44, vertikal: 1.40

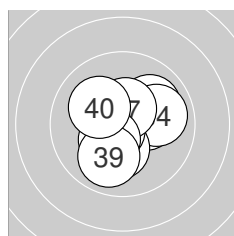

**Serie 4:**  
 10.0 ↗                      10.3 \*                      10.4 \*                      9.9 →                      10.2 \*  
 10.6 \*                      10.5 \*                      10.4 \*                      9.9 ↓                      10.1 ↘  
 beste Teiler: 76.6 (36.), 113.9 (37.), 140.1 (33.)  
 Trefferlage: 0.13 mm rechts, 0.23 mm tief  
 Streuwert: 1.38, horizontal: 1.41, vertikal: 1.34



**Ergebnis: 363 (383.7)**  
**Serien: 90 91 90 92**  
**Zähler: 11 23 4 2 0 0 0 0 0 0**  
**Innenzehner: 6**  
**Weiteste: 779 (5.), 760 (28.), 720 (8.)**  
**beste Teiler: 71.5 (26.), 81.2 (12.), 123.3 (3.)**  
**Trefferlage: 0.53 mm rechts, 0.43 mm hoch**  
**Streuwert: 2.67, horizontal: 3.51, vertikal: 1.36**

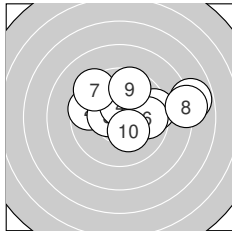
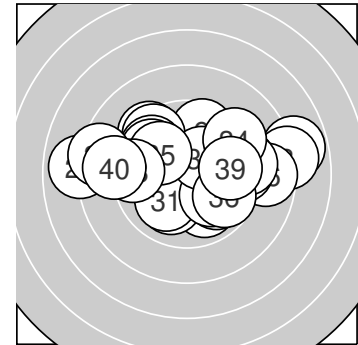

**Serie 1:**

9.4 →	9.6 ←	10.5 *	10.5 *	7.8 →
9.8 →	9.4 ↘	8.1 →	9.6 ↗	10.3 *

**beste Teiler: 123.3 (3.), 125.4 (4.), 171.1 (10.)**  
**Trefferlage: 1.62 mm rechts, 1.06 mm hoch**  
**Streuwert: 2.80, horizontal: 3.73, vertikal: 1.36**

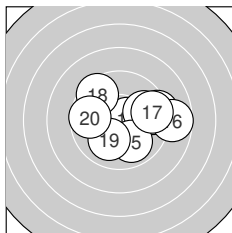

**Serie 2:**

9.5 →	10.6 *	9.3 →	9.9 →	9.9 ↘
8.7 →	9.5 →	9.5 ↘	10.0 ↙	9.7 ←

**beste Teiler: 81.2 (12.), 232.7 (19.), 257.3 (15.)**  
**Trefferlage: 1.45 mm rechts, 0.23 mm hoch**  
**Streuwert: 2.31, horizontal: 2.92, vertikal: 1.46**

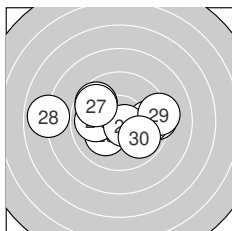

**Serie 3:**

9.4 →	9.7 ↘	10.1 ↙	9.9 ←	9.7 →
10.7 *	9.8 ↘	7.9 ←	9.3 →	9.9 ↘

**beste Teiler: 71.5 (26.), 206.5 (23.), 256.0 (24.)**  
**Trefferlage: 0.28 mm links, 0.14 mm hoch**  
**Streuwert: 2.76, horizontal: 3.72, vertikal: 1.17**

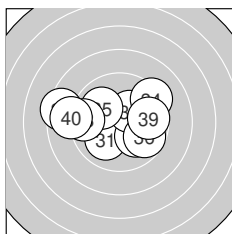

**Serie 4:**

10.0 ↙	10.0 ↘	10.3 *	9.3 ↗	10.0 ↘
9.7 ↘	8.4 ←	9.4 ←	9.7 →	8.9 ←

**beste Teiler: 154.9 (33.), 226.1 (32.), 232.3 (31.)**  
**Trefferlage: 0.67 mm links, 0.27 mm hoch**  
**Streuwert: 2.71, horizontal: 3.55, vertikal: 1.45**



Ergebnis: **384** (400.6)  
 Serien: 96 98 95 95  
 Zähler: 24 16 0 0 0 0 0 0 0 0  
 Innenzehner: 15  
 Weitestе: 477 (25.), 475 (39.), 470 (4.)  
 beste Teiler: 39.0 (15.), 60.9 (37.), 67.4 (38.)  
 Trefferlage: 0.44 mm rechts, 0.21 mm tief  
 Streuwert: 1.87, horizontal: 2.20, vertikal: 1.48

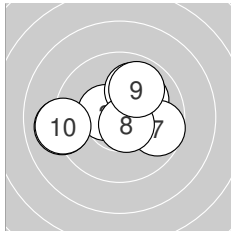
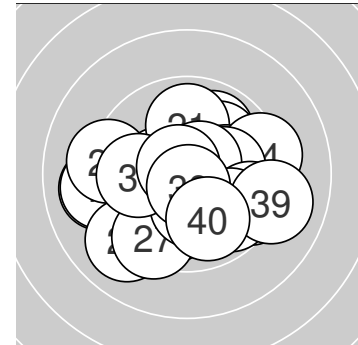

**Serie 1:**

10.6 *	10.5 *	10.1 ↗	9.1 ←	10.0 ↗
10.1 ↗	9.7 →	10.6 *	9.9 ↗	9.1 ←

beste Teiler: 79.9 (8.), 95.8 (1.), 120.1 (2.)  
 Trefferlage: 0.05 mm links, 0.53 mm hoch  
 Streuwert: 2.04, horizontal: 2.62, vertikal: 1.22

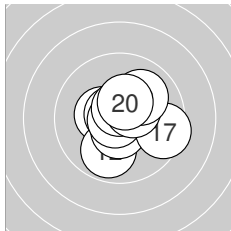

**Serie 2:**

10.4 *	9.9 ↓	10.5 *	10.7 *	10.8 *
10.6 *	9.5 →	10.4 *	10.0 ↗	10.4 *

beste Teiler: 39.0 (15.), 69.7 (14.), 79.0 (16.)  
 Trefferlage: 0.33 mm rechts, 0.03 mm hoch  
 Streuwert: 1.36, horizontal: 1.44, vertikal: 1.26

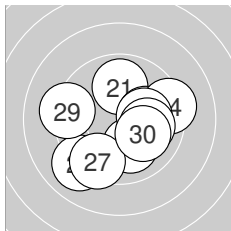

**Serie 3:**

9.9 ↑	10.1 →	10.0 ↓	9.3 →	9.0 ↙
10.2 *	9.4 ↙	10.0 →	9.2 ←	10.1 →

beste Teiler: 199.6 (26.), 212.7 (22.), 220.9 (30.)  
 Trefferlage: 0.37 mm rechts, 0.57 mm tief  
 Streuwert: 2.34, horizontal: 2.65, vertikal: 1.98

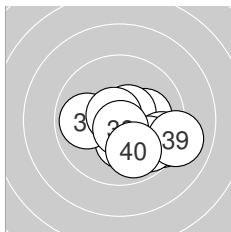

**Serie 4:**

10.1 →	10.6 *	10.3 *	9.5 →	9.7 ↘
9.9 ←	10.7 *	10.7 *	9.1 →	9.9 ↓

beste Teiler: 60.9 (37.), 67.4 (38.), 91.4 (32.)  
 Trefferlage: 1.13 mm rechts, 0.85 mm tief  
 Streuwert: 1.64, horizontal: 2.04, vertikal: 1.10





**Ergebnis:** **390** (407.5)  
**Serien:** 96 98 98 98  
**Zähler:** 30 10 0 0 0 0 0 0 0 0  
**Innenzehner:** 22  
**Weiteste:** 481 (2.), 351 (1.), 320 (9.)  
**beste Teiler:** 29.0 (17.), 45.1 (38.), 67.2 (8.)  
**Trefferlage:** 0.18 mm rechts, 0.07 mm hoch  
**Streuwert:** 1.50, horizontal: 1.71, vertikal: 1.26

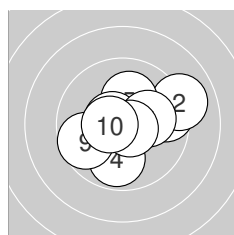
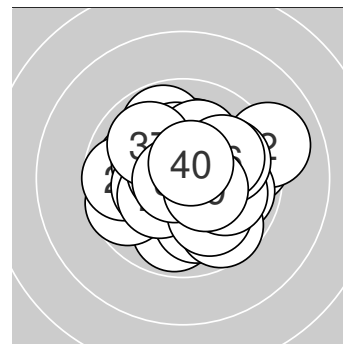

**Serie 1:**  
 9.5 →                      9.0 →                      10.4 \*                      9.9 ↓                      10.1 ↑  
 10.6 \*                      10.1 →                      10.7 \*                      9.7 ←                      10.5 \*  
**beste Teiler:** 67.2 (8.), 87.8 (6.), 102.0 (10.)  
**Trefferlage:** 0.69 mm rechts, 0.15 mm hoch  
**Streuwert:** 1.83, horizontal: 2.19, vertikal: 1.38

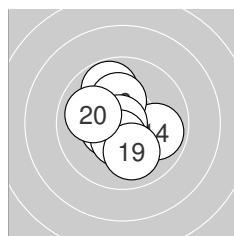

**Serie 2:**  
 10.3 \*                      10.5 \*                      10.5 \*                      9.9 →                      9.8 ↑  
 10.2 \*                      10.8 \*                      10.5 \*                      10.0 ↓                      10.0 ←  
**beste Teiler:** 29.0 (17.), 101.2 (12.), 117.9 (13.)  
**Trefferlage:** 0.24 mm links, 0.10 mm hoch  
**Streuwert:** 1.41, horizontal: 1.33, vertikal: 1.48

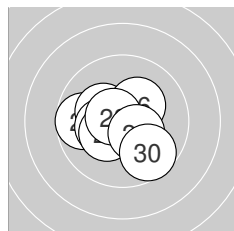

**Serie 3:**  
 10.3 \*                      9.7 ←                      10.3 \*                      10.3 \*                      10.5 \*  
 10.3 \*                      10.3 \*                      10.6 \*                      10.4 \*                      9.7 ↘  
**beste Teiler:** 80.0 (28.), 107.9 (25.), 143.9 (29.)  
**Trefferlage:** 0.64 mm links, 0.32 mm tief  
**Streuwert:** 1.33, horizontal: 1.58, vertikal: 1.04

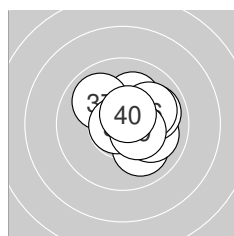

**Serie 4:**  
 10.0 ↘                      10.1 ↑                      10.0 →                      9.9 →                      10.4 \*  
 10.0 →                      9.9 ↘                      10.8 \*                      10.4 \*                      10.6 \*  
**beste Teiler:** 45.1 (38.), 89.4 (40.), 128.8 (35.)  
**Trefferlage:** 0.95 mm rechts, 0.34 mm hoch  
**Streuwert:** 1.24, horizontal: 1.29, vertikal: 1.19



**Ergebnis:** **392** (406.6)  
**Serien:** 99 96 97 100  
**Zähler:** 32 8 0 0 0 0 0 0 0 0  
**Innenzehner:** 25  
**Weiteste:** 444 (24.), 436 (18.), 378 (30.)  
**beste Teiler:** 46.6 (20.), 52.8 (1.), 56.0 (9.)  
**Trefferlage:** 0.02 mm links, 0.31 mm tief  
**Streuwert:** 1.55, horizontal: 1.74, vertikal: 1.33

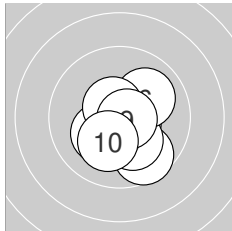
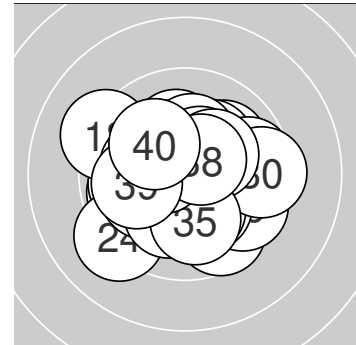

**Serie 1:**

10.7 *	10.4 *	9.6 ↘	10.6 *	10.2 *
10.0 ↗	10.2 *	10.6 *	10.7 *	10.2 *

**beste Teiler:** 52.8 (1.), 56.0 (9.), 90.1 (8.)  
**Trefferlage:** 0.36 mm rechts, 0.75 mm tief  
**Streuwert:** 1.17, horizontal: 1.09, vertikal: 1.24

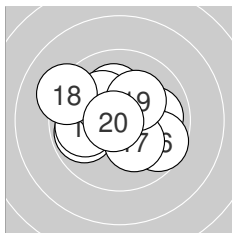

**Serie 2:**

9.8 ↙	10.2 *	10.0 →	9.9 ↖	10.2 *
9.7 ↘	10.2 *	9.2 ↖	10.2 *	10.8 *

**beste Teiler:** 46.6 (20.), 188.8 (19.), 190.5 (15.)  
**Trefferlage:** 0.35 mm links, 0.24 mm hoch  
**Streuwert:** 1.87, horizontal: 2.27, vertikal: 1.38

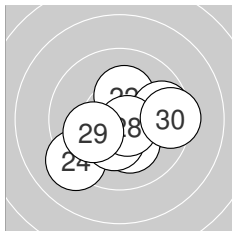

**Serie 3:**

10.4 *	10.2 *	10.3 *	9.2 ↙	10.2 *
9.7 →	10.3 *	10.6 *	10.1 ↖	9.4 →

**beste Teiler:** 76.5 (28.), 139.5 (21.), 158.0 (23.)  
**Trefferlage:** 0.39 mm rechts, 0.76 mm tief  
**Streuwert:** 1.76, horizontal: 2.10, vertikal: 1.35

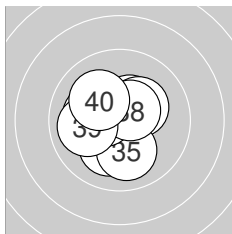

**Serie 4:**

10.4 *	10.1 ↙	10.7 *	10.3 *	10.0 ↓
10.2 *	10.5 *	10.5 *	10.0 ↖	10.1 ↘

**beste Teiler:** 68.0 (33.), 106.8 (38.), 117.6 (37.)  
**Trefferlage:** 0.50 mm links, 0.02 mm hoch  
**Streuwert:** 1.27, horizontal: 1.29, vertikal: 1.24



Ergebnis: **389** (406.9)  
 Serien: 97 99 96 97  
 Zähler: 30 9 1 0 0 0 0 0 0  
 Innenzehner: 27  
 Weitester: 650 (26.), 486 (9.), 393 (28.)  
 beste Teiler: 35.1 (16.), 35.3 (24.), 41.6 (3.)  
 Trefferlage: 0.12 mm rechts, 0.05 mm tief  
 Streuwert: 1.66, horizontal: 2.13, vertikal: 0.96

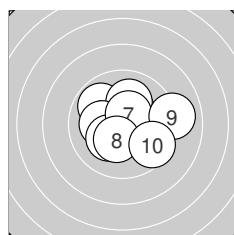
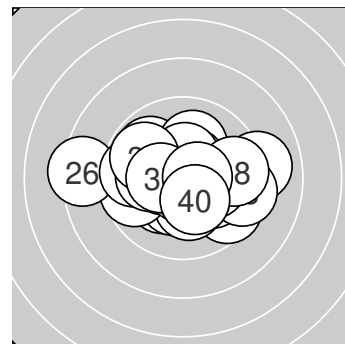

**Serie 1:**  
 10.3 \*                      9.9 ↘                      10.8 \*                      10.1 ↑                      10.2 \*  
 10.2 \*                      10.5 \*                      10.3 \*                      9.0 →                      9.6 ↘  
 beste Teiler: 41.6 (3.), 114.2 (7.), 157.0 (8.)  
 Trefferlage: 0.39 mm rechts, 0.26 mm hoch  
 Streuwert: 1.82, horizontal: 2.15, vertikal: 1.42

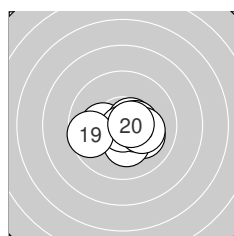

**Serie 2:**  
 10.3 \*                      10.2 \*                      10.6 \*                      10.1 ↘                      10.2 \*  
 10.8 \*                      10.5 \*                      10.2 \*                      9.7 ←                      10.6 \*  
 beste Teiler: 35.1 (16.), 81.4 (20.), 86.3 (13.)  
 Trefferlage: 0.31 mm rechts, 0.50 mm tief  
 Streuwert: 1.25, horizontal: 1.63, vertikal: 0.68

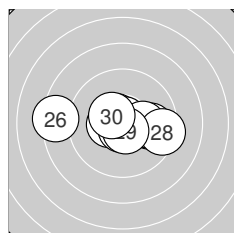

**Serie 3:**  
 10.4 \*                      10.7 \*                      10.6 \*                      10.8 \*                      9.9 →  
 8.4 ←                      10.2 \*                      9.4 →                      10.6 \*                      10.4 \*  
 beste Teiler: 35.3 (24.), 60.4 (22.), 78.5 (29.)  
 Trefferlage: 0.06 mm links, 0.05 mm tief  
 Streuwert: 2.03, horizontal: 2.81, vertikal: 0.57

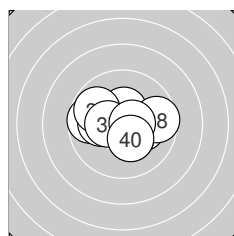

**Serie 4:**  
 10.2 \*                      10.4 \*                      10.3 \*                      9.7 ←                      10.1 ←  
 9.8 ↘                      10.4 \*                      9.6 →                      10.6 \*                      10.3 \*  
 beste Teiler: 93.3 (39.), 134.5 (32.), 143.0 (37.)  
 Trefferlage: 0.13 mm links, 0.06 mm hoch  
 Streuwert: 1.61, horizontal: 2.08, vertikal: 0.94



Ergebnis: **380** (399.6)  
 Serien: 94 95 95 96  
 Zähler: 22 16 2 0 0 0 0 0 0 0  
 Innenzehner: 20  
 Weitester: 634 (5.), 628 (7.), 462 (8.)  
 beste Teiler: 31.4 (10.), 56.7 (31.), 70.8 (36.)  
 Trefferlage: 0.30 mm rechts, 0.04 mm tief  
 Streuwert: 1.97, horizontal: 2.36, vertikal: 1.46

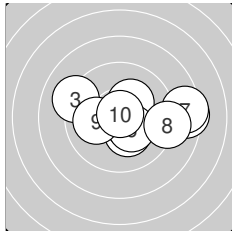
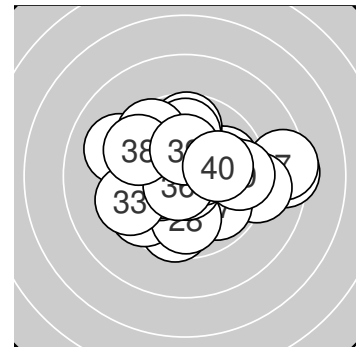

**Serie 1:**

10.3 *	10.5 *	9.1 ↖	10.3 *	8.4 →
10.3 *	8.4 →	9.1 →	10.1 ←	10.8 *

beste Teiler: 31.4 (10.), 113.7 (2.), 155.6 (6.)  
 Trefferlage: 1.46 mm rechts, 0.00 mm  
 Streuwert: 2.53, horizontal: 3.41, vertikal: 1.06

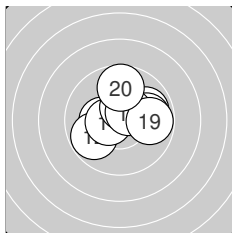

**Serie 2:**

10.3 *	9.8 ↙	10.4 *	10.5 *	10.4 *
9.9 →	9.9 →	10.5 *	9.8 →	9.7 ↑

beste Teiler: 106.2 (14.), 116.8 (18.), 129.5 (15.)  
 Trefferlage: 0.47 mm rechts, 0.58 mm hoch  
 Streuwert: 1.54, horizontal: 1.81, vertikal: 1.21

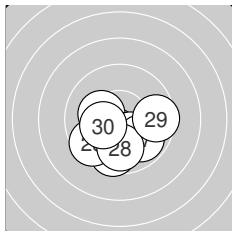

**Serie 3:**

9.6 ↓	10.4 *	9.6 ↙	10.2 *	10.3 *
10.2 *	9.9 ↘	9.9 ↓	9.6 →	10.3 *

beste Teiler: 127.4 (22.), 166.3 (25.), 167.3 (30.)  
 Trefferlage: 0.00 mm, 1.43 mm tief  
 Streuwert: 1.54, horizontal: 1.83, vertikal: 1.17

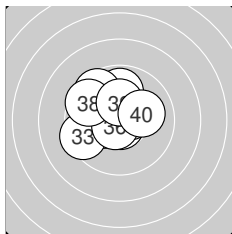

**Serie 4:**

10.7 *	10.3 *	9.4 ↙	10.5 *	9.9 ↑
10.7 *	9.6 ↘	9.6 ↘	10.3 *	10.1 →

beste Teiler: 56.7 (31.), 70.8 (36.), 105.6 (34.)  
 Trefferlage: 0.72 mm links, 0.66 mm hoch  
 Streuwert: 1.62, horizontal: 1.76, vertikal: 1.47



**Ergebnis:** **388** (406.1)  
**Serien:** 98 98 98 94  
**Zähler:** 29 10 1 0 0 0 0 0 0 0  
**Innenzehner:** 25  
**Weiteste:** 537 (34.), 460 (14.), 423 (33.)  
**beste Teiler:** 15.8 (7.), 20.6 (9.), 48.1 (12.)  
**Trefferlage:** 0.06 mm links, 0.48 mm hoch  
**Streuwert:** 1.65, horizontal: 2.11, vertikal: 1.01

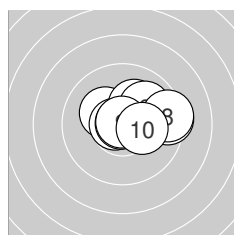
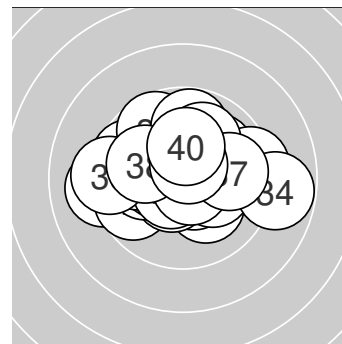

**Serie 1:**  
 10.2 \*                      10.4 \*                      10.7 \*                      9.4 →                      10.2 \*  
 10.0 ↗                      10.9 \*                      9.4 →                      10.9 \*                      10.3 \*  
**beste Teiler:** 15.8 (7.), 20.6 (9.), 65.0 (3.)  
**Trefferlage:** 1.12 mm rechts, 0.59 mm hoch  
**Streuwert:** 1.36, horizontal: 1.81, vertikal: 0.65

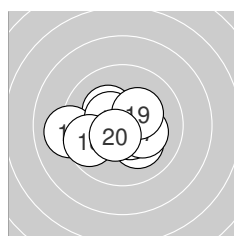

**Serie 2:**  
 10.2 \*                      10.8 \*                      10.3 \*                      9.1 ←                      10.6 \*  
 10.5 \*                      10.2 \*                      9.7 ↙                      10.3 \*                      10.5 \*  
**beste Teiler:** 48.1 (12.), 97.1 (15.), 108.0 (20.)  
**Trefferlage:** 0.54 mm links, 0.22 mm tief  
**Streuwert:** 1.58, horizontal: 2.00, vertikal: 0.98

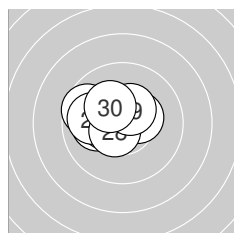

**Serie 3:**  
 10.1 ←                      10.2 \*                      10.7 \*                      10.4 \*                      9.6 ↖  
 9.9 ↖                      10.4 \*                      10.6 \*                      10.4 \*                      10.2 \*  
**beste Teiler:** 67.2 (23.), 95.4 (28.), 136.0 (29.)  
**Trefferlage:** 1.08 mm links, 0.49 mm hoch  
**Streuwert:** 1.11, horizontal: 1.43, vertikal: 0.66

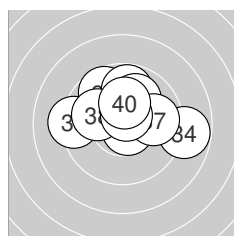

**Serie 4:**  
 10.7 \*                      9.7 ↘                      9.3 ←                      8.8 →                      9.8 ↑  
 10.0 ↗                      9.9 →                      10.0 ↖                      10.6 \*                      10.2 \*  
**beste Teiler:** 64.3 (31.), 83.7 (39.), 183.7 (40.)  
**Trefferlage:** 0.24 mm rechts, 1.05 mm hoch  
**Streuwert:** 2.07, horizontal: 2.62, vertikal: 1.29



Ergebnis: **388** (405.3)  
 Serien: 97 99 98 94  
 Zähler: 30 8 2 0 0 0 0 0 0  
 Innenzehner: 23  
 Weitester: 514 (37.), 512 (31.), 476 (10.)  
 beste Teiler: 46.0 (24.), 81.1 (9.), 82.0 (16.)  
 Trefferlage: 0.10 mm rechts, 0.40 mm hoch  
 Streuwert: 1.64, horizontal: 1.69, vertikal: 1.59

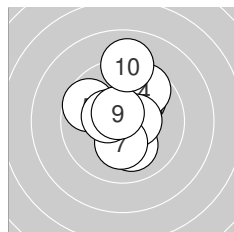
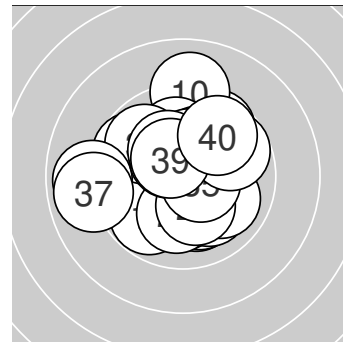

**Serie 1:**  
 10.0 ↗ 10.1 ↘ 10.4 \* 9.7 ↗ 9.7 ↖  
 10.5 \* 10.2 \* 10.4 \* 10.6 \* 9.0 ↑  
 beste Teiler: 81.1 (9.), 109.1 (6.), 132.8 (8.)  
 Trefferlage: 0.19 mm rechts, 0.89 mm hoch  
 Streuwert: 1.73, horizontal: 1.42, vertikal: 1.99

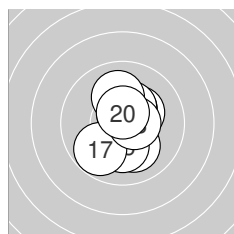

**Serie 2:**  
 10.3 \* 10.1 ↘ 10.4 \* 10.4 \* 10.2 \*  
 10.6 \* 9.8 ↙ 10.6 \* 10.1 ↑ 10.6 \*  
 beste Teiler: 82.0 (16.), 91.0 (20.), 100.0 (18.)  
 Trefferlage: 0.23 mm rechts, 0.13 mm hoch  
 Streuwert: 1.29, horizontal: 0.93, vertikal: 1.58

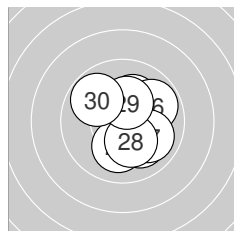

**Serie 3:**  
 10.3 \* 10.2 \* 10.0 ↘ 10.8 \* 10.1 ↓  
 9.8 ↗ 10.0 ↘ 10.2 \* 10.3 \* 9.8 ↖  
 beste Teiler: 46.0 (24.), 159.4 (21.), 160.0 (29.)  
 Trefferlage: 0.63 mm rechts, 0.15 mm tief  
 Streuwert: 1.48, horizontal: 1.31, vertikal: 1.64

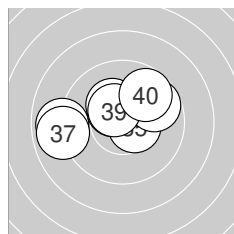

**Serie 4:**  
 8.9 ← 10.6 \* 10.4 \* 10.6 \* 10.5 \*  
 9.7 ↗ 8.9 ← 10.3 \* 10.5 \* 9.7 ↗  
 beste Teiler: 85.4 (34.), 100.1 (32.), 106.8 (35.)  
 Trefferlage: 0.64 mm links, 0.74 mm hoch  
 Streuwert: 1.97, horizontal: 2.62, vertikal: 0.97



Ergebnis: **382** (396.8)  
 Serien: 92 95 97 98  
 Zähler: 24 14 2 0 0 0 0 0 0 0  
 Innenzehner: 14  
 Weitester: 604 (17.), 531 (12.), 482 (27.)  
 beste Teiler: 6.0 (15.), 79.1 (30.), 85.0 (38.)  
 Trefferlage: 0.37 mm rechts, 0.54 mm hoch  
 Streuwert: 2.01, horizontal: 2.46, vertikal: 1.44

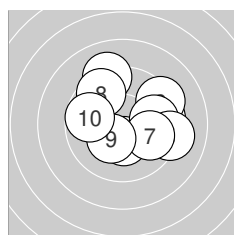
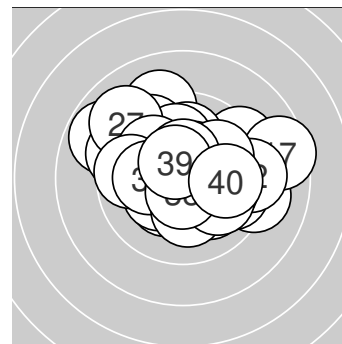

**Serie 1:**  
 9.5 →                      9.3 ↗                      10.3 \*                      9.8 →                      9.2 →  
 9.1 ↑                      9.9 ↘                      9.6 ↖                      10.3 \*                      9.7 ←  
 beste Teiler: 154.3 (3.), 166.4 (9.), 269.0 (7.)  
 Trefferlage: 0.93 mm rechts, 0.59 mm hoch  
 Streuwert: 2.35, horizontal: 2.67, vertikal: 1.96

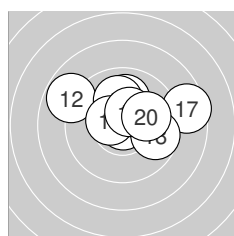

**Serie 2:**  
 10.0 ↑                      8.8 ↘                      10.0 ↑                      10.2 \*                      10.9 \*  
 10.5 \*                      8.5 →                      9.7 →                      10.4 \*                      10.0 →  
 beste Teiler: 6.0 (15.), 119.9 (16.), 135.9 (19.)  
 Trefferlage: 0.74 mm rechts, 1.10 mm hoch  
 Streuwert: 2.11, horizontal: 2.78, vertikal: 1.10

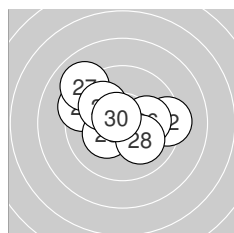

**Serie 3:**  
 10.4 \*                      9.3 →                      10.5 \*                      9.4 ↖                      10.3 \*  
 10.1 →                      9.0 ↖                      10.1 ↘                      10.0 ↖                      10.6 \*  
 beste Teiler: 79.1 (30.), 124.2 (23.), 131.5 (21.)  
 Trefferlage: 0.54 mm links, 0.56 mm hoch  
 Streuwert: 2.00, horizontal: 2.47, vertikal: 1.36

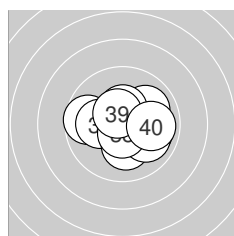

**Serie 4:**  
 10.0 →                      9.7 ←                      10.0 ↗                      10.1 ←                      10.2 \*  
 10.0 ↘                      10.4 \*                      10.6 \*                      10.5 \*                      9.9 →  
 beste Teiler: 85.0 (38.), 107.7 (39.), 134.0 (37.)  
 Trefferlage: 0.37 mm rechts, 0.08 mm tief  
 Streuwert: 1.58, horizontal: 1.95, vertikal: 1.10



Ergebnis: **384** (401.4)  
 Serien: 97 97 93 97  
 Zähler: 25 14 1 0 0 0 0 0 0 0  
 Innenzehner: 19  
 Weitestе: 585 (26.), 475 (38.), 437 (20.)  
 beste Teiler: 39.2 (27.), 52.0 (40.), 53.7 (13.)  
 Trefferlage: 0.38 mm rechts, 0.09 mm tief  
 Streuwert: 1.87, horizontal: 1.91, vertikal: 1.82

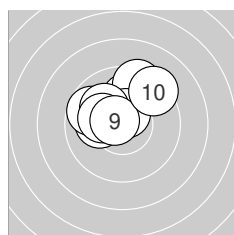
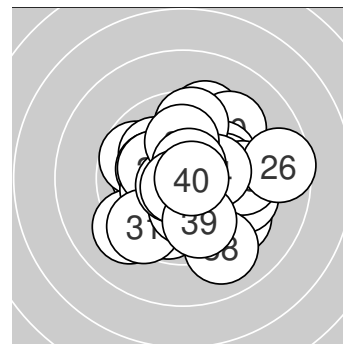

**Serie 1:**  
 10.2 \*                      10.1 ←                      10.0 ↑                      9.7 ↖                      9.4 ↑  
 10.5 \*                      10.1 ↘                      10.2 \*                      10.6 \*                      9.3 ↗  
 beste Teiler: 79.6 (9.), 103.1 (6.), 184.9 (1.)  
 Trefferlage: 0.40 mm links, 1.54 mm hoch  
 Streuwert: 1.48, horizontal: 1.74, vertikal: 1.17

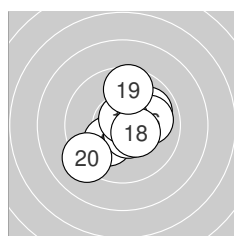

**Serie 2:**  
 10.5 \*                      9.9 ↗                      10.7 \*                      10.2 \*                      10.6 \*  
 10.0 →                      10.7 \*                      10.4 \*                      9.6 ↑                      9.2 ↙  
 beste Teiler: 53.7 (13.), 59.4 (17.), 90.6 (15.)  
 Trefferlage: 0.30 mm rechts, 0.02 mm tief  
 Streuwert: 1.66, horizontal: 1.67, vertikal: 1.66

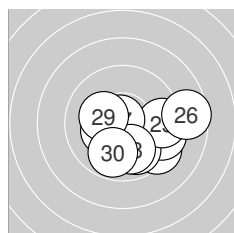

**Serie 3:**  
 9.4 ↘                      9.5 →                      9.9 ↓                      10.3 \*                      9.5 →  
 8.6 →                      10.8 \*                      10.0 ↓                      10.2 \*                      9.8 ↓  
 beste Teiler: 39.2 (27.), 170.6 (24.), 182.8 (29.)  
 Trefferlage: 1.36 mm rechts, 0.98 mm tief  
 Streuwert: 2.05, horizontal: 2.55, vertikal: 1.38

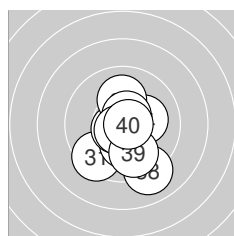

**Serie 4:**  
 9.4 ↙                      10.2 \*                      10.7 \*                      10.2 \*                      10.1 ↑  
 10.6 \*                      10.7 \*                      9.1 ↓                      9.8 ↓                      10.7 \*  
 beste Teiler: 52.0 (40.), 62.9 (37.), 75.4 (33.)  
 Trefferlage: 0.28 mm rechts, 0.90 mm tief  
 Streuwert: 1.65, horizontal: 1.32, vertikal: 1.93

