

Ergebnis: **391** (407.6)
 Serien: 95 98 98 100
 Zähler: 31 9 0 0 0 0 0 0 0 0
 Innenzehner: 23
 weiteste: 434 (4), 370 (10), 336 (5)
 beste Teiler 19.7 (40.) 34.8 (22.) 52.0 (21.)
 Trefferlage 0.42 mm rechts, 0.09 mm tief
 Streuwert 1.47, horizontal: 1.42, vertikal: 1.52

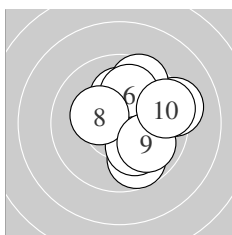

Serie 1:
 10.1 ↑ 9.7 ↓ 10.1 ↗ 9.2 → 9.6 ↗
 10.0 ↗ 10.1 ↓ 10.3 * 9.9 ↘ 9.5 →
 beste Teiler 165.2 (8.) 203.0 (1.) 210.7 (7.)
 Trefferlage 1.47 mm rechts, 0.52 mm hoch
 Streuwert 1.77, horizontal: 1.64, vertikal: 1.90

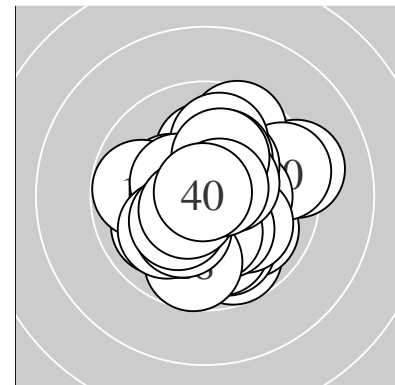
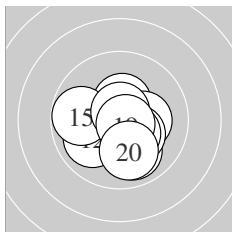

Serie 2:
 10.4 * 10.0 ↙ 9.9 ↓ 10.2 * 9.8 ←
 10.7 * 10.3 * 10.4 * 10.7 * 10.0 ↓
 beste Teiler 54.0 (19.) 65.1 (16.) 133.3 (11.)
 Trefferlage 0.13 mm rechts, 0.61 mm tief
 Streuwert 1.36, horizontal: 1.48, vertikal: 1.22

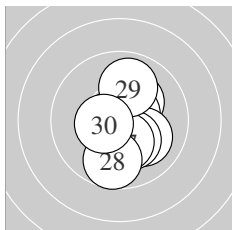

Serie 3:
 10.7 * 10.8 * 10.2 * 10.6 * 10.1 ↘
 10.2 * 10.3 * 9.7 ↓ 9.9 ↑ 10.5 *
 beste Teiler 34.8 (22.) 52.0 (21.) 98.1 (24.)
 Trefferlage 0.36 mm rechts, 0.31 mm tief
 Streuwert 1.31, horizontal: 0.91, vertikal: 1.61

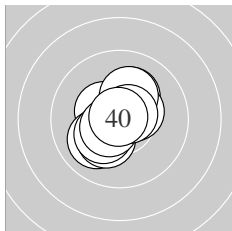

Serie 4:
 10.4 * 10.0 ↙ 10.2 * 10.4 * 10.2 *
 10.2 * 10.3 * 10.5 * 10.6 * 10.9 *
 beste Teiler 19.7 (40.) 76.1 (39.) 101.8 (38.)
 Trefferlage 0.27 mm links, 0.04 mm hoch
 Streuwert 1.14, horizontal: 1.05, vertikal: 1.21

Unterschrift des Schützen

Meyton Elektronik

Ergebnis: **383** (400.4)
 Serien: 94 94 96 99
 Zähler: 26 11 3 0 0 0 0 0 0 0
 Innenzehner: 19
 weiteste: 587 (18), 561 (7), 550 (24)
 beste Teiler 20.6 (10.) 58.0 (40.) 74.6 (37.)
 Trefferlage 0.24 mm rechts, 0.34 mm hoch
 Streuwert 1.91, horizontal: 2.30, vertikal: 1.43

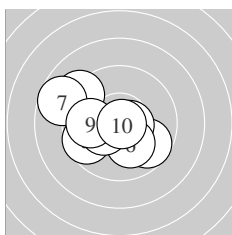
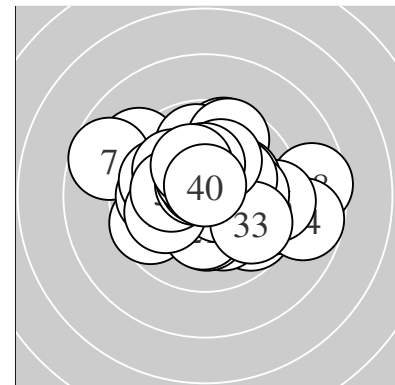

Serie 1:
 9.2 ↘ 10.0 ↘ 9.7 ↘ 10.6 * 9.6 ←
 10.1 ↘ 8.7 ↖ 10.3 * 9.9 ← 10.9 *
 beste Teiler 20.6 (10.) 91.5 (4.) 158.8 (8.)
 Trefferlage 0.95 mm links, 0.31 mm tief
 Streuwert 2.14, horizontal: 2.60, vertikal: 1.56

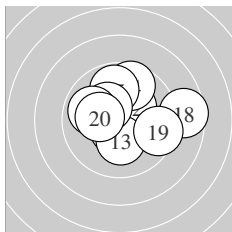

Serie 2:
 10.6 * 10.3 * 10.2 * 9.6 ↑ 9.8 ↑
 10.3 * 9.9 ↖ 8.6 → 9.5 → 10.2 *
 beste Teiler 98.8 (11.) 163.5 (16.) 164.1 (12.)
 Trefferlage 0.52 mm rechts, 0.63 mm hoch
 Streuwert 2.10, horizontal: 2.52, vertikal: 1.59

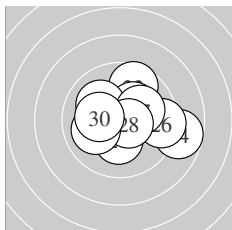

Serie 3:
 10.2 * 9.6 ↑ 10.3 * 8.8 → 10.1 ↘
 9.4 → 10.1 → 10.6 * 10.0 ← 10.2 *
 beste Teiler 87.3 (28.) 175.3 (23.) 178.2 (21.)
 Trefferlage 0.85 mm rechts, 0.24 mm hoch
 Streuwert 2.02, horizontal: 2.46, vertikal: 1.46

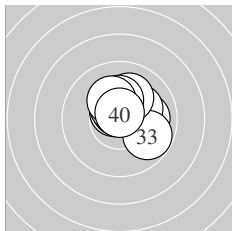

Serie 4:
 10.0 → 10.2 * 9.8 ↘ 10.1 ↑ 10.6 *
 10.3 * 10.7 * 10.5 * 10.2 * 10.7 *
 beste Teiler 58.0 (40.) 74.6 (37.) 81.4 (35.)
 Trefferlage 0.54 mm rechts, 0.80 mm hoch
 Streuwert 1.12, horizontal: 1.23, vertikal: 0.99

Unterschrift des Schützen

Meyton Elektronik

Ergebnis: **379** (393.5)
 Serien: 95 94 94 96
 Zähler: 20 19 1 0 0 0 0 0 0 0
 Innenzehner: 13
 weiteste: 607 (8), 489 (7), 477 (22)
 beste Teiler 103.5 (38.) 150.0 (3.) 155.2 (2.)
 Trefferlage 0.42 mm links, 0.30 mm hoch
 Streuwert 2.12, horizontal: 2.51, vertikal: 1.65

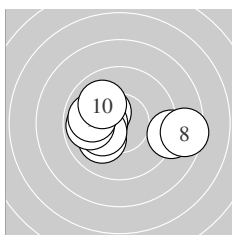
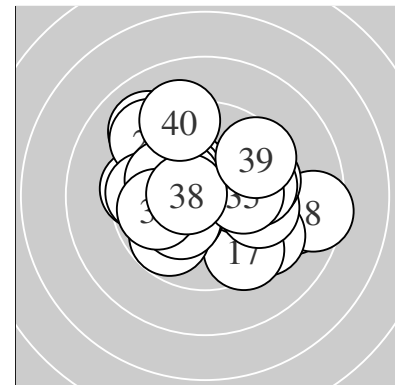

Serie 1:
 10.0 ← 10.3 * 10.4 * 10.1 ↗ 10.2 *
 9.9 ← 9.0 → 8.5 → 9.9 ← 10.0 ↘
 beste Teiler 150.0 (3.) 155.2 (2.) 176.2 (5.)
 Trefferlage 0.43 mm links, 0.11 mm tief
 Streuwert 2.32, horizontal: 3.13, vertikal: 0.99

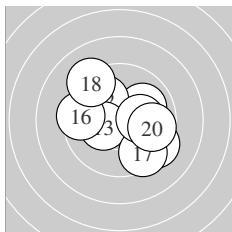

Serie 2:
 10.0 ↗ 10.0 ↘ 10.3 * 9.4 ↘ 9.4 ↘
 9.5 ← 9.5 ↘ 9.2 ↘ 10.2 * 9.7 →
 beste Teiler 159.4 (13.) 191.4 (19.) 237.4 (12.)
 Trefferlage 0.64 mm rechts, 0.15 mm tief
 Streuwert 2.35, horizontal: 2.64, vertikal: 2.03

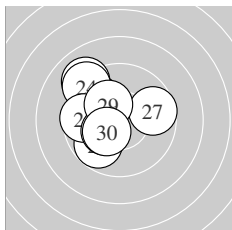

Serie 3:
 9.8 ↗ 9.0 ↘ 9.9 ↘ 9.2 ↘ 10.3 *
 9.6 ← 9.7 → 10.3 * 10.2 * 10.3 *
 beste Teiler 159.0 (25.) 160.1 (30.) 167.8 (28.)
 Trefferlage 1.54 mm links, 0.67 mm hoch
 Streuwert 1.85, horizontal: 1.83, vertikal: 1.86

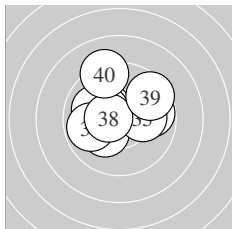

Serie 4:
 10.3 * 10.2 * 10.3 * 9.8 → 10.1 →
 10.0 ↘ 9.8 ← 10.5 * 9.5 ↗ 9.2 ↘
 beste Teiler 103.5 (38.) 161.8 (33.) 169.9 (31.)
 Trefferlage 0.34 mm links, 0.80 mm hoch
 Streuwert 1.84, horizontal: 2.11, vertikal: 1.53

Unterschrift des Schützen

Meyton Elektronik

Ergebnis: **381** (399.4)
 Serien: 94 98 95 94
 Zähler: 23 15 2 0 0 0 0 0 0 0
 Innenzehner: 19
 weiteste: 626 (28), 540 (36), 492 (27)
 beste Teiler 81.8 (20.) 89.3 (38.) 98.7 (2.)
 Trefferlage 0.07 mm rechts, 0.22 mm tief
 Streuwert 1.94, horizontal: 2.10, vertikal: 1.76

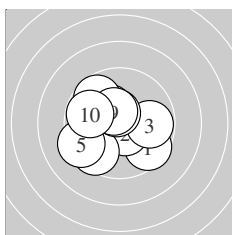
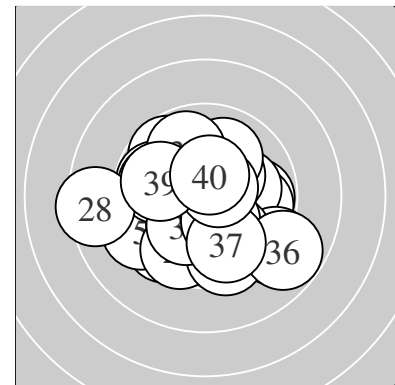

Serie 1:
 9.6 ↘ 10.6 * 9.8 → 9.5 ✓ 9.3 ←
 10.3 * 9.7 ↙ 10.6 * 10.5 * 9.8 ←
 beste Teiler 98.7 (2.) 99.7 (8.) 123.4 (9.)
 Trefferlage 0.65 mm links, 0.11 mm tief
 Streuwert 1.97, horizontal: 2.19, vertikal: 1.72

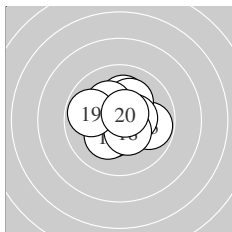

Serie 2:
 10.1 ↑ 10.4 * 9.8 → 10.2 * 10.2 *
 10.2 * 10.4 * 10.4 * 9.8 ← 10.6 *
 beste Teiler 81.8 (20.) 131.8 (18.) 136.4 (17.)
 Trefferlage 0.11 mm rechts, 0.23 mm hoch
 Streuwert 1.41, horizontal: 1.54, vertikal: 1.28

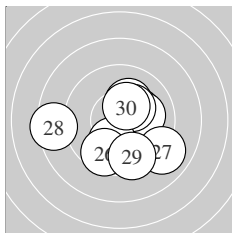

Serie 3:
 10.2 * 10.2 * 10.1 → 10.3 * 10.1 ✓
 9.6 ✓ 9.0 ↘ 8.4 ← 9.5 ↓ 10.4 *
 beste Teiler 146.2 (30.) 164.7 (24.) 184.2 (21.)
 Trefferlage 0.31 mm rechts, 0.65 mm tief
 Streuwert 2.40, horizontal: 2.74, vertikal: 2.00

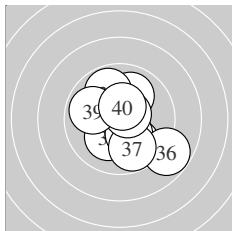

Serie 4:
 10.0 ↑ 9.8 ↖ 9.9 ↘ 10.2 * 10.3 *
 8.8 ↘ 9.8 ↓ 10.6 * 9.9 ← 10.5 *
 beste Teiler 89.3 (38.) 121.8 (40.) 166.2 (35.)
 Trefferlage 0.53 mm rechts, 0.38 mm tief
 Streuwert 1.98, horizontal: 1.88, vertikal: 2.07

Unterschrift des Schützen

Meyton Elektronik

Ergebnis: **373** (394.8)
 Serien: 93 95 93 92
 Zähler: 18 18 3 1 0 0 0 0 0 0
 Innenzehner: 16
 weiteste: 867 (37), 560 (5), 544 (30)
 beste Teiler 27.0 (9.) 33.2 (40.) 46.0 (22.)
 Trefferlage 0.37 mm rechts, 0.78 mm tief
 Streuwert 2.20, horizontal: 2.40, vertikal: 1.98

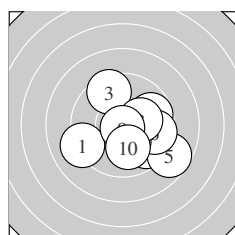
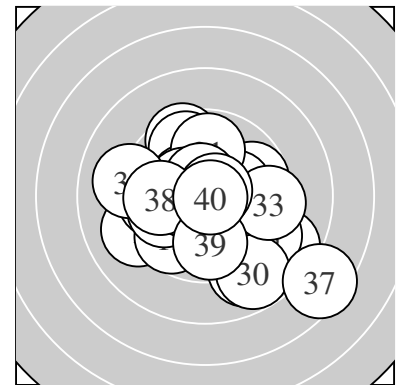

Serie 1:
 9.1 ↙ 9.7 ↘ 9.5 ↗ 9.7 → 8.7 ↘
 9.6 → 10.2 * 10.2 * 10.8 * 10.0 ↓
 beste Teiler 27.0 (9.) 177.2 (7.) 188.3 (8.)
 Trefferlage 1.07 mm rechts, 0.71 mm tief
 Streuwert 2.25, horizontal: 2.53, vertikal: 1.94

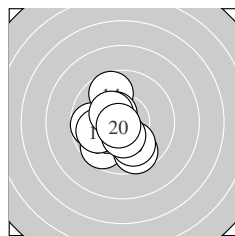

Serie 2:
 9.7 ← 9.7 ↙ 9.7 ↓ 9.7 ↗ 10.5 *
 9.9 ← 10.4 * 10.0 ↓ 10.4 * 10.7 *
 beste Teiler 55.3 (20.) 114.6 (15.) 136.2 (19.)
 Trefferlage 0.85 mm links, 0.59 mm tief
 Streuwert 1.62, horizontal: 1.43, vertikal: 1.79

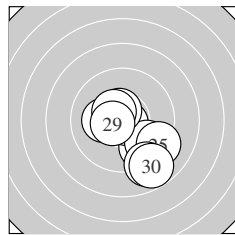

Serie 3:
 9.6 ↘ 10.8 * 9.6 ↘ 10.5 * 9.2 ↘
 10.2 * 8.9 ↓ 10.5 * 10.5 * 8.8 ↓
 beste Teiler 46.0 (22.) 101.1 (24.) 107.2 (29.)
 Trefferlage 0.94 mm rechts, 1.53 mm tief
 Streuwert 1.99, horizontal: 1.93, vertikal: 2.05

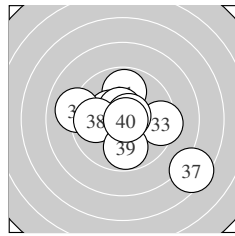

Serie 4:
 9.8 ↑ 10.4 * 9.4 → 9.1 ← 10.6 *
 10.7 * 7.5 ↘ 9.9 ← 9.8 ↓ 10.8 *
 beste Teiler 33.2 (40.) 69.3 (36.) 98.4 (35.)
 Trefferlage 0.34 mm rechts, 0.30 mm tief
 Streuwert 2.75, horizontal: 3.21, vertikal: 2.21

Unterschrift des Schützen

Meyton Elektronik

Ergebnis: **371** (390.9)
 Serien: 96 94 90 91
 Zähler: 17 18 4 1 0 0 0 0 0 0
 Innenzehner: 14
 weiteste: 768 (22), 632 (19), 547 (34)
 beste Teiler 68.9 (1.) 87.3 (21.) 118.2 (9.)
 Trefferlage 0.88 mm links, 0.73 mm hoch
 Streuwert 2.25, horizontal: 2.65, vertikal: 1.77

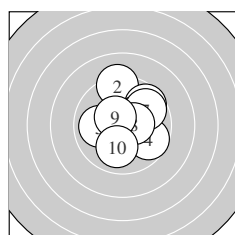
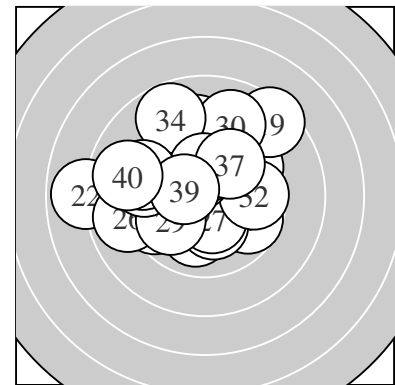

Serie 1:
 10.7 * 9.2 ↑ 9.6 ↗ 9.7 ↘ 10.0 ←
 10.4 * 9.8 ↗ 10.5 * 10.5 * 10.0 ↓
 beste Teiler 68.9 (1.) 118.2 (9.) 120.0 (8.)
 Trefferlage 0.54 mm rechts, 0.66 mm hoch
 Streuwert 1.79, horizontal: 1.74, vertikal: 1.84

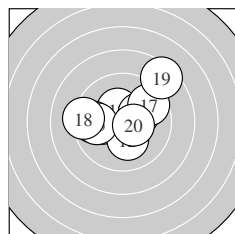

Serie 2:
 10.1 ← 10.2 * 10.4 * 9.7 ← 9.8 ←
 10.2 * 9.6 ↗ 9.3 ← 8.4 ↗ 10.5 *
 beste Teiler 120.3 (20.) 149.6 (13.) 193.0 (12.)
 Trefferlage 0.24 mm links, 0.68 mm hoch
 Streuwert 2.33, horizontal: 2.79, vertikal: 1.76

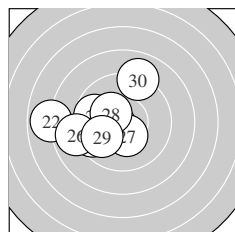

Serie 3:
 10.6 * 7.9 ← 9.4 ← 9.5 ← 9.7 ←
 8.9 ← 10.3 * 10.3 * 9.9 ← 9.0 ↑
 beste Teiler 87.3 (21.) 152.1 (27.) 156.2 (28.)
 Trefferlage 2.47 mm links, 0.07 mm tief
 Streuwert 2.33, horizontal: 2.70, vertikal: 1.89

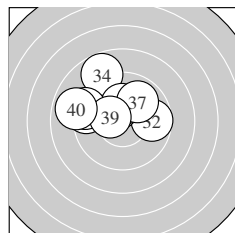

Serie 4:
 9.9 ↘ 9.7 → 10.4 * 8.8 ↘ 9.3 ←
 10.2 * 9.9 ↗ 9.3 ← 10.4 * 8.9 ←
 beste Teiler 140.7 (39.) 141.6 (33.) 179.2 (36.)
 Trefferlage 1.36 mm links, 1.64 mm hoch
 Streuwert 2.05, horizontal: 2.56, vertikal: 1.36

Unterschrift des Schützen

Meyton Elektronik

Ergebnis:	374	(391.4)
Serien:	95 94 93 92	
Zähler:	19 17 3 1 0 0 0 0 0 0	
Innenzehner:	12	
weiteste:	977 (31), 562 (12), 561 (40)	
beste Teiler	55.5 (33.) 55.7 (26.) 64.4 (11.)	
Trefferlage	0.76 mm rechts, 0.29 mm hoch	
Streuwert	2.37, horizontal: 2.77, vertikal: 1.88	

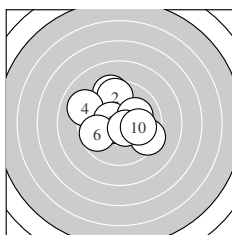
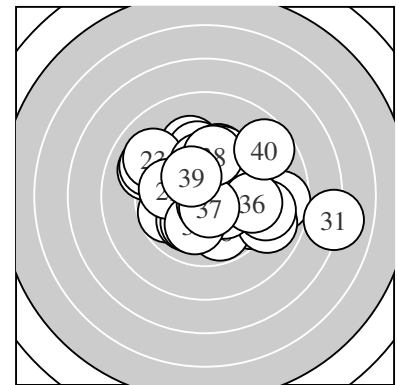

Serie 1:

9.4 ↑	9.6 ↑	10.6 *	9.1 ↖	10.5 *
9.7 ↙	9.4 ↘	10.1 ↗	10.6 *	10.0 →
beste Teiler	95.7 (9.)	98.0 (3.)	110.0 (5.)	
Trefferlage	0.22 mm links, 0.58 mm hoch			
Streuwert	2.13, horizontal: 2.37, vertikal: 1.87			

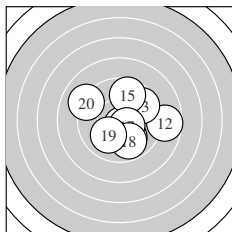

Serie 2:

10.7 *	8.7 →	9.6 ↗	10.2 *	9.6 ↑
10.0 ↓	10.5 *	9.8 ↓	10.0 ↙	9.1 ↖
beste Teiler	64.4 (11.)	114.0 (17.)	179.0 (14.)	
Trefferlage	0.72 mm rechts, 0.28 mm tief			
Streuwert	2.27, horizontal: 2.52, vertikal: 2.00			

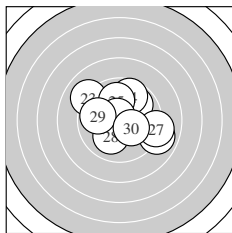

Serie 3:

9.9 ↗	8.9 ↘	9.0 ↖	9.7 ↑	10.0 ↑
10.7 *	9.1 →	10.1 ↙	9.9 ↖	10.3 *
beste Teiler	55.7 (26.)	173.3 (30.)	225.5 (28.)	
Trefferlage	0.54 mm rechts, 0.50 mm hoch			
Streuwert	2.40, horizontal: 2.79, vertikal: 1.94			

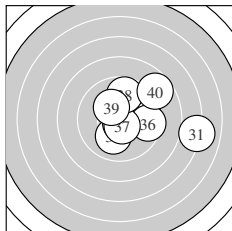

Serie 4:

7.0 →	10.1 ↓	10.7 *	10.4 *	9.7 →
9.5 →	10.6 *	9.7 ↑	10.2 *	8.7 ↗
beste Teiler	55.5 (33.)	90.4 (37.)	149.5 (34.)	
Trefferlage	2.03 mm rechts, 0.36 mm hoch			
Streuwert	2.66, horizontal: 3.24, vertikal: 1.91			

Unterschrift des Schützen

Meyton Elektronik

Ergebnis: **371** (391.8)
 Serien: 93 92 93 93
 Zähler: 18 17 4 0 1 0 0 0 0 0
 Innenzehner: 14
 weiteste: 1018 (13), 658 (30), 594 (22)
 beste Teiler 38.0 (40.) 65.0 (32.) 69.4 (3.)
 Trefferlage 0.23 mm links, 0.21 mm hoch
 Streuwert 2.47, horizontal: 2.36, vertikal: 2.58

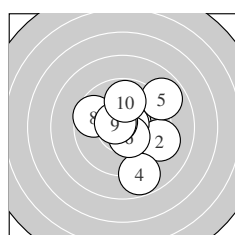
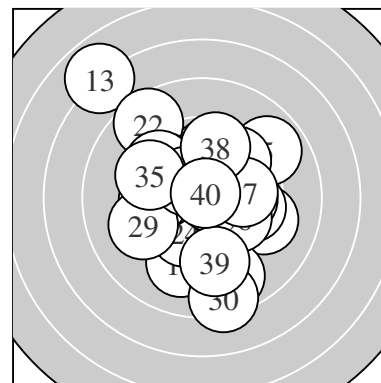

Serie 1:
 10.6 * 9.3 → 10.7 * 8.8 ↓ 8.9 ↗
 10.5 * 10.6 * 9.6 ← 10.6 * 9.8 ↑
 beste Teiler 69.4 (3.) 86.3 (7.) 90.4 (9.)
 Trefferlage 0.78 mm rechts, 0.13 mm hoch
 Streuwert 2.24, horizontal: 2.18, vertikal: 2.30

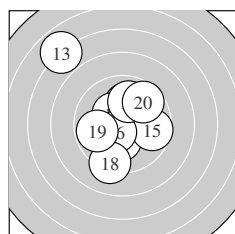

Serie 2:
 10.1 ↑ 10.2 * 6.9 ↘ 10.3 * 9.7 →
 10.5 * 10.0 ↑ 9.2 ↓ 9.8 ← 9.7 ↗
 beste Teiler 113.4 (16.) 154.3 (14.) 178.3 (12.)
 Trefferlage 0.63 mm links, 0.77 mm hoch
 Streuwert 2.98, horizontal: 2.72, vertikal: 3.22

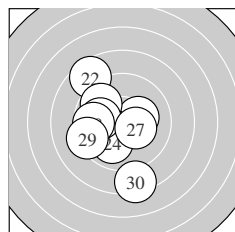

Serie 3:
 10.3 * 8.6 ↘ 10.2 * 10.0 ↓ 9.7 ↘
 10.0 ← 10.3 * 9.7 ← 9.3 ← 8.3 ↓
 beste Teiler 155.7 (27.) 175.8 (21.) 189.3 (23.)
 Trefferlage 1.36 mm links, 0.37 mm tief
 Streuwert 2.54, horizontal: 2.12, vertikal: 2.90

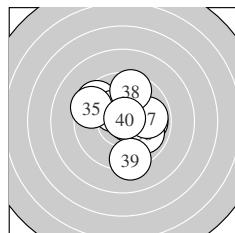

Serie 4:
 9.9 → 10.7 * 9.6 ↘ 10.4 * 9.5 ↘
 9.9 ↘ 9.9 → 9.6 ↑ 9.3 ↓ 10.8 *
 beste Teiler 38.0 (40.) 65.0 (32.) 144.4 (34.)
 Trefferlage 0.30 mm rechts, 0.32 mm hoch
 Streuwert 2.06, horizontal: 2.11, vertikal: 2.01

Unterschrift des Schützen

Meyton Elektronik

Ergebnis: **393** (407.4)
 Serien: 98 99 100 96
 Zähler: 33 7 0 0 0 0 0 0 0 0
 Innenzehner: 21
 weiteste: 379 (33), 355 (17), 351 (3)
 beste Teiler 62.6 (30.) 82.7 (7.) 93.0 (16.)
 Trefferlage 0.04 mm rechts, 0.08 mm hoch
 Streuwert 1.47, horizontal: 1.49, vertikal: 1.44

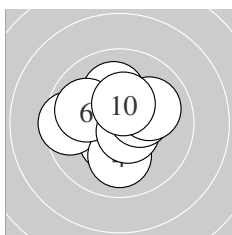
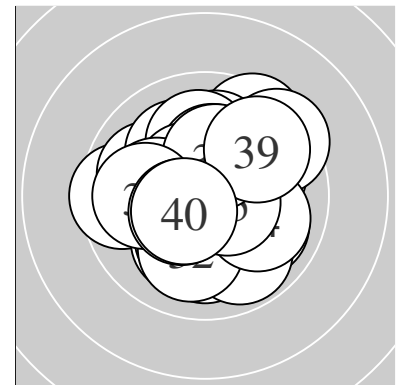

Serie 1:
 10.2 * 10.4 * 9.5 ← 10.0 ↓ 10.1 ↑
 9.9 ↖ 10.6 * 10.3 * 10.0 ↗ 10.4 *
 beste Teiler 82.7 (7.) 136.4 (2.) 138.6 (10.)
 Trefferlage 0.42 mm links, 0.25 mm hoch
 Streuwert 1.52, horizontal: 1.71, vertikal: 1.31

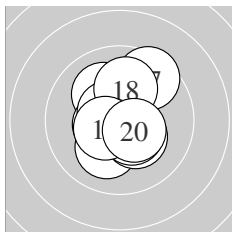

Serie 2:
 10.1 ↖ 10.5 * 10.1 ↙ 10.3 * 10.4 *
 10.6 * 9.5 ↗ 10.0 ↑ 10.5 * 10.5 *
 beste Teiler 93.0 (16.) 113.0 (12.) 115.9 (19.)
 Trefferlage 0.05 mm rechts, 0.19 mm hoch
 Streuwert 1.41, horizontal: 1.16, vertikal: 1.62

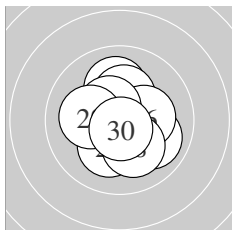

Serie 3:
 10.0 ↘ 10.2 * 10.4 * 10.1 ↑ 10.3 *
 10.3 * 10.5 * 10.1 ↘ 10.1 ← 10.7 *
 beste Teiler 62.6 (30.) 113.7 (27.) 137.2 (23.)
 Trefferlage 0.01 mm rechts, 0.03 mm hoch
 Streuwert 1.35, horizontal: 1.32, vertikal: 1.38

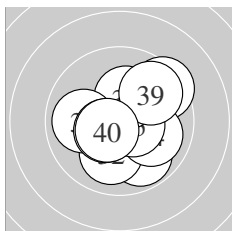

Serie 4:
 9.8 ↘ 10.0 ↓ 9.4 ↗ 10.0 ↘ 10.6 *
 10.3 * 9.9 ← 10.5 * 9.8 ↗ 10.5 *
 beste Teiler 99.0 (35.) 110.2 (40.) 120.9 (38.)
 Trefferlage 0.52 mm rechts, 0.12 mm tief
 Streuwert 1.70, horizontal: 1.76, vertikal: 1.63

Unterschrift des Schützen

Meyton Elektronik

Ergebnis: **393** (412.2)
 Serien: 98 99 99 97
 Zähler: 33 7 0 0 0 0 0 0 0 0
 Innenzehner: 27
 weiteste: 359 (3), 325 (8), 312 (40)
 beste Teiler 31.3 (26.) 33.9 (19.) 42.4 (39.)
 Trefferlage 0.28 mm rechts, 0.59 mm hoch
 Streuwert 1.24, horizontal: 1.27, vertikal: 1.20

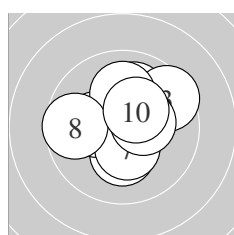
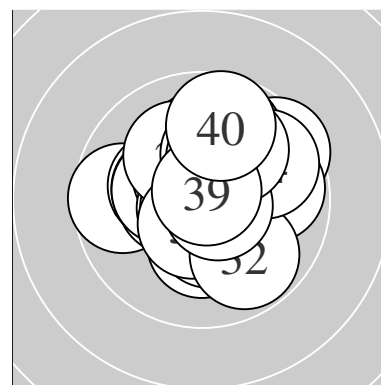

Serie 1:
 10.0 ↗ 10.2 * 9.5 ↘ 10.2 * 10.7 *
 10.1 ↑ 10.4 * 9.7 ← 10.4 * 10.4 *
 beste Teiler 63.2 (5.) 139.7 (7.) 143.6 (9.)
 Trefferlage 0.18 mm rechts, 0.54 mm hoch
 Streuwert 1.56, horizontal: 1.71, vertikal: 1.39

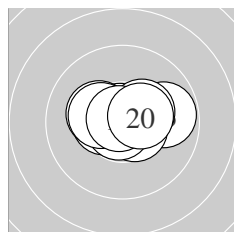

Serie 2:
 10.5 * 10.8 * 9.8 → 10.3 * 10.4 *
 10.6 * 10.8 * 10.3 * 10.8 * 10.4 *
 beste Teiler 33.9 (19.) 43.4 (17.) 45.1 (12.)
 Trefferlage 0.11 mm rechts, 0.24 mm hoch
 Streuwert 1.04, horizontal: 1.42, vertikal: 0.39

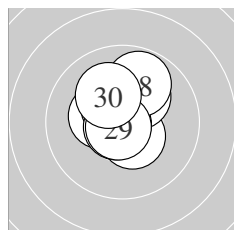

Serie 3:
 10.5 * 10.3 * 10.5 * 10.5 * 10.1 ↗
 10.8 * 10.7 * 9.8 ↑ 10.8 * 10.1 ↘
 beste Teiler 31.3 (26.) 44.6 (29.) 54.2 (27.)
 Trefferlage 0.07 mm links, 0.67 mm hoch
 Streuwert 1.01, horizontal: 0.86, vertikal: 1.14

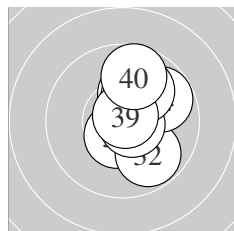

Serie 4:
 10.5 * 9.8 ↘ 10.1 ↗ 9.8 ↗ 10.2 *
 10.2 * 10.7 * 10.0 ↗ 10.8 * 9.7 ↑
 beste Teiler 42.4 (39.) 68.9 (37.) 105.4 (31.)
 Trefferlage 0.93 mm rechts, 0.89 mm hoch
 Streuwert 1.28, horizontal: 0.82, vertikal: 1.62

Unterschrift des Schützen

Meyton Elektronik

Ergebnis: **384** (403.5)
 Serien: 97 94 97 96
 Zähler: 25 14 1 0 0 0 0 0 0 0
 Innenzehner: 22
 weiteste: 501 (38), 438 (16), 411 (28)
 beste Teiler 25.1 (6.) 47.2 (15.) 70.7 (9.)
 Trefferlage 0.16 mm links, 0.16 mm hoch
 Streuwert 1.77, horizontal: 2.18, vertikal: 1.21

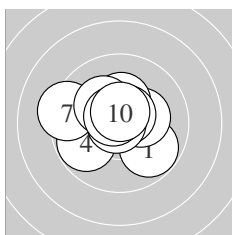
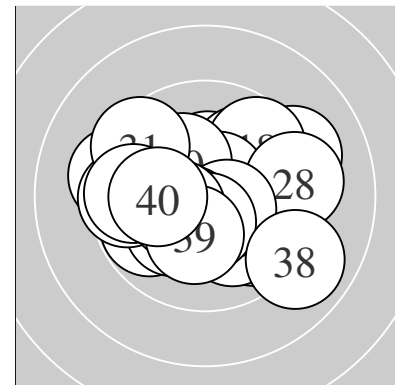

Serie 1:
 9.8 ↘ 10.3 * 10.3 * 9.8 ↙ 10.6 *
 10.9 * 9.3 ← 10.2 * 10.7 * 10.6 *
 beste Teiler 25.1 (6.) 70.7 (9.) 81.2 (5.)
 Trefferlage 0.39 mm links, 0.30 mm hoch
 Streuwert 1.52, horizontal: 1.83, vertikal: 1.12

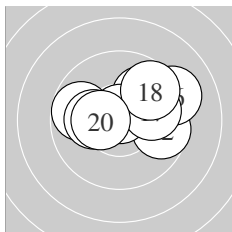

Serie 2:
 9.8 ← 9.7 → 9.5 ↗ 10.0 ↗ 10.8 *
 9.2 ↗ 9.9 → 9.7 ↗ 10.2 * 10.4 *
 beste Teiler 47.2 (15.) 144.0 (20.) 197.0 (19.)
 Trefferlage 1.04 mm rechts, 0.90 mm hoch
 Streuwert 1.86, horizontal: 2.44, vertikal: 0.99

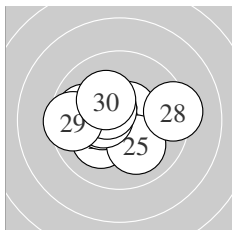

Serie 3:
 10.2 * 9.9 ← 10.6 * 10.4 * 10.1 ↘
 10.5 * 10.5 * 9.3 → 9.5 ← 10.2 *
 beste Teiler 89.3 (23.) 122.8 (26.) 124.1 (27.)
 Trefferlage 0.61 mm links, 0.09 mm hoch
 Streuwert 1.68, horizontal: 2.14, vertikal: 1.03

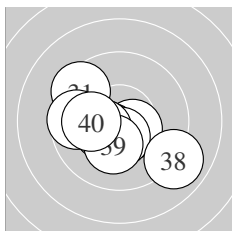

Serie 4:
 9.5 ↘ 10.5 * 10.5 * 9.6 ← 10.4 *
 10.5 * 10.4 * 8.9 ↘ 10.2 * 10.1 ←
 beste Teiler 114.8 (33.) 115.7 (32.) 119.2 (36.)
 Trefferlage 0.69 mm links, 0.62 mm tief
 Streuwert 1.78, horizontal: 2.13, vertikal: 1.33

Unterschrift des Schützen

Meyton Elektronik

Ergebnis: **389** (407.6)
 Serien: 98 100 97 94
 Zähler: 29 11 0 0 0 0 0 0 0 0
 Innenzehner: 23
 weiteste: 395 (22), 392 (35), 364 (7)
 beste Teiler 18.2 (4.) 30.0 (23.) 40.0 (20.)
 Trefferlage 0.04 mm rechts, 0.23 mm hoch
 Streuwert 1.54, horizontal: 1.78, vertikal: 1.27

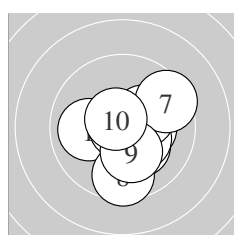
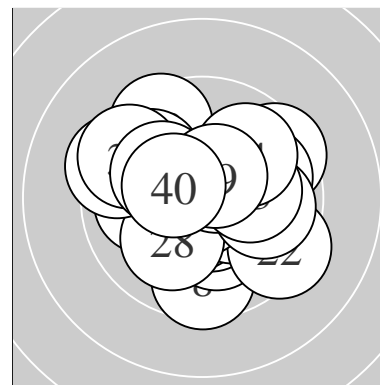

Serie 1:
 10.0 ← 10.3 * 10.2 * 10.9 * 10.3 *
 10.3 * 9.5 ↗ 9.6 ↓ 10.2 * 10.7 *
 beste Teiler 18.2 (4.) 75.9 (10.) 152.5 (5.)
 Trefferlage 0.63 mm rechts, 0.44 mm tief
 Streuwert 1.50, horizontal: 1.51, vertikal: 1.49

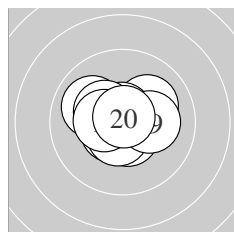

Serie 2:
 10.1 ↗ 10.5 * 10.0 ↖ 10.7 * 10.5 *
 10.6 * 10.3 * 10.4 * 10.2 * 10.8 *
 beste Teiler 40.0 (20.) 63.5 (14.) 97.1 (16.)
 Trefferlage 0.18 mm links, 0.16 mm hoch
 Streuwert 1.08, horizontal: 1.31, vertikal: 0.79

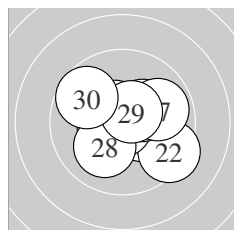

Serie 3:
 10.4 * 9.4 ↘ 10.8 * 10.3 * 10.5 *
 10.6 * 9.9 ↗ 10.1 ↙ 10.6 * 9.7 ↖
 beste Teiler 30.0 (23.) 95.2 (26.) 97.1 (29.)
 Trefferlage 0.37 mm rechts, 0.00 mm
 Streuwert 1.56, horizontal: 1.83, vertikal: 1.24

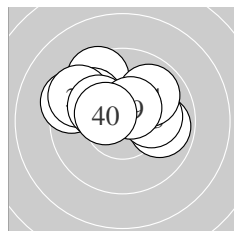

Serie 4:
 9.9 → 9.5 ↖ 10.1 → 9.9 ↗ 9.4 ↖
 9.9 ↖ 9.5 ↖ 10.1 ↖ 10.5 * 10.4 *
 beste Teiler 111.3 (39.) 134.3 (40.) 203.4 (38.)
 Trefferlage 0.65 mm links, 1.22 mm hoch
 Streuwert 1.76, horizontal: 2.29, vertikal: 0.97

Unterschrift des Schützen

Meyton Elektronik

Ergebnis: **377** (399.7)
 Serien: 98 92 93 94
 Zähler: 18 21 1 0 0 0 0 0 0 0
 Innenzehner: 17
 weiteste: 522 (16), 469 (25), 436 (13)
 beste Teiler 42.0 (10.) 70.0 (14.) 83.6 (7.)
 Trefferlage 0.51 mm rechts, 0.15 mm tief
 Streuwert 1.89, horizontal: 2.03, vertikal: 1.74

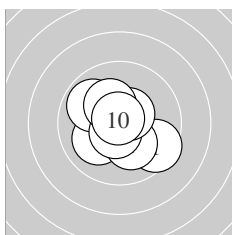
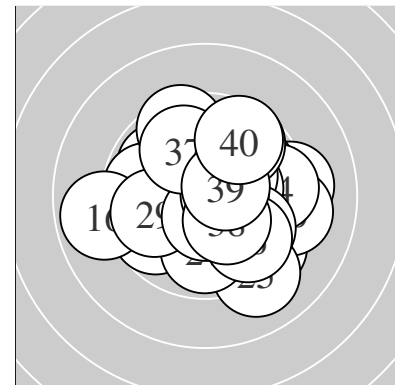

Serie 1:
 9.5 ↘ 10.6 * 10.1 ↙ 10.2 * 10.5 *
 9.9 ↖ 10.6 * 10.5 * 10.3 * 10.8 *
 beste Teiler 42.0 (10.) 83.6 (7.) 100.4 (2.)
 Trefferlage 0.21 mm links, 0.00 mm
 Streuwert 1.41, horizontal: 1.51, vertikal: 1.30

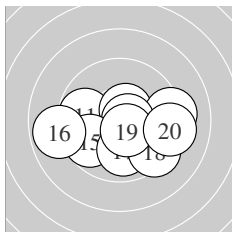

Serie 2:
 9.8 ← 10.6 * 9.2 → 10.7 * 9.7 ↗
 8.9 ← 9.9 ↓ 9.4 ↘ 10.5 * 9.2 →
 beste Teiler 70.0 (14.) 100.8 (12.) 105.4 (19.)
 Trefferlage 0.31 mm rechts, 0.76 mm tief
 Streuwert 2.37, horizontal: 3.11, vertikal: 1.24

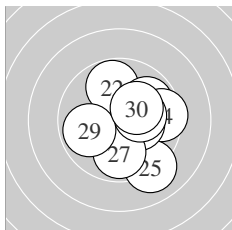

Serie 3:
 9.9 ↓ 9.8 ↑ 9.9 ↗ 9.5 → 9.1 ↘
 10.3 * 9.9 ↓ 10.2 * 9.9 ← 10.2 *
 beste Teiler 161.8 (26.) 177.8 (30.) 178.3 (28.)
 Trefferlage 1.07 mm rechts, 0.42 mm tief
 Streuwert 1.94, horizontal: 1.77, vertikal: 2.10

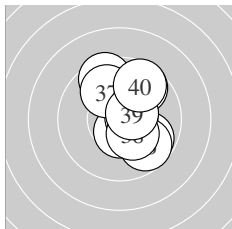

Serie 4:
 9.8 ↘ 10.5 * 9.5 ↑ 10.6 * 9.7 ↗
 9.7 ↘ 9.9 ↖ 10.3 * 10.5 * 9.6 ↗
 beste Teiler 100.3 (34.) 106.0 (32.) 115.8 (39.)
 Trefferlage 0.89 mm rechts, 0.57 mm hoch
 Streuwert 1.73, horizontal: 1.28, vertikal: 2.09

Unterschrift des Schützen

Ergebnis:	381	(399.5)								
Serien:	96	97	93	95						
Zähler:	24	14	1	1	0	0	0	0	0	0
Innenzehner:	17									
weiteste:	916 (36), 513 (14), 464 (25)									
beste Teiler	18.6 (35.)	27.0 (39.)	61.0 (22.)							
Trefferlage	0.38 mm rechts,	0.20 mm hoch								
Streuwert	2.04, horizontal: 2.62, vertikal: 1.22									

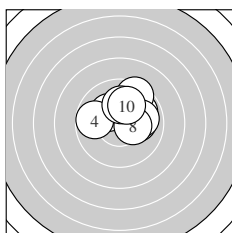
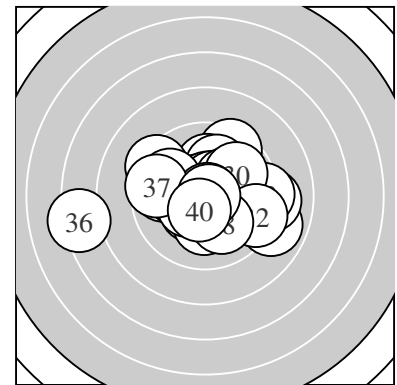

Serie 1:

9.9 ↗	10.2 *	10.1 →	9.8 ←	10.0 →
9.5 ↗	9.9 →	10.3 *	10.1 ↑	10.0 ↑
beste Teiler	161.0 (8.)	181.0 (2.)	213.0 (3.)	
Trefferlage	0.92 mm rechts, 1.15 mm hoch			
Streuwert	1.49, horizontal: 1.80, vertikal: 1.11			

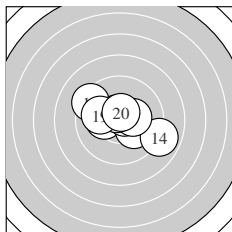

Serie 2:

10.4 *	10.2 *	10.1 ↘	8.9 ↘	9.3 ↘
10.7 *	10.3 *	10.6 *	10.0 ←	10.6 *
beste Teiler	67.2 (16.)	83.6 (18.)	93.3 (20.)	
Trefferlage	0.23 mm rechts, 0.18 mm hoch			
Streuwert	1.85, horizontal: 2.36, vertikal: 1.13			

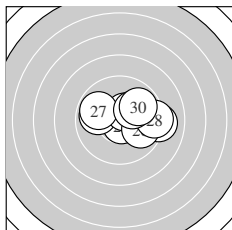

Serie 3:

9.7 →	10.7 *	9.9 ←	10.5 *	9.1 →
9.9 ↘	9.9 ↖	9.3 →	10.2 *	9.9 ↗
beste Teiler	61.0 (22.)	113.0 (24.)	195.0 (29.)	
Trefferlage	1.37 mm rechts, 0.38 mm hoch			
Streuwert	1.86, horizontal: 2.48, vertikal: 0.86			

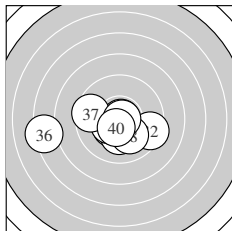

Serie 4:

10.4 *	9.4 ↘	10.2 *	10.4 *	10.9 *
7.3 ←	9.5 ←	10.1 ↘	10.8 *	10.5 *
beste Teiler	18.6 (35.)	27.0 (39.)	109.0 (40.)	
Trefferlage	0.98 mm links, 0.89 mm tief			
Streuwert	2.45, horizontal: 3.34, vertikal: 0.92			

Unterschrift des Schützen

Meyton Elektronik

Ergebnis: **381** (395.5)
 Serien: 93 92 98 98
 Zähler: 25 11 4 0 0 0 0 0 0 0
 Innenzehner: 14
 weiteste: 660 (16), 621 (6), 507 (17)
 beste Teiler 37.3 (37.) 85.4 (36.) 142.1 (9.)
 Trefferlage 0.42 mm links, 0.17 mm hoch
 Streuwert 2.11, horizontal: 2.52, vertikal: 1.60

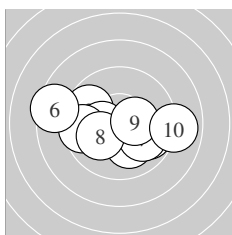
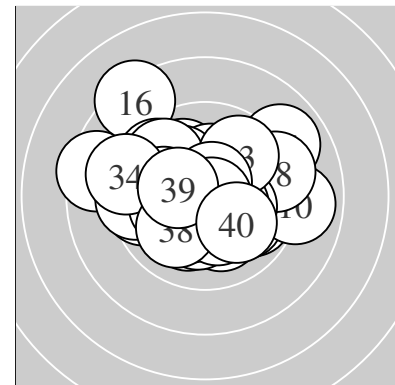

Serie 1:
 10.1 ↘ 9.7 ↖ 10.3 * 9.8 ↗ 9.6 ←
 8.5 ↖ 10.0 ↘ 10.1 ↙ 10.4 * 8.9 →
 beste Teiler 142.1 (9.) 163.4 (3.) 214.3 (8.)
 Trefferlage 0.36 mm links, 0.38 mm tief
 Streuwert 2.49, horizontal: 3.35, vertikal: 1.10

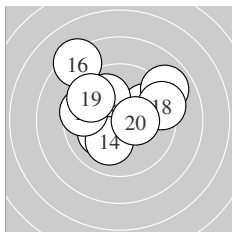

Serie 2:
 9.9 → 10.0 ↘ 10.1 ↙ 10.1 ↙ 9.6 ←
 8.3 ↘ 8.9 → 9.3 → 9.6 ↖ 10.4 *
 beste Teiler 147.1 (20.) 203.2 (13.) 215.1 (14.)
 Trefferlage 0.18 mm links, 1.24 mm hoch
 Streuwert 2.56, horizontal: 2.97, vertikal: 2.06

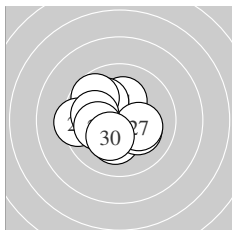

Serie 3:
 10.2 * 10.1 ↘ 9.7 ↖ 10.2 * 10.2 *
 9.4 ← 10.2 * 10.0 ← 10.1 ← 10.3 *
 beste Teiler 174.4 (30.) 181.6 (21.) 186.8 (27.)
 Trefferlage 0.94 mm links, 0.03 mm hoch
 Streuwert 1.63, horizontal: 1.82, vertikal: 1.41

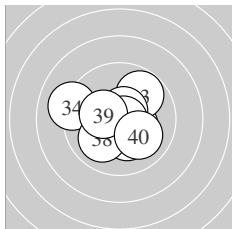

Serie 4:
 10.2 * 10.4 * 9.8 ↗ 9.1 ↖ 10.3 *
 10.6 * 10.8 * 10.0 ↙ 10.3 * 10.0 ↘
 beste Teiler 37.3 (37.) 85.4 (36.) 142.6 (32.)
 Trefferlage 0.23 mm links, 0.21 mm tief
 Streuwert 1.68, horizontal: 1.95, vertikal: 1.36

Unterschrift des Schützen

Meyton Elektronik

Ergebnis: **377** (395.3)
 Serien: 96 97 92 92
 Zähler: 20 17 3 0 0 0 0 0 0 0
 Innenzehner: 13
 weiteste: 700 (22), 647 (29), 544 (33)
 beste Teiler 63.2 (8.) 68.2 (21.) 108.4 (27.)
 Trefferlage 0.53 mm rechts, 0.29 mm hoch
 Streuwert 2.11, horizontal: 2.03, vertikal: 2.19

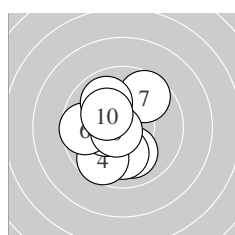
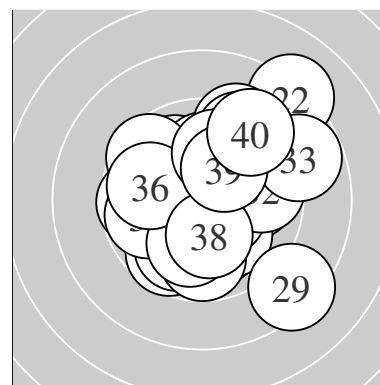

Serie 1:
 10.1 ↙ 10.0 ↓ 10.1 ↓ 9.7 ↘ 10.4 *
 9.7 ← 9.7 ↗ 10.7 * 9.9 ↘ 10.2 *
 beste Teiler 63.2 (8.) 144.5 (5.) 176.1 (10.)
 Trefferlage 0.87 mm links, 0.32 mm tief
 Streuwert 1.66, horizontal: 1.46, vertikal: 1.85

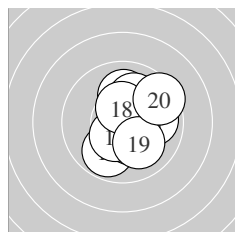

Serie 2:
 9.8 ↘ 10.3 * 10.4 * 9.9 → 10.0 ↑
 10.4 * 10.1 ↗ 10.4 * 10.1 ↓ 9.5 ↗
 beste Teiler 126.3 (18.) 131.1 (16.) 138.6 (13.)
 Trefferlage 0.79 mm rechts, 0.00 mm
 Streuwert 1.58, horizontal: 1.36, vertikal: 1.77

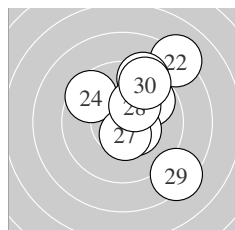

Serie 3:
 10.7 * 8.2 ↗ 9.8 ↗ 9.6 ↘ 9.3 ↑
 10.4 * 10.5 * 10.2 * 8.4 ↘ 9.4 ↑
 beste Teiler 68.2 (21.) 108.4 (27.) 127.7 (26.)
 Trefferlage 1.55 mm rechts, 1.16 mm hoch
 Streuwert 2.51, horizontal: 2.13, vertikal: 2.83

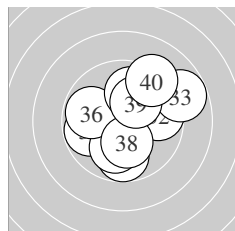

Serie 4:
 9.8 ↓ 9.7 → 8.8 ↗ 9.8 ← 10.0 ↓
 9.8 ← 9.9 ↑ 10.2 * 10.2 * 9.2 ↗
 beste Teiler 184.7 (38.) 199.4 (39.) 233.6 (35.)
 Trefferlage 0.66 mm rechts, 0.32 mm hoch
 Streuwert 2.32, horizontal: 2.44, vertikal: 2.19

Unterschrift des Schützen

Meyton Elektronik

Ergebnis: **387** (404.9)
 Serien: 96 97 98 96
 Zähler: 28 11 1 0 0 0 0 0 0 0
 Innenzehner: 20
 weiteste: 562 (9), 487 (35), 378 (23)
 beste Teiler 25.0 (18.) 28.4 (28.) 51.6 (12.)
 Trefferlage 0.37 mm rechts, 0.12 mm tief
 Streuwert 1.68, horizontal: 1.69, vertikal: 1.68

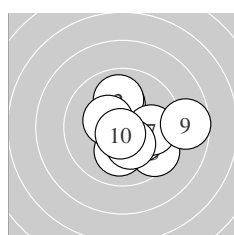
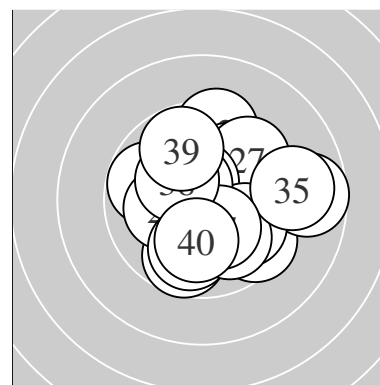

Serie 1:
 10.1 ↑ 10.0 ↑ 9.5 ↘ 10.1 ↓ 10.4 *
 10.2 * 9.9 → 10.3 * 8.7 → 10.7 *
 beste Teiler 62.2 (10.) 143.1 (5.) 165.5 (8.)
 Trefferlage 1.09 mm rechts, 0.21 mm tief
 Streuwert 1.85, horizontal: 2.09, vertikal: 1.58

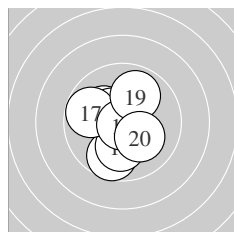

Serie 2:
 10.7 * 10.7 * 10.2 * 9.7 ↓ 10.1 ↓
 10.5 * 9.8 ← 10.9 * 9.9 ↑ 10.2 *
 beste Teiler 25.0 (18.) 51.6 (12.) 67.9 (11.)
 Trefferlage 0.32 mm links, 0.25 mm tief
 Streuwert 1.46, horizontal: 1.32, vertikal: 1.59

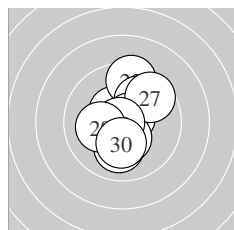

Serie 3:
 10.0 ↓ 10.5 * 9.4 ↑ 10.0 ↗ 10.7 *
 10.4 * 9.6 ↗ 10.8 * 10.2 * 10.2 *
 beste Teiler 28.4 (28.) 75.6 (25.) 121.5 (22.)
 Trefferlage 0.22 mm rechts, 0.31 mm hoch
 Streuwert 1.61, horizontal: 1.22, vertikal: 1.92

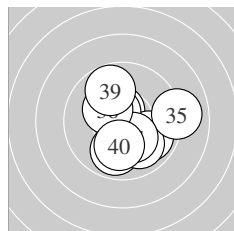

Serie 4:
 10.6 * 9.9 ↓ 9.9 ↘ 10.0 ↘ 9.0 →
 10.6 * 10.3 * 10.3 * 9.8 ↖ 10.1 ↓
 beste Teiler 97.8 (31.) 100.4 (36.) 170.8 (38.)
 Trefferlage 0.52 mm rechts, 0.34 mm tief
 Streuwert 1.85, horizontal: 1.91, vertikal: 1.79

Unterschrift des Schützen

Meyton Elektronik

Ergebnis: **395** (411.9)
 Serien: 100 99 98 98
 Zähler: 35 5 0 0 0 0 0 0 0 0
 Innenzehner: 27
 weiteste: 357 (17), 314 (30), 283 (37)
 beste Teiler 40.8 (35.) 42.2 (2.) 43.8 (28.)
 Trefferlage 0.00 mm , 0.11 mm hoch
 Streuwert 1.28, horizontal: 1.37, vertikal: 1.17

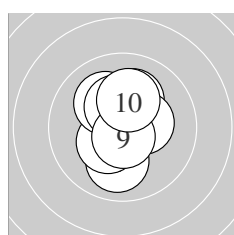
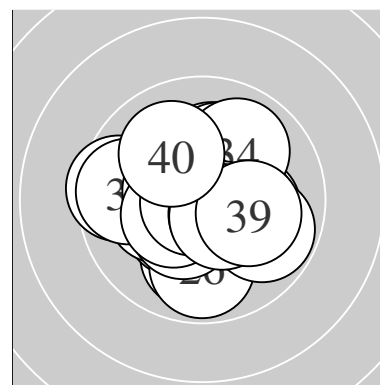

Serie 1:
 10.1 ↗ 10.8 * 10.4 * 10.0 ↓ 10.4 *
 10.1 ↘ 10.3 * 10.4 * 10.7 * 10.2 *
 beste Teiler 42.2 (2.) 67.2 (9.) 127.0 (3.)
 Trefferlage 0.04 mm links, 0.48 mm hoch
 Streuwert 1.17, horizontal: 0.79, vertikal: 1.45

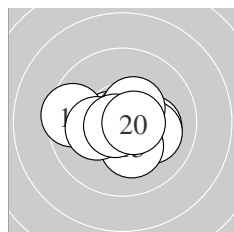

Serie 2:
 10.2 * 10.1 → 10.6 * 10.7 * 10.2 *
 10.5 * 9.5 ← 10.2 * 10.7 * 10.6 *
 beste Teiler 51.4 (14.) 58.1 (19.) 78.1 (20.)
 Trefferlage 0.02 mm links, 0.16 mm tief
 Streuwert 1.31, horizontal: 1.71, vertikal: 0.73

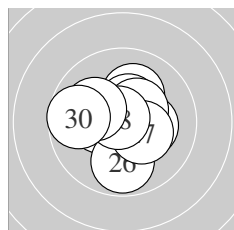

Serie 3:
 10.1 ↗ 10.5 * 10.3 * 10.4 * 10.3 *
 9.8 ↓ 10.3 * 10.8 * 10.1 ↖ 9.7 ←
 beste Teiler 43.8 (28.) 123.9 (22.) 132.5 (24.)
 Trefferlage 0.17 mm links, 0.18 mm hoch
 Streuwert 1.43, horizontal: 1.57, vertikal: 1.28

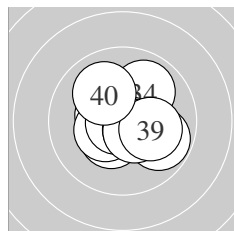

Serie 4:
 10.4 * 10.5 * 10.4 * 9.9 ↗ 10.8 *
 10.5 * 9.8 → 10.5 * 10.1 → 10.0 ↘
 beste Teiler 40.8 (35.) 101.6 (36.) 111.3 (38.)
 Trefferlage 0.28 mm rechts, 0.05 mm tief
 Streuwert 1.32, horizontal: 1.43, vertikal: 1.19

Unterschrift des Schützen

Meyton Elektronik

Ergebnis:	360	(376.8)
Serien:	91	89 88 92
Zähler:	10	21 8 1 0 0 0 0 0 0
Innenzehner:	4	
weiteste:	761	(27), 720 (16), 711 (2)
beste Teiler	42.1	(1.) 43.5 (38.) 45.1 (14.)
Trefferlage	0.48 mm	links, 2.17 mm hoch
Streuwert	2.58,	horizontal: 2.84, vertikal: 2.29

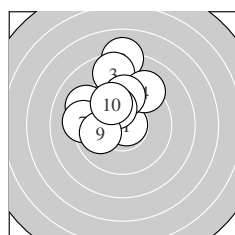
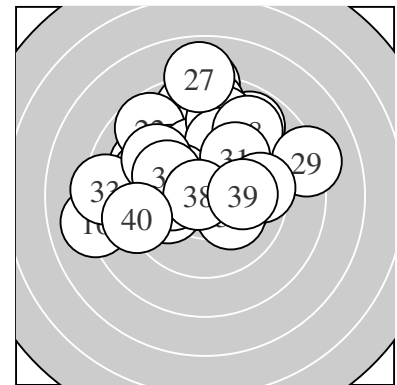

Serie 1:

10.8 *	8.1 ↑	8.7 ↑	9.2 ↗	9.7 ↑
9.2 ↖	9.3 ←	10.2 *	10.0 ←	9.9 ↘
beste Teiler	42.1 (1.)	195.7 (8.)	249.8 (9.)	
Trefferlage	1.04 mm	links, 2.51 mm	hoch	
Streuwert	2.24,	horizontal: 2.00,	vertikal: 2.45	

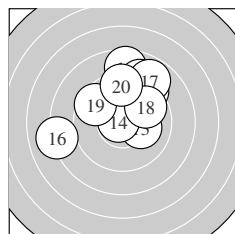

Serie 2:

8.6 ↑	9.0 ↗	10.1 →	10.8 *	9.3 ↗
8.1 ←	8.8 ↗	9.8 ↗	9.6 ↖	9.4 ↑
beste Teiler	45.1 (14.)	202.4 (13.)	294.0 (18.)	
Trefferlage	0.16 mm	rechts, 2.33 mm	hoch	
Streuwert	2.80,	horizontal: 3.10,	vertikal: 2.47	

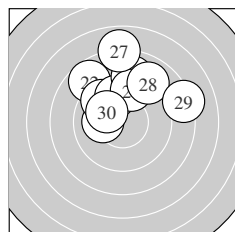

Serie 3:

10.1 ←	8.7 ↘	9.7 ↘	9.8 ↑	9.0 ↑
9.5 ↑	7.9 ↑	9.0 ↗	8.2 →	10.1 ↘
beste Teiler	201.6 (30.)	211.0 (21.)	283.8 (24.)	
Trefferlage	0.05 mm	rechts, 3.27 mm	hoch	
Streuwert	2.56,	horizontal: 2.93,	vertikal: 2.13	

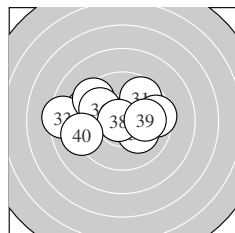

Serie 4:

9.7 ↗	9.4 ↖	8.4 ←	9.4 ↖	9.5 →
9.8 ↖	10.1 ↘	10.8 *	10.0 →	9.1 ←
beste Teiler	43.5 (38.)	202.8 (37.)	241.2 (39.)	
Trefferlage	1.09 mm	links, 0.59 mm	hoch	
Streuwert	2.56,	horizontal: 3.37,	vertikal: 1.30	

Unterschrift des Schützen

Meyton Elektronik

Ergebnis:	394	(414.2)			
Serien:	98	98	100	98	
Zähler:	34	6	0	0	0 0 0 0 0 0
Innenzehner:	30				
weiteste:	373 (17), 315 (39), 300 (7)				
beste Teiler	14.0 (12.) 23.3 (21.) 29.2 (18.)				
Trefferlage	0.09 mm rechts, 0.10 mm hoch				
Streuwert	1.23, horizontal: 1.25, vertikal: 1.21				

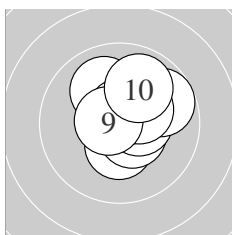
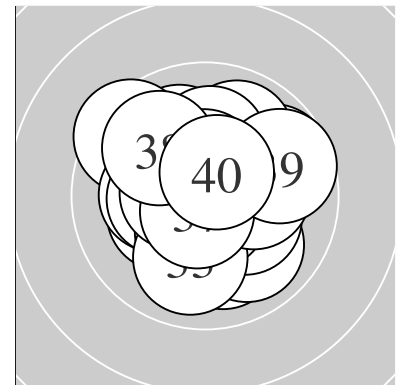

Serie 1:	10.4 *	10.5 *	10.5 *	10.0 ↖	10.4 *
	10.7 *	9.8 ↗	10.3 *	10.7 *	9.9 ↗
beste Teiler	73.1 (6.) 73.5 (9.) 108.5 (3.)				
Trefferlage	0.53 mm rechts, 0.66 mm hoch				
Streuwert	1.15, horizontal: 1.13, vertikal: 1.18				

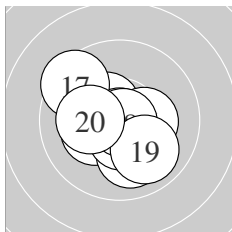

Serie 2:	10.5 *	10.9 *	10.3 *	10.0 ↓	10.3 *
	10.5 *	9.5 ↘	10.8 *	9.9 ↓	10.2 *
beste Teiler	14.0 (12.) 29.2 (18.) 103.9 (16.)				
Trefferlage	0.30 mm links, 0.30 mm tief				
Streuwert	1.41, horizontal: 1.51, vertikal: 1.31				

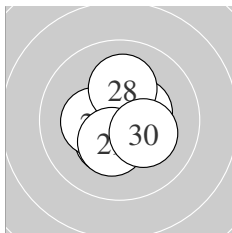

Serie 3:	10.9 *	10.7 *	10.4 *	10.7 *	10.4 *
	10.3 *	10.7 *	10.1 ↑	10.4 *	10.2 *
beste Teiler	23.3 (21.) 55.4 (24.) 72.5 (27.)				
Trefferlage	0.02 mm rechts, 0.19 mm tief				
Streuwert	0.98, horizontal: 0.92, vertikal: 1.03				

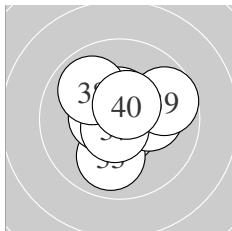

Serie 4:	10.7 *	10.6 *	10.0 ↓	10.5 *	10.5 *
	10.2 *	10.7 *	9.9 ↘	9.7 ↗	10.5 *
beste Teiler	67.5 (37.) 68.7 (31.) 85.9 (32.)				
Trefferlage	0.11 mm rechts, 0.24 mm hoch				
Streuwert	1.32, horizontal: 1.40, vertikal: 1.23				

Unterschrift des Schützen

Ergebnis: **389** (404.2)
 Serien: 97 98 96 98
 Zähler: 32 6 1 1 0 0 0 0 0 0
 Innenzehner: 23
 weiteste: 839 (21), 526 (14), 495 (22)
 beste Teiler 33.6 (20.) 35.5 (17.) 55.0 (40.)
 Trefferlage 0.01 mm rechts, 0.37 mm hoch
 Streuwert 1.84, horizontal: 2.22, vertikal: 1.36

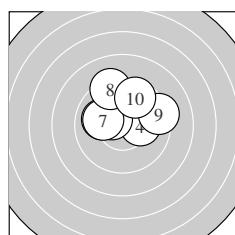
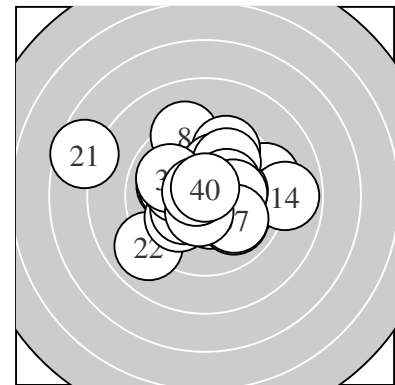

Serie 1:
 10.1 ↗ 10.4 * 10.0 ↗ 10.2 * 10.4 *
 10.0 ↖ 10.1 ↖ 9.3 ↖ 9.3 → 9.6 ↗
 beste Teiler 127.1 (2.) 133.3 (5.) 194.0 (4.)
 Trefferlage 0.45 mm rechts, 1.38 mm hoch
 Streuwert 1.70, horizontal: 2.06, vertikal: 1.24

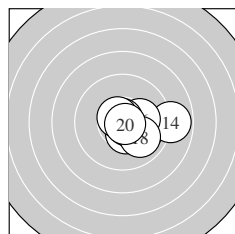

Serie 2:
 10.4 * 10.7 * 10.0 → 8.8 → 10.4 *
 10.2 * 10.8 * 10.0 ↘ 10.6 * 10.8 *
 beste Teiler 33.6 (20.) 35.5 (17.) 63.0 (12.)
 Trefferlage 1.32 mm rechts, 0.37 mm tief
 Streuwert 1.29, horizontal: 1.68, vertikal: 0.71

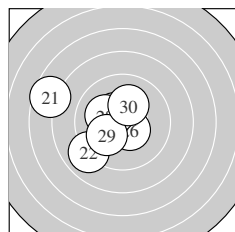

Serie 3:
 7.6 ↖ 9.0 ↙ 10.3 * 10.5 * 10.7 *
 10.5 * 10.4 * 10.1 ↖ 10.1 ↙ 10.2 *
 beste Teiler 62.6 (25.) 108.5 (24.) 117.4 (26.)
 Trefferlage 1.72 mm links, 0.26 mm hoch
 Streuwert 2.17, horizontal: 2.54, vertikal: 1.72

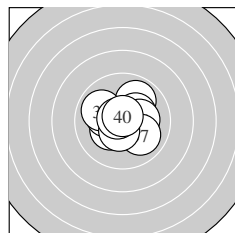

Serie 4:
 9.9 ↗ 10.3 * 10.3 * 10.2 * 9.9 ↖
 10.2 * 10.0 ↘ 10.5 * 10.7 * 10.7 *
 beste Teiler 55.0 (40.) 64.4 (39.) 112.6 (38.)
 Trefferlage 0.02 mm rechts, 0.21 mm hoch
 Streuwert 1.35, horizontal: 1.56, vertikal: 1.12

Unterschrift des Schützen

Ergebnis: **382** (400.2)
 Serien: 95 96 94 97
 Zähler: 22 18 0 0 0 0 0 0 0 0
 Innenzehner: 15
 weiteste: 383 (9), 382 (21), 370 (24)
 beste Teiler 82.3 (30.) 93.0 (35.) 117.4 (14.)
 Trefferlage 0.12 mm links, 0.61 mm hoch
 Streuwert 1.74, horizontal: 1.88, vertikal: 1.59

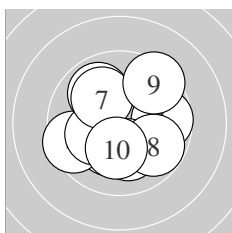
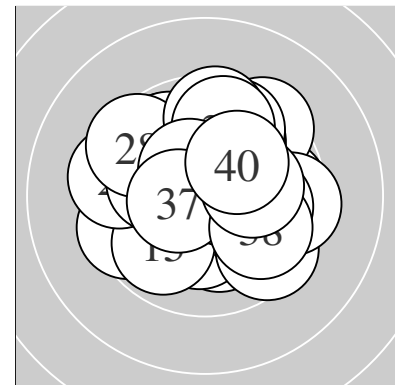

Serie 1:
 9.7 → 10.1 ↓ 10.2 * 9.5 ← 9.9 ↖
 10.2 * 10.1 ↖ 9.8 ↘ 9.4 ↗ 10.2 *
 beste Teiler 176.2 (3.) 182.5 (10.) 190.6 (6.)
 Trefferlage 0.02 mm links, 0.19 mm tief
 Streuwert 2.00, horizontal: 2.13, vertikal: 1.85

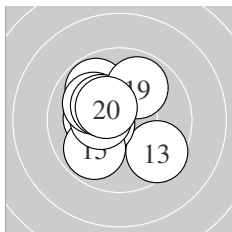

Serie 2:
 10.2 * 9.8 ↖ 9.5 ↘ 10.5 * 9.9 ↗
 10.4 * 10.0 ↖ 10.3 * 9.9 ↗ 10.4 *
 beste Teiler 117.4 (14.) 133.6 (20.) 137.5 (16.)
 Trefferlage 0.81 mm links, 0.34 mm hoch
 Streuwert 1.56, horizontal: 1.54, vertikal: 1.58

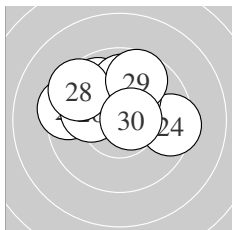

Serie 3:
 9.4 ← 10.3 * 9.8 ↖ 9.5 → 10.2 *
 10.1 ← 9.9 ↑ 9.5 ↖ 9.7 ↑ 10.6 *
 beste Teiler 82.3 (30.) 172.7 (22.) 184.8 (25.)
 Trefferlage 0.48 mm links, 1.39 mm hoch
 Streuwert 1.76, horizontal: 2.23, vertikal: 1.09

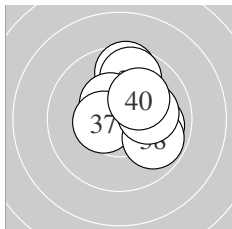

Serie 4:
 10.4 * 9.6 ↑ 9.7 ↑ 10.0 → 10.6 *
 10.4 * 10.5 * 9.8 ↘ 10.1 → 10.1 ↗
 beste Teiler 93.0 (35.) 118.0 (37.) 129.6 (36.)
 Trefferlage 0.83 mm rechts, 0.92 mm hoch
 Streuwert 1.38, horizontal: 1.27, vertikal: 1.49

Unterschrift des Schützen

Meyton Elektronik

Ergebnis: **379** (396.8)
 Serien: 96 90 96 97
 Zähler: 23 13 4 0 0 0 0 0 0 0
 Innenzehner: 15
 weiteste: 602 (6), 529 (13), 520 (19)
 beste Teiler 9.2 (27.) 48.1 (7.) 62.5 (31.)
 Trefferlage 0.66 mm links, 0.76 mm hoch
 Streuwert 2.02, horizontal: 2.36, vertikal: 1.62

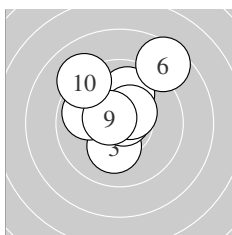
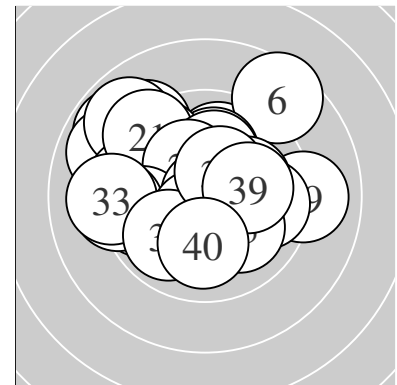

Serie 1:
 10.0 ↘ 10.5 * 10.2 * 9.9 ↘ 10.0 ↑
 8.5 ↗ 10.8 * 10.5 * 10.6 * 9.1 ↘
 beste Teiler 48.1 (7.) 94.4 (9.) 114.7 (2.)
 Trefferlage 0.34 mm links, 1.34 mm hoch
 Streuwert 1.90, horizontal: 1.94, vertikal: 1.85

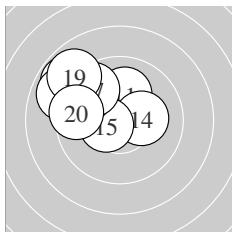

Serie 2:
 10.1 ↑ 9.8 ↘ 8.8 ↘ 10.2 * 10.5 *
 9.5 ↘ 9.6 ↘ 8.9 ↘ 8.9 ↘ 9.5 ←
 beste Teiler 116.7 (15.) 180.6 (14.) 217.1 (11.)
 Trefferlage 2.27 mm links, 1.72 mm hoch
 Streuwert 1.73, horizontal: 2.08, vertikal: 1.28

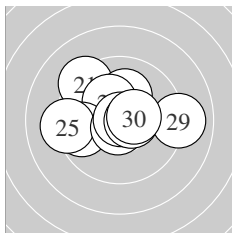

Serie 3:
 9.3 ↘ 10.1 ↑ 10.3 * 9.7 ← 9.2 ←
 10.7 * 10.9 * 10.6 * 9.0 → 10.5 *
 beste Teiler 9.2 (27.) 63.7 (26.) 96.2 (28.)
 Trefferlage 0.37 mm links, 0.48 mm hoch
 Streuwert 2.05, horizontal: 2.61, vertikal: 1.26

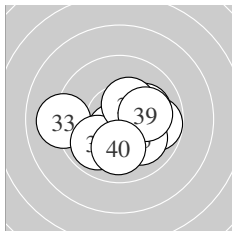

Serie 4:
 10.7 * 9.8 → 9.1 ← 10.5 * 10.0 ↘
 9.9 ↗ 10.1 → 10.4 * 10.1 → 10.0 ↓
 beste Teiler 62.5 (31.) 103.8 (34.) 140.9 (38.)
 Trefferlage 0.31 mm rechts, 0.51 mm tief
 Streuwert 1.78, horizontal: 2.23, vertikal: 1.16

Unterschrift des Schützen

Meyton Elektronik

Ergebnis: **372** (391.8)
 Serien: 94 87 96 95
 Zähler: 21 18 0 0 0 0 0 0 0 0
 Innenzehner: 19
 weiteste: 3708 (18), 487 (1), 410 (9)
 beste Teiler 38.1 (21.) 57.0 (3.) 72.9 (8.)
 Trefferlage 0.65 mm links, 1.63 mm hoch
 Streuwert 4.39, horizontal: 1.77, vertikal: 5.95

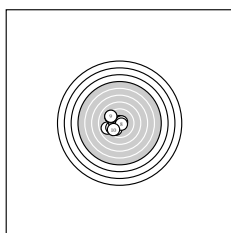
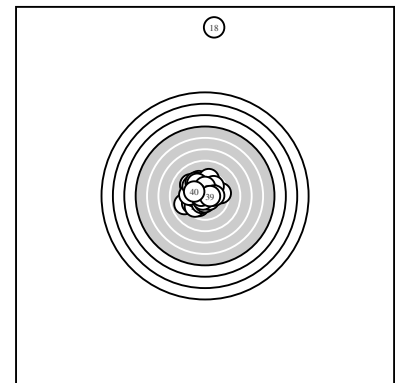

Serie 1:
 9.0 ↙ 9.9 ↘ 10.7 * 9.6 ↙ 10.2 *
 9.4 ↘ 10.6 * 10.7 * 9.3 ↘ 9.7 ↘
 beste Teiler 57.0 (3.) 72.9 (8.) 84.5 (7.)
 Trefferlage 1.79 mm links, 0.20 mm tief
 Streuwert 1.78, horizontal: 1.78, vertikal: 1.77

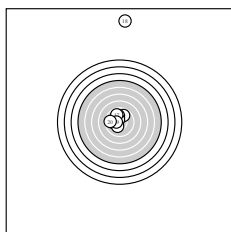

Serie 2:
 9.8 ↗ 10.0 ↑ 10.6 * 10.0 ← 10.5 *
 10.3 * 9.8 ↘ 0.0 ↑ 10.5 * 9.6 ←
 beste Teiler 79.0 (13.) 102.0 (15.) 120.0 (19.)
 Trefferlage 0.70 mm links, 4.41 mm hoch
 Streuwert 8.24, horizontal: 1.60, vertikal: 11.54

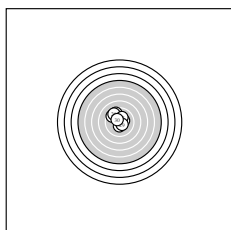

Serie 3:
 10.8 * 9.9 ↘ 10.3 * 9.5 ↘ 9.6 ↘
 9.5 ↘ 10.2 * 10.4 * 10.5 * 10.4 *
 beste Teiler 38.1 (21.) 121.0 (29.) 127.9 (30.)
 Trefferlage 0.50 mm links, 1.18 mm hoch
 Streuwert 1.47, horizontal: 1.39, vertikal: 1.55

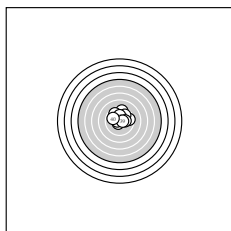

Serie 4:
 9.6 → 9.4 ↑ 10.6 * 9.8 ↗ 9.7 ↘
 10.6 * 10.2 * 10.2 * 10.5 * 9.9 ↖
 beste Teiler 86.0 (36.) 93.4 (33.) 108.0 (39.)
 Trefferlage 0.37 mm rechts, 1.13 mm hoch
 Streuwert 1.63, horizontal: 1.81, vertikal: 1.43

Unterschrift des Schützen

Meyton Elektronik

Ergebnis: **390** (409.4)
 Serien: 99 98 94 99
 Zähler: 32 7 0 1 0 0 0 0 0 0
 Innenzehner: 26
 weiteste: 848 (24), 381 (17), 321 (28)
 beste Teiler 10.4 (36.) 30.2 (39.) 54.1 (2.)
 Trefferlage 0.20 mm links, 0.11 mm hoch
 Streuwert 1.60, horizontal: 1.94, vertikal: 1.18

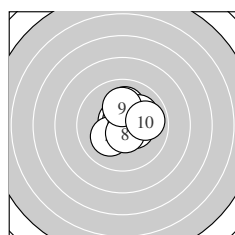
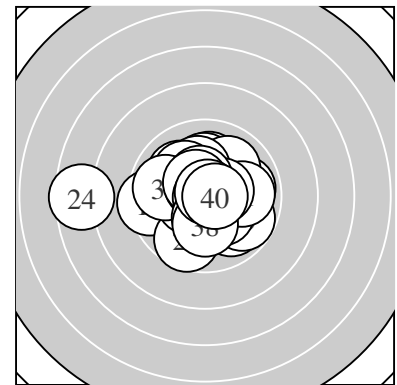

Serie 1:
 10.6 * 10.7 * 10.1 ↑ 10.2 * 10.1 ↗
 10.7 * 10.4 * 10.6 * 10.1 ↑ 9.9 →
 beste Teiler 54.1 (2.) 72.1 (6.) 78.4 (1.)
 Trefferlage 0.48 mm rechts, 0.48 mm hoch
 Streuwert 1.16, horizontal: 1.17, vertikal: 1.15

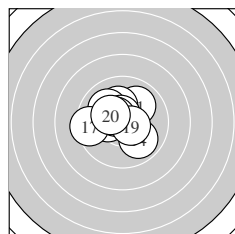

Serie 2:
 10.0 ↗ 10.2 * 10.3 * 9.9 ↘ 10.0 ↘
 10.6 * 9.4 ← 10.5 * 10.5 * 10.3 *
 beste Teiler 85.6 (16.) 101.8 (18.) 102.1 (19.)
 Trefferlage 0.58 mm links, 0.47 mm hoch
 Streuwert 1.47, horizontal: 1.70, vertikal: 1.19

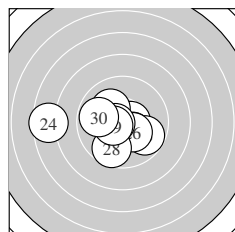

Serie 3:
 10.6 * 10.1 ↘ 10.3 * 7.6 ← 9.8 ↘
 10.3 * 10.6 * 9.7 ↓ 10.5 * 9.8 ←
 beste Teiler 84.8 (27.) 93.7 (21.) 115.1 (29.)
 Trefferlage 1.00 mm links, 0.51 mm tief
 Streuwert 2.34, horizontal: 3.07, vertikal: 1.24

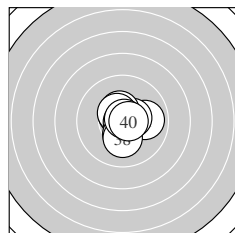

Serie 4:
 9.9 → 10.5 * 10.5 * 10.6 * 10.5 *
 10.9 * 10.4 * 10.2 * 10.8 * 10.7 *
 beste Teiler 10.4 (36.) 30.2 (39.) 68.0 (40.)
 Trefferlage 0.29 mm rechts, 0.00 mm
 Streuwert 0.97, horizontal: 0.95, vertikal: 1.00

Unterschrift des Schützen

Meyton Elektronik

Ergebnis: **387** (407.9)
 Serien: 97 98 94 98
 Zähler: 27 13 0 0 0 0 0 0 0 0
 Innenzehner: 24
 weiteste: 474 (6), 462 (36), 374 (25)
 beste Teiler 12.0 (1.) 51.9 (28.) 56.0 (7.)
 Trefferlage 0.10 mm rechts, 0.40 mm hoch
 Streuwert 1.54, horizontal: 1.94, vertikal: 1.01

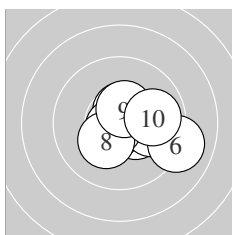
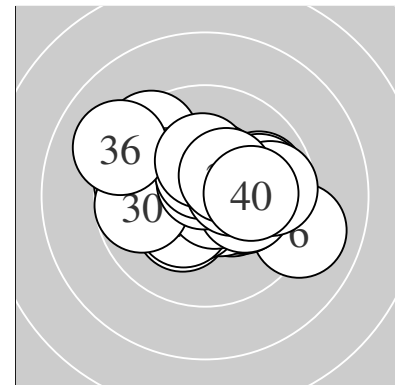

Serie 1:
 10.9 * 10.4 * 10.6 * 9.9 → 10.6 *
 9.1 → 10.7 * 10.3 * 10.5 * 9.9 →
 beste Teiler 12.0 (1.) 56.0 (7.) 85.2 (3.)
 Trefferlage 0.93 mm rechts, 0.23 mm tief
 Streuwert 1.40, horizontal: 1.75, vertikal: 0.91

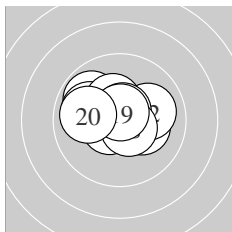

Serie 2:
 10.2 * 10.0 → 9.8 ↖ 10.6 * 10.0 ↖
 10.3 * 10.7 * 10.6 * 10.7 * 9.9 ←
 beste Teiler 61.5 (19.) 74.3 (17.) 91.0 (14.)
 Trefferlage 0.33 mm links, 0.46 mm hoch
 Streuwert 1.31, horizontal: 1.67, vertikal: 0.78

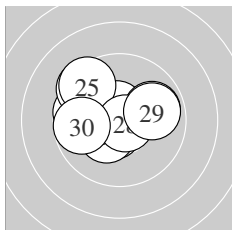

Serie 3:
 9.7 ↖ 9.5 ↖ 10.6 * 10.6 * 9.5 ↖
 9.9 → 10.3 * 10.7 * 9.9 → 9.7 ←
 beste Teiler 51.9 (28.) 89.0 (24.) 97.1 (23.)
 Trefferlage 0.74 mm links, 0.54 mm hoch
 Streuwert 1.77, horizontal: 2.14, vertikal: 1.29

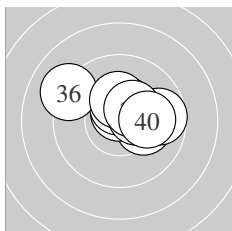

Serie 4:
 10.4 * 10.2 * 10.7 * 10.5 * 9.7 →
 9.1 ↖ 10.3 * 10.4 * 10.4 * 10.1 →
 beste Teiler 66.1 (33.) 115.7 (34.) 132.4 (31.)
 Trefferlage 0.56 mm rechts, 0.83 mm hoch
 Streuwert 1.48, horizontal: 1.94, vertikal: 0.80

Unterschrift des Schützen

Meyton Elektronik

Ergebnis:	374	(394.0)
Serien:	91 94 95 94	
Zähler:	17 20 3 0 0 0 0 0 0 0	
Innenzehner:	13	
weiteste:	599 (30), 573 (6), 527 (29)	
beste Teiler	42.5 (23.) 79.6 (15.) 102.8 (24.)	
Trefferlage	0.16 mm rechts, 0.26 mm hoch	
Streuwert	2.17, horizontal: 2.27, vertikal: 2.06	

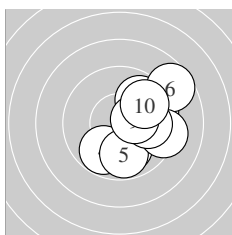
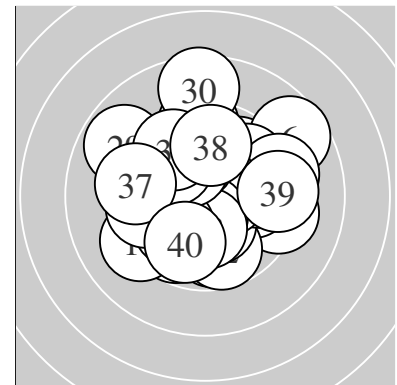

Serie 1:				
	10.0 ↓	9.8 ↗	9.6 →	9.8 ✓
	8.7 ↗	9.3 →	9.9 →	10.4 *
beste Teiler	144.5 (9.)	239.7 (1.)	263.1 (8.)	
Trefferlage	1.98 mm rechts, 0.00 mm			
Streuwert	1.97, horizontal: 1.83, vertikal: 2.11			

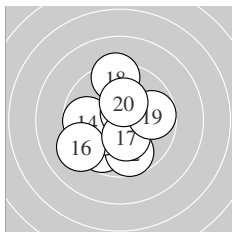

Serie 2:				
	9.7 ✓	9.7 ↓	10.3 *	9.7 ←
	9.2 ✓	10.3 *	9.4 ↑	9.8 →
beste Teiler	79.6 (15.)	163.4 (17.)	168.6 (13.)	
Trefferlage	0.46 mm links, 0.38 mm tief			
Streuwert	2.07, horizontal: 1.97, vertikal: 2.17			

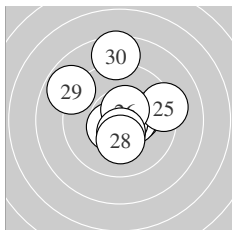

Serie 3:				
	10.3 *	10.5 *	10.8 *	10.5 *
	10.5 *	10.5 *	10.2 *	8.8 ↖
beste Teiler	42.5 (23.)	102.8 (24.)	107.3 (26.)	
Trefferlage	0.22 mm rechts, 0.75 mm hoch			
Streuwert	2.19, horizontal: 2.14, vertikal: 2.24			

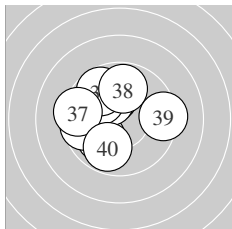

Serie 4:				
	10.1 ↑	10.0 ✓	9.6 ←	10.2 *
	9.7 ↘	9.4 ←	9.8 ↑	9.3 →
beste Teiler	187.1 (34.)	206.6 (31.)	242.5 (32.)	
Trefferlage	1.06 mm links, 0.67 mm hoch			
Streuwert	2.00, horizontal: 2.17, vertikal: 1.82			

Unterschrift des Schützen

Ergebnis: **381** (401.1)
 Serien: 95 94 95 97
 Zähler: 23 15 2 0 0 0 0 0 0 0
 Innenzehner: 17
 weiteste: 577 (37), 536 (15), 442 (5)
 beste Teiler 40.2 (1.) 61.0 (33.) 63.0 (31.)
 Trefferlage 0.40 mm rechts, 0.05 mm tief
 Streuwert 1.84, horizontal: 2.11, vertikal: 1.53

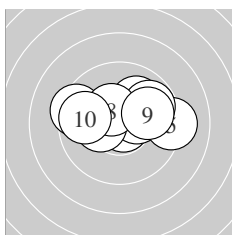
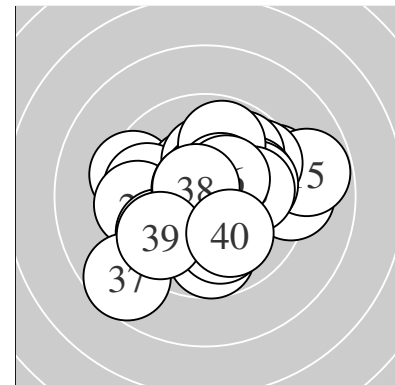

Serie 1:
 10.8 * 9.4 ← 10.0 ↗ 10.3 * 9.2 →
 9.8 ↗ 10.3 * 10.4 * 9.9 → 9.8 ←
 beste Teiler 40.2 (1.) 134.6 (8.) 155.2 (4.)
 Trefferlage 0.35 mm rechts, 0.67 mm hoch
 Streuwert 1.90, horizontal: 2.59, vertikal: 0.71

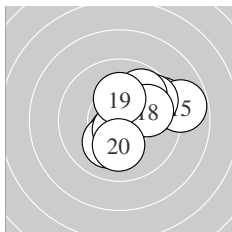

Serie 2:
 9.4 → 10.5 * 10.1 ↙ 10.6 * 8.8 →
 9.7 → 9.8 ↗ 9.9 → 10.2 * 10.1 ↓
 beste Teiler 81.6 (14.) 118.9 (12.) 184.0 (19.)
 Trefferlage 1.42 mm rechts, 0.32 mm hoch
 Streuwert 1.85, horizontal: 2.04, vertikal: 1.63

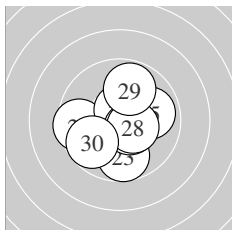

Serie 3:
 10.3 * 10.4 * 9.7 ↓ 9.6 ← 9.9 →
 10.6 * 10.5 * 10.4 * 9.8 ↑ 9.7 ↙
 beste Teiler 87.1 (26.) 113.5 (27.) 127.4 (28.)
 Trefferlage 0.12 mm links, 0.49 mm tief
 Streuwert 1.68, horizontal: 1.78, vertikal: 1.58

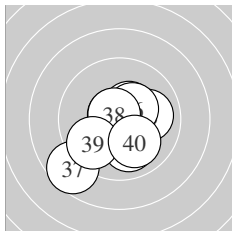

Serie 4:
 10.7 * 10.0 ↓ 10.7 * 10.4 * 10.0 →
 10.4 * 8.6 ↙ 10.7 * 9.7 ↙ 10.0 ↓
 beste Teiler 61.0 (33.) 63.0 (31.) 63.0 (38.)
 Trefferlage 0.03 mm links, 0.72 mm tief
 Streuwert 1.81, horizontal: 1.88, vertikal: 1.74

Unterschrift des Schützen

Meyton Elektronik

Ergebnis: **385** (403.4)
 Serien: 97 96 94 98
 Zähler: 26 13 1 0 0 0 0 0 0 0
 Innenzehner: 21
 weiteste: 508 (14), 426 (12), 425 (2)
 beste Teiler 56.8 (28.) 64.7 (9.) 73.5 (37.)
 Trefferlage 0.47 mm rechts, 0.60 mm hoch
 Streuwert 1.65, horizontal: 1.98, vertikal: 1.23

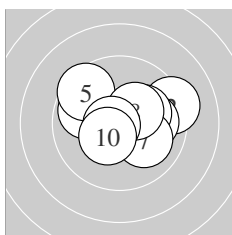
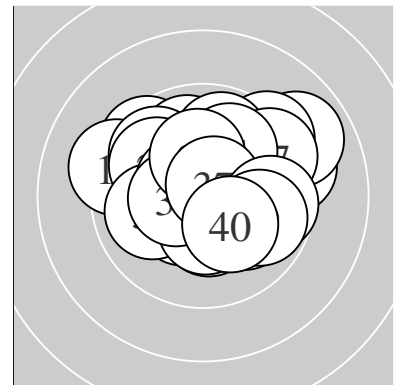

Serie 1:
 9.8 ↙ 9.3 → 10.0 → 10.6 * 9.5 ↘
 10.2 * 10.1 ↘ 10.3 * 10.7 * 10.4 *
 beste Teiler 64.7 (9.) 84.2 (4.) 137.9 (10.)
 Trefferlage 0.52 mm rechts, 0.46 mm hoch
 Streuwert 1.72, horizontal: 2.18, vertikal: 1.10

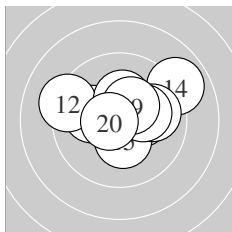

Serie 2:
 10.1 ↙ 9.2 ↙ 10.3 * 8.9 ↗ 10.3 *
 9.9 → 10.2 * 10.3 * 10.4 * 10.6 *
 beste Teiler 80.6 (20.) 142.6 (19.) 154.3 (15.)
 Trefferlage 0.47 mm rechts, 0.69 mm hoch
 Streuwert 1.87, horizontal: 2.40, vertikal: 1.12

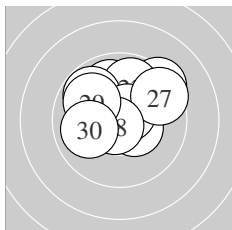

Serie 3:
 9.4 ↗ 9.9 ↖ 9.9 ↑ 9.8 ↘ 10.4 *
 10.6 * 9.5 ↗ 10.7 * 9.9 ↘ 10.0 ←
 beste Teiler 56.8 (28.) 82.0 (26.) 130.1 (25.)
 Trefferlage 0.08 mm rechts, 1.17 mm hoch
 Streuwert 1.72, horizontal: 2.01, vertikal: 1.36

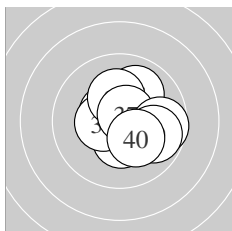

Serie 4:
 10.3 * 10.4 * 10.5 * 10.0 ↗ 10.4 *
 10.2 * 10.7 * 9.7 → 9.8 ↘ 10.2 *
 beste Teiler 73.5 (37.) 110.3 (33.) 127.4 (35.)
 Trefferlage 0.81 mm rechts, 0.06 mm hoch
 Streuwert 1.34, horizontal: 1.45, vertikal: 1.22

Unterschrift des Schützen

Ergebnis: **376** (395.3)
 Serien: 94 92 94 96
 Zähler: 20 16 4 0 0 0 0 0 0 0
 Innenzehner: 12
 weiteste: 614 (26), 574 (22), 554 (4)
 beste Teiler 40.0 (21.) 57.9 (30.) 58.9 (16.)
 Trefferlage 0.30 mm rechts, 0.49 mm hoch
 Streuwert 2.12, horizontal: 2.34, vertikal: 1.87

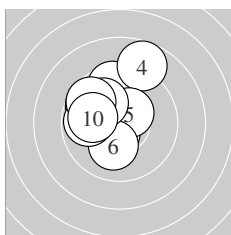
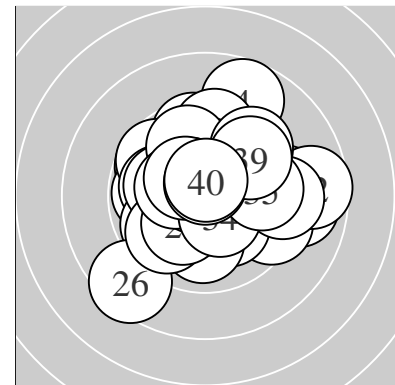

Serie 1:
 10.6 * 9.6 ↑ 9.7 ↘ 8.7 ↑ 10.4 *
 10.1 ↓ 9.8 ← 10.0 ↖ 9.7 ↘ 10.0 ←
 beste Teiler 99.4 (1.) 126.7 (5.) 206.0 (6.)
 Trefferlage 1.06 mm links, 1.25 mm hoch
 Streuwert 1.85, horizontal: 1.63, vertikal: 2.04

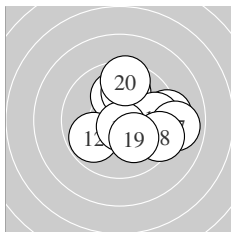

Serie 2:
 10.1 ↑ 9.8 ↙ 9.2 → 9.9 ↑ 9.7 →
 10.7 * 8.9 → 9.4 ↘ 10.1 ↘ 9.5 ↑
 beste Teiler 58.9 (16.) 203.3 (19.) 219.3 (11.)
 Trefferlage 1.58 mm rechts, 0.32 mm hoch
 Streuwert 2.10, horizontal: 2.34, vertikal: 1.84

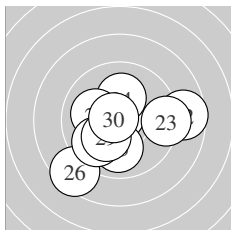

Serie 3:
 10.8 * 8.7 → 9.3 → 10.2 * 10.0 ↓
 8.5 ↙ 10.1 ← 9.8 ↙ 10.2 * 10.7 *
 beste Teiler 40.0 (21.) 57.9 (30.) 191.1 (29.)
 Trefferlage 0.00 mm , 0.69 mm tief
 Streuwert 2.48, horizontal: 2.94, vertikal: 1.93

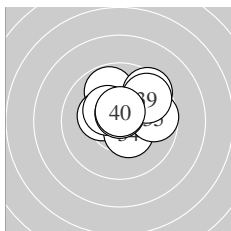

Serie 4:
 10.0 ↗ 9.8 ↑ 10.3 * 10.4 * 9.7 →
 10.4 * 9.5 ↗ 10.7 * 9.7 ↗ 10.6 *
 beste Teiler 69.0 (38.) 85.1 (40.) 132.6 (34.)
 Trefferlage 0.71 mm rechts, 1.09 mm hoch
 Streuwert 1.43, horizontal: 1.67, vertikal: 1.12

Unterschrift des Schützen

Meyton Elektronik

Ergebnis:	382	(402.0)
Serien:	94	96 98 94
Zähler:	25	13 1 1 0 0 0 0 0 0
Innenzehner:	22	
weiteste:	838	(6), 594 (2), 450 (35)
beste Teiler	51.4	(38.) 55.3 (16.) 57.6 (15.)
Trefferlage	1.54 mm	rechts, 0.01 mm hoch
Streuwert	1.64,	horizontal: 2.10, vertikal: 1.01

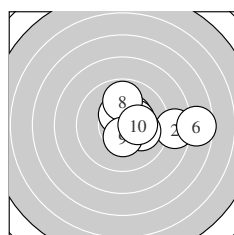
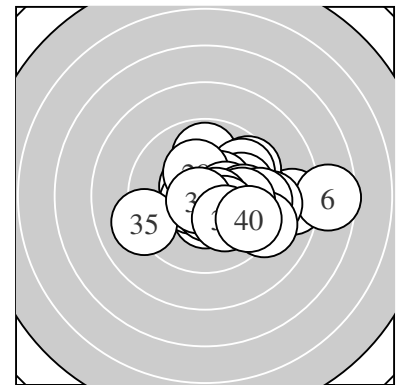

Serie 1:

10.3 *	8.6 →	10.4 *	10.5 *	10.3 *
7.6 →	10.1 →	9.9 ↑	10.4 *	10.3 *
beste Teiler	111.5 (4.)	131.8 (3.)	133.0 (9.)	
Trefferlage	2.11 mm rechts, 0.32 mm hoch			
Streuwert	2.17, horizontal: 2.84, vertikal: 1.16			

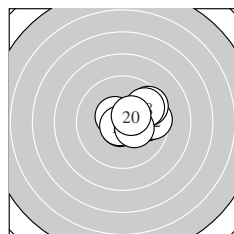

Serie 2:

9.9 →	9.6 →	10.5 *	10.5 *	10.7 *
10.7 *	9.6 ↗	9.8 ↗	10.4 *	10.5 *
beste Teiler	55.3 (16.)	57.6 (15.)	110.0 (13.)	
Trefferlage	1.35 mm rechts, 0.36 mm hoch			
Streuwert	1.22, horizontal: 1.50, vertikal: 0.86			

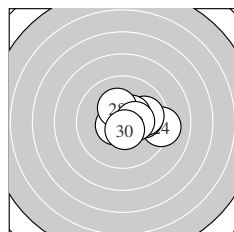

Serie 3:

10.3 *	10.7 *	10.6 *	9.2 →	10.0 →
9.9 →	10.4 *	10.3 *	10.4 *	10.6 *
beste Teiler	68.8 (22.)	89.2 (30.)	91.9 (23.)	
Trefferlage	1.23 mm rechts, 0.26 mm hoch			
Streuwert	1.22, horizontal: 1.56, vertikal: 0.72			

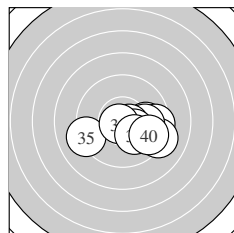

Serie 4:

9.9 →	9.5 →	9.2 ↘	9.9 →	9.2 ←
10.6 *	10.3 *	10.7 *	10.1 ↘	9.6 ↘
beste Teiler	51.4 (38.)	81.0 (36.)	156.1 (37.)	
Trefferlage	1.46 mm rechts, 0.90 mm tief			
Streuwert	1.77, horizontal: 2.40, vertikal: 0.72			

Unterschrift des Schützen

Ergebnis: **377** (396.7)
 Serien: 95 92 95 95
 Zähler: 21 15 4 0 0 0 0 0 0 0
 Innenzehner: 17
 weiteste: 662 (12), 569 (31), 531 (17)
 beste Teiler 74.3 (25.) 85.6 (24.) 91.9 (15.)
 Trefferlage 0.63 mm rechts, 0.01 mm tief
 Streuwert 2.09, horizontal: 2.11, vertikal: 2.06

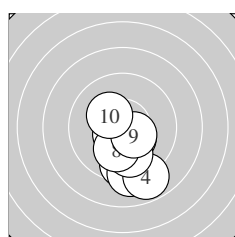
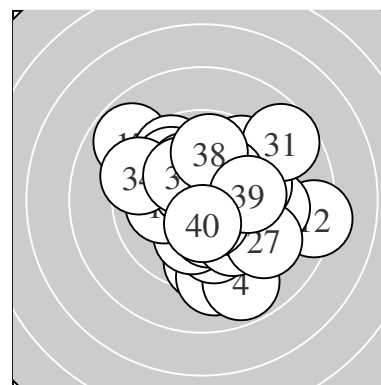

Serie 1:
 10.4 * 9.5 ↓ 9.1 ↓ 8.8 ↘ 10.5 *
 10.6 * 9.9 ↓ 10.1 ↓ 10.4 * 10.3 *
 beste Teiler 96.1 (6.) 116.4 (5.) 131.4 (9.)
 Trefferlage 0.28 mm rechts, 2.00 mm tief
 Streuwert 1.53, horizontal: 1.06, vertikal: 1.88

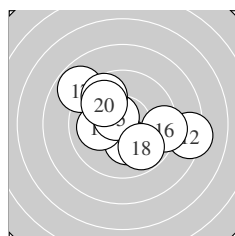

Serie 2:
 10.5 * 8.3 → 10.3 * 10.1 ← 10.6 *
 9.3 → 8.8 ↖ 9.8 ↘ 9.7 ↖ 9.9 ↖
 beste Teiler 91.9 (15.) 119.5 (11.) 175.3 (13.)
 Trefferlage 0.14 mm rechts, 0.38 mm hoch
 Streuwert 2.62, horizontal: 3.19, vertikal: 1.87

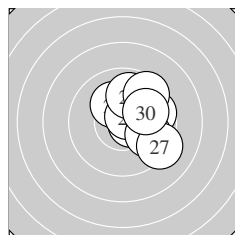

Serie 3:
 10.2 * 10.1 ↗ 9.7 → 10.6 * 10.7 *
 9.9 ↘ 9.2 ↘ 9.9 ↑ 9.5 ↗ 10.0 →
 beste Teiler 74.3 (25.) 85.6 (24.) 192.8 (21.)
 Trefferlage 1.57 mm rechts, 0.75 mm hoch
 Streuwert 1.50, horizontal: 1.37, vertikal: 1.61

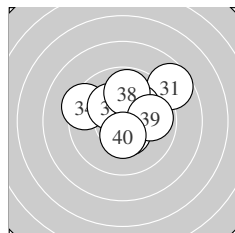

Serie 4:
 8.7 ↗ 10.5 * 10.2 * 9.4 ↖ 10.5 *
 10.4 * 10.2 * 9.8 ↑ 9.9 → 10.4 *
 beste Teiler 121.4 (35.) 122.5 (32.) 135.5 (36.)
 Trefferlage 0.52 mm rechts, 0.82 mm hoch
 Streuwert 1.94, horizontal: 2.19, vertikal: 1.64

Unterschrift des Schützen

Meyton Elektronik

Ergebnis: **390** (410.5)
 Serien: 97 95 99 99
 Zähler: 30 10 0 0 0 0 0 0 0 0
 Innenzehner: 26
 weiteste: 374 (13), 346 (9), 313 (12)
 beste Teiler 24.1 (18.) 59.2 (11.) 61.8 (22.)
 Trefferlage 0.21 mm links, 0.12 mm hoch
 Streuwert 1.39, horizontal: 1.26, vertikal: 1.50

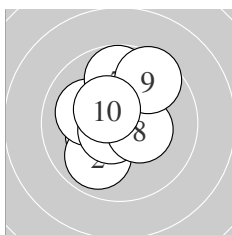
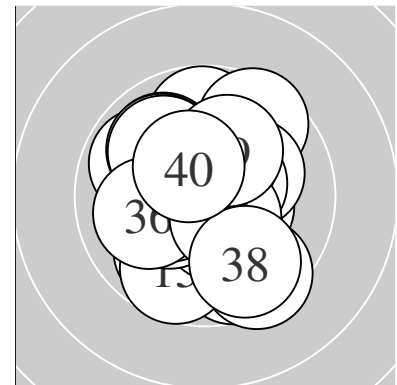

Serie 1:
 10.3 * 9.9 ↘ 10.6 * 10.1 ↖ 10.7 *
 10.5 * 9.8 ↑ 10.4 * 9.6 ↗ 10.5 *
 beste Teiler 73.7 (5.) 98.3 (3.) 120.2 (6.)
 Trefferlage 0.30 mm links, 0.51 mm hoch
 Streuwert 1.46, horizontal: 1.29, vertikal: 1.60

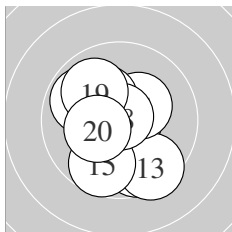

Serie 2:
 10.7 * 9.7 ↘ 9.5 ↘ 10.3 * 9.7 ↘
 10.2 * 9.8 ↖ 10.9 * 9.9 ↖ 10.3 *
 beste Teiler 24.1 (18.) 59.2 (11.) 159.8 (20.)
 Trefferlage 0.27 mm links, 0.38 mm tief
 Streuwert 1.73, horizontal: 1.50, vertikal: 1.94

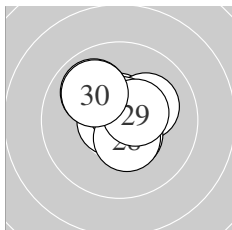

Serie 3:
 10.6 * 10.7 * 9.9 ↖ 10.2 * 10.7 *
 10.7 * 10.5 * 10.4 * 10.5 * 10.0 ↖
 beste Teiler 61.8 (22.) 68.6 (25.) 68.8 (26.)
 Trefferlage 0.06 mm rechts, 0.42 mm hoch
 Streuwert 1.08, horizontal: 1.13, vertikal: 1.04

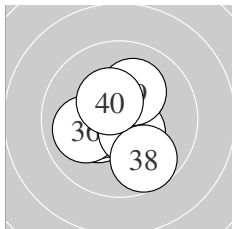

Serie 4:
 10.4 * 10.3 * 10.6 * 10.4 * 10.5 *
 10.0 ← 10.5 * 9.7 ↘ 10.1 ↗ 10.4 *
 beste Teiler 90.8 (33.) 105.1 (35.) 118.8 (37.)
 Trefferlage 0.37 mm links, 0.06 mm tief
 Streuwert 1.29, horizontal: 1.27, vertikal: 1.31

Unterschrift des Schützen

Meyton Elektronik

Ergebnis:	399	(418.3)
Serien:	100 100 100 99	
Zähler:	39 1 0 0 0 0 0 0 0 0	
Innenzehner:	32	
weiteste:	265 (39), 248 (36), 245 (32)	
beste Teiler	5.0 (7.) 11.3 (40.) 22.0 (1.)	
Trefferlage	0.07 mm links, 0.14 mm tief	
Streuwert	1.00, horizontal: 0.98, vertikal: 1.02	

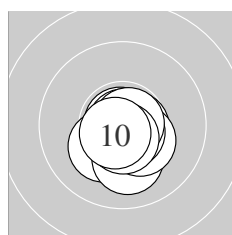
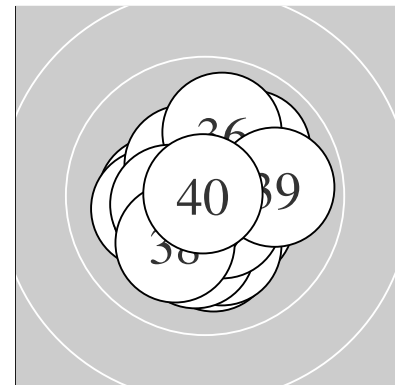

Serie 1:					
	10.9 *	10.2 *	10.1 ↓	10.7 *	10.4 *
	10.7 *	10.9 *	10.8 *	10.6 *	10.7 *
beste Teiler	5.0 (7.) 22.0 (1.) 38.6 (8.)				
Trefferlage	0.11 mm rechts, 0.60 mm tief				
Streuwert	0.68, horizontal: 0.63, vertikal: 0.72				

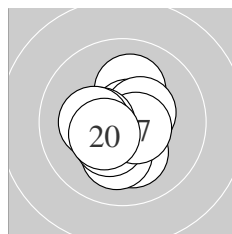

Serie 2:					
	10.1 ↑	10.7 *	10.4 *	10.2 *	10.1 ↓
	10.4 *	10.6 *	10.4 *	10.2 *	10.4 *
beste Teiler	57.0 (12.) 90.8 (17.) 126.6 (13.)				
Trefferlage	0.22 mm links, 0.31 mm tief				
Streuwert	1.13, horizontal: 1.04, vertikal: 1.21				

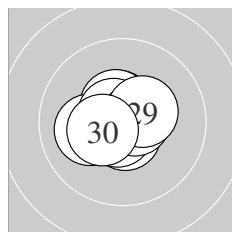

Serie 3:					
	10.5 *	10.6 *	10.5 *	10.1 ←	10.8 *
	10.7 *	10.7 *	10.6 *	10.4 *	10.4 *
beste Teiler	48.0 (25.) 65.7 (27.) 75.8 (26.)				
Trefferlage	0.32 mm links, 0.10 mm hoch				
Streuwert	0.82, horizontal: 0.93, vertikal: 0.68				

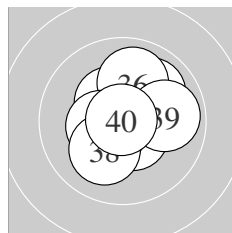

Serie 4:					
	10.5 *	10.0 ↗	10.6 *	10.7 *	10.4 *
	10.0 ↑	10.4 *	10.1 ↙	9.9 →	10.9 *
beste Teiler	11.3 (40.) 62.0 (34.) 82.0 (33.)				
Trefferlage	0.10 mm rechts, 0.24 mm hoch				
Streuwert	1.27, horizontal: 1.29, vertikal: 1.24				

Unterschrift des Schützen

Meyton Elektronik

Ergebnis: **392** (405.9)
 Serien: 97 99 98 98
 Zähler: 32 8 0 0 0 0 0 0 0 0
 Innenzehner: 21
 weiteste: 441 (22), 429 (15), 413 (3)
 beste Teiler 62.3 (5.) 64.0 (17.) 77.8 (2.)
 Trefferlage 0.21 mm rechts, 0.59 mm hoch
 Streuwert 1.52, horizontal: 1.64, vertikal: 1.40

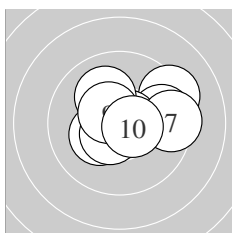
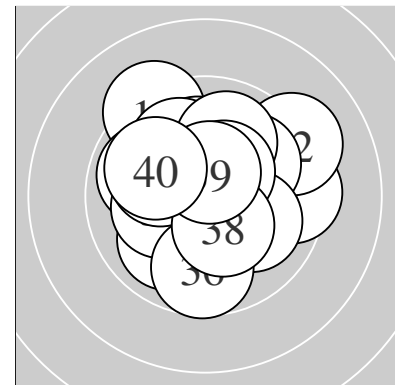

Serie 1:
 10.3 * 10.6 * 9.3 ↗ 9.7 → 10.7 *
 10.5 * 9.4 → 10.1 ↘ 10.5 * 10.6 *
 beste Teiler 62.3 (5.) 77.8 (2.) 97.2 (10.)
 Trefferlage 0.76 mm rechts, 0.44 mm hoch
 Streuwert 1.58, horizontal: 2.02, vertikal: 0.97

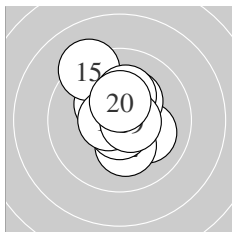

Serie 2:
 10.1 ↘ 10.2 * 10.3 * 10.3 * 9.2 ↖
 10.2 * 10.7 * 10.6 * 10.6 * 10.4 *
 beste Teiler 64.0 (17.) 80.7 (19.) 81.0 (18.)
 Trefferlage 0.04 mm rechts, 0.58 mm hoch
 Streuwert 1.40, horizontal: 1.17, vertikal: 1.60

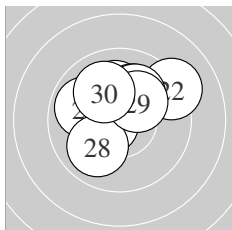

Serie 3:
 10.1 ↑ 9.2 ↗ 10.1 ↗ 10.6 * 10.1 ↗
 9.9 ↖ 10.3 * 10.0 ↙ 10.2 * 10.0 ↘
 beste Teiler 88.6 (24.) 157.3 (27.) 186.0 (29.)
 Trefferlage 0.01 mm rechts, 1.17 mm hoch
 Streuwert 1.58, horizontal: 1.81, vertikal: 1.31

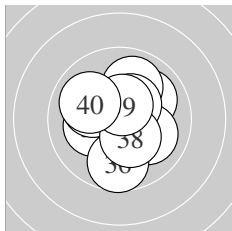

Serie 4:
 10.0 ↗ 10.0 ↘ 10.2 * 9.9 ↗ 10.1 ↖
 9.7 ↓ 10.4 * 10.3 * 10.5 * 10.0 ↖
 beste Teiler 104.9 (39.) 134.0 (37.) 151.2 (38.)
 Trefferlage 0.05 mm rechts, 0.19 mm hoch
 Streuwert 1.61, horizontal: 1.57, vertikal: 1.65

Unterschrift des Schützen

Meyton Elektronik

Ergebnis: **392** (409.1)
 Serien: 98 98 98 98
 Zähler: 32 8 0 0 0 0 0 0 0 0
 Innenzehner: 26
 weiteste: 378 (1), 368 (33), 353 (35)
 beste Teiler 26.3 (37.) 45.6 (2.) 59.5 (38.)
 Trefferlage 0.03 mm rechts, 0.23 mm hoch
 Streuwert 1.44, horizontal: 1.77, vertikal: 0.99

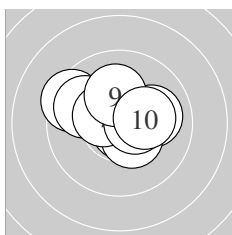
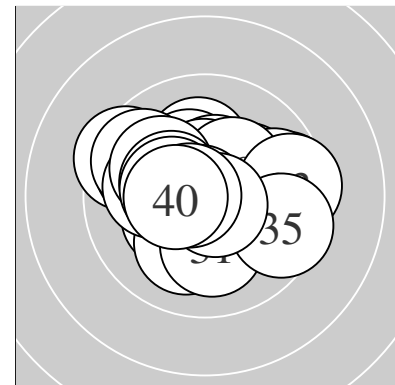

Serie 1:
 9.4 ↖ 10.8 * 10.6 * 10.0 → 9.8 ↖
 10.4 * 10.4 * 10.5 * 10.1 ↑ 10.2 *
 beste Teiler 45.6 (2.) 97.8 (3.) 111.0 (8.)
 Trefferlage 0.04 mm links, 0.55 mm hoch
 Streuwert 1.44, horizontal: 1.83, vertikal: 0.90

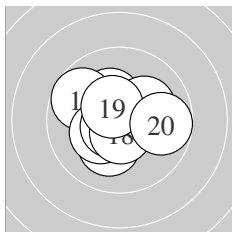

Serie 2:
 10.3 * 10.2 * 10.3 * 9.7 ↖ 10.3 *
 10.2 * 10.7 * 10.6 * 10.5 * 9.8 →
 beste Teiler 74.8 (17.) 90.3 (18.) 109.6 (19.)
 Trefferlage 0.31 mm links, 0.14 mm hoch
 Streuwert 1.40, horizontal: 1.62, vertikal: 1.15

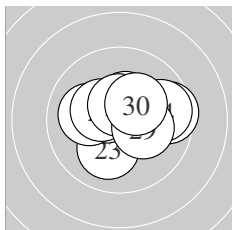

Serie 3:
 10.4 * 9.6 → 10.1 ↓ 9.7 → 10.5 *
 10.1 ← 10.4 * 10.5 * 10.2 * 10.3 *
 beste Teiler 108.1 (28.) 113.2 (25.) 131.8 (21.)
 Trefferlage 0.43 mm rechts, 0.38 mm hoch
 Streuwert 1.49, horizontal: 1.86, vertikal: 0.98

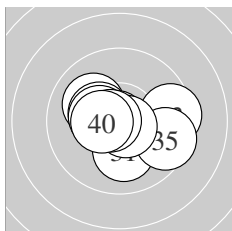

Serie 4:
 10.1 ↓ 10.1 ↖ 9.5 → 10.3 * 9.5 →
 10.4 * 10.8 * 10.7 * 10.7 * 10.4 *
 beste Teiler 26.3 (37.) 59.5 (38.) 68.0 (39.)
 Trefferlage 0.07 mm rechts, 0.13 mm tief
 Streuwert 1.54, horizontal: 1.95, vertikal: 0.95

Unterschrift des Schützen

Ergebnis:	383	(397.5)
Serien:	97	95 94 97
Zähler:	26	11 3 0 0 0 0 0 0 0
Innenzehner:	12	
weiteste:	740	(22), 536 (21), 525 (40)
beste Teiler	58.3	(5.) 60.1 (20.) 90.5 (36.)
Trefferlage	1.10 mm	rechts, 0.09 mm hoch
Streuwert	1.91,	horizontal: 2.07, vertikal: 1.75

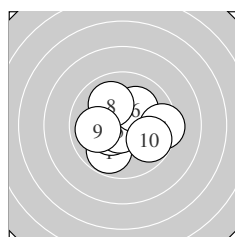
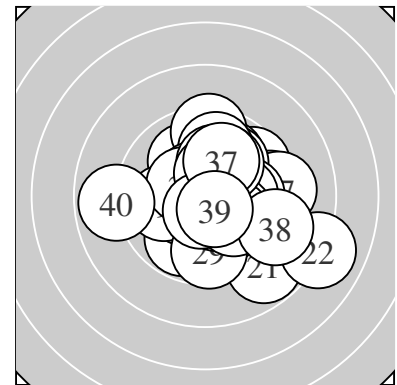

Serie 1:

9.8 ↘	10.4 *	10.3 *	10.0 →	10.7 *
10.1 ↗	9.4 →	10.0 ↘	10.0 ←	9.8 ↘
beste Teiler	58.3 (5.)	133.9 (2.)	151.4 (3.)	
Trefferlage	0.46 mm rechts, 0.12 mm tief			
Streuwert	1.75, horizontal: 2.05, vertikal: 1.38			

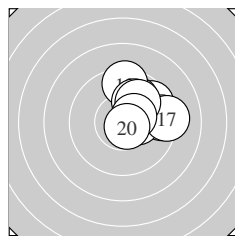

Serie 2:

9.6 ↗	9.9 ↗	9.4 ↑	9.4 →	10.0 ↗
10.4 *	9.2 →	10.0 ↗	10.5 *	10.7 *
beste Teiler	60.1 (20.)	124.7 (19.)	148.0 (16.)	
Trefferlage	1.81 mm rechts, 1.28 mm hoch			
Streuwert	1.34, horizontal: 1.39, vertikal: 1.30			

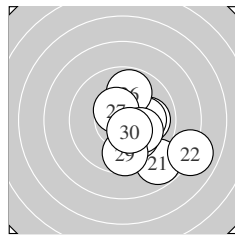

Serie 3:

8.8 ↘	8.0 ↘	10.0 →	10.1 →	10.1 ↘
9.8 ↑	10.5 *	10.1 ↘	9.7 ↓	10.5 *
beste Teiler	116.5 (27.)	122.3 (30.)	202.5 (28.)	
Trefferlage	1.87 mm rechts, 1.04 mm tief			
Streuwert	2.08, horizontal: 2.06, vertikal: 2.10			

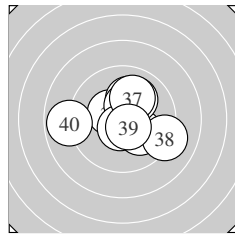

Serie 4:

10.4 *	10.1 ↘	10.1 ↑	10.1 ↗	10.4 *
10.6 *	10.0 ↑	9.1 ↘	10.6 *	8.9 ←
beste Teiler	90.5 (36.)	96.6 (39.)	138.6 (31.)	
Trefferlage	0.28 mm rechts, 0.26 mm hoch			
Streuwert	1.99, horizontal: 2.39, vertikal: 1.49			

Unterschrift des Schützen

Ergebnis:	387	(402.4)
Serien:	96 98 98 95	
Zähler:	27 13 0 0 0 0 0 0 0 0	
Innenzehner:	22	
weiteste:	457 (10), 455 (33), 430 (38)	
beste Teiler	14.0 (32.) 18.4 (2.) 52.0 (39.)	
Trefferlage	0.09 mm rechts, 0.17 mm tief	
Streuwert	1.81, horizontal: 1.88, vertikal: 1.73	

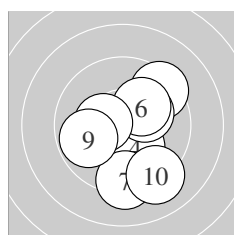
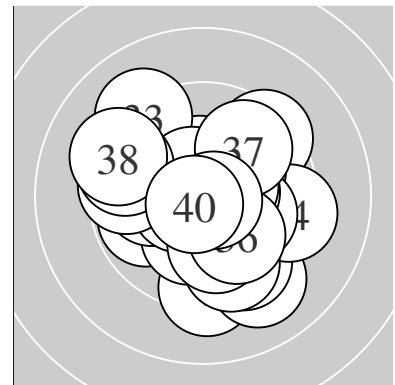

Serie 1:					
	9.4 ↗	10.9 *	10.3 *	10.2 *	10.2 *
	10.1 ↗	9.3 ↓	10.4 *	9.8 ←	9.1 ↘
beste Teiler	18.4 (2.) 149.0 (8.) 156.2 (3.)				
Trefferlage	0.62 mm rechts, 0.70 mm tief				
Streuwert	1.96, horizontal: 1.69, vertikal: 2.19				

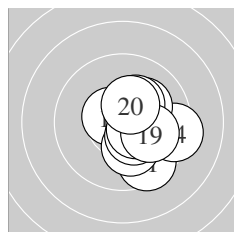

Serie 2:					
	9.5 ↘	10.6 *	10.2 *	9.3 →	10.4 *
	10.2 *	10.5 *	10.3 *	10.0 →	10.4 *
beste Teiler	99.2 (12.) 114.6 (17.) 136.3 (15.)				
Trefferlage	1.26 mm rechts, 0.38 mm tief				
Streuwert	1.36, horizontal: 1.25, vertikal: 1.47				

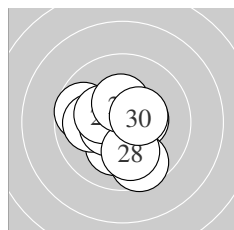

Serie 3:					
	10.4 *	9.7 ←	10.2 *	9.6 ↘	10.0 ←
	10.5 *	10.3 *	10.0 ↓	10.4 *	10.4 *
beste Teiler	113.8 (26.) 131.2 (21.) 131.3 (30.)				
Trefferlage	0.43 mm links, 0.41 mm tief				
Streuwert	1.52, horizontal: 1.56, vertikal: 1.48				

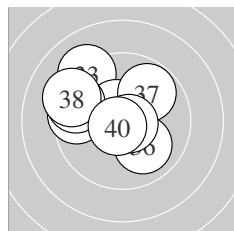

Serie 4:					
	9.5 ←	10.9 *	9.1 ↘	10.5 *	9.4 ←
	10.0 ↘	9.8 ↗	9.2 ←	10.7 *	10.7 *
beste Teiler	14.0 (32.) 52.0 (39.) 55.8 (40.)				
Trefferlage	1.09 mm links, 0.79 mm hoch				
Streuwert	1.89, horizontal: 2.18, vertikal: 1.53				

Unterschrift des Schützen

Ergebnis: **380** (399.4)
 Serien: 90 96 97 97
 Zähler: 25 10 5 0 0 0 0 0 0 0
 Innenzehner: 19
 weiteste: 615 (10), 575 (9), 559 (5)
 beste Teiler 12.0 (31.) 43.0 (37.) 82.8 (35.)
 Trefferlage 0.41 mm rechts, 0.53 mm tief
 Streuwert 1.96, horizontal: 2.36, vertikal: 1.47

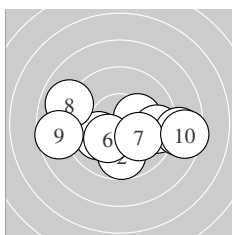
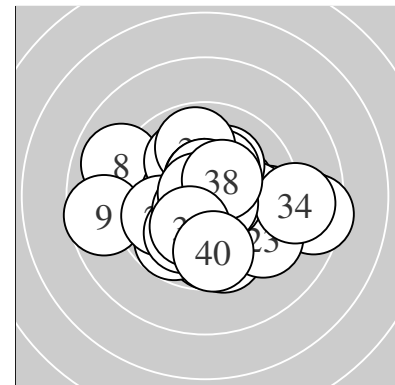

Serie 1:
 10.0 ↙ 9.8 ↓ 10.3 * 9.5 → 8.7 →
 10.2 * 10.1 ↘ 8.9 ↖ 8.7 ← 8.5 →
 beste Teiler 173.3 (3.) 179.6 (6.) 218.3 (7.)
 Trefferlage 0.53 mm rechts, 0.79 mm tief
 Streuwert 2.94, horizontal: 3.97, vertikal: 1.25

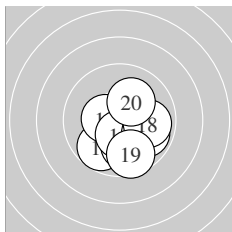

Serie 2:
 9.8 ↗ 10.4 * 10.0 ↓ 10.2 * 10.1 ↘
 10.4 * 9.9 ↘ 9.9 → 9.6 ↓ 10.2 *
 beste Teiler 133.7 (12.) 134.0 (16.) 190.0 (14.)
 Trefferlage 0.81 mm rechts, 1.03 mm tief
 Streuwert 1.47, horizontal: 1.48, vertikal: 1.46

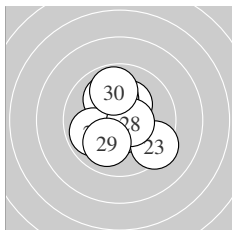

Serie 3:
 10.2 * 10.6 * 9.4 ↘ 10.3 * 10.2 *
 10.1 ↘ 9.9 ↖ 10.5 * 10.0 ↗ 9.8 ↑
 beste Teiler 94.1 (22.) 102.3 (28.) 167.8 (24.)
 Trefferlage 0.22 mm links, 0.05 mm hoch
 Streuwert 1.72, horizontal: 1.61, vertikal: 1.82

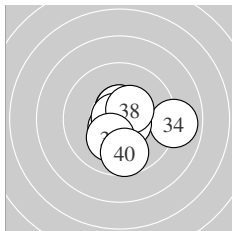

Serie 4:
 10.9 * 10.6 * 10.5 * 8.9 → 10.6 *
 10.6 * 10.8 * 10.4 * 10.2 * 9.7 ↓
 beste Teiler 12.0 (31.) 43.0 (37.) 82.8 (35.)
 Trefferlage 0.51 mm rechts, 0.36 mm tief
 Streuwert 1.50, horizontal: 1.69, vertikal: 1.28

Unterschrift des Schützen

Meyton Elektronik

Ergebnis:	384	(403.1)
Serien:	95	96 97 96
Zähler:	26	12 2 0 0 0 0 0 0 0
Innenzehner:	21	
weiteste:	553	(30), 536 (38), 452 (4)
beste Teiler	15.2	(10.) 44.7 (23.) 47.0 (19.)
Trefferlage	0.33 mm	rechts, 0.54 mm tief
Streuwert	1.78,	horizontal: 2.20, vertikal: 1.21

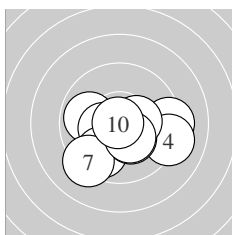
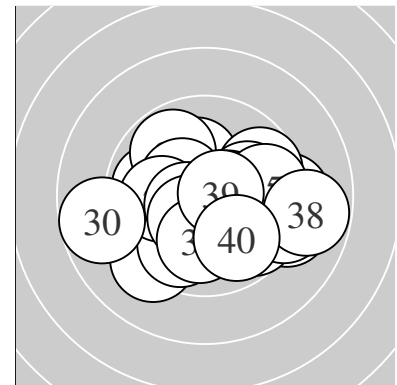

Serie 1:

9.9 ←	9.2 →	10.4 *	9.1 →	9.8 ↘
10.3 *	9.2 ↙	10.4 *	10.3 *	10.9 *
beste Teiler	15.2 (10.)	144.8 (3.)	146.8 (8.)	
Trefferlage	0.34 mm rechts, 0.96 mm tief			
Streuwert	2.00, horizontal: 2.54, vertikal: 1.24			

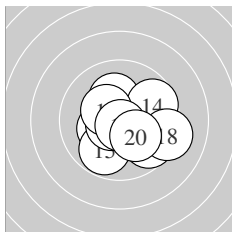

Serie 2:

10.2 *	10.3 *	9.7 ↘	9.7 →	9.8 ↘
10.6 *	10.4 *	9.2 →	10.8 *	10.2 *
beste Teiler	47.0 (19.)	82.3 (16.)	143.6 (17.)	
Trefferlage	0.58 mm rechts, 0.46 mm tief			
Streuwert	1.74, horizontal: 2.00, vertikal: 1.43			

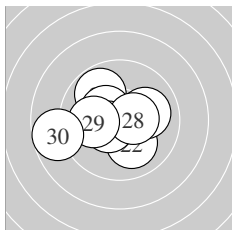

Serie 3:

10.7 *	10.1 ↘	10.8 *	9.8 ↘	10.0 →
10.4 *	10.5 *	10.5 *	10.0 ←	8.7 ←
beste Teiler	44.7 (23.)	71.8 (21.)	111.8 (27.)	
Trefferlage	0.81 mm links, 0.01 mm tief			
Streuwert	1.72, horizontal: 2.13, vertikal: 1.16			

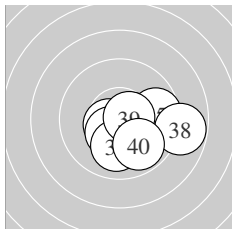

Serie 4:

10.5 *	10.5 *	10.1 →	10.7 *	9.7 →
10.4 *	10.0 ↓	8.8 →	10.6 *	9.9 ↘
beste Teiler	62.6 (34.)	83.3 (39.)	104.6 (32.)	
Trefferlage	1.23 mm rechts, 0.75 mm tief			
Streuwert	1.50, horizontal: 1.91, vertikal: 0.93			

Unterschrift des Schützen