

Ergebnis: **379** (400.1)
 Serien: 96 94 96 93
 Zähler: 22 15 3 0 0 0 0 0 0 0
 Innenzehner: 21
 weiteste: 559 (15), 545 (34), 505 (40)
 beste Teiler 37.3 (35.) 63.2 (27.) 65.1 (11.)
 Trefferlage 0.01 mm rechts, 0.16 mm hoch
 Streuwert 1.98, horizontal: 2.31, vertikal: 1.58

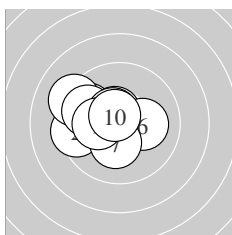

Serie 1:
 9.8 ↖ 9.4 ← 9.2 ↖ 10.5 * 9.8 ↖
 10.2 * 10.3 * 10.5 * 10.2 * 10.6 *
 beste Teiler 79.6 (10.) 101.0 (8.) 102.0 (4.)
 Trefferlage 1.48 mm links, 0.41 mm hoch
 Streuwert 1.51, horizontal: 1.85, vertikal: 1.06

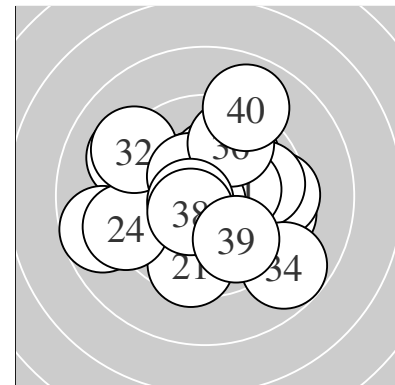
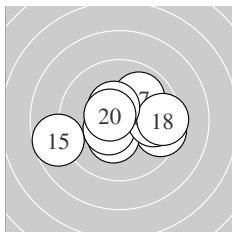

Serie 2:
 10.7 * 9.5 → 10.3 * 10.5 * 8.7 ←
 9.8 → 9.9 ↗ 9.5 → 10.5 * 10.6 *
 beste Teiler 65.1 (11.) 94.8 (20.) 119.3 (14.)
 Trefferlage 0.41 mm rechts, 0.08 mm tief
 Streuwert 2.09, horizontal: 2.72, vertikal: 1.15

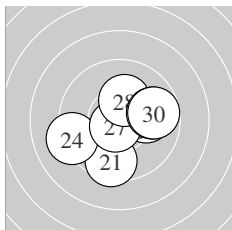

Serie 3:
 9.5 ↓ 10.0 → 10.6 * 9.2 ← 10.5 *
 10.3 * 10.7 * 10.3 * 9.8 → 9.7 →
 beste Teiler 63.2 (27.) 88.2 (23.) 111.8 (25.)
 Trefferlage 0.62 mm rechts, 0.03 mm tief
 Streuwert 1.82, horizontal: 2.09, vertikal: 1.51

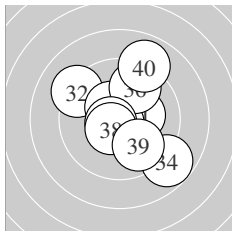

Serie 4:
 10.3 * 9.2 ↖ 10.4 * 8.8 ↘ 10.8 *
 9.7 ↗ 10.6 * 10.5 * 9.8 ↘ 8.9 ↗
 beste Teiler 37.3 (35.) 82.4 (37.) 111.8 (38.)
 Trefferlage 0.48 mm rechts, 0.37 mm hoch
 Streuwert 2.29, horizontal: 2.15, vertikal: 2.43

Unterschrift des Schützen

Meyton Elektronik

Ergebnis:	384	(397.1)
Serien:	96 93 98 97	
Zähler:	26 12 2 0 0 0 0 0 0 0	
Innenzehner:	18	
weiteste:	590 (13), 515 (8), 498 (4)	
beste Teiler	25.8 (1.) 76.7 (3.) 88.9 (36.)	
Trefferlage	0.24 mm rechts, 0.20 mm hoch	
Streuwert	2.10, horizontal: 2.25, vertikal: 1.93	

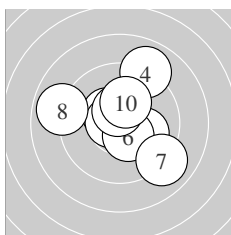
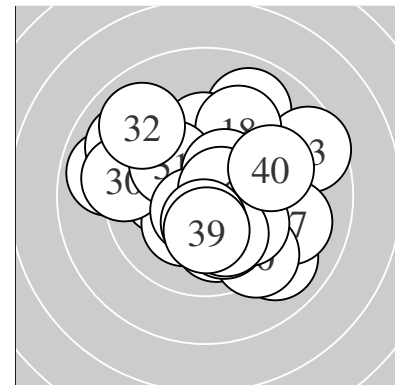

Serie 1:	10.9 *	10.4 *	10.6 *	9.0 ↗	10.1 ↘
	10.4 *	9.0 ↘	8.9 ←	10.5 *	10.2 *
beste Teiler	25.8 (1.)	76.7 (3.)	110.3 (9.)		
Trefferlage	0.24 mm rechts, 0.45 mm hoch				
Streuwert	2.19, horizontal: 2.36, vertikal: 2.02				

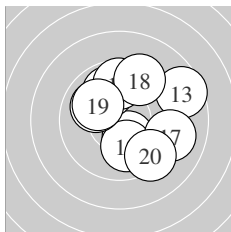

Serie 2:	10.3 *	10.0 ↓	8.6 ↘	10.0 ↖	9.9 ↗
	9.7 ↑	9.1 ↘	9.4 ↗	10.0 ↖	9.3 ↘
beste Teiler	161.4 (11.)	231.6 (19.)	232.8 (12.)		
Trefferlage	1.05 mm rechts, 0.59 mm hoch				
Streuwert	2.47, horizontal: 2.53, vertikal: 2.41				

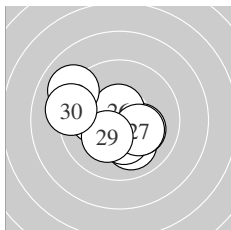

Serie 3:	10.0 ↓	10.4 *	10.2 *	10.3 *	10.1 ←
	10.6 *	10.2 *	9.0 ↖	10.2 *	9.2 ←
beste Teiler	89.4 (26.)	140.4 (22.)	166.3 (24.)		
Trefferlage	0.62 mm links, 0.35 mm tief				
Streuwert	1.86, horizontal: 2.19, vertikal: 1.46				

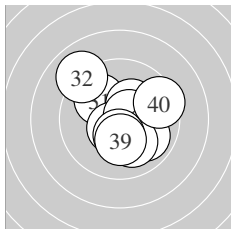

Serie 4:	10.0 ↖	9.0 ↖	10.3 *	9.9 ↘	10.6 *
	10.6 *	10.1 ↓	10.4 *	10.2 *	9.5 ↘
beste Teiler	88.9 (36.)	98.8 (35.)	138.1 (38.)		
Trefferlage	0.29 mm rechts, 0.10 mm hoch				
Streuwert	1.89, horizontal: 1.91, vertikal: 1.88				

Unterschrift des Schützen

Ergebnis: **367** (386.2)
 Serien: 91 93 90 93
 Zähler: 12 23 5 0 0 0 0 0 0 0
 Innenzehner: 9
 weiteste: 688 (35), 635 (3), 605 (24)
 beste Teiler 84.3 (27.) 125.8 (32.) 145.3 (20.)
 Trefferlage 0.17 mm rechts, 0.41 mm hoch
 Streuwert 2.52, horizontal: 2.99, vertikal: 1.95

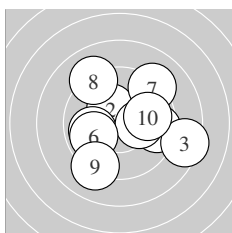
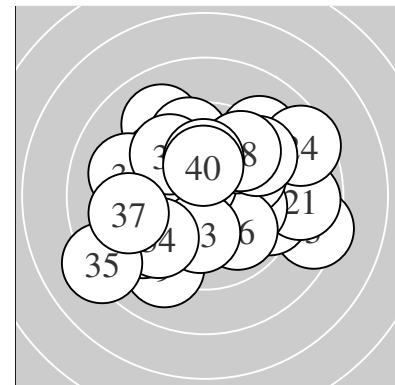

Serie 1:
 9.5 → 10.3 * 8.4 → 9.9 ← 10.2 *
 9.9 ← 9.1 ↗ 9.1 ↘ 9.1 ↘ 9.9 →
 beste Teiler 163.4 (2.) 183.3 (5.) 261.8 (4.)
 Trefferlage 0.66 mm rechts, 0.10 mm hoch
 Streuwert 2.78, horizontal: 3.13, vertikal: 2.38

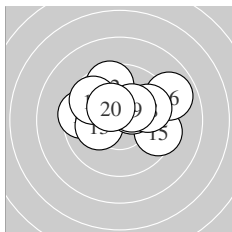

Serie 2:
 9.5 ← 9.6 ↑ 10.2 * 9.7 ↘ 9.5 →
 8.9 → 10.4 * 9.8 → 10.3 * 10.4 *
 beste Teiler 145.3 (20.) 149.9 (17.) 161.2 (19.)
 Trefferlage 0.35 mm rechts, 1.07 mm hoch
 Streuwert 2.11, horizontal: 2.71, vertikal: 1.26

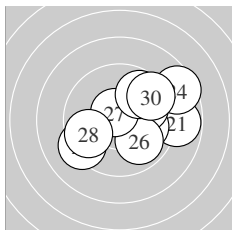

Serie 3:
 8.8 → 9.3 ← 10.0 → 8.5 → 9.9 →
 9.9 ↘ 10.6 * 9.7 ← 9.7 ↗ 9.5 →
 beste Teiler 84.3 (27.) 242.5 (23.) 260.7 (25.)
 Trefferlage 1.51 mm rechts, 0.29 mm hoch
 Streuwert 2.50, horizontal: 3.01, vertikal: 1.85

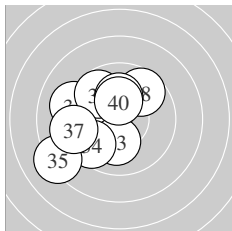

Serie 4:
 9.2 ↖ 10.5 * 10.1 ↓ 9.6 ↙ 8.2 ←
 9.7 ↘ 9.2 ← 9.7 ↗ 10.1 ↑ 10.3 *
 beste Teiler 125.8 (32.) 169.2 (40.) 206.1 (39.)
 Trefferlage 1.81 mm links, 0.17 mm hoch
 Streuwert 2.34, horizontal: 2.41, vertikal: 2.26

Unterschrift des Schützen

Meyton Elektronik

Ergebnis: **384** (399.8)
 Serien: 93 97 98 96
 Zähler: 24 16 0 0 0 0 0 0 0 0
 Innenzehner: 19
 weiteste: 493 (29), 486 (20), 438 (32)
 beste Teiler 15.6 (39.) 100.0 (18.) 112.3 (1.)
 Trefferlage 0.23 mm links, 0.07 mm hoch
 Streuwert 1.86, horizontal: 2.02, vertikal: 1.70

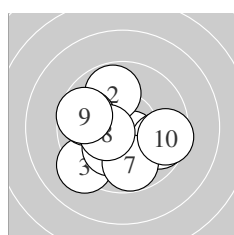
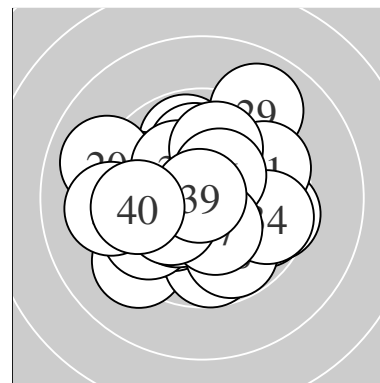

Serie 1:
 10.5 * 9.8 ↑ 9.2 ↙ 10.2 * 9.8 ←
 9.7 → 9.8 ↓ 10.4 * 9.7 ↖ 9.5 →
 beste Teiler 112.3 (1.) 132.8 (8.) 192.4 (4.)
 Trefferlage 0.43 mm links, 0.63 mm tief
 Streuwert 2.06, horizontal: 2.32, vertikal: 1.75

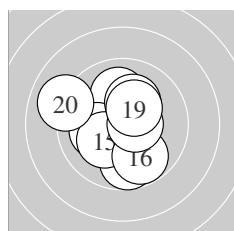

Serie 2:
 10.2 * 9.7 ↓ 10.0 ↑ 10.1 ← 10.2 *
 9.8 ↘ 10.2 * 10.6 * 10.3 * 9.0 ←
 beste Teiler 100.0 (18.) 157.6 (19.) 176.8 (11.)
 Trefferlage 0.50 mm links, 0.16 mm tief
 Streuwert 1.86, horizontal: 1.84, vertikal: 1.87

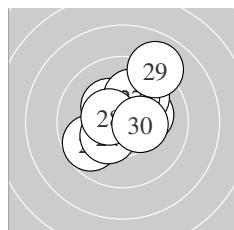

Serie 3:
 9.7 ↙ 10.2 * 10.4 * 10.3 * 10.3 *
 10.0 ↗ 10.1 ↑ 10.5 * 9.0 ↗ 10.4 *
 beste Teiler 115.5 (28.) 140.1 (30.) 147.0 (23.)
 Trefferlage 0.21 mm rechts, 0.89 mm hoch
 Streuwert 1.67, horizontal: 1.65, vertikal: 1.69

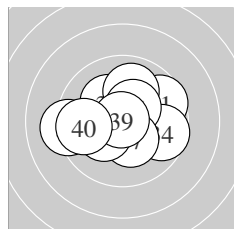

Serie 4:
 9.6 → 9.2 ← 10.2 * 9.7 → 10.0 ↑
 10.4 * 10.3 * 10.2 * 10.9 * 9.7 ←
 beste Teiler 15.6 (39.) 136.2 (36.) 157.5 (37.)
 Trefferlage 0.19 mm links, 0.21 mm hoch
 Streuwert 1.92, horizontal: 2.40, vertikal: 1.28

Unterschrift des Schützen

Meyton Elektronik

Ergebnis: **381** (397.6)
 Serien: 95 95 96 95
 Zähler: 22 17 1 0 0 0 0 0 0 0
 Innenzehner: 17
 weiteste: 525 (13), 496 (37), 490 (32)
 beste Teiler 41.3 (36.) 57.1 (26.) 77.3 (14.)
 Trefferlage 0.29 mm rechts, 0.33 mm tief
 Streuwert 2.03, horizontal: 1.94, vertikal: 2.11

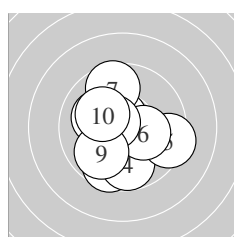
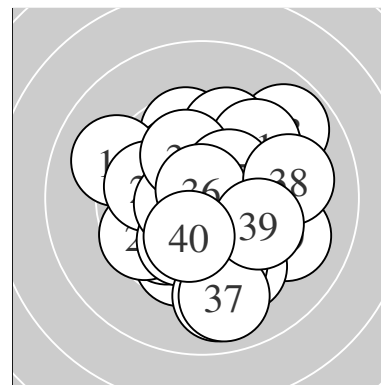

Serie 1:
 10.1 ↖ 10.6 * 9.6 ↓ 9.8 ↓ 9.4 →
 10.2 * 9.6 ↑ 10.6 * 9.9 ↙ 10.2 *
 beste Teiler 78.1 (2.) 87.6 (8.) 177.0 (6.)
 Trefferlage 0.23 mm links, 0.34 mm tief
 Streuwert 1.90, horizontal: 1.80, vertikal: 1.99

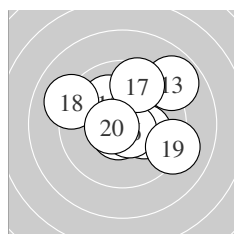

Serie 2:
 10.3 * 10.2 * 8.9 ↗ 10.6 * 10.1 ↖
 10.6 * 9.6 ↑ 9.1 ↖ 9.1 → 10.6 *
 beste Teiler 77.3 (14.) 77.8 (16.) 91.2 (20.)
 Trefferlage 0.55 mm rechts, 0.80 mm hoch
 Streuwert 2.17, horizontal: 2.48, vertikal: 1.80

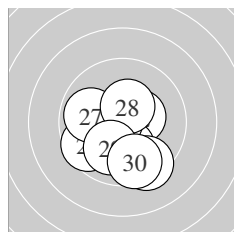

Serie 3:
 10.2 * 10.4 * 10.1 ↓ 9.4 ↘ 9.6 ↖
 10.7 * 9.9 ← 10.4 * 10.0 ↓ 9.6 ↓
 beste Teiler 57.1 (26.) 135.3 (28.) 139.1 (22.)
 Trefferlage 0.17 mm links, 1.21 mm tief
 Streuwert 1.63, horizontal: 1.59, vertikal: 1.66

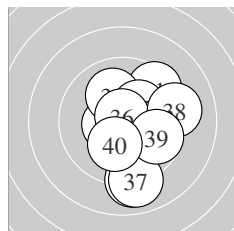

Serie 4:
 9.5 ↗ 9.0 ↓ 10.5 * 10.0 ↑ 10.3 *
 10.8 * 9.0 ↓ 9.2 → 9.7 → 10.2 *
 beste Teiler 41.3 (36.) 115.4 (33.) 175.1 (35.)
 Trefferlage 1.02 mm rechts, 0.59 mm tief
 Streuwert 2.24, horizontal: 1.77, vertikal: 2.63

Unterschrift des Schützen

Meyton Elektronik

Ergebnis: **383** (402.5)
 Serien: 96 97 95 95
 Zähler: 24 15 1 0 0 0 0 0 0 0
 Innenzehner: 19
 weiteste: 616 (34), 472 (8), 383 (30)
 beste Teiler 11.0 (24.) 11.4 (25.) 28.2 (7.)
 Trefferlage 0.29 mm links, 0.10 mm tief
 Streuwert 1.82, horizontal: 2.06, vertikal: 1.53

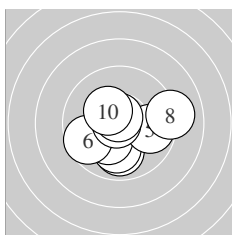
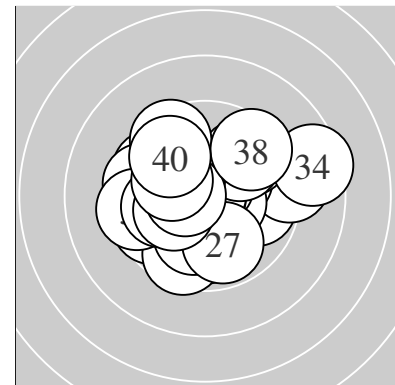

Serie 1:
 10.4 * 9.9 ↓ 10.0 ↓ 10.2 * 9.8 →
 9.6 ← 10.8 * 9.1 → 10.7 * 10.3 *
 beste Teiler 28.2 (7.) 55.3 (9.) 135.3 (1.)
 Trefferlage 0.29 mm rechts, 0.68 mm tief
 Streuwert 1.77, horizontal: 2.13, vertikal: 1.30

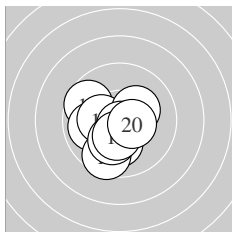

Serie 2:
 10.1 ↓ 9.7 ↖ 9.9 ← 9.6 ↓ 10.3 *
 10.3 * 10.7 * 10.2 * 10.4 * 10.5 *
 beste Teiler 52.3 (17.) 119.2 (20.) 146.3 (19.)
 Trefferlage 0.65 mm links, 0.75 mm tief
 Streuwert 1.42, horizontal: 1.44, vertikal: 1.41

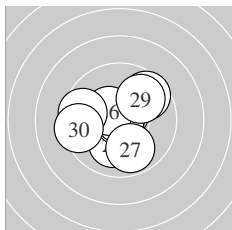

Serie 3:
 10.6 * 10.1 ↓ 9.6 ↗ 10.9 * 10.9 *
 10.4 * 9.9 ↓ 9.6 ← 9.9 ↗ 9.4 ←
 beste Teiler 11.0 (24.) 11.4 (25.) 76.4 (21.)
 Trefferlage 0.29 mm links, 0.09 mm hoch
 Streuwert 1.81, horizontal: 2.03, vertikal: 1.57

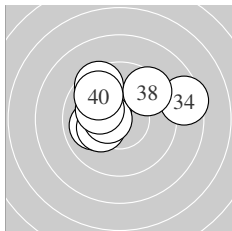

Serie 4:
 10.4 * 10.2 * 10.0 ← 8.5 → 9.5 ↖
 10.2 * 10.5 * 9.5 ↗ 10.1 ↖ 9.8 ↖
 beste Teiler 110.0 (37.) 142.4 (31.) 188.4 (36.)
 Trefferlage 0.53 mm links, 0.91 mm hoch
 Streuwert 2.13, horizontal: 2.67, vertikal: 1.41

Unterschrift des Schützen

Meyton Elektronik

Ergebnis: **371** (386.3)
 Serien: 91 93 93 94
 Zähler: 16 19 5 0 0 0 0 0 0 0
 Innenzehner: 11
 weiteste: 697 (9), 661 (12), 533 (6)
 beste Teiler 56.2 (22.) 99.1 (37.) 103.5 (16.)
 Trefferlage 0.00 mm , 0.42 mm hoch
 Streuwert 2.55, horizontal: 2.81, vertikal: 2.27

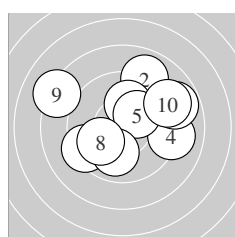
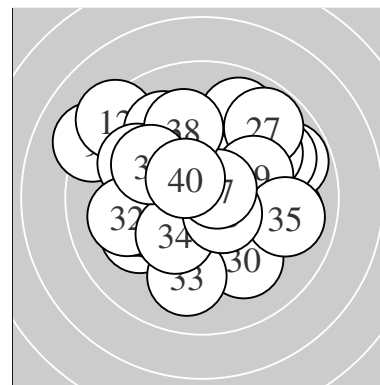

Serie 1:
 9.3 ↙ 8.9 ↗ 10.1 ↑ 9.1 → 10.2 *
 8.8 → 10.0 ↓ 10.0 ↙ 8.2 ↘ 9.0 ↗
 beste Teiler 181.2 (5.) 223.8 (3.) 246.5 (8.)
 Trefferlage 0.52 mm rechts, 0.89 mm hoch
 Streuwert 3.11, horizontal: 3.70, vertikal: 2.37

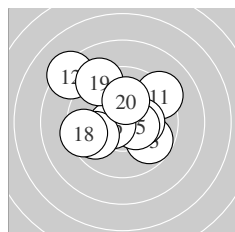

Serie 2:
 9.2 ↗ 8.3 ↘ 9.7 ↘ 10.3 * 10.4 *
 10.5 * 9.8 ↙ 9.4 ↙ 9.2 ↘ 10.1 ↑
 beste Teiler 103.5 (16.) 129.8 (15.) 173.0 (14.)
 Trefferlage 0.50 mm links, 0.82 mm hoch
 Streuwert 2.51, horizontal: 2.79, vertikal: 2.20

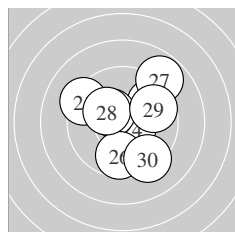

Serie 3:
 9.3 ↘ 10.7 * 9.7 ↗ 10.5 * 10.4 *
 9.7 ↓ 8.8 ↗ 10.2 * 9.7 → 9.3 ↘
 beste Teiler 56.2 (22.) 107.6 (24.) 136.8 (25.)
 Trefferlage 0.62 mm rechts, 0.34 mm hoch
 Streuwert 2.30, horizontal: 2.30, vertikal: 2.30

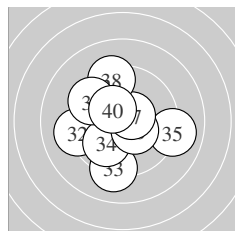

Serie 4:
 10.0 ↙ 9.2 ↙ 9.1 ↓ 9.9 ↙ 9.0 →
 10.4 * 10.6 * 9.3 ↑ 9.6 ↘ 10.4 *
 beste Teiler 99.1 (37.) 144.8 (36.) 146.1 (40.)
 Trefferlage 0.63 mm links, 0.37 mm tief
 Streuwert 2.39, horizontal: 2.45, vertikal: 2.33

Unterschrift des Schützen

Ergebnis: **378** (394.1)
 Serien: 93 95 94 96
 Zähler: 21 16 3 0 0 0 0 0 0 0
 Innenzehner: 16
 weiteste: 710 (25), 702 (36), 613 (9)
 beste Teiler 9.4 (26.) 59.8 (11.) 76.2 (12.)
 Trefferlage 0.24 mm rechts, 0.06 mm hoch
 Streuwert 2.27, horizontal: 2.51, vertikal: 2.01

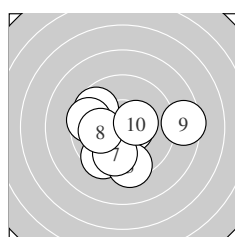
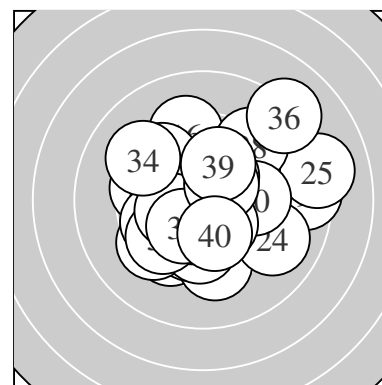

Serie 1:
 9.5 ↙ 10.6 * 9.4 ↓ 10.1 ← 9.7 ↘
 9.6 ← 9.9 ↓ 10.1 ← 8.5 → 10.4 *
 beste Teiler 87.9 (2.) 140.0 (10.) 202.5 (4.)
 Trefferlage 0.39 mm links, 0.70 mm tief
 Streuwert 2.36, horizontal: 2.80, vertikal: 1.81

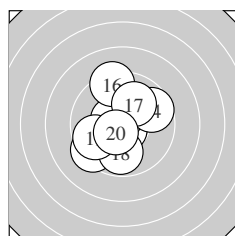

Serie 2:
 10.7 * 10.6 * 10.5 * 9.7 → 9.4 ↙
 9.3 ↑ 10.0 ↗ 9.8 ↓ 9.7 ← 10.5 *
 beste Teiler 59.8 (11.) 76.2 (12.) 107.2 (20.)
 Trefferlage 0.45 mm links, 0.06 mm hoch
 Streuwert 1.93, horizontal: 1.72, vertikal: 2.11

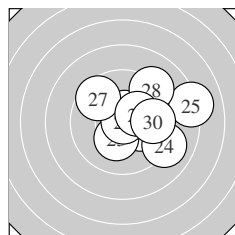

Serie 3:
 10.6 * 10.2 * 10.3 * 9.0 ↘ 8.1 →
 10.9 * 9.6 ↘ 9.2 ↗ 10.3 * 9.7 →
 beste Teiler 9.4 (26.) 95.9 (21.) 169.6 (29.)
 Trefferlage 1.74 mm rechts, 0.47 mm hoch
 Streuwert 2.25, horizontal: 2.67, vertikal: 1.75

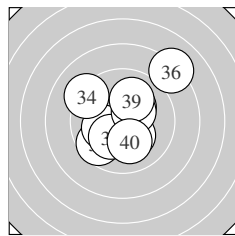

Serie 4:
 9.6 ↙ 10.2 * 10.2 * 9.2 ↘ 10.2 *
 8.1 ↗ 10.2 * 10.4 * 10.0 ↗ 10.1 ↓
 beste Teiler 144.8 (38.) 178.0 (33.) 180.6 (35.)
 Trefferlage 0.06 mm rechts, 0.41 mm hoch
 Streuwert 2.41, horizontal: 2.42, vertikal: 2.39

Unterschrift des Schützen

Meyton Elektronik

Ergebnis: **394** (411.8)
 Serien: 99 98 97 100
 Zähler: 34 6 0 0 0 0 0 0 0 0
 Innenzehner: 30
 weiteste: 367 (26), 356 (11), 348 (1)
 beste Teiler 48.3 (38.) 54.0 (27.) 69.6 (13.)
 Trefferlage 0.24 mm links, 0.00 mm
 Streuwert 1.32, horizontal: 1.51, vertikal: 1.10

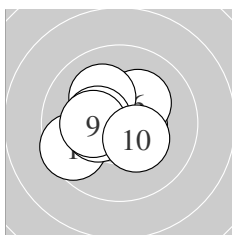
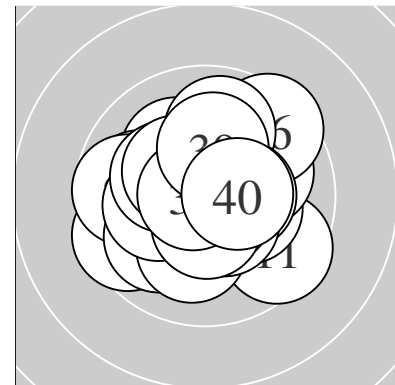

Serie 1:
 9.6 ↙ 10.7 * 10.5 * 10.4 * 10.6 *
 10.2 * 10.1 ↘ 10.4 * 10.2 * 10.3 *
 beste Teiler 75.0 (2.) 97.8 (5.) 125.5 (3.)
 Trefferlage 0.45 mm links, 0.15 mm hoch
 Streuwert 1.30, horizontal: 1.51, vertikal: 1.04

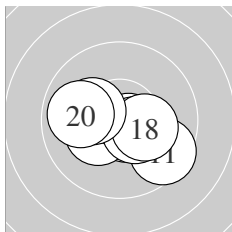

Serie 2:
 9.5 ↘ 10.4 * 10.7 * 10.5 * 10.7 *
 10.3 * 10.5 * 10.3 * 10.2 * 9.9 ←
 beste Teiler 69.6 (13.) 74.2 (15.) 110.3 (14.)
 Trefferlage 0.15 mm links, 0.50 mm tief
 Streuwert 1.33, horizontal: 1.74, vertikal: 0.72

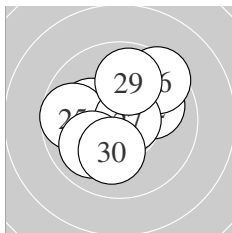

Serie 3:
 10.7 * 10.0 ↗ 10.2 * 10.6 * 9.7 ←
 9.5 ↗ 10.7 * 10.0 ↙ 9.9 ↑ 10.1 ↓
 beste Teiler 54.0 (27.) 75.8 (21.) 85.5 (24.)
 Trefferlage 0.29 mm links, 0.29 mm hoch
 Streuwert 1.67, horizontal: 1.78, vertikal: 1.55

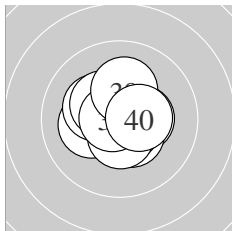

Serie 4:
 10.4 * 10.5 * 10.7 * 10.2 * 10.5 *
 10.3 * 10.4 * 10.8 * 10.2 * 10.4 *
 beste Teiler 48.3 (38.) 75.2 (33.) 109.2 (35.)
 Trefferlage 0.06 mm links, 0.08 mm hoch
 Streuwert 1.05, horizontal: 1.16, vertikal: 0.93

Unterschrift des Schützen

Meyton Elektronik

Ergebnis:	389	(404.5)			
Serien:	97	98	98	96	
Zähler:	29	11	0	0	0 0 0 0 0 0
Innenzehner:	19				
weiteste:	479 (35), 429 (39), 402 (34)				
beste Teiler	19.0 (32.) 21.0 (12.) 63.2 (14.)				
Trefferlage	0.24 mm links, 0.01 mm hoch				
Streuwert	1.69, horizontal: 2.05, vertikal: 1.24				

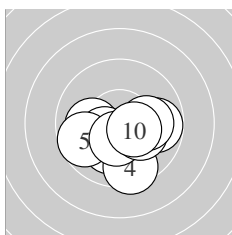
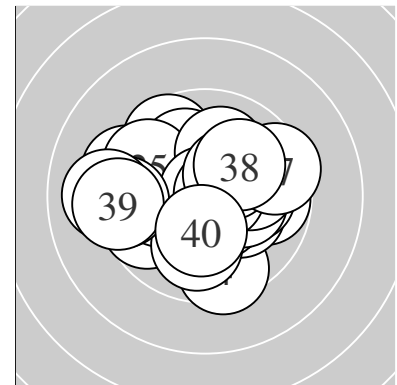

Serie 1:	10.1 ↓	10.1 ←	10.3 *	9.5 ↓	9.7 ←
	9.8 →	10.4 *	10.2 *	10.1 →	10.4 *
beste Teiler	129.4 (7.) 129.4 (10.) 151.6 (3.)				
Trefferlage	0.15 mm rechts, 1.06 mm tief				
Streuwert	1.56, horizontal: 1.93, vertikal: 1.07				

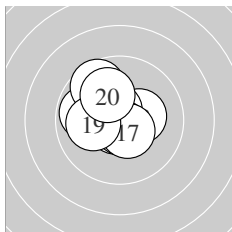

Serie 2:	9.8 ←	10.9 *	10.3 *	10.7 *	10.6 *
	10.7 *	10.5 *	9.6 ↘	10.1 ←	10.0 ↘
beste Teiler	21.0 (12.) 63.2 (14.) 68.0 (16.)				
Trefferlage	0.59 mm links, 0.39 mm hoch				
Streuwert	1.26, horizontal: 1.33, vertikal: 1.19				

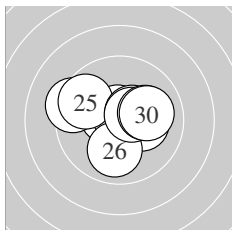

Serie 3:	10.5 *	9.3 ←	10.7 *	10.2 *	9.7 ↘
	10.0 ↓	10.5 *	10.5 *	10.1 →	10.0 →
beste Teiler	65.2 (23.) 105.6 (21.) 108.3 (28.)				
Trefferlage	0.00 mm , 0.32 mm hoch				
Streuwert	1.64, horizontal: 2.06, vertikal: 1.08				

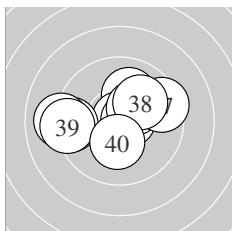

Serie 4:	10.0 ↑	10.9 *	10.7 *	9.3 ←	9.0 ←
	10.3 *	9.5 →	10.0 ↗	9.2 ←	10.3 *
beste Teiler	19.0 (32.) 71.7 (33.) 157.1 (36.)				
Trefferlage	0.55 mm links, 0.39 mm hoch				
Streuwert	2.15, horizontal: 2.82, vertikal: 1.13				

Unterschrift des Schützen

Ergebnis: **383** (397.5)
 Serien: 95 97 95 96
 Zähler: 23 17 0 0 0 0 0 0 0 0
 Innenzehner: 16
 weiteste: 494 (33), 486 (17), 475 (1)
 beste Teiler 25.2 (37.) 53.5 (13.) 75.4 (9.)
 Trefferlage 0.35 mm links, 0.33 mm tief
 Streuwert 2.02, horizontal: 1.91, vertikal: 2.12

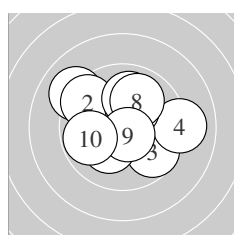
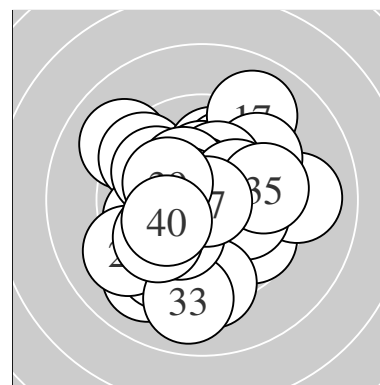

Serie 1:
 9.1 ↘ 9.5 ↘ 9.7 ↘ 9.1 → 10.3 *
 10.0 ↑ 10.2 * 10.0 ↑ 10.7 * 9.8 ←
 beste Teiler 75.4 (9.) 166.0 (5.) 193.0 (7.)
 Trefferlage 0.04 mm links, 0.60 mm hoch
 Streuwert 2.25, horizontal: 2.64, vertikal: 1.78

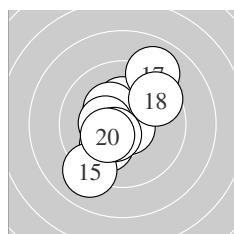

Serie 2:
 10.1 ↙ 10.3 * 10.7 * 10.3 * 9.1 ↘
 10.4 * 9.0 ↗ 9.6 ↗ 10.5 * 10.3 *
 beste Teiler 53.5 (13.) 109.6 (19.) 143.2 (16.)
 Trefferlage 0.27 mm links, 0.16 mm hoch
 Streuwert 2.01, horizontal: 1.75, vertikal: 2.24

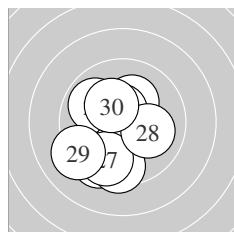

Serie 3:
 9.9 ↘ 10.2 * 10.1 ↓ 9.4 ↙ 9.5 ↓
 10.6 * 9.6 ↙ 10.1 → 9.2 ↙ 10.3 *
 beste Teiler 94.9 (26.) 165.8 (30.) 182.9 (22.)
 Trefferlage 0.81 mm links, 0.99 mm tief
 Streuwert 1.91, horizontal: 1.63, vertikal: 2.16

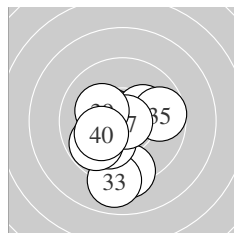

Serie 4:
 10.6 * 9.3 ↓ 9.0 ↓ 10.2 * 9.7 →
 10.1 ↙ 10.9 * 9.8 ↙ 10.2 * 10.1 ←
 beste Teiler 25.2 (37.) 97.5 (31.) 183.8 (34.)
 Trefferlage 0.29 mm links, 1.11 mm tief
 Streuwert 1.87, horizontal: 1.66, vertikal: 2.06

Unterschrift des Schützen

Meyton Elektronik

Ergebnis: **386** (405.3)
 Serien: 96 97 95 98
 Zähler: 28 10 2 0 0 0 0 0 0 0
 Innenzehner: 21
 weiteste: 552 (27), 524 (19), 335 (8)
 beste Teiler 16.6 (14.) 73.2 (23.) 82.2 (16.)
 Trefferlage 0.09 mm rechts, 0.23 mm hoch
 Streuwert 1.66, horizontal: 2.07, vertikal: 1.11

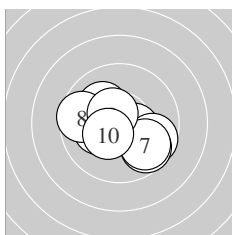
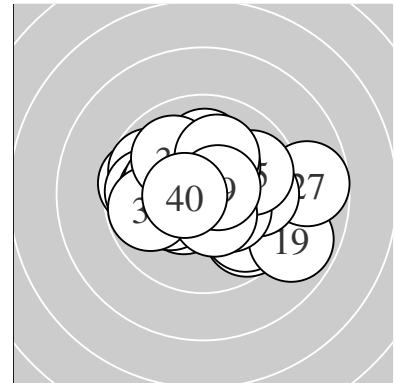

Serie 1:
 10.4 * 10.2 * 9.7 ↘ 10.1 ↖ 9.7 ↘
 10.2 * 9.8 ↘ 9.6 ← 10.5 * 10.4 *
 beste Teiler 106.0 (9.) 133.8 (1.) 138.7 (10.)
 Trefferlage 0.13 mm links, 0.39 mm tief
 Streuwert 1.74, horizontal: 2.14, vertikal: 1.21

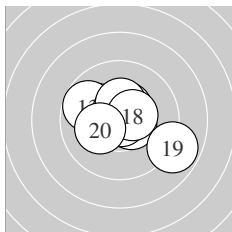

Serie 2:
 10.1 ↖ 10.5 * 9.7 ↖ 10.9 * 10.5 *
 10.6 * 10.4 * 10.5 * 8.9 ↘ 10.2 *
 beste Teiler 16.6 (14.) 82.2 (16.) 108.7 (12.)
 Trefferlage 0.10 mm rechts, 0.24 mm hoch
 Streuwert 1.69, horizontal: 2.08, vertikal: 1.18

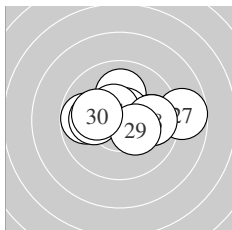

Serie 3:
 10.0 ↑ 9.8 → 10.7 * 10.5 * 9.8 ←
 10.1 ← 8.7 → 9.8 → 10.3 * 10.1 ←
 beste Teiler 73.2 (23.) 105.6 (24.) 161.0 (29.)
 Trefferlage 0.52 mm rechts, 0.42 mm hoch
 Streuwert 1.96, horizontal: 2.65, vertikal: 0.80

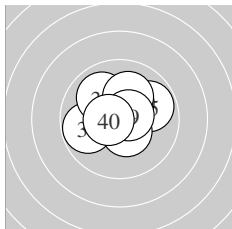

Serie 4:
 10.5 * 10.4 * 9.8 ← 10.0 ↖ 9.8 →
 10.3 * 10.5 * 10.1 ↑ 10.6 * 10.6 *
 beste Teiler 85.6 (39.) 97.3 (40.) 123.0 (31.)
 Trefferlage 0.11 mm links, 0.67 mm hoch
 Streuwert 1.32, horizontal: 1.54, vertikal: 1.06

Unterschrift des Schützen

Meyton Elektronik

Ergebnis:	383	(401.3)
Serien:	96 96 93 98	
Zähler:	25 14 0 1 0 0 0 0 0 0	
Innenzehner:	22	
weiteste:	863 (25), 479 (30), 447 (18)	
beste Teiler	64.5 (7.) 76.3 (8.) 79.1 (34.)	
Trefferlage	0.09 mm rechts, 0.21 mm tief	
Streuwert	1.99, horizontal: 2.30, vertikal: 1.62	

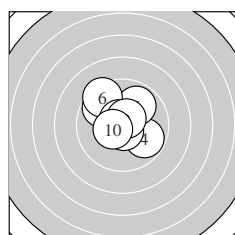
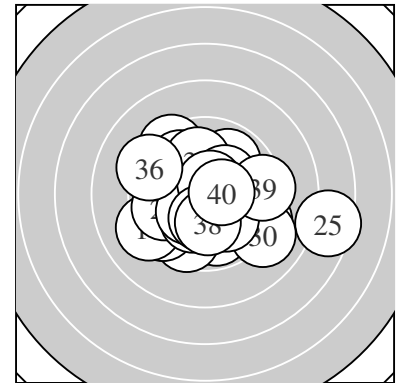

Serie 1:	10.6 *	10.3 *	9.7 ↘	9.8 ↘	9.9 ↗
	9.4 ↘	10.7 *	10.6 *	10.6 *	10.5 *
beste Teiler	64.5 (7.)	76.3 (8.)	85.9 (9.)		
Trefferlage	0.26 mm links, 0.86 mm hoch				
Streuwert	1.47, horizontal: 1.52, vertikal: 1.42				

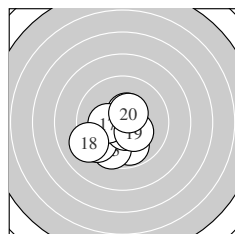

Serie 2:	9.8 ↓	10.5 *	9.6 ↓	9.5 ↙	10.6 *
	10.6 *	10.3 *	9.2 ↙	10.3 *	10.5 *
beste Teiler	80.7 (15.)	100.8 (16.)	114.9 (12.)		
Trefferlage	0.57 mm links, 0.97 mm tief				
Streuwert	1.66, horizontal: 1.74, vertikal: 1.58				

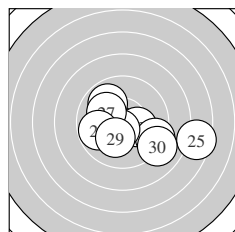

Serie 3:	10.6 *	9.9 ↘	10.3 *	9.3 ↘	7.5 →
	10.6 *	10.1 ↘	9.8 ↙	10.2 *	9.0 ↘
beste Teiler	84.4 (21.)	86.9 (26.)	175.8 (23.)		
Trefferlage	0.94 mm rechts, 0.75 mm tief				
Streuwert	2.67, horizontal: 3.48, vertikal: 1.48				

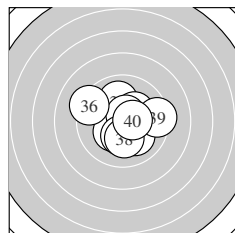

Serie 4:	10.0 ↑	10.3 *	10.3 *	10.6 *	10.1 ↘
	9.3 ↘	10.3 *	10.2 *	9.4 →	10.5 *
beste Teiler	79.1 (34.)	113.5 (40.)	163.4 (33.)		
Trefferlage	0.27 mm rechts, 0.00 mm				
Streuwert	1.78, horizontal: 2.00, vertikal: 1.53				

Unterschrift des Schützen

Ergebnis:	386	(403.0)
Serien:	98	92 98 98
Zähler:	28	11 0 1 0 0 0 0 0 0
Innenzehner:	20	
weiteste:	943	(12), 351 (25), 342 (39)
beste Teiler	40.7	(6.) 63.6 (32.) 89.8 (13.)
Trefferlage	0.07 mm	rechts, 0.01 mm tief
Streuwert	1.87,	horizontal: 2.09, vertikal: 1.62

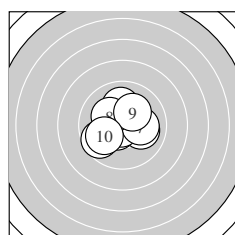
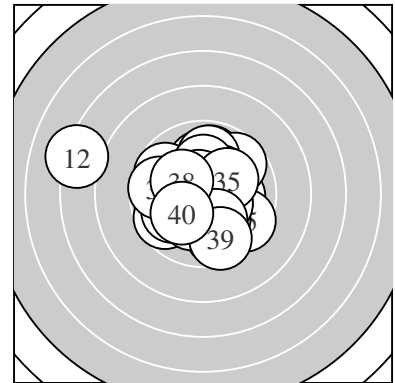

Serie 1:	10.6 *	10.0 →	9.7 ↙	10.5 *	10.0 ↑
	10.8 *	10.1 →	10.2 *	10.2 *	9.9 ↙
beste Teiler	40.7 (6.)	98.4 (1.)	105.9 (4.)		
Trefferlage	0.23 mm links, 0.11 mm hoch				
Streuwert	1.50, horizontal: 1.67, vertikal: 1.30				

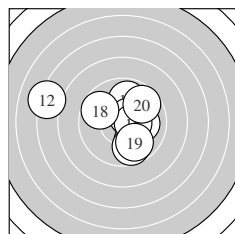

Serie 2:	9.9 ↑	7.2 ↖	10.6 *	10.0 ↘	10.1 →
	10.5 *	9.7 ↘	9.7 ↖	9.8 ↘	9.7 ↗
beste Teiler	89.8 (13.)	125.4 (16.)	221.5 (15.)		
Trefferlage	0.11 mm links, 0.17 mm hoch				
Streuwert	2.85, horizontal: 3.43, vertikal: 2.10				

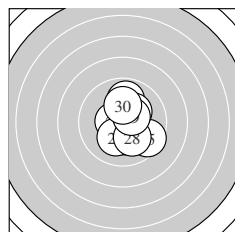

Serie 3:	10.5 *	10.3 *	9.9 ↑	10.4 *	9.5 ↘
	10.2 *	10.2 *	10.1 ↘	10.5 *	10.2 *
beste Teiler	106.4 (21.)	124.0 (29.)	143.4 (24.)		
Trefferlage	0.60 mm rechts, 0.06 mm hoch				
Streuwert	1.47, horizontal: 1.15, vertikal: 1.74				

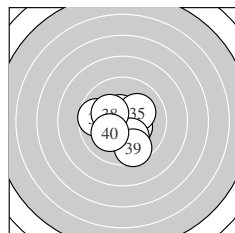

Serie 4:	10.4 *	10.7 *	10.6 *	10.4 *	10.2 *
	9.7 ←	10.1 ↘	10.2 *	9.6 ↘	10.1 ↙
beste Teiler	63.6 (32.)	96.1 (33.)	144.8 (31.)		
Trefferlage	0.05 mm rechts, 0.40 mm tief				
Streuwert	1.52, horizontal: 1.61, vertikal: 1.42				

Unterschrift des Schützen

Meyton Elektronik

Ergebnis: **357** (376.0)
 Serien: 89 90 89 89
 Zähler: 10 18 11 1 0 0 0 0 0 0
 Innenzehner: 8
 weiteste: 832 (7), 716 (2), 707 (17)
 beste Teiler 52.3 (14.) 113.8 (18.) 137.3 (4.)
 Trefferlage 0.66 mm links, 0.09 mm tief
 Streuwert 3.05, horizontal: 3.52, vertikal: 2.49

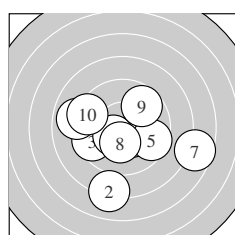
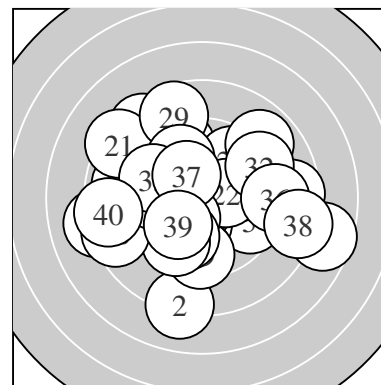

Serie 1:
 10.4 * 8.1 ↓ 9.5 ← 10.4 * 9.6 →
 8.9 ← 7.6 → 10.3 * 9.7 ↗ 9.3 ←
 beste Teiler 137.3 (4.) 149.2 (1.) 169.1 (8.)
 Trefferlage 0.07 mm links, 1.14 mm tief
 Streuwert 3.27, horizontal: 3.84, vertikal: 2.57

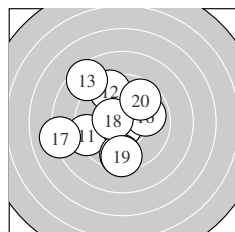

Serie 2:
 9.3 ← 9.5 ↖ 8.5 ↘ 10.7 * 9.5 ↓
 9.9 → 8.1 ← 10.5 * 9.5 ↓ 9.7 ↗
 beste Teiler 52.3 (14.) 113.8 (18.) 261.1 (16.)
 Trefferlage 1.32 mm links, 0.07 mm hoch
 Streuwert 2.84, horizontal: 2.86, vertikal: 2.82

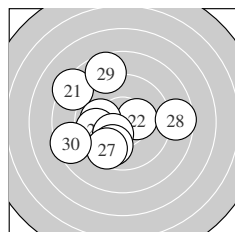

Serie 3:
 8.3 ↘ 10.3 * 10.0 ← 9.7 ← 10.3 *
 9.8 ↓ 9.6 ↓ 8.6 → 8.7 ↖ 8.5 ←
 beste Teiler 159.2 (22.) 167.8 (25.) 243.7 (23.)
 Trefferlage 1.48 mm links, 0.01 mm hoch
 Streuwert 3.02, horizontal: 3.33, vertikal: 2.68

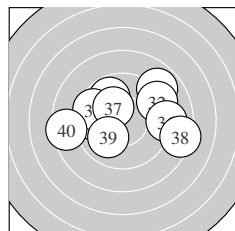

Serie 4:
 8.9 ↗ 9.2 ↗ 9.8 ↖ 9.7 ← 9.6 ←
 9.0 → 10.2 * 8.3 → 10.0 ↙ 8.5 ←
 beste Teiler 181.3 (37.) 237.2 (39.) 292.7 (33.)
 Trefferlage 0.21 mm rechts, 0.67 mm hoch
 Streuwert 3.21, horizontal: 4.15, vertikal: 1.82

Unterschrift des Schützen

Meyton Elektronik

Ergebnis: **380** (398.8)
 Serien: 96 94 95 95
 Zähler: 20 20 0 0 0 0 0 0 0 0
 Innenzehner: 14
 weiteste: 483 (40), 454 (16), 416 (2)
 beste Teiler 45.1 (25.) 48.1 (12.) 55.5 (24.)
 Trefferlage 0.56 mm rechts, 0.51 mm tief
 Streuwert 1.87, horizontal: 2.08, vertikal: 1.63

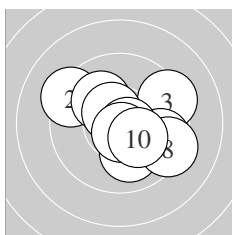
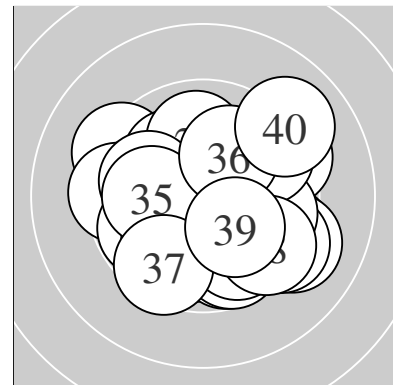

Serie 1:
 10.0 ↘ 9.3 ↖ 9.4 ↗ 10.1 ↖ 9.6 ↗
 10.5 * 10.7 * 9.3 ↘ 10.7 * 10.3 *
 beste Teiler 67.5 (7.) 70.4 (9.) 101.6 (6.)
 Trefferlage 0.74 mm rechts, 0.09 mm tief
 Streuwert 1.97, horizontal: 2.32, vertikal: 1.54

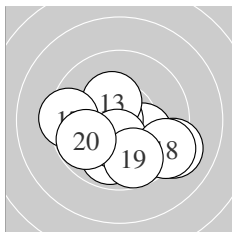

Serie 2:
 10.2 * 10.8 * 10.3 * 9.9 ↓ 10.4 *
 9.1 ↗ 9.4 ← 9.3 ↘ 9.7 ↓ 9.8 ↖
 beste Teiler 48.1 (12.) 144.2 (15.) 151.5 (13.)
 Trefferlage 0.19 mm rechts, 1.19 mm tief
 Streuwert 1.98, horizontal: 2.45, vertikal: 1.36

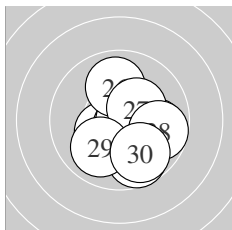

Serie 3:
 9.9 → 9.7 ↓ 10.4 * 10.7 * 10.8 *
 9.9 ↑ 10.3 * 9.7 → 10.0 ↙ 9.8 ↓
 beste Teiler 45.1 (25.) 55.5 (24.) 144.2 (23.)
 Trefferlage 0.73 mm rechts, 0.67 mm tief
 Streuwert 1.53, horizontal: 1.46, vertikal: 1.58

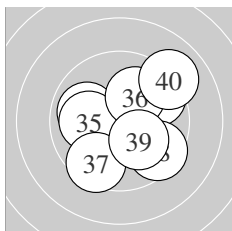

Serie 4:
 10.5 * 9.9 ↖ 9.6 ↗ 10.6 * 10.0 ←
 10.1 ↗ 9.5 ↙ 9.5 ↘ 10.1 ↓ 9.0 ↗
 beste Teiler 96.7 (34.) 117.3 (31.) 201.5 (39.)
 Trefferlage 0.59 mm rechts, 0.10 mm tief
 Streuwert 2.10, horizontal: 2.22, vertikal: 1.97

Unterschrift des Schützen

Meyton Elektronik

Ergebnis: **393** (411.1)
 Serien: 100 97 96 100
 Zähler: 34 5 1 0 0 0 0 0 0 0
 Innenzehner: 30
 weiteste: 577 (29), 332 (26), 324 (14)
 beste Teiler 23.4 (35.) 37.8 (1.) 80.1 (27.)
 Trefferlage 0.03 mm links, 0.30 mm hoch
 Streuwert 1.38, horizontal: 1.64, vertikal: 1.06

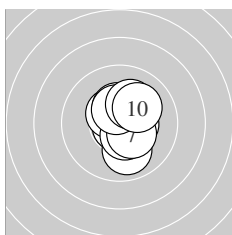
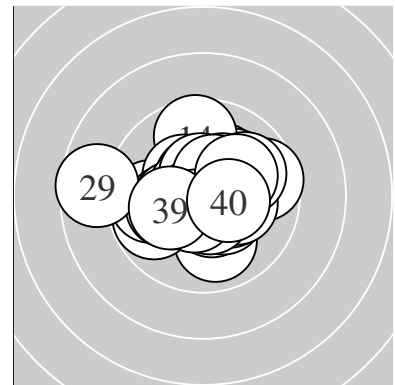

Serie 1:
 10.8 * 10.5 * 10.4 * 10.0 ↓ 10.5 *
 10.4 * 10.4 * 10.5 * 10.2 * 10.1 ↗
 beste Teiler 37.8 (1.) 118.1 (5.) 119.5 (2.)
 Trefferlage 0.45 mm rechts, 0.18 mm hoch
 Streuwert 1.12, horizontal: 0.81, vertikal: 1.36

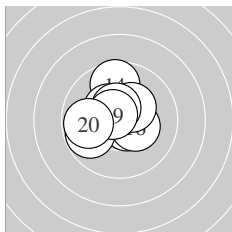

Serie 2:
 10.6 * 9.8 ↙ 10.4 * 9.7 ↑ 10.4 *
 10.3 * 10.3 * 10.5 * 10.6 * 9.8 ←
 beste Teiler 81.0 (19.) 84.6 (11.) 114.5 (18.)
 Trefferlage 0.51 mm links, 0.57 mm hoch
 Streuwert 1.34, horizontal: 1.41, vertikal: 1.28

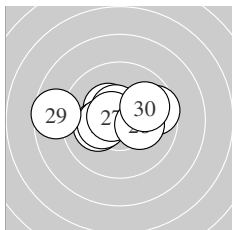

Serie 3:
 10.4 * 10.1 ← 10.2 * 10.6 * 10.3 *
 9.6 → 10.6 * 10.2 * 8.6 ← 9.9 ↗
 beste Teiler 80.1 (27.) 100.6 (24.) 149.9 (21.)
 Trefferlage 0.22 mm links, 0.39 mm hoch
 Streuwert 1.93, horizontal: 2.64, vertikal: 0.65

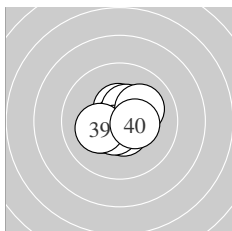

Serie 4:
 10.3 * 10.3 * 10.5 * 10.6 * 10.9 *
 10.5 * 10.6 * 10.1 ↗ 10.2 * 10.4 *
 beste Teiler 23.4 (35.) 94.5 (37.) 98.7 (34.)
 Trefferlage 0.13 mm rechts, 0.05 mm hoch
 Streuwert 1.05, horizontal: 1.22, vertikal: 0.85

Unterschrift des Schützen

Meyton Elektronik

Ergebnis: **390** (409.4)
 Serien: 96 98 99 97
 Zähler: 30 10 0 0 0 0 0 0 0 0
 Innenzehner: 26
 weiteste: 434 (33), 365 (3), 325 (11)
 beste Teiler 47.3 (5.) 60.4 (22.) 70.1 (16.)
 Trefferlage 0.40 mm links, 0.79 mm hoch
 Streuwert 1.31, horizontal: 1.44, vertikal: 1.17

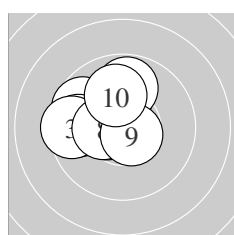
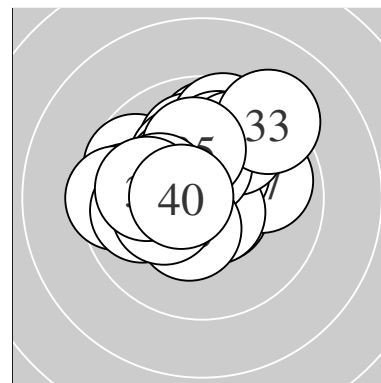

Serie 1:
 9.7 ↖ 9.7 ← 9.5 ← 10.5 * 10.8 *
 10.2 * 9.8 ↑ 10.4 * 10.6 * 10.0 ↑
 beste Teiler 47.3 (5.) 83.0 (9.) 112.4 (4.)
 Trefferlage 1.22 mm links, 0.81 mm hoch
 Streuwert 1.36, horizontal: 1.52, vertikal: 1.18

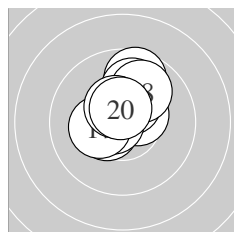

Serie 2:
 9.7 ↑ 10.5 * 10.0 ↑ 10.5 * 10.4 *
 10.7 * 10.3 * 9.9 ↑ 10.5 * 10.6 *
 beste Teiler 70.1 (16.) 100.1 (20.) 121.1 (12.)
 Trefferlage 0.03 mm rechts, 1.07 mm hoch
 Streuwert 1.12, horizontal: 1.01, vertikal: 1.22

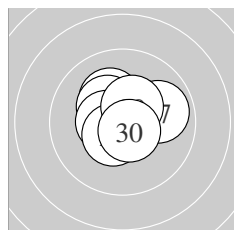

Serie 3:
 10.2 * 10.7 * 10.4 * 10.6 * 10.3 *
 10.5 * 9.9 → 10.5 * 10.4 * 10.6 *
 beste Teiler 60.4 (22.) 78.4 (30.) 90.0 (24.)
 Trefferlage 0.17 mm rechts, 0.50 mm hoch
 Streuwert 1.01, horizontal: 1.19, vertikal: 0.80

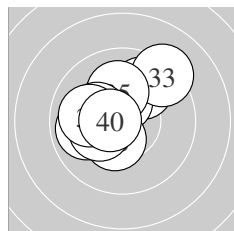

Serie 4:
 9.9 ↗ 10.4 * 9.2 ↗ 9.9 ← 10.1 ↑
 10.4 * 10.2 * 10.3 * 10.0 ← 10.6 *
 beste Teiler 90.1 (40.) 141.2 (32.) 143.0 (36.)
 Trefferlage 0.60 mm links, 0.76 mm hoch
 Streuwert 1.59, horizontal: 1.70, vertikal: 1.48

Unterschrift des Schützen

Meyton Elektronik

Ergebnis: **389** (405.7)
 Serien: 97 96 100 96
 Zähler: 31 7 2 0 0 0 0 0 0 0
 Innenzehner: 24
 weiteste: 543 (35), 504 (16), 382 (10)
 beste Teiler 48.7 (9.) 63.3 (4.) 67.6 (11.)
 Trefferlage 0.26 mm rechts, 0.27 mm hoch
 Streuwert 1.64, horizontal: 1.82, vertikal: 1.43

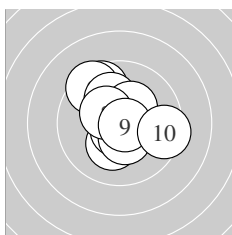
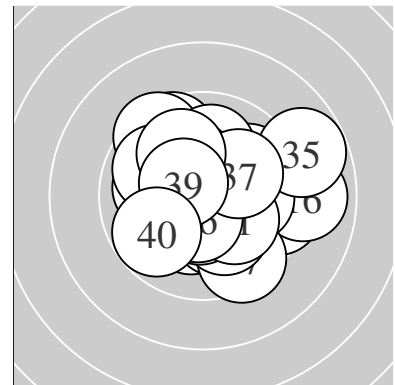

Serie 1:
 9.6 ↘ 9.5 ↘ 10.2 * 10.7 * 10.1 ↗
 10.3 * 10.4 * 10.4 * 10.8 * 9.4 →
 beste Teiler 48.7 (9.) 63.3 (4.) 131.9 (7.)
 Trefferlage 0.09 mm links, 0.57 mm hoch
 Streuwert 1.69, horizontal: 1.67, vertikal: 1.71

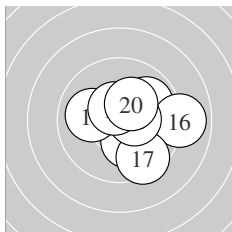

Serie 2:
 10.7 * 10.2 * 10.3 * 10.0 ← 9.9 ↗
 8.9 → 9.5 ↘ 10.4 * 10.5 * 10.3 *
 beste Teiler 67.6 (11.) 106.6 (19.) 126.2 (18.)
 Trefferlage 0.97 mm rechts, 0.08 mm hoch
 Streuwert 1.73, horizontal: 1.96, vertikal: 1.47

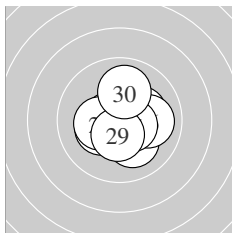

Serie 3:
 10.6 * 10.2 * 10.1 ↘ 10.6 * 10.3 *
 10.0 → 10.5 * 10.3 * 10.5 * 10.0 ↑
 beste Teiler 81.7 (21.) 86.4 (24.) 103.7 (27.)
 Trefferlage 0.24 mm rechts, 0.06 mm tief
 Streuwert 1.24, horizontal: 1.33, vertikal: 1.15

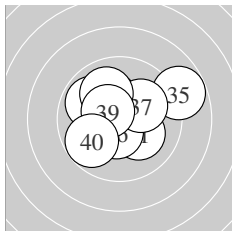

Serie 4:
 10.2 * 10.4 * 10.3 * 9.9 ↘ 8.8 →
 10.5 * 10.1 ↗ 10.0 ↘ 10.5 * 9.8 ↙
 beste Teiler 112.8 (36.) 118.4 (39.) 142.0 (32.)
 Trefferlage 0.07 mm links, 0.49 mm hoch
 Streuwert 1.90, horizontal: 2.26, vertikal: 1.45

Unterschrift des Schützen

Meyton Elektronik

Ergebnis: **393** (409.9)
 Serien: 99 99 97 98
 Zähler: 33 7 0 0 0 0 0 0 0 0
 Innenzehner: 24
 weiteste: 414 (32), 350 (28), 318 (29)
 beste Teiler 16.1 (31.) 48.2 (6.) 51.4 (25.)
 Trefferlage 0.12 mm links, 0.24 mm tief
 Streuwert 1.41, horizontal: 1.56, vertikal: 1.24

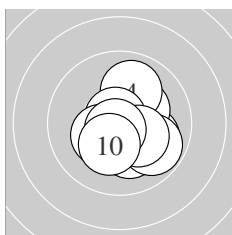
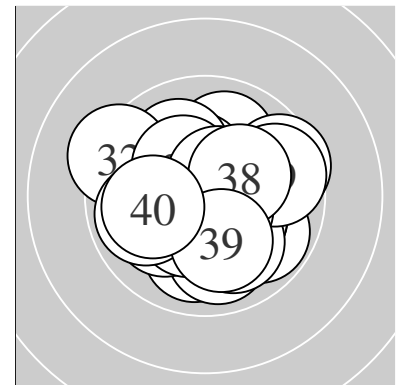

Serie 1:
 10.0 ↘ 10.2 * 10.3 * 10.0 ↑ 9.8 ↘
 10.8 * 10.3 * 10.3 * 10.7 * 10.3 *
 beste Teiler 48.2 (6.) 56.8 (9.) 158.0 (8.)
 Trefferlage 0.60 mm rechts, 0.45 mm tief
 Streuwert 1.27, horizontal: 1.24, vertikal: 1.30

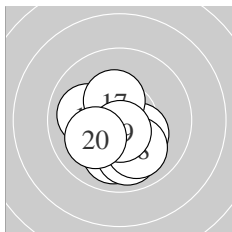

Serie 2:
 10.3 * 10.0 ↓ 10.3 * 9.9 ↓ 10.5 *
 10.0 ← 10.4 * 10.0 ↘ 10.6 * 10.1 ↙
 beste Teiler 82.2 (19.) 101.8 (15.) 147.2 (17.)
 Trefferlage 0.36 mm links, 0.90 mm tief
 Streuwert 1.24, horizontal: 1.20, vertikal: 1.28

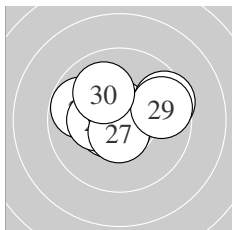

Serie 3:
 10.7 * 10.6 * 9.8 ↖ 10.3 * 10.7 *
 10.7 * 10.6 * 9.6 ↗ 9.7 → 10.0 ↘
 beste Teiler 51.4 (25.) 60.0 (21.) 69.8 (26.)
 Trefferlage 0.07 mm links, 0.39 mm hoch
 Streuwert 1.49, horizontal: 1.90, vertikal: 0.91

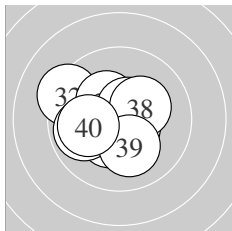

Serie 4:
 10.9 * 9.3 ↖ 10.4 * 10.3 * 9.9 ←
 10.6 * 10.6 * 10.3 * 10.1 ↓ 10.0 ←
 beste Teiler 16.1 (31.) 93.4 (36.) 98.2 (37.)
 Trefferlage 0.66 mm links, 0.02 mm tief
 Streuwert 1.48, horizontal: 1.72, vertikal: 1.19

Unterschrift des Schützen

Meyton Elektronik

Ergebnis: **387** (404.1)
 Serien: 95 98 96 98
 Zähler: 28 11 1 0 0 0 0 0 0 0
 Innenzehner: 24
 weiteste: 529 (2), 490 (14), 452 (38)
 beste Teiler 14.7 (27.) 18.8 (13.) 50.0 (24.)
 Trefferlage 0.31 mm links, 0.23 mm hoch
 Streuwert 1.81, horizontal: 2.14, vertikal: 1.41

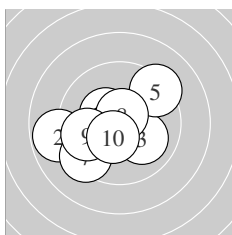
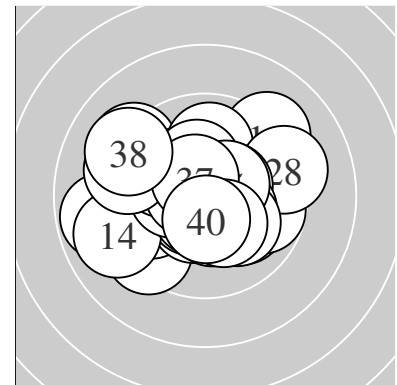

Serie 1:
 10.7 * 8.8 ← 10.0 ↘ 10.4 * 9.3 ↗
 10.6 * 9.3 ↙ 10.7 * 9.8 ← 10.4 *
 beste Teiler 52.0 (1.) 73.7 (8.) 90.6 (6.)
 Trefferlage 0.81 mm links, 0.40 mm tief
 Streuwert 2.01, horizontal: 2.40, vertikal: 1.52

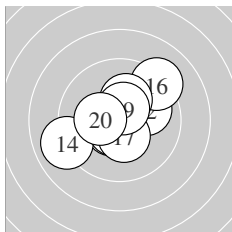

Serie 2:
 10.5 * 10.0 → 10.9 * 9.0 ← 10.6 *
 9.2 ↗ 10.4 * 10.2 * 10.5 * 10.3 *
 beste Teiler 18.8 (13.) 93.5 (15.) 103.7 (19.)
 Trefferlage 0.08 mm links, 0.17 mm hoch
 Streuwert 1.83, horizontal: 2.08, vertikal: 1.53

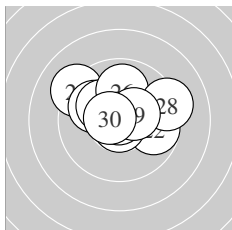

Serie 3:
 9.2 ↘ 9.8 → 10.0 ↘ 10.8 * 10.2 *
 9.9 ↑ 10.9 * 9.3 → 10.4 * 10.6 *
 beste Teiler 14.7 (27.) 50.0 (24.) 85.9 (30.)
 Trefferlage 0.01 mm rechts, 0.84 mm hoch
 Streuwert 1.81, horizontal: 2.29, vertikal: 1.13

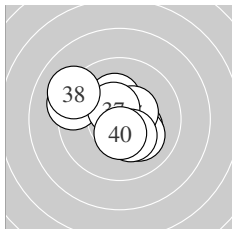

Serie 4:
 10.3 * 10.5 * 10.3 * 10.1 ↘ 10.5 *
 9.3 ↙ 10.5 * 9.1 ↘ 10.3 * 10.5 *
 beste Teiler 103.9 (37.) 107.0 (32.) 120.1 (40.)
 Trefferlage 0.37 mm links, 0.31 mm hoch
 Streuwert 1.73, horizontal: 2.03, vertikal: 1.36

Unterschrift des Schützen

Meyton Elektronik

Ergebnis: **393** (409.2)
 Serien: 98 99 98 98
 Zähler: 33 7 0 0 0 0 0 0 0 0
 Innenzehner: 26
 weiteste: 428 (34), 389 (29), 313 (33)
 beste Teiler 32.2 (25.) 36.0 (40.) 37.6 (6.)
 Trefferlage 0.47 mm rechts, 0.70 mm hoch
 Streuwert 1.32, horizontal: 1.37, vertikal: 1.26

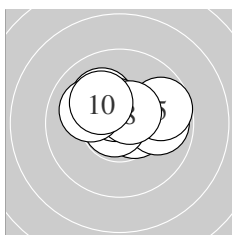
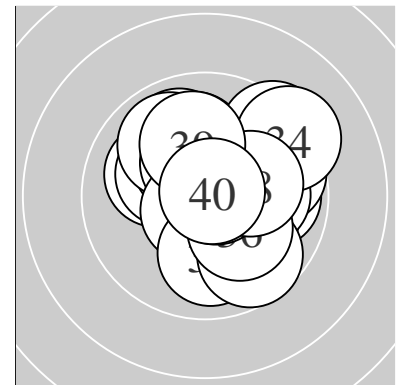

Serie 1:
 10.5 * 9.9 → 10.6 * 10.1 ↘ 9.7 →
 10.8 * 10.6 * 10.5 * 10.1 ↖ 10.2 *
 beste Teiler 37.6 (6.) 87.7 (3.) 99.3 (7.)
 Trefferlage 0.17 mm rechts, 0.71 mm hoch
 Streuwert 1.26, horizontal: 1.66, vertikal: 0.65

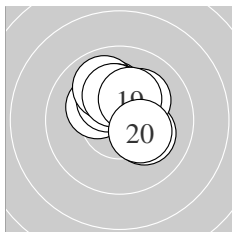

Serie 2:
 10.2 * 10.2 * 10.3 * 10.2 * 10.2 *
 9.9 ↘ 10.3 * 10.2 * 10.3 * 10.3 *
 beste Teiler 163.1 (13.) 165.5 (20.) 167.2 (19.)
 Trefferlage 0.07 mm rechts, 1.13 mm hoch
 Streuwert 1.14, horizontal: 1.17, vertikal: 1.11

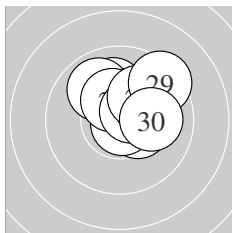

Serie 3:
 10.1 ↑ 10.4 * 10.4 * 9.9 ↘ 10.8 *
 10.4 * 10.5 * 10.1 ↗ 9.4 ↗ 10.1 →
 beste Teiler 32.2 (25.) 102.8 (27.) 138.5 (22.)
 Trefferlage 0.63 mm rechts, 1.13 mm hoch
 Streuwert 1.22, horizontal: 1.34, vertikal: 1.10

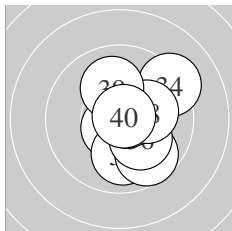

Serie 4:
 10.6 * 10.0 ↓ 9.7 ↘ 9.2 ↗ 10.5 *
 10.2 * 10.8 * 10.2 * 10.0 ↑ 10.8 *
 beste Teiler 36.0 (40.) 50.3 (37.) 79.6 (31.)
 Trefferlage 1.00 mm rechts, 0.15 mm tief
 Streuwert 1.48, horizontal: 1.26, vertikal: 1.67

Unterschrift des Schützen

Meyton Elektronik

Ergebnis:	366	(380.5)
Serien:	92 91 92 91	
Zähler:	15 17 7 1 0 0 0 0 0 0	
Innenzehner:	9	
weiteste:	920 (25), 741 (12), 675 (34)	
beste Teiler	64.3 (40.) 104.7 (4.) 124.0 (36.)	
Trefferlage	0.42 mm rechts, 0.10 mm tief	
Streuwert	2.91, horizontal: 3.25, vertikal: 2.53	

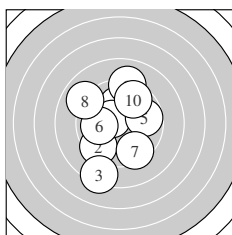
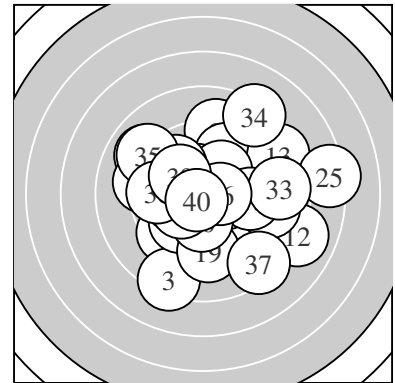

Serie 1:	10.1 ↑	9.4 ↙	8.3 ↘	10.5 *	9.7 →
	10.0 ←	9.5 ↘	9.0 ↖	9.1 ↑	9.6 ↗
beste Teiler	104.7 (4.)	218.0 (1.)	245.9 (6.)		
Trefferlage	0.54 mm links, 0.10 mm hoch				
Streuwert	2.87, horizontal: 2.34, vertikal: 3.31				

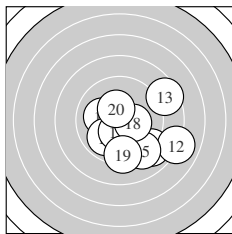

Serie 2:	8.9 ↘	8.0 ↘	8.5 ↗	10.1 ←	9.2 ↘
	9.9 ↗	10.4 *	10.3 *	9.3 ↓	10.4 *
beste Teiler	139.4 (17.)	142.3 (20.)	163.1 (18.)		
Trefferlage	1.61 mm rechts, 1.31 mm tief				
Streuwert	2.68, horizontal: 3.00, vertikal: 2.32				

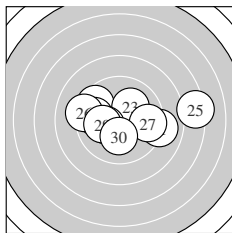

Serie 3:	9.0 →	9.6 ↖	10.1 ↗	9.7 ←	7.3 →
	9.2 ←	9.6 →	10.2 *	10.1 ←	10.2 *
beste Teiler	176.1 (28.)	192.2 (30.)	206.7 (23.)		
Trefferlage	0.45 mm rechts, 0.18 mm hoch				
Streuwert	3.10, horizontal: 4.21, vertikal: 1.24				

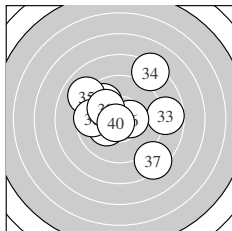

Serie 4:	9.8 ↖	10.2 *	8.7 →	8.3 ↗	9.0 ↖
	10.5 *	8.4 ↘	9.6 ←	10.1 ↖	10.7 *
beste Teiler	64.3 (40.)	124.0 (36.)	182.8 (32.)		
Trefferlage	0.15 mm rechts, 0.59 mm hoch				
Streuwert	3.03, horizontal: 3.28, vertikal: 2.75				

Unterschrift des Schützen

Meyton Elektronik

Ergebnis: **389** (406.7)
 Serien: 98 96 98 97
 Zähler: 29 11 0 0 0 0 0 0 0 0
 Innenzehner: 22
 weiteste: 452 (9), 380 (40), 356 (15)
 beste Teiler 23.5 (3.) 26.8 (4.) 60.1 (19.)
 Trefferlage 0.15 mm links, 0.46 mm hoch
 Streuwert 1.53, horizontal: 1.60, vertikal: 1.46

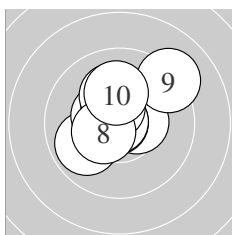
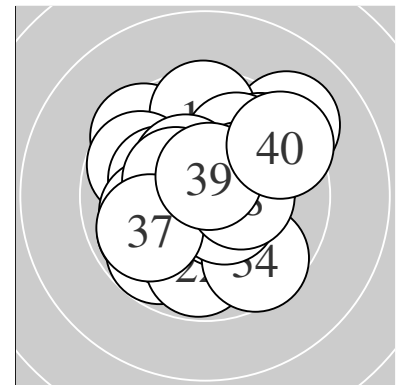

Serie 1:
 10.5 * 9.9 ↙ 10.9 * 10.8 * 10.4 *
 10.5 * 10.2 * 10.4 * 9.1 ↗ 10.1 ↑
 beste Teiler 23.5 (3.) 26.8 (4.) 118.3 (6.)
 Trefferlage 0.17 mm links, 0.69 mm hoch
 Streuwert 1.44, horizontal: 1.54, vertikal: 1.34

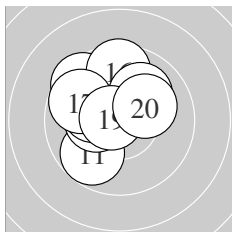

Serie 2:
 9.8 ↘ 10.3 * 10.1 ↑ 10.2 * 9.5 ↖
 9.6 ↑ 9.7 ↘ 10.0 ↗ 10.7 * 10.1 ↗
 beste Teiler 60.1 (19.) 163.0 (12.) 193.3 (14.)
 Trefferlage 0.74 mm links, 1.05 mm hoch
 Streuwert 1.60, horizontal: 1.63, vertikal: 1.58

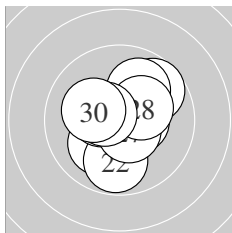

Serie 3:
 10.1 ↘ 9.8 ↓ 10.4 * 9.7 ↗ 10.5 *
 10.0 ↗ 10.6 * 10.3 * 10.5 * 10.2 *
 beste Teiler 98.4 (27.) 111.2 (29.) 123.1 (25.)
 Trefferlage 0.12 mm rechts, 0.12 mm hoch
 Streuwert 1.49, horizontal: 1.46, vertikal: 1.53

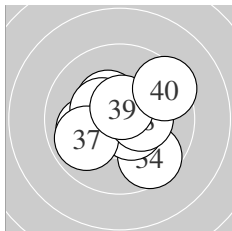

Serie 4:
 10.7 * 10.4 * 10.0 ↙ 9.6 ↘ 10.4 *
 10.5 * 9.9 ↙ 10.3 * 10.6 * 9.4 ↗
 beste Teiler 67.9 (31.) 83.7 (39.) 103.4 (36.)
 Trefferlage 0.17 mm rechts, 0.00 mm
 Streuwert 1.60, horizontal: 1.82, vertikal: 1.36

Unterschrift des Schützen

Meyton Elektronik

Ergebnis:	380	(399.7)
Serien:	95 94 94 97	
Zähler:	22 16 2 0 0 0 0 0 0 0	
Innenzehner:	18	
weiteste:	580 (13), 562 (9), 417 (26)	
beste Teiler	11.1 (6.) 45.2 (7.) 68.1 (27.)	
Trefferlage	0.28 mm rechts, 0.43 mm hoch	
Streuwert	1.92, horizontal: 2.11, vertikal: 1.72	

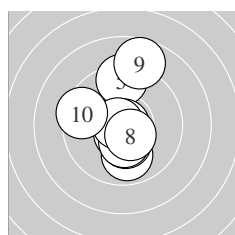
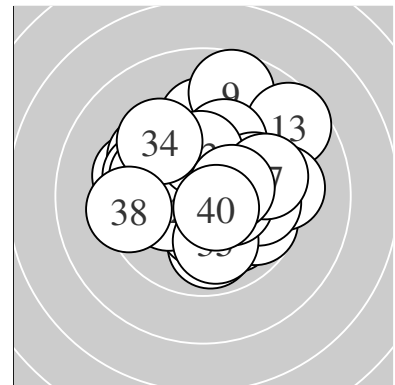

Serie 1:	10.6 *	9.9 ↓	10.3 *	10.4 *	9.4 ↑
	10.9 *	10.8 *	10.5 *	8.7 ↑	9.5 ↖
beste Teiler	11.1 (6.)	45.2 (7.)	79.4 (1.)		
Trefferlage	0.12 mm links, 0.34 mm hoch				
Streuwert	2.02, horizontal: 1.32, vertikal: 2.53				

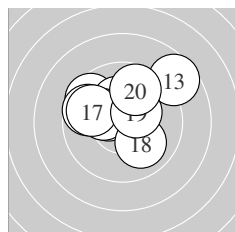

Serie 2:	10.4 *	9.6 ↖	8.6 ↗	9.7 ↖	10.2 *
	10.2 *	9.8 ↖	10.0 ↘	10.4 *	9.7 ↑
beste Teiler	135.9 (11.)	148.2 (19.)	178.0 (16.)		
Trefferlage	0.34 mm links, 1.27 mm hoch				
Streuwert	2.00, horizontal: 2.42, vertikal: 1.47				

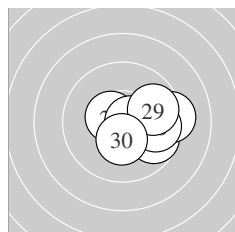

Serie 3:	9.8 →	10.5 *	10.5 *	9.7 ↘	9.5 →
	9.3 →	10.7 *	9.8 →	9.8 →	10.3 *
beste Teiler	68.1 (27.)	109.4 (22.)	112.4 (23.)		
Trefferlage	1.89 mm rechts, 0.09 mm tief				
Streuwert	1.36, horizontal: 1.70, vertikal: 0.90				

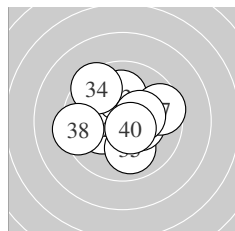

Serie 4:	10.1 ↖	10.2 *	10.1 ↑	9.5 ↖	10.0 ↓
	10.4 *	9.6 →	9.4 ←	10.3 *	10.6 *
beste Teiler	92.7 (40.)	149.4 (36.)	157.0 (39.)		
Trefferlage	0.27 mm links, 0.22 mm hoch				
Streuwert	1.89, horizontal: 2.20, vertikal: 1.52				

Unterschrift des Schützen

Meyton Elektronik

Ergebnis: **383** (402.6)
 Serien: 93 96 97 97
 Zähler: 26 12 1 1 0 0 0 0 0 0
 Innenzehner: 20
 weiteste: 781 (10), 651 (7), 484 (6)
 beste Teiler 28.1 (3.) 41.4 (5.) 44.3 (8.)
 Trefferlage 0.32 mm rechts, 0.27 mm tief
 Streuwert 1.97, horizontal: 2.28, vertikal: 1.61

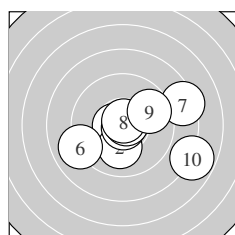
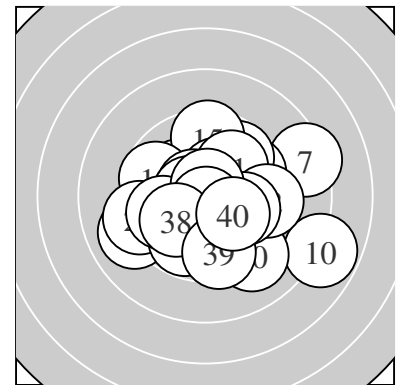

Serie 1:
 10.6 * 10.1 ↓ 10.8 * 10.7 * 10.8 *
 9.0 ← 8.3 → 10.8 * 9.7 → 7.8 ↘
 beste Teiler 28.1 (3.) 41.4 (5.) 44.3 (8.)
 Trefferlage 1.15 mm rechts, 0.35 mm tief
 Streuwert 2.67, horizontal: 3.35, vertikal: 1.73

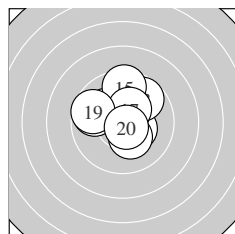

Serie 2:
 10.4 * 10.5 * 9.7 ↗ 10.1 ↘ 9.5 ↑
 9.8 ← 10.4 * 10.3 * 9.7 ← 10.7 *
 beste Teiler 64.4 (20.) 124.4 (12.) 144.9 (11.)
 Trefferlage 0.15 mm links, 0.87 mm hoch
 Streuwert 1.61, horizontal: 1.72, vertikal: 1.49

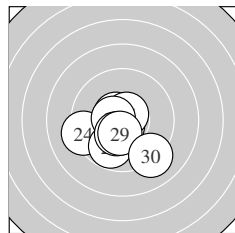

Serie 3:
 10.8 * 10.7 * 10.6 * 9.3 ← 10.7 *
 9.8 ↓ 10.6 * 10.3 * 10.4 * 9.1 ↘
 beste Teiler 46.4 (21.) 61.0 (22.) 72.1 (25.)
 Trefferlage 0.43 mm links, 0.90 mm tief
 Streuwert 1.57, horizontal: 1.69, vertikal: 1.43

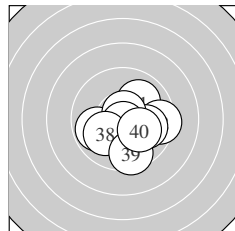

Serie 4:
 10.0 ↗ 9.4 → 9.8 ← 10.0 → 10.3 *
 10.7 * 10.8 * 10.0 ← 9.5 ↓ 10.1 ↘
 beste Teiler 46.5 (37.) 65.5 (36.) 157.4 (35.)
 Trefferlage 0.74 mm rechts, 0.71 mm tief
 Streuwert 1.64, horizontal: 1.88, vertikal: 1.35

Unterschrift des Schützen

Meyton Elektronik

Ergebnis: **379** (397.2)
 Serien: 93 96 94 96
 Zähler: 20 19 1 0 0 0 0 0 0 0
 Innenzehner: 16
 weiteste: 572 (36), 488 (25), 446 (9)
 beste Teiler 48.7 (32.) 65.7 (31.) 78.2 (20.)
 Trefferlage 0.41 mm links, 0.09 mm tief
 Streuwert 2.03, horizontal: 2.38, vertikal: 1.62

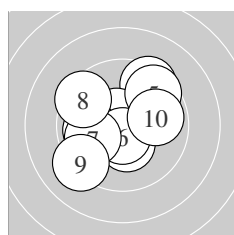
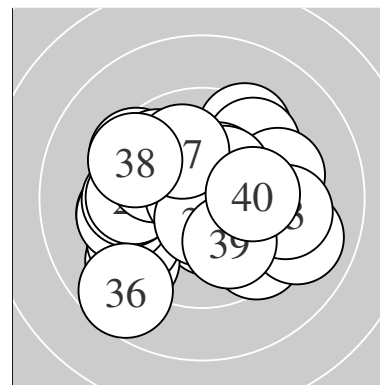

Serie 1:
 9.4 ↗ 10.4 * 10.6 * 9.9 ← 9.6 ↗
 10.6 * 9.9 ← 9.5 ↘ 9.2 ↘ 9.9 →
 beste Teiler 84.0 (3.) 86.0 (6.) 149.9 (2.)
 Trefferlage 0.44 mm links, 0.24 mm hoch
 Streuwert 2.14, horizontal: 2.31, vertikal: 1.95

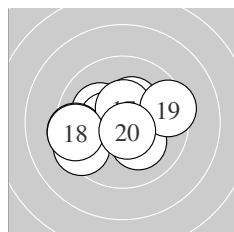

Serie 2:
 10.3 * 10.2 * 10.2 * 10.5 * 9.4 ←
 9.4 ← 10.5 * 9.4 ← 9.4 → 10.6 *
 beste Teiler 78.2 (20.) 112.2 (17.) 124.7 (14.)
 Trefferlage 0.77 mm links, 0.11 mm tief
 Streuwert 1.91, horizontal: 2.42, vertikal: 1.20

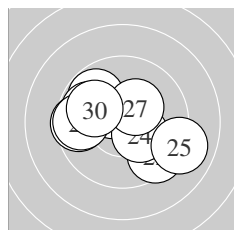

Serie 3:
 10.5 * 9.5 ↘ 9.8 ↘ 10.3 * 9.0 →
 9.6 ← 10.3 * 9.8 ← 9.6 ← 10.0 ↖
 beste Teiler 125.3 (21.) 157.3 (27.) 166.7 (24.)
 Trefferlage 0.50 mm links, 0.07 mm hoch
 Streuwert 2.20, horizontal: 2.74, vertikal: 1.47

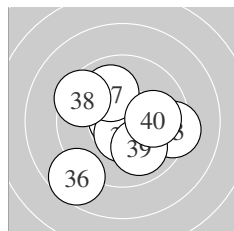

Serie 4:
 10.7 * 10.8 * 9.3 → 10.4 * 10.5 *
 8.7 ↘ 10.0 ↘ 9.5 ↘ 10.0 ↘ 10.0 →
 beste Teiler 48.7 (32.) 65.7 (31.) 101.0 (35.)
 Trefferlage 0.05 mm rechts, 0.55 mm tief
 Streuwert 2.12, horizontal: 2.32, vertikal: 1.89

Unterschrift des Schützen

Meyton Elektronik

Ergebnis: **384** (402.0)
 Serien: 94 97 97 96
 Zähler: 24 16 0 0 0 0 0 0 0 0
 Innenzehner: 15
 weiteste: 436 (33), 421 (6), 390 (34)
 beste Teiler 7.0 (23.) 73.2 (14.) 73.5 (38.)
 Trefferlage 0.00 mm , 0.65 mm hoch
 Streuwert 1.68, horizontal: 2.07, vertikal: 1.19

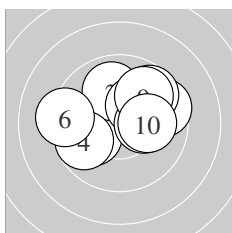
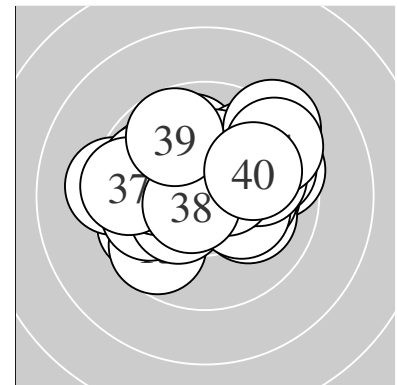

Serie 1:
 10.0 ↙ 9.9 ↑ 10.2 * 9.7 ↙ 10.2 *
 9.3 ← 9.6 → 9.7 ↗ 9.8 ↗ 10.1 →
 beste Teiler 178.7 (3.) 183.0 (5.) 212.0 (10.)
 Trefferlage 0.29 mm rechts, 0.73 mm hoch
 Streuwert 2.02, horizontal: 2.52, vertikal: 1.33

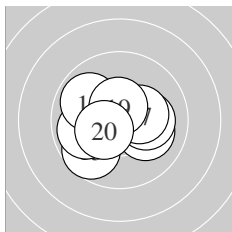

Serie 2:
 10.6 * 10.1 ↘ 10.1 → 10.7 * 9.7 ↙
 9.9 ← 10.3 * 9.9 ↖ 10.5 * 10.4 *
 beste Teiler 73.2 (14.) 86.0 (11.) 104.4 (19.)
 Trefferlage 0.34 mm links, 0.03 mm tief
 Streuwert 1.46, horizontal: 1.74, vertikal: 1.11

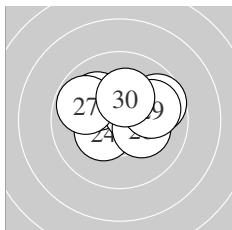

Serie 3:
 9.7 → 10.3 * 10.9 * 10.4 * 10.1 ↘
 10.5 * 9.8 ↖ 10.2 * 9.9 → 10.2 *
 beste Teiler 7.0 (23.) 120.8 (26.) 150.6 (24.)
 Trefferlage 0.18 mm rechts, 0.67 mm hoch
 Streuwert 1.45, horizontal: 1.84, vertikal: 0.91

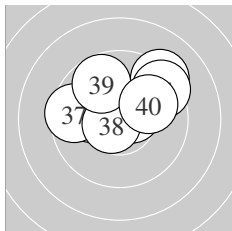

Serie 4:
 10.5 * 10.1 ↖ 9.2 ↗ 9.4 ↗ 10.1 ←
 10.1 ↘ 9.5 ← 10.7 * 9.7 ↘ 10.0 →
 beste Teiler 73.5 (38.) 101.6 (31.) 202.2 (36.)
 Trefferlage 0.12 mm links, 1.25 mm hoch
 Streuwert 1.84, horizontal: 2.33, vertikal: 1.14

Unterschrift des Schützen

Meyton Elektronik

Ergebnis:	374	(392.6)
Serien:	97 93 91 93	
Zähler:	18 18 4 0 0 0 0 0 0 0	
Innenzehner:	14	
weiteste:	590 (22), 590 (30), 547 (13)	
beste Teiler	36.7 (18.) 55.1 (2.) 84.0 (9.)	
Trefferlage	0.13 mm rechts, 0.69 mm hoch	
Streuwert	2.25, horizontal: 2.68, vertikal: 1.71	

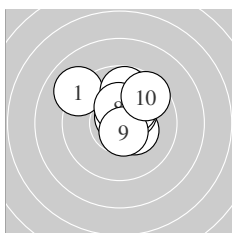
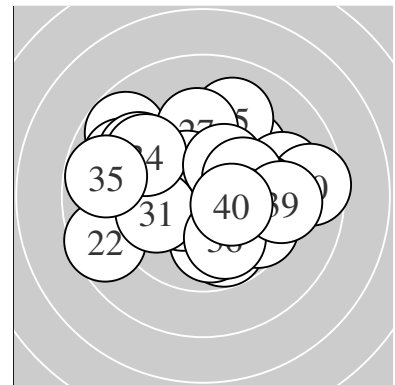

Serie 1:	9.0 ↘	10.7 *	10.1 ↗	10.4 *	9.8 ↑
	10.4 *	10.2 *	10.4 *	10.6 *	9.6 ↗
beste Teiler	55.1 (2.) 84.0 (9.) 147.2 (8.)				
Trefferlage	0.40 mm rechts, 1.31 mm hoch				
Streuwert	1.49, horizontal: 1.64, vertikal: 1.32				

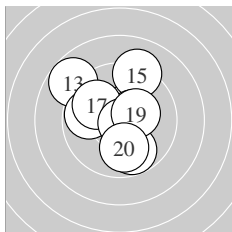

Serie 2:	9.8 ↓	10.6 *	8.8 ↘	9.8 ←	9.1 ↑
	10.4 *	9.9 ↘	10.8 *	10.3 *	9.9 ↓
beste Teiler	36.7 (18.) 85.8 (12.) 128.4 (16.)				
Trefferlage	0.28 mm links, 0.61 mm hoch				
Streuwert	2.12, horizontal: 2.03, vertikal: 2.20				

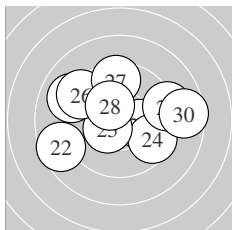

Serie 3:	10.2 *	8.6 ←	9.0 ↘	9.6 ↘	10.4 *
	9.3 ↘	9.5 ↑	10.3 *	9.1 →	8.6 →
beste Teiler	133.7 (25.) 160.0 (28.) 186.3 (21.)				
Trefferlage	0.05 mm links, 0.59 mm hoch				
Streuwert	2.99, horizontal: 3.78, vertikal: 1.91				

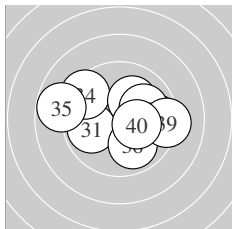

Serie 4:	9.9 ←	10.1 →	9.7 →	9.4 ↘	8.8 ←
	9.9 ↓	10.1 ↗	10.0 ↗	9.2 →	10.3 *
beste Teiler	163.2 (40.) 205.2 (37.) 225.8 (32.)				
Trefferlage	0.47 mm rechts, 0.26 mm hoch				
Streuwert	2.38, horizontal: 3.09, vertikal: 1.33				

Unterschrift des Schützen

Meyton Elektronik

Ergebnis: **387** (403.6)
 Serien: 97 98 96 96
 Zähler: 28 11 1 0 0 0 0 0 0 0
 Innenzehner: 21
 weiteste: 613 (35), 437 (29), 432 (12)
 beste Teiler 6.7 (5.) 42.2 (14.) 85.7 (38.)
 Trefferlage 0.26 mm rechts, 0.20 mm hoch
 Streuwert 1.75, horizontal: 1.90, vertikal: 1.59

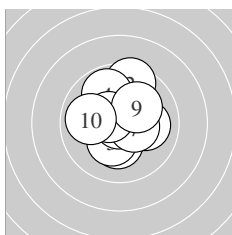
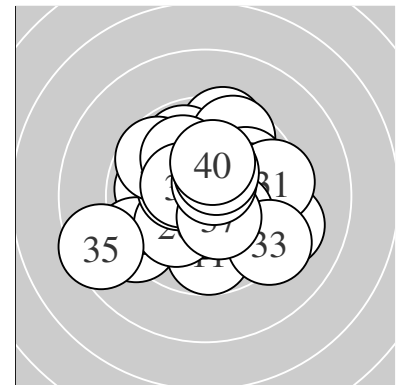

Serie 1:
 10.2 * 9.5 ↑ 10.3 * 9.8 ↖ 10.9 *
 10.1 → 10.4 * 10.5 * 10.1 ↗ 9.9 ←
 beste Teiler 6.7 (5.) 108.4 (8.) 131.7 (7.)
 Trefferlage 0.05 mm rechts, 0.45 mm hoch
 Streuwert 1.56, horizontal: 1.45, vertikal: 1.66

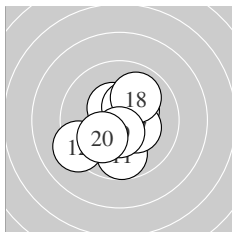

Serie 2:
 9.8 ↓ 9.2 ↙ 10.3 * 10.8 * 10.5 *
 10.4 * 10.3 * 10.0 ↗ 10.5 * 10.1 ↘
 beste Teiler 42.2 (14.) 107.0 (19.) 125.0 (15.)
 Trefferlage 0.08 mm links, 0.38 mm tief
 Streuwert 1.60, horizontal: 1.57, vertikal: 1.64

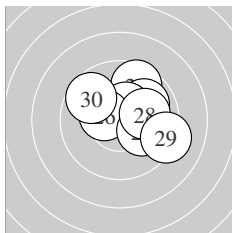

Serie 3:
 9.6 ↗ 10.5 * 9.9 ↘ 10.5 * 10.5 *
 10.4 * 10.1 ↘ 10.0 → 9.2 ↘ 9.7 ↖
 beste Teiler 106.4 (22.) 120.9 (24.) 123.8 (25.)
 Trefferlage 0.84 mm rechts, 0.77 mm hoch
 Streuwert 1.67, horizontal: 1.96, vertikal: 1.32

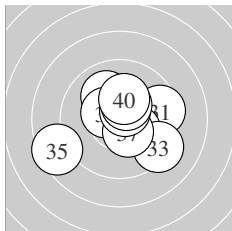

Serie 4:
 9.5 → 10.3 * 9.3 ↘ 10.0 ↖ 8.5 ←
 10.4 * 10.4 * 10.6 * 10.4 * 10.2 *
 beste Teiler 85.7 (38.) 131.0 (36.) 133.4 (37.)
 Trefferlage 0.26 mm rechts, 0.01 mm tief
 Streuwert 2.18, horizontal: 2.58, vertikal: 1.69

Unterschrift des Schützen

Meyton Elektronik

Ergebnis: **374** (391.4)
 Serien: 95 97 92 90
 Zähler: 21 12 7 0 0 0 0 0 0 0
 Innenzehner: 15
 weiteste: 733 (40), 681 (22), 618 (32)
 beste Teiler 72.8 (1.) 76.0 (14.) 85.7 (18.)
 Trefferlage 0.39 mm links, 0.13 mm tief
 Streuwert 2.41, horizontal: 2.72, vertikal: 2.05

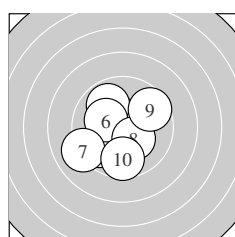
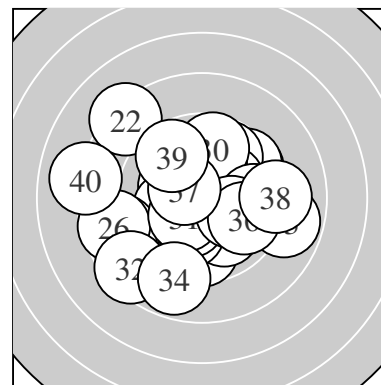

Serie 1:
 10.7 * 9.9 ↖ 9.8 ↙ 10.0 ↘ 10.4 *
 10.2 * 9.1 ↙ 10.3 * 9.6 ↗ 9.6 ↓
 beste Teiler 72.8 (1.) 127.9 (5.) 164.0 (8.)
 Trefferlage 0.83 mm links, 0.55 mm tief
 Streuwert 1.90, horizontal: 1.94, vertikal: 1.85

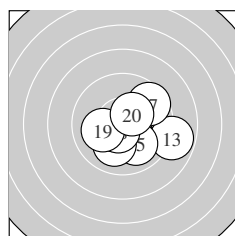

Serie 2:
 10.2 * 10.3 * 8.8 → 10.6 * 10.0 ↘
 10.0 ↓ 9.6 ↗ 10.6 * 10.1 ← 10.4 *
 beste Teiler 76.0 (14.) 85.7 (18.) 141.4 (20.)
 Trefferlage 1.06 mm rechts, 0.18 mm tief
 Streuwert 1.72, horizontal: 1.98, vertikal: 1.43

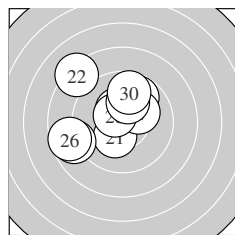

Serie 3:
 10.3 * 8.2 ↖ 8.8 ↙ 9.8 ↗ 10.4 *
 8.7 ← 10.2 * 10.5 * 10.1 ↑ 9.7 ↑
 beste Teiler 105.5 (28.) 141.4 (25.) 164.6 (21.)
 Trefferlage 1.30 mm links, 1.03 mm hoch
 Streuwert 2.51, horizontal: 2.75, vertikal: 2.26

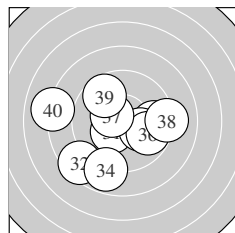

Serie 4:
 10.3 * 8.5 ↙ 9.7 → 8.8 ↓ 10.1 →
 9.8 → 10.5 * 9.1 → 9.7 ↖ 8.0 ←
 beste Teiler 123.8 (37.) 154.1 (31.) 203.9 (35.)
 Trefferlage 0.52 mm links, 0.82 mm tief
 Streuwert 3.06, horizontal: 3.64, vertikal: 2.33

Unterschrift des Schützen

Meyton Elektronik

Ergebnis:	373	(392.1)
Serien:	94 95 93 91	
Zähler:	20 14 5 1 0 0 0 0 0 0	
Innenzehner:	16	
weiteste:	847 (30), 686 (18), 625 (35)	
beste Teiler	61.4 (17.) 71.0 (11.) 87.6 (26.)	
Trefferlage	0.37 mm rechts, 0.38 mm hoch	
Streuwert	2.41, horizontal: 3.05, vertikal: 1.51	

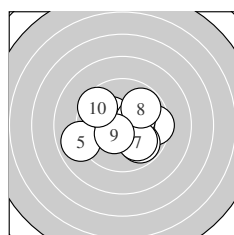
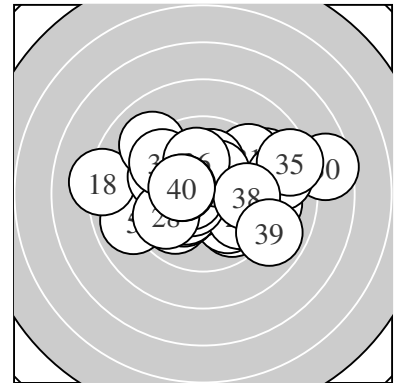

Serie 1:	9.5 →	10.3 *	9.8 ↘	10.6 *	8.9 ←
	10.3 *	10.0 ↘	9.8 ↗	10.4 *	9.6 ↖
beste Teiler	99.4 (4.) 134.3 (9.) 156.0 (6.)				
Trefferlage	0.19 mm rechts, 0.11 mm tief				
Streuwert	2.10, horizontal: 2.56, vertikal: 1.50				

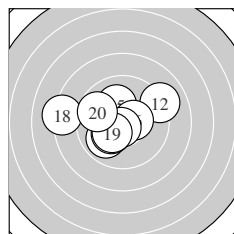

Serie 2:	10.7 *	9.1 ↗	9.9 ↙	10.2 *	10.1 ↑
	10.5 *	10.7 *	8.2 ←	10.3 *	9.7 ↖
beste Teiler	61.4 (17.) 71.0 (11.) 123.7 (16.)				
Trefferlage	0.94 mm links, 0.21 mm hoch				
Streuwert	2.23, horizontal: 2.83, vertikal: 1.39				

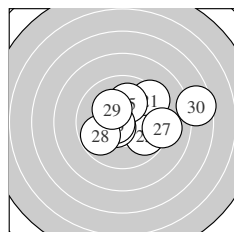

Serie 3:	9.4 ↗	10.5 *	9.8 ↘	10.6 *	10.1 ↑
	10.6 *	9.2 →	9.8 ↙	10.2 *	7.6 →
beste Teiler	87.6 (26.) 97.4 (24.) 112.1 (22.)				
Trefferlage	1.25 mm rechts, 0.39 mm hoch				
Streuwert	2.57, horizontal: 3.31, vertikal: 1.49				

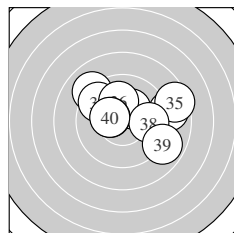

Serie 4:	10.3 *	8.8 →	9.0 ↘	9.6 ↖	8.5 →
	10.0 ↑	10.4 *	9.8 →	8.9 ↘	10.4 *
beste Teiler	145.8 (37.) 150.9 (40.) 167.2 (31.)				
Trefferlage	0.99 mm rechts, 1.03 mm hoch				
Streuwert	2.68, horizontal: 3.41, vertikal: 1.65				

Unterschrift des Schützen

Meyton Elektronik

Ergebnis:	389	(408.3)
Serien:	97 99 97 96	
Zähler:	29 11 0 0 0 0 0 0 0 0	
Innenzehner:	25	
weiteste:	472 (3), 421 (20), 385 (35)	
beste Teiler	11.4 (28.) 51.7 (7.) 71.5 (14.)	
Trefferlage	0.21 mm rechts, 0.12 mm tief	
Streuwert	1.54, horizontal: 1.79, vertikal: 1.24	

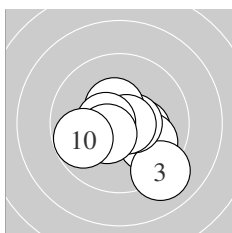
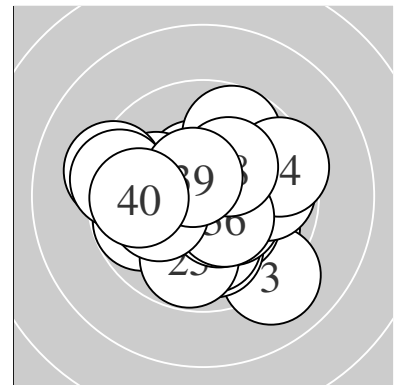

Serie 1:	10.3 *	9.9 ↘	9.1 ↘	10.6 *	10.6 *
	10.5 *	10.7 *	10.5 *	10.5 *	9.8 ←
beste Teiler	51.7 (7.)	81.2 (5.)	97.0 (4.)		
Trefferlage	0.23 mm rechts, 0.64 mm tief				
Streuwert	1.52, horizontal: 1.75, vertikal: 1.26				

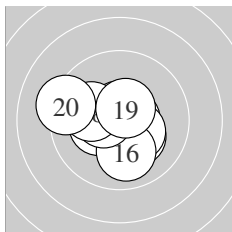

Serie 2:	10.6 *	10.3 *	10.3 *	10.7 *	10.4 *
	10.0 ↓	10.5 *	10.1 ←	10.6 *	9.3 ←
beste Teiler	71.5 (14.)	81.2 (11.)	100.6 (19.)		
Trefferlage	0.48 mm links, 0.12 mm tief				
Streuwert	1.44, horizontal: 1.72, vertikal: 1.10				

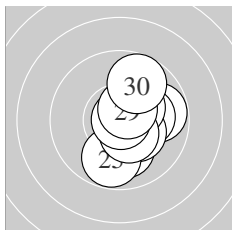

Serie 3:	9.8 →	10.1 ↓	10.2 *	10.3 *	9.8 ↓
	10.3 *	10.5 *	10.9 *	10.5 *	9.7 ↑
beste Teiler	11.4 (28.)	102.4 (29.)	121.8 (27.)		
Trefferlage	0.97 mm rechts, 0.14 mm tief				
Streuwert	1.33, horizontal: 0.97, vertikal: 1.62				

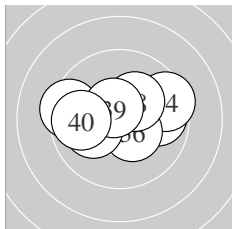

Serie 4:	10.6 *	9.8 →	10.4 *	9.5 →	9.4 ←
	10.4 *	10.1 ←	10.3 *	10.6 *	9.8 ←
beste Teiler	91.3 (31.)	95.7 (39.)	136.4 (36.)		
Trefferlage	0.12 mm rechts, 0.40 mm hoch				
Streuwert	1.77, horizontal: 2.38, vertikal: 0.78				

Unterschrift des Schützen

Meyton Elektronik

Ergebnis: **396** (415.5)
 Serien: 100 99 98 99
 Zähler: 36 4 0 0 0 0 0 0 0 0
 Innenzehner: 32
 weiteste: 304 (26), 287 (37), 277 (20)
 beste Teiler 10.8 (19.) 49.4 (14.) 52.9 (33.)
 Trefferlage 0.09 mm links, 0.28 mm hoch
 Streuwert 1.11, horizontal: 1.13, vertikal: 1.10

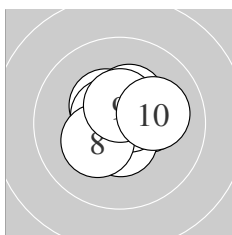
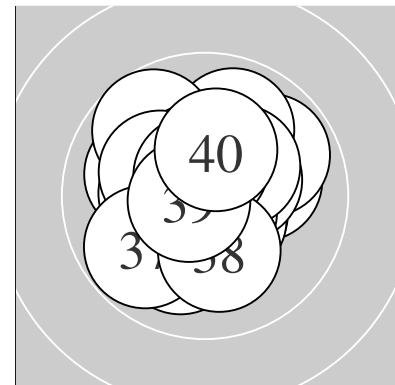

Serie 1:
 10.7 * 10.3 * 10.4 * 10.4 * 10.5 *
 10.6 * 10.6 * 10.3 * 10.5 * 10.1 →
 beste Teiler 59.9 (1.) 76.0 (7.) 88.5 (6.)
 Trefferlage 0.22 mm rechts, 0.39 mm hoch
 Streuwert 0.95, horizontal: 1.07, vertikal: 0.82

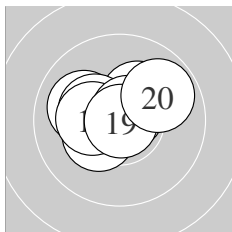

Serie 2:
 10.3 * 10.0 ↖ 10.7 * 10.8 * 10.3 *
 10.3 * 10.3 * 10.7 * 10.9 * 9.8 ↗
 beste Teiler 10.8 (19.) 49.4 (14.) 68.1 (13.)
 Trefferlage 0.37 mm links, 0.39 mm hoch
 Streuwert 1.11, horizontal: 1.40, vertikal: 0.71

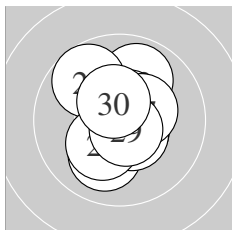

Serie 3:
 10.6 * 9.9 ↗ 10.6 * 10.0 ↘ 10.5 *
 9.7 ↘ 10.4 * 10.2 * 10.7 * 10.5 *
 beste Teiler 69.0 (29.) 96.8 (23.) 100.4 (21.)
 Trefferlage 0.05 mm rechts, 0.18 mm hoch
 Streuwert 1.32, horizontal: 1.05, vertikal: 1.54

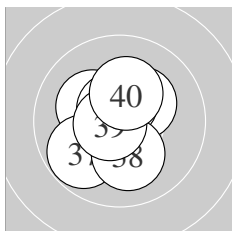

Serie 4:
 10.7 * 10.2 * 10.7 * 10.3 * 10.5 *
 10.6 * 9.8 ↙ 10.1 ↓ 10.7 * 10.3 *
 beste Teiler 52.9 (33.) 55.1 (31.) 61.4 (39.)
 Trefferlage 0.28 mm links, 0.16 mm hoch
 Streuwert 1.15, horizontal: 1.02, vertikal: 1.26

Unterschrift des Schützen

Meyton Elektronik

Ergebnis: **381** (397.6)
 Serien: 95 92 97 97
 Zähler: 25 11 4 0 0 0 0 0 0 0
 Innenzehner: 16
 weiteste: 675 (13), 624 (32), 549 (30)
 beste Teiler 15.1 (40.) 74.0 (22.) 86.7 (23.)
 Trefferlage 0.65 mm rechts, 0.26 mm hoch
 Streuwert 2.03, horizontal: 2.50, vertikal: 1.40

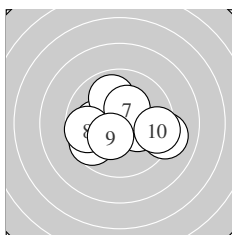
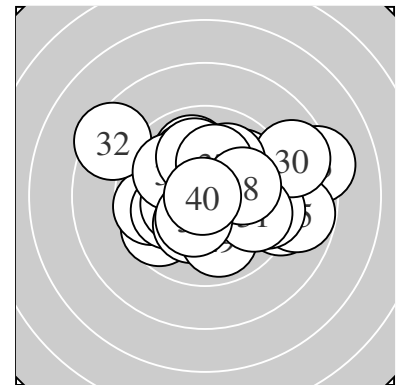

Serie 1:
 9.7 ↙ 9.1 → 10.1 ← 10.5 * 10.2 *
 9.9 ↑ 10.3 * 9.7 ← 10.3 * 9.5 →
 beste Teiler 117.0 (4.) 155.3 (9.) 160.1 (7.)
 Trefferlage 0.13 mm rechts, 0.11 mm tief
 Streuwert 2.05, horizontal: 2.57, vertikal: 1.36

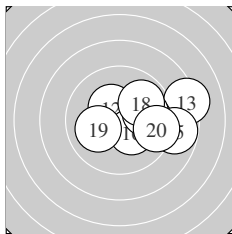

Serie 2:
 10.2 * 10.4 * 8.3 → 9.8 → 8.8 →
 10.3 * 9.9 → 9.9 ↗ 10.1 ← 9.5 →
 beste Teiler 147.2 (12.) 161.2 (16.) 177.3 (11.)
 Trefferlage 2.26 mm rechts, 0.26 mm hoch
 Streuwert 1.99, horizontal: 2.57, vertikal: 1.15

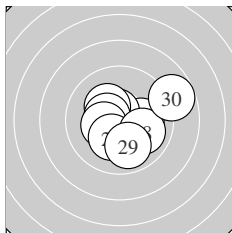

Serie 3:
 10.1 → 10.7 * 10.6 * 10.2 * 10.4 *
 10.3 * 10.2 * 10.0 ↘ 9.9 ↓ 8.8 →
 beste Teiler 74.0 (22.) 86.7 (23.) 127.4 (25.)
 Trefferlage 0.51 mm rechts, 0.18 mm tief
 Streuwert 1.77, horizontal: 2.07, vertikal: 1.40

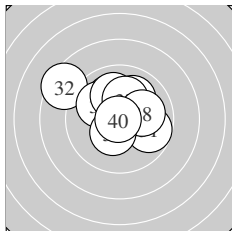

Serie 4:
 9.7 → 8.5 ↖ 10.1 ↑ 10.0 ↖ 10.0 ↑
 10.0 ↗ 10.2 * 10.1 → 10.4 * 10.9 *
 beste Teiler 15.1 (40.) 144.4 (39.) 198.7 (37.)
 Trefferlage 0.28 mm links, 1.10 mm hoch
 Streuwert 1.95, horizontal: 2.32, vertikal: 1.48

Unterschrift des Schützen

Meyton Elektronik

Ergebnis: **394** (407.2)
 Serien: 100 99 97 98
 Zähler: 35 4 1 0 0 0 0 0 0 0
 Innenzehner: 18
 weiteste: 508 (22), 416 (29), 316 (31)
 beste Teiler 48.3 (5.) 56.3 (7.) 58.2 (35.)
 Trefferlage 0.35 mm rechts, 0.06 mm hoch
 Streuwert 1.52, horizontal: 1.51, vertikal: 1.54

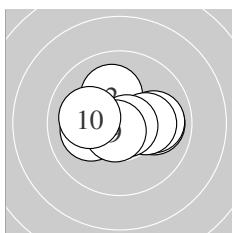
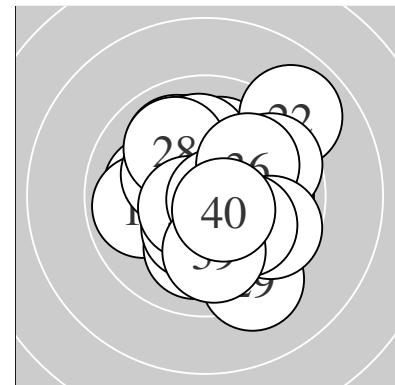

Serie 1:
 10.3 * 10.1 ↗ 10.0 → 10.0 → 10.8 *
 10.2 * 10.7 * 10.1 ← 10.7 * 10.1 ←
 beste Teiler 48.3 (5.) 56.3 (7.) 64.4 (9.)
 Trefferlage 0.05 mm rechts, 0.13 mm hoch
 Streuwert 1.35, horizontal: 1.76, vertikal: 0.77

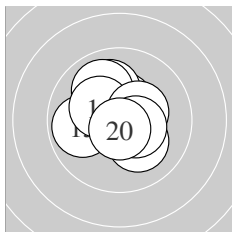

Serie 2:
 10.5 * 10.5 * 9.9 ← 10.0 ↗ 10.0 ↗
 10.3 * 10.4 * 10.1 ↘ 10.4 * 10.7 *
 beste Teiler 64.0 (20.) 123.3 (12.) 124.8 (11.)
 Trefferlage 0.29 mm links, 0.47 mm hoch
 Streuwert 1.28, horizontal: 1.34, vertikal: 1.22

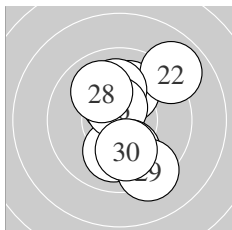

Serie 3:
 10.1 ↗ 8.9 ↗ 10.4 * 10.1 ↑ 10.0 ↓
 10.6 * 10.0 ↓ 10.0 ↘ 9.3 ↓ 10.1 ↓
 beste Teiler 93.6 (26.) 137.4 (23.) 216.9 (21.)
 Trefferlage 0.49 mm rechts, 0.17 mm hoch
 Streuwert 2.03, horizontal: 1.46, vertikal: 2.47

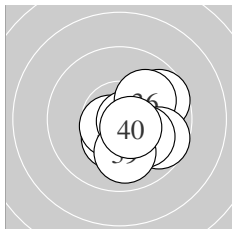

Serie 4:
 9.7 ↗ 10.4 * 10.2 * 10.6 * 10.7 *
 10.0 ↗ 9.7 ↘ 10.1 ↘ 10.0 ↓ 10.5 *
 beste Teiler 58.2 (35.) 84.2 (34.) 101.4 (40.)
 Trefferlage 1.16 mm rechts, 0.51 mm tief
 Streuwert 1.23, horizontal: 1.26, vertikal: 1.19

Unterschrift des Schützen

Meyton Elektronik

Ergebnis: **374** (392.5)
 Serien: 90 94 96 94
 Zähler: 17 20 3 0 0 0 0 0 0 0
 Innenzehner: 13
 weiteste: 607 (7), 605 (8), 504 (11)
 beste Teiler 15.0 (10.) 17.2 (38.) 69.8 (33.)
 Trefferlage 0.64 mm links, 0.04 mm hoch
 Streuwert 2.27, horizontal: 2.25, vertikal: 2.29

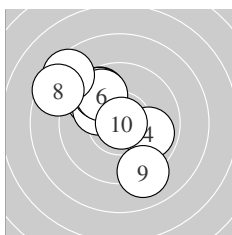
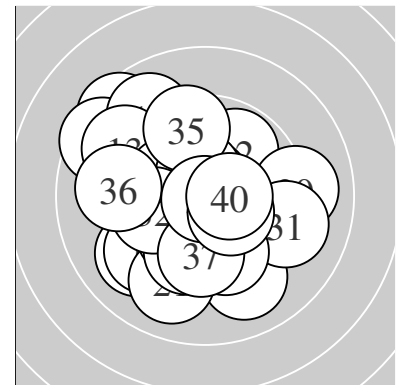

Serie 1:
 9.7 ↖ 9.7 ↖ 10.1 ↖ 9.9 ↗ 9.7 ↖
 9.8 ↖ 8.5 ↖ 8.5 ↖ 9.1 ↘ 10.9 *

beste Teiler 15.0 (10.) 219.9 (3.) 264.0 (4.)
 Trefferlage 1.43 mm links, 1.29 mm hoch
 Streuwert 2.45, horizontal: 2.48, vertikal: 2.41

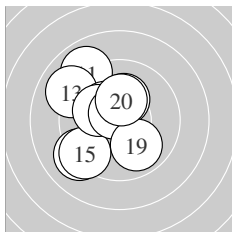

Serie 2:
 8.9 ↖ 10.2 * 9.0 ↖ 9.1 ↗ 9.3 ↗
 10.3 * 10.1 ↖ 10.7 * 9.9 ↘ 10.3 *

beste Teiler 75.6 (18.) 167.0 (16.) 175.5 (20.)
 Trefferlage 1.51 mm links, 0.47 mm hoch
 Streuwert 2.14, horizontal: 1.87, vertikal: 2.38

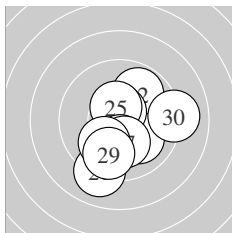

Serie 3:
 9.1 ↘ 9.8 ↗ 10.1 ↘ 10.7 * 10.5 *
 10.2 * 10.2 * 10.0 ↗ 9.7 ↘ 9.1 →

beste Teiler 73.4 (24.) 117.4 (25.) 178.0 (26.)
 Trefferlage 0.41 mm rechts, 0.99 mm tief
 Streuwert 1.96, horizontal: 1.87, vertikal: 2.05

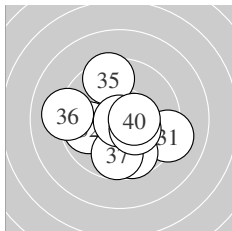

Serie 4:
 9.2 ↗ 9.8 ← 10.7 * 9.7 ↘ 9.5 ↖
 9.1 ← 9.8 ↓ 10.9 * 10.3 * 10.4 *

beste Teiler 17.2 (38.) 69.8 (33.) 127.0 (40.)
 Trefferlage 0.03 mm links, 0.59 mm tief
 Streuwert 2.12, horizontal: 2.37, vertikal: 1.83

Unterschrift des Schützen

Meyton Elektronik

Ergebnis: **391** (407.8)
 Serien: 95 98 99 99
 Zähler: 32 7 1 0 0 0 0 0 0 0
 Innenzehner: 24
 weiteste: 511 (3), 471 (7), 442 (38)
 beste Teiler 18.4 (10.) 27.2 (36.) 48.5 (1.)
 Trefferlage 0.04 mm rechts, 0.80 mm hoch
 Streuwert 1.50, horizontal: 1.69, vertikal: 1.27

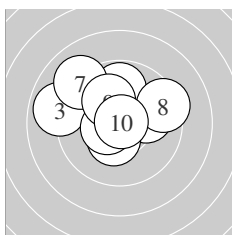
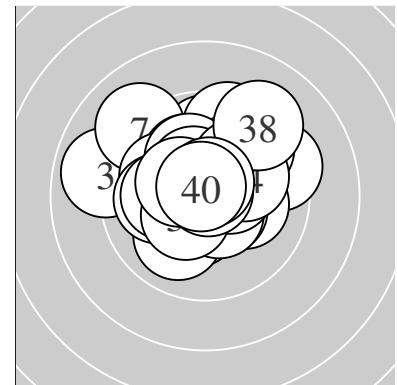

Serie 1:
 10.8 * 10.0 → 8.9 ← 10.4 * 9.8 ↑
 10.5 * 9.1 ↘ 9.4 → 10.1 ↖ 10.9 *
 beste Teiler 18.4 (10.) 48.5 (1.) 109.7 (6.)
 Trefferlage 0.47 mm links, 1.02 mm hoch
 Streuwert 2.00, horizontal: 2.44, vertikal: 1.44

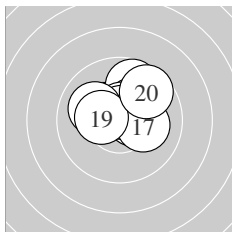

Serie 2:
 10.5 * 10.3 * 9.7 ↑ 10.3 * 10.6 *
 10.7 * 10.2 * 10.0 ↘ 10.3 * 9.7 ↗
 beste Teiler 66.4 (16.) 94.5 (15.) 117.1 (11.)
 Trefferlage 0.29 mm rechts, 0.98 mm hoch
 Streuwert 1.27, horizontal: 1.49, vertikal: 1.00

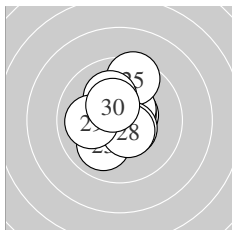

Serie 3:
 10.5 * 10.6 * 10.0 ↙ 10.5 * 9.5 ↑
 10.5 * 10.1 ↘ 10.5 * 10.0 ← 10.4 *
 beste Teiler 94.6 (22.) 108.8 (21.) 112.4 (28.)
 Trefferlage 0.02 mm rechts, 0.47 mm hoch
 Streuwert 1.38, horizontal: 1.21, vertikal: 1.53

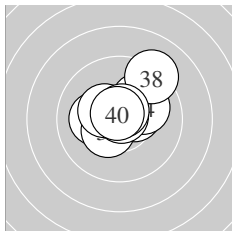

Serie 4:
 10.2 * 10.4 * 10.1 ↗ 10.1 → 10.4 *
 10.8 * 10.4 * 9.2 ↗ 10.7 * 10.7 *
 beste Teiler 27.2 (36.) 51.0 (40.) 72.1 (39.)
 Trefferlage 0.34 mm rechts, 0.76 mm hoch
 Streuwert 1.35, horizontal: 1.51, vertikal: 1.18

Unterschrift des Schützen

Meyton Elektronik

Ergebnis: **370** (389.6)
 Serien: 91 93 91 95
 Zähler: 18 16 5 0 1 0 0 0 0 0
 Innenzehner: 13
 weiteste: 1020 (17), 669 (9), 644 (29)
 beste Teiler 21.1 (12.) 49.8 (34.) 56.0 (40.)
 Trefferlage 0.21 mm links, 1.05 mm hoch
 Streuwert 2.51, horizontal: 2.86, vertikal: 2.11

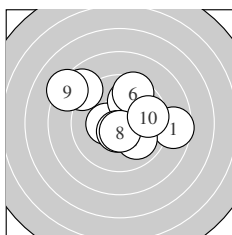
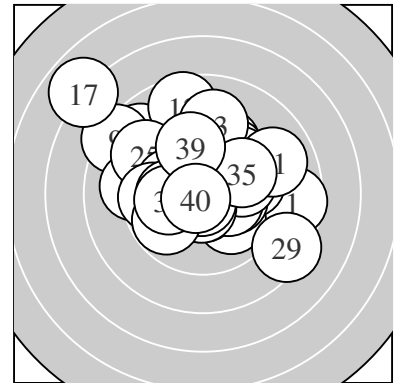

Serie 1:
 8.6 → 10.4 * 9.9 ↑ 10.6 * 8.8 ↘
 9.5 ↑ 10.0 ↘ 10.6 * 8.3 ↘ 9.7 →
 beste Teiler 88.1 (8.) 92.7 (4.) 141.2 (2.)
 Trefferlage 0.17 mm rechts, 0.95 mm hoch
 Streuwert 2.77, horizontal: 3.33, vertikal: 2.06

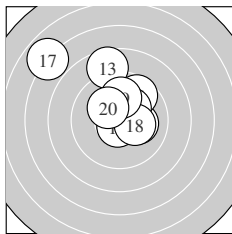

Serie 2:
 10.2 * 10.9 * 8.6 ↑ 9.7 ↗ 10.3 *
 10.7 * 6.9 ↘ 10.3 * 10.0 ↑ 10.2 *
 beste Teiler 21.1 (12.) 71.4 (16.) 173.0 (18.)
 Trefferlage 0.39 mm links, 1.83 mm hoch
 Streuwert 2.72, horizontal: 2.86, vertikal: 2.56

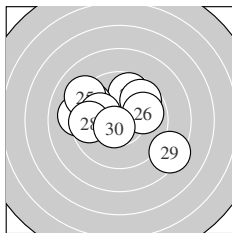

Serie 3:
 9.7 ↑ 9.5 ↘ 9.7 ↗ 9.2 ← 9.1 ↘
 9.9 → 10.1 ← 9.6 ← 8.4 ↘ 10.6 *
 beste Teiler 94.8 (30.) 223.2 (27.) 264.4 (26.)
 Trefferlage 0.60 mm links, 0.69 mm hoch
 Streuwert 2.68, horizontal: 3.29, vertikal: 1.88

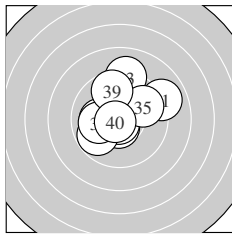

Serie 4:
 9.0 → 10.6 * 9.1 ↑ 10.8 * 9.8 ↗
 9.8 ↙ 10.1 ← 10.0 ← 9.7 ↑ 10.7 *
 beste Teiler 49.8 (34.) 56.0 (40.) 92.4 (32.)
 Trefferlage 0.04 mm links, 0.72 mm hoch
 Streuwert 2.09, horizontal: 2.19, vertikal: 1.97

Unterschrift des Schützen

Meyton Elektronik

Ergebnis: **381** (398.1)
 Serien: 96 93 94 98
 Zähler: 21 19 0 0 0 0 0 0 0 0
 Innenzehner: 15
 weiteste: 453 (39), 427 (13), 426 (9)
 beste Teiler 59.6 (1.) 73.1 (19.) 80.3 (31.)
 Trefferlage 0.05 mm rechts, 0.02 mm tief
 Streuwert 1.96, horizontal: 2.22, vertikal: 1.65

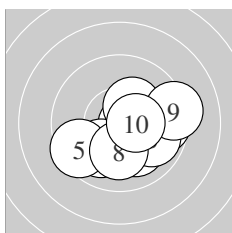
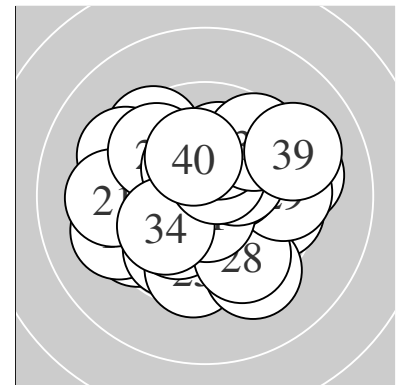

Serie 1:
 10.7 * 9.7 → 10.1 ↘ 10.0 ✓ 9.5 ↙
 9.9 ↘ 10.3 * 10.1 ↓ 9.2 → 10.5 *
 beste Teiler 59.6 (1.) 124.0 (10.) 161.4 (7.)
 Trefferlage 0.92 mm rechts, 0.68 mm tief
 Streuwert 1.75, horizontal: 2.13, vertikal: 1.27

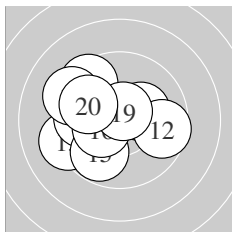

Serie 2:
 10.2 * 9.6 → 9.2 ↙ 9.8 ← 9.8 ✓
 10.3 * 9.5 ↘ 9.3 ↘ 10.7 * 9.9 ↘
 beste Teiler 73.1 (19.) 151.7 (16.) 176.2 (11.)
 Trefferlage 1.29 mm links, 0.20 mm hoch
 Streuwert 2.00, horizontal: 2.34, vertikal: 1.59

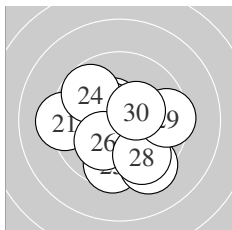

Serie 3:
 9.3 ← 10.5 * 10.5 * 9.7 ↘ 9.6 ↓
 10.1 ✓ 9.3 ↘ 9.7 ↘ 9.5 → 10.4 *
 beste Teiler 101.5 (23.) 115.9 (22.) 145.9 (30.)
 Trefferlage 0.07 mm links, 0.65 mm tief
 Streuwert 2.14, horizontal: 2.31, vertikal: 1.96

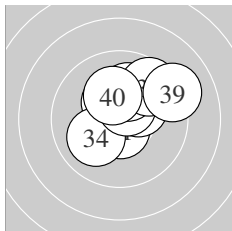

Serie 4:
 10.6 * 10.4 * 10.4 * 10.0 ✓ 10.3 *
 10.5 * 10.1 ↑ 9.6 ↗ 9.1 → 10.2 *
 beste Teiler 80.3 (31.) 110.2 (36.) 138.2 (32.)
 Trefferlage 0.66 mm rechts, 1.05 mm hoch
 Streuwert 1.46, horizontal: 1.65, vertikal: 1.25

Unterschrift des Schützen

Meyton Elektronik