

Ergebnis: **398** (415.6)
 Serien: 100 99 99 100
 Zähler: 38 2 0 0 0 0 0 0 0 0
 Innenzehner: 34
 weiteste: 332 (26), 270 (13), 250 (10)
 beste Teiler 7.2 (34.) 63.0 (4.) 66.2 (28.)
 Trefferlage 0.30 mm rechts, 0.49 mm hoch
 Streuwert 1.02, horizontal: 1.27, vertikal: 0.70

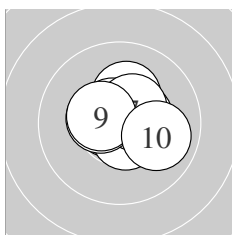

Serie 1:
 10.6 * 10.2 * 10.6 * 10.7 * 10.6 *
 10.5 * 10.5 * 10.5 * 10.4 * 10.0 →
 beste Teiler 63.0 (4.) 81.8 (3.) 87.2 (5.)
 Trefferlage 0.23 mm rechts, 0.36 mm hoch
 Streuwert 0.96, horizontal: 1.13, vertikal: 0.76

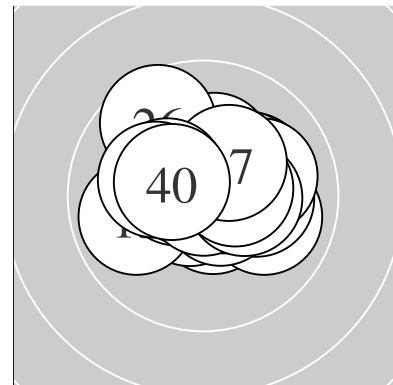
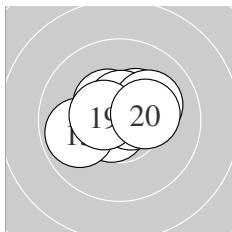

Serie 2:
 10.5 * 10.7 * 9.9 ← 10.4 * 10.4 *
 10.6 * 10.6 * 10.1 → 10.5 * 10.3 *
 beste Teiler 69.3 (12.) 79.7 (16.) 97.5 (17.)
 Trefferlage 0.06 mm links, 0.37 mm hoch
 Streuwert 1.10, horizontal: 1.40, vertikal: 0.68

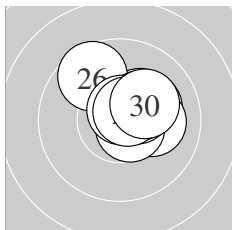

Serie 3:
 10.2 * 10.1 → 10.6 * 10.4 * 10.3 *
 9.6 ↘ 10.3 * 10.7 * 10.6 * 10.2 *
 beste Teiler 66.2 (28.) 76.4 (29.) 82.0 (23.)
 Trefferlage 0.88 mm rechts, 0.80 mm hoch
 Streuwert 0.99, horizontal: 1.10, vertikal: 0.87

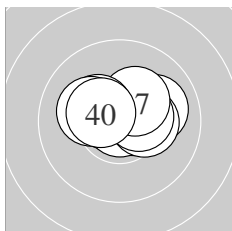

Serie 4:
 10.6 * 10.0 → 10.6 * 10.9 * 10.3 *
 10.4 * 10.3 * 10.3 * 10.2 * 10.4 *
 beste Teiler 7.2 (34.) 78.7 (31.) 88.0 (33.)
 Trefferlage 0.18 mm rechts, 0.45 mm hoch
 Streuwert 1.04, horizontal: 1.40, vertikal: 0.43

Unterschrift des Schützen

Ergebnis: **396** (415.7)
 Serien: 97 99 100 100
 Zähler: 36 4 0 0 0 0 0 0 0 0
 Innenzehner: 33
 weiteste: 443 (2), 340 (8), 286 (19)
 beste Teiler 17.6 (28.) 26.5 (31.) 36.0 (18.)
 Trefferlage 0.36 mm rechts, 0.41 mm hoch
 Streuwert 1.11, horizontal: 1.30, vertikal: 0.88

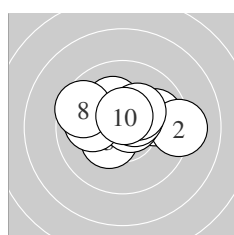
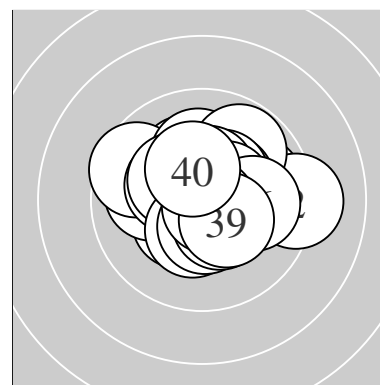

Serie 1:
 9.9 → 9.2 → 10.4 * 10.7 * 10.2 *
 10.5 * 10.0 ← 9.6 ↖ 10.3 * 10.6 *
 beste Teiler 67.2 (4.) 89.1 (10.) 119.2 (6.)
 Trefferlage 0.25 mm rechts, 0.62 mm hoch
 Streuwert 1.68, horizontal: 2.23, vertikal: 0.79

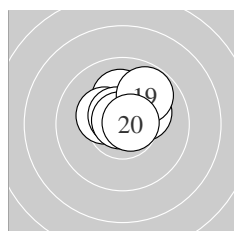

Serie 2:
 10.6 * 10.7 * 10.5 * 10.1 ↑ 10.3 *
 10.2 * 10.6 * 10.8 * 9.8 ↗ 10.7 *
 beste Teiler 36.0 (18.) 63.6 (12.) 64.1 (20.)
 Trefferlage 0.31 mm rechts, 0.91 mm hoch
 Streuwert 0.85, horizontal: 0.96, vertikal: 0.73

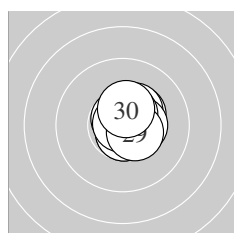

Serie 3:
 10.4 * 10.7 * 10.4 * 10.7 * 10.4 *
 10.7 * 10.5 * 10.9 * 10.5 * 10.4 *
 beste Teiler 17.6 (28.) 55.9 (24.) 58.0 (22.)
 Trefferlage 0.50 mm rechts, 0.29 mm hoch
 Streuwert 0.64, horizontal: 0.56, vertikal: 0.71

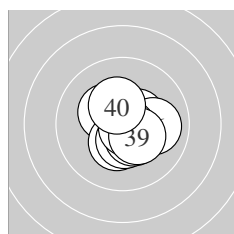

Serie 4:
 10.8 * 10.3 * 10.4 * 10.5 * 10.5 *
 10.0 → 10.4 * 10.8 * 10.4 * 10.3 *
 beste Teiler 26.5 (31.) 45.4 (38.) 123.0 (35.)
 Trefferlage 0.38 mm rechts, 0.19 mm tief
 Streuwert 1.01, horizontal: 1.04, vertikal: 0.98

Unterschrift des Schützen

Meyton Elektronik

Ergebnis: **397** (417.7)
 Serien: 99 99 99 100
 Zähler: 37 3 0 0 0 0 0 0 0 0
 Innenzehner: 33
 weiteste: 261 (20), 258 (28), 254 (8)
 beste Teiler 12.2 (24.) 41.8 (33.) 54.4 (16.)
 Trefferlage 0.76 mm links, 0.12 mm hoch
 Streuwert 0.86, horizontal: 0.79, vertikal: 0.92

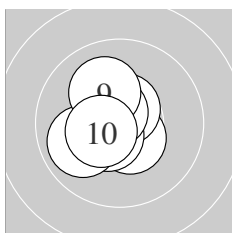
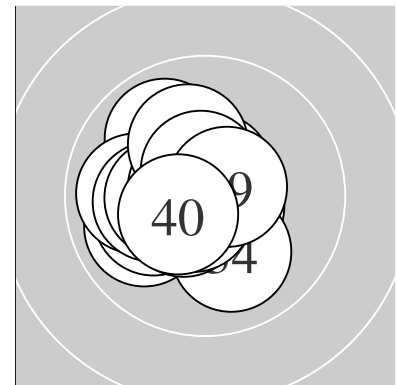

Serie 1:
 10.5 * 10.6 * 10.7 * 10.6 * 10.5 *
 10.5 * 10.6 * 9.9 ← 10.1 ↗ 10.5 *
 beste Teiler 74.1 (3.) 82.6 (7.) 85.0 (4.)
 Trefferlage 0.69 mm links, 0.05 mm tief
 Streuwert 0.88, horizontal: 0.79, vertikal: 0.96

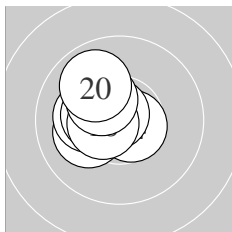

Serie 2:
 10.1 ← 10.2 * 10.6 * 10.6 * 10.5 *
 10.7 * 10.4 * 10.5 * 10.3 * 9.9 ↘
 beste Teiler 54.4 (16.) 80.9 (14.) 89.0 (13.)
 Trefferlage 1.05 mm links, 0.38 mm hoch
 Streuwert 0.80, horizontal: 0.78, vertikal: 0.82

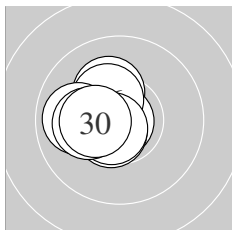

Serie 3:
 10.5 * 10.7 * 10.2 * 10.9 * 10.6 *
 10.4 * 10.7 * 9.9 ← 10.2 * 10.3 *
 beste Teiler 12.2 (24.) 72.8 (27.) 74.0 (22.)
 Trefferlage 1.01 mm links, 0.14 mm hoch
 Streuwert 0.78, horizontal: 0.77, vertikal: 0.79

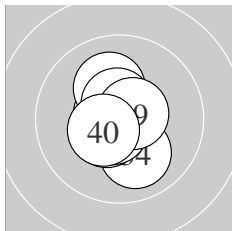

Serie 4:
 10.5 * 10.7 * 10.8 * 10.0 ↘ 10.5 *
 10.7 * 10.1 ↗ 10.6 * 10.6 * 10.5 *
 beste Teiler 41.8 (33.) 71.1 (32.) 75.0 (36.)
 Trefferlage 0.26 mm links, 0.02 mm hoch
 Streuwert 0.94, horizontal: 0.66, vertikal: 1.15

Unterschrift des Schützen

Ergebnis: **383** (401.5)
 Serien: 95 94 96 98
 Zähler: 25 13 2 0 0 0 0 0 0 0
 Innenzehner: 22
 weiteste: 556 (10), 556 (12), 447 (38)
 beste Teiler 12.0 (19.) 34.0 (17.) 58.0 (33.)
 Trefferlage 0.92 mm rechts, 0.67 mm hoch
 Streuwert 1.71, horizontal: 1.58, vertikal: 1.83

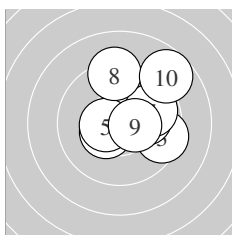

Serie 1:
 10.4 * 10.4 * 9.5 ↘ 10.4 * 10.5 *
 10.1 → 9.8 → 9.3 ↑ 10.4 * 8.7 ↗
 beste Teiler 116.1 (5.) 127.8 (4.) 127.9 (2.)
 Trefferlage 1.31 mm rechts, 0.86 mm hoch
 Streuwert 1.81, horizontal: 1.81, vertikal: 1.81

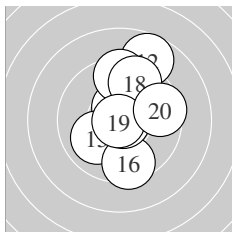

Serie 2:
 10.3 * 8.7 ↗ 10.5 * 9.5 ↑ 10.0 ↖
 9.5 ↓ 10.8 * 9.6 ↑ 10.9 * 9.5 →
 beste Teiler 12.0 (19.) 34.0 (17.) 107.5 (13.)
 Trefferlage 0.72 mm rechts, 0.95 mm hoch
 Streuwert 2.07, horizontal: 1.46, vertikal: 2.54

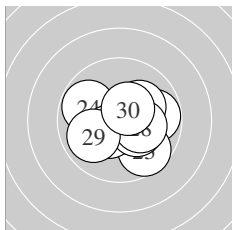

Serie 3:
 9.8 → 10.2 * 9.7 ↘ 9.8 ↖ 10.5 *
 10.4 * 10.3 * 10.2 * 9.9 ↙ 10.5 *
 beste Teiler 118.8 (30.) 121.2 (25.) 131.7 (26.)
 Trefferlage 0.58 mm rechts, 0.32 mm tief
 Streuwert 1.56, horizontal: 1.86, vertikal: 1.19

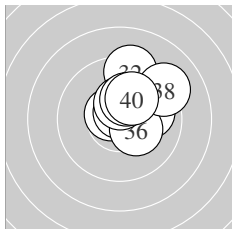

Serie 4:
 10.6 * 9.3 ↑ 10.7 * 10.4 * 10.0 →
 10.3 * 10.4 * 9.2 ↗ 10.3 * 10.2 *
 beste Teiler 58.0 (33.) 83.7 (31.) 133.1 (37.)
 Trefferlage 1.07 mm rechts, 1.20 mm hoch
 Streuwert 1.32, horizontal: 1.28, vertikal: 1.36

Unterschrift des Schützen

Meyton Elektronik

Ergebnis: **385** (403.7)
 Serien: 95 96 97 97
 Zähler: 25 15 0 0 0 0 0 0 0 0
 Innenzehner: 18
 weiteste: 441 (26), 439 (18), 405 (4)
 beste Teiler 19.0 (14.) 31.7 (35.) 41.2 (32.)
 Trefferlage 0.08 mm rechts, 0.11 mm tief
 Streuwert 1.76, horizontal: 1.94, vertikal: 1.57

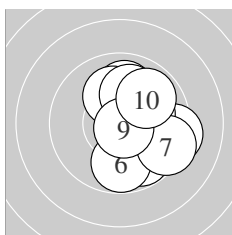
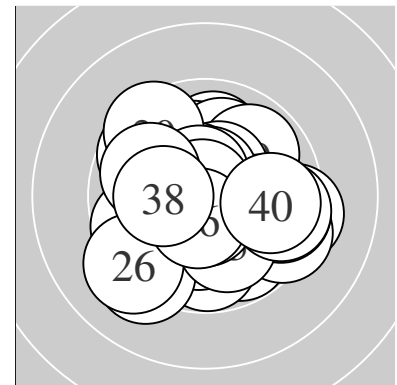

Serie 1:
 10.0 ↑ 10.1 ↑ 9.8 ↘ 9.3 → 10.1 →
 9.8 ↓ 9.4 ↘ 10.0 ↑ 10.8 * 9.9 ↗
 beste Teiler 47.5 (9.) 202.4 (5.) 208.3 (2.)
 Trefferlage 1.39 mm rechts, 0.09 mm hoch
 Streuwert 1.77, horizontal: 1.48, vertikal: 2.02

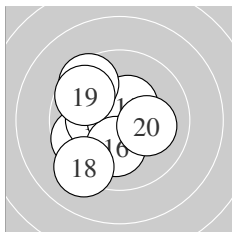

Serie 2:
 10.2 * 9.7 ↙ 10.2 * 10.9 * 10.4 *
 10.2 * 9.5 ↘ 9.2 ↙ 9.7 ↘ 10.1 →
 beste Teiler 19.0 (14.) 126.2 (15.) 180.0 (13.)
 Trefferlage 1.19 mm links, 0.17 mm tief
 Streuwert 1.74, horizontal: 1.66, vertikal: 1.82

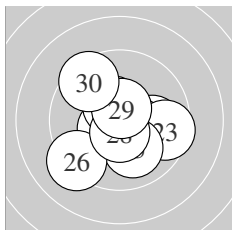

Serie 3:
 10.0 → 10.4 * 9.6 → 10.5 * 10.0 ↓
 9.2 ↙ 10.5 * 10.6 * 10.6 * 9.5 ↘
 beste Teiler 88.1 (29.) 91.0 (28.) 111.5 (24.)
 Trefferlage 0.13 mm rechts, 0.35 mm tief
 Streuwert 1.85, horizontal: 2.02, vertikal: 1.66

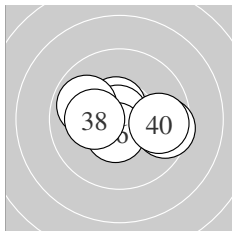

Serie 4:
 10.5 * 10.8 * 10.8 * 10.6 * 10.8 *
 10.5 * 9.9 ↙ 10.2 * 9.6 → 9.8 →
 beste Teiler 31.7 (35.) 41.2 (32.) 41.8 (33.)
 Trefferlage 0.02 mm rechts, 0.02 mm tief
 Streuwert 1.40, horizontal: 1.87, vertikal: 0.63

Unterschrift des Schützen

Meyton Elektronik

Ergebnis: **380** (398.6)
 Serien: 95 97 95 93
 Zähler: 23 14 3 0 0 0 0 0 0 0
 Innenzehner: 21
 weiteste: 612 (32), 598 (37), 528 (30)
 beste Teiler 22.0 (6.) 70.0 (29.) 74.8 (1.)
 Trefferlage 0.88 mm rechts, 0.75 mm hoch
 Streuwert 1.92, horizontal: 2.20, vertikal: 1.58

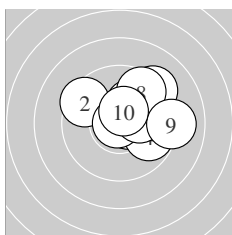
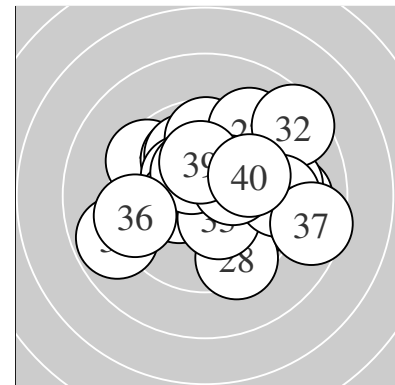

Serie 1:
 10.7 * 9.5 ↖ 10.2 * 9.8 ↘ 9.3 ↗
 10.9 * 10.2 * 9.6 ↗ 9.1 → 10.5 *
 beste Teiler 22.0 (6.) 74.8 (1.) 114.7 (10.)
 Trefferlage 1.28 mm rechts, 0.96 mm hoch
 Streuwert 1.79, horizontal: 2.12, vertikal: 1.37

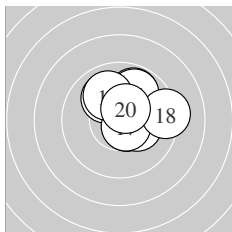

Serie 2:
 9.8 ↗ 10.6 * 10.3 * 9.9 ↗ 10.0 ↖
 10.6 * 10.6 * 9.3 → 10.0 ↖ 10.5 *
 beste Teiler 79.9 (17.) 87.8 (12.) 99.8 (16.)
 Trefferlage 0.85 mm rechts, 0.96 mm hoch
 Streuwert 1.38, horizontal: 1.50, vertikal: 1.26

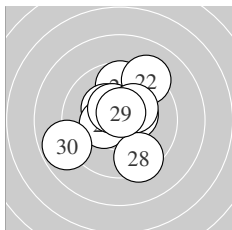

Serie 3:
 9.7 ↑ 9.2 ↗ 10.3 * 10.4 * 10.4 *
 10.5 * 10.3 * 9.4 ↘ 10.7 * 8.8 ←
 beste Teiler 70.0 (29.) 124.8 (26.) 134.4 (24.)
 Trefferlage 0.13 mm links, 0.51 mm hoch
 Streuwert 2.10, horizontal: 2.07, vertikal: 2.14

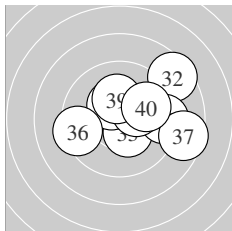

Serie 4:
 10.5 * 8.5 ↗ 10.4 * 10.4 * 9.3 →
 9.4 ← 8.6 ↘ 10.3 * 10.2 * 9.9 →
 beste Teiler 110.3 (31.) 141.5 (33.) 145.6 (34.)
 Trefferlage 1.53 mm rechts, 0.56 mm hoch
 Streuwert 2.32, horizontal: 2.86, vertikal: 1.61

Unterschrift des Schützen

Meyton Elektronik

Ergebnis: **385** (407.4)
 Serien: 99 95 94 97
 Zähler: 25 15 0 0 0 0 0 0 0 0
 Innenzehner: 22
 weiteste: 346 (27), 342 (28), 338 (3)
 beste Teiler 28.2 (16.) 59.0 (31.) 72.0 (18.)
 Trefferlage 0.46 mm links, 0.24 mm hoch
 Streuwert 1.49, horizontal: 1.50, vertikal: 1.47

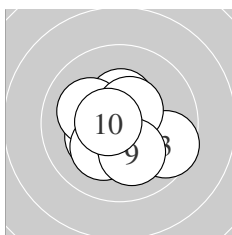
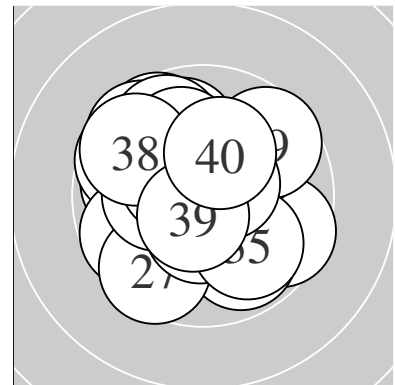

Serie 1:
 10.4 * 10.3 * 9.6 ↘ 10.5 * 10.7 *
 10.1 ↖ 10.5 * 10.2 * 10.1 ↓ 10.6 *
 beste Teiler 75.6 (5.) 76.4 (10.) 102.5 (4.)
 Trefferlage 0.16 mm links, 0.40 mm tief
 Streuwert 1.29, horizontal: 1.44, vertikal: 1.13

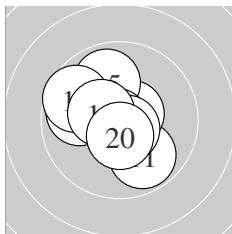

Serie 2:
 9.8 ↘ 9.9 ← 10.6 * 9.9 ← 9.9 ↗
 10.8 * 9.7 ↖ 10.7 * 10.4 * 10.5 *
 beste Teiler 28.2 (16.) 72.0 (18.) 84.7 (13.)
 Trefferlage 0.78 mm links, 0.19 mm hoch
 Streuwert 1.45, horizontal: 1.56, vertikal: 1.33

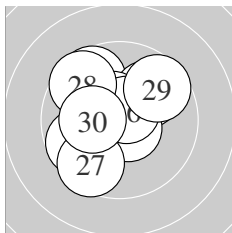

Serie 3:
 9.7 ↙ 9.7 ↘ 9.9 ↗ 10.6 * 10.5 *
 10.6 * 9.6 ↘ 9.6 ↖ 9.6 ↗ 10.2 *
 beste Teiler 78.5 (24.) 82.0 (26.) 110.9 (25.)
 Trefferlage 0.57 mm links, 0.57 mm hoch
 Streuwert 1.83, horizontal: 1.85, vertikal: 1.81

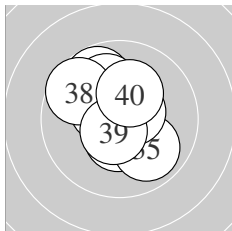

Serie 4:
 10.7 * 10.4 * 9.8 ↘ 10.0 ↗ 9.9 ↘
 10.4 * 10.6 * 9.6 ↖ 10.6 * 10.2 *
 beste Teiler 59.0 (31.) 88.5 (39.) 96.7 (37.)
 Trefferlage 0.33 mm links, 0.61 mm hoch
 Streuwert 1.41, horizontal: 1.28, vertikal: 1.52

Unterschrift des Schützen

Meyton Elektronik

Ergebnis: **380** (394.9)
 Serien: 92 98 94 96
 Zähler: 23 14 3 0 0 0 0 0 0 0
 Innenzehner: 12
 weiteste: 689 (22), 619 (25), 610 (6)
 beste Teiler 79.4 (4.) 107.3 (26.) 109.2 (17.)
 Trefferlage 0.37 mm rechts, 0.36 mm hoch
 Streuwert 2.15, horizontal: 2.60, vertikal: 1.56

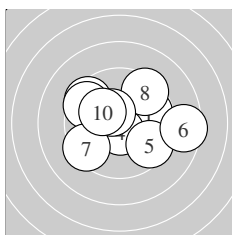
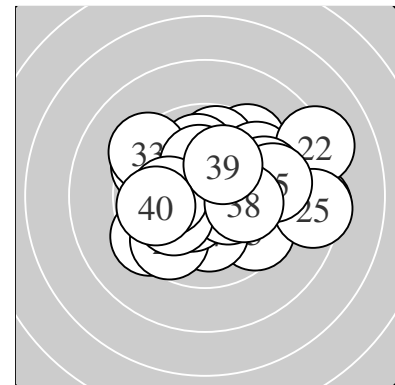

Serie 1:
 9.8 → 9.5 ↘ 9.5 ↘ 10.6 * 9.6 ↘
 8.5 → 9.4 ↙ 9.4 ↗ 10.5 * 10.2 *
 beste Teiler 79.4 (4.) 125.2 (9.) 194.9 (10.)
 Trefferlage 0.25 mm rechts, 0.43 mm hoch
 Streuwert 2.56, horizontal: 3.16, vertikal: 1.76

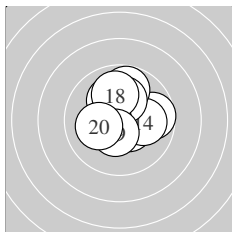

Serie 2:
 10.1 ↖ 9.7 → 10.5 * 10.1 → 9.8 ↑
 10.2 * 10.5 * 10.0 ↑ 10.4 * 10.1 ←
 beste Teiler 109.2 (17.) 116.3 (13.) 126.4 (19.)
 Trefferlage 0.24 mm rechts, 0.67 mm hoch
 Streuwert 1.50, horizontal: 1.55, vertikal: 1.46

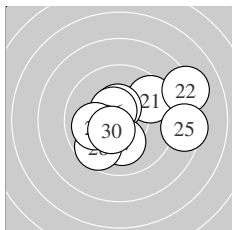

Serie 3:
 9.5 ↗ 8.2 → 10.0 ↙ 10.5 * 8.5 →
 10.5 * 10.1 ↓ 9.7 ↙ 10.0 ← 10.5 *
 beste Teiler 107.3 (26.) 119.3 (24.) 121.3 (30.)
 Trefferlage 0.84 mm rechts, 0.19 mm tief
 Streuwert 2.59, horizontal: 3.17, vertikal: 1.83

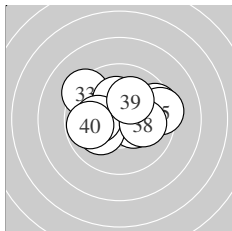

Serie 4:
 10.4 * 10.1 ↙ 9.3 ↘ 9.5 → 9.4 →
 10.2 * 10.1 ← 10.1 → 10.1 ↗ 9.8 ←
 beste Teiler 141.8 (31.) 183.0 (36.) 205.1 (39.)
 Trefferlage 0.15 mm rechts, 0.53 mm hoch
 Streuwert 2.02, horizontal: 2.57, vertikal: 1.23

Unterschrift des Schützen

Ergebnis: **397** (413.1)
 Serien: 99 99 99 100
 Zähler: 37 3 0 0 0 0 0 0 0 0
 Innenzehner: 28
 weiteste: 329 (10), 263 (16), 261 (21)
 beste Teiler 29.0 (14.) 32.1 (33.) 40.0 (8.)
 Trefferlage 0.13 mm rechts, 0.07 mm hoch
 Streuwert 1.22, horizontal: 1.24, vertikal: 1.20

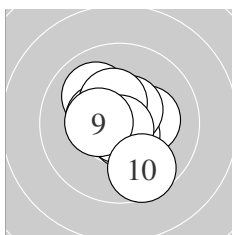
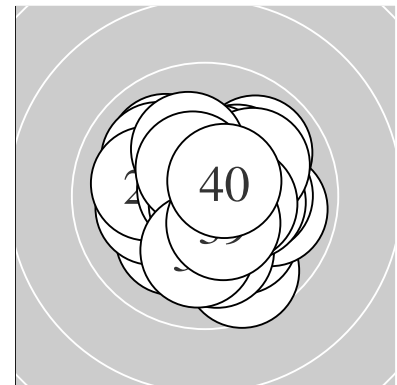

Serie 1:
 10.2 * 10.5 * 10.0 ↘ 10.4 * 10.6 *
 10.5 * 10.4 * 10.8 * 10.4 * 9.6 ↓
 beste Teiler 40.0 (8.) 85.8 (5.) 107.3 (6.)
 Trefferlage 0.09 mm links, 0.14 mm hoch
 Streuwert 1.25, horizontal: 1.16, vertikal: 1.34

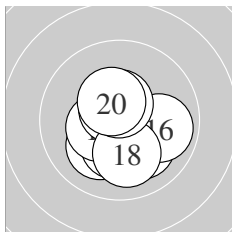

Serie 2:
 10.1 ↙ 10.3 * 10.4 * 10.8 * 10.1 ↓
 9.9 → 10.6 * 10.1 ↓ 10.5 * 10.4 *
 beste Teiler 29.0 (14.) 83.5 (17.) 108.0 (19.)
 Trefferlage 0.08 mm rechts, 0.50 mm tief
 Streuwert 1.21, horizontal: 1.19, vertikal: 1.24

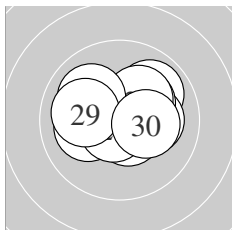

Serie 3:
 9.9 ↗ 10.2 * 10.2 * 10.6 * 10.1 ←
 10.2 * 10.7 * 10.0 ↘ 10.0 ← 10.3 *
 beste Teiler 65.4 (27.) 95.2 (24.) 173.8 (30.)
 Trefferlage 0.23 mm rechts, 0.41 mm hoch
 Streuwert 1.39, horizontal: 1.74, vertikal: 0.93

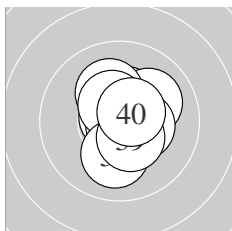

Serie 4:
 10.8 * 10.4 * 10.8 * 10.1 ↗ 10.4 *
 10.2 * 10.5 * 10.1 ↓ 10.4 * 10.6 *
 beste Teiler 32.1 (33.) 50.2 (31.) 96.2 (40.)
 Trefferlage 0.32 mm rechts, 0.25 mm hoch
 Streuwert 1.06, horizontal: 0.86, vertikal: 1.23

Unterschrift des Schützen

Meyton Elektronik

Ergebnis: **390** (409.0)
 Serien: 100 96 95 99
 Zähler: 30 10 0 0 0 0 0 0 0 0
 Innenzehner: 23
 weiteste: 350 (26), 341 (23), 329 (30)
 beste Teiler 27.4 (7.) 55.1 (32.) 59.8 (34.)
 Trefferlage 0.00 mm , 0.18 mm tief
 Streuwert 1.43, horizontal: 1.39, vertikal: 1.48

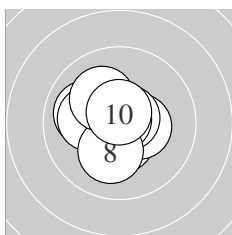
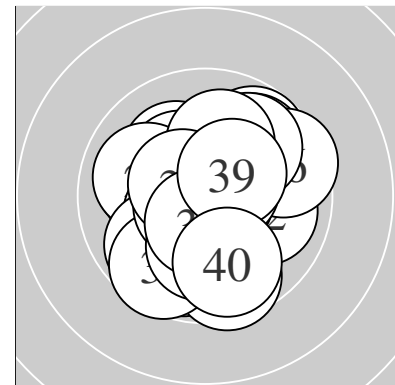

Serie 1:
 10.5 * 10.4 * 10.3 * 10.7 * 10.0 ↖
 10.1 ↖ 10.8 * 10.2 * 10.1 ↗ 10.7 *
 beste Teiler 27.4 (7.) 63.2 (4.) 75.1 (10.)
 Trefferlage 0.57 mm links, 0.10 mm hoch
 Streuwert 1.09, horizontal: 1.16, vertikal: 1.00

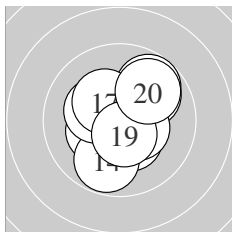

Serie 2:
 9.8 ↗ 10.4 * 10.3 * 9.8 ↓ 10.3 *
 9.9 ↗ 10.3 * 10.4 * 10.5 * 9.8 ↗
 beste Teiler 101.1 (19.) 130.7 (18.) 144.2 (12.)
 Trefferlage 0.31 mm rechts, 0.17 mm hoch
 Streuwert 1.56, horizontal: 1.46, vertikal: 1.65

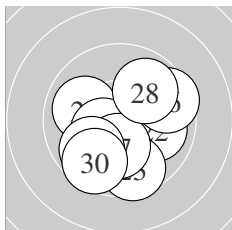

Serie 3:
 10.6 * 10.0 → 9.6 ↓ 10.0 ↖ 10.4 *
 9.6 → 10.2 * 9.9 ↗ 9.8 ↙ 9.6 ↙
 beste Teiler 100.4 (21.) 133.6 (25.) 179.4 (27.)
 Trefferlage 0.01 mm rechts, 0.74 mm tief
 Streuwert 1.86, horizontal: 1.96, vertikal: 1.76

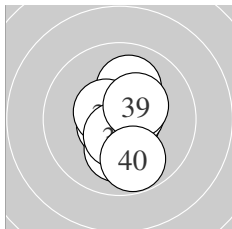

Serie 4:
 10.1 ↑ 10.7 * 10.6 * 10.7 * 10.6 *
 10.5 * 10.1 ↓ 10.5 * 10.4 * 9.8 ↓
 beste Teiler 55.1 (32.) 59.8 (34.) 81.9 (33.)
 Trefferlage 0.25 mm rechts, 0.25 mm tief
 Streuwert 1.13, horizontal: 0.72, vertikal: 1.42

Unterschrift des Schützen

Ergebnis: **395** (413.1)
 Serien: 99 98 99 99
 Zähler: 35 5 0 0 0 0 0 0 0 0
 Innenzehner: 29
 weiteste: 365 (31), 345 (3), 307 (13)
 beste Teiler 5.6 (22.) 53.0 (5.) 53.2 (37.)
 Trefferlage 0.02 mm links, 0.55 mm hoch
 Streuwert 1.21, horizontal: 1.37, vertikal: 1.02

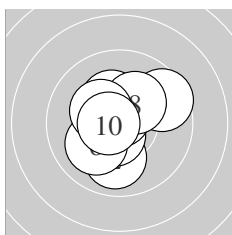
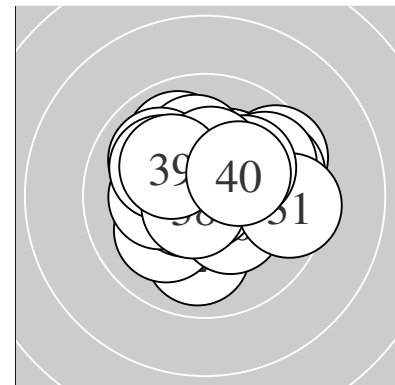

Serie 1:
 10.6 * 10.0 ↓ 9.6 ↗ 10.6 * 10.7 *
 10.1 ↙ 10.3 * 10.2 * 10.3 * 10.6 *
 beste Teiler 53.0 (5.) 79.0 (10.) 85.9 (1.)
 Trefferlage 0.14 mm links, 0.05 mm hoch
 Streuwert 1.37, horizontal: 1.34, vertikal: 1.40

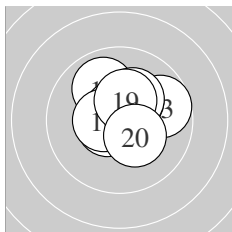

Serie 2:
 9.9 ↖ 10.6 * 9.7 ↗ 10.7 * 10.7 *
 10.5 * 10.3 * 10.2 * 10.4 * 10.3 *
 beste Teiler 61.8 (14.) 65.7 (15.) 90.8 (12.)
 Trefferlage 0.30 mm rechts, 0.71 mm hoch
 Streuwert 1.14, horizontal: 1.26, vertikal: 1.01

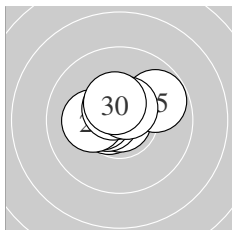

Serie 3:
 10.6 * 10.9 * 10.6 * 10.6 * 9.8 ↗
 10.4 * 10.2 * 10.6 * 10.6 * 10.5 *
 beste Teiler 5.6 (22.) 78.8 (21.) 86.0 (23.)
 Trefferlage 0.31 mm links, 0.47 mm hoch
 Streuwert 0.95, horizontal: 1.21, vertikal: 0.58

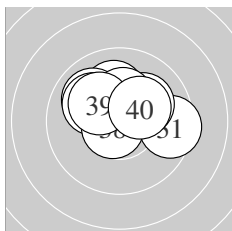

Serie 4:
 9.5 → 10.1 ↑ 10.0 ↘ 10.1 ↗ 10.3 *
 10.1 ↘ 10.7 * 10.7 * 10.2 * 10.3 *
 beste Teiler 53.2 (37.) 65.8 (38.) 160.8 (35.)
 Trefferlage 0.06 mm rechts, 0.95 mm hoch
 Streuwert 1.38, horizontal: 1.76, vertikal: 0.84

Unterschrift des Schützen

Ergebnis: **396** (413.2)
 Serien: 100 100 98 98
 Zähler: 36 4 0 0 0 0 0 0 0 0
 Innenzehner: 31
 weiteste: 414 (40), 355 (31), 287 (30)
 beste Teiler 50.4 (1.) 50.6 (32.) 56.8 (33.)
 Trefferlage 0.04 mm links, 0.09 mm tief
 Streuwert 1.24, horizontal: 1.45, vertikal: 0.99

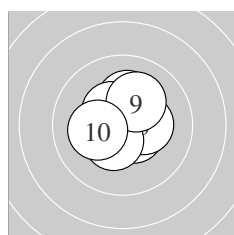
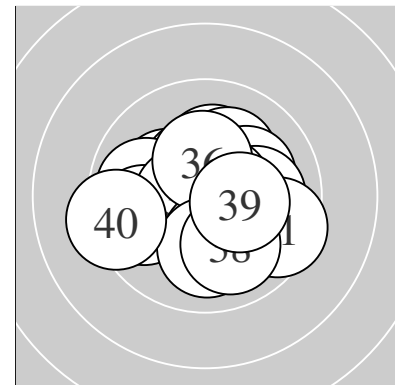

Serie 1:
 10.8 * 10.5 * 10.6 * 10.7 * 10.3 *
 10.2 * 10.4 * 10.4 * 10.1 ↗ 10.2 *
 beste Teiler 50.4 (1.) 57.0 (4.) 80.2 (3.)
 Trefferlage 0.06 mm rechts, 0.24 mm hoch
 Streuwert 1.02, horizontal: 1.04, vertikal: 1.01

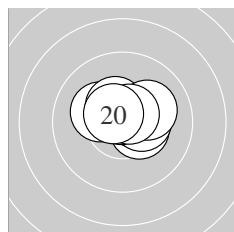

Serie 2:
 10.4 * 10.2 * 10.5 * 10.4 * 10.7 *
 10.6 * 10.4 * 10.1 ↗ 10.6 * 10.6 *
 beste Teiler 58.2 (15.) 78.1 (19.) 92.6 (20.)
 Trefferlage 0.25 mm rechts, 0.53 mm hoch
 Streuwert 0.86, horizontal: 1.12, vertikal: 0.48

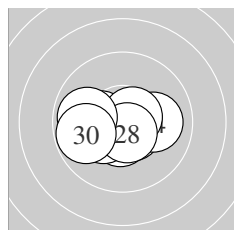

Serie 3:
 10.3 * 10.6 * 10.2 * 10.0 → 10.5 *
 10.6 * 10.3 * 10.6 * 9.9 ← 9.8 ←
 beste Teiler 82.7 (26.) 86.9 (28.) 96.1 (22.)
 Trefferlage 0.63 mm links, 0.40 mm tief
 Streuwert 1.24, horizontal: 1.66, vertikal: 0.56

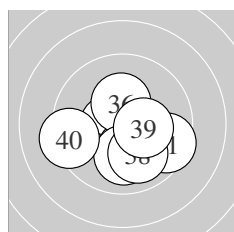

Serie 4:
 9.5 ↘ 10.8 * 10.7 * 10.6 * 10.2 *
 10.3 * 10.0 ↓ 10.0 ↘ 10.3 * 9.3 ←
 beste Teiler 50.6 (32.) 56.8 (33.) 94.0 (34.)
 Trefferlage 0.15 mm rechts, 0.75 mm tief
 Streuwert 1.59, horizontal: 1.87, vertikal: 1.26

Unterschrift des Schützen

Meyton Elektronik

Ergebnis:	385	(401.6)
Serien:	98 96 97 94	
Zähler:	26 13 1 0 0 0 0 0 0 0	
Innenzehner:	18	
weiteste:	566 (37), 497 (24), 433 (40)	
beste Teiler	51.6 (7.) 55.0 (30.) 65.0 (34.)	
Trefferlage	0.30 mm rechts, 0.88 mm hoch	
Streuwert	1.70, horizontal: 1.91, vertikal: 1.46	

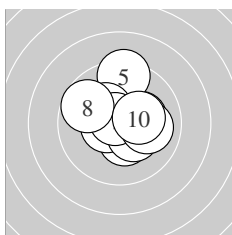
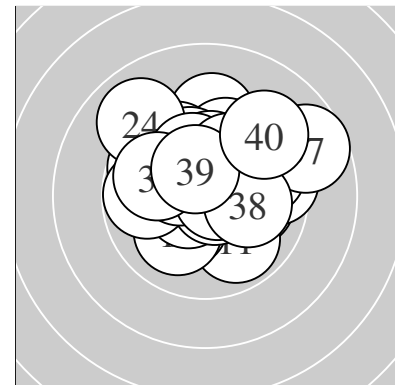

Serie 1:	10.4 *	10.5 *	10.3 *	10.2 *	9.3 ↑
	10.3 *	10.7 *	9.7 ↖	10.0 →	10.3 *
beste Teiler	51.6 (7.)	110.1 (2.)	144.5 (1.)		
Trefferlage	0.23 mm rechts, 0.49 mm hoch				
Streuwert	1.55, horizontal: 1.58, vertikal: 1.52				

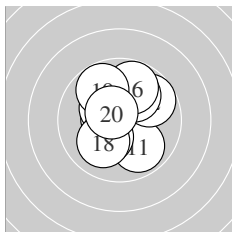

Serie 2:	9.9 ↘	9.7 ↗	10.5 *	10.3 *	10.0 ↗
	9.8 ↑	10.2 *	10.0 ↙	9.8 ↘	10.6 *
beste Teiler	94.7 (20.)	105.3 (13.)	156.7 (14.)		
Trefferlage	0.04 mm links, 0.54 mm hoch				
Streuwert	1.66, horizontal: 1.48, vertikal: 1.82				

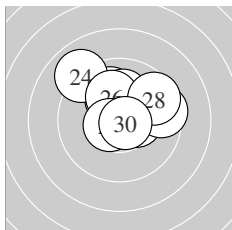

Serie 3:	10.0 ↑	10.4 *	10.2 *	9.0 ↘	10.1 ↑
	10.1 ↑	9.5 →	9.6 ↗	10.6 *	10.7 *
beste Teiler	55.0 (30.)	94.8 (29.)	140.1 (22.)		
Trefferlage	0.23 mm rechts, 1.37 mm hoch				
Streuwert	1.70, horizontal: 1.99, vertikal: 1.33				

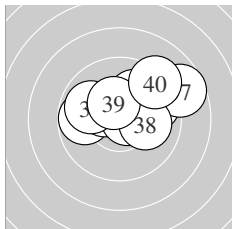

Serie 4:	9.8 ←	10.4 *	9.7 ↗	10.7 *	10.0 ↗
	9.9 ↖	8.7 ↗	10.1 →	10.4 *	9.2 ↗
beste Teiler	65.0 (34.)	144.8 (39.)	147.8 (32.)		
Trefferlage	0.79 mm rechts, 1.15 mm hoch				
Streuwert	2.00, horizontal: 2.60, vertikal: 1.11				

Unterschrift des Schützen

Ergebnis: **390** (406.6)
 Serien: 99 97 97 97
 Zähler: 30 10 0 0 0 0 0 0 0 0
 Innenzehner: 24
 weiteste: 490 (10), 428 (38), 337 (20)
 beste Teiler 35.0 (17.) 51.3 (5.) 79.0 (2.)
 Trefferlage 0.33 mm rechts, 0.03 mm hoch
 Streuwert 1.54, horizontal: 1.69, vertikal: 1.38

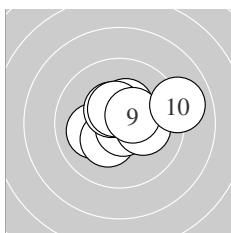
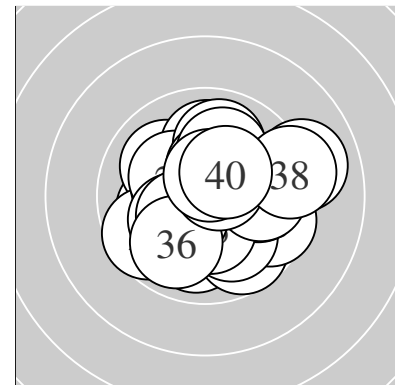

Serie 1:
 10.4 * 10.6 * 10.1 ← 10.3 * 10.7 *
 10.2 * 10.4 * 10.5 * 10.5 * 9.0 →
 beste Teiler 51.3 (5.) 79.0 (2.) 120.2 (8.)
 Trefferlage 0.43 mm rechts, 0.38 mm hoch
 Streuwert 1.48, horizontal: 1.85, vertikal: 0.97

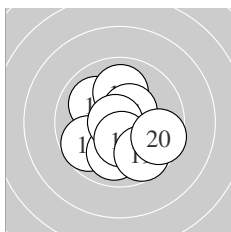

Serie 2:
 10.0 ↖ 10.0 ↑ 10.4 * 10.5 * 9.7 ↙
 10.0 ↓ 10.8 * 10.4 * 9.7 ↘ 9.6 →
 beste Teiler 35.0 (17.) 117.4 (14.) 126.8 (13.)
 Trefferlage 0.20 mm rechts, 0.50 mm tief
 Streuwert 1.67, horizontal: 1.67, vertikal: 1.67

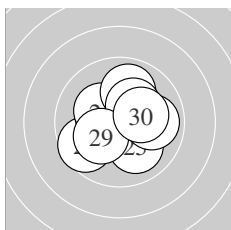

Serie 3:
 9.6 ↙ 10.4 * 10.4 * 10.3 * 10.0 ↘
 9.9 ↑ 9.9 → 10.3 * 10.2 * 10.2 *
 beste Teiler 126.5 (22.) 144.2 (23.) 171.8 (28.)
 Trefferlage 0.06 mm links, 0.00 mm
 Streuwert 1.60, horizontal: 1.76, vertikal: 1.42

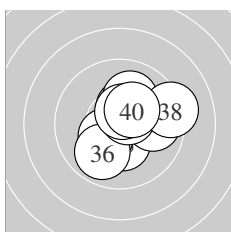

Serie 4:
 10.4 * 10.1 ↑ 10.3 * 10.4 * 9.9 →
 9.9 ↙ 10.6 * 9.2 → 10.5 * 10.3 *
 beste Teiler 88.7 (37.) 102.6 (39.) 140.1 (31.)
 Trefferlage 0.76 mm rechts, 0.25 mm hoch
 Streuwert 1.52, horizontal: 1.64, vertikal: 1.40

Unterschrift des Schützen

Meyton Elektronik

Ergebnis: **373** (392.2)
 Serien: 91 95 95 92
 Zähler: 18 18 3 1 0 0 0 0 0 0
 Innenzehner: 11
 weiteste: 782 (39), 632 (33), 563 (4)
 beste Teiler 38.0 (40.) 73.3 (2.) 76.6 (31.)
 Trefferlage 0.25 mm rechts, 0.38 mm hoch
 Streuwert 2.33, horizontal: 2.68, vertikal: 1.92

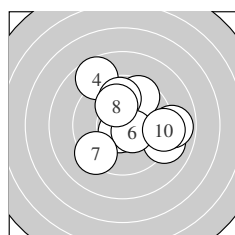
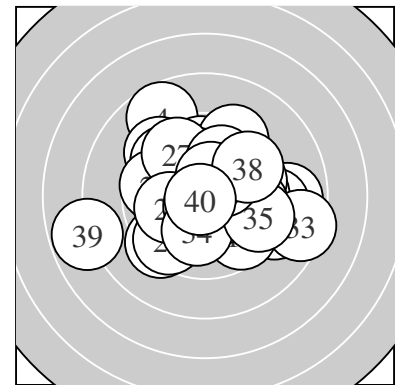

Serie 1:
 9.6 ↗ 10.7 * 9.1 ↘ 8.7 ↖ 9.8 ↑
 10.5 * 9.3 ↙ 10.1 ↕ 8.9 → 9.2 →
 beste Teiler 73.3 (2.) 121.7 (6.) 217.9 (8.)
 Trefferlage 0.98 mm rechts, 0.61 mm hoch
 Streuwert 2.68, horizontal: 2.89, vertikal: 2.46

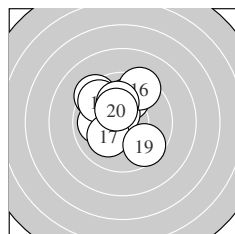

Serie 2:
 10.0 ↑ 9.4 ↘ 9.9 ← 10.6 * 9.6 ↖
 9.4 ↗ 10.1 ↙ 10.1 ↕ 9.6 ↘ 10.4 *
 beste Teiler 94.8 (14.) 148.4 (20.) 206.5 (17.)
 Trefferlage 0.63 mm links, 1.12 mm hoch
 Streuwert 1.84, horizontal: 1.78, vertikal: 1.90

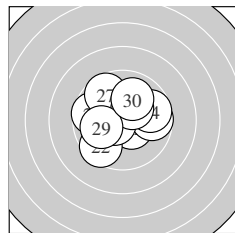

Serie 3:
 10.5 * 9.5 ↙ 9.7 → 9.7 → 10.6 *
 9.7 ← 9.7 ↘ 10.3 * 10.0 ← 10.0 ↑
 beste Teiler 92.5 (25.) 124.7 (21.) 161.3 (28.)
 Trefferlage 0.12 mm links, 0.32 mm hoch
 Streuwert 1.94, horizontal: 2.23, vertikal: 1.59

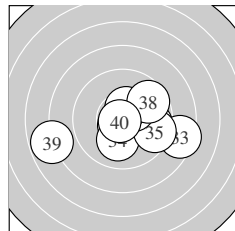

Serie 4:
 10.6 * 9.7 → 8.4 ↘ 10.1 ↓ 9.5 ↘
 10.4 * 10.5 * 9.7 ↗ 7.8 ← 10.8 *
 beste Teiler 38.0 (40.) 76.6 (31.) 122.7 (37.)
 Trefferlage 0.80 mm rechts, 0.51 mm tief
 Streuwert 2.73, horizontal: 3.58, vertikal: 1.46

Unterschrift des Schützen

Ergebnis: **375** (394.1)
 Serien: 91 92 97 95
 Zähler: 21 14 4 1 0 0 0 0 0 0
 Innenzehner: 18
 weiteste: 817 (2), 618 (1), 600 (14)
 beste Teiler 71.1 (16.) 80.9 (28.) 86.5 (40.)
 Trefferlage 0.35 mm rechts, 0.40 mm tief
 Streuwert 2.31, horizontal: 2.84, vertikal: 1.60

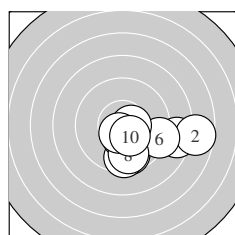
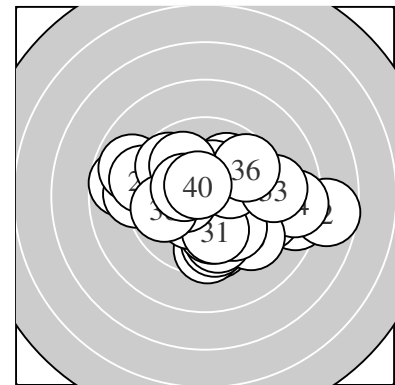

Serie 1:
 8.5 → 7.7 → 9.6 ↓ 9.5 ↓ 10.4 *
 9.2 → 10.6 * 9.7 ↓ 10.6 * 10.4 *
 beste Teiler 95.0 (7.) 95.3 (9.) 138.0 (5.)
 Trefferlage 2.11 mm rechts, 1.73 mm tief
 Streuwert 2.23, horizontal: 2.92, vertikal: 1.17

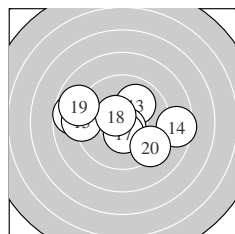

Serie 2:
 10.6 * 8.7 ← 10.0 ↗ 8.6 → 9.1 ←
 10.7 * 10.5 * 10.5 * 8.9 ↖ 9.3 ↘
 beste Teiler 71.1 (16.) 93.2 (11.) 104.7 (18.)
 Trefferlage 0.53 mm links, 0.11 mm hoch
 Streuwert 2.77, horizontal: 3.65, vertikal: 1.42

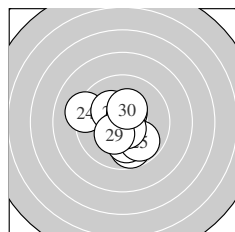

Serie 3:
 10.6 * 9.8 ↓ 10.0 ↓ 9.2 ← 9.8 ↘
 10.2 * 10.5 * 10.6 * 10.3 * 10.3 *
 beste Teiler 80.9 (28.) 89.4 (21.) 110.4 (27.)
 Trefferlage 0.14 mm links, 0.52 mm tief
 Streuwert 1.64, horizontal: 1.66, vertikal: 1.63

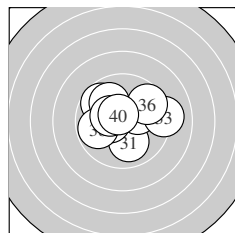

Serie 4:
 10.0 ↓ 10.2 * 9.1 → 9.7 ↘ 10.4 *
 9.6 ↗ 9.9 ↘ 9.8 ← 10.4 * 10.6 *
 beste Teiler 86.5 (40.) 141.1 (35.) 149.3 (39.)
 Trefferlage 0.02 mm links, 0.51 mm hoch
 Streuwert 1.94, horizontal: 2.38, vertikal: 1.35

Unterschrift des Schützen

Ergebnis: **383** (402.7)
 Serien: 96 97 96 94
 Zähler: 24 15 1 0 0 0 0 0 0 0
 Innenzehner: 20
 weiteste: 605 (37), 431 (23), 396 (28)
 beste Teiler 39.5 (17.) 47.8 (4.) 55.9 (22.)
 Trefferlage 0.68 mm rechts, 0.11 mm tief
 Streuwert 1.77, horizontal: 1.96, vertikal: 1.56

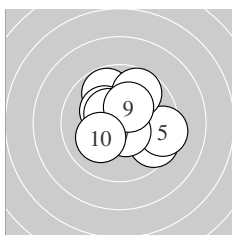
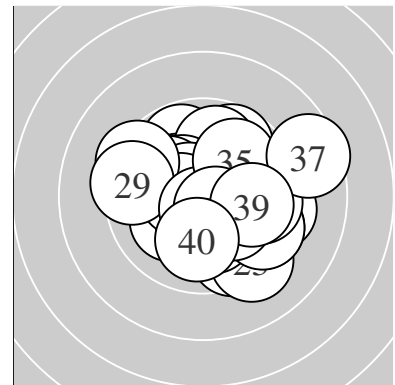

Serie 1:
 9.6 ↘ 9.8 ↖ 10.3 * 10.8 * 9.4 →
 9.7 ↗ 10.6 * 10.4 * 10.3 * 10.1 ↙
 beste Teiler 47.8 (4.) 93.6 (7.) 128.8 (8.)
 Trefferlage 0.41 mm rechts, 0.41 mm hoch
 Streuwert 1.75, horizontal: 1.91, vertikal: 1.57

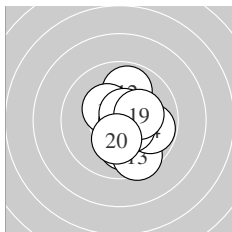

Serie 2:
 10.0 ↓ 9.9 ↑ 9.5 ↘ 9.8 → 10.4 *
 10.5 * 10.8 * 10.7 * 10.2 * 10.3 *
 beste Teiler 39.5 (17.) 71.2 (18.) 115.1 (16.)
 Trefferlage 0.74 mm rechts, 0.38 mm tief
 Streuwert 1.42, horizontal: 1.08, vertikal: 1.69

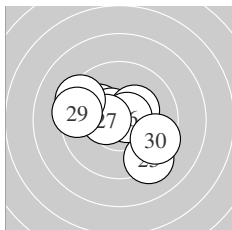

Serie 3:
 10.1 ↖ 10.7 * 9.2 ↘ 10.6 * 10.3 *
 10.7 * 10.5 * 9.4 ↖ 9.4 ← 9.5 ↘
 beste Teiler 55.9 (22.) 71.1 (26.) 97.3 (24.)
 Trefferlage 0.30 mm links, 0.05 mm hoch
 Streuwert 2.00, horizontal: 2.38, vertikal: 1.52

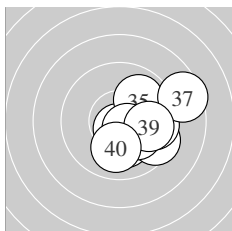

Serie 4:
 10.2 * 10.7 * 9.5 ↘ 9.7 → 9.9 ↗
 10.2 * 8.5 → 10.6 * 9.9 → 10.0 ↓
 beste Teiler 69.0 (32.) 94.7 (38.) 197.0 (36.)
 Trefferlage 1.85 mm rechts, 0.53 mm tief
 Streuwert 1.68, horizontal: 1.84, vertikal: 1.50

Unterschrift des Schützen

Meyton Elektronik

Ergebnis: **397** (414.5)
 Serien: 99 99 99 100
 Zähler: 37 3 0 0 0 0 0 0 0 0
 Innenzehner: 31
 weiteste: 332 (9), 310 (24), 305 (12)
 beste Teiler 15.2 (26.) 57.0 (19.) 58.8 (3.)
 Trefferlage 0.22 mm links, 0.41 mm hoch
 Streuwert 1.15, horizontal: 1.06, vertikal: 1.24

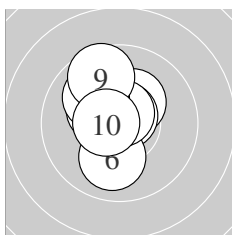
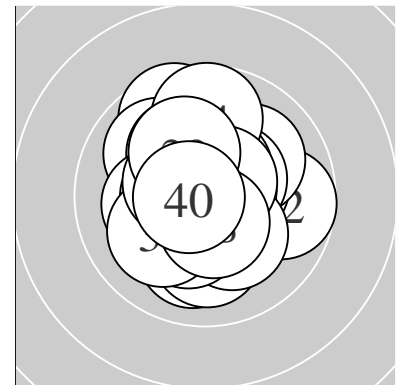

Serie 1:
 10.3 * 10.6 * 10.7 * 10.3 * 10.7 *
 10.0 ↓ 10.7 * 10.0 ↖ 9.6 ↗ 10.6 *
 beste Teiler 58.8 (3.) 59.9 (5.) 67.6 (7.)
 Trefferlage 0.51 mm links, 0.72 mm hoch
 Streuwert 1.11, horizontal: 0.79, vertikal: 1.36

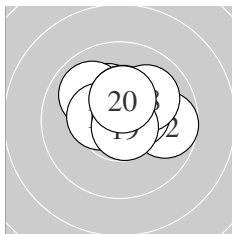

Serie 2:
 10.3 * 9.7 → 10.3 * 10.5 * 10.0 ↖
 10.4 * 10.4 * 10.0 ↗ 10.7 * 10.4 *
 beste Teiler 57.0 (19.) 122.4 (14.) 132.3 (16.)
 Trefferlage 0.14 mm rechts, 0.83 mm hoch
 Streuwert 1.23, horizontal: 1.54, vertikal: 0.80

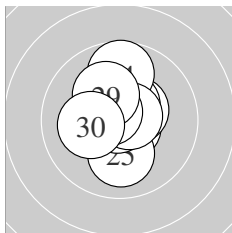

Serie 3:
 10.7 * 10.5 * 10.5 * 9.7 ↑ 10.1 ↓
 10.9 * 10.7 * 10.6 * 10.2 * 10.2 *
 beste Teiler 15.2 (26.) 68.5 (27.) 69.6 (21.)
 Trefferlage 0.08 mm links, 0.43 mm hoch
 Streuwert 1.17, horizontal: 0.88, vertikal: 1.40

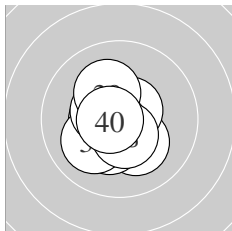

Serie 4:
 10.2 * 10.6 * 10.5 * 10.3 * 10.6 *
 10.1 ↙ 10.5 * 10.5 * 10.2 * 10.7 *
 beste Teiler 65.1 (40.) 87.1 (32.) 100.1 (35.)
 Trefferlage 0.44 mm links, 0.35 mm tief
 Streuwert 0.99, horizontal: 0.88, vertikal: 1.10

Unterschrift des Schützen

Meyton Elektronik

Ergebnis: **386** (403.4)
 Serien: 95 96 98 97
 Zähler: 26 14 0 0 0 0 0 0 0 0
 Innenzehner: 20
 weiteste: 498 (6), 473 (5), 440 (4)
 beste Teiler 19.1 (21.) 56.6 (14.) 65.2 (30.)
 Trefferlage 0.50 mm links, 0.41 mm hoch
 Streuwert 1.70, horizontal: 1.85, vertikal: 1.53

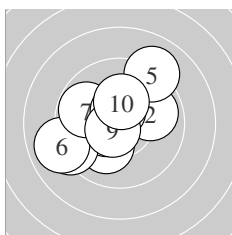
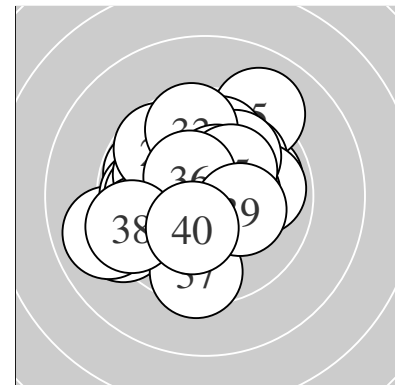

Serie 1:
 10.1 ↘ 9.9 → 10.5 * 9.2 ← 9.1 ↗
 9.0 ← 9.8 ↖ 10.6 * 10.7 * 10.3 *
 beste Teiler 75.0 (9.) 98.8 (8.) 116.0 (3.)
 Trefferlage 0.89 mm links, 0.20 mm hoch
 Streuwert 2.16, horizontal: 2.41, vertikal: 1.88

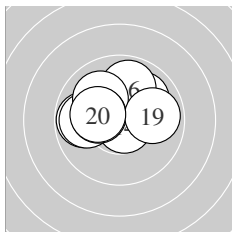

Serie 2:
 9.8 ← 10.3 * 10.0 ↗ 10.7 * 9.9 ←
 9.9 ↑ 10.0 ↘ 10.3 * 9.9 → 10.2 *
 beste Teiler 56.6 (14.) 156.9 (12.) 174.4 (18.)
 Trefferlage 0.39 mm links, 0.78 mm hoch
 Streuwert 1.53, horizontal: 1.95, vertikal: 0.95

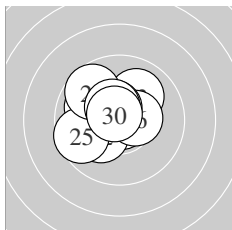

Serie 3:
 10.9 * 10.2 * 10.0 ↗ 10.0 ↖ 9.6 ←
 10.5 * 10.5 * 9.7 ↘ 10.5 * 10.7 *
 beste Teiler 19.1 (21.) 65.2 (30.) 107.4 (27.)
 Trefferlage 0.77 mm links, 0.53 mm hoch
 Streuwert 1.33, horizontal: 1.47, vertikal: 1.17

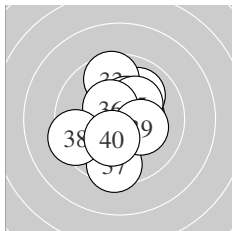

Serie 4:
 10.4 * 10.0 ↗ 9.6 ↑ 10.4 * 10.3 *
 10.5 * 9.5 ↓ 9.4 ← 10.2 * 10.3 *
 beste Teiler 118.0 (36.) 133.7 (34.) 141.5 (31.)
 Trefferlage 0.03 mm rechts, 0.12 mm hoch
 Streuwert 1.81, horizontal: 1.60, vertikal: 2.01

Unterschrift des Schützen

Meyton Elektronik

Ergebnis: **395** (413.1)
 Serien: 98 99 100 98
 Zähler: 35 5 0 0 0 0 0 0 0 0
 Innenzehner: 28
 weiteste: 357 (31), 312 (18), 281 (5)
 beste Teiler 37.6 (16.) 46.8 (11.) 48.0 (22.)
 Trefferlage 0.02 mm links, 0.51 mm hoch
 Streuwert 1.19, horizontal: 1.35, vertikal: 1.02

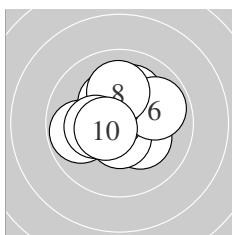
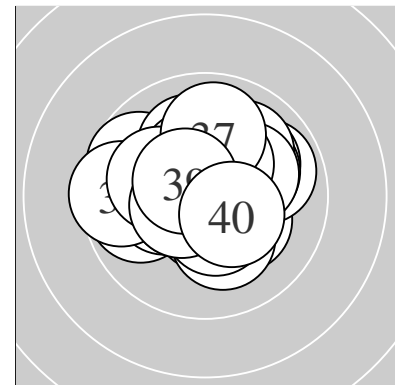

Serie 1:
 10.2 * 10.6 * 10.7 * 10.1 ↗ 9.8 ←
 9.9 ↗ 10.3 * 10.1 ↑ 10.3 * 10.5 *
 beste Teiler 65.2 (3.) 98.0 (2.) 106.4 (10.)
 Trefferlage 0.19 mm links, 0.37 mm hoch
 Streuwert 1.38, horizontal: 1.53, vertikal: 1.20

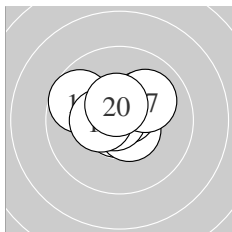

Serie 2:
 10.8 * 10.5 * 10.2 * 10.6 * 10.7 *
 10.8 * 10.0 ↗ 9.7 ↖ 10.4 * 10.5 *
 beste Teiler 37.6 (16.) 46.8 (11.) 70.8 (15.)
 Trefferlage 0.00 mm , 0.54 mm hoch
 Streuwert 1.09, horizontal: 1.35, vertikal: 0.76

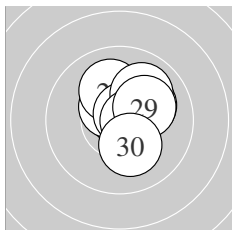

Serie 3:
 10.1 ↗ 10.8 * 10.5 * 10.5 * 10.1 ↑
 10.7 * 10.0 ↗ 10.6 * 10.2 * 10.2 *
 beste Teiler 48.0 (22.) 59.0 (26.) 85.0 (28.)
 Trefferlage 0.68 mm rechts, 0.63 mm hoch
 Streuwert 0.99, horizontal: 0.91, vertikal: 1.07

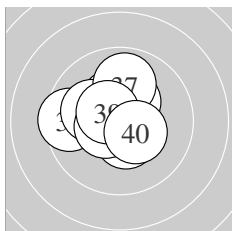

Serie 4:
 9.5 ← 10.3 * 10.4 * 10.1 ↖ 10.6 *
 10.5 * 9.9 ↑ 10.5 * 10.5 * 10.4 *
 beste Teiler 80.7 (35.) 105.8 (39.) 106.7 (38.)
 Trefferlage 0.56 mm links, 0.51 mm hoch
 Streuwert 1.27, horizontal: 1.40, vertikal: 1.13

Unterschrift des Schützen

Ergebnis:	382	(400.4)
Serien:	96 95 97 94	
Zähler:	22 18 0 0 0 0 0 0 0 0	
Innenzehner:	16	
weiteste:	452 (12), 443 (5), 442 (33)	
beste Teiler	3.0 (31.) 47.0 (15.) 74.4 (1.)	
Trefferlage	0.01 mm links, 0.37 mm hoch	
Streuwert	1.84, horizontal: 1.63, vertikal: 2.03	

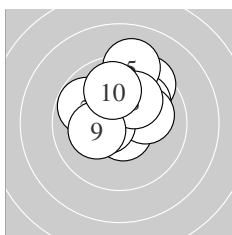
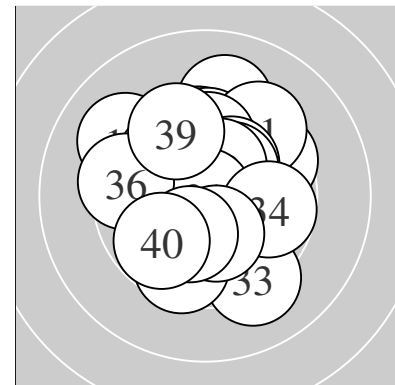

Serie 1:				
	10.7 *	9.8 ↖	9.5 ↗	10.0 ↗
	10.1 →	10.5 *	10.1 ↗	9.2 ↑
beste Teiler	74.4 (1.)	101.8 (7.)	185.0 (9.)	
Trefferlage	0.22 mm rechts, 1.39 mm hoch			
Streuwert	1.64, horizontal: 1.65, vertikal: 1.63			

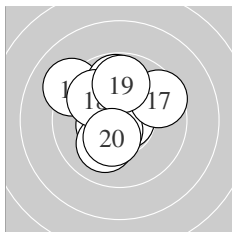

Serie 2:				
	10.5 *	9.1 ↖	9.8 ↑	10.1 ↙
	10.6 *	9.6 ↗	9.9 ↖	10.8 *
beste Teiler	47.0 (15.)	89.5 (16.)	122.3 (11.)	
Trefferlage	0.56 mm links, 0.72 mm hoch			
Streuwert	1.76, horizontal: 1.73, vertikal: 1.79			

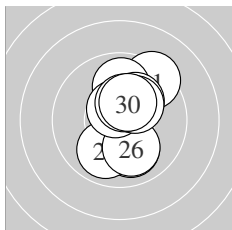

Serie 3:				
	9.4 ↗	9.9 ↑	10.2 *	10.0 ↘
	10.0 ↘	10.6 *	10.3 *	10.4 *
beste Teiler	93.0 (27.)	138.0 (29.)	152.1 (30.)	
Trefferlage	0.63 mm rechts, 0.53 mm hoch			
Streuwert	1.58, horizontal: 0.97, vertikal: 2.01			

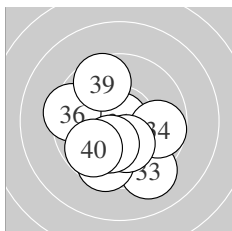

Serie 4:				
	10.9 *	10.2 *	9.2 ↘	9.7 →
	9.4 ←	10.2 *	10.2 *	9.6 ↖
beste Teiler	3.0 (31.)	183.5 (37.)	192.5 (38.)	
Trefferlage	0.35 mm links, 1.16 mm tief			
Streuwert	1.98, horizontal: 1.95, vertikal: 2.00			

Unterschrift des Schützen

Ergebnis: **361** (379.5)
 Serien: 90 87 91 93
 Zähler: 11 19 10 0 0 0 0 0 0 0
 Innenzehner: 9
 weiteste: 669 (33), 637 (22), 632 (12)
 beste Teiler 90.8 (29.) 109.8 (36.) 123.2 (2.)
 Trefferlage 1.80 mm rechts, 0.40 mm hoch
 Streuwert 2.57, horizontal: 2.79, vertikal: 2.33

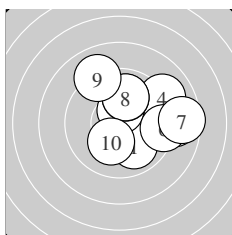
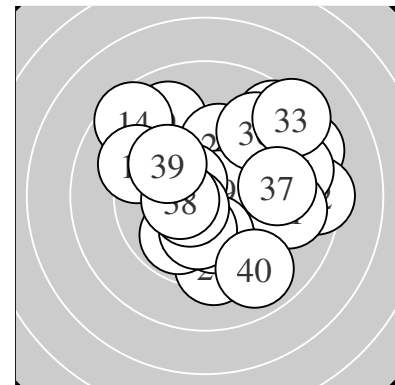

Serie 1:
 9.9 ↘ 10.5 * 8.9 → 9.0 ↗ 9.9 ↑
 9.3 → 8.6 → 9.9 ↑ 9.0 ↘ 10.2 *
 beste Teiler 123.2 (2.) 194.1 (10.) 251.5 (5.)
 Trefferlage 1.91 mm rechts, 0.88 mm hoch
 Streuwert 2.44, horizontal: 2.76, vertikal: 2.07

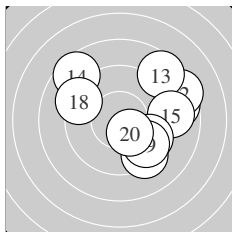

Serie 2:
 8.7 → 8.4 ↗ 8.6 ↗ 8.6 ↘ 9.0 →
 9.3 ↘ 9.6 ↘ 9.2 ↘ 9.6 ↘ 10.3 *
 beste Teiler 154.9 (20.) 334.7 (17.) 341.2 (19.)
 Trefferlage 2.08 mm rechts, 0.65 mm hoch
 Streuwert 3.16, horizontal: 3.54, vertikal: 2.72

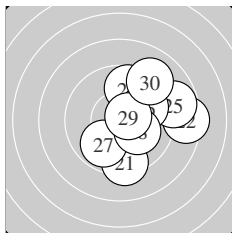

Serie 3:
 9.3 ↓ 8.4 → 9.7 ↑ 10.3 * 8.8 →
 9.9 ↗ 9.9 ↙ 10.2 * 10.6 * 9.1 ↗
 beste Teiler 90.8 (29.) 160.9 (24.) 200.3 (28.)
 Trefferlage 2.06 mm rechts, 0.30 mm hoch
 Streuwert 2.32, horizontal: 2.30, vertikal: 2.33

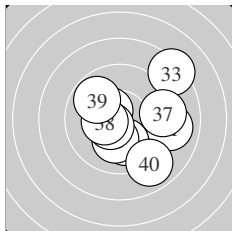

Serie 4:
 9.0 → 10.5 * 8.3 ↗ 10.0 ↓ 10.1 ↓
 10.5 * 9.3 → 10.4 * 9.8 ↘ 8.9 ↘
 beste Teiler 109.8 (36.) 125.7 (32.) 144.8 (38.)
 Trefferlage 1.14 mm rechts, 0.23 mm tief
 Streuwert 2.58, horizontal: 2.76, vertikal: 2.38

Unterschrift des Schützen

Meyton Elektronik

Ergebnis: **382** (399.5)
 Serien: 96 96 95 95
 Zähler: 23 16 1 0 0 0 0 0 0 0
 Innenzehner: 19
 weiteste: 538 (23), 487 (15), 449 (6)
 beste Teiler 37.3 (27.) 55.7 (7.) 85.0 (8.)
 Trefferlage 1.24 mm rechts, 0.19 mm tief
 Streuwert 1.76, horizontal: 1.76, vertikal: 1.76

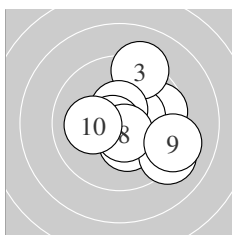
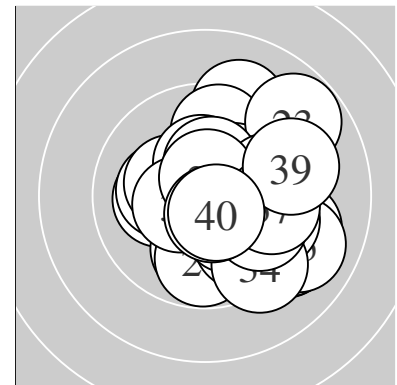

Serie 1:
 9.7 → 10.4 * 9.2 ↑ 10.3 * 10.5 *
 9.2 ↘ 10.7 * 10.6 * 9.2 → 10.1 ←
 beste Teiler 55.7 (7.) 85.0 (8.) 106.1 (5.)
 Trefferlage 1.20 mm rechts, 0.00 mm
 Streuwert 1.91, horizontal: 1.97, vertikal: 1.84

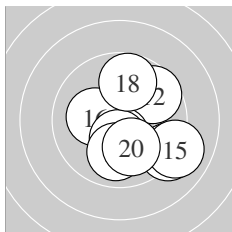

Serie 2:
 10.3 * 9.7 ↗ 10.5 * 9.2 ↘ 9.0 ↘
 10.2 * 10.4 * 9.7 ↑ 10.0 ↓ 10.0 ↓
 beste Teiler 122.1 (13.) 144.4 (17.) 165.0 (11.)
 Trefferlage 1.05 mm rechts, 0.52 mm tief
 Streuwert 1.99, horizontal: 1.93, vertikal: 2.04

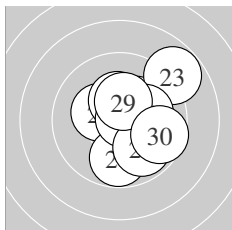

Serie 3:
 10.3 * 10.3 * 8.8 ↗ 10.1 → 10.3 *
 9.8 ↓ 10.8 * 9.9 ↘ 10.4 * 9.6 →
 beste Teiler 37.3 (27.) 147.8 (29.) 154.0 (25.)
 Trefferlage 1.10 mm rechts, 0.26 mm hoch
 Streuwert 1.79, horizontal: 1.68, vertikal: 1.88

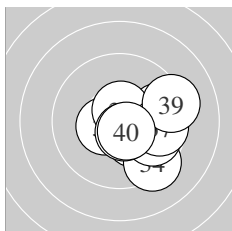

Serie 4:
 10.2 * 10.5 * 9.7 → 9.3 ↘ 9.8 →
 10.6 * 9.7 → 10.6 * 9.3 → 10.6 *
 beste Teiler 86.5 (36.) 91.5 (38.) 93.7 (40.)
 Trefferlage 1.62 mm rechts, 0.53 mm tief
 Streuwert 1.50, horizontal: 1.66, vertikal: 1.32

Unterschrift des Schützen

Meyton Elektronik

Ergebnis: **372** (390.5)
 Serien: 95 89 94 94
 Zähler: 16 21 2 1 0 0 0 0 0 0
 Innenzehner: 11
 weiteste: 763 (12), 571 (39), 503 (20)
 beste Teiler 61.6 (28.) 81.1 (35.) 85.3 (32.)
 Trefferlage 0.36 mm links, 0.31 mm tief
 Streuwert 2.38, horizontal: 2.54, vertikal: 2.21

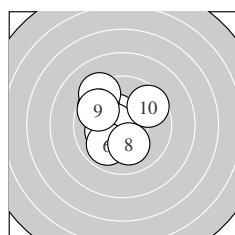
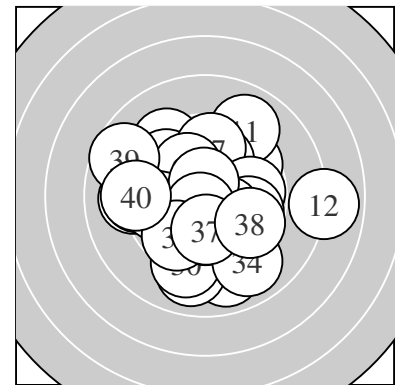

Serie 1:
 10.5 * 10.4 * 9.7 ↘ 10.2 * 10.6 *
 9.9 ↙ 9.3 ↘ 10.1 ↓ 9.7 ↘ 9.6 ↗
 beste Teiler 94.3 (5.) 124.0 (1.) 127.9 (2.)
 Trefferlage 0.93 mm links, 0.42 mm hoch
 Streuwert 1.78, horizontal: 1.69, vertikal: 1.86

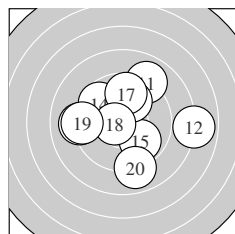

Serie 2:
 9.0 ↗ 7.9 → 9.1 ← 9.7 ↘ 9.9 ↘
 10.0 ↗ 9.7 ↑ 10.6 * 9.2 ← 8.9 ↓
 beste Teiler 87.0 (18.) 240.8 (16.) 271.6 (15.)
 Trefferlage 0.23 mm rechts, 0.37 mm hoch
 Streuwert 3.16, horizontal: 3.61, vertikal: 2.64

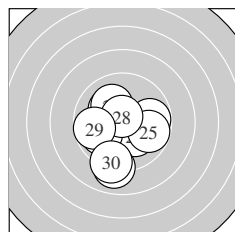

Serie 3:
 10.2 * 9.8 → 10.1 ↘ 10.2 * 9.8 →
 9.0 ↓ 9.9 ↙ 10.7 * 9.7 ← 9.2 ↓
 beste Teiler 61.6 (28.) 195.3 (24.) 198.0 (21.)
 Trefferlage 0.30 mm links, 0.94 mm tief
 Streuwert 2.11, horizontal: 2.02, vertikal: 2.19

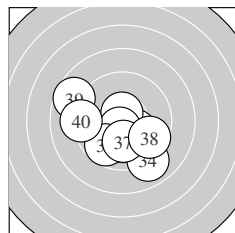

Serie 4:
 10.3 * 10.6 * 10.1 ↓ 9.0 ↘ 10.6 *
 9.7 ↙ 10.1 ↓ 9.6 ↘ 8.7 ↘ 9.2 ←
 beste Teiler 81.1 (35.) 85.3 (32.) 167.4 (31.)
 Trefferlage 0.47 mm links, 1.12 mm tief
 Streuwert 2.32, horizontal: 2.69, vertikal: 1.88

Unterschrift des Schützen

Meyton Elektronik

Ergebnis: **386** (403.4)
 Serien: 94 98 96 98
 Zähler: 27 12 1 0 0 0 0 0 0 0
 Innenzehner: 19
 weiteste: 582 (3), 407 (23), 391 (22)
 beste Teiler 50.8 (27.) 53.5 (25.) 68.2 (18.)
 Trefferlage 0.42 mm rechts, 0.06 mm hoch
 Streuwert 1.72, horizontal: 1.80, vertikal: 1.63

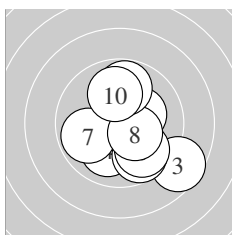
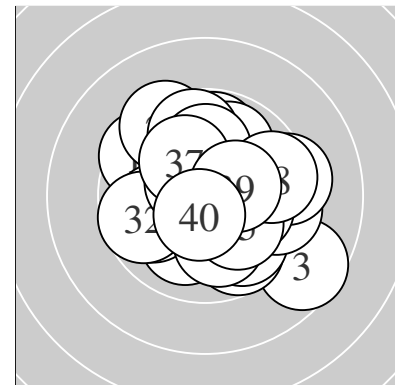

Serie 1:
 10.3 * 10.3 * 8.6 ↘ 10.0 ↓ 9.7 ↘
 9.8 ↘ 9.9 ← 10.4 * 9.8 ↑ 10.0 ↑
 beste Teiler 149.7 (8.) 153.6 (1.) 175.0 (2.)
 Trefferlage 0.65 mm rechts, 0.72 mm tief
 Streuwert 2.06, horizontal: 2.04, vertikal: 2.09

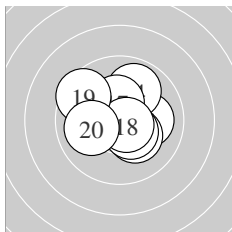

Serie 2:
 10.1 → 10.6 * 10.2 * 9.9 ↑ 10.4 *
 10.4 * 10.4 * 10.7 * 9.5 ↘ 10.0 ←
 beste Teiler 68.2 (18.) 96.6 (12.) 126.1 (16.)
 Trefferlage 0.01 mm links, 0.43 mm hoch
 Streuwert 1.46, horizontal: 1.63, vertikal: 1.26

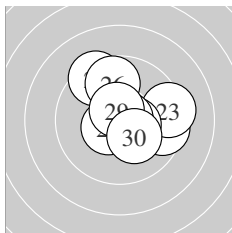

Serie 3:
 9.5 → 9.4 ↘ 9.3 → 10.5 * 10.7 *
 9.7 ↑ 10.8 * 10.5 * 10.6 * 10.2 *
 beste Teiler 50.8 (27.) 53.5 (25.) 87.3 (29.)
 Trefferlage 0.63 mm rechts, 0.56 mm hoch
 Streuwert 1.73, horizontal: 1.89, vertikal: 1.54

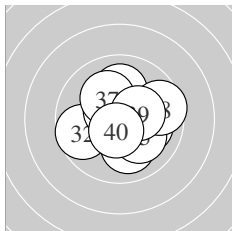

Serie 4:
 10.1 → 9.7 ← 10.0 ↓ 10.6 * 10.1 ↘
 10.0 ↑ 10.2 * 9.6 → 10.3 * 10.6 *
 beste Teiler 97.0 (34.) 97.1 (40.) 156.2 (39.)
 Trefferlage 0.41 mm rechts, 0.01 mm tief
 Streuwert 1.63, horizontal: 1.80, vertikal: 1.44

Unterschrift des Schützen

Ergebnis: **391** (406.3)
 Serien: 99 97 96 99
 Zähler: 31 9 0 0 0 0 0 0 0 0
 Innenzehner: 23
 weiteste: 448 (19), 436 (21), 366 (1)
 beste Teiler 72.1 (28.) 80.0 (3.) 81.0 (35.)
 Trefferlage 0.30 mm links, 0.23 mm tief
 Streuwert 1.54, horizontal: 1.72, vertikal: 1.33

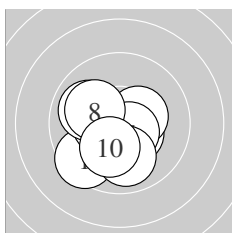
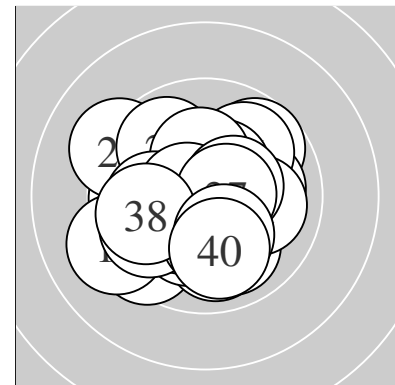

Serie 1:
 9.5 ↙ 10.4 * 10.6 * 10.0 ↘ 10.4 *
 10.4 * 10.6 * 10.1 ↖ 10.0 ↓ 10.2 *
 beste Teiler 80.0 (3.) 96.9 (7.) 126.5 (2.)
 Trefferlage 0.51 mm links, 0.67 mm tief
 Streuwert 1.37, horizontal: 1.44, vertikal: 1.30

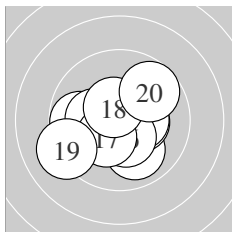

Serie 2:
 9.8 ← 10.0 ↘ 10.4 * 10.2 * 10.4 *
 10.4 * 10.3 * 10.5 * 9.2 ↙ 9.7 ↗
 beste Teiler 105.1 (18.) 133.8 (16.) 143.0 (15.)
 Trefferlage 0.33 mm links, 0.38 mm tief
 Streuwert 1.74, horizontal: 2.06, vertikal: 1.35

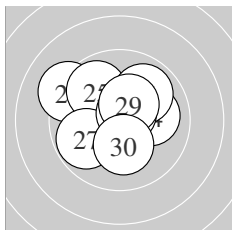

Serie 3:
 9.2 ↘ 10.4 * 10.4 * 10.0 → 9.8 ↖
 9.9 ↗ 9.8 ↙ 10.7 * 10.4 * 10.2 *
 beste Teiler 72.1 (28.) 136.4 (23.) 136.6 (29.)
 Trefferlage 0.26 mm links, 0.50 mm hoch
 Streuwert 1.72, horizontal: 1.98, vertikal: 1.41

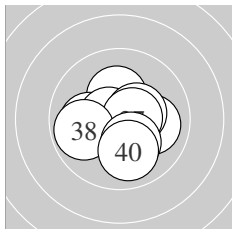

Serie 4:
 10.0 → 10.3 * 10.0 ← 10.4 * 10.6 *
 10.4 * 10.6 * 9.9 ← 10.2 * 10.0 ↓
 beste Teiler 81.0 (35.) 94.3 (37.) 126.5 (34.)
 Trefferlage 0.10 mm links, 0.37 mm tief
 Streuwert 1.38, horizontal: 1.59, vertikal: 1.12

Unterschrift des Schützen

Ergebnis: **377** (399.4)
 Serien: 94 93 95 95
 Zähler: 20 17 3 0 0 0 0 0 0 0
 Innenzehner: 15
 weiteste: 615 (12), 534 (26), 513 (4)
 beste Teiler 47.1 (5.) 56.8 (1.) 65.0 (38.)
 Trefferlage 0.19 mm rechts, 0.07 mm hoch
 Streuwert 1.97, horizontal: 2.10, vertikal: 1.83

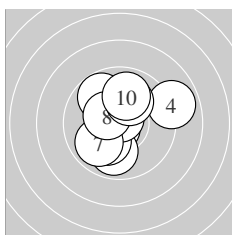
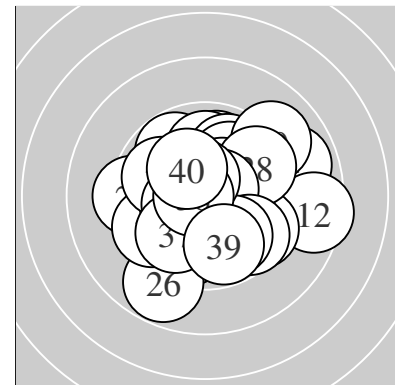

Serie 1:
 10.7 * 9.9 ↓ 10.1 ↙ 8.9 → 10.8 *
 9.8 ↘ 9.9 ↙ 10.4 * 10.1 ↑ 9.9 ↑
 beste Teiler 47.1 (5.) 56.8 (1.) 136.0 (8.)
 Trefferlage 0.03 mm links, 0.33 mm hoch
 Streuwert 1.92, horizontal: 1.95, vertikal: 1.88

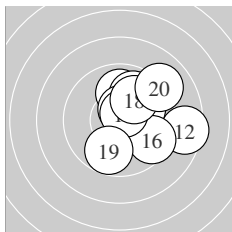

Serie 2:
 9.9 ↑ 8.5 → 9.9 ↗ 10.0 → 10.5 *
 9.6 ↘ 10.6 * 10.0 ↗ 9.8 ↓ 9.0 ↗
 beste Teiler 76.0 (17.) 105.3 (15.) 228.9 (14.)
 Trefferlage 1.70 mm rechts, 0.69 mm hoch
 Streuwert 2.03, horizontal: 2.09, vertikal: 1.96

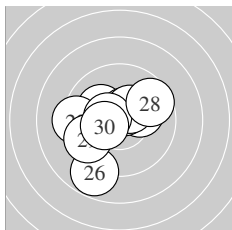

Serie 3:
 10.2 * 10.1 ↘ 9.3 ← 10.6 * 10.4 *
 8.8 ↓ 10.5 * 9.6 ↗ 9.6 ↙ 10.4 *
 beste Teiler 89.0 (24.) 115.6 (27.) 138.6 (25.)
 Trefferlage 0.75 mm links, 0.16 mm tief
 Streuwert 2.06, horizontal: 2.21, vertikal: 1.89

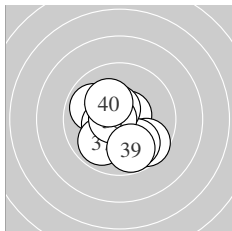

Serie 4:
 10.6 * 9.6 ↘ 9.9 ↘ 9.9 ↘ 10.6 *
 10.4 * 9.9 ↙ 10.7 * 9.8 ↓ 10.2 *
 beste Teiler 65.0 (38.) 84.0 (31.) 99.6 (35.)
 Trefferlage 0.15 mm links, 0.57 mm tief
 Streuwert 1.57, horizontal: 1.55, vertikal: 1.59

Unterschrift des Schützen

Ergebnis: **390** (406.7)
 Serien: 97 99 99 95
 Zähler: 30 10 0 0 0 0 0 0 0 0
 Innenzehner: 25
 weiteste: 428 (35), 423 (18), 418 (9)
 beste Teiler 10.0 (13.) 47.3 (7.) 47.6 (21.)
 Trefferlage 0.35 mm rechts, 0.06 mm tief
 Streuwert 1.58, horizontal: 1.88, vertikal: 1.20

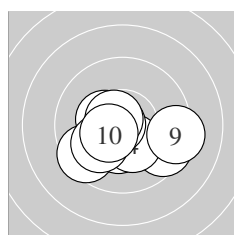
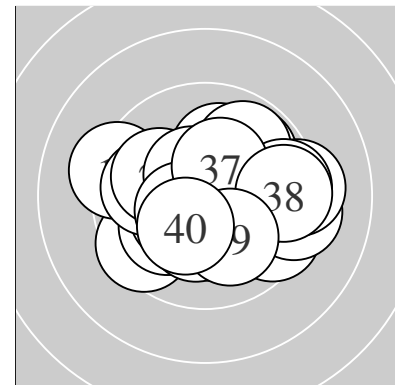

Serie 1:
 10.3 * 9.5 ↘ 9.5 ↙ 10.3 * 10.4 *
 10.0 ↙ 10.8 * 10.6 * 9.3 → 10.5 *
 beste Teiler 47.3 (7.) 81.2 (8.) 122.2 (10.)
 Trefferlage 0.04 mm links, 0.86 mm tief
 Streuwert 1.67, horizontal: 2.17, vertikal: 0.94

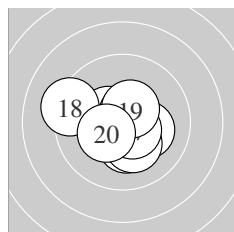

Serie 2:
 10.3 * 10.2 * 10.9 * 10.5 * 10.2 *
 10.7 * 10.6 * 9.3 ← 10.5 * 10.3 *
 beste Teiler 10.0 (13.) 75.4 (16.) 96.8 (17.)
 Trefferlage 0.18 mm links, 0.19 mm tief
 Streuwert 1.37, horizontal: 1.63, vertikal: 1.04

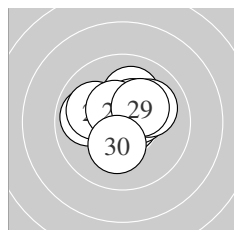

Serie 3:
 10.8 * 10.1 ↑ 10.4 * 10.4 * 9.9 ←
 10.0 ↗ 10.0 ← 10.5 * 10.2 * 10.2 *
 beste Teiler 47.6 (21.) 115.4 (28.) 132.3 (24.)
 Trefferlage 0.06 mm rechts, 0.64 mm hoch
 Streuwert 1.27, horizontal: 1.50, vertikal: 1.00

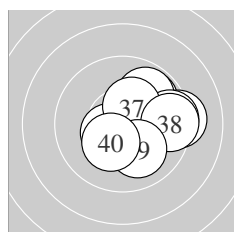

Serie 4:
 10.5 * 9.8 ↗ 9.8 ↗ 10.5 * 9.2 →
 9.5 → 10.3 * 9.5 → 10.1 ↘ 10.3 *
 beste Teiler 110.2 (31.) 121.4 (34.) 154.7 (37.)
 Trefferlage 1.58 mm rechts, 0.13 mm hoch
 Streuwert 1.63, horizontal: 1.85, vertikal: 1.38

Unterschrift des Schützen

Meyton Elektronik

Ergebnis: **373** (387.4)
 Serien: 92 94 96 91
 Zähler: 18 18 3 1 0 0 0 0 0 0
 Innenzehner: 9
 weiteste: 762 (38), 743 (37), 687 (5)
 beste Teiler 91.5 (20.) 100.8 (21.) 123.0 (32.)
 Trefferlage 0.91 mm rechts, 0.12 mm hoch
 Streuwert 2.49, horizontal: 2.88, vertikal: 2.03

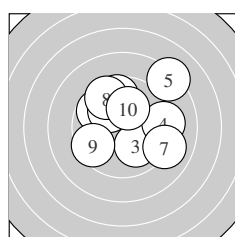
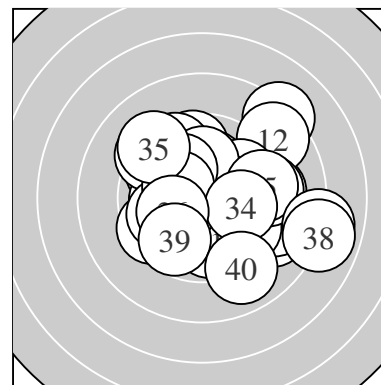

Serie 1:
 9.7 ↑ 9.7 ↖ 10.0 ↘ 9.3 → 8.2 ↗
 10.1 ↘ 9.0 ↘ 9.6 ↘ 9.5 ↙ 10.1 ↑
 beste Teiler 203.5 (10.) 218.1 (6.) 233.4 (3.)
 Trefferlage 0.60 mm rechts, 1.11 mm hoch
 Streuwert 2.70, horizontal: 2.96, vertikal: 2.42

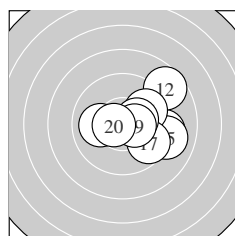

Serie 2:
 9.2 → 8.7 ↗ 10.0 → 10.0 ← 9.1 →
 9.8 ↗ 9.6 ↘ 10.3 * 10.5 * 10.6 *
 beste Teiler 91.5 (20.) 124.9 (19.) 154.3 (18.)
 Trefferlage 2.01 mm rechts, 0.16 mm hoch
 Streuwert 1.93, horizontal: 2.25, vertikal: 1.55

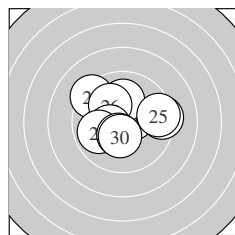

Serie 3:
 10.6 * 10.1 ↑ 9.3 → 9.3 ↖ 9.4 →
 10.1 ↘ 10.4 * 9.9 ← 10.4 * 10.4 *
 beste Teiler 100.8 (21.) 139.1 (29.) 142.6 (27.)
 Trefferlage 0.02 mm links, 0.38 mm hoch
 Streuwert 1.98, horizontal: 2.39, vertikal: 1.47

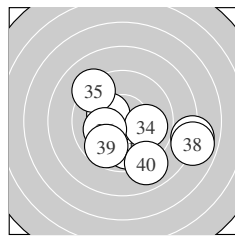

Serie 4:
 9.8 ↓ 10.5 * 10.3 * 10.0 → 9.2 ↖
 10.1 ← 8.0 → 7.9 → 9.7 ↙ 9.0 ↘
 beste Teiler 123.0 (32.) 163.2 (33.) 203.1 (36.)
 Trefferlage 1.06 mm rechts, 1.16 mm tief
 Streuwert 3.02, horizontal: 3.72, vertikal: 2.09

Unterschrift des Schützen

Meyton Elektronik

Ergebnis: **375** (393.8)
 Serien: 93 94 98 90
 Zähler: 18 19 3 0 0 0 0 0 0 0
 Innenzehner: 16
 weiteste: 628 (36), 558 (38), 523 (8)
 beste Teiler 84.5 (21.) 89.8 (22.) 95.1 (31.)
 Trefferlage 0.37 mm links, 0.28 mm hoch
 Streuwert 2.22, horizontal: 2.60, vertikal: 1.77

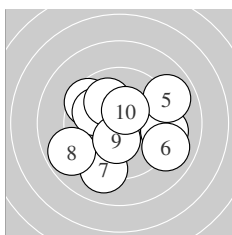
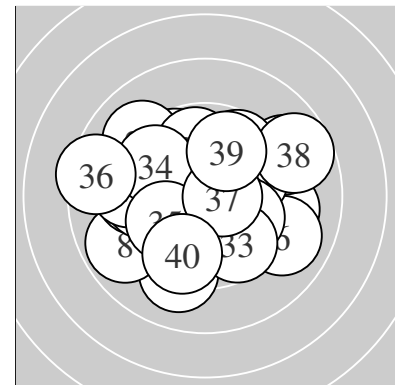

Serie 1:
 9.5 ↖ 10.0 ↖ 10.0 ↖ 9.2 → 9.0 ↗
 9.0 ↗ 9.1 ↓ 8.9 ↙ 10.3 * 10.4 *
 beste Teiler 131.5 (10.) 156.7 (9.) 229.2 (3.)
 Trefferlage 0.09 mm rechts, 0.29 mm tief
 Streuwert 2.81, horizontal: 3.23, vertikal: 2.32

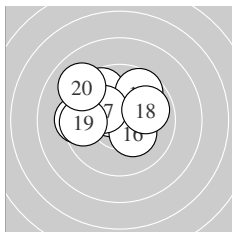

Serie 2:
 10.5 * 9.7 ↖ 10.5 * 9.7 ↗ 9.4 ←
 10.3 * 10.2 * 9.9 → 9.6 ← 9.1 ↖
 beste Teiler 101.9 (13.) 107.2 (11.) 172.5 (16.)
 Trefferlage 0.82 mm links, 0.98 mm hoch
 Streuwert 1.95, horizontal: 2.37, vertikal: 1.41

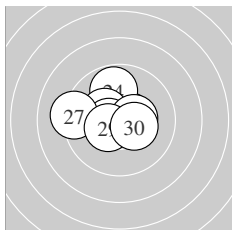

Serie 3:
 10.6 * 10.6 * 10.6 * 9.8 ↑ 10.3 *
 10.5 * 9.2 ← 10.4 * 10.4 * 10.4 *
 beste Teiler 84.5 (21.) 89.8 (22.) 97.6 (23.)
 Trefferlage 0.62 mm links, 0.41 mm hoch
 Streuwert 1.35, horizontal: 1.64, vertikal: 0.96

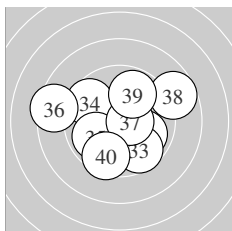

Serie 4:
 10.6 * 9.9 ↗ 9.7 ↘ 9.6 ↖ 9.9 ↙
 8.4 ← 10.6 * 8.7 → 9.8 ↑ 9.5 ↓
 beste Teiler 95.1 (31.) 98.0 (37.) 255.4 (32.)
 Trefferlage 0.15 mm links, 0.02 mm hoch
 Streuwert 2.66, horizontal: 3.14, vertikal: 2.07

Unterschrift des Schützen

Meyton Elektronik

Ergebnis: **368** (387.0)
 Serien: 91 92 94 91
 Zähler: 16 18 4 2 0 0 0 0 0 0
 Innenzehner: 9
 weiteste: 785 (1), 768 (21), 588 (37)
 beste Teiler 58.9 (39.) 78.1 (35.) 80.8 (14.)
 Trefferlage 0.83 mm links, 0.35 mm hoch
 Streuwert 2.51, horizontal: 3.19, vertikal: 1.55

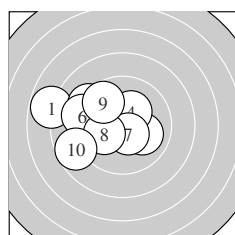
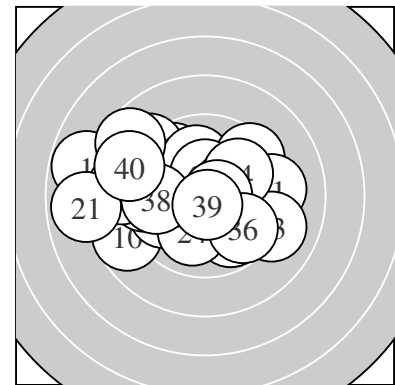

Serie 1:
 7.8 ← 9.5 ← 10.0 → 10.3 * 9.2 ↘
 9.2 ← 10.5 * 10.1 ← 9.7 ↘ 8.7 ←
 beste Teiler 111.5 (7.) 169.8 (4.) 215.6 (8.)
 Trefferlage 2.45 mm links, 0.42 mm hoch
 Streuwert 2.43, horizontal: 3.01, vertikal: 1.68

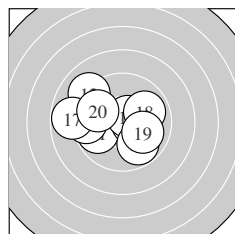

Serie 2:
 9.8 ← 9.1 ↘ 10.5 * 10.6 * 9.4 ←
 9.8 ↘ 8.8 ← 9.9 → 10.0 → 9.8 ↘
 beste Teiler 80.8 (14.) 108.8 (13.) 241.4 (19.)
 Trefferlage 1.04 mm links, 0.16 mm hoch
 Streuwert 2.29, horizontal: 2.88, vertikal: 1.49

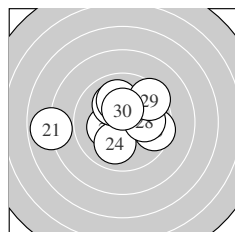

Serie 3:
 7.9 ← 10.3 * 9.9 ↗ 10.0 ↓ 9.6 →
 10.1 ↘ 10.0 ↑ 10.0 → 9.4 ↗ 10.4 *
 beste Teiler 139.0 (30.) 168.5 (22.) 212.1 (26.)
 Trefferlage 0.10 mm links, 0.53 mm hoch
 Streuwert 2.53, horizontal: 3.20, vertikal: 1.58

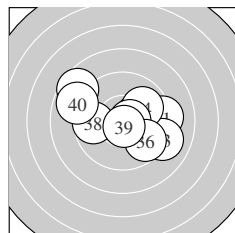

Serie 4:
 9.2 → 10.3 * 9.1 ↘ 9.9 ↗ 10.6 *
 9.7 ↘ 8.6 ↘ 9.7 ← 10.7 * 8.9 ←
 beste Teiler 58.9 (39.) 78.1 (35.) 153.2 (32.)
 Trefferlage 0.26 mm rechts, 0.29 mm hoch
 Streuwert 2.70, horizontal: 3.42, vertikal: 1.68

Unterschrift des Schützen

Meyton Elektronik

Ergebnis: **371** (390.8)
 Serien: 93 92 90 96
 Zähler: 16 20 3 1 0 0 0 0 0 0
 Innenzehner: 10
 weiteste: 813 (16), 556 (24), 541 (27)
 beste Teiler 66.2 (23.) 109.4 (5.) 111.7 (39.)
 Trefferlage 0.30 mm rechts, 0.17 mm tief
 Streuwert 2.31, horizontal: 2.76, vertikal: 1.75

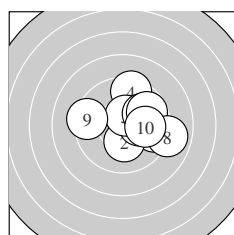
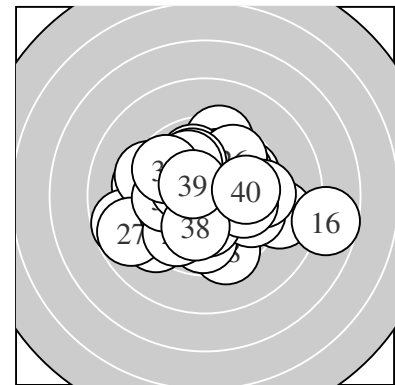

Serie 1:
 9.5 → 10.2 * 10.2 * 9.4 ↑ 10.5 *
 9.9 ↗ 9.7 ↗ 8.9 → 9.4 ← 10.0 →
 beste Teiler 109.4 (5.) 179.0 (2.) 180.0 (3.)
 Trefferlage 1.50 mm rechts, 0.42 mm hoch
 Streuwert 2.02, horizontal: 2.38, vertikal: 1.58

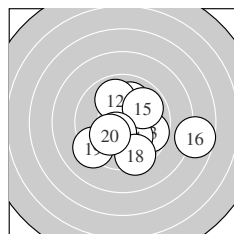

Serie 2:
 10.0 ↑ 9.9 ↖ 9.7 → 10.2 * 9.9 ↗
 7.7 → 10.4 * 9.4 ↓ 9.2 ↙ 10.2 *
 beste Teiler 135.6 (17.) 192.2 (14.) 195.1 (20.)
 Trefferlage 1.02 mm rechts, 0.70 mm tief
 Streuwert 2.60, horizontal: 3.04, vertikal: 2.06

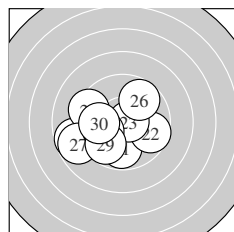

Serie 3:
 9.8 ↓ 9.6 → 10.7 * 8.7 ← 9.4 ↖
 9.7 ↗ 8.8 ← 10.0 ← 9.7 ↙ 9.9 ←
 beste Teiler 66.2 (23.) 233.0 (28.) 258.2 (30.)
 Trefferlage 1.49 mm links, 0.77 mm tief
 Streuwert 2.32, horizontal: 2.80, vertikal: 1.72

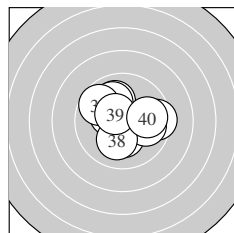

Serie 4:
 10.2 * 10.0 ↖ 10.0 ↖ 10.4 * 9.7 ↖
 9.5 → 9.9 → 10.1 ↓ 10.5 * 9.9 →
 beste Teiler 111.7 (39.) 150.8 (34.) 177.4 (31.)
 Trefferlage 0.17 mm rechts, 0.36 mm hoch
 Streuwert 1.80, horizontal: 2.08, vertikal: 1.47

Unterschrift des Schützen

Meyton Elektronik

Ergebnis: **395** (413.4)
 Serien: 99 98 99 99
 Zähler: 35 5 0 0 0 0 0 0 0 0
 Innenzehner: 27
 weiteste: 374 (31), 339 (8), 295 (16)
 beste Teiler 13.0 (12.) 31.7 (3.) 34.0 (35.)
 Trefferlage 0.21 mm links, 0.12 mm hoch
 Streuwert 1.26, horizontal: 1.37, vertikal: 1.15

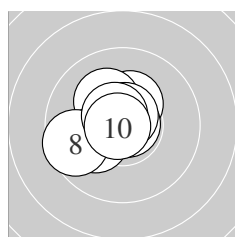
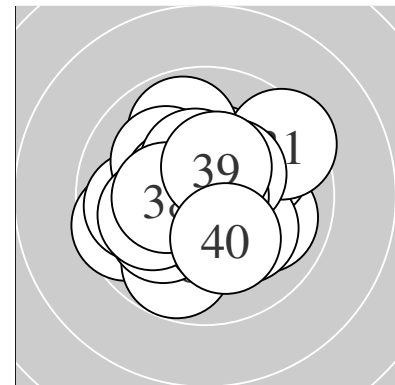

Serie 1:
 10.3 * 10.2 * 10.8 * 10.8 * 10.7 *
 10.1 ← 10.7 * 9.6 ← 10.6 * 10.8 *
 beste Teiler 31.7 (3.) 35.6 (10.) 41.1 (4.)
 Trefferlage 0.63 mm links, 0.27 mm hoch
 Streuwert 1.03, horizontal: 1.13, vertikal: 0.92

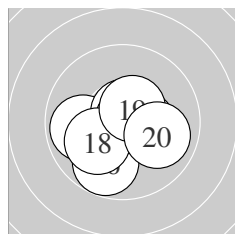

Serie 2:
 10.4 * 10.9 * 9.9 ← 10.7 * 10.1 ↙
 9.8 ↘ 10.8 * 10.1 ↗ 10.5 * 10.0 →
 beste Teiler 13.0 (12.) 38.8 (17.) 66.4 (14.)
 Trefferlage 0.20 mm links, 0.54 mm tief
 Streuwert 1.33, horizontal: 1.50, vertikal: 1.15

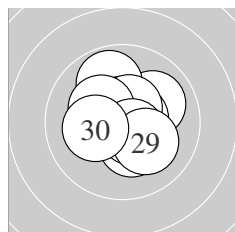

Serie 3:
 10.0 ↗ 10.6 * 9.9 ↖ 10.4 * 10.5 *
 10.3 * 10.3 * 10.6 * 10.1 ↘ 10.2 *
 beste Teiler 89.8 (22.) 92.6 (28.) 105.6 (25.)
 Trefferlage 0.06 mm rechts, 0.28 mm hoch
 Streuwert 1.30, horizontal: 1.34, vertikal: 1.26

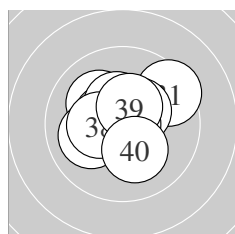

Serie 4:
 9.5 ↗ 10.1 ↖ 10.4 * 10.5 * 10.8 *
 10.1 ← 10.4 * 10.3 * 10.4 * 10.2 *
 beste Teiler 34.0 (35.) 116.4 (34.) 126.6 (39.)
 Trefferlage 0.09 mm links, 0.47 mm hoch
 Streuwert 1.38, horizontal: 1.58, vertikal: 1.14

Unterschrift des Schützen

Ergebnis: **399** (415.9)
 Serien: 100 100 100 99
 Zähler: 39 1 0 0 0 0 0 0 0 0
 Innenzehner: 31
 weiteste: 341 (40), 245 (14), 243 (38)
 beste Teiler 23.4 (22.) 40.8 (20.) 42.1 (36.)
 Trefferlage 0.09 mm rechts, 0.24 mm tief
 Streuwert 1.09, horizontal: 1.22, vertikal: 0.94

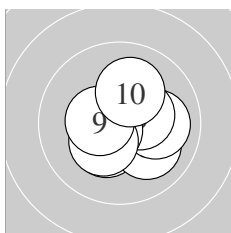
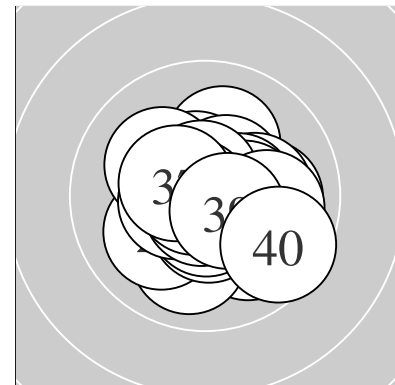

Serie 1:
 10.6 * 10.3 * 10.1 ↘ 10.5 * 10.0 →
 10.4 * 10.6 * 10.3 * 10.4 * 10.1 ↑
 beste Teiler 88.3 (7.) 97.5 (1.) 114.9 (4.)
 Trefferlage 0.20 mm rechts, 0.20 mm tief
 Streuwert 1.19, horizontal: 1.35, vertikal: 1.02

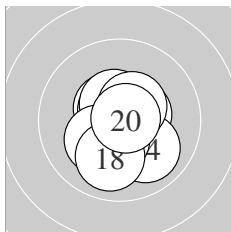

Serie 2:
 10.5 * 10.5 * 10.6 * 10.0 ↘ 10.4 *
 10.5 * 10.2 * 10.0 ↓ 10.5 * 10.8 *
 beste Teiler 40.8 (20.) 80.2 (13.) 107.4 (12.)
 Trefferlage 0.01 mm rechts, 0.27 mm tief
 Streuwert 1.11, horizontal: 0.95, vertikal: 1.25

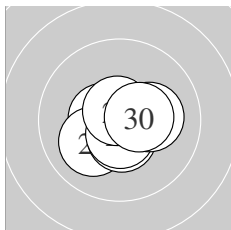

Serie 3:
 10.5 * 10.9 * 10.4 * 10.5 * 10.1 ↙
 10.5 * 10.6 * 10.7 * 10.2 * 10.4 *
 beste Teiler 23.4 (22.) 61.8 (28.) 88.1 (27.)
 Trefferlage 0.14 mm links, 0.36 mm tief
 Streuwert 0.92, horizontal: 1.09, vertikal: 0.70

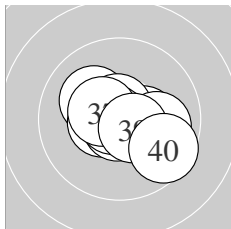

Serie 4:
 10.1 ↘ 10.5 * 10.8 * 10.3 * 10.7 *
 10.8 * 10.5 * 10.0 → 10.5 * 9.6 ↘
 beste Teiler 42.1 (36.) 49.0 (33.) 69.4 (35.)
 Trefferlage 0.30 mm rechts, 0.13 mm tief
 Streuwert 1.24, horizontal: 1.54, vertikal: 0.84

Unterschrift des Schützen

Meyton Elektronik

Ergebnis: **396** (411.0)
 Serien: 100 98 99 99
 Zähler: 36 4 0 0 0 0 0 0 0 0
 Innenzehner: 29
 weiteste: 413 (30), 369 (37), 325 (17)
 beste Teiler 32.7 (18.) 76.5 (23.) 76.6 (2.)
 Trefferlage 0.02 mm rechts, 0.14 mm hoch
 Streuwert 1.33, horizontal: 1.37, vertikal: 1.30

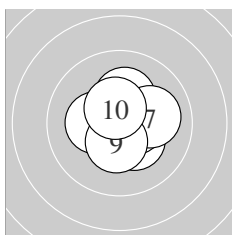
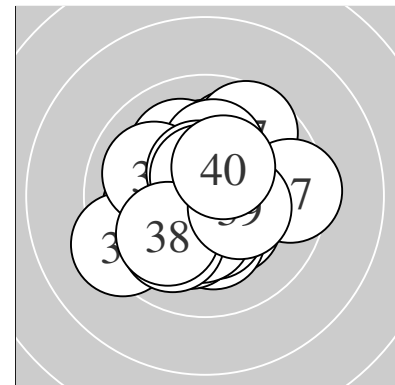

Serie 1:
 10.6 * 10.6 * 10.4 * 10.3 * 10.5 *
 10.2 * 10.1 → 10.3 * 10.4 * 10.5 *
 beste Teiler 76.6 (2.) 81.5 (1.) 102.0 (5.)
 Trefferlage 0.46 mm rechts, 0.24 mm hoch
 Streuwert 1.00, horizontal: 1.04, vertikal: 0.95

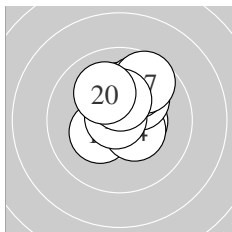

Serie 2:
 10.2 * 10.5 * 10.3 * 10.4 * 10.1 ↗
 9.9 ↗ 9.7 ↗ 10.8 * 10.4 * 10.1 ↘
 beste Teiler 32.7 (18.) 123.1 (12.) 129.2 (14.)
 Trefferlage 0.39 mm rechts, 1.04 mm hoch
 Streuwert 1.20, horizontal: 1.09, vertikal: 1.30

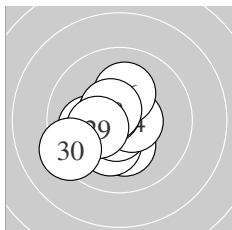

Serie 3:
 10.2 * 10.2 * 10.6 * 10.6 * 10.1 ←
 10.2 * 10.6 * 10.6 * 10.3 * 9.3 ↙
 beste Teiler 76.5 (23.) 90.3 (24.) 92.0 (27.)
 Trefferlage 0.80 mm links, 0.42 mm tief
 Streuwert 1.31, horizontal: 1.34, vertikal: 1.28

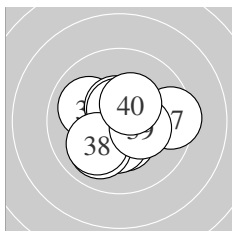

Serie 4:
 10.0 ↖ 10.4 * 10.5 * 10.6 * 10.3 *
 10.0 ↙ 9.5 → 10.0 ↘ 10.3 * 10.4 *
 beste Teiler 85.1 (34.) 106.0 (33.) 141.4 (32.)
 Trefferlage 0.04 mm rechts, 0.26 mm tief
 Streuwert 1.50, horizontal: 1.71, vertikal: 1.26

Unterschrift des Schützen

Meyton Elektronik

Ergebnis: **390** (409.1)
 Serien: 100 94 98 98
 Zähler: 31 8 1 0 0 0 0 0 0 0
 Innenzehner: 27
 weiteste: 597 (16), 377 (27), 328 (35)
 beste Teiler 19.9 (4.) 73.1 (29.) 75.6 (3.)
 Trefferlage 0.26 mm rechts, 0.19 mm tief
 Streuwert 1.49, horizontal: 1.60, vertikal: 1.36

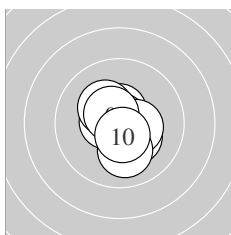
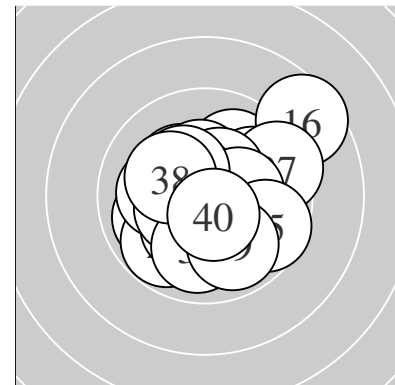

Serie 1:
 10.5 * 10.6 * 10.7 * 10.9 * 10.3 *
 10.3 * 10.4 * 10.1 ↓ 10.5 * 10.6 *
 beste Teiler 19.9 (4.) 75.6 (3.) 96.0 (2.)
 Trefferlage 0.09 mm rechts, 0.16 mm tief
 Streuwert 0.96, horizontal: 0.86, vertikal: 1.05

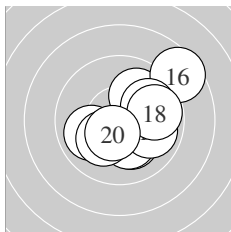

Serie 2:
 10.2 * 10.0 ↗ 10.2 * 9.9 ↘ 9.9 ↖
 8.6 ↗ 9.9 ↗ 9.8 → 10.2 * 10.5 *
 beste Teiler 120.8 (20.) 187.7 (13.) 198.3 (19.)
 Trefferlage 1.11 mm rechts, 0.05 mm tief
 Streuwert 1.97, horizontal: 2.10, vertikal: 1.83

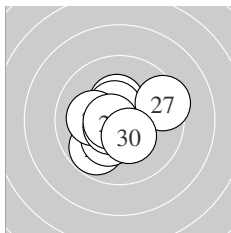

Serie 3:
 10.4 * 10.5 * 10.6 * 9.8 ↙ 10.3 *
 10.1 ← 9.4 → 10.6 * 10.7 * 10.4 *
 beste Teiler 73.1 (29.) 90.6 (28.) 99.2 (23.)
 Trefferlage 0.35 mm links, 0.21 mm tief
 Streuwert 1.42, horizontal: 1.58, vertikal: 1.24

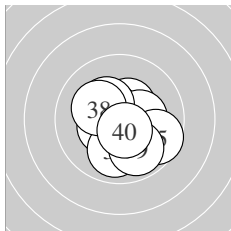

Serie 4:
 10.4 * 10.5 * 10.4 * 10.3 * 9.6 ↘
 10.3 * 10.0 ↓ 10.2 * 9.9 ↓ 10.6 *
 beste Teiler 100.7 (40.) 111.1 (32.) 128.1 (31.)
 Trefferlage 0.19 mm rechts, 0.37 mm tief
 Streuwert 1.44, horizontal: 1.47, vertikal: 1.40

Unterschrift des Schützen

Ergebnis: **377** (399.0)
 Serien: 96 97 92 92
 Zähler: 21 15 4 0 0 0 0 0 0 0
 Innenzehner: 17
 weiteste: 518 (37), 508 (39), 506 (27)
 beste Teiler 15.6 (35.) 60.4 (30.) 67.1 (17.)
 Trefferlage 0.49 mm rechts, 0.36 mm hoch
 Streuwert 1.96, horizontal: 2.16, vertikal: 1.73

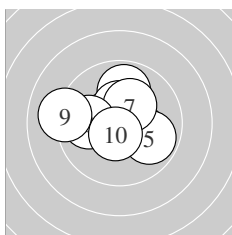
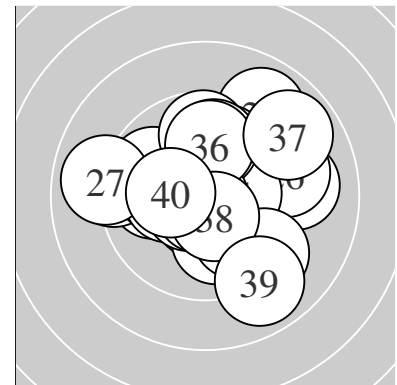

Serie 1:
 10.3 * 10.4 * 9.9 ↑ 10.4 * 9.9 ↘
 10.4 * 10.3 * 9.9 ← 9.1 ← 10.6 *
 beste Teiler 96.5 (10.) 130.8 (2.) 131.1 (6.)
 Trefferlage 0.33 mm links, 0.52 mm hoch
 Streuwert 1.68, horizontal: 2.04, vertikal: 1.20

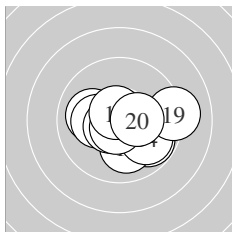

Serie 2:
 9.8 ↘ 10.0 ↓ 10.0 ← 9.9 ↘ 10.2 *
 10.6 * 10.7 * 10.7 * 9.1 → 10.4 *
 beste Teiler 67.1 (17.) 70.2 (18.) 96.2 (16.)
 Trefferlage 0.56 mm rechts, 0.49 mm tief
 Streuwert 1.64, horizontal: 2.10, vertikal: 0.99

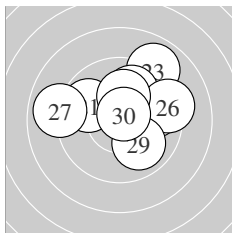

Serie 3:
 9.8 ↖ 9.8 → 8.9 ↗ 10.4 * 9.9 ↗
 9.3 → 8.9 ← 10.1 ↑ 10.0 ↘ 10.7 *
 beste Teiler 60.4 (30.) 146.0 (24.) 202.7 (28.)
 Trefferlage 0.68 mm rechts, 1.10 mm hoch
 Streuwert 2.22, horizontal: 2.70, vertikal: 1.60

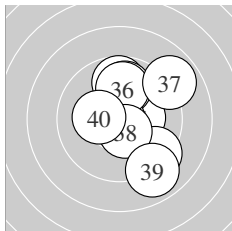

Serie 4:
 10.3 * 9.7 ↑ 9.9 ↑ 9.3 ↘ 10.9 *
 9.9 ↑ 8.9 ↗ 10.5 * 8.9 ↘ 10.3 *
 beste Teiler 15.6 (35.) 113.2 (38.) 160.4 (31.)
 Trefferlage 1.07 mm rechts, 0.32 mm hoch
 Streuwert 2.20, horizontal: 1.77, vertikal: 2.55

Unterschrift des Schützen

Meyton Elektronik

Ergebnis: **390** (407.2)
 Serien: 99 95 97 99
 Zähler: 30 10 0 0 0 0 0 0 0 0
 Innenzehner: 24
 weiteste: 463 (36), 430 (14), 429 (22)
 beste Teiler 11.7 (33.) 24.2 (26.) 35.3 (19.)
 Trefferlage 0.13 mm rechts, 0.22 mm hoch
 Streuwert 1.60, horizontal: 1.81, vertikal: 1.36

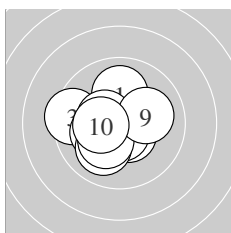
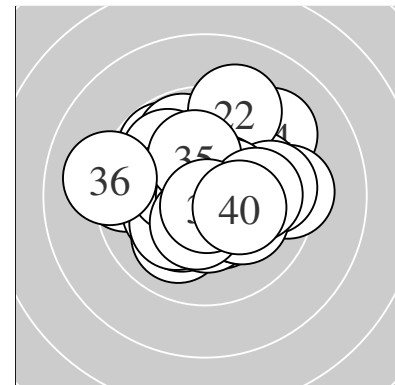

Serie 1:
 10.0 ↑ 10.5 * 9.4 ← 10.2 * 10.6 *
 10.0 ↙ 10.5 * 10.2 * 10.1 → 10.4 *
 beste Teiler 81.2 (5.) 113.2 (2.) 125.5 (7.)
 Trefferlage 0.76 mm links, 0.19 mm tief
 Streuwert 1.42, horizontal: 1.59, vertikal: 1.23

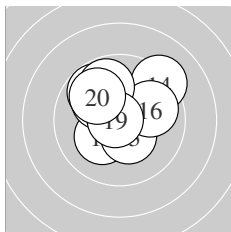

Serie 2:
 10.6 * 10.2 * 10.4 * 9.2 ↗ 9.8 ↖
 9.9 → 10.1 ↘ 9.8 ↘ 10.8 * 9.9 ↖
 beste Teiler 35.3 (19.) 100.6 (11.) 143.7 (13.)
 Trefferlage 0.09 mm links, 0.92 mm hoch
 Streuwert 1.70, horizontal: 1.82, vertikal: 1.58

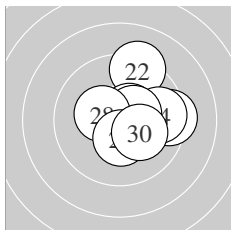

Serie 3:
 9.4 → 9.2 ↑ 10.5 * 9.7 → 10.5 *
 10.9 * 10.5 * 10.4 * 10.4 * 10.2 *
 beste Teiler 24.2 (26.) 104.1 (23.) 114.7 (25.)
 Trefferlage 1.19 mm rechts, 0.34 mm hoch
 Streuwert 1.50, horizontal: 1.52, vertikal: 1.48

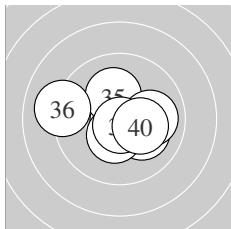

Serie 4:
 10.6 * 10.1 ↘ 10.9 * 10.5 * 10.2 *
 9.1 ← 10.0 → 10.4 * 10.8 * 10.3 *
 beste Teiler 11.7 (33.) 49.8 (39.) 98.7 (31.)
 Trefferlage 0.19 mm rechts, 0.15 mm tief
 Streuwert 1.53, horizontal: 1.94, vertikal: 0.94

Unterschrift des Schützen

Ergebnis: **376** (393.9)
 Serien: 94 95 92 95
 Zähler: 19 18 3 0 0 0 0 0 0
 Innenzehner: 14
 weiteste: 676 (8), 507 (27), 504 (20)
 beste Teiler 11.7 (24.) 36.1 (7.) 42.3 (19.)
 Trefferlage 0.31 mm links, 0.46 mm hoch
 Streuwert 2.22, horizontal: 2.40, vertikal: 2.02

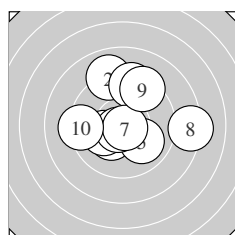
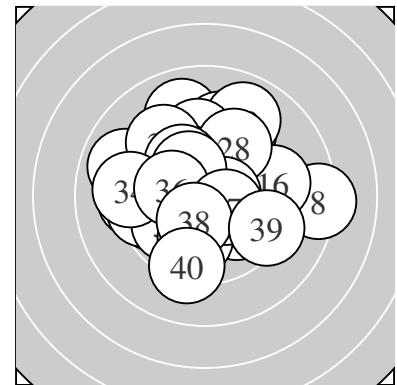

Serie 1:
 10.3 * 9.0 ↗ 10.2 * 9.3 ↑ 10.0 ↘
 10.7 * 10.8 * 8.2 → 9.3 ↗ 9.3 ←
 beste Teiler 36.1 (7.) 65.7 (6.) 166.4 (1.)
 Trefferlage 0.27 mm rechts, 0.74 mm hoch
 Streuwert 2.67, horizontal: 2.93, vertikal: 2.37

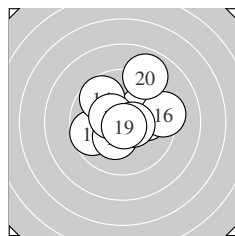

Serie 2:
 10.0 → 10.0 ↗ 9.7 ← 9.7 ↘ 10.3 *
 9.3 → 10.5 * 10.6 * 10.8 * 8.9 ↗
 beste Teiler 42.3 (19.) 100.4 (18.) 125.2 (17.)
 Trefferlage 0.48 mm rechts, 0.67 mm hoch
 Streuwert 2.00, horizontal: 2.22, vertikal: 1.76

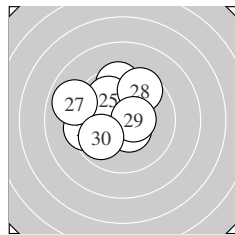

Serie 3:
 9.9 ← 9.5 ← 9.5 ↑ 10.9 * 9.9 ↘
 10.5 * 8.9 ← 9.6 ↗ 10.5 * 9.9 ↙
 beste Teiler 11.7 (24.) 108.2 (29.) 112.8 (26.)
 Trefferlage 1.15 mm links, 0.75 mm hoch
 Streuwert 1.94, horizontal: 2.12, vertikal: 1.75

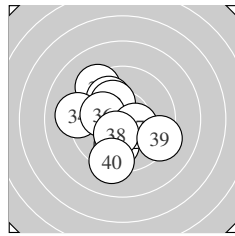

Serie 4:
 9.3 ↘ 10.0 ↘ 10.2 * 9.2 ← 9.9 ↓
 10.1 ← 10.4 * 10.3 * 9.3 ↘ 9.2 ↓
 beste Teiler 140.9 (37.) 159.4 (38.) 187.6 (33.)
 Trefferlage 0.86 mm links, 0.31 mm tief
 Streuwert 2.21, horizontal: 2.17, vertikal: 2.26

Unterschrift des Schützen

Meyton Elektronik

Ergebnis: **381** (398.2)
 Serien: 96 94 95 96
 Zähler: 21 19 0 0 0 0 0 0 0 0
 Innenzehner: 19
 weiteste: 470 (19), 458 (27), 450 (18)
 beste Teiler 21.2 (8.) 32.2 (26.) 35.0 (28.)
 Trefferlage 0.43 mm links, 0.15 mm tief
 Streuwert 2.02, horizontal: 2.14, vertikal: 1.88

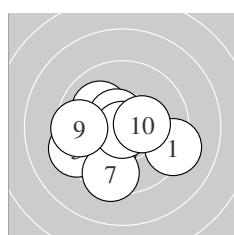
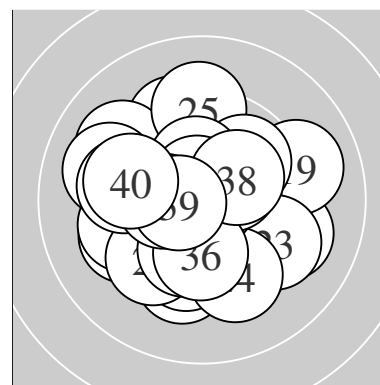

Serie 1:
 9.2 ↘ 10.2 * 10.1 ↖ 10.2 * 9.4 ←
 10.6 * 9.5 ↓ 10.9 * 9.6 ← 10.3 *
 beste Teiler 21.2 (8.) 90.7 (6.) 153.7 (10.)
 Trefferlage 0.76 mm links, 0.71 mm tief
 Streuwert 1.90, horizontal: 2.25, vertikal: 1.46

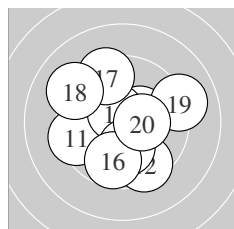

Serie 2:
 9.4 ← 9.5 ↘ 10.4 * 10.6 * 10.2 *
 9.7 ↓ 9.4 ↗ 9.2 ↖ 9.1 → 10.3 *
 beste Teiler 94.6 (14.) 148.6 (13.) 153.0 (20.)
 Trefferlage 0.06 mm links, 0.04 mm tief
 Streuwert 2.41, horizontal: 2.52, vertikal: 2.29

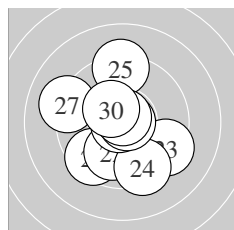

Serie 3:
 9.5 ↗ 10.0 ↓ 9.4 ↘ 9.4 ↓ 9.2 ↑
 10.8 * 9.1 ← 10.8 * 10.8 * 10.4 *
 beste Teiler 32.2 (26.) 35.0 (28.) 38.1 (29.)
 Trefferlage 0.34 mm links, 0.36 mm tief
 Streuwert 2.22, horizontal: 2.08, vertikal: 2.35

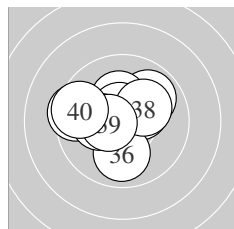

Serie 4:
 9.9 ↗ 10.3 * 10.3 * 9.5 ← 10.6 *
 9.9 ↓ 10.2 * 10.2 * 10.5 * 9.6 ←
 beste Teiler 83.5 (35.) 110.8 (39.) 155.3 (32.)
 Trefferlage 0.56 mm links, 0.49 mm hoch
 Streuwert 1.64, horizontal: 1.97, vertikal: 1.23

Unterschrift des Schützen

Meyton Elektronik