

Ergebnis: **381** (396.9)
 Serien: 95 94 97 95
 Zähler: 22 17 1 0 0 0 0 0 0 0
 Innenzehner: 12
 weiteste: 549 (15), 480 (38), 449 (20)
 beste Teiler 12.7 (35.) 64.6 (39.) 72.2 (29.)
 Trefferlage 0.00 mm , 0.43 mm tief
 Streuwert 2.00, horizontal: 2.19, vertikal: 1.78

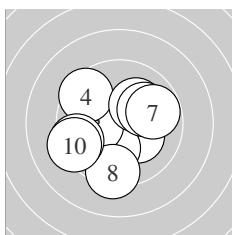

Serie 1:
 10.2 * 10.1 ↓ 10.2 * 9.5 ↘ 10.1 ↗
 10.0 ↗ 9.8 → 9.3 ↓ 9.4 ← 9.3 ←
 beste Teiler 181.2 (1.) 191.8 (3.) 202.5 (5.)
 Trefferlage 0.54 mm links, 0.46 mm tief
 Streuwert 2.18, horizontal: 2.39, vertikal: 1.96

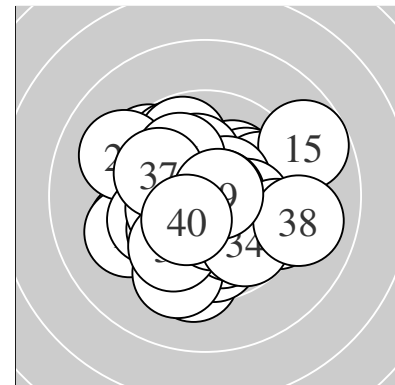
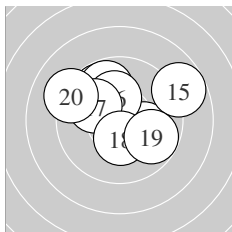

Serie 2:
 9.8 ↖ 10.4 * 10.1 → 9.8 ↖ 8.8 ↗
 10.2 * 10.0 ↖ 10.4 * 9.8 → 9.2 ↖
 beste Teiler 146.9 (12.) 150.2 (18.) 188.9 (16.)
 Trefferlage 0.15 mm rechts, 0.82 mm hoch
 Streuwert 2.20, horizontal: 2.59, vertikal: 1.73

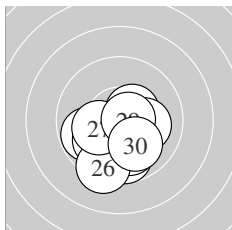

Serie 3:
 10.4 * 9.8 ← 9.7 ↓ 10.0 ↓ 10.0 ↘
 9.3 ↓ 10.2 * 10.1 → 10.7 * 10.0 ↓
 beste Teiler 72.2 (29.) 126.4 (21.) 182.2 (27.)
 Trefferlage 0.10 mm links, 1.42 mm tief
 Streuwert 1.50, horizontal: 1.58, vertikal: 1.42

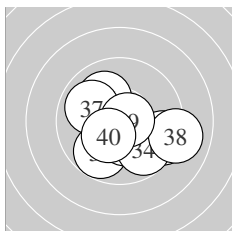

Serie 4:
 9.8 ↙ 10.3 * 9.4 → 9.8 ↘ 10.9 *
 10.1 ↘ 9.9 ↖ 9.0 → 10.7 * 10.4 *
 beste Teiler 12.7 (35.) 64.6 (39.) 150.4 (40.)
 Trefferlage 0.51 mm rechts, 0.68 mm tief
 Streuwert 1.89, horizontal: 2.26, vertikal: 1.43

Unterschrift des Schützen

Ergebnis: **381** (396.7)
 Serien: 95 95 96 95
 Zähler: 22 17 1 0 0 0 0 0 0 0
 Innenzehner: 13
 weiteste: 527 (34), 478 (29), 470 (14)
 beste Teiler 52.4 (17.) 71.3 (25.) 102.1 (31.)
 Trefferlage 0.39 mm links, 0.88 mm hoch
 Streuwert 1.91, horizontal: 1.92, vertikal: 1.89

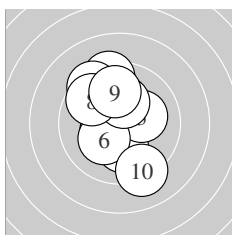
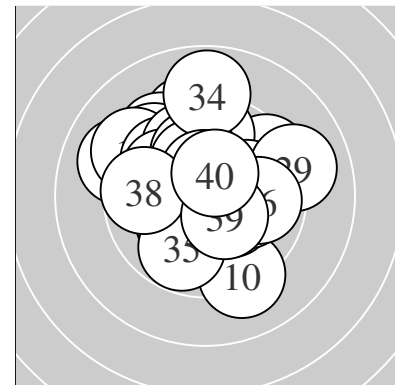

Serie 1:
 10.4 * 10.1 ↓ 10.2 * 9.3 ↑ 9.4 ↘
 10.2 * 10.2 * 9.7 ↘ 9.9 ↑ 9.2 ↓
 beste Teiler 130.5 (1.) 183.3 (7.) 188.7 (6.)
 Trefferlage 0.41 mm links, 0.61 mm hoch
 Streuwert 2.11, horizontal: 1.52, vertikal: 2.56

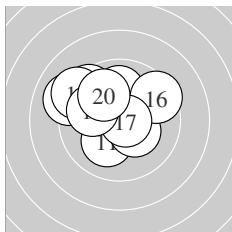

Serie 2:
 10.1 ↙ 10.0 ↑ 9.5 ↘ 9.1 ↖ 10.3 *
 9.5 ↗ 10.7 * 9.2 ↘ 10.0 ↖ 9.9 ↘
 beste Teiler 52.4 (17.) 160.6 (15.) 206.8 (11.)
 Trefferlage 1.04 mm links, 1.13 mm hoch
 Streuwert 1.97, horizontal: 2.32, vertikal: 1.55

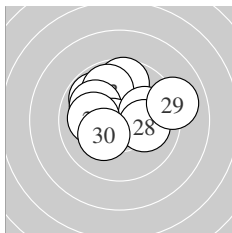

Serie 3:
 9.7 ↑ 9.8 ↘ 9.9 ↗ 10.0 ↖ 10.7 *
 10.1 → 10.1 ← 10.1 → 9.0 → 10.2 *
 beste Teiler 71.3 (25.) 183.3 (30.) 218.3 (28.)
 Trefferlage 0.03 mm links, 0.89 mm hoch
 Streuwert 1.90, horizontal: 2.29, vertikal: 1.41

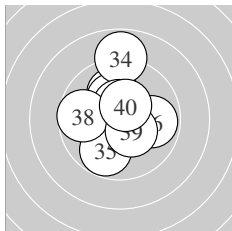

Serie 4:
 10.5 * 10.0 ↑ 10.2 * 8.8 ↑ 9.8 ↙
 9.9 → 10.5 * 9.7 ← 10.4 * 10.4 *
 beste Teiler 102.1 (31.) 116.2 (37.) 128.5 (40.)
 Trefferlage 0.08 mm links, 0.88 mm hoch
 Streuwert 1.83, horizontal: 1.53, vertikal: 2.10

Unterschrift des Schützen

Meyton Elektronik

Ergebnis: **366** (385.6)
 Serien: 91 90 92 93
 Zähler: 16 17 4 3 0 0 0 0 0 0
 Innenzehner: 15
 weiteste: 868 (5), 799 (11), 760 (4)
 beste Teiler 19.4 (40.) 68.1 (37.) 95.5 (7.)
 Trefferlage 1.01 mm links, 0.13 mm tief
 Streuwert 2.68, horizontal: 3.24, vertikal: 1.97

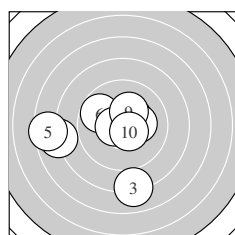
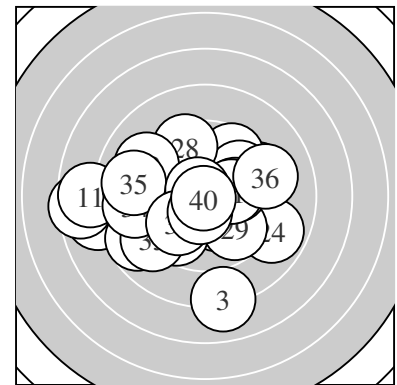

Serie 1:
 10.4 * 10.4 * 8.0 ↓ 7.9 ← 7.5 ←
 9.8 ↖ 10.6 * 10.2 * 10.3 * 10.5 *
 beste Teiler 95.5 (7.) 103.9 (10.) 142.2 (2.)
 Trefferlage 1.27 mm links, 0.56 mm tief
 Streuwert 3.24, horizontal: 3.81, vertikal: 2.53

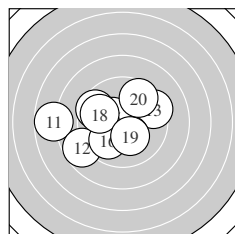

Serie 2:
 7.8 ← 8.7 ↖ 9.4 → 10.3 * 10.4 *
 9.9 ↖ 9.5 ↖ 9.8 ↖ 10.2 * 9.6 ↗
 beste Teiler 131.1 (15.) 167.2 (14.) 183.8 (19.)
 Trefferlage 1.43 mm links, 0.06 mm tief
 Streuwert 2.75, horizontal: 3.41, vertikal: 1.87

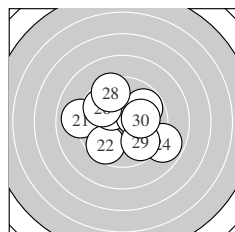

Serie 3:
 9.0 ← 9.6 ↖ 10.2 * 8.9 ↘ 10.3 *
 9.8 ↖ 9.8 ↗ 9.5 ↖ 9.7 ↘ 10.1 →
 beste Teiler 162.0 (25.) 184.5 (23.) 213.9 (30.)
 Trefferlage 0.07 mm rechts, 0.23 mm hoch
 Streuwert 2.49, horizontal: 2.88, vertikal: 2.02

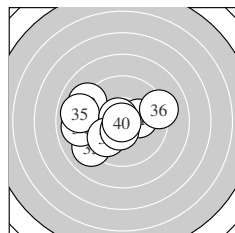

Serie 4:
 10.2 * 9.1 ↖ 9.1 ↖ 9.0 ← 8.9 ←
 9.2 → 10.7 * 9.9 ↖ 10.5 * 10.9 *
 beste Teiler 19.4 (40.) 68.1 (37.) 116.6 (39.)
 Trefferlage 1.43 mm links, 0.16 mm tief
 Streuwert 2.41, horizontal: 3.03, vertikal: 1.55

Unterschrift des Schützen

Meyton Elektronik

Ergebnis: **373** (394.6)
 Serien: 92 94 95 92
 Zähler: 17 19 4 0 0 0 0 0 0 0
 Innenzehner: 14
 weiteste: 601 (33), 595 (26), 542 (1)
 beste Teiler 14.3 (28.) 68.2 (25.) 84.4 (27.)
 Trefferlage 0.35 mm rechts, 0.17 mm tief
 Streuwert 2.20, horizontal: 2.60, vertikal: 1.72

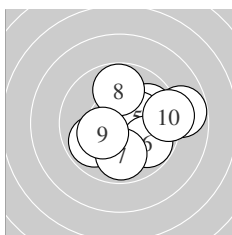
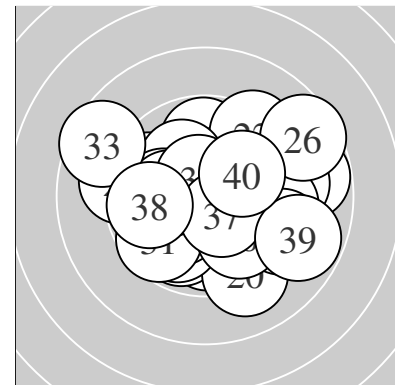

Serie 1:
 8.8 → 9.9 ↗ 10.6 * 9.9 ↙ 10.3 *
 9.8 ↘ 9.9 ↓ 9.8 ↑ 10.3 * 9.2 →
 beste Teiler 86.8 (3.) 165.0 (5.) 170.3 (9.)
 Trefferlage 1.27 mm rechts, 0.12 mm tief
 Streuwert 2.06, horizontal: 2.39, vertikal: 1.66

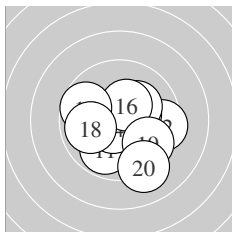

Serie 2:
 9.9 ↙ 9.5 → 10.4 * 10.6 * 10.2 *
 10.4 * 9.7 ↖ 9.9 ← 9.7 ↘ 9.1 ↘
 beste Teiler 85.7 (14.) 143.6 (16.) 149.0 (13.)
 Trefferlage 0.44 mm rechts, 0.61 mm tief
 Streuwert 1.99, horizontal: 2.20, vertikal: 1.77

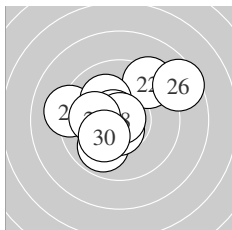

Serie 3:
 9.9 ↙ 9.3 ↗ 9.2 ← 10.1 ↘ 10.7 *
 8.6 ↗ 10.6 * 10.9 * 10.1 ← 10.2 *
 beste Teiler 14.3 (28.) 68.2 (25.) 84.4 (27.)
 Trefferlage 0.35 mm links, 0.51 mm hoch
 Streuwert 2.23, horizontal: 2.59, vertikal: 1.79

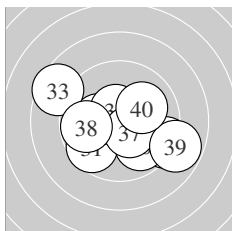

Serie 4:
 9.6 ↙ 10.2 * 8.5 ↘ 9.2 ↘ 10.6 *
 9.9 ↘ 10.4 * 9.8 ← 8.8 ↘ 10.1 →
 beste Teiler 99.9 (35.) 128.0 (37.) 183.5 (32.)
 Trefferlage 0.06 mm rechts, 0.48 mm tief
 Streuwert 2.58, horizontal: 3.22, vertikal: 1.70

Unterschrift des Schützen

Ergebnis: **396** (414.8)
 Serien: 99 97 100 100
 Zähler: 36 4 0 0 0 0 0 0 0 0
 Innenzehner: 32
 weiteste: 295 (19), 274 (13), 272 (16)
 beste Teiler 55.1 (37.) 56.7 (9.) 65.8 (35.)
 Trefferlage 0.43 mm links, 0.47 mm hoch
 Streuwert 1.04, horizontal: 0.81, vertikal: 1.23

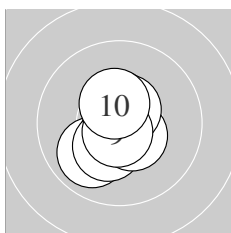
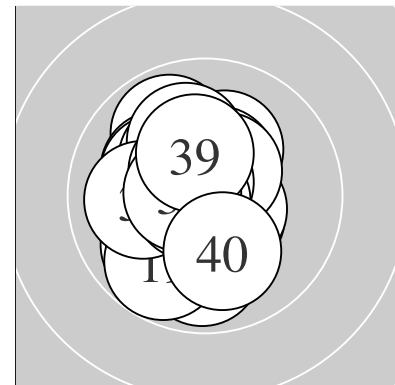

Serie 1:
 9.9 ↙ 10.6 * 10.3 * 10.6 * 10.6 *
 10.5 * 10.5 * 10.6 * 10.7 * 10.4 *
 beste Teiler 56.7 (9.) 86.5 (2.) 88.8 (5.)
 Trefferlage 0.19 mm links, 0.04 mm tief
 Streuwert 0.96, horizontal: 0.70, vertikal: 1.16



Serie 2:
 10.6 * 10.5 * 9.9 ↘ 10.4 * 10.4 *
 9.9 ↓ 10.6 * 10.1 ↖ 9.8 ↙ 10.2 *
 beste Teiler 78.6 (11.) 87.6 (17.) 112.8 (12.)
 Trefferlage 0.95 mm links, 0.33 mm hoch
 Streuwert 1.23, horizontal: 0.60, vertikal: 1.63

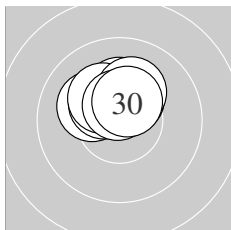

Serie 3:
 10.4 * 10.5 * 10.3 * 10.2 * 10.4 *
 10.4 * 10.3 * 10.2 * 10.6 * 10.4 *
 beste Teiler 96.8 (29.) 123.3 (22.) 127.3 (30.)
 Trefferlage 0.22 mm links, 1.27 mm hoch
 Streuwert 0.62, horizontal: 0.83, vertikal: 0.30

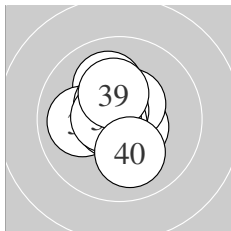

Serie 4:
 10.1 ↗ 10.0 ← 10.5 * 10.5 * 10.7 *
 10.5 * 10.7 * 10.6 * 10.3 * 10.1 ↓
 beste Teiler 55.1 (37.) 65.8 (35.) 87.8 (38.)
 Trefferlage 0.37 mm links, 0.32 mm hoch
 Streuwert 1.08, horizontal: 0.96, vertikal: 1.19

Unterschrift des Schützen

Ergebnis:	395	(412.5)							
Serien:	98	99	99	99					
Zähler:	35	5	0	0	0	0	0	0	0
Innenzehner:	30								
weiteste:	419 (8), 299 (2), 288 (38)								
beste Teiler	37.6 (21.)	45.8 (11.)	54.5 (27.)						
Trefferlage	0.13 mm rechts, 0.06 mm hoch								
Streuwert	1.27, horizontal: 1.21, vertikal: 1.32								

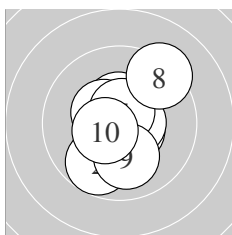
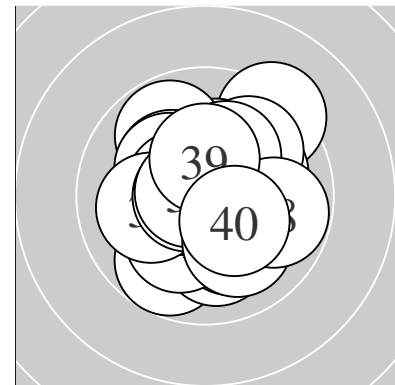

Serie 1:	10.5 *	9.8 ↘	10.7 *	10.6 *	10.6 *
	10.4 *	10.6 *	9.3 ↗	10.0 ↓	10.5 *
beste Teiler	63.2 (3.) 80.4 (7.) 92.0 (5.)				
Trefferlage	0.18 mm rechts, 0.06 mm hoch				
Streuwert	1.47, horizontal: 1.20, vertikal: 1.69				

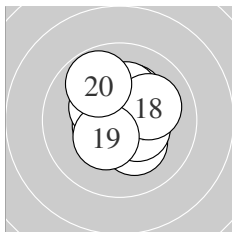

Serie 2:	10.8 *	10.5 *	10.2 *	10.3 *	10.2 *
	10.4 *	10.4 *	10.1 ↗	10.4 *	9.8 ↘
beste Teiler	45.8 (11.) 104.1 (12.) 132.4 (17.)				
Trefferlage	0.13 mm rechts, 0.38 mm hoch				
Streuwert	1.25, horizontal: 1.18, vertikal: 1.32				

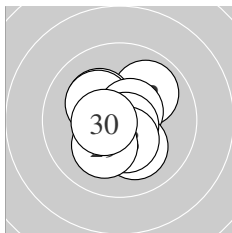

Serie 3:	10.8 *	9.9 ↗	10.2 *	10.2 *	10.6 *
	10.1 ↘	10.7 *	10.4 *	10.2 *	10.5 *
beste Teiler	37.6 (21.) 54.5 (27.) 92.4 (25.)				
Trefferlage	0.08 mm links, 0.06 mm tief				
Streuwert	1.20, horizontal: 1.12, vertikal: 1.27				

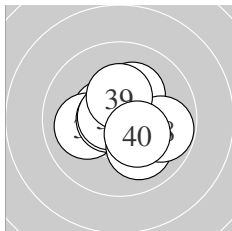

Serie 4:	10.5 *	10.2 *	10.2 *	10.1 ←	10.7 *
	10.7 *	10.0 ↘	9.8 →	10.3 *	10.3 *
beste Teiler	63.7 (36.) 71.0 (35.) 107.0 (31.)				
Trefferlage	0.31 mm rechts, 0.12 mm tief				
Streuwert	1.31, horizontal: 1.48, vertikal: 1.11				

Unterschrift des Schützen

Meyton Elektronik

Ergebnis: **387** (404.1)
 Serien: 95 97 98 97
 Zähler: 27 13 0 0 0 0 0 0 0 0
 Innenzehner: 23
 weiteste: 467 (19), 440 (31), 428 (23)
 beste Teiler 20.6 (26.) 45.0 (15.) 49.7 (36.)
 Trefferlage 0.91 mm links, 0.00 mm
 Streuwert 1.62, horizontal: 1.79, vertikal: 1.43

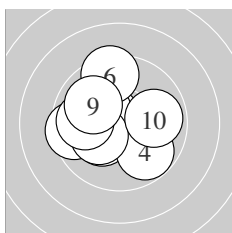
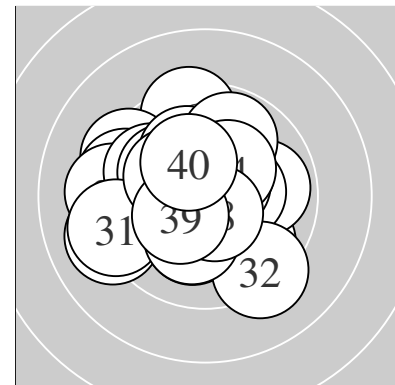

Serie 1:
 9.5 ← 10.6 * 10.3 * 9.8 ↘ 10.4 *
 9.4 ↑ 10.2 * 9.9 ← 10.0 ↖ 9.9 →
 beste Teiler 86.2 (2.) 150.0 (5.) 172.8 (3.)
 Trefferlage 0.92 mm links, 0.23 mm hoch
 Streuwert 1.77, horizontal: 1.91, vertikal: 1.62

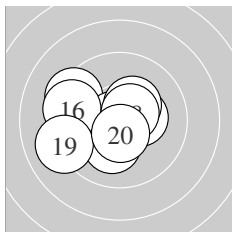

Serie 2:
 10.4 * 10.3 * 9.4 ↖ 10.2 * 10.8 *
 9.4 ← 10.3 * 10.6 * 9.1 ← 10.5 *
 beste Teiler 45.0 (15.) 99.0 (18.) 103.2 (20.)
 Trefferlage 1.02 mm links, 0.12 mm tief
 Streuwert 1.74, horizontal: 2.10, vertikal: 1.28

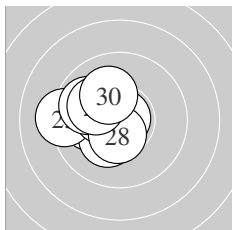

Serie 3:
 10.0 ← 10.3 * 9.2 ← 10.4 * 10.7 *
 10.9 * 9.9 ↖ 10.5 * 10.1 ↖ 10.1 ↖
 beste Teiler 20.6 (26.) 51.7 (25.) 112.2 (28.)
 Trefferlage 1.40 mm links, 0.17 mm hoch
 Streuwert 1.21, horizontal: 1.36, vertikal: 1.03

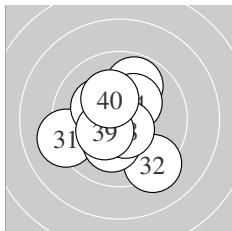

Serie 4:
 9.2 ← 9.2 ↘ 9.8 ↑ 10.3 * 10.2 *
 10.8 * 10.2 * 10.6 * 10.4 * 10.3 *
 beste Teiler 49.7 (36.) 90.9 (38.) 146.6 (39.)
 Trefferlage 0.31 mm links, 0.26 mm tief
 Streuwert 1.83, horizontal: 1.83, vertikal: 1.83

Unterschrift des Schützen

Meyton Elektronik

Ergebnis: **396** (414.1)
 Serien: 98 100 99 99
 Zähler: 36 4 0 0 0 0 0 0 0 0
 Innenzehner: 32
 weiteste: 318 (5), 287 (39), 272 (2)
 beste Teiler 61.7 (35.) 65.2 (8.) 66.1 (20.)
 Trefferlage 0.47 mm links, 0.02 mm tief
 Streuwert 1.13, horizontal: 1.31, vertikal: 0.92

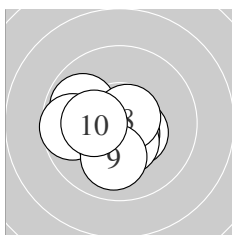
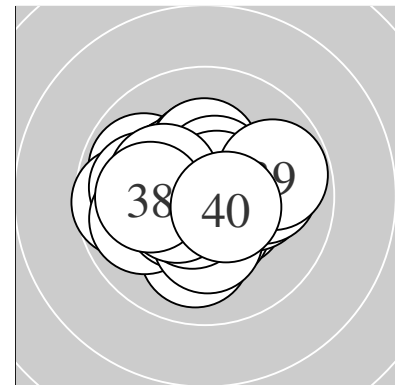

Serie 1:
 10.5 * 9.9 ← 10.5 * 10.6 * 9.7 ←
 10.3 * 10.4 * 10.7 * 10.0 ↓ 10.3 *
 beste Teiler 65.2 (8.) 85.1 (4.) 103.6 (3.)
 Trefferlage 0.62 mm links, 0.60 mm tief
 Streuwert 1.21, horizontal: 1.41, vertikal: 0.97

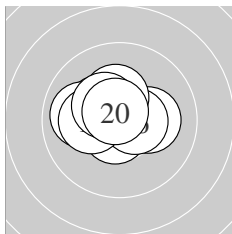

Serie 2:
 10.2 * 10.3 * 10.3 * 10.6 * 10.0 ←
 10.5 * 10.2 * 10.3 * 10.4 * 10.7 *
 beste Teiler 66.1 (20.) 78.0 (14.) 103.2 (16.)
 Trefferlage 0.61 mm links, 0.34 mm hoch
 Streuwert 1.05, horizontal: 1.33, vertikal: 0.65

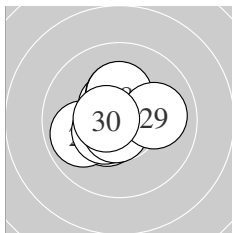

Serie 3:
 10.5 * 10.5 * 9.9 ← 10.5 * 10.3 *
 10.7 * 10.7 * 10.3 * 10.0 → 10.6 *
 beste Teiler 69.4 (26.) 74.2 (27.) 90.4 (30.)
 Trefferlage 0.41 mm links, 0.22 mm hoch
 Streuwert 1.11, horizontal: 1.19, vertikal: 1.02

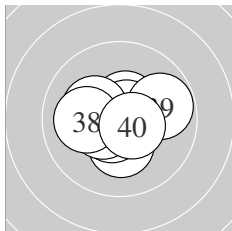

Serie 4:
 10.3 * 10.4 * 10.5 * 10.6 * 10.7 *
 10.5 * 10.2 * 10.1 ← 9.8 → 10.6 *
 beste Teiler 61.7 (35.) 88.0 (34.) 96.1 (40.)
 Trefferlage 0.23 mm links, 0.07 mm tief
 Streuwert 1.19, horizontal: 1.46, vertikal: 0.83

Unterschrift des Schützen

Meyton Elektronik

Ergebnis: **392** (408.8)
 Serien: 98 98 99 97
 Zähler: 32 8 0 0 0 0 0 0 0 0
 Innenzehner: 25
 weiteste: 492 (4), 335 (24), 333 (9)
 beste Teiler 50.0 (10.) 62.9 (38.) 80.9 (22.)
 Trefferlage 0.16 mm rechts, 0.05 mm tief
 Streuwert 1.44, horizontal: 1.43, vertikal: 1.45

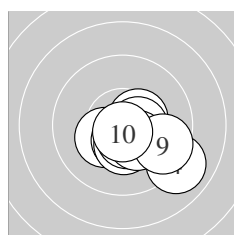
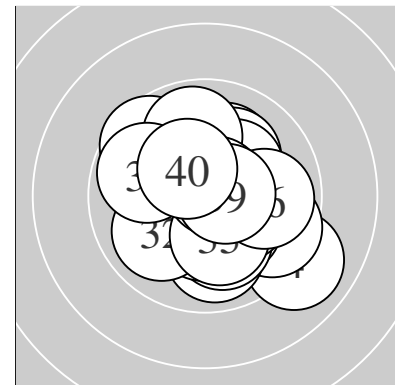

Serie 1:
 10.3 * 10.5 * 10.5 * 9.0 ↘ 10.5 *
 10.4 * 10.5 * 10.3 * 9.6 ↘ 10.8 *
 beste Teiler 50.0 (10.) 105.9 (7.) 113.5 (5.)
 Trefferlage 0.93 mm rechts, 1.01 mm tief
 Streuwert 1.27, horizontal: 1.57, vertikal: 0.89

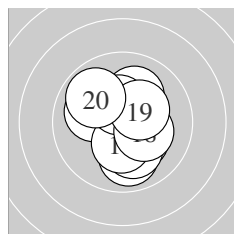

Serie 2:
 10.0 ↖ 9.9 ↓ 10.2 * 10.1 ↓ 10.1 ↗
 10.3 * 10.4 * 10.3 * 10.3 * 9.9 ↘
 beste Teiler 131.7 (17.) 156.2 (19.) 157.2 (16.)
 Trefferlage 0.16 mm rechts, 0.13 mm tief
 Streuwert 1.50, horizontal: 1.32, vertikal: 1.67

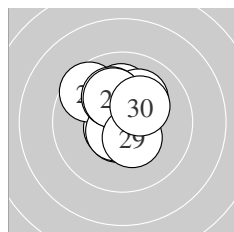

Serie 3:
 10.6 * 10.6 * 10.1 ↑ 9.6 ↘ 10.6 *
 10.1 ↗ 10.1 ↖ 10.2 * 10.4 * 10.2 *
 beste Teiler 80.9 (22.) 84.0 (25.) 85.8 (21.)
 Trefferlage 0.25 mm links, 0.80 mm hoch
 Streuwert 1.25, horizontal: 1.12, vertikal: 1.38

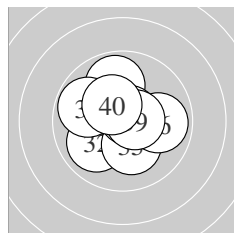

Serie 4:
 10.4 * 10.0 ↙ 9.9 ↑ 10.5 * 10.2 *
 9.9 → 9.8 ↖ 10.7 * 10.6 * 10.4 *
 beste Teiler 62.9 (38.) 92.5 (39.) 113.1 (34.)
 Trefferlage 0.17 mm links, 0.13 mm hoch
 Streuwert 1.46, horizontal: 1.57, vertikal: 1.33

Unterschrift des Schützen

Meyton Elektronik

Ergebnis: **380** (402.5)
 Serien: 96 97 92 95
 Zähler: 25 10 5 0 0 0 0 0 0 0
 Innenzehner: 23
 weiteste: 583 (30), 551 (21), 536 (26)
 beste Teiler 48.1 (33.) 57.9 (11.) 67.7 (36.)
 Trefferlage 0.64 mm rechts, 0.24 mm tief
 Streuwert 1.87, horizontal: 2.22, vertikal: 1.44

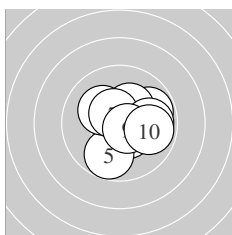
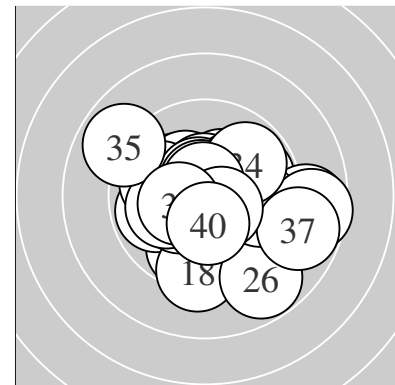

Serie 1:
 10.5 * 10.7 * 9.8 ↗ 10.3 * 9.8 ↓
 10.2 * 10.5 * 9.9 → 10.6 * 9.9 →
 beste Teiler 68.2 (2.) 84.8 (9.) 103.7 (7.)
 Trefferlage 0.78 mm rechts, 0.04 mm tief
 Streuwert 1.40, horizontal: 1.51, vertikal: 1.27

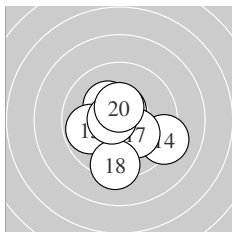

Serie 2:
 10.7 * 10.3 * 10.6 * 9.2 ↘ 9.8 ←
 10.6 * 10.2 * 9.3 ↓ 10.7 * 10.5 *
 beste Teiler 57.9 (11.) 70.4 (19.) 80.5 (13.)
 Trefferlage 0.01 mm rechts, 0.56 mm tief
 Streuwert 1.67, horizontal: 1.74, vertikal: 1.60

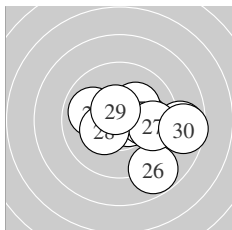

Serie 3:
 8.7 → 10.6 * 9.9 ↖ 10.1 → 10.2 *
 8.8 ↘ 9.7 → 10.3 * 10.5 * 8.6 →
 beste Teiler 80.4 (22.) 101.0 (29.) 163.6 (28.)
 Trefferlage 1.76 mm rechts, 0.44 mm tief
 Streuwert 2.22, horizontal: 2.72, vertikal: 1.58

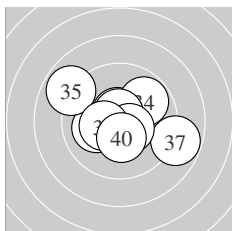

Serie 4:
 10.1 ← 10.6 * 10.8 * 9.8 ↗ 8.9 ↖
 10.7 * 8.8 ↘ 10.5 * 10.4 * 10.4 *
 beste Teiler 48.1 (33.) 67.7 (36.) 82.0 (32.)
 Trefferlage 0.01 mm rechts, 0.05 mm hoch
 Streuwert 2.05, horizontal: 2.52, vertikal: 1.43

Unterschrift des Schützen

Meyton Elektronik

Ergebnis: **377** (394.7)
 Serien: 93 95 95 94
 Zähler: 18 21 1 0 0 0 0 0 0 0
 Innenzehner: 11
 weiteste: 533 (7), 480 (22), 467 (3)
 beste Teiler 8.0 (6.) 88.2 (21.) 105.0 (29.)
 Trefferlage 0.04 mm links, 0.13 mm hoch
 Streuwert 2.10, horizontal: 2.23, vertikal: 1.95

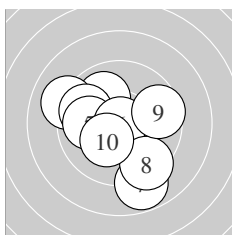
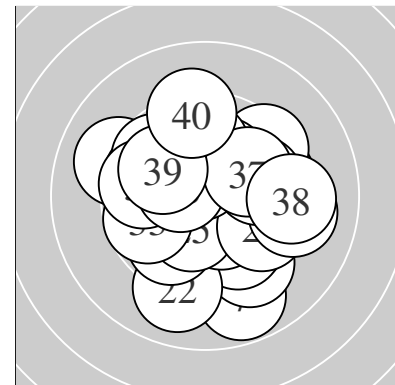

Serie 1:
 10.2 * 10.0 ↖ 9.1 ↖ 9.7 ↖ 9.9 ←
 10.9 * 8.8 ↓ 9.3 ↓ 9.6 → 10.2 *
 beste Teiler 8.0 (6.) 177.6 (10.) 186.5 (1.)
 Trefferlage 0.65 mm links, 0.35 mm tief
 Streuwert 2.37, horizontal: 2.46, vertikal: 2.28

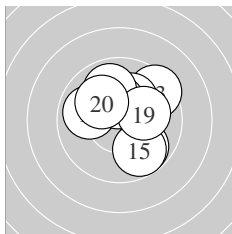

Serie 2:
 10.1 ↖ 9.9 ← 9.4 ↗ 9.8 ↘ 9.8 ↘
 10.2 * 10.3 * 9.9 ↖ 10.1 → 10.1 ↖
 beste Teiler 152.7 (17.) 195.6 (16.) 203.0 (11.)
 Trefferlage 0.30 mm rechts, 0.76 mm hoch
 Streuwert 1.79, horizontal: 1.83, vertikal: 1.75

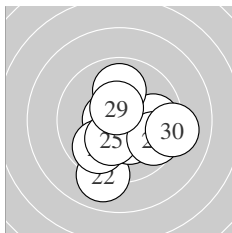

Serie 3:
 10.6 * 9.0 ↓ 10.3 * 9.8 ✓ 10.3 *
 9.8 → 10.0 ↑ 9.7 ↘ 10.5 * 9.2 →
 beste Teiler 88.2 (21.) 105.0 (29.) 167.9 (23.)
 Trefferlage 0.59 mm rechts, 0.86 mm tief
 Streuwert 2.00, horizontal: 2.08, vertikal: 1.93

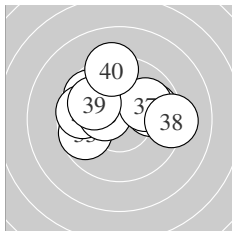

Serie 4:
 9.8 → 9.7 ↖ 9.7 ← 10.4 * 9.7 ←
 10.4 * 10.0 ↗ 9.2 → 10.0 ↖ 9.3 ↑
 beste Teiler 130.2 (36.) 136.4 (34.) 247.5 (37.)
 Trefferlage 0.44 mm links, 0.99 mm hoch
 Streuwert 2.08, horizontal: 2.59, vertikal: 1.39

Unterschrift des Schützen

Meyton Elektronik

Ergebnis: **381** (398.5)
 Serien: 94 98 95 94
 Zähler: 24 13 3 0 0 0 0 0 0 0
 Innenzehner: 18
 weiteste: 514 (8), 513 (32), 509 (22)
 beste Teiler 15.1 (34.) 31.3 (6.) 33.9 (5.)
 Trefferlage 0.67 mm rechts, 0.68 mm hoch
 Streuwert 1.93, horizontal: 1.78, vertikal: 2.08

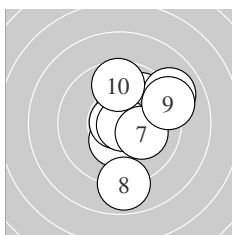
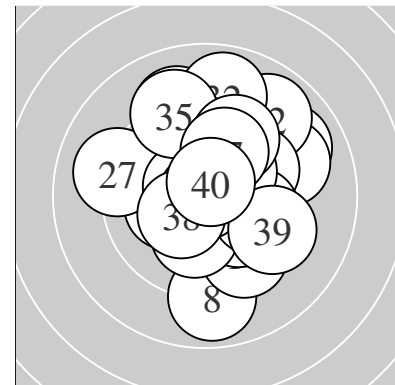

Serie 1:
 10.2 * 9.9 ↗ 9.0 ↗ 10.4 * 10.8 *
 10.8 * 10.1 → 8.9 ↓ 9.2 → 9.7 ↑
 beste Teiler 31.3 (6.) 33.9 (5.) 149.6 (4.)
 Trefferlage 1.21 mm rechts, 0.38 mm hoch
 Streuwert 2.13, horizontal: 1.74, vertikal: 2.46

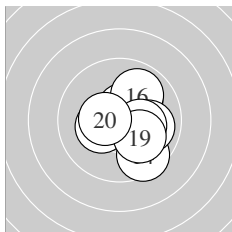

Serie 2:
 10.4 * 10.3 * 10.1 ↗ 9.5 ↘ 10.6 *
 9.9 ↗ 10.0 → 10.2 * 10.1 ↘ 10.5 *
 beste Teiler 94.2 (15.) 124.4 (20.) 150.2 (11.)
 Trefferlage 0.97 mm rechts, 0.15 mm tief
 Streuwert 1.42, horizontal: 1.36, vertikal: 1.47

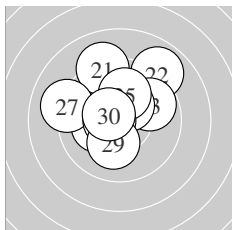

Serie 3:
 9.1 ↖ 8.9 ↗ 9.8 ↗ 10.4 * 10.1 ↑
 10.2 * 9.1 ← 10.6 * 10.2 * 10.5 *
 beste Teiler 87.0 (28.) 104.2 (30.) 145.4 (24.)
 Trefferlage 0.32 mm links, 1.23 mm hoch
 Streuwert 2.07, horizontal: 2.21, vertikal: 1.92

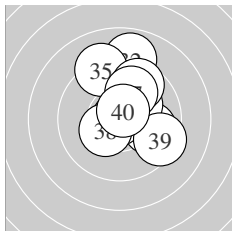

Serie 4:
 9.9 → 8.9 ↑ 10.2 * 10.9 * 9.2 ↖
 9.6 ↗ 10.0 ↑ 10.3 * 9.4 → 10.6 *
 beste Teiler 15.1 (34.) 76.6 (40.) 151.8 (38.)
 Trefferlage 0.82 mm rechts, 1.28 mm hoch
 Streuwert 1.95, horizontal: 1.55, vertikal: 2.27

Unterschrift des Schützen

Meyton Elektronik

LG Liga – Wertung – offene Klasse

StartNr: 1

StandNr: 103

9. Dezember 2017 15:50

Fuchs, Manfred #70804734

Bruckhäusl / Bruckhäusl

Ergebnis: **388** (402.4)
 Serien: 96 97 98 97
 Zähler: 28 12 0 0 0 0 0 0 0 0
 Innenzehner: 21
 weiteste: 450 (8), 439 (38), 426 (1)
 beste Teiler 71.7 (14.) 84.7 (18.) 104.4 (22.)
 Trefferlage 0.23 mm links, 0.48 mm hoch
 Streuwert 1.71, horizontal: 1.81, vertikal: 1.60

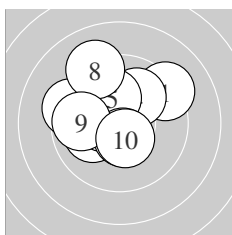
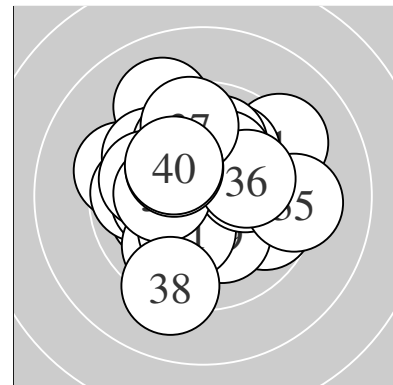

Serie 1:
 9.2 ↗ 10.1 ← 10.5 * 10.0 ↗ 10.1 ↑
 9.4 ← 10.5 * 9.2 ↘ 9.8 ← 10.5 *
 beste Teiler 111.8 (7.) 123.7 (10.) 125.1 (3.)
 Trefferlage 0.68 mm links, 0.88 mm hoch
 Streuwert 1.95, horizontal: 2.14, vertikal: 1.74

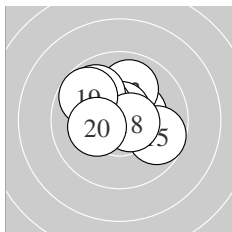

Serie 2:
 10.3 * 10.4 * 10.0 ↑ 10.7 * 9.7 →
 10.3 * 9.9 ↘ 10.6 * 9.8 ↘ 10.2 *
 beste Teiler 71.7 (14.) 84.7 (18.) 144.6 (12.)
 Trefferlage 0.05 mm links, 0.78 mm hoch
 Streuwert 1.44, horizontal: 1.68, vertikal: 1.14

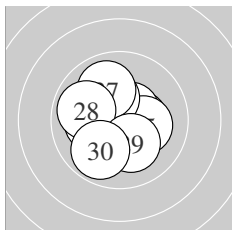

Serie 3:
 10.4 * 10.5 * 10.2 * 10.3 * 10.2 *
 10.2 * 10.0 ↘ 9.9 ← 10.2 * 9.9 ↙
 beste Teiler 104.4 (22.) 143.0 (21.) 158.6 (24.)
 Trefferlage 0.37 mm links, 0.04 mm tief
 Streuwert 1.48, horizontal: 1.50, vertikal: 1.46

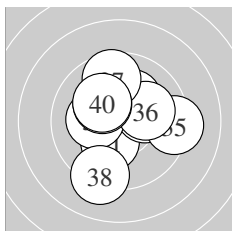

Serie 4:
 10.3 * 10.1 → 10.2 * 10.2 * 9.3 →
 10.1 → 9.6 ↑ 9.2 ↓ 10.2 * 10.2 *
 beste Teiler 174.4 (31.) 184.5 (39.) 187.3 (34.)
 Trefferlage 0.16 mm rechts, 0.30 mm hoch
 Streuwert 2.01, horizontal: 2.00, vertikal: 2.01

Unterschrift des Schützen

Meyton Elektronik

Ergebnis: **383** (399.9)
 Serien: 98 94 94 97
 Zähler: 24 15 1 0 0 0 0 0 0 0
 Innenzehner: 18
 weiteste: 663 (15), 424 (11), 406 (28)
 beste Teiler 56.2 (30.) 72.0 (31.) 80.6 (32.)
 Trefferlage 1.01 mm links, 0.76 mm hoch
 Streuwert 1.73, horizontal: 1.80, vertikal: 1.66

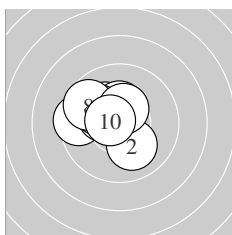
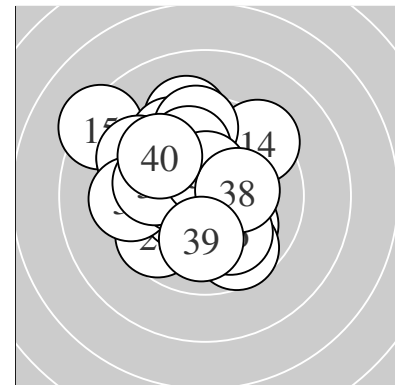

Serie 1:
 10.5 * 10.1 ↘ 10.2 * 9.5 ← 10.4 *
 10.3 * 10.1 ↖ 9.7 ↖ 10.4 * 10.6 *
 beste Teiler 87.6 (10.) 122.2 (1.) 131.4 (9.)
 Trefferlage 1.10 mm links, 0.71 mm hoch
 Streuwert 1.25, horizontal: 1.42, vertikal: 1.05

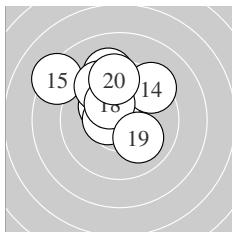

Serie 2:
 9.3 ↑ 10.5 * 10.2 * 9.4 ↗ 8.3 ↖
 9.6 ↘ 10.5 * 10.3 * 10.1 ↘ 9.5 ↑
 beste Teiler 102.4 (12.) 105.2 (17.) 171.8 (18.)
 Trefferlage 0.81 mm links, 1.94 mm hoch
 Streuwert 2.01, horizontal: 2.18, vertikal: 1.82

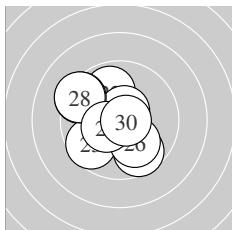

Serie 3:
 9.3 ↖ 9.9 ↑ 9.6 ↙ 9.7 ↘ 10.6 *
 10.0 ↘ 9.4 ↖ 9.3 ↖ 10.4 * 10.7 *
 beste Teiler 56.2 (30.) 89.8 (25.) 130.5 (29.)
 Trefferlage 1.10 mm links, 0.18 mm hoch
 Streuwert 2.01, horizontal: 2.06, vertikal: 1.96

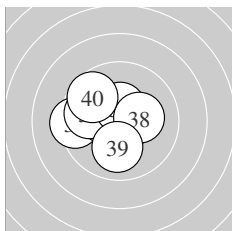

Serie 4:
 10.7 * 10.6 * 9.4 ← 10.4 * 10.0 ↖
 9.9 ← 10.5 * 10.3 * 10.0 ↓ 9.7 ↖
 beste Teiler 72.0 (31.) 80.6 (32.) 119.1 (37.)
 Trefferlage 1.02 mm links, 0.22 mm hoch
 Streuwert 1.50, horizontal: 1.75, vertikal: 1.21

Unterschrift des Schützen

Meyton Elektronik

Ergebnis: **390** (404.0)
 Serien: 96 97 99 98
 Zähler: 31 8 1 0 0 0 0 0 0
 Innenzehner: 21
 weiteste: 732 (40), 363 (27), 348 (7)
 beste Teiler 34.4 (35.) 50.5 (39.) 89.3 (23.)
 Trefferlage 0.66 mm rechts, 0.35 mm tief
 Streuwert 1.64, horizontal: 1.46, vertikal: 1.80

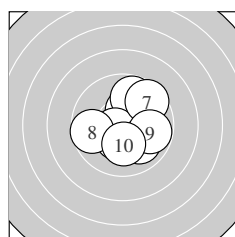
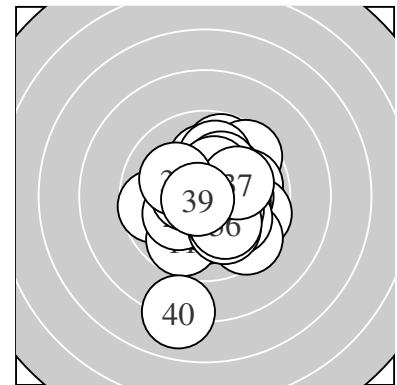

Serie 1:
 10.3 * 10.2 * 10.4 * 9.8 ↑ 10.6 *
 10.0 ↘ 9.6 ↗ 9.7 ← 9.8 → 10.2 *
 beste Teiler 90.7 (5.) 146.0 (3.) 161.0 (1.)
 Trefferlage 0.53 mm rechts, 0.13 mm hoch
 Streuwert 1.75, horizontal: 1.75, vertikal: 1.74

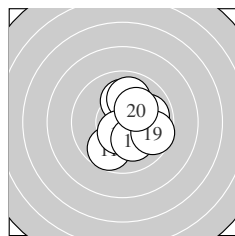

Serie 2:
 9.7 ↓ 10.1 ↑ 10.0 ↑ 10.2 * 10.0 →
 10.5 * 10.1 ↘ 9.9 → 9.6 → 10.2 *
 beste Teiler 110.6 (16.) 180.0 (14.) 191.0 (20.)
 Trefferlage 1.10 mm rechts, 0.00 mm
 Streuwert 1.55, horizontal: 1.41, vertikal: 1.67

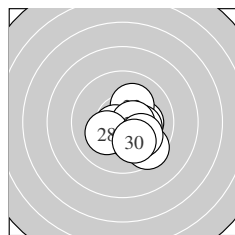

Serie 3:
 10.2 * 10.2 * 10.6 * 10.2 * 10.4 *
 10.5 * 9.5 ↘ 10.2 * 10.0 ↘ 10.0 ↘
 beste Teiler 89.3 (23.) 106.1 (26.) 148.5 (25.)
 Trefferlage 0.96 mm rechts, 0.77 mm tief
 Streuwert 1.24, horizontal: 1.29, vertikal: 1.20

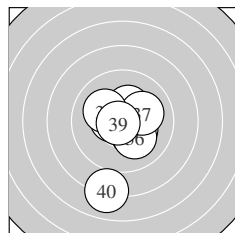

Serie 4:
 10.5 * 10.3 * 10.3 * 10.3 * 10.8 *
 10.1 ↘ 10.1 → 10.1 ↖ 10.8 * 8.0 ↓
 beste Teiler 34.4 (35.) 50.5 (39.) 110.3 (31.)
 Trefferlage 0.07 mm rechts, 0.78 mm tief
 Streuwert 1.97, horizontal: 1.33, vertikal: 2.44

Unterschrift des Schützen

Meyton Elektronik

Ergebnis: **386** (403.7)
 Serien: 93 98 97 98
 Zähler: 26 14 0 0 0 0 0 0 0 0
 Innenzehner: 20
 weiteste: 479 (2), 376 (26), 344 (39)
 beste Teiler 54.4 (17.) 77.0 (33.) 91.6 (31.)
 Trefferlage 0.07 mm links, 0.05 mm hoch
 Streuwert 1.67, horizontal: 1.84, vertikal: 1.47

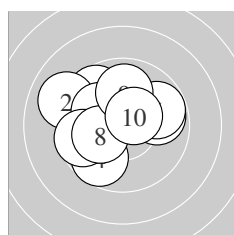
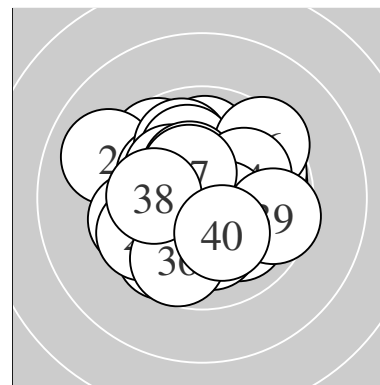

Serie 1:
 9.7 ↘ 9.0 ↖ 9.8 → 9.7 ✓ 9.8 ↗
 10.1 ↖ 9.6 ← 10.2 * 9.9 ↑ 10.5 *
 beste Teiler 113.7 (10.) 188.6 (8.) 210.0 (6.)
 Trefferlage 0.85 mm links, 0.63 mm hoch
 Streuwert 2.03, horizontal: 2.37, vertikal: 1.63

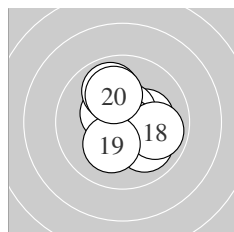

Serie 2:
 10.5 * 10.2 * 10.4 * 10.6 * 9.9 ↗
 10.0 ↘ 10.7 * 9.9 → 10.2 * 10.1 ↗
 beste Teiler 54.4 (17.) 91.7 (14.) 125.1 (11.)
 Trefferlage 0.35 mm rechts, 0.07 mm hoch
 Streuwert 1.39, horizontal: 1.30, vertikal: 1.47

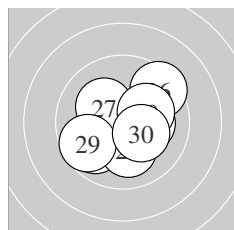

Serie 3:
 10.5 * 9.8 ↙ 10.2 * 10.1 ↓ 10.4 *
 9.4 ↗ 10.2 * 10.2 * 9.7 ↙ 10.3 *
 beste Teiler 121.4 (21.) 144.4 (25.) 169.0 (30.)
 Trefferlage 0.01 mm links, 0.19 mm tief
 Streuwert 1.73, horizontal: 1.93, vertikal: 1.49

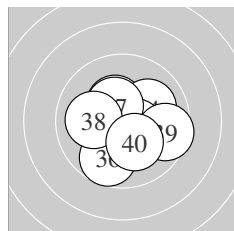

Serie 4:
 10.6 * 10.4 * 10.6 * 10.1 ↗ 10.5 *
 9.7 ↓ 10.4 * 10.0 ← 9.6 → 10.2 *
 beste Teiler 77.0 (33.) 91.6 (31.) 112.6 (35.)
 Trefferlage 0.22 mm rechts, 0.29 mm tief
 Streuwert 1.50, horizontal: 1.64, vertikal: 1.33

Unterschrift des Schützen

Meyton Elektronik

Ergebnis:	386	(407.7)
Serien:	96 98 97 95	
Zähler:	26 14 0 0 0 0 0 0 0 0	
Innenzehner:	25	
weiteste:	430 (3), 349 (24), 340 (40)	
beste Teiler	9.2 (19.) 27.3 (1.) 45.5 (18.)	
Trefferlage	0.32 mm links, 0.19 mm hoch	
Streuwert	1.53, horizontal: 1.59, vertikal: 1.46	

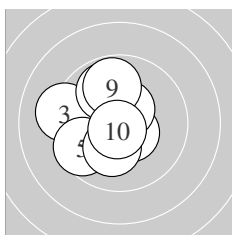
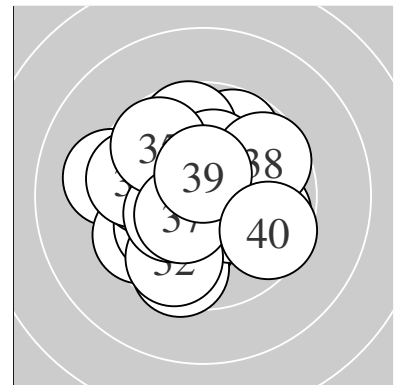

Serie 1:	10.8 *	10.2 *	9.2 ←	9.9 ↑	9.6 ↙
	10.5 *	10.5 *	10.2 *	9.8 ↑	10.7 *
beste Teiler	27.3 (1.) 52.5 (10.) 109.7 (6.)				
Trefferlage	0.91 mm links, 0.38 mm hoch				
Streuwert	1.58, horizontal: 1.52, vertikal: 1.64				

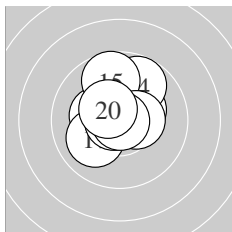

Serie 2:	10.3 *	10.6 *	10.3 *	9.8 ↗	9.7 ↑
	10.4 *	10.0 ↙	10.8 *	10.9 *	10.5 *
beste Teiler	9.2 (19.) 45.5 (18.) 91.9 (12.)				
Trefferlage	0.07 mm links, 0.66 mm hoch				
Streuwert	1.27, horizontal: 1.22, vertikal: 1.31				

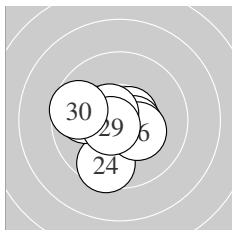

Serie 3:	10.6 *	10.3 *	10.6 *	9.6 ↓	10.5 *
	10.3 *	9.9 ←	10.6 *	10.6 *	9.7 ←
beste Teiler	76.4 (23.) 79.3 (29.) 94.3 (28.)				
Trefferlage	0.75 mm links, 0.31 mm tief				
Streuwert	1.35, horizontal: 1.48, vertikal: 1.19				

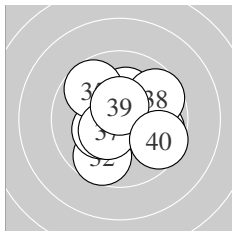

Serie 4:	10.4 *	9.7 ↓	10.2 *	10.3 *	9.7 ↖
	9.8 →	10.4 *	9.7 ↗	10.5 *	9.6 ↘
beste Teiler	101.0 (39.) 126.6 (37.) 130.6 (31.)				
Trefferlage	0.44 mm rechts, 0.03 mm hoch				
Streuwert	1.79, horizontal: 1.90, vertikal: 1.67				

Unterschrift des Schützen

Ergebnis: **383** (400.8)
 Serien: 97 99 97 90
 Zähler: 25 13 2 0 0 0 0 0 0 0
 Innenzehner: 17
 weiteste: 534 (39), 509 (36), 425 (40)
 beste Teiler 6.0 (12.) 9.4 (31.) 34.9 (17.)
 Trefferlage 0.14 mm rechts, 0.81 mm tief
 Streuwert 1.84, horizontal: 1.93, vertikal: 1.75

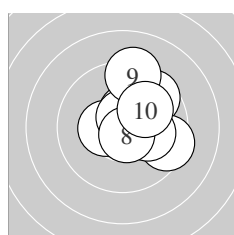
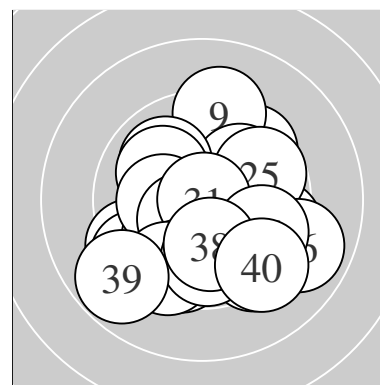

Serie 1:
 9.6 ↗ 10.5 * 9.5 ↘ 10.6 * 10.4 *
 10.1 → 10.6 * 10.7 * 9.3 ↑ 10.0 ↗
 beste Teiler 68.4 (8.) 80.7 (7.) 94.6 (4.)
 Trefferlage 1.07 mm rechts, 0.80 mm hoch
 Streuwert 1.49, horizontal: 1.38, vertikal: 1.60

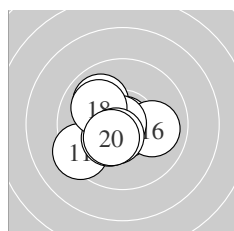

Serie 2:
 9.3 ↙ 10.9 * 10.0 ↘ 10.3 * 10.8 *
 10.0 → 10.8 * 10.0 ↘ 10.5 * 10.4 *
 beste Teiler 6.0 (12.) 34.9 (17.) 49.3 (15.)
 Trefferlage 0.73 mm links, 0.30 mm tief
 Streuwert 1.36, horizontal: 1.52, vertikal: 1.18

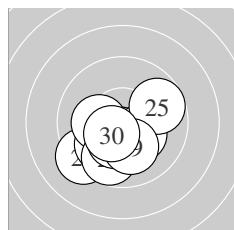

Serie 3:
 10.5 * 10.3 * 9.3 ↙ 10.0 ↙ 9.7 ↗
 10.2 * 9.8 ↓ 10.3 * 10.1 ↓ 10.4 *
 beste Teiler 105.0 (21.) 128.0 (30.) 159.6 (28.)
 Trefferlage 0.46 mm links, 1.24 mm tief
 Streuwert 1.48, horizontal: 1.70, vertikal: 1.22

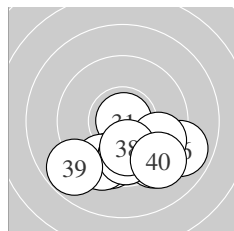

Serie 4:
 10.9 * 9.4 ↘ 9.6 ↓ 9.5 ↓ 9.8 ↓
 8.9 ↘ 9.6 ↘ 10.1 ↓ 8.8 ↙ 9.3 ↘
 beste Teiler 9.4 (31.) 217.7 (38.) 287.0 (35.)
 Trefferlage 0.70 mm rechts, 2.51 mm tief
 Streuwert 1.95, horizontal: 2.53, vertikal: 1.11

Unterschrift des Schützen

Meyton Elektronik

Ergebnis: **381** (402.0)
 Serien: 93 96 95 97
 Zähler: 23 15 2 0 0 0 0 0 0 0
 Innenzehner: 18
 weiteste: 644 (23), 543 (9), 416 (30)
 beste Teiler 44.5 (28.) 46.1 (35.) 46.6 (12.)
 Trefferlage 0.13 mm rechts, 0.14 mm tief
 Streuwert 1.88, horizontal: 1.72, vertikal: 2.04

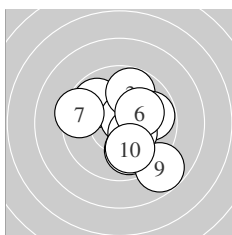
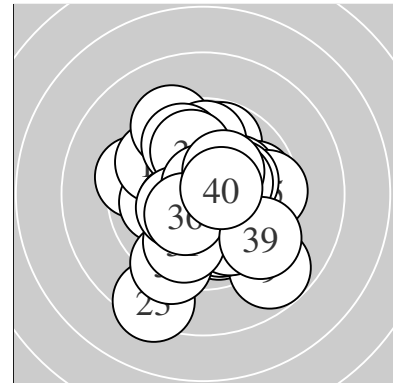

Serie 1:
 9.8 ↘ 10.7 * 9.8 ↑ 9.8 → 10.4 *
 10.1 ↗ 9.4 ← 9.9 ↓ 8.8 ↘ 10.0 ↓
 beste Teiler 65.0 (2.) 147.8 (5.) 206.7 (6.)
 Trefferlage 0.69 mm rechts, 0.20 mm tief
 Streuwert 2.15, horizontal: 2.15, vertikal: 2.15

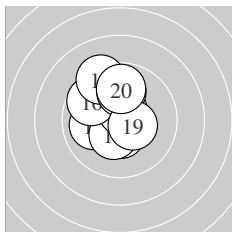

Serie 2:
 10.0 ← 10.8 * 10.5 * 10.4 * 10.6 *
 9.7 ↘ 9.3 ↘ 9.9 ↑ 10.4 * 9.8 ↑
 beste Teiler 46.6 (12.) 87.9 (15.) 125.3 (13.)
 Trefferlage 0.50 mm links, 0.77 mm hoch
 Streuwert 1.57, horizontal: 1.27, vertikal: 1.83

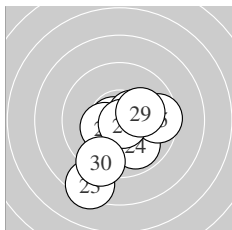

Serie 3:
 10.6 * 10.7 * 8.4 ↓ 9.9 ↘ 9.6 →
 10.4 * 10.5 * 10.8 * 10.1 → 9.3 ↓
 beste Teiler 44.5 (28.) 58.2 (22.) 78.6 (21.)
 Trefferlage 0.18 mm rechts, 1.23 mm tief
 Streuwert 1.99, horizontal: 1.87, vertikal: 2.11

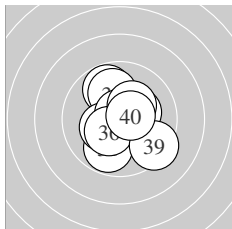

Serie 4:
 9.8 ↓ 9.8 ↘ 10.0 ↑ 10.3 * 10.8 *
 10.4 * 10.3 * 10.3 * 9.4 ↘ 10.5 *
 beste Teiler 46.1 (35.) 104.9 (40.) 146.6 (36.)
 Trefferlage 0.15 mm rechts, 0.08 mm hoch
 Streuwert 1.66, horizontal: 1.49, vertikal: 1.81

Unterschrift des Schützen

Ergebnis: **370** (389.0)
 Serien: 97 93 91 89
 Zähler: 17 16 7 0 0 0 0 0 0 0
 Innenzehner: 13
 weiteste: 620 (36), 587 (15), 548 (23)
 beste Teiler 20.6 (6.) 57.2 (17.) 74.5 (37.)
 Trefferlage 0.56 mm rechts, 0.57 mm hoch
 Streuwert 2.42, horizontal: 2.65, vertikal: 2.16

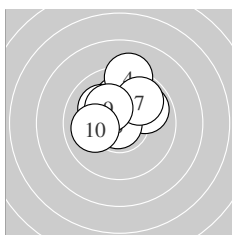
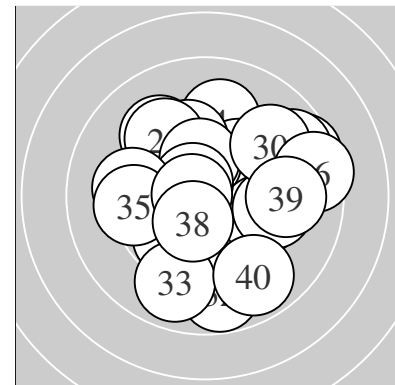

Serie 1:
 10.3 * 10.2 * 10.1 ↑ 9.2 ↑ 9.9 ↗
 10.9 * 9.8 ↗ 10.1 ↘ 10.3 * 10.0 ←
 beste Teiler 20.6 (6.) 161.2 (1.) 173.4 (9.)
 Trefferlage 0.14 mm links, 1.50 mm hoch
 Streuwert 1.38, horizontal: 1.46, vertikal: 1.29

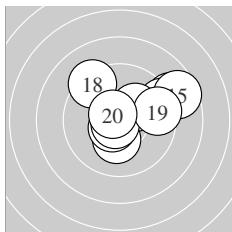

Serie 2:
 8.9 ↗ 9.2 ↗ 10.2 * 10.2 * 8.6 ↗
 10.6 * 10.7 * 9.3 ↘ 9.5 → 10.6 *
 beste Teiler 57.2 (17.) 84.3 (20.) 98.3 (16.)
 Trefferlage 1.45 mm rechts, 0.92 mm hoch
 Streuwert 2.24, horizontal: 2.75, vertikal: 1.57

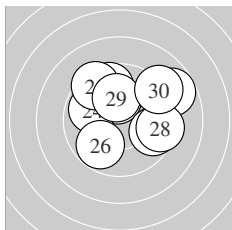

Serie 3:
 9.7 ↑ 10.2 * 8.8 ↗ 9.9 ↘ 9.4 ↘
 9.8 ↘ 9.6 → 9.4 → 10.1 ↑ 9.1 ↗
 beste Teiler 189.1 (22.) 210.1 (29.) 270.5 (24.)
 Trefferlage 0.73 mm rechts, 1.26 mm hoch
 Streuwert 2.42, horizontal: 2.81, vertikal: 1.96

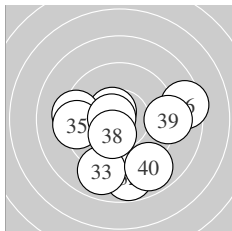

Serie 4:
 10.6 * 8.8 ↓ 8.9 ↓ 9.3 ← 9.3 ←
 8.5 → 10.7 * 10.3 * 9.1 → 8.9 ↘
 beste Teiler 74.5 (37.) 99.0 (31.) 157.4 (38.)
 Trefferlage 0.22 mm rechts, 1.39 mm tief
 Streuwert 2.96, horizontal: 3.35, vertikal: 2.50

Unterschrift des Schützen

Meyton Elektronik

Ergebnis: **399** (416.7)
 Serien: 100 99 100 100
 Zähler: 39 1 0 0 0 0 0 0 0 0
 Innenzehner: 35
 weiteste: 266 (12), 238 (17), 229 (25)
 beste Teiler 31.4 (14.) 38.3 (40.) 53.0 (21.)
 Trefferlage 0.01 mm rechts, 0.03 mm tief
 Streuwert 1.05, horizontal: 0.99, vertikal: 1.11

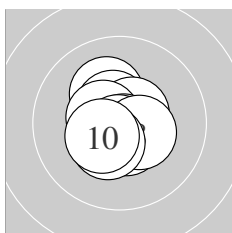
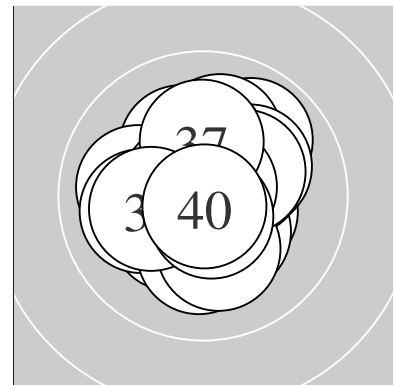

Serie 1:
 10.2 * 10.5 * 10.6 * 10.5 * 10.7 *
 10.7 * 10.5 * 10.4 * 10.4 * 10.4 *
 beste Teiler 53.6 (5.) 53.6 (6.) 93.2 (3.)
 Trefferlage 0.14 mm links, 0.08 mm tief
 Streuwert 0.87, horizontal: 0.78, vertikal: 0.95

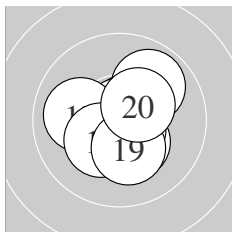

Serie 2:
 10.7 * 9.9 ↗ 10.3 * 10.8 * 10.4 *
 10.6 * 10.0 ← 10.3 * 10.3 * 10.4 *
 beste Teiler 31.4 (14.) 65.9 (11.) 80.6 (16.)
 Trefferlage 0.05 mm rechts, 0.15 mm tief
 Streuwert 1.20, horizontal: 1.24, vertikal: 1.16

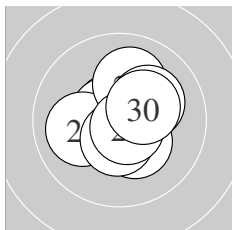

Serie 3:
 10.7 * 10.7 * 10.6 * 10.3 * 10.0 ←
 10.1 ↑ 10.2 * 10.5 * 10.7 * 10.3 *
 beste Teiler 53.0 (21.) 62.9 (29.) 73.6 (22.)
 Trefferlage 0.12 mm rechts, 0.19 mm hoch
 Streuwert 1.11, horizontal: 1.15, vertikal: 1.06

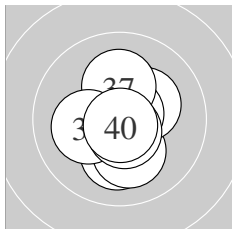

Serie 4:
 10.2 * 10.1 ↓ 10.7 * 10.2 * 10.3 *
 10.7 * 10.2 * 10.2 * 10.6 * 10.8 *
 beste Teiler 38.3 (40.) 54.2 (36.) 74.8 (33.)
 Trefferlage 0.03 mm rechts, 0.11 mm tief
 Streuwert 1.14, horizontal: 0.85, vertikal: 1.37

Unterschrift des Schützen

Ergebnis: **394** (411.2)
 Serien: 97 99 100 98
 Zähler: 34 6 0 0 0 0 0 0 0 0
 Innenzehner: 28
 weiteste: 384 (9), 366 (38), 350 (3)
 beste Teiler 7.2 (32.) 15.6 (37.) 33.8 (26.)
 Trefferlage 0.00 mm , 0.11 mm hoch
 Streuwert 1.38, horizontal: 1.51, vertikal: 1.23

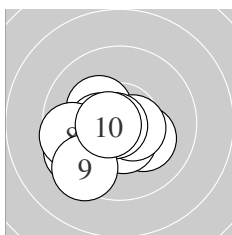
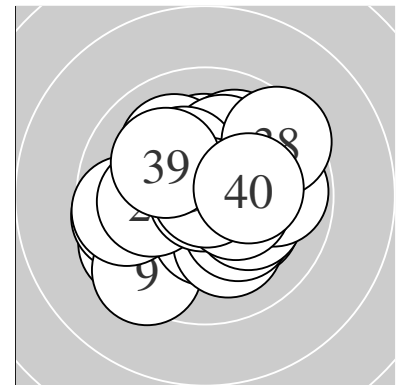

Serie 1:
 10.2 * 10.5 * 9.6 ↙ 10.3 * 10.4 *
 10.6 * 10.8 * 9.6 ↙ 9.4 ↘ 10.6 *
 beste Teiler 38.0 (7.) 77.7 (10.) 95.5 (6.)
 Trefferlage 0.95 mm links, 0.78 mm tief
 Streuwert 1.38, horizontal: 1.61, vertikal: 1.11

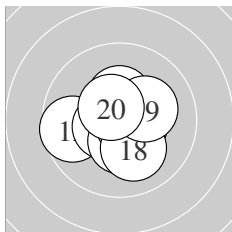

Serie 2:
 10.5 * 9.7 ← 10.4 * 10.6 * 10.5 *
 10.4 * 10.7 * 10.1 ↓ 10.2 * 10.5 *
 beste Teiler 70.2 (17.) 92.7 (14.) 104.5 (20.)
 Trefferlage 0.02 mm links, 0.28 mm tief
 Streuwert 1.22, horizontal: 1.37, vertikal: 1.05

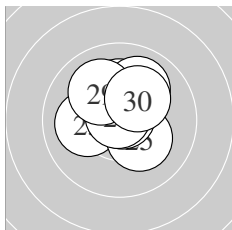

Serie 3:
 10.2 * 10.4 * 10.1 ← 10.5 * 10.2 *
 10.8 * 10.0 ↗ 10.8 * 10.0 ↘ 10.2 *
 beste Teiler 33.8 (26.) 33.8 (28.) 113.3 (24.)
 Trefferlage 0.09 mm rechts, 0.90 mm hoch
 Streuwert 1.10, horizontal: 1.11, vertikal: 1.09

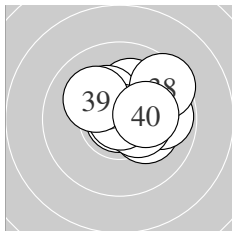

Serie 4:
 10.2 * 10.9 * 9.8 → 10.1 ↗ 10.3 *
 10.4 * 10.9 * 9.5 ↗ 10.1 ↘ 10.2 *
 beste Teiler 7.2 (32.) 15.6 (37.) 131.3 (36.)
 Trefferlage 0.87 mm rechts, 0.63 mm hoch
 Streuwert 1.28, horizontal: 1.50, vertikal: 1.01

Unterschrift des Schützen

Ergebnis: **396** (414.8)
 Serien: 99 99 99 99
 Zähler: 36 4 0 0 0 0 0 0 0 0
 Innenzehner: 30
 weiteste: 453 (21), 327 (36), 286 (16)
 beste Teiler 26.9 (6.) 29.5 (26.) 29.8 (14.)
 Trefferlage 0.53 mm rechts, 0.25 mm tief
 Streuwert 1.13, horizontal: 1.09, vertikal: 1.17

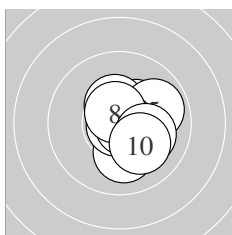
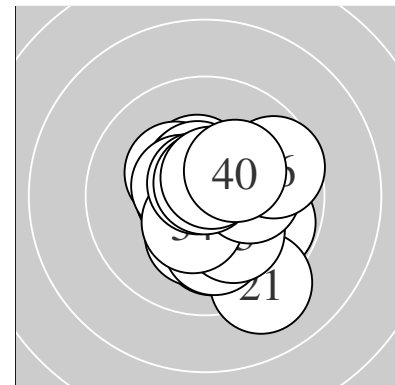

Serie 1:
 10.3 * 10.4 * 10.2 * 10.1 ↓ 9.9 →
 10.8 * 10.8 * 10.6 * 10.1 ↘ 10.1 ↘
 beste Teiler 26.9 (6.) 46.8 (7.) 86.1 (8.)
 Trefferlage 0.73 mm rechts, 0.24 mm tief
 Streuwert 1.13, horizontal: 0.98, vertikal: 1.26

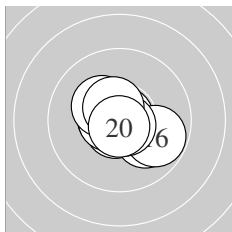

Serie 2:
 10.7 * 10.0 ↘ 10.6 * 10.8 * 10.6 *
 9.8 ↘ 10.3 * 10.7 * 10.5 * 10.8 *
 beste Teiler 29.8 (14.) 46.1 (20.) 55.9 (18.)
 Trefferlage 0.14 mm rechts, 0.16 mm tief
 Streuwert 1.03, horizontal: 1.23, vertikal: 0.77

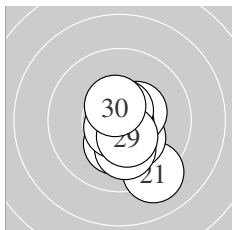

Serie 3:
 9.1 ↘ 10.2 * 10.3 * 10.1 ↓ 10.4 *
 10.8 * 10.7 * 10.7 * 10.4 * 10.5 *
 beste Teiler 29.5 (26.) 66.0 (27.) 74.6 (28.)
 Trefferlage 0.51 mm rechts, 0.84 mm tief
 Streuwert 1.23, horizontal: 0.89, vertikal: 1.49

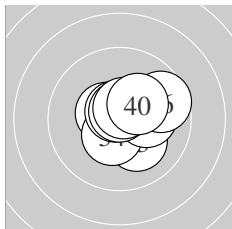

Serie 4:
 10.4 * 10.5 * 10.1 ↘ 10.4 * 10.2 *
 9.6 → 10.7 * 10.7 * 10.6 * 10.3 *
 beste Teiler 56.0 (38.) 63.5 (37.) 85.0 (39.)
 Trefferlage 0.74 mm rechts, 0.25 mm hoch
 Streuwert 1.10, horizontal: 1.26, vertikal: 0.92

Unterschrift des Schützen

Ergebnis: **385** (404.3)
 Serien: 97 96 96 96
 Zähler: 27 11 2 0 0 0 0 0 0 0
 Innenzehner: 24
 weiteste: 580 (12), 502 (28), 481 (34)
 beste Teiler 42.5 (39.) 45.5 (23.) 49.0 (19.)
 Trefferlage 0.34 mm links, 0.09 mm tief
 Streuwert 1.79, horizontal: 2.13, vertikal: 1.37

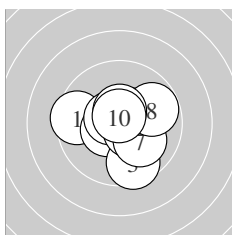
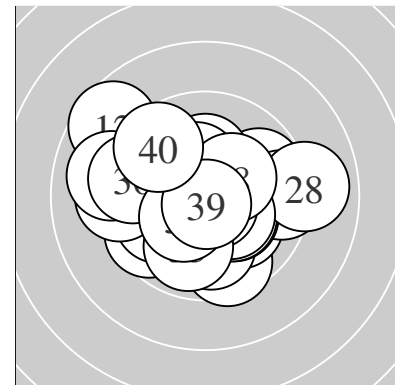

Serie 1:
 9.5 ← 10.5 * 9.6 ↓ 10.5 * 10.6 *
 10.5 * 10.1 ↘ 9.8 ↗ 10.5 * 10.7 *
 beste Teiler 61.2 (10.) 86.4 (5.) 102.0 (9.)
 Trefferlage 0.18 mm rechts, 0.15 mm tief
 Streuwert 1.56, horizontal: 1.73, vertikal: 1.37

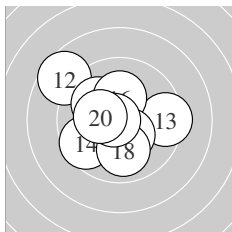

Serie 2:
 10.5 * 8.6 ↖ 9.4 → 9.6 ↙ 10.0 ↗
 10.2 * 10.4 * 10.0 ↓ 10.8 * 10.3 *
 beste Teiler 49.0 (19.) 114.0 (11.) 142.5 (17.)
 Trefferlage 0.74 mm links, 0.21 mm hoch
 Streuwert 2.04, horizontal: 2.27, vertikal: 1.79

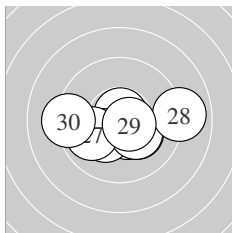

Serie 3:
 10.5 * 10.7 * 10.8 * 10.3 * 10.2 *
 10.3 * 9.9 ↙ 8.9 → 10.6 * 9.2 ←
 beste Teiler 45.5 (23.) 69.7 (22.) 87.3 (29.)
 Trefferlage 0.18 mm rechts, 0.56 mm tief
 Streuwert 1.81, horizontal: 2.47, vertikal: 0.66

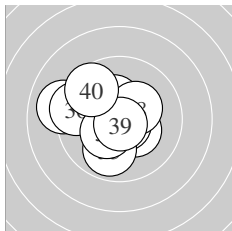

Serie 4:
 10.3 * 10.3 * 10.7 * 9.0 ← 9.9 ↓
 9.5 ← 10.4 * 10.3 * 10.8 * 9.6 ↖
 beste Teiler 42.5 (39.) 59.4 (33.) 150.6 (37.)
 Trefferlage 0.99 mm links, 0.13 mm hoch
 Streuwert 1.76, horizontal: 2.02, vertikal: 1.46

Unterschrift des Schützen

Meyton Elektronik

Ergebnis: **390** (409.9)
 Serien: 97 99 96 98
 Zähler: 30 10 0 0 0 0 0 0 0 0
 Innenzehner: 24
 weiteste: 457 (6), 408 (19), 348 (29)
 beste Teiler 12.1 (14.) 19.7 (8.) 33.6 (32.)
 Trefferlage 0.31 mm links, 0.00 mm
 Streuwert 1.46, horizontal: 1.55, vertikal: 1.36

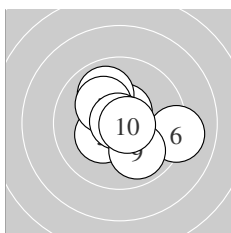
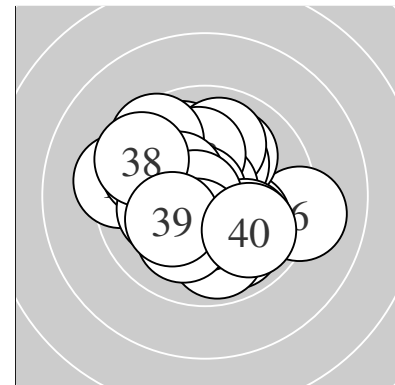

Serie 1:
 10.4 * 10.6 * 9.9 ↖ 10.5 * 10.3 *
 9.1 → 10.2 * 10.9 * 9.9 ↘ 10.7 *
 beste Teiler 19.7 (8.) 61.6 (10.) 95.2 (2.)
 Trefferlage 0.29 mm rechts, 0.09 mm hoch
 Streuwert 1.57, horizontal: 1.74, vertikal: 1.38

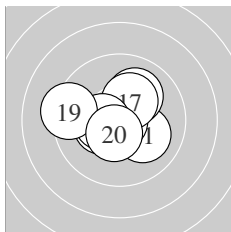

Serie 2:
 10.1 ↘ 10.6 * 10.8 * 10.9 * 10.4 *
 10.1 ↗ 10.3 * 10.4 * 9.3 ← 10.5 *
 beste Teiler 12.1 (14.) 33.7 (13.) 78.4 (12.)
 Trefferlage 0.42 mm links, 0.07 mm hoch
 Streuwert 1.36, horizontal: 1.64, vertikal: 1.02

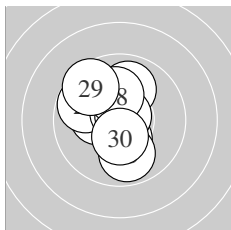

Serie 3:
 9.9 ↑ 10.3 * 9.8 ↖ 10.3 * 9.9 ↓
 10.7 * 10.8 * 10.1 ↑ 9.6 ↖ 10.4 *
 beste Teiler 43.2 (27.) 61.1 (26.) 131.0 (30.)
 Trefferlage 0.52 mm links, 0.40 mm hoch
 Streuwert 1.53, horizontal: 1.24, vertikal: 1.77

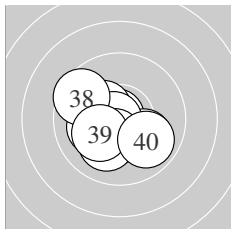

Serie 4:
 10.1 ← 10.8 * 10.0 ↘ 10.3 * 10.8 *
 10.4 * 10.1 ↙ 9.6 ↖ 10.2 * 9.9 ↘
 beste Teiler 33.6 (32.) 48.5 (35.) 147.5 (36.)
 Trefferlage 0.60 mm links, 0.54 mm tief
 Streuwert 1.41, horizontal: 1.60, vertikal: 1.19

Unterschrift des Schützen

Ergebnis: **383** (400.9)
 Serien: 96 93 98 96
 Zähler: 25 14 0 1 0 0 0 0 0 0
 Innenzehner: 16
 weiteste: 834 (17), 474 (2), 435 (32)
 beste Teiler 12.5 (38.) 35.1 (26.) 54.4 (30.)
 Trefferlage 0.09 mm links, 0.38 mm tief
 Streuwert 1.96, horizontal: 2.20, vertikal: 1.68

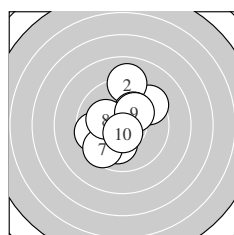
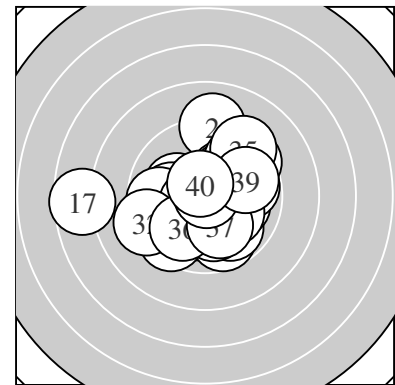

Serie 1:
 9.5 ↗ 9.1 ↑ 10.2 * 10.1 ↙ 9.6 ←
 10.1 ↓ 9.6 ↘ 10.1 ← 10.2 * 10.6 *
 beste Teiler 87.0 (10.) 192.8 (3.) 196.7 (9.)
 Trefferlage 0.36 mm links, 0.32 mm hoch
 Streuwert 2.08, horizontal: 1.93, vertikal: 2.23

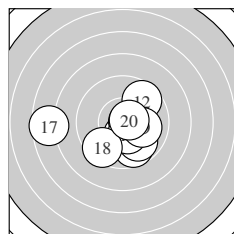

Serie 2:
 10.4 * 9.6 ↗ 9.7 ↓ 10.7 * 9.8 ↘
 10.4 * 7.6 ← 9.5 ↘ 10.0 → 10.6 *
 beste Teiler 66.1 (14.) 77.4 (20.) 141.3 (11.)
 Trefferlage 0.12 mm links, 0.89 mm tief
 Streuwert 2.51, horizontal: 3.16, vertikal: 1.62

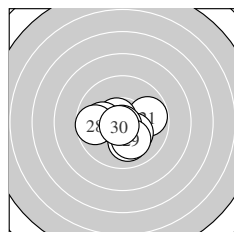

Serie 3:
 9.8 → 10.5 * 10.6 * 10.3 * 10.0 ↓
 10.8 * 10.0 ← 9.7 ← 10.1 ↓ 10.7 *
 beste Teiler 35.1 (26.) 54.4 (30.) 83.8 (23.)
 Trefferlage 0.05 mm links, 0.61 mm tief
 Streuwert 1.38, horizontal: 1.71, vertikal: 0.95

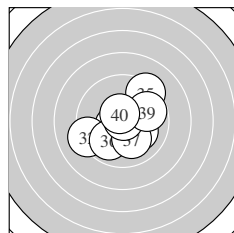

Serie 4:
 10.6 * 9.2 ← 10.1 ↘ 10.5 * 9.3 ↗
 9.9 ↘ 10.1 ↓ 10.9 * 9.8 → 10.6 *
 beste Teiler 12.5 (38.) 89.3 (40.) 100.2 (31.)
 Trefferlage 0.18 mm rechts, 0.36 mm tief
 Streuwert 1.87, horizontal: 2.03, vertikal: 1.68

Unterschrift des Schützen

Meyton Elektronik

Ergebnis: **384** (403.5)
 Serien: 93 98 95 98
 Zähler: 25 14 1 0 0 0 0 0 0 0
 Innenzehner: 18
 weiteste: 504 (9), 488 (1), 452 (7)
 beste Teiler 1.0 (38.) 8.2 (15.) 11.0 (31.)
 Trefferlage 0.26 mm links, 0.09 mm tief
 Streuwert 1.76, horizontal: 2.00, vertikal: 1.47

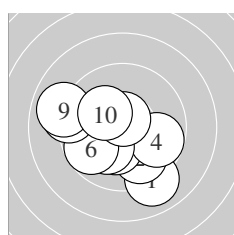
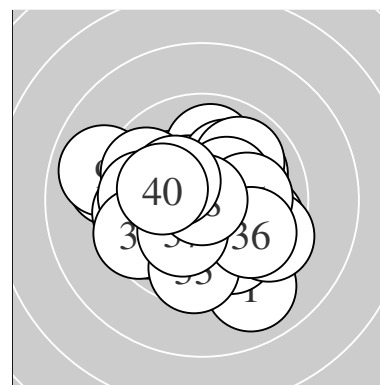

Serie 1:
 9.0 ↘ 9.8 ↘ 10.2 * 9.8 → 10.1 ↗
 9.7 ↙ 9.1 ← 10.7 * 8.9 ← 10.2 *
 beste Teiler 67.2 (8.) 176.4 (3.) 186.3 (10.)
 Trefferlage 0.84 mm links, 0.84 mm tief
 Streuwert 2.27, horizontal: 2.63, vertikal: 1.85

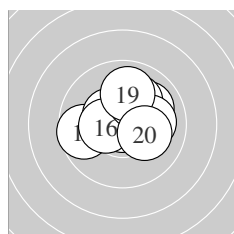

Serie 2:
 10.0 ↗ 10.5 * 9.7 ← 10.4 * 10.9 *
 10.4 * 10.1 ↗ 10.1 → 9.9 ↑ 10.2 *
 beste Teiler 8.2 (15.) 114.1 (12.) 128.9 (14.)
 Trefferlage 0.07 mm rechts, 0.53 mm hoch
 Streuwert 1.45, horizontal: 1.75, vertikal: 1.06

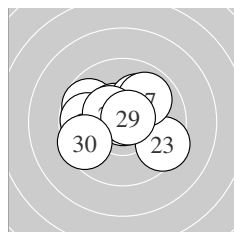

Serie 3:
 9.7 ↖ 10.5 * 9.5 ↘ 10.8 * 9.8 ←
 10.1 ↗ 9.9 ↗ 10.4 * 10.7 * 9.5 ↙
 beste Teiler 31.1 (24.) 58.2 (29.) 116.0 (22.)
 Trefferlage 0.37 mm links, 0.40 mm hoch
 Streuwert 1.76, horizontal: 2.15, vertikal: 1.26

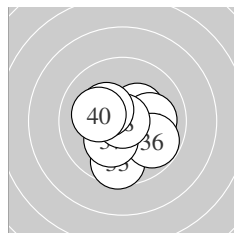

Serie 4:
 10.9 * 10.6 * 9.6 ↓ 10.4 * 10.1 →
 9.8 ↘ 10.2 * 10.9 * 10.3 * 10.1 ←
 beste Teiler 1.0 (38.) 11.0 (31.) 77.8 (32.)
 Trefferlage 0.07 mm rechts, 0.47 mm tief
 Streuwert 1.40, horizontal: 1.46, vertikal: 1.34

Unterschrift des Schützen

Meyton Elektronik

Ergebnis: **376** (395.1)
 Serien: 93 96 95 92
 Zähler: 18 20 2 0 0 0 0 0 0 0
 Innenzehner: 13
 weiteste: 527 (21), 526 (6), 475 (3)
 beste Teiler 83.1 (40.) 83.4 (22.) 89.0 (1.)
 Trefferlage 0.44 mm links, 0.42 mm tief
 Streuwert 2.08, horizontal: 2.46, vertikal: 1.61

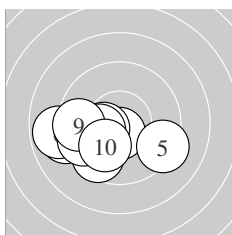
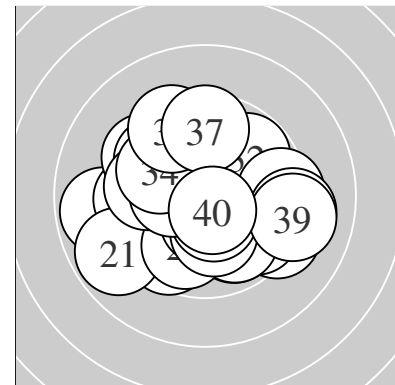

Serie 1:
 10.6 * 10.4 * 9.1 ← 10.2 * 9.3 ↘
 8.8 ← 9.6 ↙ 9.6 ← 9.6 ← 10.0 ↙
 beste Teiler 89.0 (1.) 145.4 (2.) 183.4 (4.)
 Trefferlage 1.89 mm links, 1.22 mm tief
 Streuwert 1.88, horizontal: 2.53, vertikal: 0.82

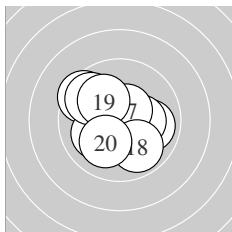

Serie 2:
 10.2 * 9.5 ↖ 10.1 ← 9.9 → 9.7 ↖
 10.3 * 10.5 * 9.9 ↘ 10.1 ↖ 10.1 ↙
 beste Teiler 101.7 (17.) 174.1 (16.) 185.8 (11.)
 Trefferlage 0.48 mm links, 0.08 mm tief
 Streuwert 1.76, horizontal: 1.92, vertikal: 1.59

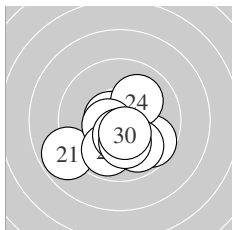

Serie 3:
 8.8 ↙ 10.6 * 9.7 ↘ 10.1 ↗ 10.5 *
 9.9 ↘ 9.9 ↙ 10.4 * 10.2 * 10.5 *
 beste Teiler 83.4 (22.) 107.0 (25.) 120.7 (30.)
 Trefferlage 0.07 mm links, 1.22 mm tief
 Streuwert 1.69, horizontal: 1.95, vertikal: 1.37

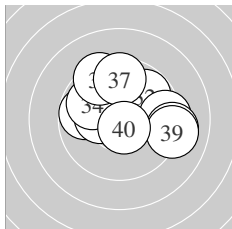

Serie 4:
 9.8 ← 9.8 ↗ 10.3 * 9.9 ↖ 9.4 →
 9.4 ↘ 9.6 ↑ 9.1 → 9.1 → 10.6 *
 beste Teiler 83.1 (40.) 165.6 (33.) 267.9 (34.)
 Trefferlage 0.67 mm rechts, 0.84 mm hoch
 Streuwert 2.36, horizontal: 2.90, vertikal: 1.67

Unterschrift des Schützen

Ergebnis: **388** (408.1)
 Serien: 96 98 97 97
 Zähler: 29 10 1 0 0 0 0 0 0 0
 Innenzehner: 28
 weiteste: 537 (8), 440 (29), 427 (27)
 beste Teiler 36.8 (34.) 46.0 (24.) 50.1 (14.)
 Trefferlage 0.04 mm rechts, 0.02 mm tief
 Streuwert 1.58, horizontal: 1.82, vertikal: 1.29

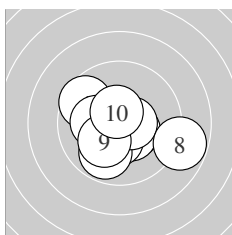
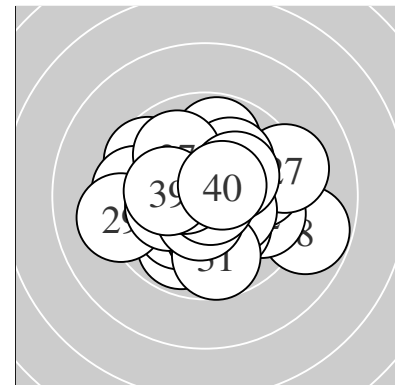

Serie 1:
 10.4 * 10.4 * 10.4 * 9.6 ↘ 9.9 ↙
 10.2 * 10.6 * 8.8 → 10.2 * 10.6 *
 beste Teiler 94.0 (7.) 99.2 (10.) 132.9 (2.)
 Trefferlage 0.03 mm rechts, 0.58 mm tief
 Streuwert 1.82, horizontal: 2.22, vertikal: 1.30

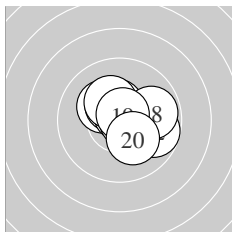

Serie 2:
 10.2 * 9.8 → 10.4 * 10.8 * 10.5 *
 10.3 * 10.7 * 9.9 → 10.7 * 10.2 *
 beste Teiler 50.1 (14.) 54.5 (17.) 55.4 (19.)
 Trefferlage 0.44 mm rechts, 0.42 mm hoch
 Streuwert 1.22, horizontal: 1.41, vertikal: 1.00

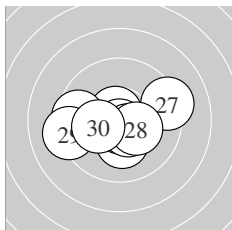

Serie 3:
 10.2 * 10.7 * 10.7 * 10.8 * 10.5 *
 9.5 ← 9.2 → 10.3 * 9.2 ← 10.2 *
 beste Teiler 46.0 (24.) 62.2 (22.) 70.3 (23.)
 Trefferlage 0.35 mm links, 0.38 mm tief
 Streuwert 1.81, horizontal: 2.39, vertikal: 0.92

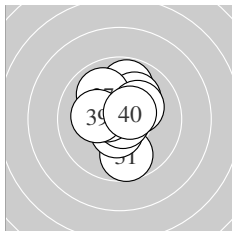

Serie 4:
 9.7 ↓ 9.8 ↑ 10.5 * 10.8 * 10.1 ↗
 10.5 * 9.9 ↘ 10.2 * 10.2 * 10.5 *
 beste Teiler 36.8 (34.) 102.3 (40.) 105.7 (33.)
 Trefferlage 0.05 mm rechts, 0.44 mm hoch
 Streuwert 1.43, horizontal: 1.16, vertikal: 1.66

Unterschrift des Schützen

Meyton Elektronik

Ergebnis: **398** (418.4)
 Serien: 100 100 100 98
 Zähler: 38 2 0 0 0 0 0 0 0 0
 Innenzehner: 33
 weiteste: 341 (39), 251 (31), 248 (21)
 beste Teiler 25.2 (38.) 31.7 (18.) 37.0 (6.)
 Trefferlage 0.18 mm rechts, 0.06 mm tief
 Streuwert 1.01, horizontal: 0.99, vertikal: 1.02

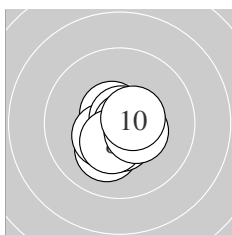
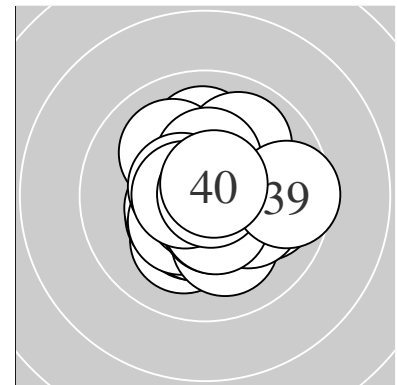

Serie 1:
 10.1 ↙ 10.6 * 10.4 * 10.8 * 10.5 *
 10.8 * 10.8 * 10.4 * 10.4 * 10.6 *
 beste Teiler 37.0 (6.) 41.1 (7.) 49.4 (4.)
 Trefferlage 0.01 mm rechts, 0.44 mm tief
 Streuwert 0.79, horizontal: 0.76, vertikal: 0.82

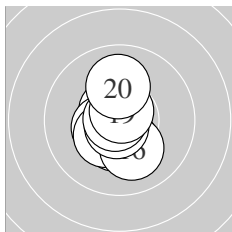

Serie 2:
 10.4 * 10.6 * 10.3 * 10.5 * 10.4 *
 10.1 ↘ 10.8 * 10.8 * 10.7 * 10.0 ↑
 beste Teiler 31.7 (18.) 48.7 (17.) 65.3 (19.)
 Trefferlage 0.22 mm links, 0.30 mm tief
 Streuwert 1.00, horizontal: 0.61, vertikal: 1.27

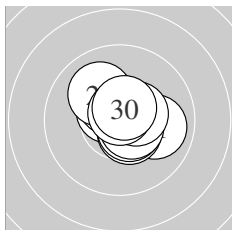

Serie 3:
 10.0 → 10.6 * 10.5 * 10.4 * 10.6 *
 10.0 ↘ 10.6 * 10.5 * 10.8 * 10.6 *
 beste Teiler 49.0 (29.) 91.1 (30.) 93.3 (25.)
 Trefferlage 0.33 mm rechts, 0.30 mm hoch
 Streuwert 0.99, horizontal: 1.09, vertikal: 0.88

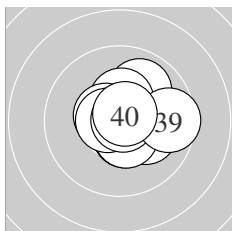

Serie 4:
 9.9 ↗ 10.2 * 10.4 * 10.5 * 10.5 *
 10.5 * 10.6 * 10.9 * 9.6 → 10.7 *
 beste Teiler 25.2 (38.) 62.2 (40.) 83.1 (37.)
 Trefferlage 0.63 mm rechts, 0.18 mm hoch
 Streuwert 1.16, horizontal: 1.29, vertikal: 1.02

Unterschrift des Schützen

Ergebnis: **384** (402.8)
 Serien: 94 95 99 96
 Zähler: 25 14 1 0 0 0 0 0 0 0
 Innenzehner: 22
 weiteste: 574 (7), 477 (30), 412 (6)
 beste Teiler 43.1 (23.) 53.2 (37.) 54.9 (5.)
 Trefferlage 0.20 mm rechts, 0.14 mm hoch
 Streuwert 1.83, horizontal: 2.05, vertikal: 1.58

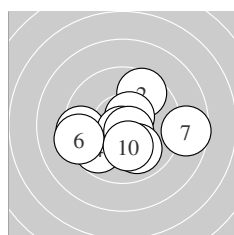
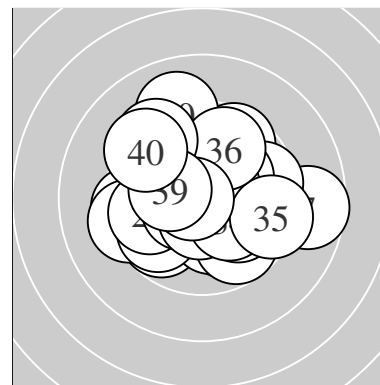

Serie 1:
 9.4 ← 9.6 ↗ 10.6 * 9.8 ↙ 10.7 *
 9.3 ← 8.7 → 10.6 * 10.0 ↘ 10.2 *
 beste Teiler 54.9 (5.) 77.7 (8.) 98.0 (3.)
 Trefferlage 0.04 mm rechts, 0.57 mm tief
 Streuwert 2.27, horizontal: 2.84, vertikal: 1.51

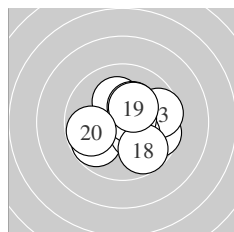

Serie 2:
 9.8 ↙ 9.7 → 9.6 → 10.3 * 10.2 *
 10.3 * 10.6 * 9.7 ↘ 10.3 * 9.8 ←
 beste Teiler 87.4 (17.) 155.6 (14.) 164.6 (16.)
 Trefferlage 0.61 mm rechts, 0.12 mm tief
 Streuwert 1.77, horizontal: 2.02, vertikal: 1.47

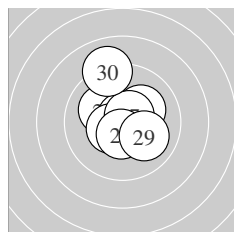

Serie 3:
 10.4 * 10.1 ↖ 10.8 * 10.7 * 10.5 *
 10.2 * 10.6 * 10.5 * 10.0 ↘ 9.0 ↑
 beste Teiler 43.1 (23.) 67.1 (24.) 84.1 (27.)
 Trefferlage 0.15 mm rechts, 0.38 mm hoch
 Streuwert 1.50, horizontal: 1.25, vertikal: 1.70

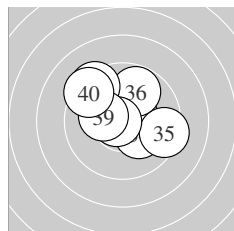

Serie 4:
 10.6 * 10.5 * 10.6 * 10.2 * 9.4 →
 9.8 ↗ 10.7 * 9.4 ↖ 10.2 * 9.4 ↖
 beste Teiler 53.2 (37.) 88.8 (33.) 90.9 (31.)
 Trefferlage 0.02 mm rechts, 0.89 mm hoch
 Streuwert 1.78, horizontal: 2.04, vertikal: 1.48

Unterschrift des Schützen

Meyton Elektronik

Ergebnis: **395** (413.0)
 Serien: 99 98 100 98
 Zähler: 35 5 0 0 0 0 0 0 0 0
 Innenzehner: 29
 weiteste: 369 (5), 345 (14), 292 (34)
 beste Teiler 39.8 (10.) 41.1 (33.) 43.0 (29.)
 Trefferlage 0.40 mm rechts, 0.19 mm hoch
 Streuwert 1.25, horizontal: 1.42, vertikal: 1.06

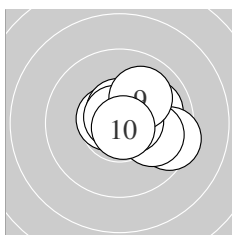
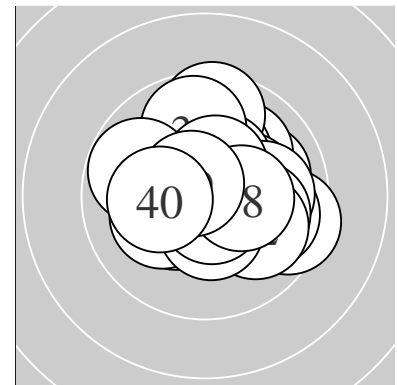

Serie 1:
 10.0 → 10.6 * 10.3 * 10.6 * 9.5 →
 10.7 * 10.0 → 10.6 * 10.0 ↗ 10.8 *
 beste Teiler 39.8 (10.) 52.4 (6.) 87.9 (8.)
 Trefferlage 1.10 mm rechts, 0.21 mm hoch
 Streuwert 1.14, horizontal: 1.37, vertikal: 0.85

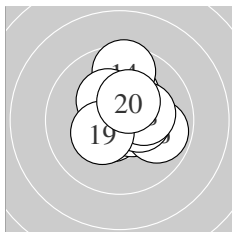

Serie 2:
 10.2 * 10.6 * 10.6 * 9.6 ↑ 10.3 *
 9.9 → 10.4 * 10.2 * 10.3 * 10.4 *
 beste Teiler 90.6 (13.) 93.6 (12.) 139.0 (17.)
 Trefferlage 0.54 mm rechts, 0.56 mm hoch
 Streuwert 1.30, horizontal: 1.20, vertikal: 1.40

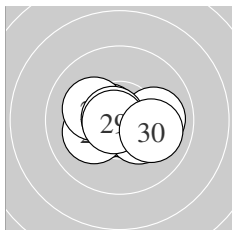

Serie 3:
 10.6 * 10.8 * 10.6 * 10.3 * 10.2 *
 10.2 * 10.0 → 10.8 * 10.8 * 10.0 →
 beste Teiler 43.0 (29.) 47.2 (22.) 49.0 (28.)
 Trefferlage 0.02 mm rechts, 0.19 mm tief
 Streuwert 1.14, horizontal: 1.52, vertikal: 0.55

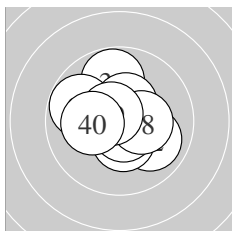

Serie 4:
 9.8 ↑ 10.0 → 10.8 * 9.8 ↖ 10.5 *
 10.4 * 10.7 * 10.3 * 10.6 * 10.2 *
 beste Teiler 41.1 (33.) 71.1 (37.) 78.6 (39.)
 Trefferlage 0.06 mm links, 0.21 mm hoch
 Streuwert 1.36, horizontal: 1.46, vertikal: 1.26

Unterschrift des Schützen

Ergebnis: **387** (404.1)
 Serien: 98 95 97 97
 Zähler: 28 11 1 0 0 0 0 0 0 0
 Innenzehner: 22
 weiteste: 503 (13), 495 (18), 457 (36)
 beste Teiler 43.0 (17.) 46.0 (3.) 58.8 (32.)
 Trefferlage 0.51 mm rechts, 0.27 mm hoch
 Streuwert 1.72, horizontal: 2.04, vertikal: 1.33

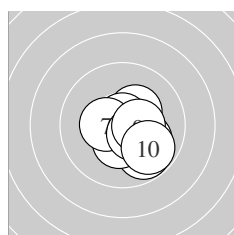
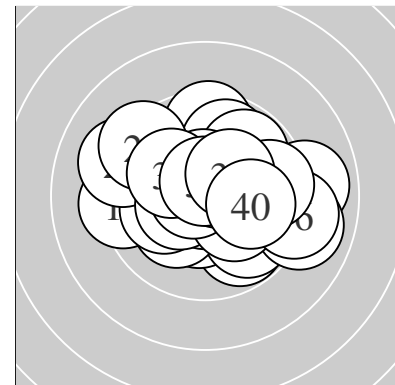

Serie 1:
 10.1 ↘ 10.3 * 10.8 * 10.1 ↘ 9.8 ↘
 10.4 * 10.4 * 10.5 * 10.4 * 9.8 ↘
 beste Teiler 46.0 (3.) 115.8 (8.) 133.1 (9.)
 Trefferlage 0.86 mm rechts, 0.76 mm tief
 Streuwert 1.11, horizontal: 1.10, vertikal: 1.12

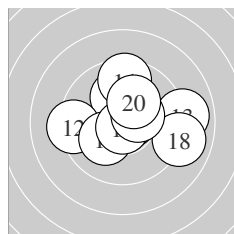

Serie 2:
 10.1 ↑ 9.3 ← 8.9 → 9.5 ↑ 10.2 *
 10.7 * 10.8 * 9.0 → 10.4 * 10.2 *
 beste Teiler 43.0 (17.) 61.9 (16.) 138.7 (19.)
 Trefferlage 0.66 mm rechts, 0.48 mm hoch
 Streuwert 2.20, horizontal: 2.69, vertikal: 1.58

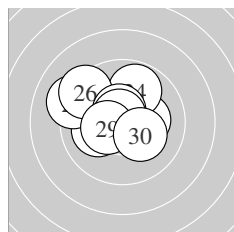

Serie 3:
 10.4 * 10.2 * 10.1 ← 9.8 ↑ 9.2 ↖
 9.4 ↖ 10.6 * 10.7 * 10.4 * 10.2 *
 beste Teiler 59.0 (28.) 99.3 (27.) 126.9 (21.)
 Trefferlage 0.61 mm links, 0.74 mm hoch
 Streuwert 1.67, horizontal: 2.00, vertikal: 1.28

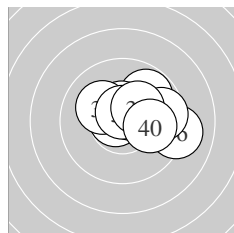

Serie 4:
 9.8 ↗ 10.7 * 10.5 * 10.1 ↖ 10.6 *
 9.1 → 10.7 * 9.6 → 10.3 * 10.0 →
 beste Teiler 58.8 (32.) 74.1 (37.) 93.3 (35.)
 Trefferlage 1.15 mm rechts, 0.61 mm hoch
 Streuwert 1.46, horizontal: 1.88, vertikal: 0.86

Unterschrift des Schützen

Ergebnis: **387** (401.8)
 Serien: 99 96 97 95
 Zähler: 30 7 3 0 0 0 0 0 0 0
 Innenzehner: 20
 weiteste: 713 (12), 553 (24), 550 (37)
 beste Teiler 15.0 (10.) 81.1 (13.) 83.0 (29.)
 Trefferlage 0.39 mm rechts, 0.32 mm hoch
 Streuwert 1.89, horizontal: 2.23, vertikal: 1.47

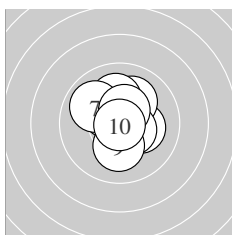
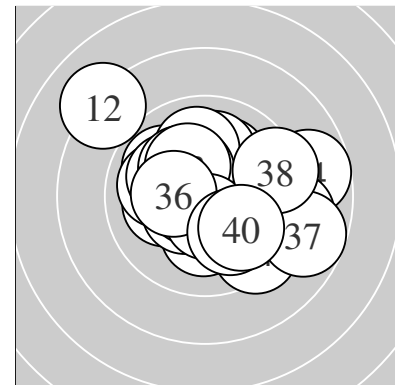

Serie 1:
 10.2 * 10.4 * 10.6 * 10.1 ↗ 10.5 *
 10.1 ↑ 9.9 ↘ 10.5 * 10.2 * 10.9 *
 beste Teiler 15.0 (10.) 99.1 (3.) 114.2 (5.)
 Trefferlage 0.05 mm rechts, 0.53 mm hoch
 Streuwert 1.19, horizontal: 1.10, vertikal: 1.27

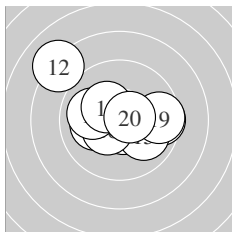

Serie 2:
 10.1 ← 8.1 ↘ 10.6 * 9.6 → 10.0 ↘
 10.4 * 10.0 ← 10.3 * 9.6 → 10.6 *
 beste Teiler 81.1 (13.) 91.7 (20.) 132.2 (16.)
 Trefferlage 0.17 mm links, 0.37 mm hoch
 Streuwert 2.30, horizontal: 2.79, vertikal: 1.69

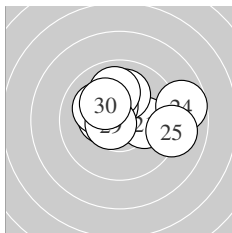

Serie 3:
 10.1 → 10.4 * 10.1 ↘ 8.7 → 9.1 →
 10.1 ↑ 10.4 * 10.0 ↑ 10.6 * 10.2 *
 beste Teiler 83.0 (29.) 136.0 (27.) 141.0 (22.)
 Trefferlage 0.61 mm rechts, 0.81 mm hoch
 Streuwert 1.98, horizontal: 2.56, vertikal: 1.11

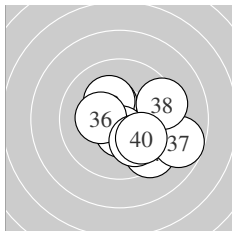

Serie 4:
 10.5 * 10.4 * 10.2 * 9.4 ↘ 10.5 *
 10.3 * 8.8 ↘ 9.4 → 10.0 ↘ 9.9 ↘
 beste Teiler 109.4 (35.) 112.3 (31.) 146.7 (32.)
 Trefferlage 1.09 mm rechts, 0.43 mm tief
 Streuwert 1.96, horizontal: 2.23, vertikal: 1.65

Unterschrift des Schützen

Ergebnis: **385** (399.8)
 Serien: 93 98 97 97
 Zähler: 25 15 0 0 0 0 0 0 0 0
 Innenzehner: 12
 weiteste: 465 (20), 448 (40), 437 (26)
 beste Teiler 15.0 (22.) 31.2 (25.) 33.5 (28.)
 Trefferlage 0.14 mm rechts, 0.15 mm tief
 Streuwert 1.90, horizontal: 2.03, vertikal: 1.75

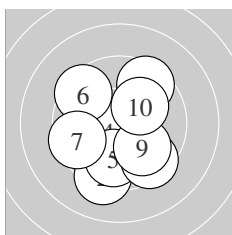
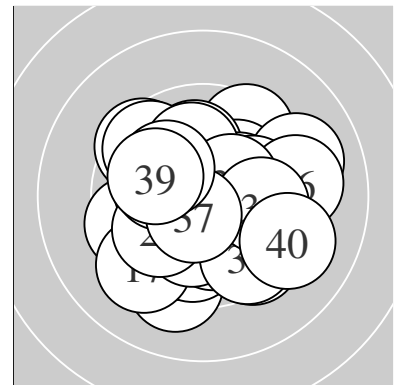

Serie 1:
 10.1 ← 9.2 ↓ 9.5 ↗ 10.5 * 9.8 ↓
 9.5 ↘ 9.5 ← 9.5 ↘ 9.9 ↘ 10.1 ↗
 beste Teiler 107.0 (4.) 206.5 (10.) 208.3 (1.)
 Trefferlage 0.31 mm links, 0.73 mm tief
 Streuwert 2.22, horizontal: 2.11, vertikal: 2.33

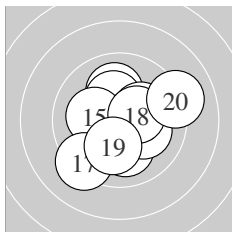

Serie 2:
 10.0 ↑ 10.3 * 10.1 ↓ 10.2 * 10.2 *
 10.1 → 9.3 ↙ 10.4 * 10.1 ↓ 9.1 →
 beste Teiler 139.4 (18.) 168.0 (12.) 181.3 (14.)
 Trefferlage 0.35 mm rechts, 0.12 mm tief
 Streuwert 1.95, horizontal: 2.06, vertikal: 1.85

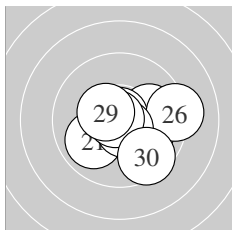

Serie 3:
 9.9 ↙ 10.9 * 10.1 → 10.0 → 10.8 *
 9.2 → 10.6 * 10.8 * 10.5 * 9.5 ↘
 beste Teiler 15.0 (22.) 31.2 (25.) 33.5 (28.)
 Trefferlage 0.77 mm rechts, 0.39 mm tief
 Streuwert 1.55, horizontal: 1.89, vertikal: 1.13

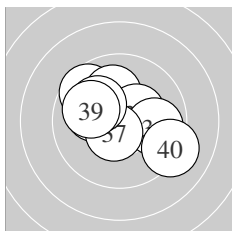

Serie 4:
 10.1 ↖ 9.6 ↘ 10.1 ↑ 10.1 ↖ 10.4 *
 9.9 → 10.6 * 10.1 ↖ 10.0 ↖ 9.2 ↘
 beste Teiler 98.3 (37.) 146.2 (35.) 206.1 (34.)
 Trefferlage 0.22 mm links, 0.63 mm hoch
 Streuwert 1.85, horizontal: 2.20, vertikal: 1.41

Unterschrift des Schützen

Meyton Elektronik

Ergebnis: **383** (400.7)
 Serien: 97 94 97 95
 Zähler: 24 15 1 0 0 0 0 0 0 0
 Innenzehner: 18
 weiteste: 559 (1), 487 (17), 482 (11)
 beste Teiler 10.4 (24.) 37.1 (5.) 56.7 (23.)
 Trefferlage 0.40 mm links, 0.07 mm hoch
 Streuwert 1.87, horizontal: 1.95, vertikal: 1.78

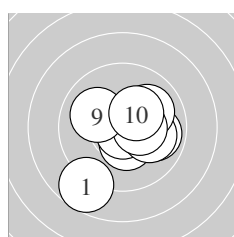
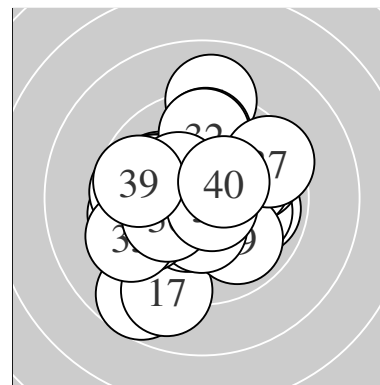

Serie 1:
 8.7 ↙ 9.9 → 10.4 * 10.3 * 10.8 *
 10.0 → 10.0 ↗ 10.4 * 10.0 ↖ 10.3 *
 beste Teiler 37.1 (5.) 133.8 (3.) 141.1 (8.)
 Trefferlage 0.63 mm rechts, 0.41 mm tief
 Streuwert 1.80, horizontal: 1.85, vertikal: 1.74

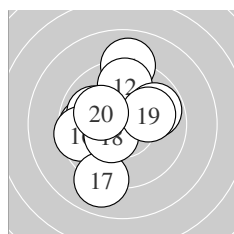

Serie 2:
 9.0 ↑ 9.7 ↑ 9.8 ← 9.8 → 10.0 ↖
 9.6 ← 9.0 ↓ 10.4 * 10.1 → 10.2 *
 beste Teiler 129.4 (18.) 199.9 (20.) 224.3 (19.)
 Trefferlage 0.78 mm links, 0.53 mm hoch
 Streuwert 2.29, horizontal: 2.06, vertikal: 2.49

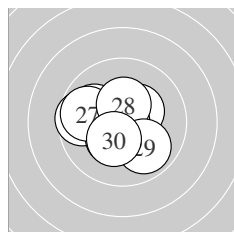

Serie 3:
 10.0 ↖ 10.4 * 10.7 * 10.9 * 9.6 ←
 10.3 * 9.8 ← 10.4 * 9.9 ↘ 10.3 *
 beste Teiler 10.4 (24.) 56.7 (23.) 144.2 (28.)
 Trefferlage 0.72 mm links, 0.01 mm hoch
 Streuwert 1.43, horizontal: 1.66, vertikal: 1.15

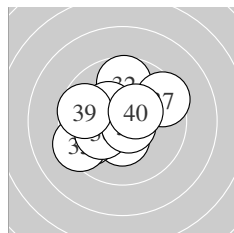

Serie 4:
 10.4 * 9.7 ↑ 9.7 ↙ 10.3 * 9.4 ↙
 10.2 * 9.5 ↗ 10.7 * 9.7 ↖ 10.4 *
 beste Teiler 61.4 (38.) 133.0 (40.) 144.0 (31.)
 Trefferlage 0.72 mm links, 0.15 mm hoch
 Streuwert 1.89, horizontal: 2.12, vertikal: 1.62

Unterschrift des Schützen

Meyton Elektronik

Ergebnis: **391** (409.2)
 Serien: 99 97 96 99
 Zähler: 31 9 0 0 0 0 0 0 0 0
 Innenzehner: 26
 weiteste: 482 (28), 411 (21), 327 (24)
 beste Teiler 12.3 (31.) 50.2 (26.) 52.4 (17.)
 Trefferlage 0.36 mm rechts, 0.01 mm hoch
 Streuwert 1.43, horizontal: 1.62, vertikal: 1.20

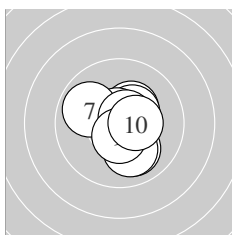
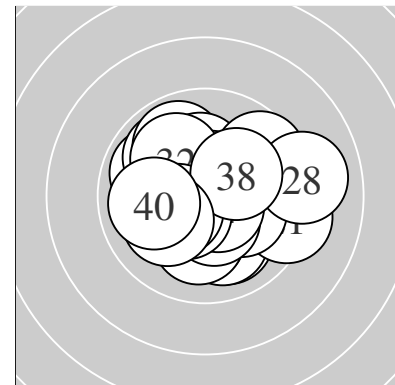

Serie 1:
 10.0 ↘ 10.4 * 10.5 * 10.4 * 10.0 ↘
 10.7 * 9.9 ↖ 10.7 * 10.5 * 10.4 *
 beste Teiler 66.7 (6.) 67.9 (8.) 103.0 (9.)
 Trefferlage 0.42 mm rechts, 0.08 mm tief
 Streuwert 1.18, horizontal: 1.12, vertikal: 1.24

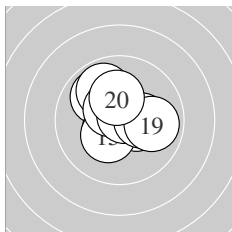

Serie 2:
 9.9 ↖ 9.9 ↖ 10.4 * 10.5 * 10.3 *
 10.5 * 10.7 * 10.2 * 9.9 → 10.2 *
 beste Teiler 52.4 (17.) 111.0 (14.) 115.1 (16.)
 Trefferlage 0.03 mm rechts, 0.47 mm hoch
 Streuwert 1.34, horizontal: 1.45, vertikal: 1.23

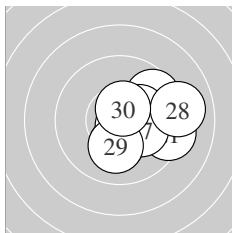

Serie 3:
 9.3 → 9.9 ↗ 10.2 * 9.6 ↗ 10.3 *
 10.8 * 10.2 * 9.0 → 10.1 ↓ 10.6 *
 beste Teiler 50.2 (26.) 97.8 (30.) 173.6 (25.)
 Trefferlage 1.69 mm rechts, 0.07 mm tief
 Streuwert 1.58, horizontal: 1.76, vertikal: 1.38

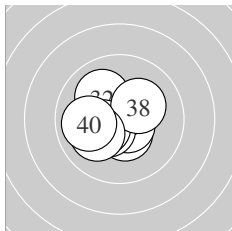

Serie 4:
 10.9 * 10.0 ↘ 10.5 * 10.6 * 10.2 *
 10.4 * 10.4 * 10.2 * 10.1 ↙ 9.9 ←
 beste Teiler 12.3 (31.) 81.2 (34.) 125.3 (33.)
 Trefferlage 0.70 mm links, 0.26 mm tief
 Streuwert 1.15, horizontal: 1.28, vertikal: 0.99

Unterschrift des Schützen

Meyton Elektronik

Ergebnis: **388** (407.0)
 Serien: 93 100 97 98
 Zähler: 30 9 0 1 0 0 0 0 0 0
 Innenzehner: 25
 weiteste: 843 (7), 452 (37), 413 (1)
 beste Teiler 38.3 (36.) 50.9 (38.) 52.1 (18.)
 Trefferlage 0.35 mm links, 0.89 mm hoch
 Streuwert 1.60, horizontal: 1.88, vertikal: 1.26

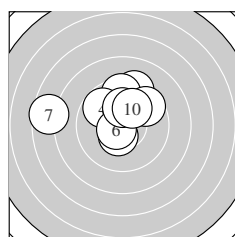
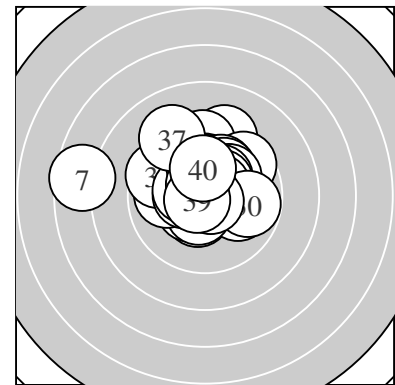

Serie 1:
 9.3 ↗ 9.5 ↑ 10.4 * 9.8 ↘ 10.3 *
 10.6 * 7.6 ← 9.6 ↗ 10.2 * 10.1 ↗
 beste Teiler 85.4 (6.) 131.8 (3.) 168.0 (5.)
 Trefferlage 0.69 mm links, 1.66 mm hoch
 Streuwert 2.39, horizontal: 2.98, vertikal: 1.58

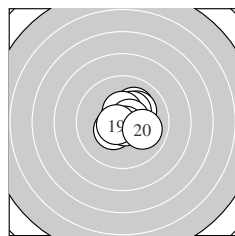

Serie 2:
 10.1 ↗ 10.4 * 10.1 ↗ 10.3 * 10.7 *
 10.5 * 10.6 * 10.7 * 10.6 * 10.0 →
 beste Teiler 52.1 (18.) 60.5 (15.) 76.3 (19.)
 Trefferlage 0.51 mm rechts, 0.39 mm hoch
 Streuwert 1.00, horizontal: 1.05, vertikal: 0.95

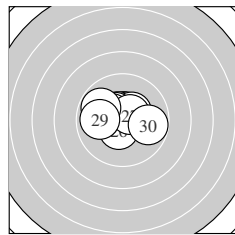

Serie 3:
 10.6 * 10.5 * 10.4 * 10.5 * 10.4 *
 10.5 * 10.5 * 9.8 ↘ 9.9 ← 9.8 →
 beste Teiler 99.2 (21.) 105.0 (27.) 107.7 (22.)
 Trefferlage 0.31 mm links, 0.49 mm hoch
 Streuwert 1.29, horizontal: 1.65, vertikal: 0.77

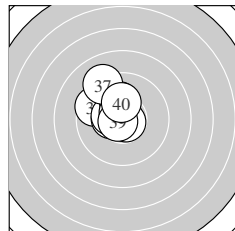

Serie 4:
 9.6 ↘ 10.4 * 10.4 * 10.1 ↑ 10.6 *
 10.8 * 9.1 ↘ 10.8 * 10.7 * 10.2 *
 beste Teiler 38.3 (36.) 50.9 (38.) 59.9 (39.)
 Trefferlage 0.91 mm links, 1.01 mm hoch
 Streuwert 1.21, horizontal: 1.09, vertikal: 1.32

Unterschrift des Schützen

Meyton Elektronik

Ergebnis: **390** (407.7)
 Serien: 98 98 97 97
 Zähler: 30 10 0 0 0 0 0 0 0 0
 Innenzehner: 24
 weiteste: 470 (2), 417 (35), 346 (32)
 beste Teiler 29.1 (12.) 44.2 (1.) 44.2 (13.)
 Trefferlage 0.16 mm links, 0.15 mm tief
 Streuwert 1.53, horizontal: 1.25, vertikal: 1.76

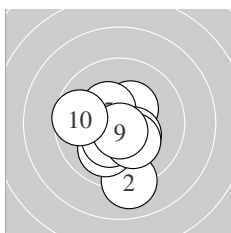
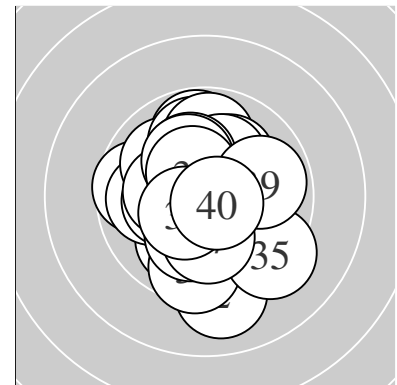

Serie 1:
 10.8 * 9.1 ↓ 10.4 * 10.0 ✓ 10.4 *
 10.4 * 10.3 * 10.2 * 10.7 * 9.7 ←
 beste Teiler 44.2 (1.) 63.0 (9.) 144.0 (5.)
 Trefferlage 0.25 mm links, 0.85 mm tief
 Streuwert 1.54, horizontal: 1.35, vertikal: 1.71

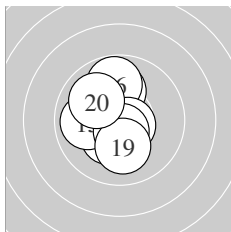

Serie 2:
 10.0 ↑ 10.8 * 10.8 * 10.3 * 9.9 ←
 9.8 ↑ 10.6 * 10.6 * 10.1 ↓ 10.0 ↘
 beste Teiler 29.1 (12.) 44.2 (13.) 77.6 (17.)
 Trefferlage 0.52 mm links, 0.15 mm hoch
 Streuwert 1.33, horizontal: 0.99, vertikal: 1.61

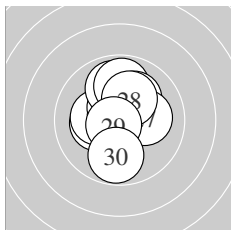

Serie 3:
 10.2 * 10.3 * 10.5 * 9.9 ↑ 9.9 ↑
 10.1 ↗ 10.1 → 10.2 * 10.7 * 9.8 ↓
 beste Teiler 60.6 (29.) 108.8 (23.) 174.3 (22.)
 Trefferlage 0.10 mm links, 0.67 mm hoch
 Streuwert 1.44, horizontal: 1.20, vertikal: 1.66

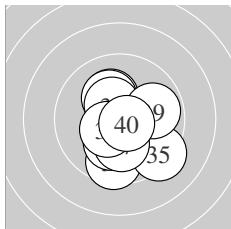

Serie 4:
 10.2 * 9.6 ↓ 10.2 * 10.2 * 9.3 ↘
 10.4 * 10.2 * 10.4 * 9.9 → 10.7 *
 beste Teiler 66.8 (40.) 128.4 (36.) 128.4 (38.)
 Trefferlage 0.22 mm rechts, 0.59 mm tief
 Streuwert 1.70, horizontal: 1.49, vertikal: 1.88

Unterschrift des Schützen