

Ergebnis: **386** (406.5)
 Serien: 96 97 96 97
 Zähler: 26 14 0 0 0 0 0 0 0 0
 Innenzehner: 24
 weiteste: 428 (12), 401 (39), 335 (23)
 beste Teiler 36.4 (35.) 57.4 (15.) 59.9 (29.)
 Trefferlage 0.10 mm rechts, 0.57 mm hoch
 Streuwert 1.53, horizontal: 1.81, vertikal: 1.18

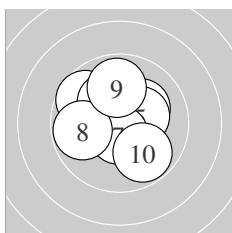

Serie 1:
 9.7 ↘ 10.2 * 10.5 * 10.5 * 10.3 *
 10.2 * 10.6 * 9.8 ← 9.9 ↑ 9.8 ↘
 beste Teiler 87.3 (7.) 101.1 (4.) 119.8 (3.)
 Trefferlage 0.02 mm rechts, 0.32 mm hoch
 Streuwert 1.59, horizontal: 1.69, vertikal: 1.48

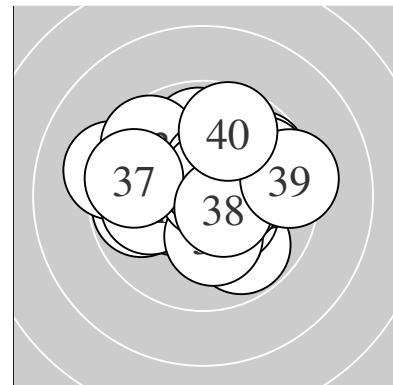
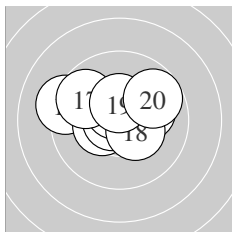

Serie 2:
 10.1 → 9.2 ↖ 10.4 * 10.3 * 10.7 *
 10.6 * 9.7 ↘ 10.4 * 10.4 * 9.7 →
 beste Teiler 57.4 (15.) 87.7 (16.) 129.0 (19.)
 Trefferlage 0.19 mm links, 0.68 mm hoch
 Streuwert 1.59, horizontal: 2.08, vertikal: 0.85

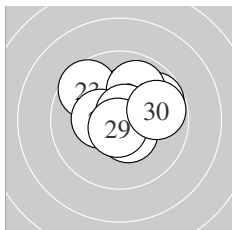

Serie 3:
 10.2 * 10.3 * 9.6 ↘ 9.8 → 9.9 ↗
 10.5 * 10.4 * 10.7 * 10.7 * 9.8 →
 beste Teiler 59.9 (29.) 62.4 (28.) 118.9 (26.)
 Trefferlage 0.26 mm rechts, 0.88 mm hoch
 Streuwert 1.46, horizontal: 1.72, vertikal: 1.14

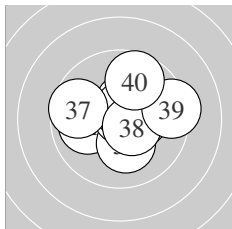

Serie 4:
 10.0 ← 10.4 * 10.4 * 10.2 * 10.8 *
 10.6 * 9.7 ← 10.5 * 9.3 → 9.7 ↑
 beste Teiler 36.4 (35.) 78.7 (36.) 107.9 (38.)
 Trefferlage 0.33 mm rechts, 0.39 mm hoch
 Streuwert 1.65, horizontal: 1.97, vertikal: 1.26

Unterschrift des Schützen

Meyton Elektronik

Ergebnis: **400** (417.6)
 Serien: 100 100 100 100
 Zähler: 40 0 0 0 0 0 0 0 0 0
 Innenzehner: 39
 weiteste: 235 (2), 200 (40), 195 (10)
 beste Teiler 39.5 (38.) 49.0 (37.) 57.0 (4.)
 Trefferlage 0.04 mm rechts, 0.00 mm
 Streuwert 0.98, horizontal: 1.07, vertikal: 0.88

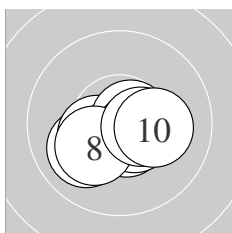
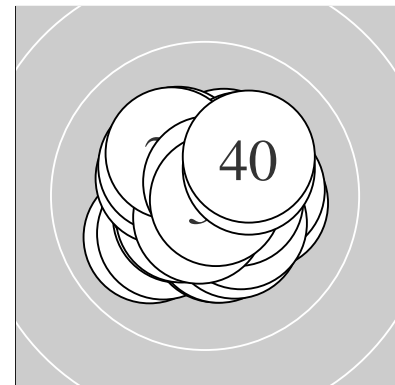

Serie 1:
 10.7 * 10.0 ↙ 10.4 * 10.7 * 10.6 *
 10.7 * 10.5 * 10.2 * 10.5 * 10.2 *
 beste Teiler 57.0 (4.) 61.6 (1.) 65.1 (6.)
 Trefferlage 0.06 mm rechts, 0.61 mm tief
 Streuwert 0.94, horizontal: 1.23, vertikal: 0.48

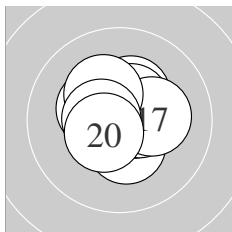

Serie 2:
 10.4 * 10.3 * 10.5 * 10.6 * 10.3 *
 10.5 * 10.2 * 10.3 * 10.5 * 10.5 *
 beste Teiler 98.7 (14.) 104.3 (19.) 110.5 (13.)
 Trefferlage 0.08 mm rechts, 0.36 mm hoch
 Streuwert 0.99, horizontal: 1.07, vertikal: 0.90

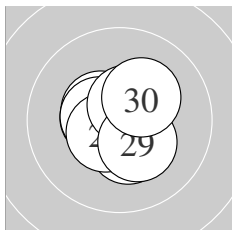

Serie 3:
 10.6 * 10.5 * 10.5 * 10.6 * 10.5 *
 10.4 * 10.5 * 10.6 * 10.3 * 10.2 *
 beste Teiler 83.2 (24.) 95.7 (28.) 99.4 (21.)
 Trefferlage 0.14 mm links, 0.11 mm tief
 Streuwert 0.92, horizontal: 0.94, vertikal: 0.91

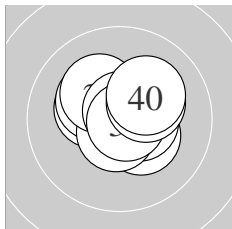

Serie 4:
 10.3 * 10.3 * 10.3 * 10.5 * 10.6 *
 10.2 * 10.8 * 10.8 * 10.3 * 10.2 *
 beste Teiler 39.5 (38.) 49.0 (37.) 76.6 (35.)
 Trefferlage 0.16 mm rechts, 0.38 mm hoch
 Streuwert 1.02, horizontal: 1.18, vertikal: 0.84

Unterschrift des Schützen

Ergebnis: **380** (401.1)
 Serien: 91 97 97 95
 Zähler: 22 16 2 0 0 0 0 0 0 0
 Innenzehner: 17
 weiteste: 543 (2), 522 (7), 372 (37)
 beste Teiler 52.9 (33.) 59.2 (24.) 74.5 (12.)
 Trefferlage 0.62 mm links, 0.11 mm hoch
 Streuwert 1.79, horizontal: 1.48, vertikal: 2.05

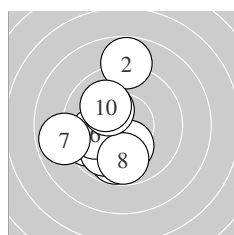
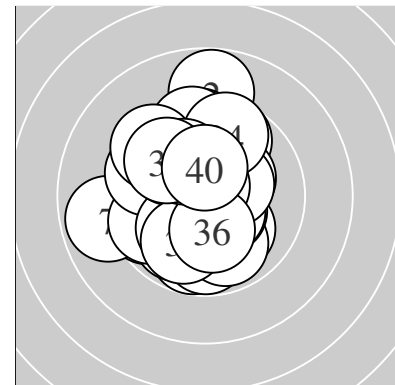

Serie 1:
 10.2 * 8.8 ↑ 9.8 ↓ 9.6 ↙ 9.9 ↘
 9.9 ← 8.9 ← 9.8 ↓ 10.2 * 10.1 ↘
 beste Teiler 179.6 (9.) 186.5 (1.) 224.6 (10.)
 Trefferlage 1.45 mm links, 0.46 mm tief
 Streuwert 2.20, horizontal: 1.71, vertikal: 2.60

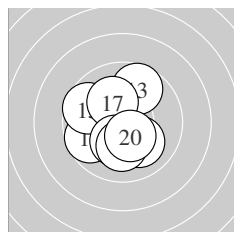

Serie 2:
 10.6 * 10.7 * 9.7 ↑ 9.7 ↙ 9.7 ↘
 10.1 ↘ 10.2 * 10.3 * 10.1 ↓ 10.4 *
 beste Teiler 74.5 (12.) 100.8 (11.) 138.3 (20.)
 Trefferlage 0.55 mm links, 0.13 mm tief
 Streuwert 1.61, horizontal: 1.51, vertikal: 1.70

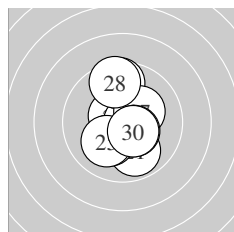

Serie 3:
 9.9 ↘ 10.6 * 10.2 * 10.7 * 10.1 ↘
 9.6 ↑ 10.3 * 9.5 ↑ 10.4 * 10.5 *
 beste Teiler 59.2 (24.) 93.8 (22.) 121.9 (30.)
 Trefferlage 0.08 mm rechts, 0.10 mm hoch
 Streuwert 1.62, horizontal: 1.04, vertikal: 2.04

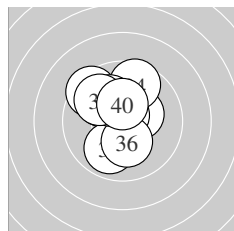

Serie 4:
 10.4 * 9.9 ↘ 10.7 * 9.6 ↑ 9.9 ↘
 10.2 * 9.5 ↘ 10.1 ↘ 9.9 ↘ 10.4 *
 beste Teiler 52.9 (33.) 148.0 (40.) 150.8 (31.)
 Trefferlage 0.59 mm links, 0.96 mm hoch
 Streuwert 1.59, horizontal: 1.37, vertikal: 1.79

Unterschrift des Schützen

Ergebnis: **386** (401.9)
 Serien: 99 97 94 96
 Zähler: 28 10 2 0 0 0 0 0 0 0
 Innenzehner: 19
 weiteste: 529 (27), 504 (36), 451 (37)
 beste Teiler 3.6 (4.) 59.0 (19.) 65.2 (12.)
 Trefferlage 0.20 mm links, 0.08 mm hoch
 Streuwert 1.81, horizontal: 1.90, vertikal: 1.72

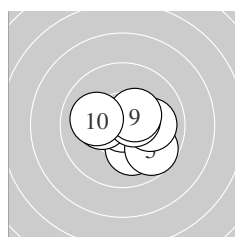
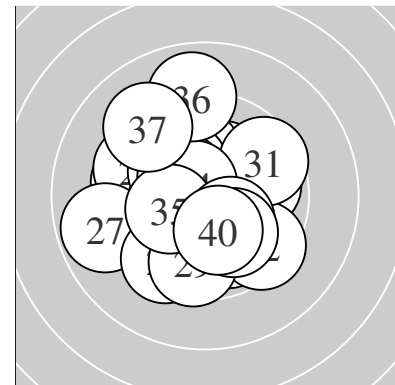

Serie 1:
 10.1 → 10.1 ↓ 10.4 * 10.9 * 9.7 ↘
 10.3 * 10.0 → 10.5 * 10.4 * 10.1 ←
 beste Teiler 3.6 (4.) 102.9 (8.) 128.0 (3.)
 Trefferlage 0.69 mm rechts, 0.24 mm tief
 Streuwert 1.32, horizontal: 1.58, vertikal: 0.98

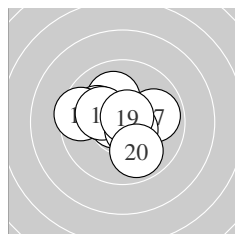

Serie 2:
 10.5 * 10.7 * 10.1 ↑ 10.0 ↖ 9.5 ←
 10.2 * 9.9 → 10.6 * 10.7 * 9.9 ↓
 beste Teiler 59.0 (19.) 65.2 (12.) 96.4 (18.)
 Trefferlage 0.28 mm links, 0.24 mm hoch
 Streuwert 1.53, horizontal: 1.83, vertikal: 1.15

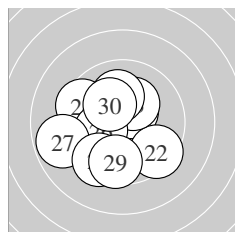

Serie 3:
 10.5 * 9.4 ↘ 10.2 * 9.5 ↖ 10.1 ↑
 10.2 * 8.8 ← 9.5 ↓ 9.6 ↓ 10.2 *
 beste Teiler 114.7 (21.) 177.3 (23.) 183.2 (30.)
 Trefferlage 0.98 mm links, 0.38 mm tief
 Streuwert 2.19, horizontal: 2.25, vertikal: 2.13

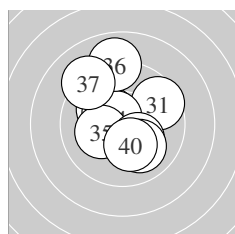

Serie 4:
 9.6 ↗ 10.1 ↖ 10.4 * 10.6 * 10.2 *
 8.9 ↑ 9.1 ↖ 10.2 * 10.0 ↘ 10.2 *
 beste Teiler 83.5 (34.) 149.4 (33.) 181.0 (38.)
 Trefferlage 0.24 mm links, 0.74 mm hoch
 Streuwert 2.03, horizontal: 1.79, vertikal: 2.25

Unterschrift des Schützen

Meyton Elektronik

Ergebnis: **380** (396.2)
 Serien: 95 95 94 96
 Zähler: 24 12 4 0 0 0 0 0 0 0
 Innenzehner: 20
 weiteste: 695 (12), 603 (1), 559 (38)
 beste Teiler 34.2 (33.) 37.1 (27.) 51.8 (16.)
 Trefferlage 0.17 mm rechts, 0.25 mm tief
 Streuwert 2.21, horizontal: 2.65, vertikal: 1.65

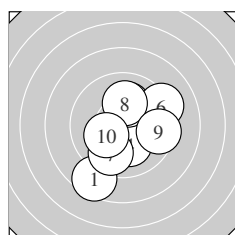
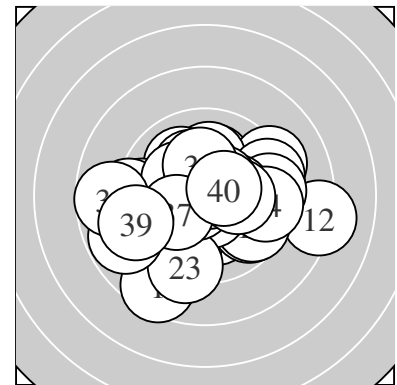

Serie 1:
 8.5 ↘ 10.3 * 10.4 * 10.1 ↘ 10.1 ↑
 9.2 ↗ 9.8 ↘ 10.1 ↑ 9.5 → 10.2 *
 beste Teiler 137.2 (3.) 158.5 (2.) 191.2 (10.)
 Trefferlage 0.56 mm rechts, 0.70 mm tief
 Streuwert 2.25, horizontal: 2.12, vertikal: 2.37

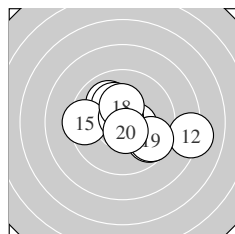

Serie 2:
 10.0 ↖ 8.2 → 10.5 * 10.2 * 9.4 ←
 10.7 * 9.7 ↘ 10.3 * 9.6 ↘ 10.6 *
 beste Teiler 51.8 (16.) 92.9 (20.) 125.4 (13.)
 Trefferlage 0.74 mm rechts, 0.02 mm tief
 Streuwert 2.27, horizontal: 2.89, vertikal: 1.41

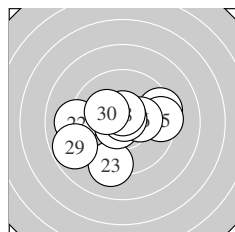

Serie 3:
 9.4 → 9.1 ← 9.2 ↓ 10.7 * 9.4 →
 10.2 * 10.8 * 10.6 * 8.8 ← 10.2 *
 beste Teiler 37.1 (27.) 70.2 (24.) 88.0 (28.)
 Trefferlage 0.31 mm links, 0.30 mm tief
 Streuwert 2.41, horizontal: 2.95, vertikal: 1.70

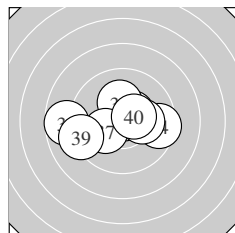

Serie 4:
 10.5 * 10.6 * 10.8 * 9.5 → 10.2 *
 10.2 * 10.2 * 8.7 ← 9.2 ← 10.5 *
 beste Teiler 34.2 (33.) 94.5 (32.) 121.6 (40.)
 Trefferlage 0.30 mm links, 0.04 mm hoch
 Streuwert 2.09, horizontal: 2.80, vertikal: 0.96

Unterschrift des Schützen

Ergebnis: **380** (396.4)
 Serien: 95 94 96 95
 Zähler: 20 20 0 0 0 0 0 0 0 0
 Innenzehner: 11
 weiteste: 462 (3), 410 (2), 399 (7)
 beste Teiler 17.0 (39.) 102.8 (6.) 129.6 (4.)
 Trefferlage 0.12 mm rechts, 0.87 mm hoch
 Streuwert 1.88, horizontal: 2.16, vertikal: 1.56

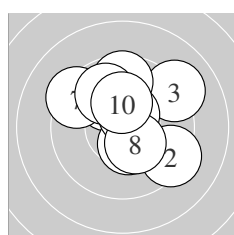
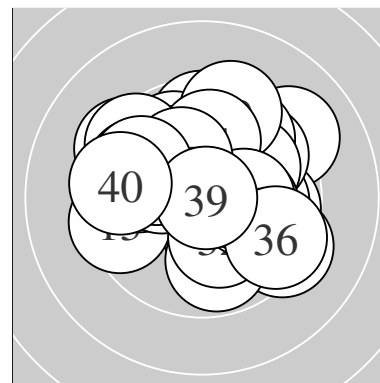

Serie 1:
 10.1 ↘ 9.3 ↘ 9.1 ↗ 10.4 * 9.6 ↑
 10.5 * 9.4 ↘ 10.4 * 9.9 ↘ 10.2 *
 beste Teiler 102.8 (6.) 129.6 (4.) 148.6 (8.)
 Trefferlage 0.33 mm rechts, 1.07 mm hoch
 Streuwert 2.02, horizontal: 2.13, vertikal: 1.90

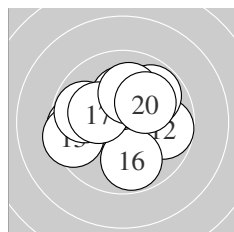

Serie 2:
 9.6 ← 9.8 → 9.5 ← 10.2 * 9.8 ↖
 9.8 ↓ 10.2 * 9.8 ↗ 10.1 ↑ 10.1 ↗
 beste Teiler 184.0 (14.) 189.0 (17.) 215.7 (19.)
 Trefferlage 0.37 mm links, 0.41 mm hoch
 Streuwert 1.99, horizontal: 2.35, vertikal: 1.56

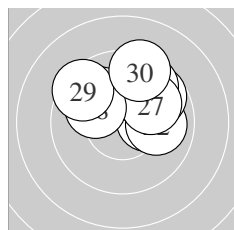

Serie 3:
 10.2 * 10.0 → 10.0 ↗ 10.0 ↘ 9.7 ↗
 9.7 ↗ 10.0 ↗ 10.1 ↘ 9.5 ↘ 9.4 ↑
 beste Teiler 179.2 (21.) 224.5 (28.) 243.4 (24.)
 Trefferlage 0.69 mm rechts, 1.65 mm hoch
 Streuwert 1.66, horizontal: 2.03, vertikal: 1.16

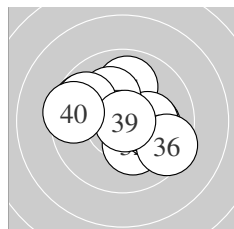

Serie 4:
 9.7 ↖ 10.2 * 10.1 → 9.9 ↑ 10.2 *
 9.5 ↘ 10.2 * 9.8 ↘ 10.9 * 9.5 ←
 beste Teiler 17.0 (39.) 183.2 (35.) 185.3 (32.)
 Trefferlage 0.16 mm links, 0.35 mm hoch
 Streuwert 1.90, horizontal: 2.29, vertikal: 1.40

Unterschrift des Schützen

Meyton Elektronik

Ergebnis: **365** (383.3)
 Serien: 91 89 95 90
 Zähler: 19 9 11 0 1 0 0 0 0 0
 Innenzehner: 16
 weiteste: 1050 (32), 730 (7), 709 (19)
 beste Teiler 76.2 (17.) 79.1 (40.) 92.3 (1.)
 Trefferlage 1.17 mm rechts, 0.48 mm tief
 Streuwert 2.78, horizontal: 3.44, vertikal: 1.89

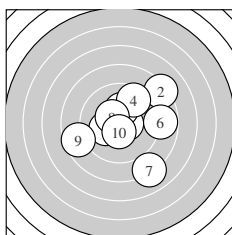
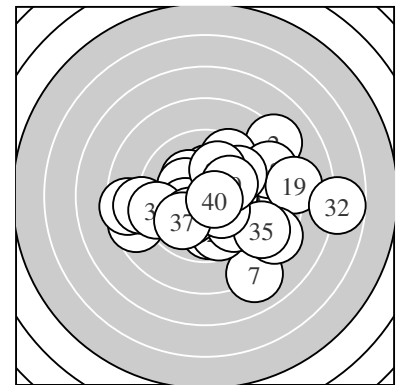

Serie 1:
 10.6 * 8.2 ↗ 10.2 * 9.5 ↗ 10.2 *
 8.8 → 8.0 ↘ 10.4 * 8.6 ← 10.5 *
 beste Teiler 92.3 (1.) 113.2 (10.) 129.7 (8.)
 Trefferlage 0.94 mm rechts, 0.02 mm tief
 Streuwert 3.16, horizontal: 3.39, vertikal: 2.90

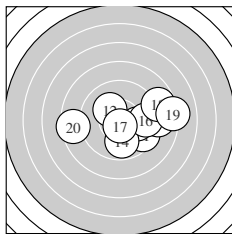

Serie 2:
 9.5 ↘ 10.2 * 10.0 → 9.8 ↓ 8.9 →
 9.6 → 10.6 * 8.8 → 8.1 → 8.5 ←
 beste Teiler 76.2 (17.) 188.9 (12.) 237.3 (13.)
 Trefferlage 1.90 mm rechts, 0.24 mm tief
 Streuwert 2.89, horizontal: 3.82, vertikal: 1.46

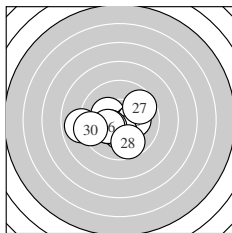

Serie 3:
 10.3 * 10.4 * 10.2 * 10.3 * 10.3 *
 10.2 * 9.7 ↗ 9.7 ↘ 8.9 ← 9.4 ←
 beste Teiler 150.2 (22.) 157.2 (25.) 165.3 (24.)
 Trefferlage 0.61 mm links, 0.61 mm tief
 Streuwert 1.99, horizontal: 2.51, vertikal: 1.26

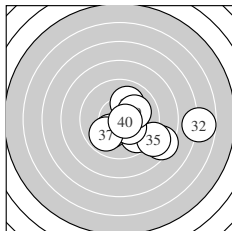

Serie 4:
 9.7 ↘ 6.8 → 10.2 * 8.4 ↘ 8.9 ↘
 10.3 * 9.9 ↗ 10.0 ↑ 10.1 → 10.6 *
 beste Teiler 79.1 (40.) 170.4 (36.) 198.6 (33.)
 Trefferlage 2.47 mm rechts, 1.06 mm tief
 Streuwert 2.79, horizontal: 3.59, vertikal: 1.63

Unterschrift des Schützen

Meyton Elektronik

Ergebnis: **374** (392.4)
 Serien: 95 95 92 92
 Zähler: 16 22 2 0 0 0 0 0 0 0
 Innenzehner: 10
 weiteste: 534 (37), 508 (21), 478 (12)
 beste Teiler 35.0 (6.) 43.0 (1.) 107.9 (26.)
 Trefferlage 0.17 mm links, 0.13 mm hoch
 Streuwert 2.20, horizontal: 2.59, vertikal: 1.73

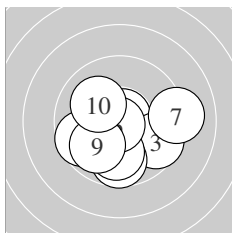
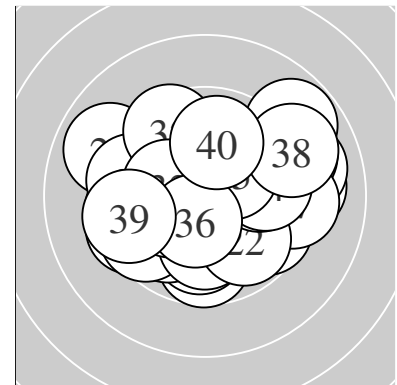

Serie 1:
 10.8 * 10.1 ↙ 9.6 ↘ 9.7 ↓ 10.0 ↓
 10.8 * 9.1 → 9.6 ← 9.9 ↗ 10.1 ↖
 beste Teiler 35.0 (6.) 43.0 (1.) 201.1 (2.)
 Trefferlage 0.03 mm links, 1.02 mm tief
 Streuwert 1.89, horizontal: 2.25, vertikal: 1.44

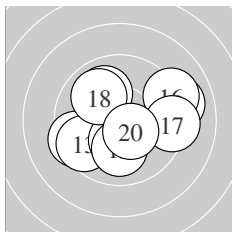

Serie 2:
 9.4 ← 9.0 → 9.6 ← 10.3 * 10.0 ↖
 9.1 → 9.3 → 10.0 ↘ 10.0 ↓ 10.4 *
 beste Teiler 126.5 (20.) 160.9 (14.) 226.0 (19.)
 Trefferlage 0.43 mm rechts, 0.12 mm tief
 Streuwert 2.44, horizontal: 2.97, vertikal: 1.76

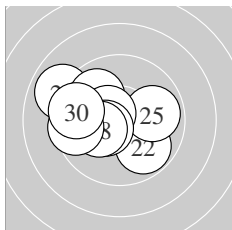

Serie 3:
 8.9 ↖ 9.8 ↘ 9.9 ↖ 9.9 ↖ 9.9 →
 10.5 * 10.4 * 10.2 * 9.5 ← 9.5 ←
 beste Teiler 107.9 (26.) 131.2 (27.) 178.1 (28.)
 Trefferlage 1.50 mm links, 0.30 mm hoch
 Streuwert 1.87, horizontal: 2.30, vertikal: 1.31

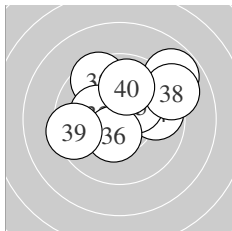

Serie 4:
 9.7 ↖ 9.5 ↖ 10.2 * 9.8 → 10.3 *
 10.4 * 8.8 ↗ 9.1 → 9.4 ← 9.9 ↑
 beste Teiler 128.8 (36.) 168.6 (35.) 181.2 (33.)
 Trefferlage 0.40 mm rechts, 1.39 mm hoch
 Streuwert 2.23, horizontal: 2.68, vertikal: 1.65

Unterschrift des Schützen

Meyton Elektronik

Ergebnis: **393** (411.4)
 Serien: 99 97 99 98
 Zähler: 33 7 0 0 0 0 0 0 0 0
 Innenzehner: 24
 weiteste: 305 (39), 285 (27), 279 (5)
 beste Teiler 6.4 (24.) 28.2 (33.) 32.7 (35.)
 Trefferlage 0.26 mm rechts, 0.23 mm hoch
 Streuwert 1.30, horizontal: 1.21, vertikal: 1.38

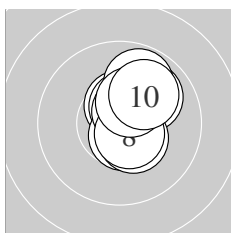
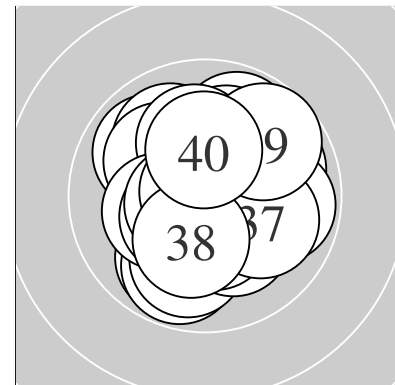

Serie 1:
 10.5 * 10.5 * 10.6 * 10.0 ↗ 9.8 ↗
 10.6 * 10.4 * 10.6 * 10.3 * 10.0 ↗
 beste Teiler 82.8 (3.) 87.1 (6.) 91.9 (8.)
 Trefferlage 0.77 mm rechts, 0.78 mm hoch
 Streuwert 0.95, horizontal: 0.60, vertikal: 1.20

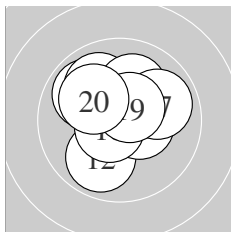

Serie 2:
 9.9 ↘ 9.9 ↙ 10.0 ↖ 10.8 * 10.1 ↗
 10.4 * 9.9 → 10.6 * 10.5 * 10.1 ↖
 beste Teiler 45.3 (14.) 78.8 (18.) 103.8 (19.)
 Trefferlage 0.13 mm links, 0.59 mm hoch
 Streuwert 1.42, horizontal: 1.46, vertikal: 1.37

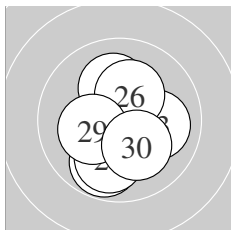

Serie 3:
 10.7 * 10.7 * 10.0 → 10.9 * 10.1 ↑
 10.3 * 9.8 ↙ 10.0 ↓ 10.2 * 10.2 *
 beste Teiler 6.4 (24.) 64.3 (21.) 68.4 (22.)
 Trefferlage 0.07 mm links, 0.32 mm tief
 Streuwert 1.37, horizontal: 1.15, vertikal: 1.57

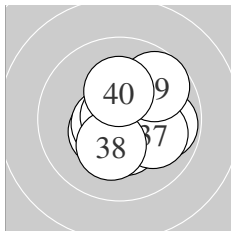

Serie 4:
 10.4 * 10.6 * 10.8 * 9.8 → 10.8 *
 10.4 * 10.0 → 10.3 * 9.7 ↗ 10.2 *
 beste Teiler 28.2 (33.) 32.7 (35.) 91.0 (32.)
 Trefferlage 0.47 mm rechts, 0.11 mm tief
 Streuwert 1.32, horizontal: 1.39, vertikal: 1.24

Unterschrift des Schützen

Meyton Elektronik

Ergebnis: **391** (411.7)
 Serien: 95 99 98 99
 Zähler: 31 9 0 0 0 0 0 0 0 0
 Innenzehner: 25
 weiteste: 405 (1), 395 (2), 304 (4)
 beste Teiler 23.0 (23.) 41.2 (6.) 50.2 (18.)
 Trefferlage 0.60 mm rechts, 0.01 mm tief
 Streuwert 1.30, horizontal: 1.59, vertikal: 0.93

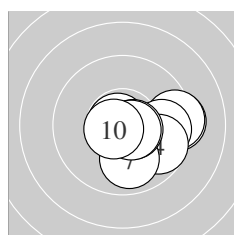
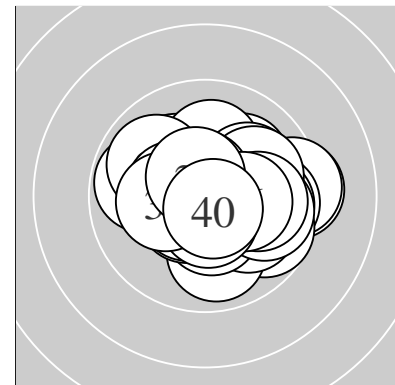

Serie 1:
 9.3 → 9.4 → 9.8 → 9.7 ↘ 10.6 *
 10.8 * 9.9 ↓ 10.6 * 10.7 * 10.7 *
 beste Teiler 41.2 (6.) 73.0 (10.) 74.7 (9.)
 Trefferlage 1.49 mm rechts, 0.51 mm tief
 Streuwert 1.38, horizontal: 1.74, vertikal: 0.88

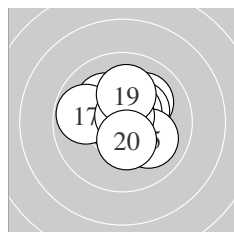

Serie 2:
 10.1 ↗ 10.3 * 10.2 * 10.5 * 10.0 ↘
 10.7 * 9.8 ← 10.8 * 10.1 ↑ 10.4 *
 beste Teiler 50.2 (18.) 61.6 (16.) 105.4 (14.)
 Trefferlage 0.16 mm rechts, 0.53 mm hoch
 Streuwert 1.27, horizontal: 1.42, vertikal: 1.11

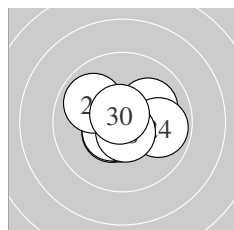

Serie 3:
 10.4 * 10.1 ↗ 10.9 * 9.9 → 10.5 *
 10.6 * 10.5 * 10.6 * 9.9 ↖ 10.7 *
 beste Teiler 23.0 (23.) 63.3 (30.) 79.1 (28.)
 Trefferlage 0.19 mm rechts, 0.06 mm tief
 Streuwert 1.17, horizontal: 1.44, vertikal: 0.81

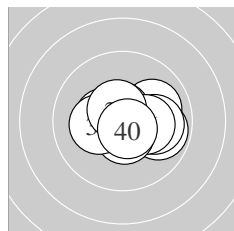

Serie 4:
 10.0 → 10.4 * 9.8 → 10.7 * 10.0 →
 10.3 * 10.5 * 10.2 * 10.6 * 10.7 *
 beste Teiler 68.2 (40.) 73.0 (34.) 96.1 (39.)
 Trefferlage 0.57 mm rechts, 0.03 mm tief
 Streuwert 1.22, horizontal: 1.59, vertikal: 0.67

Unterschrift des Schützen

Ergebnis: **383** (398.5)
 Serien: 96 96 96 95
 Zähler: 23 17 0 0 0 0 0 0 0 0
 Innenzehner: 12
 weiteste: 397 (28), 384 (22), 372 (7)
 beste Teiler 109.6 (24.) 111.0 (16.) 119.6 (27.)
 Trefferlage 0.46 mm rechts, 0.52 mm tief
 Streuwert 1.81, horizontal: 2.08, vertikal: 1.48

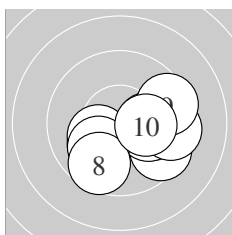
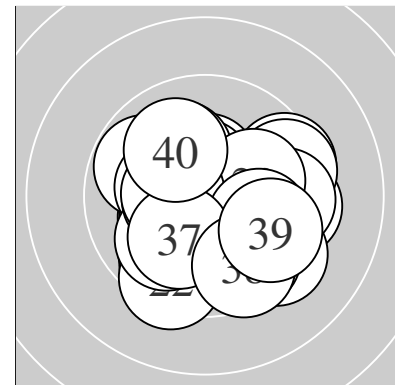

Serie 1:
 10.1 ↙ 10.2 * 9.5 ↘ 10.1 → 10.1 →
 10.0 ↙ 9.5 → 9.6 ↙ 9.5 → 10.2 *
 beste Teiler 179.3 (2.) 190.5 (10.) 203.0 (4.)
 Trefferlage 1.00 mm rechts, 0.87 mm tief
 Streuwert 1.80, horizontal: 2.25, vertikal: 1.20

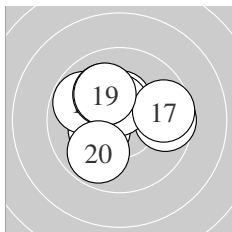

Serie 2:
 10.2 * 10.4 * 10.3 * 9.6 → 9.8 ↘
 10.5 * 9.7 → 10.1 ↘ 10.1 ↘ 9.8 ↙
 beste Teiler 111.0 (16.) 133.1 (12.) 163.6 (13.)
 Trefferlage 0.31 mm links, 0.55 mm hoch
 Streuwert 1.70, horizontal: 2.02, vertikal: 1.29

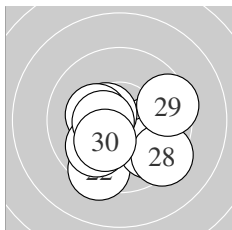

Serie 3:
 10.1 → 9.4 ↙ 9.8 ↘ 10.5 * 10.3 *
 10.0 ↙ 10.5 * 9.4 ↘ 9.5 → 10.2 *
 beste Teiler 109.6 (24.) 119.6 (27.) 172.2 (25.)
 Trefferlage 0.27 mm rechts, 1.01 mm tief
 Streuwert 1.84, horizontal: 2.14, vertikal: 1.49

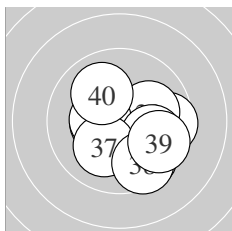

Serie 4:
 9.6 → 10.4 * 10.1 → 9.7 ↘ 10.4 *
 9.9 → 10.1 ↙ 9.6 ↘ 9.7 ↘ 10.0 ↘
 beste Teiler 136.8 (32.) 140.3 (35.) 209.7 (37.)
 Trefferlage 0.91 mm rechts, 0.75 mm tief
 Streuwert 1.76, horizontal: 1.95, vertikal: 1.54

Unterschrift des Schützen

Ergebnis: **384** (402.6)
 Serien: 96 95 97 96
 Zähler: 24 16 0 0 0 0 0 0 0 0
 Innenzehner: 17
 weiteste: 427 (17), 388 (32), 383 (11)
 beste Teiler 38.6 (37.) 45.1 (13.) 59.8 (14.)
 Trefferlage 0.26 mm links, 0.19 mm tief
 Streuwert 1.75, horizontal: 2.09, vertikal: 1.31

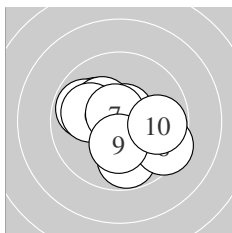
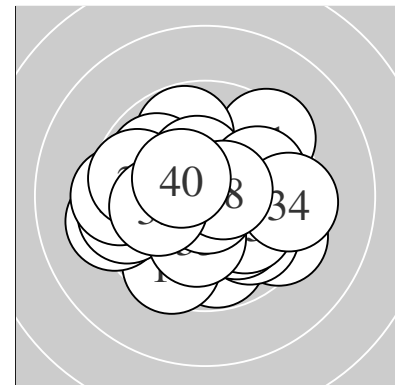

Serie 1:
 9.8 ↓ 10.1 ↖ 9.8 ↖ 10.7 * 10.3 *
 10.0 ↖ 10.7 * 9.4 ↘ 10.3 * 9.8 →
 beste Teiler 67.2 (7.) 68.6 (4.) 171.1 (9.)
 Trefferlage 0.12 mm links, 0.16 mm tief
 Streuwert 1.75, horizontal: 2.01, vertikal: 1.44

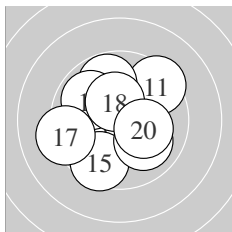

Serie 2:
 9.4 ↗ 9.8 ↗ 10.8 * 10.7 * 9.6 ↘
 9.9 ↖ 9.2 ← 10.4 * 10.0 ↘ 10.2 *
 beste Teiler 45.1 (13.) 59.8 (14.) 144.5 (18.)
 Trefferlage 0.33 mm links, 0.11 mm hoch
 Streuwert 1.99, horizontal: 2.07, vertikal: 1.91

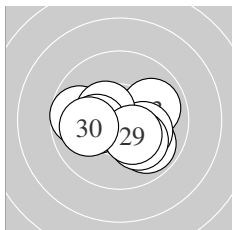

Serie 3:
 9.7 ← 10.6 * 9.9 → 9.9 ↘ 10.2 *
 10.4 * 10.3 * 10.1 ↘ 10.4 * 10.0 ←
 beste Teiler 96.2 (22.) 128.4 (26.) 147.4 (29.)
 Trefferlage 0.14 mm rechts, 0.40 mm tief
 Streuwert 1.55, horizontal: 1.99, vertikal: 0.93

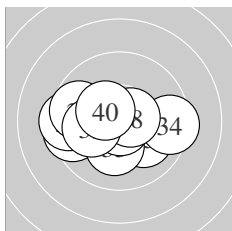

Serie 4:
 9.5 ← 9.4 ← 10.1 ↘ 9.4 → 10.2 *
 9.7 ← 10.8 * 10.6 * 10.1 ← 10.4 *
 beste Teiler 38.6 (37.) 87.2 (38.) 134.4 (40.)
 Trefferlage 0.75 mm links, 0.32 mm tief
 Streuwert 1.86, horizontal: 2.49, vertikal: 0.86

Unterschrift des Schützen

Meyton Elektronik

Ergebnis: **370** (389.9)
 Serien: 91 94 93 92
 Zähler: 15 20 5 0 0 0 0 0 0 0
 Innenzehner: 8
 weiteste: 653 (14), 625 (38), 557 (34)
 beste Teiler 39.4 (20.) 63.5 (27.) 96.7 (17.)
 Trefferlage 0.11 mm rechts, 0.85 mm hoch
 Streuwert 2.32, horizontal: 2.19, vertikal: 2.44

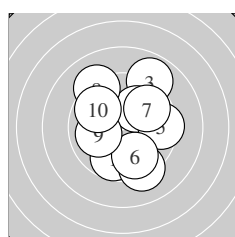
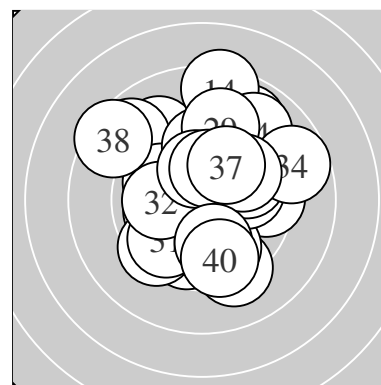

Serie 1:
 9.7 ↘ 9.2 ↘ 8.9 ↗ 10.1 ↗ 9.5 →
 9.8 ↘ 9.8 ↗ 9.2 ↘ 10.0 ← 9.8 ↘
 beste Teiler 220.4 (4.) 240.6 (9.) 295.0 (10.)
 Trefferlage 0.49 mm rechts, 0.33 mm hoch
 Streuwert 2.61, horizontal: 2.32, vertikal: 2.87

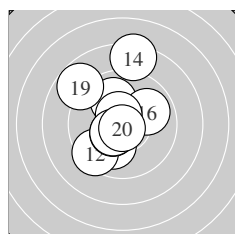

Serie 2:
 10.0 ↘ 9.4 ↗ 10.0 ↖ 8.3 ↑ 10.4 *
 9.9 ↗ 10.6 * 10.5 * 8.8 ↘ 10.8 *
 beste Teiler 39.4 (20.) 96.7 (17.) 122.5 (18.)
 Trefferlage 0.74 mm links, 0.75 mm hoch
 Streuwert 2.33, horizontal: 1.77, vertikal: 2.78

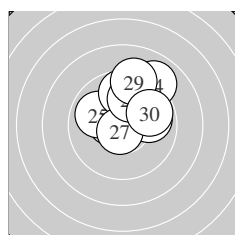

Serie 3:
 10.5 * 9.9 → 10.1 ↑ 9.0 ↗ 9.9 ↖
 9.7 ↑ 10.7 * 9.9 ↑ 9.2 ↑ 9.8 →
 beste Teiler 63.5 (27.) 118.6 (21.) 215.0 (23.)
 Trefferlage 0.60 mm rechts, 1.84 mm hoch
 Streuwert 1.67, horizontal: 1.73, vertikal: 1.61

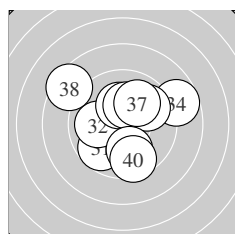

Serie 4:
 9.7 ↗ 10.0 ← 10.2 * 8.7 → 9.8 ↗
 10.2 * 10.0 ↗ 8.5 ↘ 9.9 ↓ 9.5 ↓
 beste Teiler 182.3 (33.) 185.3 (36.) 239.0 (32.)
 Trefferlage 0.10 mm rechts, 0.46 mm hoch
 Streuwert 2.61, horizontal: 2.84, vertikal: 2.36

Unterschrift des Schützen

Meyton Elektronik

Ergebnis:	375	(394.0)
Serien:	93 90 95 97	
Zähler:	21 15 2 2 0 0 0 0 0 0	
Innenzehner:	11	
weiteste:	861 (15), 776 (11), 638 (13)	
beste Teiler	20.0 (26.) 56.8 (21.) 68.0 (39.)	
Trefferlage	0.64 mm rechts, 0.42 mm tief	
Streuwert	2.28, horizontal: 2.95, vertikal: 1.29	

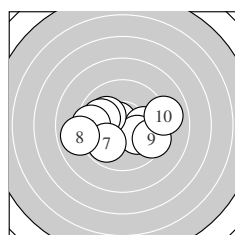
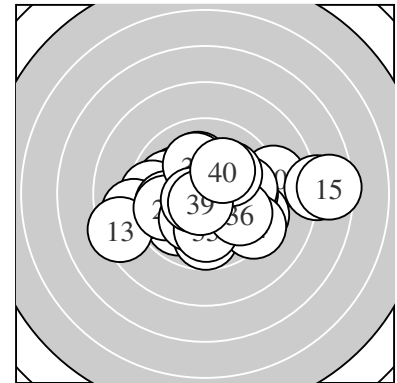

Serie 1:	10.6 *	10.0 →	10.1 ↘	10.1 ↖	9.9 ←
	9.5 ←	9.9 ↙	8.9 ←	9.5 →	9.0 →
beste Teiler	79.4 (1.) 202.1 (3.) 213.7 (4.)				
Trefferlage	0.32 mm links, 0.24 mm tief				
Streuwert	2.41, horizontal: 3.21, vertikal: 1.14				

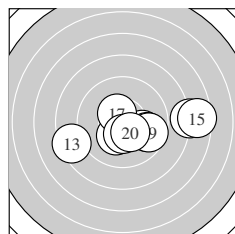

Serie 2:	7.8 →	10.0 ↘	8.4 ←	9.7 ↘	7.5 →
	10.3 *	10.5 *	10.4 *	9.7 →	10.4 *
beste Teiler	119.2 (17.) 136.0 (18.) 145.6 (20.)				
Trefferlage	1.80 mm rechts, 0.78 mm tief				
Streuwert	3.08, horizontal: 4.22, vertikal: 1.08				

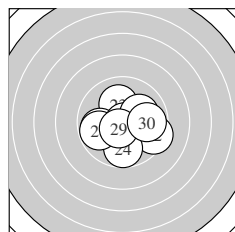

Serie 3:	10.7 *	9.4 ↘	10.1 ↑	9.7 ↓	9.9 ←
	10.9 *	10.1 →	9.8 ←	10.6 *	9.8 →
beste Teiler	20.0 (26.) 56.8 (21.) 85.2 (29.)				
Trefferlage	0.19 mm rechts, 0.33 mm tief				
Streuwert	1.76, horizontal: 2.07, vertikal: 1.39				

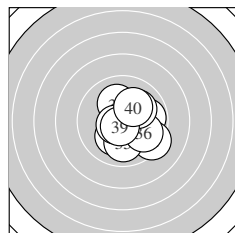

Serie 4:	10.2 *	9.8 →	10.1 ↑	9.3 ↘	10.0 ↓
	9.9 ↘	10.6 *	10.1 ↗	10.7 *	10.1 ↗
beste Teiler	68.0 (39.) 91.6 (37.) 197.8 (31.)				
Trefferlage	0.87 mm rechts, 0.33 mm tief				
Streuwert	1.63, horizontal: 1.62, vertikal: 1.63				

Unterschrift des Schützen

Ergebnis: **362** (378.7)
 Serien: 90 87 92 93
 Zähler: 12 21 6 0 0 1 0 0 0 0
 Innenzehner: 9
 weiteste: 1480 (20), 724 (10), 702 (11)
 beste Teiler 61.2 (26.) 101.3 (8.) 106.9 (15.)
 Trefferlage 1.17 mm rechts, 0.54 mm hoch
 Streuwert 3.03, horizontal: 3.56, vertikal: 2.39

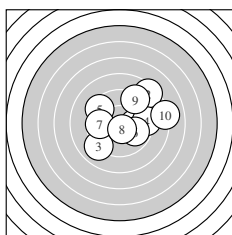
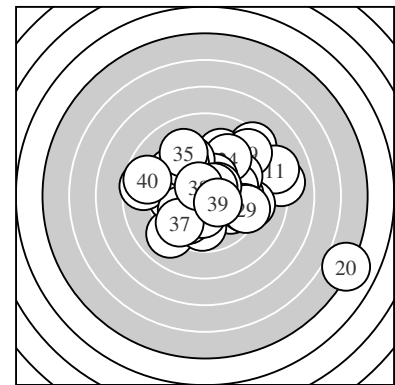

Serie 1:
 10.0 → 8.4 ↗ 9.0 ↙ 9.3 → 9.4 ↖
 9.9 ↘ 9.7 ← 10.5 * 9.2 ↗ 8.1 →
 beste Teiler 101.3 (8.) 232.2 (1.) 272.9 (6.)
 Trefferlage 1.38 mm rechts, 0.61 mm hoch
 Streuwert 3.08, horizontal: 3.60, vertikal: 2.44

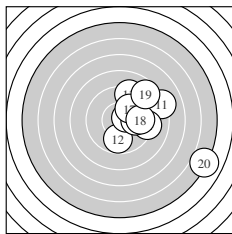

Serie 2:
 8.1 → 9.8 ↓ 9.2 ↑ 9.2 → 10.5 *
 10.0 → 10.0 ↗ 9.7 → 8.7 ↗ 5.0 ↘
 beste Teiler 106.9 (15.) 237.6 (17.) 245.1 (16.)
 Trefferlage 3.76 mm rechts, 0.24 mm hoch
 Streuwert 3.56, horizontal: 3.86, vertikal: 3.24

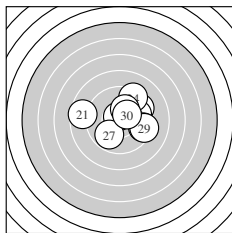

Serie 3:
 8.6 ← 9.5 ↗ 9.8 → 9.3 ↗ 9.4 →
 10.7 * 9.8 ↙ 10.2 * 9.3 → 10.4 *
 beste Teiler 61.2 (26.) 144.2 (30.) 189.6 (28.)
 Trefferlage 0.97 mm rechts, 0.57 mm hoch
 Streuwert 2.41, horizontal: 2.95, vertikal: 1.71

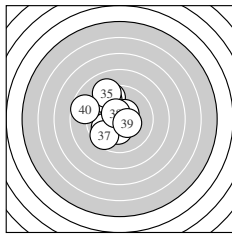

Serie 4:
 10.3 * 9.5 ↖ 9.5 ↖ 9.9 ↙ 9.1 ↖
 10.5 * 9.6 ↙ 10.5 * 10.4 * 8.7 ←
 beste Teiler 107.6 (38.) 113.1 (36.) 135.0 (39.)
 Trefferlage 1.40 mm links, 0.75 mm hoch
 Streuwert 2.08, horizontal: 1.88, vertikal: 2.27

Unterschrift des Schützen

Meyton Elektronik

Ergebnis: **372** (393.0)
 Serien: 95 95 95 87
 Zähler: 21 12 6 0 1 0 0 0 0 0
 Innenzehner: 15
 weiteste: 1089 (32), 603 (10), 583 (39)
 beste Teiler 34.7 (6.) 52.3 (25.) 66.2 (16.)
 Trefferlage 0.51 mm rechts, 0.03 mm tief
 Streuwert 2.45, horizontal: 3.08, vertikal: 1.58

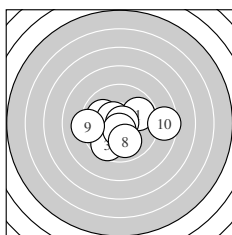
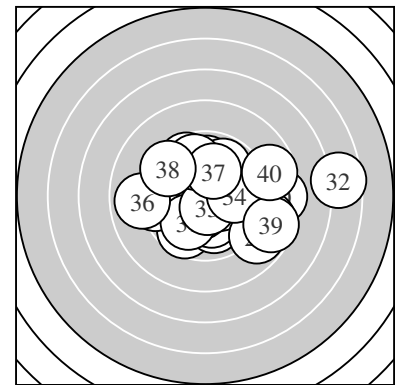

Serie 1:
 9.8 ↗ 10.5 * 9.6 ↘ 10.0 ↖ 10.5 *
 10.8 * 10.6 * 10.0 ↓ 9.2 ← 8.5 →
 beste Teiler 34.7 (6.) 91.0 (7.) 108.0 (5.)
 Trefferlage 0.03 mm links, 0.43 mm tief
 Streuwert 2.20, horizontal: 2.81, vertikal: 1.34

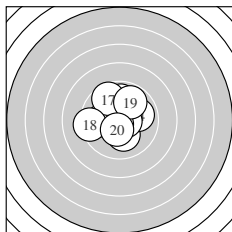

Serie 2:
 10.1 ↓ 9.9 ↑ 10.1 ← 9.9 → 10.6 *
 10.7 * 9.6 ↘ 9.3 ← 9.8 ↗ 10.4 *
 beste Teiler 66.2 (16.) 80.4 (15.) 132.6 (20.)
 Trefferlage 0.31 mm links, 0.40 mm hoch
 Streuwert 1.79, horizontal: 1.88, vertikal: 1.70

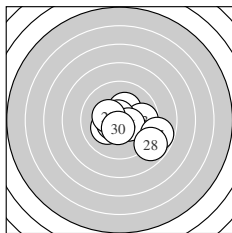

Serie 3:
 10.3 * 10.2 * 9.8 → 10.6 * 10.7 *
 10.4 * 8.8 ↘ 8.8 ↘ 10.3 * 10.5 *
 beste Teiler 52.3 (25.) 98.4 (24.) 108.0 (30.)
 Trefferlage 0.96 mm rechts, 0.57 mm tief
 Streuwert 1.92, horizontal: 2.37, vertikal: 1.34

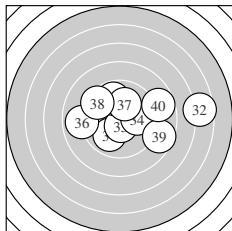

Serie 4:
 9.9 ↘ 6.6 → 10.6 * 10.0 → 9.8 ↖
 8.9 ← 10.1 ↑ 9.5 ↘ 8.6 ↘ 8.7 →
 beste Teiler 93.7 (33.) 212.1 (37.) 238.1 (34.)
 Trefferlage 1.43 mm rechts, 0.44 mm hoch
 Streuwert 3.55, horizontal: 4.67, vertikal: 1.85

Unterschrift des Schützen

Ergebnis: **393** (410.9)
 Serien: 98 97 98 100
 Zähler: 34 5 1 0 0 0 0 0 0 0
 Innenzehner: 28
 weiteste: 504 (11), 481 (1), 415 (22)
 beste Teiler 15.2 (27.) 33.1 (39.) 49.4 (31.)
 Trefferlage 0.24 mm links, 0.55 mm hoch
 Streuwert 1.39, horizontal: 1.59, vertikal: 1.16

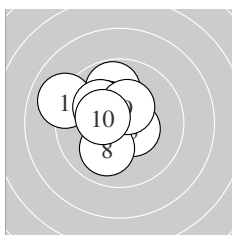
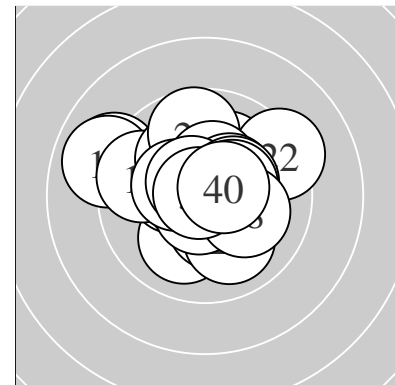

Serie 1:
 9.0 ↙ 9.8 ↑ 10.5 * 10.4 * 10.4 *
 10.3 * 10.1 ↘ 10.0 ↘ 10.4 * 10.4 *
 beste Teiler 116.8 (3.) 127.2 (4.) 140.3 (5.)
 Trefferlage 1.04 mm links, 0.80 mm hoch
 Streuwert 1.40, horizontal: 1.48, vertikal: 1.32

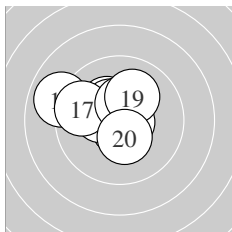

Serie 2:
 8.9 ↙ 10.7 * 10.3 * 10.7 * 10.3 *
 10.4 * 9.7 ↙ 10.4 * 10.1 ↗ 10.4 *
 beste Teiler 58.6 (14.) 65.0 (12.) 134.5 (16.)
 Trefferlage 0.89 mm links, 0.66 mm hoch
 Streuwert 1.49, horizontal: 1.82, vertikal: 1.06

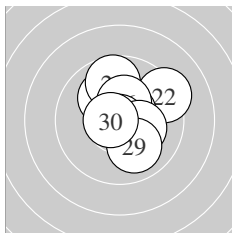

Serie 3:
 10.1 ↘ 9.3 ↗ 9.7 ↑ 10.6 * 10.6 *
 10.4 * 10.9 * 10.3 * 10.0 ↘ 10.7 *
 beste Teiler 15.2 (27.) 73.0 (30.) 84.1 (25.)
 Trefferlage 0.56 mm rechts, 0.55 mm hoch
 Streuwert 1.46, horizontal: 1.39, vertikal: 1.54

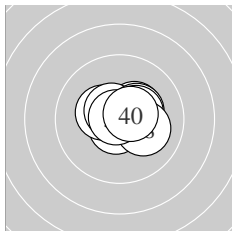

Serie 4:
 10.8 * 10.7 * 10.4 * 10.4 * 10.6 *
 10.3 * 10.4 * 10.1 ↘ 10.8 * 10.6 *
 beste Teiler 33.1 (39.) 49.4 (31.) 68.4 (32.)
 Trefferlage 0.40 mm rechts, 0.19 mm hoch
 Streuwert 0.87, horizontal: 1.08, vertikal: 0.59

Unterschrift des Schützen

Ergebnis: **390** (406.3)
 Serien: 98 97 99 96
 Zähler: 30 10 0 0 0 0 0 0 0 0
 Innenzehner: 22
 weiteste: 371 (38), 365 (16), 362 (24)
 beste Teiler 48.0 (23.) 62.3 (27.) 65.9 (25.)
 Trefferlage 0.54 mm rechts, 0.09 mm tief
 Streuwert 1.51, horizontal: 1.61, vertikal: 1.40

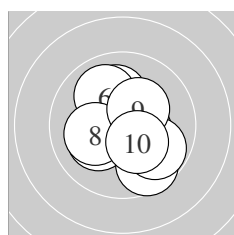
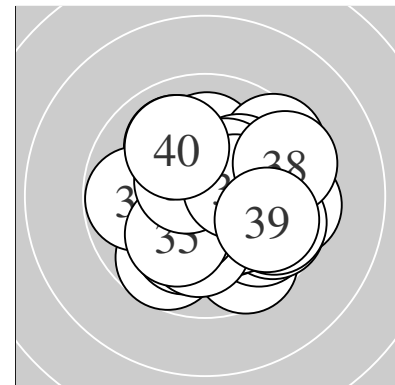

Serie 1:
 10.4 * 10.1 ↑ 10.6 * 9.6 ↘ 9.8 ↘
 10.0 ↘ 10.2 * 10.1 ← 10.3 * 10.3 *
 beste Teiler 90.6 (3.) 133.2 (1.) 159.5 (10.)
 Trefferlage 0.14 mm rechts, 0.29 mm tief
 Streuwert 1.57, horizontal: 1.54, vertikal: 1.60

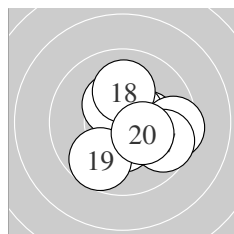

Serie 2:
 10.2 * 10.3 * 10.6 * 10.4 * 10.4 *
 9.5 → 9.7 ↘ 10.1 ↑ 9.7 ✓ 10.3 *
 beste Teiler 91.0 (13.) 134.0 (14.) 142.2 (15.)
 Trefferlage 0.82 mm rechts, 0.07 mm tief
 Streuwert 1.58, horizontal: 1.61, vertikal: 1.54

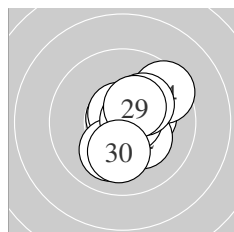

Serie 3:
 10.3 * 10.3 * 10.8 * 9.5 ↗ 10.7 *
 10.1 ↓ 10.7 * 10.2 * 10.4 * 10.1 ↓
 beste Teiler 48.0 (23.) 62.3 (27.) 65.9 (25.)
 Trefferlage 0.70 mm rechts, 0.07 mm hoch
 Streuwert 1.29, horizontal: 1.17, vertikal: 1.40

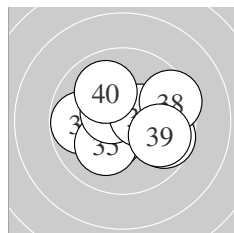

Serie 4:
 9.8 ← 9.7 ↘ 10.4 * 10.4 * 10.1 ✓
 10.5 * 10.4 * 9.5 → 9.8 ↘ 10.0 ↘
 beste Teiler 101.8 (36.) 135.0 (34.) 135.0 (37.)
 Trefferlage 0.49 mm rechts, 0.08 mm tief
 Streuwert 1.75, horizontal: 2.15, vertikal: 1.21

Unterschrift des Schützen

Meyton Elektronik

Ergebnis: **378** (393.5)
 Serien: 93 94 95 96
 Zähler: 22 14 4 0 0 0 0 0 0 0
 Innenzehner: 13
 weiteste: 703 (8), 584 (9), 516 (34)
 beste Teiler 57.3 (27.) 67.8 (18.) 106.9 (31.)
 Trefferlage 0.06 mm rechts, 0.55 mm hoch
 Streuwert 2.20, horizontal: 2.59, vertikal: 1.71

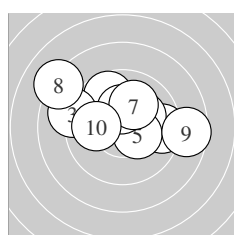
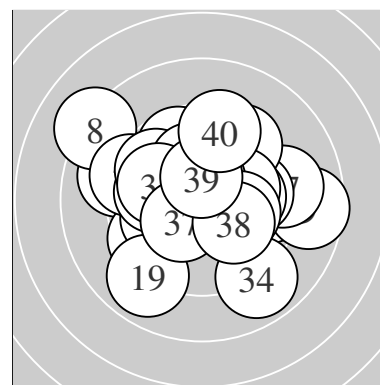

Serie 1:
 9.7 ↖ 9.5 → 9.0 ← 10.2 * 10.4 *
 10.3 * 10.0 ↗ 8.1 ↖ 8.6 → 10.0 ←
 beste Teiler 149.4 (5.) 163.3 (6.) 198.9 (4.)
 Trefferlage 0.07 mm links, 1.16 mm hoch
 Streuwert 2.74, horizontal: 3.58, vertikal: 1.49

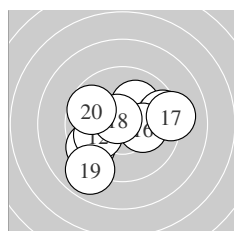

Serie 2:
 9.5 ↙ 10.0 ← 10.3 * 10.1 ↗ 9.5 →
 10.2 * 9.2 → 10.7 * 8.9 ↘ 9.7 ↖
 beste Teiler 67.8 (18.) 168.3 (13.) 186.9 (16.)
 Trefferlage 0.12 mm rechts, 0.18 mm tief
 Streuwert 2.35, horizontal: 2.80, vertikal: 1.80

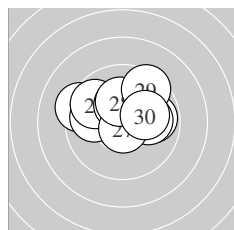

Serie 3:
 9.3 ↖ 9.9 ← 9.8 → 10.0 → 9.7 ↖
 10.3 * 10.7 * 10.2 * 9.5 ↗ 10.1 →
 beste Teiler 57.3 (27.) 160.8 (26.) 187.5 (28.)
 Trefferlage 0.03 mm links, 1.04 mm hoch
 Streuwert 1.82, horizontal: 2.37, vertikal: 1.03

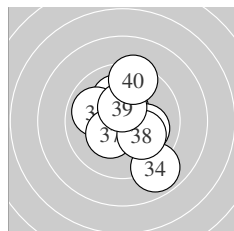

Serie 4:
 10.5 * 10.4 * 10.1 ↖ 8.9 ↘ 9.9 ↖
 10.1 → 10.3 * 10.1 ↘ 10.4 * 9.4 ↗
 beste Teiler 106.9 (31.) 126.0 (39.) 127.2 (32.)
 Trefferlage 0.25 mm rechts, 0.21 mm hoch
 Streuwert 1.94, horizontal: 1.67, vertikal: 2.17

Unterschrift des Schützen

Ergebnis: **388** (408.2)
 Serien: 96 96 98 98
 Zähler: 29 10 1 0 0 0 0 0 0 0
 Innenzehner: 26
 weiteste: 524 (16), 430 (38), 358 (15)
 beste Teiler 32.0 (5.) 46.0 (6.) 63.5 (31.)
 Trefferlage 0.36 mm rechts, 0.30 mm tief
 Streuwert 1.52, horizontal: 1.67, vertikal: 1.34

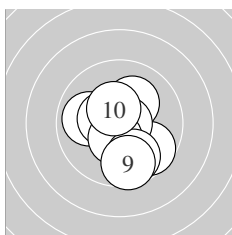
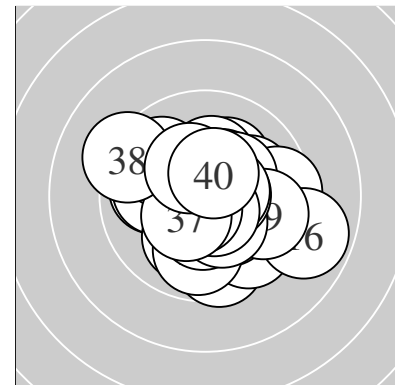

Serie 1:
 9.7 ↘ 9.9 ← 10.4 * 10.2 * 10.8 *
 10.8 * 10.4 * 9.8 ↓ 9.6 ↓ 10.4 *
 beste Teiler 32.0 (5.) 46.0 (6.) 128.4 (7.)
 Trefferlage 0.13 mm rechts, 0.57 mm tief
 Streuwert 1.53, horizontal: 1.38, vertikal: 1.67

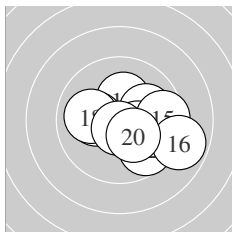

Serie 2:
 10.3 * 9.7 ↘ 10.0 → 10.3 * 9.5 →
 8.9 → 10.2 * 10.0 ← 10.7 * 10.3 *
 beste Teiler 67.7 (19.) 162.0 (14.) 168.5 (20.)
 Trefferlage 1.13 mm rechts, 0.36 mm tief
 Streuwert 1.83, horizontal: 2.27, vertikal: 1.24

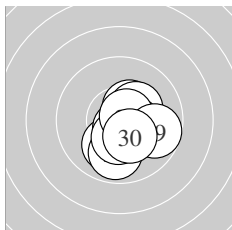

Serie 3:
 10.4 * 10.1 ↓ 9.9 ↓ 10.7 * 10.3 *
 10.5 * 10.4 * 10.7 * 9.7 → 10.3 *
 beste Teiler 66.3 (28.) 67.0 (24.) 123.2 (26.)
 Trefferlage 0.63 mm rechts, 0.69 mm tief
 Streuwert 1.15, horizontal: 1.07, vertikal: 1.24

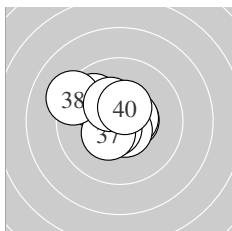

Serie 4:
 10.7 * 9.9 ↖ 10.5 * 10.6 * 10.6 *
 10.6 * 10.4 * 9.2 ↖ 10.3 * 10.5 *
 beste Teiler 63.5 (31.) 76.3 (36.) 87.9 (35.)
 Trefferlage 0.46 mm links, 0.42 mm hoch
 Streuwert 1.32, horizontal: 1.55, vertikal: 1.05

Unterschrift des Schützen

Meyton Elektronik

Ergebnis:	374	(390.2)
Serien:	94 92 95 93	
Zähler:	16 22 2 0 0 0 0 0 0 0	
Innenzehner:	12	
weiteste:	569 (25), 503 (34), 487 (11)	
beste Teiler	64.3 (10.) 91.0 (39.) 96.1 (28.)	
Trefferlage	0.07 mm rechts, 1.06 mm hoch	
Streuwert	2.23, horizontal: 2.69, vertikal: 1.63	

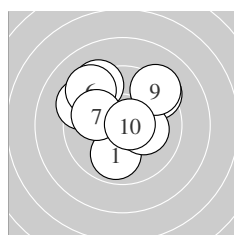
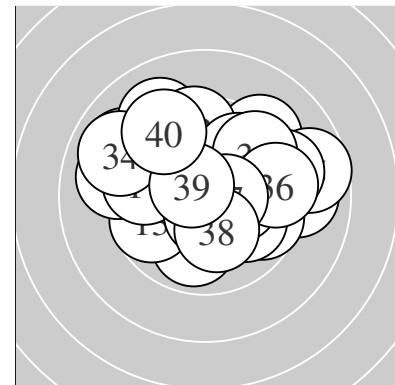

Serie 1:	9.9 ↙	9.3 ↖	9.3 ↗	10.5 *	9.3 ↘
	9.3 ↘	10.0 ↖	10.2 *	9.3 ↗	10.7 *
beste Teiler	64.3 (10.) 107.0 (4.) 190.6 (8.)				
Trefferlage	0.20 mm links, 1.23 mm hoch				
Streuwert	2.21, horizontal: 2.44, vertikal: 1.97				

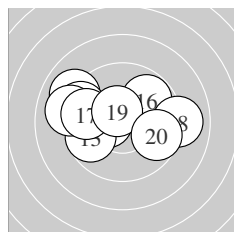

Serie 2:	9.0 ↖	10.4 *	9.7 ↙	9.4 ↖	9.1 ↖
	9.8 ↗	9.6 ↖	9.0 →	10.5 *	9.7 →
beste Teiler	108.6 (19.) 137.0 (12.) 287.3 (16.)				
Trefferlage	1.04 mm links, 0.60 mm hoch				
Streuwert	2.50, horizontal: 3.32, vertikal: 1.22				

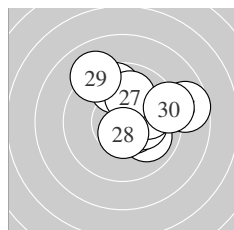

Serie 3:	9.7 ↑	10.0 ↘	10.5 *	10.3 *	8.7 →
	10.0 →	10.0 ↑	10.6 *	9.1 ↘	9.2 →
beste Teiler	96.1 (28.) 110.5 (23.) 173.1 (24.)				
Trefferlage	1.42 mm rechts, 0.97 mm hoch				
Streuwert	2.03, horizontal: 2.28, vertikal: 1.76				

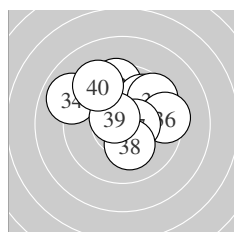

Serie 4:	10.3 *	9.5 ↑	9.8 ↗	8.9 ↖	9.6 ↗
	9.4 →	10.5 *	10.2 *	10.6 *	9.3 ↘
beste Teiler	91.0 (39.) 109.0 (37.) 163.2 (31.)				
Trefferlage	0.11 mm rechts, 1.43 mm hoch				
Streuwert	2.06, horizontal: 2.40, vertikal: 1.65				

Unterschrift des Schützen

Meyton Elektronik

Ergebnis: **386** (404.3)
 Serien: 94 98 96 98
 Zähler: 26 14 0 0 0 0 0 0 0 0
 Innenzehner: 20
 weiteste: 483 (9), 442 (13), 395 (40)
 beste Teiler 20.3 (4.) 27.7 (28.) 61.0 (34.)
 Trefferlage 0.14 mm rechts, 0.54 mm tief
 Streuwert 1.72, horizontal: 1.96, vertikal: 1.43

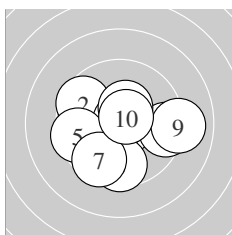
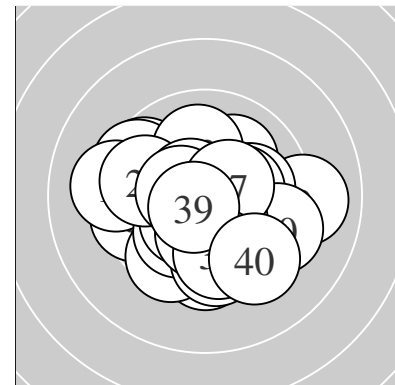

Serie 1:
 10.7 * 9.6 ↖ 9.4 → 10.9 * 9.5 ←
 9.6 ↓ 9.6 ↙ 10.4 * 9.0 → 10.7 *
 beste Teiler 20.3 (4.) 73.7 (1.) 74.2 (10.)
 Trefferlage 0.23 mm rechts, 0.46 mm tief
 Streuwert 2.19, horizontal: 2.62, vertikal: 1.64

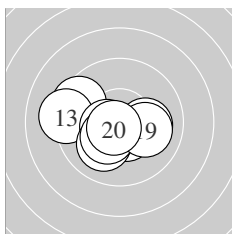

Serie 2:
 9.5 ↖ 10.1 → 9.2 ← 10.5 * 10.5 *
 10.1 ↙ 10.4 * 10.3 * 10.1 → 10.7 *
 beste Teiler 66.4 (20.) 110.7 (14.) 112.8 (15.)
 Trefferlage 0.75 mm links, 0.47 mm tief
 Streuwert 1.60, horizontal: 2.07, vertikal: 0.93

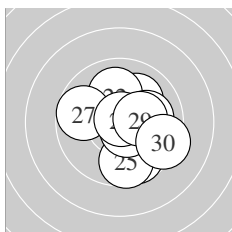

Serie 3:
 10.1 ↗ 10.0 ↑ 10.1 → 9.7 ↘ 9.7 ↓
 10.6 * 9.7 ← 10.8 * 10.3 * 9.4 ↘
 beste Teiler 27.7 (28.) 89.1 (26.) 172.1 (29.)
 Trefferlage 0.81 mm rechts, 0.26 mm tief
 Streuwert 1.78, horizontal: 1.74, vertikal: 1.81

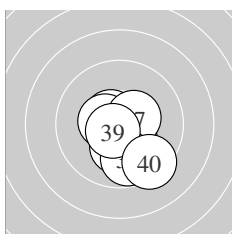

Serie 4:
 10.6 * 10.5 * 10.4 * 10.7 * 10.5 *
 10.2 * 10.4 * 9.8 ↓ 10.6 * 9.4 ↘
 beste Teiler 61.0 (34.) 79.1 (39.) 92.4 (31.)
 Trefferlage 0.27 mm rechts, 0.99 mm tief
 Streuwert 1.19, horizontal: 1.06, vertikal: 1.30

Unterschrift des Schützen

Meyton Elektronik

Ergebnis: **387** (405.1)
 Serien: 98 97 97 95
 Zähler: 27 13 0 0 0 0 0 0 0 0
 Innenzehner: 25
 weiteste: 469 (9), 424 (11), 414 (33)
 beste Teiler 64.3 (28.) 71.2 (8.) 76.4 (24.)
 Trefferlage 0.17 mm rechts, 0.24 mm hoch
 Streuwert 1.70, horizontal: 2.11, vertikal: 1.14

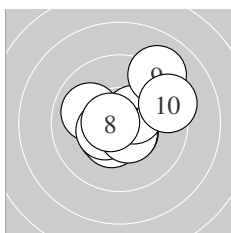
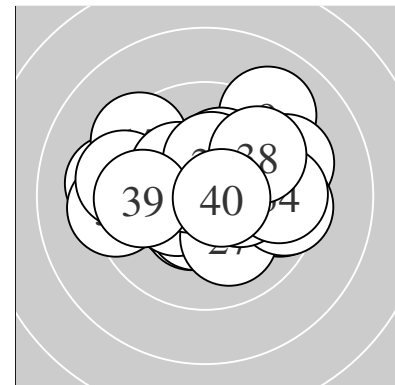

Serie 1:
 10.5 * 10.5 * 10.0 ↖ 10.4 * 10.5 *
 10.5 * 10.4 * 10.7 * 9.1 ↗ 9.4 →
 beste Teiler 71.2 (8.) 101.1 (1.) 103.8 (6.)
 Trefferlage 0.34 mm rechts, 0.27 mm hoch
 Streuwert 1.68, horizontal: 1.86, vertikal: 1.49

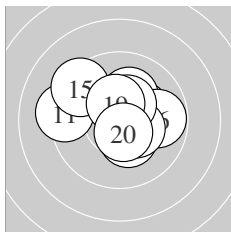

Serie 2:
 9.3 ← 10.3 * 10.2 * 10.3 * 9.4 ↖
 9.8 → 10.4 * 10.4 * 10.4 * 10.6 *
 beste Teiler 97.4 (20.) 130.7 (19.) 135.0 (18.)
 Trefferlage 0.04 mm rechts, 0.53 mm hoch
 Streuwert 1.74, horizontal: 2.12, vertikal: 1.25

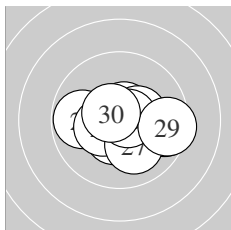

Serie 3:
 9.8 ← 10.5 * 9.6 → 10.6 * 10.4 *
 10.4 * 10.1 ↘ 10.7 * 9.5 → 10.6 *
 beste Teiler 64.3 (28.) 76.4 (24.) 85.9 (30.)
 Trefferlage 0.53 mm rechts, 0.28 mm tief
 Streuwert 1.53, horizontal: 2.01, vertikal: 0.81

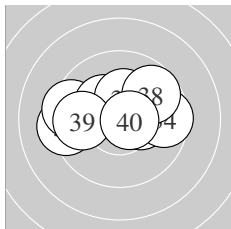

Serie 4:
 10.5 * 10.3 * 9.3 ← 9.6 → 9.4 ←
 10.3 * 10.3 * 9.7 ↗ 9.8 ← 10.6 *
 beste Teiler 76.5 (40.) 123.0 (31.) 161.3 (32.)
 Trefferlage 0.22 mm links, 0.46 mm hoch
 Streuwert 1.95, horizontal: 2.63, vertikal: 0.84

Unterschrift des Schützen

Ergebnis: **375** (394.4)
 Serien: 95 91 97 92
 Zähler: 22 13 3 2 0 0 0 0 0 0
 Innenzehner: 16
 weiteste: 793 (38), 775 (1), 727 (14)
 beste Teiler 14.4 (9.) 68.2 (16.) 82.9 (37.)
 Trefferlage 1.22 mm rechts, 0.63 mm tief
 Streuwert 2.18, horizontal: 2.68, vertikal: 1.52

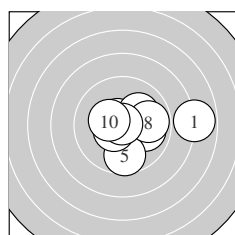
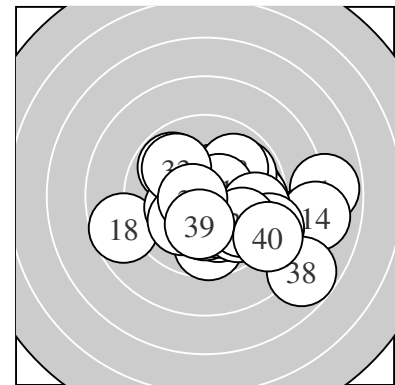

Serie 1:
 7.9 → 10.4 * 10.0 → 10.6 * 9.7 ↓
 10.1 ↗ 10.5 * 9.8 → 10.9 * 10.3 *
 beste Teiler 14.4 (9.) 83.6 (4.) 110.1 (7.)
 Trefferlage 1.29 mm rechts, 0.02 mm tief
 Streuwert 2.09, horizontal: 2.67, vertikal: 1.25

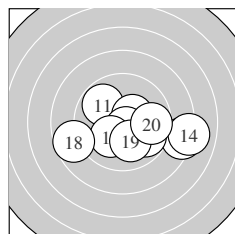

Serie 2:
 9.8 ↘ 8.3 → 10.4 * 8.0 → 9.8 ↘
 10.7 * 10.1 ↙ 8.7 ← 10.1 ↓ 9.7 →
 beste Teiler 68.2 (16.) 129.2 (13.) 201.6 (17.)
 Trefferlage 1.27 mm rechts, 0.83 mm tief
 Streuwert 2.82, horizontal: 3.77, vertikal: 1.30

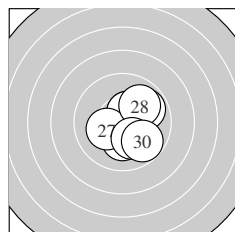

Serie 3:
 9.9 ↗ 10.5 * 10.3 * 10.6 * 10.5 *
 10.2 * 10.2 * 9.9 ↗ 10.1 ↓ 9.8 ↘
 beste Teiler 96.6 (24.) 120.3 (25.) 120.7 (22.)
 Trefferlage 0.69 mm rechts, 0.34 mm tief
 Streuwert 1.38, horizontal: 1.24, vertikal: 1.51

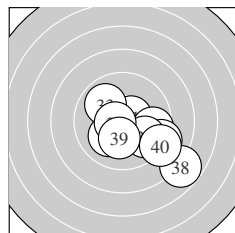

Serie 4:
 10.5 * 9.6 → 9.9 ↘ 10.1 ↙ 9.1 ↘
 9.8 ↘ 10.6 * 7.8 ↘ 10.2 * 9.0 ↘
 beste Teiler 82.9 (37.) 102.4 (31.) 186.5 (39.)
 Trefferlage 1.65 mm rechts, 1.33 mm tief
 Streuwert 2.35, horizontal: 2.77, vertikal: 1.83

Unterschrift des Schützen

Ergebnis: **393** (410.0)
 Serien: 95 99 100 99
 Zähler: 35 4 0 1 0 0 0 0 0 0
 Innenzehner: 29
 weiteste: 772 (7), 406 (35), 346 (2)
 beste Teiler 39.0 (5.) 47.2 (34.) 53.3 (14.)
 Trefferlage 0.26 mm links, 0.11 mm tief
 Streuwert 1.53, horizontal: 1.76, vertikal: 1.26

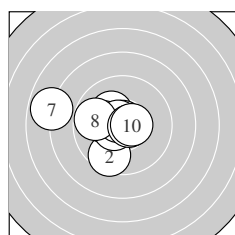
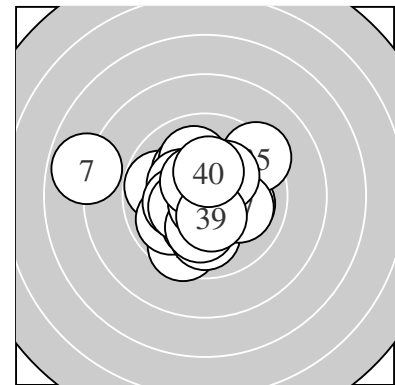

Serie 1:
 10.2 * 9.6 ↘ 10.2 * 10.6 * 10.8 *
 10.7 * 7.9 ← 9.8 ← 10.7 * 10.6 *
 beste Teiler 39.0 (5.) 63.1 (6.) 66.7 (9.)
 Trefferlage 1.46 mm links, 0.11 mm hoch
 Streuwert 1.95, horizontal: 2.42, vertikal: 1.33

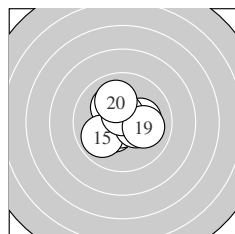

Serie 2:
 10.2 * 10.7 * 10.4 * 10.7 * 9.9 ↗
 10.4 * 10.2 * 10.6 * 10.0 → 10.0 ↑
 beste Teiler 53.3 (14.) 62.0 (12.) 81.0 (18.)
 Trefferlage 0.02 mm rechts, 0.15 mm hoch
 Streuwert 1.29, horizontal: 1.41, vertikal: 1.15

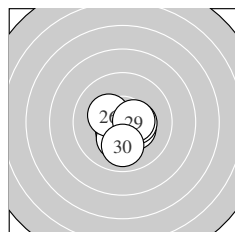

Serie 3:
 10.1 ↓ 10.5 * 10.6 * 10.6 * 10.2 *
 10.3 * 10.4 * 10.4 * 10.5 * 10.0 ↓
 beste Teiler 89.5 (23.) 96.7 (24.) 116.2 (22.)
 Trefferlage 0.09 mm rechts, 0.79 mm tief
 Streuwert 1.02, horizontal: 0.99, vertikal: 1.05

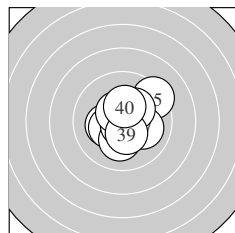

Serie 4:
 10.2 * 10.3 * 10.1 ↓ 10.8 * 9.3 ↗
 10.5 * 10.1 → 10.2 * 10.4 * 10.3 *
 beste Teiler 47.2 (34.) 110.9 (36.) 135.3 (39.)
 Trefferlage 0.30 mm rechts, 0.06 mm hoch
 Streuwert 1.47, horizontal: 1.53, vertikal: 1.41

Unterschrift des Schützen

Meyton Elektronik

Ergebnis: **385** (403.1)
 Serien: 96 99 94 96
 Zähler: 25 15 0 0 0 0 0 0 0 0
 Innenzehner: 19
 weiteste: 460 (26), 452 (23), 450 (35)
 beste Teiler 57.3 (32.) 67.7 (31.) 69.1 (33.)
 Trefferlage 0.50 mm links, 0.41 mm hoch
 Streuwert 1.71, horizontal: 2.03, vertikal: 1.30

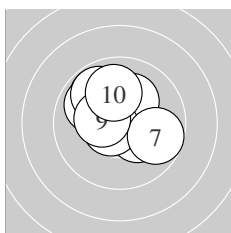
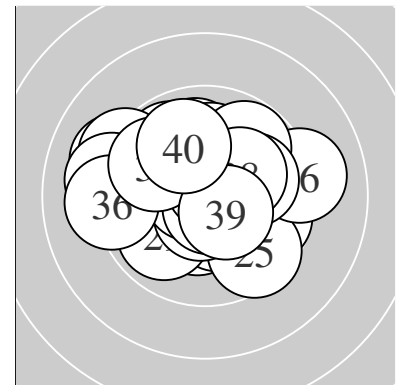

Serie 1:
 10.3 * 9.9 ↘ 10.2 * 10.6 * 10.1 ↘
 9.9 ↙ 9.7 → 9.8 ↘ 10.4 * 10.0 ↑
 beste Teiler 77.3 (4.) 142.3 (9.) 167.0 (1.)
 Trefferlage 0.41 mm links, 0.97 mm hoch
 Streuwert 1.48, horizontal: 1.62, vertikal: 1.33

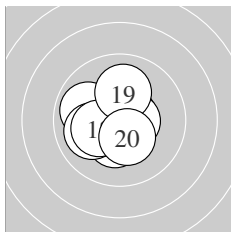

Serie 2:
 10.6 * 10.5 * 9.9 ↙ 10.3 * 10.0 ←
 10.6 * 10.6 * 10.3 * 10.1 ↑ 10.4 *
 beste Teiler 78.0 (11.) 83.0 (17.) 99.2 (16.)
 Trefferlage 0.52 mm links, 0.21 mm tief
 Streuwert 1.19, horizontal: 1.26, vertikal: 1.11

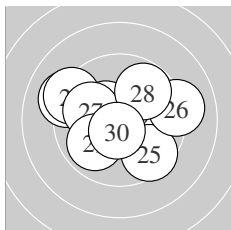

Serie 3:
 10.4 * 10.4 * 9.1 ↙ 9.2 ↙ 9.6 ↘
 9.1 → 10.0 ← 9.8 ↗ 9.9 ↙ 10.6 *
 beste Teiler 86.8 (30.) 138.8 (21.) 142.0 (22.)
 Trefferlage 0.34 mm links, 0.33 mm hoch
 Streuwert 2.31, horizontal: 2.84, vertikal: 1.61

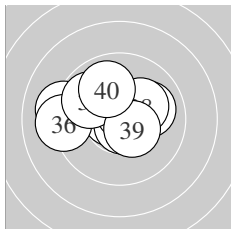

Serie 4:
 10.7 * 10.7 * 10.7 * 10.0 → 9.2 ←
 9.2 ← 9.8 ↘ 10.2 * 10.4 * 9.9 ↘
 beste Teiler 57.3 (32.) 67.7 (31.) 69.1 (33.)
 Trefferlage 0.74 mm links, 0.55 mm hoch
 Streuwert 1.80, horizontal: 2.35, vertikal: 0.97

Unterschrift des Schützen

Ergebnis: **392** (410.1)
 Serien: 98 98 98 98
 Zähler: 32 8 0 0 0 0 0 0 0 0
 Innenzehner: 25
 weiteste: 420 (5), 366 (28), 365 (23)
 beste Teiler 25.3 (37.) 28.1 (27.) 45.8 (3.)
 Trefferlage 0.03 mm links, 0.64 mm tief
 Streuwert 1.35, horizontal: 1.56, vertikal: 1.10

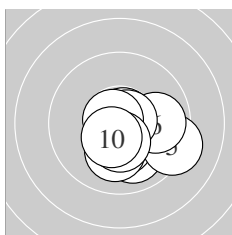
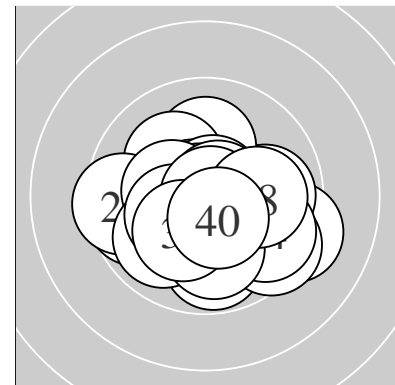

Serie 1:
 10.0 ↘ 10.3 * 10.8 * 10.1 ↓ 9.3 ↘
 9.9 → 10.7 * 10.7 * 10.4 * 10.5 *
 beste Teiler 45.8 (3.) 55.0 (8.) 57.0 (7.)
 Trefferlage 0.71 mm rechts, 0.89 mm tief
 Streuwert 1.26, horizontal: 1.46, vertikal: 1.01

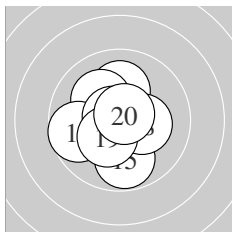

Serie 2:
 10.4 * 10.4 * 10.1 ↑ 10.1 ↘ 9.8 ↓
 9.7 ← 10.7 * 10.3 * 10.3 * 10.7 *
 beste Teiler 56.4 (20.) 58.1 (17.) 141.3 (11.)
 Trefferlage 0.52 mm links, 0.07 mm hoch
 Streuwert 1.37, horizontal: 1.27, vertikal: 1.46

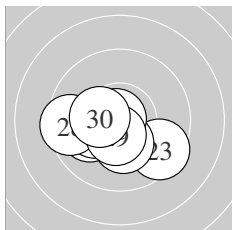

Serie 3:
 10.7 * 10.4 * 9.5 ↘ 10.0 ← 10.3 *
 10.2 * 10.8 * 9.5 ← 10.5 * 10.4 *
 beste Teiler 28.1 (27.) 71.8 (21.) 114.4 (29.)
 Trefferlage 0.69 mm links, 0.82 mm tief
 Streuwert 1.36, horizontal: 1.76, vertikal: 0.77

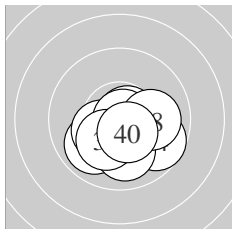

Serie 4:
 9.9 ↙ 10.3 * 10.4 * 9.7 ↘ 10.7 *
 10.0 ↓ 10.9 * 10.0 → 10.2 * 10.5 *
 beste Teiler 25.3 (37.) 60.7 (35.) 113.8 (40.)
 Trefferlage 0.38 mm rechts, 0.95 mm tief
 Streuwert 1.20, horizontal: 1.47, vertikal: 0.85

Unterschrift des Schützen

Meyton Elektronik

Ergebnis: **388** (407.6)
 Serien: 96 96 98 98
 Zähler: 28 12 0 0 0 0 0 0 0 0
 Innenzehner: 23
 weiteste: 427 (20), 343 (11), 337 (1)
 beste Teiler 6.0 (32.) 15.2 (38.) 36.8 (30.)
 Trefferlage 0.30 mm rechts, 0.46 mm hoch
 Streuwert 1.51, horizontal: 1.66, vertikal: 1.33

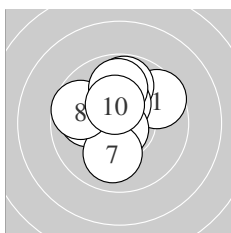
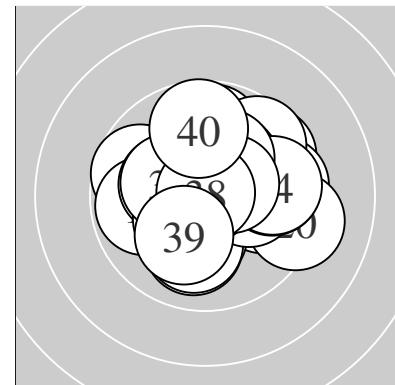

Serie 1:
 9.6 ↗ 9.8 ↑ 10.0 ← 10.7 * 10.4 *
 10.8 * 10.0 ↓ 9.7 ↖ 9.9 ↑ 10.4 *
 beste Teiler 44.1 (6.) 72.0 (4.) 144.5 (10.)
 Trefferlage 0.37 mm links, 0.90 mm hoch
 Streuwert 1.55, horizontal: 1.56, vertikal: 1.53

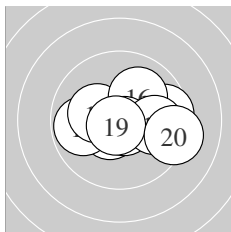

Serie 2:
 9.6 → 10.5 * 10.6 * 9.8 ← 10.2 *
 10.0 ↗ 10.7 * 9.9 → 10.8 * 9.2 →
 beste Teiler 49.6 (19.) 57.6 (17.) 86.0 (13.)
 Trefferlage 0.71 mm rechts, 0.02 mm tief
 Streuwert 1.68, horizontal: 2.21, vertikal: 0.85

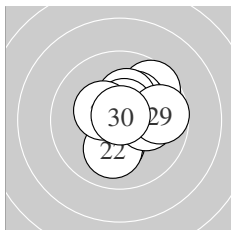

Serie 3:
 10.2 * 10.1 ↓ 9.6 ↗ 10.2 * 10.2 *
 10.3 * 10.6 * 10.4 * 9.7 → 10.8 *
 beste Teiler 36.8 (30.) 97.4 (27.) 144.7 (28.)
 Trefferlage 0.74 mm rechts, 0.38 mm hoch
 Streuwert 1.41, horizontal: 1.38, vertikal: 1.44

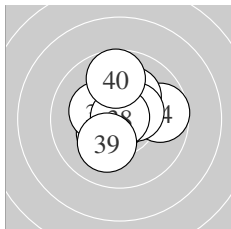

Serie 4:
 10.4 * 10.9 * 10.2 * 9.7 → 10.2 *
 10.5 * 10.3 * 10.9 * 10.1 ↓ 9.7 ↑
 beste Teiler 6.0 (32.) 15.2 (38.) 125.6 (36.)
 Trefferlage 0.13 mm rechts, 0.57 mm hoch
 Streuwert 1.38, horizontal: 1.34, vertikal: 1.42

Unterschrift des Schützen

Ergebnis:	393	(409.5)
Serien:	98 99 97 99	
Zähler:	33 7 0 0 0 0 0 0 0 0	
Innenzehner:	25	
weiteste:	384 (3), 345 (30), 299 (27)	
beste Teiler	46.2 (26.) 51.2 (2.) 67.0 (10.)	
Trefferlage	0.13 mm rechts, 0.34 mm hoch	
Streuwert	1.38, horizontal: 1.62, vertikal: 1.11	

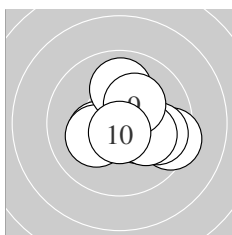
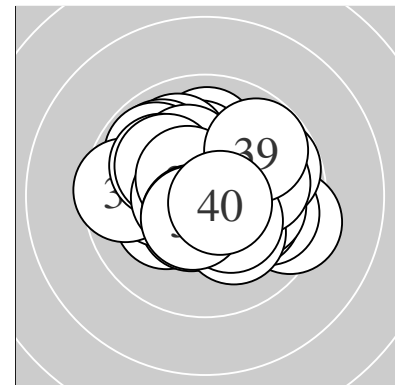

Serie 1:

10.4 *	10.7 *	9.4 ↘	9.8 ↘	10.3 *
10.2 *	10.1 ↘	10.0 ↑	10.3 *	10.7 *
beste Teiler	51.2 (2.) 67.0 (10.) 148.9 (1.)			
Trefferlage	0.72 mm rechts, 0.21 mm tief			
Streuwert	1.48, horizontal: 1.74, vertikal: 1.17			

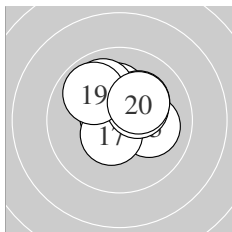

Serie 2:

10.2 *	10.2 *	10.1 ↘	10.0 ↖	10.7 *
10.4 *	10.5 *	10.3 *	9.9 ↖	10.2 *
beste Teiler	73.3 (15.) 116.9 (17.) 140.4 (16.)			
Trefferlage	0.26 mm rechts, 0.92 mm hoch			
Streuwert	1.20, horizontal: 1.33, vertikal: 1.04			

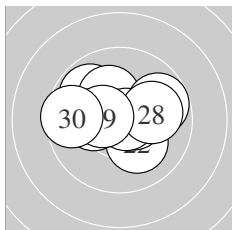

Serie 3:

9.8 ↖	10.1 ↘	10.5 *	10.2 *	10.2 *
10.8 *	9.8 ↘	10.0 →	10.5 *	9.6 ←
beste Teiler	46.2 (26.) 102.4 (23.) 125.7 (29.)			
Trefferlage	0.16 mm links, 0.43 mm hoch			
Streuwert	1.60, horizontal: 2.04, vertikal: 0.97			

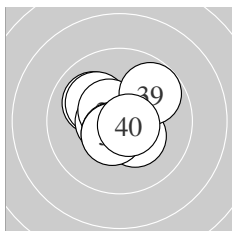

Serie 4:

10.6 *	10.0 ↖	10.3 *	10.1 ↖	10.6 *
10.5 *	10.5 *	10.5 *	9.8 ↗	10.7 *
beste Teiler	71.5 (40.) 82.6 (31.) 96.1 (35.)			
Trefferlage	0.30 mm links, 0.25 mm hoch			
Streuwert	1.18, horizontal: 1.27, vertikal: 1.08			

Unterschrift des Schützen

Meyton Elektronik

Ergebnis: **379** (394.5)
 Serien: 93 96 95 95
 Zähler: 21 17 2 0 0 0 0 0 0 0
 Innenzehner: 13
 weiteste: 704 (6), 668 (30), 468 (16)
 beste Teiler 33.7 (21.) 95.7 (3.) 112.0 (20.)
 Trefferlage 0.44 mm links, 0.20 mm hoch
 Streuwert 2.15, horizontal: 2.41, vertikal: 1.84

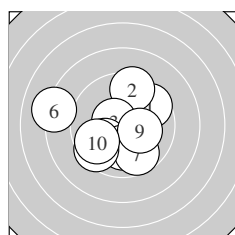
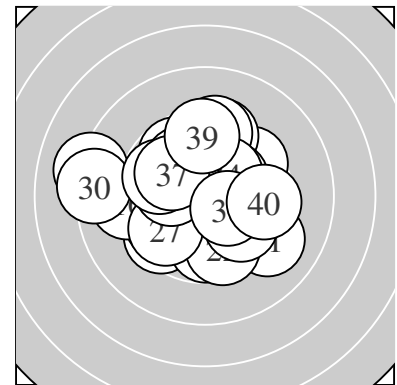

Serie 1:
 9.6 ↗ 9.5 ↑ 10.6 * 10.0 ↙ 10.1 ↓
 8.1 ← 9.7 ↘ 9.5 ↖ 10.2 * 9.7 ↙
 beste Teiler 95.7 (3.) 182.4 (9.) 225.0 (5.)
 Trefferlage 0.78 mm links, 0.36 mm tief
 Streuwert 2.52, horizontal: 2.83, vertikal: 2.16

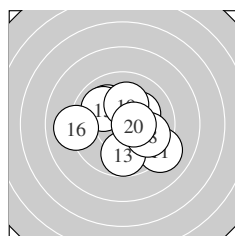

Serie 2:
 9.1 ↘ 10.0 ↖ 9.8 ↓ 10.4 * 10.0 ↖
 9.1 ← 10.2 * 9.9 ↗ 10.2 * 10.5 *
 beste Teiler 112.0 (20.) 150.3 (14.) 187.7 (17.)
 Trefferlage 0.14 mm rechts, 0.06 mm hoch
 Streuwert 2.12, horizontal: 2.40, vertikal: 1.80

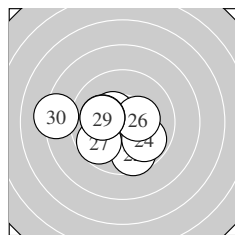

Serie 3:
 10.8 * 9.6 ↓ 10.3 * 9.9 ↘ 10.4 *
 10.3 * 9.7 ↖ 10.1 ← 10.1 ← 8.3 ←
 beste Teiler 33.7 (21.) 127.1 (25.) 155.7 (26.)
 Trefferlage 1.12 mm links, 0.44 mm tief
 Streuwert 2.02, horizontal: 2.52, vertikal: 1.34

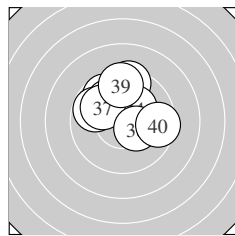

Serie 4:
 9.7 ↖ 9.4 ↑ 10.4 * 10.2 * 9.8 ↖
 10.0 ↖ 10.0 ↖ 10.3 * 9.5 ↑ 9.5 →
 beste Teiler 144.0 (33.) 155.3 (38.) 179.0 (34.)
 Trefferlage 0.02 mm links, 1.54 mm hoch
 Streuwert 1.73, horizontal: 1.95, vertikal: 1.49

Unterschrift des Schützen

Meyton Elektronik

Ergebnis: **386** (402.8)
 Serien: 96 96 98 96
 Zähler: 26 14 0 0 0 0 0 0 0 0
 Innenzehner: 18
 weiteste: 497 (17), 412 (8), 385 (37)
 beste Teiler 61.2 (9.) 76.2 (26.) 76.6 (29.)
 Trefferlage 0.31 mm links, 0.72 mm hoch
 Streuwert 1.63, horizontal: 1.79, vertikal: 1.46

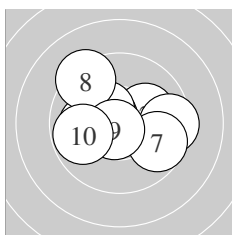
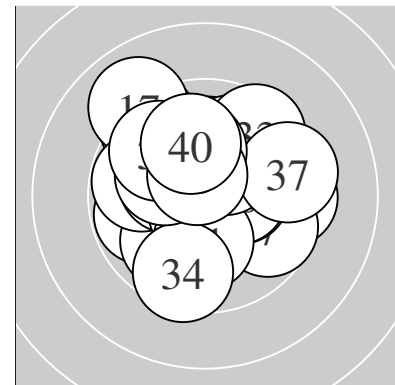

Serie 1:
 10.0 ← 10.1 → 10.5 * 10.6 * 9.5 →
 10.4 * 9.7 ↘ 9.3 ↙ 10.7 * 9.8 ←
 beste Teiler 61.2 (9.) 96.0 (4.) 101.0 (3.)
 Trefferlage 0.24 mm links, 0.26 mm hoch
 Streuwert 1.85, horizontal: 2.29, vertikal: 1.26

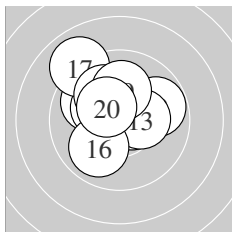

Serie 2:
 10.6 * 9.8 → 10.3 * 9.9 ↘ 10.3 *
 9.9 ↙ 9.0 ↘ 10.1 ↘ 10.1 ↑ 10.4 *
 beste Teiler 90.0 (11.) 137.8 (20.) 156.2 (13.)
 Trefferlage 0.49 mm links, 1.04 mm hoch
 Streuwert 1.68, horizontal: 1.78, vertikal: 1.57

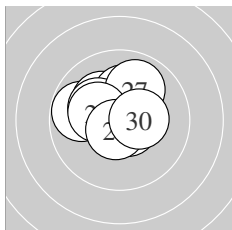

Serie 3:
 9.8 ← 10.2 * 10.2 * 10.2 * 10.2 *
 10.6 * 9.9 ↗ 10.3 * 10.6 * 10.4 *
 beste Teiler 76.2 (26.) 76.6 (29.) 145.2 (30.)
 Trefferlage 0.56 mm links, 0.78 mm hoch
 Streuwert 1.21, horizontal: 1.41, vertikal: 0.97

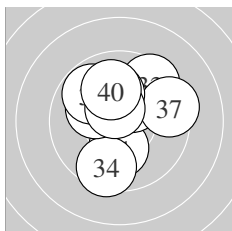

Serie 4:
 10.1 ↓ 10.3 * 9.5 ↗ 9.5 ↓ 10.1 ↘
 9.8 ↘ 9.4 → 10.1 ↑ 10.6 * 10.0 ↑
 beste Teiler 100.3 (39.) 166.1 (32.) 201.1 (31.)
 Trefferlage 0.05 mm rechts, 0.80 mm hoch
 Streuwert 1.89, horizontal: 1.79, vertikal: 1.98

Unterschrift des Schützen

Meyton Elektronik

Ergebnis: **375** (393.9)
 Serien: 90 94 95 96
 Zähler: 19 18 2 1 0 0 0 0 0 0
 Innenzehner: 14
 weiteste: 784 (8), 620 (2), 554 (1)
 beste Teiler 51.4 (31.) 54.4 (32.) 71.1 (16.)
 Trefferlage 0.36 mm links, 0.21 mm hoch
 Streuwert 2.26, horizontal: 2.75, vertikal: 1.64

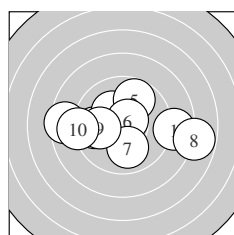
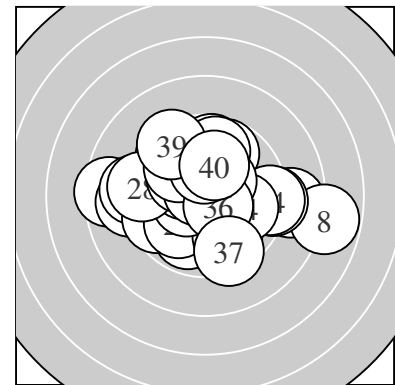

Serie 1:
 8.7 → 8.5 ← 9.7 ← 10.2 * 9.7 ↑
 10.6 * 10.0 ↓ 7.8 → 10.0 ← 9.0 ←
 beste Teiler 76.3 (6.) 182.8 (4.) 244.0 (7.)
 Trefferlage 0.20 mm links, 0.03 mm tief
 Streuwert 3.23, horizontal: 4.34, vertikal: 1.43

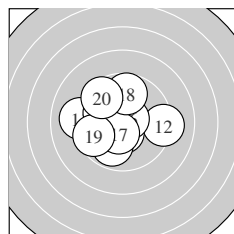

Serie 2:
 9.1 ← 9.2 → 10.5 * 9.9 ↓ 10.1 ↘
 10.7 * 10.5 * 9.7 ↑ 9.6 ← 9.6 ↘
 beste Teiler 71.1 (16.) 113.2 (13.) 125.5 (17.)
 Trefferlage 0.79 mm links, 0.08 mm hoch
 Streuwert 2.15, horizontal: 2.46, vertikal: 1.78

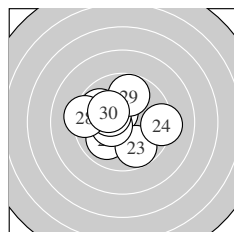

Serie 3:
 10.5 * 10.0 ↙ 9.8 ↓ 9.3 → 10.5 *
 10.3 * 9.8 ↘ 9.3 ← 9.8 ↑ 10.2 *
 beste Teiler 113.0 (21.) 124.6 (25.) 151.2 (26.)
 Trefferlage 0.65 mm links, 0.26 mm hoch
 Streuwert 1.97, horizontal: 2.29, vertikal: 1.59

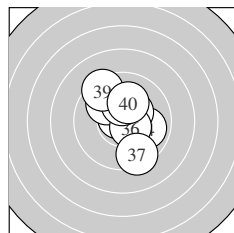

Serie 4:
 10.7 * 10.7 * 9.9 ↘ 9.9 → 10.4 *
 10.5 * 9.4 ↓ 10.3 * 9.4 ↘ 10.1 ↑
 beste Teiler 51.4 (31.) 54.4 (32.) 106.4 (36.)
 Trefferlage 0.18 mm rechts, 0.56 mm hoch
 Streuwert 1.69, horizontal: 1.42, vertikal: 1.92

Unterschrift des Schützen

Ergebnis: **391** (406.3)
 Serien: 99 99 96 97
 Zähler: 31 9 0 0 0 0 0 0 0 0
 Innenzehner: 26
 weiteste: 494 (27), 416 (36), 356 (20)
 beste Teiler 23.4 (18.) 69.0 (29.) 87.8 (7.)
 Trefferlage 0.05 mm links, 0.11 mm hoch
 Streuwert 1.57, horizontal: 1.54, vertikal: 1.61

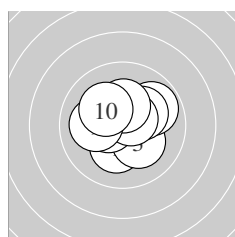
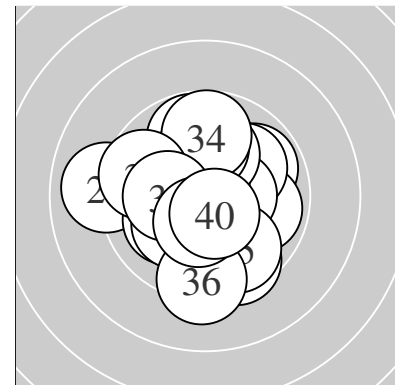

Serie 1:
 10.2 * 10.3 * 10.2 * 9.9 ↗ 10.5 *
 10.2 * 10.6 * 10.3 * 10.1 ← 10.2 *
 beste Teiler 87.8 (7.) 117.0 (5.) 157.7 (2.)
 Trefferlage 0.19 mm rechts, 0.38 mm hoch
 Streuwert 1.33, horizontal: 1.48, vertikal: 1.15

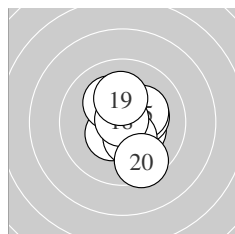

Serie 2:
 10.5 * 10.3 * 10.3 * 10.4 * 10.2 *
 10.4 * 10.2 * 10.9 * 10.2 * 9.5 ↘
 beste Teiler 23.4 (18.) 119.4 (11.) 130.2 (14.)
 Trefferlage 0.40 mm rechts, 0.00 mm
 Streuwert 1.34, horizontal: 1.08, vertikal: 1.56

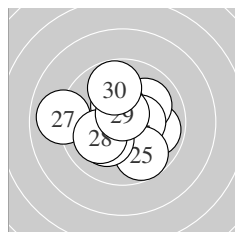

Serie 3:
 9.9 → 10.0 ↗ 10.4 * 10.4 * 9.7 ↘
 10.2 * 9.0 ← 10.1 ↙ 10.7 * 9.8 ↑
 beste Teiler 69.0 (29.) 134.0 (24.) 140.1 (23.)
 Trefferlage 0.18 mm links, 0.08 mm hoch
 Streuwert 1.93, horizontal: 2.21, vertikal: 1.60

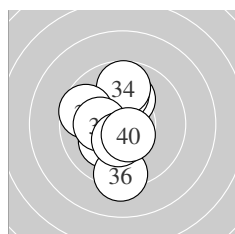

Serie 4:
 10.1 ↑ 10.5 * 10.0 ↑ 9.7 ↑ 10.2 *
 9.3 ↓ 9.7 ← 10.2 * 10.4 * 10.6 *
 beste Teiler 100.6 (40.) 106.0 (32.) 134.3 (39.)
 Trefferlage 0.64 mm links, 0.01 mm tief
 Streuwert 1.74, horizontal: 1.14, vertikal: 2.19

Unterschrift des Schützen

Meyton Elektronik

Ergebnis: **377** (399.4)
 Serien: 90 94 96 97
 Zähler: 19 19 2 0 0 0 0 0 0 0
 Innenzehner: 16
 weiteste: 605 (9), 543 (17), 486 (18)
 beste Teiler 35.3 (24.) 46.0 (20.) 56.0 (12.)
 Trefferlage 0.41 mm rechts, 0.42 mm hoch
 Streuwert 1.94, horizontal: 2.25, vertikal: 1.57

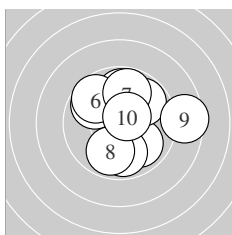
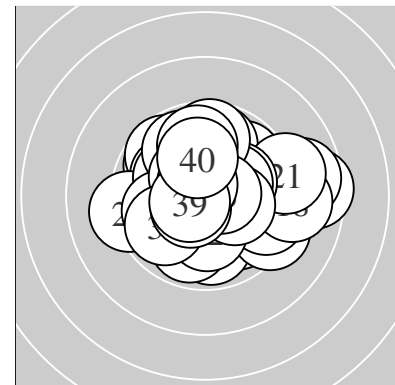

Serie 1:
 9.8 ↘ 9.9 ↘ 9.9 ↓ 9.8 ↑ 9.8 ↗
 9.7 ↘ 9.8 ↑ 9.9 ↓ 8.5 → 10.6 *
 beste Teiler 92.0 (10.) 258.8 (2.) 271.9 (8.)
 Trefferlage 0.64 mm rechts, 0.54 mm hoch
 Streuwert 2.29, horizontal: 2.40, vertikal: 2.18

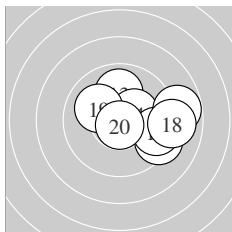

Serie 2:
 10.6 * 10.7 * 9.9 ↑ 10.3 * 9.3 ↘
 9.5 → 8.8 → 9.0 → 10.1 ↘ 10.8 *
 beste Teiler 46.0 (20.) 56.0 (12.) 82.7 (11.)
 Trefferlage 1.65 mm rechts, 0.27 mm hoch
 Streuwert 1.96, horizontal: 2.48, vertikal: 1.24

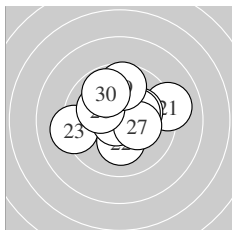

Serie 3:
 9.1 → 10.2 * 9.2 ← 10.8 * 10.2 *
 10.3 * 10.3 * 10.1 ↘ 9.7 ↑ 9.8 ↘
 beste Teiler 35.3 (24.) 167.0 (26.) 173.3 (27.)
 Trefferlage 0.22 mm rechts, 0.59 mm hoch
 Streuwert 2.00, horizontal: 2.37, vertikal: 1.54

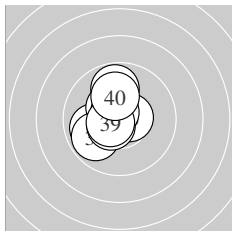

Serie 4:
 9.9 ← 10.6 * 10.4 * 9.9 ↖ 10.6 *
 10.5 * 10.6 * 9.8 ↑ 10.6 * 10.1 ↑
 beste Teiler 77.6 (37.) 90.0 (35.) 91.7 (39.)
 Trefferlage 0.85 mm links, 0.30 mm hoch
 Streuwert 1.17, horizontal: 0.94, vertikal: 1.37

Unterschrift des Schützen

Meyton Elektronik

Ergebnis: **393** (408.9)
 Serien: 98 98 98 99
 Zähler: 33 7 0 0 0 0 0 0 0 0
 Innenzehner: 21
 weiteste: 403 (8), 355 (28), 297 (19)
 beste Teiler 2.0 (5.) 61.0 (29.) 63.1 (9.)
 Trefferlage 0.44 mm links, 0.27 mm tief
 Streuwert 1.37, horizontal: 1.55, vertikal: 1.17

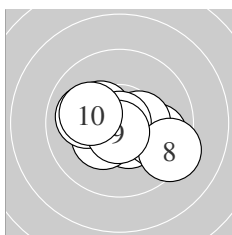
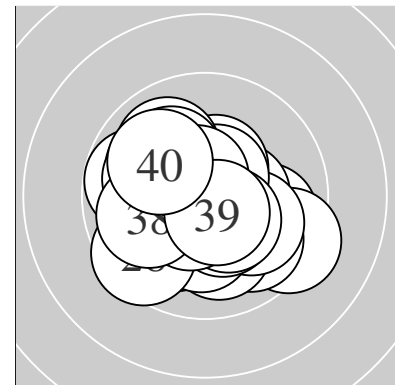

Serie 1:
 10.5 * 10.3 * 9.9 ↘ 10.4 * 10.9 *
 10.3 * 10.0 ← 9.3 ↘ 10.7 * 10.1 ←
 beste Teiler 2.0 (5.) 63.1 (9.) 116.2 (1.)
 Trefferlage 0.11 mm rechts, 0.34 mm tief
 Streuwert 1.51, horizontal: 1.95, vertikal: 0.87

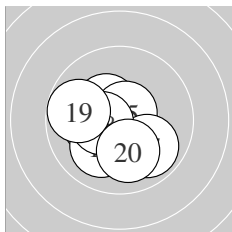

Serie 2:
 10.6 * 10.2 * 10.4 * 10.0 ↘ 10.7 *
 10.1 ↗ 9.9 ↘ 10.4 * 9.8 ← 10.0 ↓
 beste Teiler 66.8 (15.) 88.4 (11.) 126.9 (18.)
 Trefferlage 0.40 mm links, 0.65 mm tief
 Streuwert 1.38, horizontal: 1.55, vertikal: 1.19

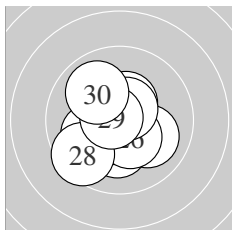

Serie 3:
 10.0 ↘ 10.1 ← 10.4 * 10.2 * 10.5 *
 10.4 * 10.6 * 9.5 ↗ 10.7 * 9.9 ↘
 beste Teiler 61.0 (29.) 92.7 (27.) 101.0 (25.)
 Trefferlage 0.36 mm links, 0.43 mm tief
 Streuwert 1.40, horizontal: 1.39, vertikal: 1.41

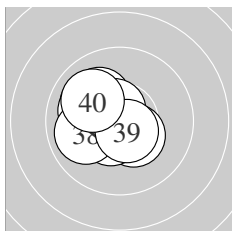

Serie 4:
 10.1 ↘ 10.6 * 10.4 * 10.0 ↘ 10.5 *
 10.0 ↘ 10.0 ← 9.9 ← 10.6 * 10.0 ↘
 beste Teiler 85.8 (32.) 87.4 (39.) 111.7 (35.)
 Trefferlage 1.12 mm links, 0.34 mm hoch
 Streuwert 1.14, horizontal: 1.19, vertikal: 1.08

Unterschrift des Schützen

Meyton Elektronik

Ergebnis:	380	(398.7)
Serien:	95 96 95 94	
Zähler:	22 16 2 0 0 0 0 0 0 0	
Innenzehner:	19	
weiteste:	705 (1), 513 (12), 435 (28)	
beste Teiler	42.9 (22.) 52.4 (19.) 65.8 (9.)	
Trefferlage	0.16 mm rechts, 0.27 mm hoch	
Streuwert	2.01, horizontal: 2.38, vertikal: 1.55	

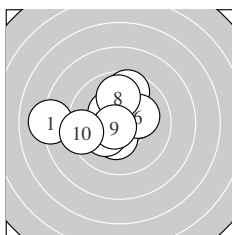
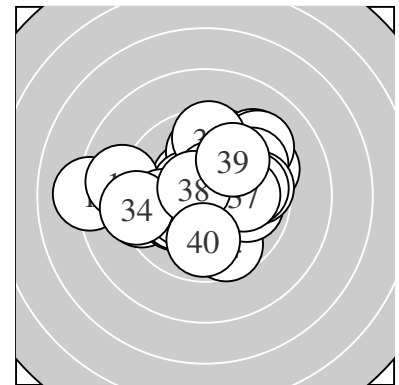

Serie 1:				
8.1 ←	10.3 *	9.6 ↑	10.4 *	10.4 *
10.2 *	10.2 *	9.9 ↑	10.7 *	9.4 ←
beste Teiler	65.8 (9.)	144.2 (5.)	150.6 (4.)	
Trefferlage	1.01 mm links, 0.44 mm hoch			
Streuwert	2.19, horizontal: 2.68, vertikal: 1.55			

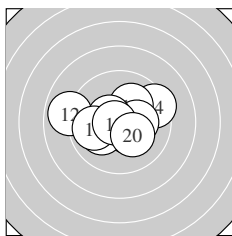

Serie 2:				
10.4 *	8.9 ←	10.1 ↙	9.4 ↗	10.1 ↗
10.3 *	10.5 *	9.9 ←	10.7 *	10.2 *
beste Teiler	52.4 (19.)	115.8 (17.)	126.2 (11.)	
Trefferlage	0.24 mm links, 0.07 mm hoch			
Streuwert	1.92, horizontal: 2.48, vertikal: 1.09			

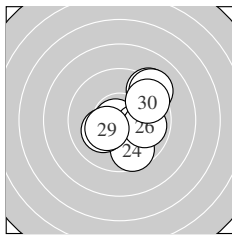

Serie 3:				
10.4 *	10.8 *	10.2 *	9.7 ↘	9.3 ↘
9.9 →	10.2 *	9.2 ↗	10.3 *	9.6 ↗
beste Teiler	42.9 (22.)	143.2 (21.)	154.4 (29.)	
Trefferlage	1.17 mm rechts, 0.04 mm hoch			
Streuwert	1.89, horizontal: 1.80, vertikal: 1.97			

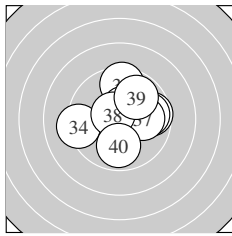

Serie 4:				
10.3 *	9.5 ↑	9.7 →	9.3 ←	10.5 *
9.8 →	10.0 →	10.6 *	9.8 ↗	9.9 ↓
beste Teiler	83.6 (38.)	117.7 (35.)	168.4 (31.)	
Trefferlage	0.74 mm rechts, 0.53 mm hoch			
Streuwert	1.92, horizontal: 2.16, vertikal: 1.65			

Unterschrift des Schützen

Ergebnis: **379** (397.3)
 Serien: 98 94 96 91
 Zähler: 22 15 3 0 0 0 0 0 0 0
 Innenzehner: 16
 weiteste: 660 (13), 534 (40), 528 (31)
 beste Teiler 46.0 (30.) 64.2 (28.) 74.0 (4.)
 Trefferlage 0.73 mm links, 0.83 mm hoch
 Streuwert 1.93, horizontal: 2.09, vertikal: 1.75

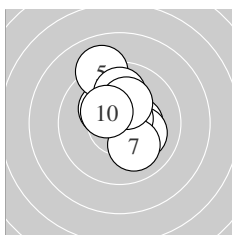
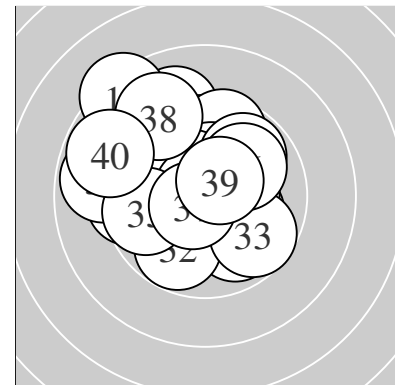

Serie 1:
 10.4 * 10.2 * 10.2 * 10.7 * 9.1 ↗
 10.6 * 10.1 ↘ 9.9 ↑ 10.2 * 10.4 *
 beste Teiler 74.0 (4.) 92.1 (6.) 147.9 (10.)
 Trefferlage 0.18 mm rechts, 0.94 mm hoch
 Streuwert 1.49, horizontal: 1.18, vertikal: 1.75

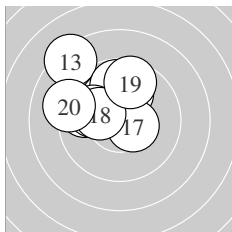

Serie 2:
 10.0 ↗ 9.7 ← 8.3 ↘ 10.1 ↘ 9.8 ↑
 10.0 ← 10.5 * 10.2 * 9.6 ↑ 9.2 ←
 beste Teiler 123.3 (17.) 179.6 (18.) 210.1 (14.)
 Trefferlage 1.41 mm links, 1.81 mm hoch
 Streuwert 1.84, horizontal: 2.03, vertikal: 1.62

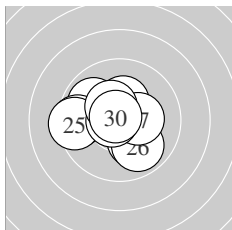

Serie 3:
 10.1 ↘ 9.9 ↘ 9.5 ← 10.3 * 9.4 ←
 9.9 ↘ 10.3 * 10.7 * 10.4 * 10.8 *
 beste Teiler 46.0 (30.) 64.2 (28.) 137.0 (29.)
 Trefferlage 0.67 mm links, 0.01 mm hoch
 Streuwert 1.65, horizontal: 1.99, vertikal: 1.23

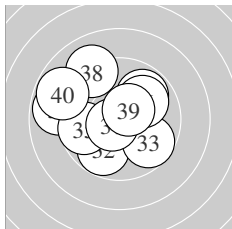

Serie 4:
 8.8 ← 9.8 ↙ 9.7 ↘ 9.8 ↗ 9.7 ←
 10.0 ↗ 10.6 * 9.1 ↘ 10.5 * 8.8 ←
 beste Teiler 80.6 (37.) 109.6 (39.) 245.4 (36.)
 Trefferlage 1.04 mm links, 0.56 mm hoch
 Streuwert 2.46, horizontal: 2.82, vertikal: 2.03

Unterschrift des Schützen

Meyton Elektronik

Ergebnis: **379** (397.4)
 Serien: 93 95 95 96
 Zähler: 23 13 4 0 0 0 0 0 0 0
 Innenzehner: 17
 weiteste: 709 (3), 585 (30), 531 (17)
 beste Teiler 2.0 (26.) 46.2 (12.) 58.0 (16.)
 Trefferlage 0.32 mm links, 0.02 mm tief
 Streuwert 2.13, horizontal: 2.27, vertikal: 1.98

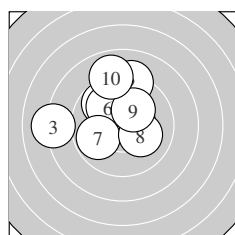
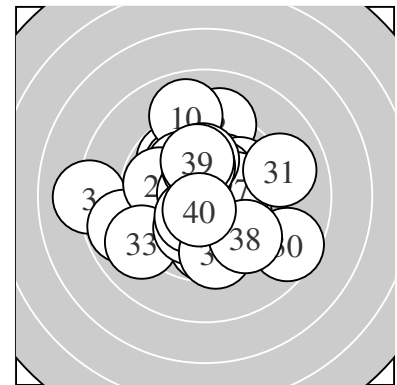

Serie 1:
 10.2 * 9.2 ↑ 8.1 ← 9.8 ↘ 10.5 *
 10.0 ↘ 9.8 ← 10.1 ↘ 10.2 * 8.9 ↑
 beste Teiler 118.1 (5.) 182.2 (1.) 190.3 (9.)
 Trefferlage 0.83 mm links, 1.46 mm hoch
 Streuwert 2.38, horizontal: 2.68, vertikal: 2.05

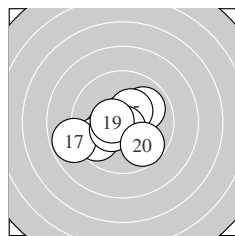

Serie 2:
 9.9 ↗ 10.8 * 10.2 * 9.7 ↙ 10.4 *
 10.7 * 8.8 ← 10.4 * 10.5 * 9.7 ↘
 beste Teiler 46.2 (12.) 58.0 (16.) 107.6 (19.)
 Trefferlage 0.64 mm links, 0.49 mm tief
 Streuwert 1.76, horizontal: 2.16, vertikal: 1.26

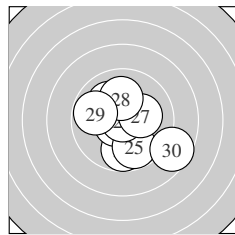

Serie 3:
 10.1 ↘ 9.8 ↓ 10.4 * 10.6 * 9.8 ↓
 10.9 * 10.2 * 10.1 ↑ 9.8 ← 8.6 ↘
 beste Teiler 2.0 (26.) 80.7 (24.) 146.1 (23.)
 Trefferlage 0.16 mm rechts, 0.35 mm tief
 Streuwert 2.04, horizontal: 2.16, vertikal: 1.91

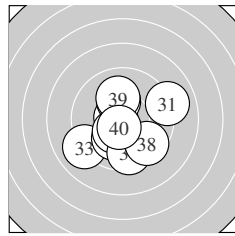

Serie 4:
 9.0 → 10.7 * 9.0 ↙ 10.2 * 10.1 ↙
 10.3 * 9.6 ↓ 9.6 ↘ 10.1 ↑ 10.6 *
 beste Teiler 72.0 (32.) 92.3 (40.) 151.9 (36.)
 Trefferlage 0.00 mm , 0.71 mm tief
 Streuwert 2.14, horizontal: 2.24, vertikal: 2.04

Unterschrift des Schützen

Meyton Elektronik

Ergebnis: **359** (377.9)
 Serien: 86 91 89 93
 Zähler: 9 24 4 3 0 0 0 0 0 0
 Innenzehner: 3
 weiteste: 912 (30), 793 (7), 771 (1)
 beste Teiler 152.7 (15.) 172.2 (11.) 184.6 (25.)
 Trefferlage 0.16 mm links, 1.08 mm tief
 Streuwert 2.85, horizontal: 3.46, vertikal: 2.06

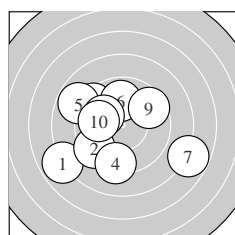
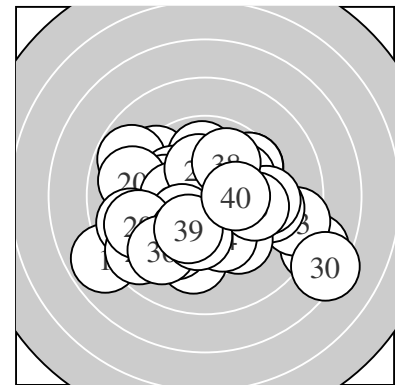

Serie 1:
 7.9 ↙ 9.4 ↙ 9.4 ↘ 9.3 ↓ 8.8 ↘
 9.9 ↑ 7.8 ↘ 10.0 ↘ 9.6 ↗ 9.9 ←
 beste Teiler 231.6 (8.) 264.8 (10.) 265.7 (6.)
 Trefferlage 1.32 mm links, 0.33 mm tief
 Streuwert 3.44, horizontal: 3.94, vertikal: 2.86

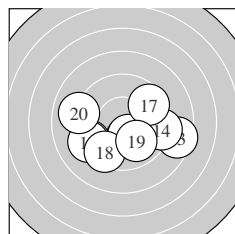

Serie 2:
 10.3 * 9.3 ↙ 8.5 → 9.2 → 10.3 *
 9.2 ↙ 9.6 ↗ 9.4 ↓ 9.9 ↘ 9.0 ←
 beste Teiler 152.7 (15.) 172.2 (11.) 254.0 (19.)
 Trefferlage 0.15 mm rechts, 1.20 mm tief
 Streuwert 2.78, horizontal: 3.62, vertikal: 1.55

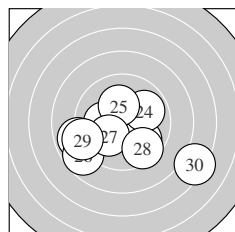

Serie 3:
 9.8 ↘ 10.1 ← 8.9 ↙ 9.9 ↗ 10.2 *
 8.7 ↙ 10.1 ↙ 9.5 ↘ 9.1 ← 7.3 ↘
 beste Teiler 184.6 (25.) 202.0 (22.) 210.0 (27.)
 Trefferlage 0.30 mm links, 1.50 mm tief
 Streuwert 3.16, horizontal: 3.99, vertikal: 2.01

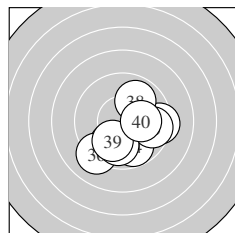

Serie 4:
 9.3 → 10.1 → 9.8 ↓ 9.8 ↘ 9.6 →
 9.1 ↙ 9.9 ↓ 9.9 ↗ 10.0 ↓ 10.1 →
 beste Teiler 201.0 (40.) 206.8 (32.) 241.9 (39.)
 Trefferlage 0.80 mm rechts, 1.29 mm tief
 Streuwert 1.96, horizontal: 2.18, vertikal: 1.72

Unterschrift des Schützen

Ergebnis:	380	(398.0)
Serien:	94 95 96 95	
Zähler:	21 18 1 0 0 0 0 0 0 0	
Innenzehner:	16	
weiteste:	521 (6), 489 (22), 442 (26)	
beste Teiler	1.4 (25.) 47.6 (37.) 89.6 (38.)	
Trefferlage	0.50 mm rechts, 0.14 mm tief	
Streuwert	1.99, horizontal: 2.25, vertikal: 1.69	

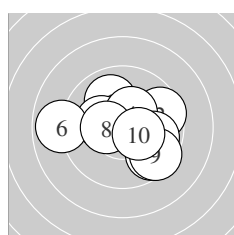
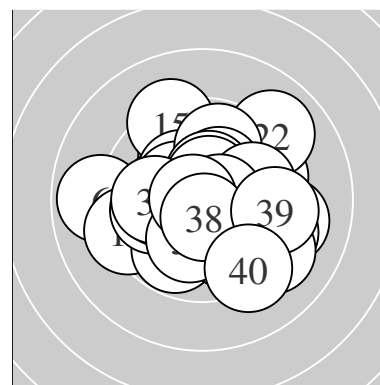

Serie 1:					
	10.0 ↖	9.6 →	10.2 *	10.4 *	9.6 ↘
	8.9 ←	9.9 →	10.4 *	9.5 ↘	10.4 *
beste Teiler	137.0 (8.)	143.0 (4.)	147.4 (10.)		
Trefferlage	0.38 mm rechts, 0.09 mm tief				
Streuwert	2.18, horizontal: 2.70, vertikal: 1.48				

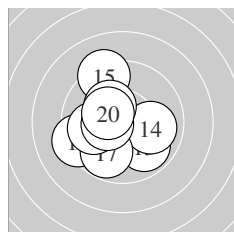

Serie 2:					
	10.3 *	9.3 ←	9.9 ↘	10.0 →	9.2 ↖
	10.3 *	9.8 ↙	9.9 ←	10.4 *	10.4 *
beste Teiler	132.2 (19.)	147.1 (20.)	169.0 (11.)		
Trefferlage	0.75 mm links, 0.24 mm tief				
Streuwert	1.92, horizontal: 1.95, vertikal: 1.89				

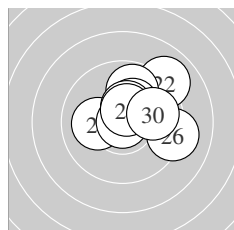

Serie 3:					
	10.1 ←	9.0 ↗	9.8 ↑	10.3 *	10.9 *
	9.2 →	10.3 *	10.4 *	10.5 *	9.9 →
beste Teiler	1.4 (25.)	109.7 (29.)	134.8 (28.)		
Trefferlage	1.14 mm rechts, 1.07 mm hoch				
Streuwert	1.61, horizontal: 1.87, vertikal: 1.32				

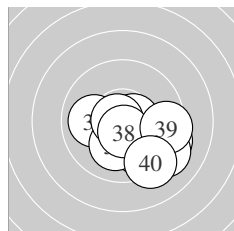

Serie 4:					
	10.0 ←	9.3 →	9.2 ↘	10.6 *	9.9 ↘
	10.1 ↙	10.8 *	10.6 *	9.4 →	9.3 ↘
beste Teiler	47.6 (37.)	89.6 (38.)	91.4 (34.)		
Trefferlage	1.23 mm rechts, 1.33 mm tief				
Streuwert	1.75, horizontal: 2.12, vertikal: 1.27				

Unterschrift des Schützen

Meyton Elektronik