

Ergebnis: **387** (405.0)  
 Serien: 95 95 98 99  
 Zähler: 28 11 1 0 0 0 0 0 0 0  
 Innenzehner: 23  
 weiteste: 549 (11), 466 (7), 447 (31)  
 beste Teiler 57.2 (12.) 76.5 (38.) 86.4 (19.)  
 Trefferlage 0.28 mm rechts, 0.02 mm hoch  
 Streuwert 1.69, horizontal: 1.95, vertikal: 1.39

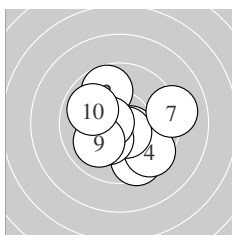

Serie 1:  
 10.5 \*                      9.8 ↗                      9.5 ↘                      9.5 ↘                      10.6 \*  
 10.3 \*                      9.1 →                      10.6 \*                      10.0 ↖                      9.9 ↖  
 beste Teiler 97.3 (8.) 97.9 (5.) 116.6 (1.)  
 Trefferlage 0.28 mm rechts, 0.50 mm tief  
 Streuwert 1.99, horizontal: 2.16, vertikal: 1.81

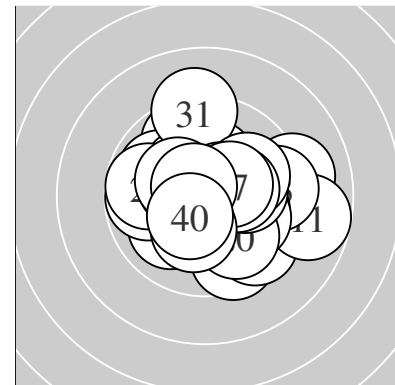
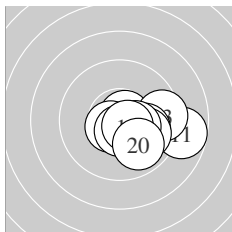

Serie 2:  
 8.8 →                      10.7 \*                      9.5 →                      10.6 \*                      10.0 →  
 9.9 ↘                      10.4 \*                      10.6 \*                      10.6 \*                      9.9 ↘  
 beste Teiler 57.2 (12.) 86.4 (19.) 92.0 (18.)  
 Trefferlage 1.69 mm rechts, 0.69 mm tief  
 Streuwert 1.38, horizontal: 1.81, vertikal: 0.72

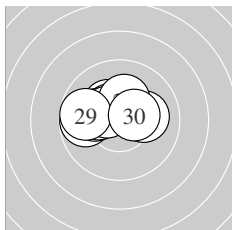

Serie 3:  
 10.3 \*                      10.5 \*                      10.1 →                      9.8 ←                      10.1 ←  
 10.2 \*                      10.4 \*                      10.2 \*                      9.8 ←                      10.4 \*  
 beste Teiler 125.2 (22.) 129.8 (27.) 134.4 (30.)  
 Trefferlage 0.91 mm links, 0.67 mm hoch  
 Streuwert 1.26, horizontal: 1.71, vertikal: 0.52

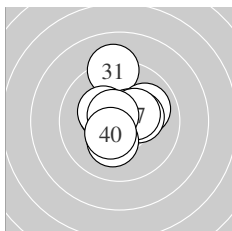

Serie 4:  
 9.2 ↑                      10.0 ↗                      10.4 \*                      10.6 \*                      10.3 \*  
 10.3 \*                      10.4 \*                      10.6 \*                      10.2 \*                      10.4 \*  
 beste Teiler 76.5 (38.) 100.9 (34.) 132.2 (40.)  
 Trefferlage 0.07 mm rechts, 0.60 mm hoch  
 Streuwert 1.46, horizontal: 1.30, vertikal: 1.61

Unterschrift des Schützen

Meyton Elektronik

Ergebnis: **380** (398.4)  
 Serien: 94 95 97 94  
 Zähler: 24 12 4 0 0 0 0 0 0 0  
 Innenzehner: 18  
 weiteste: 696 (9), 667 (14), 631 (8)  
 beste Teiler 27.6 (12.) 52.1 (15.) 60.5 (3.)  
 Trefferlage 0.23 mm links, 0.11 mm hoch  
 Streuwert 2.13, horizontal: 2.33, vertikal: 1.90

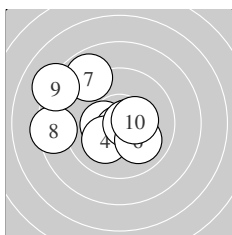
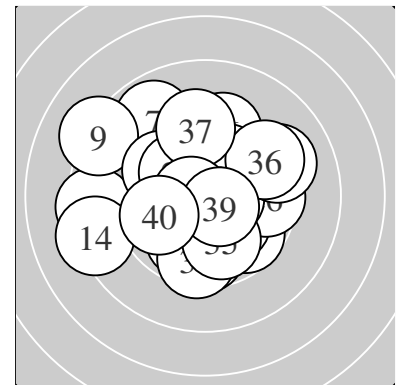

Serie 1:  
 10.6 \*                      10.3 \*                      10.7 \*                      10.1 ↙                      10.7 \*  
 10.0 ↘                      8.9 ↘                      8.4 ←                      8.2 ↘                      10.4 \*  
 beste Teiler 60.5 (3.) 65.1 (5.) 85.0 (1.)  
 Trefferlage 1.35 mm links, 0.34 mm hoch  
 Streuwert 2.50, horizontal: 2.93, vertikal: 1.97

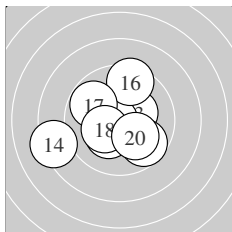

Serie 2:  
 10.3 \*                      10.8 \*                      10.3 \*                      8.3 ←                      10.7 \*  
 9.4 ↑                      9.8 ↘                      10.3 \*                      9.7 ↘                      10.1 ↘  
 beste Teiler 27.6 (12.) 52.1 (15.) 156.5 (13.)  
 Trefferlage 0.54 mm links, 0.27 mm tief  
 Streuwert 2.19, horizontal: 2.50, vertikal: 1.83

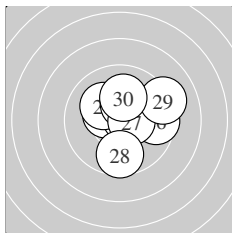

Serie 3:  
 10.3 \*                      10.4 \*                      10.7 \*                      10.1 ↘                      10.3 \*  
 9.6 →                      10.5 \*                      9.7 ↓                      9.1 →                      10.1 ↑  
 beste Teiler 65.3 (23.) 113.5 (27.) 138.9 (22.)  
 Trefferlage 0.83 mm rechts, 0.52 mm hoch  
 Streuwert 1.68, horizontal: 1.80, vertikal: 1.55

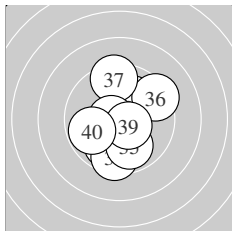

Serie 4:  
 10.1 ↗                      9.9 ↙                      10.5 \*                      9.5 ↓                      9.9 ↘  
 9.4 ↗                      9.4 ↑                      10.6 \*                      10.5 \*                      9.8 ←  
 beste Teiler 79.0 (38.) 103.6 (39.) 120.5 (33.)  
 Trefferlage 0.11 mm rechts, 0.13 mm tief  
 Streuwert 2.03, horizontal: 1.63, vertikal: 2.36

Unterschrift des Schützen

Meyton Elektronik

Ergebnis: **397** (419.5)  
 Serien: 100 100 99 98  
 Zähler: 37 3 0 0 0 0 0 0 0 0  
 Innenzehner: 36  
 weiteste: 363 (36), 278 (33), 273 (23)  
 beste Teiler 11.7 (28.) 37.6 (34.) 43.0 (11.)  
 Trefferlage 0.16 mm rechts, 0.04 mm tief  
 Streuwert 0.95, horizontal: 1.08, vertikal: 0.81

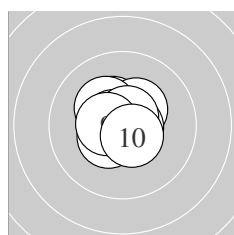
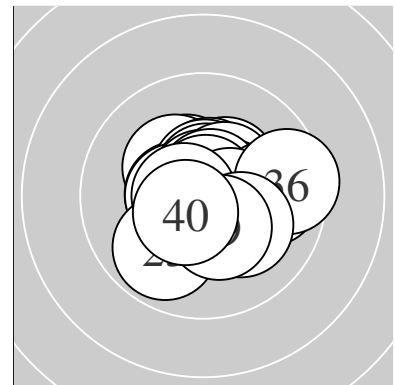

Serie 1:  
 10.7 \*                      10.4 \*                      10.4 \*                      10.4 \*                      10.3 \*  
 10.7 \*                      10.7 \*                      10.7 \*                      10.5 \*                      10.6 \*  
 beste Teiler 64.4 (8.) 68.2 (7.) 69.3 (6.)  
 Trefferlage 0.24 mm links, 0.34 mm hoch  
 Streuwert 0.79, horizontal: 0.82, vertikal: 0.75

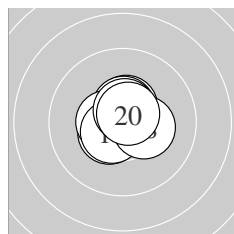

Serie 2:  
 10.8 \*                      10.5 \*                      10.5 \*                      10.6 \*                      10.5 \*  
 10.5 \*                      10.5 \*                      10.3 \*                      10.6 \*                      10.7 \*  
 beste Teiler 43.0 (11.) 71.5 (20.) 86.3 (19.)  
 Trefferlage 0.17 mm links, 0.17 mm hoch  
 Streuwert 0.75, horizontal: 0.81, vertikal: 0.68

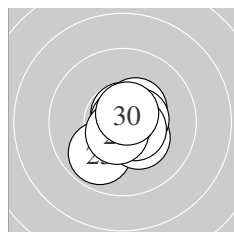

Serie 3:  
 10.7 \*                      10.6 \*                      9.9 ✓                      10.3 \*                      10.4 \*  
 10.5 \*                      10.6 \*                      10.9 \*                      10.6 \*                      10.7 \*  
 beste Teiler 11.7 (28.) 58.0 (21.) 68.8 (30.)  
 Trefferlage 0.20 mm rechts, 0.30 mm tief  
 Streuwert 0.91, horizontal: 0.85, vertikal: 0.96

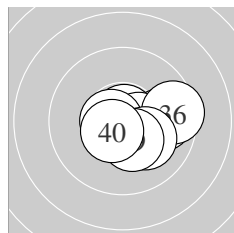

Serie 4:  
 10.7 \*                      10.5 \*                      9.8 →                      10.8 \*                      10.5 \*  
 9.5 →                      10.6 \*                      10.1 ↘                      10.4 \*                      10.5 \*  
 beste Teiler 37.6 (34.) 62.0 (31.) 81.0 (37.)  
 Trefferlage 0.89 mm rechts, 0.39 mm tief  
 Streuwert 1.12, horizontal: 1.43, vertikal: 0.67

Unterschrift des Schützen

Meyton Elektronik

Ergebnis: **380** (397.1)  
 Serien: 93 95 97 95  
 Zähler: 22 17 0 1 0 0 0 0 0 0  
 Innenzehner: 14  
 weiteste: 866 (33), 498 (12), 484 (5)  
 beste Teiler 49.6 (30.) 59.0 (38.) 62.9 (35.)  
 Trefferlage 0.04 mm rechts, 0.39 mm tief  
 Streuwert 2.09, horizontal: 2.39, vertikal: 1.75

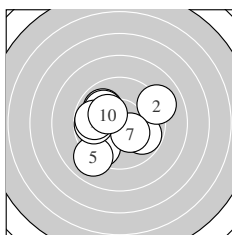
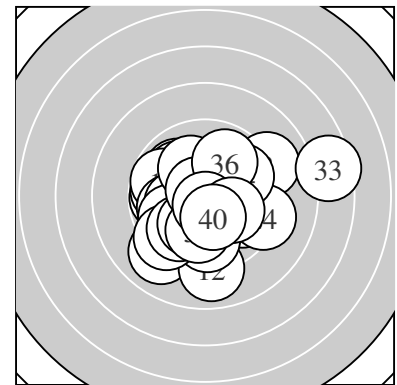

Serie 1:  
 9.8 ↘                      9.1 ↗                      9.6 ↙                      9.9 ↖                      9.0 ↗  
 10.0 ↖                      10.3 \*                      9.8 ←                      9.8 ←                      10.3 \*  
 beste Teiler 161.4 (7.) 170.6 (10.) 238.6 (6.)  
 Trefferlage 0.80 mm links, 0.23 mm tief  
 Streuwert 2.29, horizontal: 2.56, vertikal: 1.98

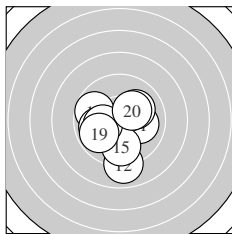

Serie 2:  
 10.0 →                      9.0 ↓                      10.0 ←                      10.1 ↗                      9.8 ↓  
 9.7 ↖                      9.9 ←                      10.2 \*                      9.9 ↙                      10.2 \*  
 beste Teiler 179.6 (20.) 198.6 (18.) 218.8 (14.)  
 Trefferlage 0.58 mm links, 0.78 mm tief  
 Streuwert 1.98, horizontal: 2.00, vertikal: 1.95

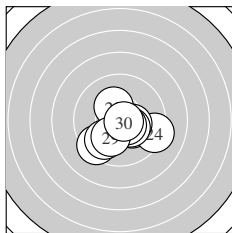

Serie 3:  
 9.4 ↙                      10.3 \*                      10.3 \*                      9.3 ↘                      9.8 ↙  
 10.3 \*                      10.4 \*                      10.6 \*                      10.1 ↙                      10.8 \*  
 beste Teiler 49.6 (30.) 100.4 (28.) 150.0 (27.)  
 Trefferlage 0.33 mm rechts, 0.98 mm tief  
 Streuwert 1.61, horizontal: 1.92, vertikal: 1.23

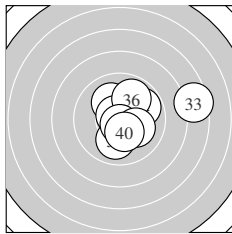

Serie 4:  
 10.3 \*                      10.1 ↖                      7.5 →                      9.8 ↗                      10.7 \*  
 9.9 ↗                      10.0 ↓                      10.7 \*                      10.1 ↘                      10.3 \*  
 beste Teiler 59.0 (38.) 62.9 (35.) 154.7 (31.)  
 Trefferlage 1.24 mm rechts, 0.40 mm hoch  
 Streuwert 2.28, horizontal: 2.78, vertikal: 1.64

Unterschrift des Schützen

Meyton Elektronik

Ergebnis: **380** (402.6)  
 Serien: 96 96 94 94  
 Zähler: 22 16 2 0 0 0 0 0 0 0  
 Innenzehner: 21  
 weiteste: 699 (29), 576 (24), 419 (27)  
 beste Teiler 18.7 (12.) 27.8 (22.) 41.9 (4.)  
 Trefferlage 0.69 mm rechts, 0.58 mm hoch  
 Streuwert 1.77, horizontal: 2.15, vertikal: 1.28

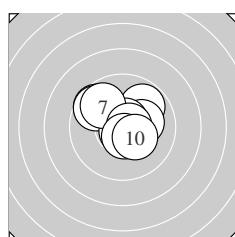
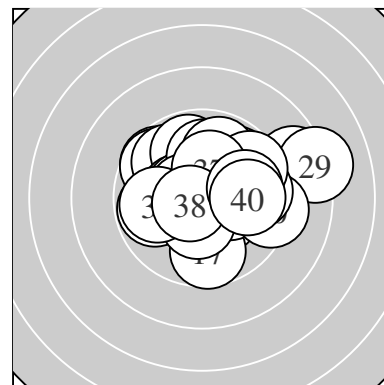

Serie 1:  
 9.6 ↘ 9.8 ↗ 9.7 ↘ 10.8 \* 10.2 \*  
 10.7 \* 9.8 ↘ 10.7 \* 10.6 \* 10.3 \*  
 beste Teiler 41.9 (4.) 65.3 (8.) 67.7 (6.)  
 Trefferlage 0.11 mm links, 0.69 mm hoch  
 Streuwert 1.50, horizontal: 1.72, vertikal: 1.24

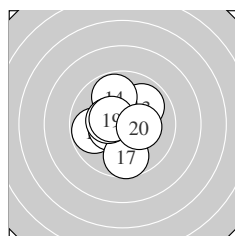

Serie 2:  
 10.5 \* 10.9 \* 9.9 ↗ 9.8 ↑ 9.8 ←  
 10.5 \* 9.7 ↓ 10.4 \* 10.5 \* 10.3 \*  
 beste Teiler 18.7 (12.) 114.2 (11.) 118.1 (19.)  
 Trefferlage 0.24 mm links, 0.06 mm hoch  
 Streuwert 1.51, horizontal: 1.48, vertikal: 1.54

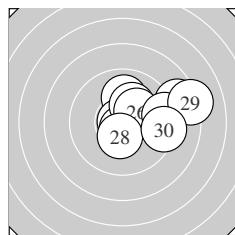

Serie 3:  
 10.0 ↑ 10.8 \* 10.7 \* 8.6 → 10.2 \*  
 10.2 \* 9.3 → 10.4 \* 8.2 → 9.3 →  
 beste Teiler 27.8 (22.) 61.2 (23.) 139.4 (28.)  
 Trefferlage 2.21 mm rechts, 0.72 mm hoch  
 Streuwert 2.07, horizontal: 2.62, vertikal: 1.32

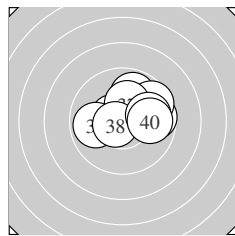

Serie 4:  
 10.2 \* 9.7 → 10.5 \* 9.9 ← 9.9 ↑  
 9.6 ↗ 10.2 \* 10.6 \* 9.9 → 9.9 →  
 beste Teiler 79.2 (38.) 102.6 (33.) 180.6 (37.)  
 Trefferlage 0.91 mm rechts, 0.84 mm hoch  
 Streuwert 1.54, horizontal: 1.93, vertikal: 1.02

Unterschrift des Schützen

Meyton Elektronik

Ergebnis: **386** (404.6)  
 Serien: 98 96 94 98  
 Zähler: 27 12 1 0 0 0 0 0 0 0  
 Innenzehner: 22  
 weiteste: 584 (23), 448 (37), 438 (27)  
 beste Teiler 24.6 (5.) 84.7 (40.) 87.2 (10.)  
 Trefferlage 0.28 mm rechts, 0.20 mm hoch  
 Streuwert 1.71, horizontal: 1.95, vertikal: 1.42

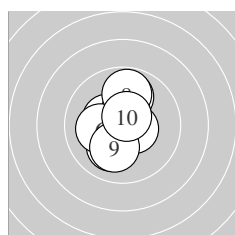
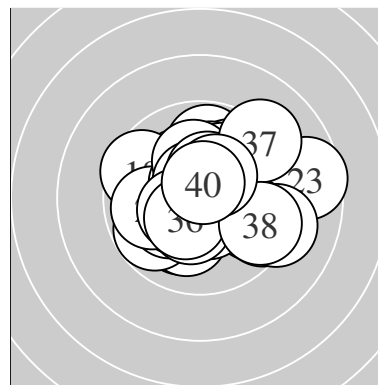

Serie 1:  
 10.1 ↘ 10.4 \* 9.9 ↑ 10.5 \* 10.9 \*  
 10.1 ← 10.5 \* 9.8 ↑ 10.1 ↓ 10.6 \*  
 beste Teiler 24.6 (5.) 87.2 (10.) 104.9 (7.)  
 Trefferlage 0.23 mm links, 0.33 mm hoch  
 Streuwert 1.33, horizontal: 0.98, vertikal: 1.61

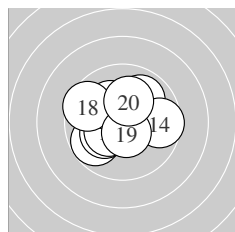

Serie 2:  
 10.3 \* 9.8 ↙ 9.9 ↗ 9.6 → 10.2 \*  
 10.4 \* 10.2 \* 9.6 ↖ 10.6 \* 10.2 \*  
 beste Teiler 100.9 (19.) 149.7 (16.) 173.2 (11.)  
 Trefferlage 0.52 mm links, 0.13 mm hoch  
 Streuwert 1.72, horizontal: 1.97, vertikal: 1.42

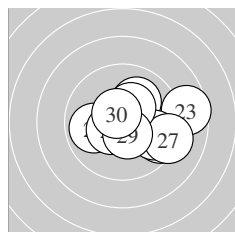

Serie 3:  
 10.1 ↗ 9.9 ← 8.6 → 9.5 ↘ 9.7 ↘  
 10.5 \* 9.2 ↘ 10.3 \* 10.5 \* 10.6 \*  
 beste Teiler 94.8 (30.) 117.0 (29.) 124.2 (26.)  
 Trefferlage 1.44 mm rechts, 0.14 mm tief  
 Streuwert 2.02, horizontal: 2.57, vertikal: 1.26

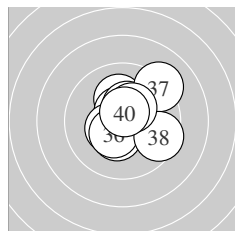

Serie 4:  
 10.4 \* 10.1 ↑ 10.6 \* 10.4 \* 10.4 \*  
 10.4 \* 9.2 ↗ 9.5 ↘ 10.4 \* 10.6 \*  
 beste Teiler 84.7 (40.) 92.1 (33.) 133.8 (35.)  
 Trefferlage 0.47 mm rechts, 0.48 mm hoch  
 Streuwert 1.55, horizontal: 1.58, vertikal: 1.53

Unterschrift des Schützen

Ergebnis: **377** (394.9)  
 Serien: 94 91 97 95  
 Zähler: 19 19 2 0 0 0 0 0 0 0  
 Innenzehner: 12  
 weiteste: 593 (7), 510 (20), 493 (40)  
 beste Teiler 42.9 (9.) 60.0 (11.) 72.0 (38.)  
 Trefferlage 0.62 mm links, 0.52 mm hoch  
 Streuwert 2.08, horizontal: 2.28, vertikal: 1.86

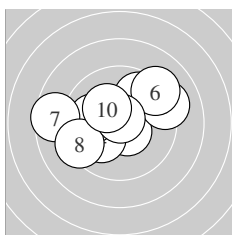
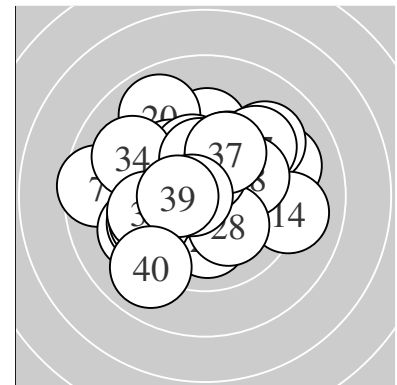

Serie 1:  
 10.5 \* 9.8 ↗ 9.2 ↘ 10.1 ↙ 10.0 ←  
 9.2 ↗ 8.6 ← 9.3 ↙ 10.8 \* 10.2 \*  
 beste Teiler 42.9 (9.) 103.2 (1.) 180.2 (10.)  
 Trefferlage 0.48 mm links, 0.58 mm hoch  
 Streuwert 2.48, horizontal: 3.12, vertikal: 1.58

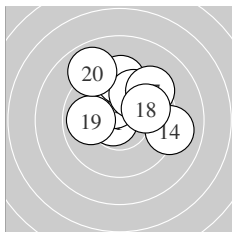

Serie 2:  
 10.7 \* 9.8 ↑ 10.3 \* 9.1 → 9.5 ↑  
 9.9 ↗ 9.4 ↗ 9.9 ↘ 9.9 ← 8.9 ↘  
 beste Teiler 60.0 (11.) 156.8 (13.) 262.7 (18.)  
 Trefferlage 0.54 mm rechts, 1.76 mm hoch  
 Streuwert 2.04, horizontal: 2.29, vertikal: 1.76

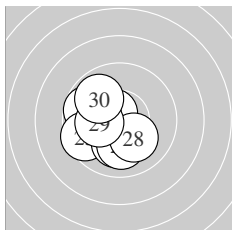

Serie 3:  
 10.4 \* 10.5 \* 10.6 \* 9.7 ↖ 9.6 ←  
 10.1 ↓ 10.0 ↓ 10.1 ↘ 10.2 \* 9.9 ↘  
 beste Teiler 87.0 (23.) 117.3 (22.) 147.2 (21.)  
 Trefferlage 1.03 mm links, 0.65 mm tief  
 Streuwert 1.41, horizontal: 1.41, vertikal: 1.41

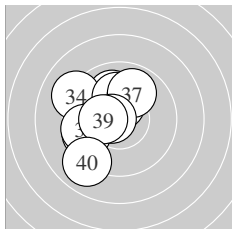

Serie 4:  
 10.0 ↖ 10.4 \* 9.6 ← 9.1 ↖ 10.1 ↑  
 9.6 ← 9.9 ↗ 10.7 \* 10.3 \* 9.0 ↙  
 beste Teiler 72.0 (38.) 128.1 (32.) 151.0 (39.)  
 Trefferlage 1.52 mm links, 0.39 mm hoch  
 Streuwert 1.87, horizontal: 1.69, vertikal: 2.04

Unterschrift des Schützen

Meyton Elektronik

Ergebnis: **381** (400.0)  
 Serien: 97 94 96 94  
 Zähler: 23 15 2 0 0 0 0 0 0 0  
 Innenzehner: 18  
 weiteste: 615 (38), 501 (35), 493 (5)  
 beste Teiler 9.8 (34.) 19.2 (8.) 44.2 (22.)  
 Trefferlage 0.60 mm rechts, 0.11 mm hoch  
 Streuwert 1.94, horizontal: 2.25, vertikal: 1.56

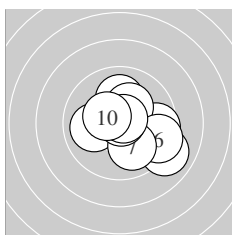
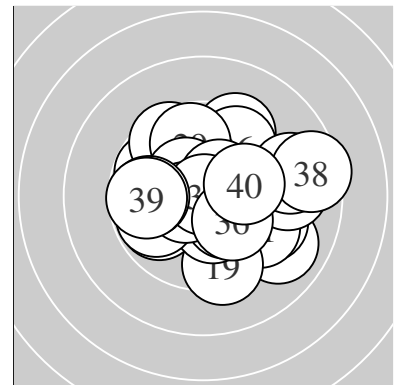

Serie 1:  
 10.0 ←                      10.1 ↑                      9.6 →                      10.3 \*                      9.0 ↘  
 9.4 ↘                      10.0 ↓                      10.9 \*                      10.7 \*                      10.4 \*  
 beste Teiler 19.2 (8.) 53.9 (9.) 133.8 (10.)  
 Trefferlage 1.01 mm rechts, 0.20 mm tief  
 Streuwert 1.85, horizontal: 2.13, vertikal: 1.53

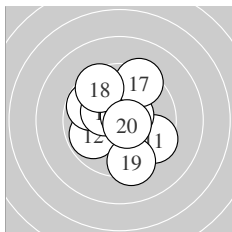

Serie 2:  
 9.5 ↘                      9.8 ↖                      9.8 ↗                      10.3 \*                      10.7 \*  
 10.5 \*                      9.4 ↗                      9.6 ↘                      9.4 ↓                      10.6 \*  
 beste Teiler 61.6 (15.) 77.8 (20.) 103.3 (16.)  
 Trefferlage 0.02 mm links, 0.21 mm hoch  
 Streuwert 2.07, horizontal: 1.95, vertikal: 2.17

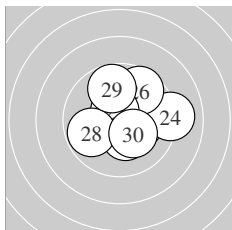

Serie 3:  
 10.5 \*                      10.8 \*                      10.2 \*                      9.1 →                      10.3 \*  
 9.6 ↗                      10.6 \*                      9.8 ↖                      9.8 ↑                      10.2 \*  
 beste Teiler 44.2 (22.) 93.5 (27.) 107.7 (21.)  
 Trefferlage 0.67 mm rechts, 0.10 mm hoch  
 Streuwert 1.77, horizontal: 1.93, vertikal: 1.61

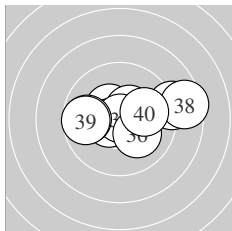

Serie 4:  
 10.4 \*                      10.5 \*                      10.4 \*                      10.9 \*                      8.9 →  
 10.1 ↘                      9.7 ←                      8.5 →                      9.7 ←                      10.0 →  
 beste Teiler 9.8 (34.) 103.4 (32.) 126.5 (33.)  
 Trefferlage 0.76 mm rechts, 0.33 mm hoch  
 Streuwert 2.23, horizontal: 3.04, vertikal: 0.85

Unterschrift des Schützen

Meyton Elektronik



Ergebnis: **397** (416.9)  
 Serien: 100 99 99 99  
 Zähler: 37 3 0 0 0 0 0 0 0 0  
 Innenzehner: 31  
 weiteste: 325 (29), 297 (38), 289 (16)  
 beste Teiler 14.3 (5.) 29.4 (12.) 31.3 (26.)  
 Trefferlage 0.10 mm links, 0.29 mm hoch  
 Streuwert 1.08, horizontal: 1.19, vertikal: 0.95

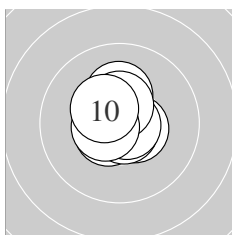
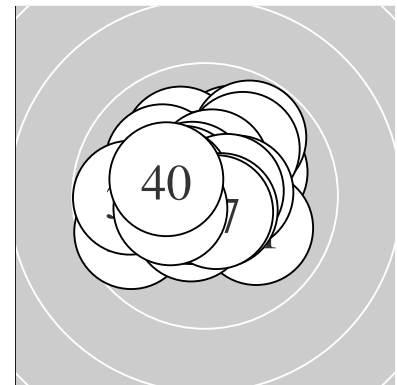

Serie 1:  
 10.6 \*                      10.5 \*                      10.2 \*                      10.8 \*                      10.9 \*  
 10.7 \*                      10.8 \*                      10.5 \*                      10.6 \*                      10.4 \*  
 beste Teiler 14.3 (5.) 49.0 (7.) 49.6 (4.)  
 Trefferlage 0.15 mm links, 0.23 mm hoch  
 Streuwert 0.73, horizontal: 0.64, vertikal: 0.81

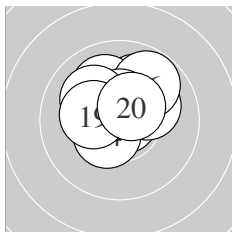

Serie 2:  
 10.0 ↗                      10.8 \*                      10.0 ↘                      10.5 \*                      10.1 ↗  
 9.8 ↗                      10.5 \*                      10.1 ↘                      10.3 \*                      10.5 \*  
 beste Teiler 29.4 (12.) 112.0 (17.) 119.0 (20.)  
 Trefferlage 0.05 mm rechts, 1.03 mm hoch  
 Streuwert 1.17, horizontal: 1.31, vertikal: 1.01

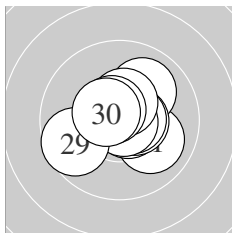

Serie 3:  
 10.0 ↘                      10.0 ↗                      10.7 \*                      10.6 \*                      10.6 \*  
 10.8 \*                      10.5 \*                      10.6 \*                      9.7 ←                      10.5 \*  
 beste Teiler 31.3 (26.) 63.5 (23.) 83.0 (25.)  
 Trefferlage 0.21 mm rechts, 0.10 mm hoch  
 Streuwert 1.22, horizontal: 1.40, vertikal: 1.01

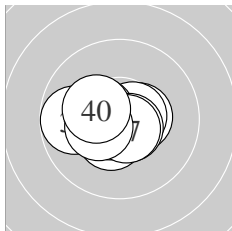

Serie 4:  
 10.4 \*                      10.5 \*                      10.6 \*                      10.7 \*                      10.4 \*  
 10.6 \*                      10.6 \*                      9.8 ←                      10.4 \*                      10.3 \*  
 beste Teiler 73.6 (34.) 77.6 (37.) 83.5 (36.)  
 Trefferlage 0.51 mm links, 0.18 mm tief  
 Streuwert 1.01, horizontal: 1.31, vertikal: 0.56

Unterschrift des Schützen

Meyton Elektronik

Ergebnis: **394** (412.5)  
 Serien: 99 98 99 98  
 Zähler: 34 6 0 0 0 0 0 0 0 0  
 Innenzehner: 26  
 weiteste: 376 (20), 330 (29), 290 (13)  
 beste Teiler 28.6 (33.) 34.0 (26.) 34.3 (19.)  
 Trefferlage 0.03 mm rechts, 0.16 mm tief  
 Streuwert 1.30, horizontal: 1.37, vertikal: 1.22

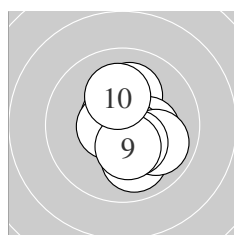
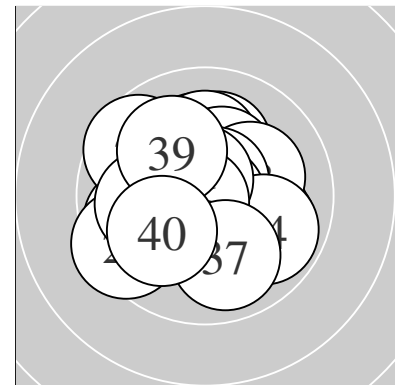

Serie 1:  
 10.0 ↘ 10.6 \* 10.1 ↑ 10.3 \* 10.6 \*  
 10.6 \* 9.9 ↘ 10.4 \* 10.4 \* 10.2 \*  
 beste Teiler 84.1 (2.) 85.7 (5.) 90.4 (6.)  
 Trefferlage 0.51 mm rechts, 0.25 mm tief  
 Streuwert 1.22, horizontal: 0.97, vertikal: 1.43

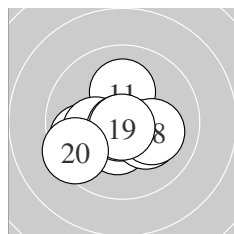

Serie 2:  
 10.1 ↑ 10.5 \* 9.8 ↙ 10.2 \* 10.4 \*  
 10.8 \* 10.2 \* 10.1 ↘ 10.8 \* 9.4 ↙  
 beste Teiler 34.3 (19.) 44.7 (16.) 117.8 (12.)  
 Trefferlage 0.38 mm links, 0.58 mm tief  
 Streuwert 1.43, horizontal: 1.74, vertikal: 1.04

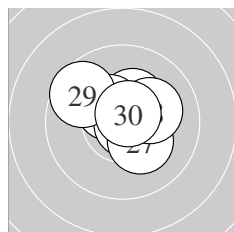

Serie 3:  
 10.7 \* 10.6 \* 10.6 \* 10.3 \* 10.4 \*  
 10.8 \* 10.2 \* 10.2 \* 9.6 ↘ 10.7 \*  
 beste Teiler 34.0 (26.) 61.5 (21.) 67.9 (30.)  
 Trefferlage 0.15 mm rechts, 0.62 mm hoch  
 Streuwert 1.07, horizontal: 1.24, vertikal: 0.87

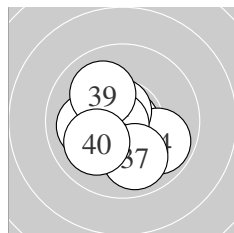

Serie 4:  
 10.8 \* 10.1 ↘ 10.8 \* 9.9 ↘ 10.7 \*  
 10.8 \* 9.9 ↘ 10.0 ↙ 10.0 ↘ 10.0 ↙  
 beste Teiler 28.6 (33.) 43.6 (31.) 50.5 (36.)  
 Trefferlage 0.12 mm links, 0.44 mm tief  
 Streuwert 1.36, horizontal: 1.47, vertikal: 1.24

Unterschrift des Schützen

Ergebnis: **393** (409.6)  
 Serien: 99 98 99 97  
 Zähler: 33 7 0 0 0 0 0 0 0 0  
 Innenzehner: 24  
 weiteste: 367 (35), 304 (12), 304 (31)  
 beste Teiler 23.0 (22.) 41.5 (2.) 64.4 (17.)  
 Trefferlage 0.51 mm links, 0.56 mm hoch  
 Streuwert 1.28, horizontal: 1.46, vertikal: 1.07

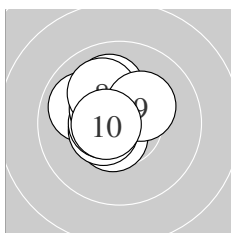
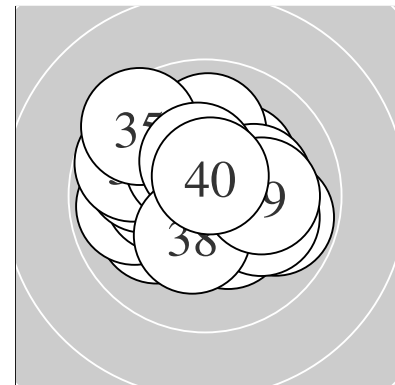

Serie 1:  
 9.9 ↖ 10.8 \* 10.6 \* 10.5 \* 10.5 \*  
 10.0 ↑ 10.4 \* 10.1 ↘ 10.3 \* 10.6 \*  
 beste Teiler 41.5 (2.) 86.2 (10.) 96.1 (3.)  
 Trefferlage 0.74 mm links, 0.58 mm hoch  
 Streuwert 0.96, horizontal: 0.92, vertikal: 1.01

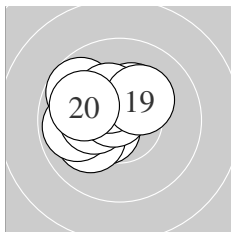

Serie 2:  
 10.5 \* 9.7 ↖ 10.3 \* 10.1 ↙ 9.9 ←  
 10.3 \* 10.7 \* 10.3 \* 10.2 \* 10.0 ↘  
 beste Teiler 64.4 (17.) 109.2 (11.) 156.9 (18.)  
 Trefferlage 1.09 mm links, 0.53 mm hoch  
 Streuwert 1.19, horizontal: 1.35, vertikal: 1.00

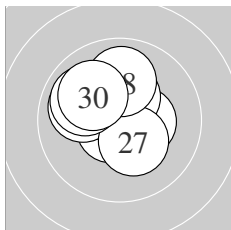

Serie 3:  
 10.4 \* 10.9 \* 10.7 \* 10.4 \* 10.3 \*  
 10.0 ↖ 10.3 \* 10.0 ↑ 9.9 ↖ 10.0 ↘  
 beste Teiler 23.0 (22.) 72.1 (23.) 134.6 (21.)  
 Trefferlage 0.44 mm links, 0.68 mm hoch  
 Streuwert 1.22, horizontal: 1.29, vertikal: 1.14

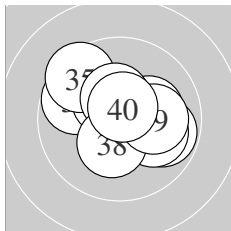

Serie 4:  
 9.7 ↖ 10.2 \* 9.8 ↗ 10.4 \* 9.5 ↖  
 10.4 \* 10.0 ↗ 10.3 \* 10.1 → 10.6 \*  
 beste Teiler 79.5 (40.) 136.8 (36.) 146.7 (34.)  
 Trefferlage 0.22 mm rechts, 0.46 mm hoch  
 Streuwert 1.65, horizontal: 1.97, vertikal: 1.26

Unterschrift des Schützen

Meyton Elektronik

Ergebnis: **394** (412.8)  
 Serien: 97 100 98 99  
 Zähler: 34 6 0 0 0 0 0 0 0 0  
 Innenzehner: 26  
 weiteste: 341 (22), 327 (6), 283 (7)  
 beste Teiler 10.1 (1.) 34.1 (32.) 43.0 (23.)  
 Trefferlage 0.10 mm rechts, 0.32 mm hoch  
 Streuwert 1.24, horizontal: 1.49, vertikal: 0.94

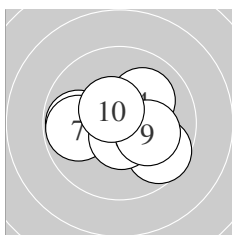
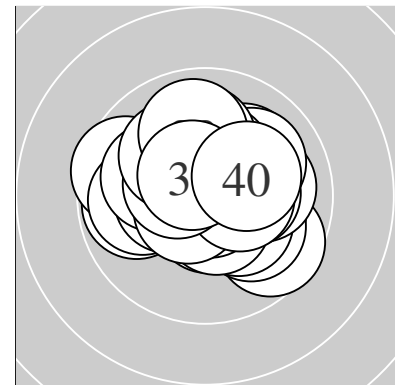

Serie 1:  
 10.9 \*                      10.6 \*                      10.6 \*                      10.1 ↗                      9.8 ←  
 9.6 ↘                      9.8 ←                      10.6 \*                      10.1 →                      10.5 \*  
 beste Teiler 10.1 (1.) 78.1 (2.) 90.8 (3.)  
 Trefferlage 0.13 mm rechts, 0.02 mm tief  
 Streuwert 1.47, horizontal: 1.83, vertikal: 0.99

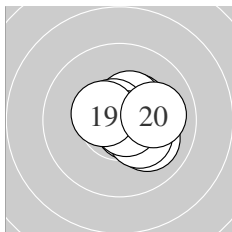

Serie 2:  
 10.0 ↘                      10.4 \*                      10.6 \*                      10.6 \*                      10.4 \*  
 10.7 \*                      10.3 \*                      10.7 \*                      10.5 \*                      10.0 →  
 beste Teiler 51.8 (18.) 71.6 (16.) 76.2 (13.)  
 Trefferlage 0.77 mm rechts, 0.04 mm hoch  
 Streuwert 0.91, horizontal: 1.00, vertikal: 0.80

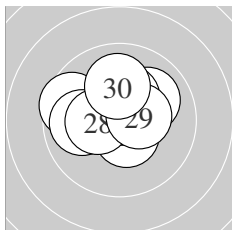

Serie 3:  
 10.0 ↗                      9.6 ←                      10.8 \*                      10.3 \*                      9.9 ←  
 10.5 \*                      10.6 \*                      10.4 \*                      10.4 \*                      10.0 ↑  
 beste Teiler 43.0 (23.) 76.5 (27.) 109.5 (26.)  
 Trefferlage 0.36 mm links, 0.62 mm hoch  
 Streuwert 1.34, horizontal: 1.64, vertikal: 0.96

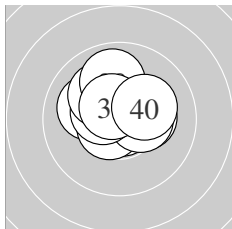

Serie 4:  
 10.1 ↖                      10.8 \*                      10.3 \*                      10.6 \*                      10.4 \*  
 10.5 \*                      10.1 ↘                      9.9 ↑                      10.6 \*                      10.2 \*  
 beste Teiler 34.1 (32.) 87.0 (34.) 100.1 (39.)  
 Trefferlage 0.11 mm links, 0.64 mm hoch  
 Streuwert 1.14, horizontal: 1.32, vertikal: 0.93

Unterschrift des Schützen

Meyton Elektronik

Ergebnis: **363** (384.4)  
 Serien: 95 90 88 90  
 Zähler: 15 14 10 1 0 0 0 0 0 0  
 Innenzehner: 10  
 weiteste: 855 (24), 650 (40), 575 (11)  
 beste Teiler 19.2 (18.) 60.4 (31.) 76.0 (25.)  
 Trefferlage 1.18 mm rechts, 0.32 mm tief  
 Streuwert 2.63, horizontal: 3.01, vertikal: 2.19

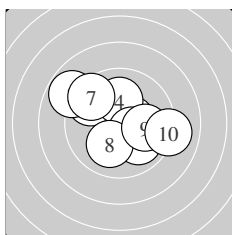
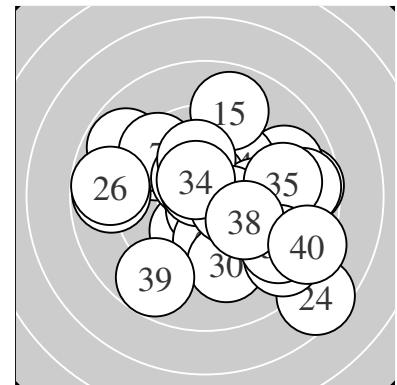

Serie 1:  
 9.6 ↘ 10.5 \* 8.8 ↘ 10.1 ↑ 10.4 \*  
 10.0 ↘ 9.5 ↘ 10.1 ↙ 10.0 → 9.1 →  
 beste Teiler 114.4 (2.) 136.3 (5.) 215.0 (4.)  
 Trefferlage 0.01 mm rechts, 0.40 mm hoch  
 Streuwert 2.35, horizontal: 2.79, vertikal: 1.81

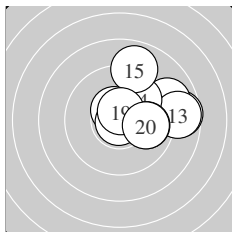

Serie 2:  
 8.7 → 9.0 → 8.7 → 9.9 ↗ 8.9 ↑  
 10.5 \* 9.9 → 10.9 \* 10.6 \* 9.9 →  
 beste Teiler 19.2 (18.) 85.8 (19.) 109.6 (16.)  
 Trefferlage 2.35 mm rechts, 1.03 mm hoch  
 Streuwert 1.97, horizontal: 2.28, vertikal: 1.59

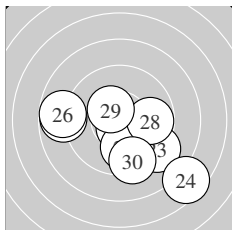

Serie 3:  
 9.6 ↘ 8.8 ← 9.1 ↘ 7.5 ↘ 10.6 \*  
 8.8 ← 9.9 ↓ 9.8 → 10.4 \* 9.3 ↓  
 beste Teiler 76.0 (25.) 133.5 (29.) 259.2 (27.)  
 Trefferlage 0.53 mm rechts, 1.62 mm tief  
 Streuwert 3.06, horizontal: 3.75, vertikal: 2.17

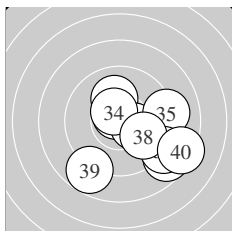

Serie 4:  
 10.7 \* 10.1 ↑ 10.4 \* 10.5 \* 9.1 →  
 8.7 ↘ 8.9 ↘ 9.9 ↘ 8.8 ↙ 8.4 ↘  
 beste Teiler 60.4 (31.) 105.3 (34.) 145.2 (33.)  
 Trefferlage 1.84 mm rechts, 1.13 mm tief  
 Streuwert 2.58, horizontal: 2.87, vertikal: 2.24

Unterschrift des Schützen

Meyton Elektronik

Ergebnis: **386** (405.6)  
 Serien: 94 97 97 98  
 Zähler: 26 14 0 0 0 0 0 0 0 0  
 Innenzehner: 21  
 weiteste: 452 (7), 354 (16), 350 (19)  
 beste Teiler 22.3 (20.) 43.7 (23.) 47.5 (39.)  
 Trefferlage 0.29 mm rechts, 0.36 mm hoch  
 Streuwert 1.57, horizontal: 1.77, vertikal: 1.33

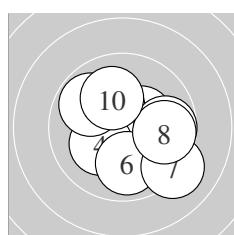
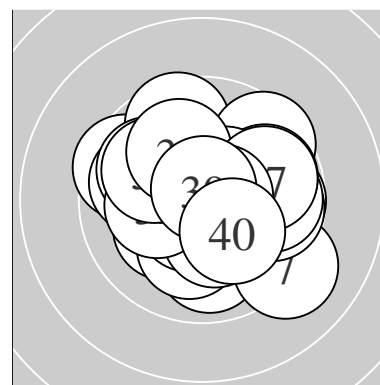

Serie 1:  
 10.4 \* 9.9 → 10.4 \* 10.2 \* 9.7 →  
 9.9 ↓ 9.1 ↘ 9.8 → 9.8 ↖ 10.1 ↗  
 beste Teiler 148.4 (1.) 149.8 (3.) 194.2 (4.)  
 Trefferlage 0.85 mm rechts, 0.15 mm tief  
 Streuwert 1.91, horizontal: 2.12, vertikal: 1.66

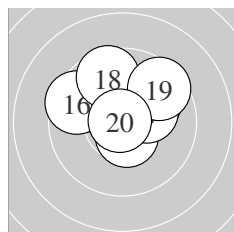

Serie 2:  
 10.4 \* 10.0 ↗ 10.6 \* 10.2 \* 10.3 \*  
 9.5 ↖ 10.2 \* 9.6 ↘ 9.6 ↗ 10.9 \*  
 beste Teiler 22.3 (20.) 100.5 (13.) 148.3 (11.)  
 Trefferlage 0.10 mm rechts, 1.21 mm hoch  
 Streuwert 1.48, horizontal: 1.76, vertikal: 1.13

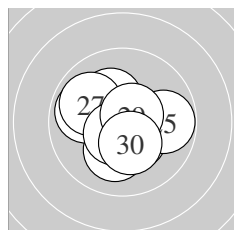

Serie 3:  
 10.4 \* 10.1 ↓ 10.8 \* 9.9 ↖ 9.8 →  
 10.2 \* 9.9 ↖ 10.6 \* 10.6 \* 10.3 \*  
 beste Teiler 43.7 (23.) 82.6 (29.) 97.3 (28.)  
 Trefferlage 0.22 mm links, 0.11 mm tief  
 Streuwert 1.40, horizontal: 1.58, vertikal: 1.20

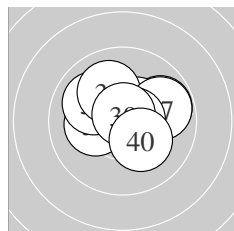

Serie 4:  
 10.6 \* 10.2 \* 9.8 → 10.0 ↖ 10.4 \*  
 10.0 ↘ 9.8 → 10.6 \* 10.8 \* 10.2 \*  
 beste Teiler 47.5 (39.) 77.0 (31.) 79.0 (38.)  
 Trefferlage 0.42 mm rechts, 0.54 mm hoch  
 Streuwert 1.35, horizontal: 1.67, vertikal: 0.92

Unterschrift des Schützen

Meyton Elektronik

Ergebnis: **372** (388.4)  
 Serien: 94 96 95 87  
 Zähler: 19 15 5 1 0 0 0 0 0 0  
 Innenzehner: 12  
 weiteste: 957 (33), 705 (35), 667 (36)  
 beste Teiler 30.4 (9.) 76.2 (15.) 94.1 (20.)  
 Trefferlage 0.10 mm links, 0.29 mm tief  
 Streuwert 2.57, horizontal: 2.98, vertikal: 2.09

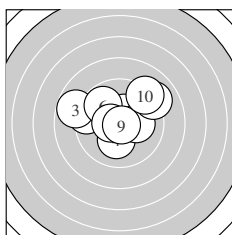
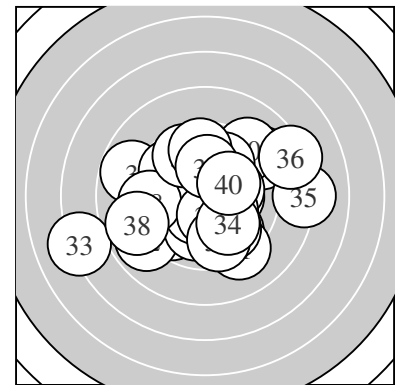

Serie 1:  
 9.3 ← 10.4 \* 8.8 ↖ 10.2 \* 10.2 \*  
 9.8 ↘ 10.5 \* 9.0 ↗ 10.8 \* 9.2 ↗  
 beste Teiler 30.4 (9.) 105.0 (7.) 129.0 (2.)  
 Trefferlage 0.28 mm links, 0.97 mm hoch  
 Streuwert 2.34, horizontal: 2.90, vertikal: 1.58

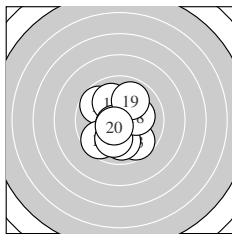

Serie 2:  
 9.7 ↖ 10.0 ↖ 9.7 ↘ 9.6 ↙ 10.6 \*  
 10.0 ↓ 10.0 ↓ 10.1 → 9.9 ↗ 10.6 \*  
 beste Teiler 76.2 (15.) 94.1 (20.) 201.0 (18.)  
 Trefferlage 0.23 mm links, 0.39 mm tief  
 Streuwert 1.78, horizontal: 1.58, vertikal: 1.96

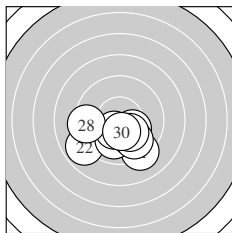

Serie 3:  
 9.2 ↘ 8.9 ↙ 10.0 ↓ 10.0 ↘ 10.2 \*  
 9.8 ↘ 10.4 \* 9.4 ← 10.2 \* 10.4 \*  
 beste Teiler 135.5 (27.) 137.1 (30.) 183.6 (25.)  
 Trefferlage 0.10 mm links, 1.89 mm tief  
 Streuwert 1.78, horizontal: 2.31, vertikal: 1.00

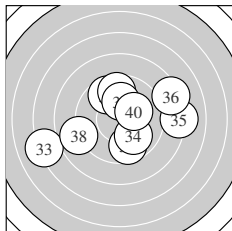

Serie 4:  
 9.6 ↓ 9.7 ↖ 7.1 ← 9.9 ↘ 8.1 →  
 8.3 → 9.6 ↑ 8.9 ← 10.1 ↑ 10.2 \*  
 beste Teiler 190.5 (40.) 209.5 (39.) 253.3 (34.)  
 Trefferlage 0.19 mm rechts, 0.14 mm hoch  
 Streuwert 3.79, horizontal: 4.70, vertikal: 2.59

Unterschrift des Schützen

Ergebnis: **377** (395.1)  
 Serien: 96 93 94 94  
 Zähler: 19 19 2 0 0 0 0 0 0 0  
 Innenzehner: 15  
 weiteste: 692 (16), 502 (8), 448 (5)  
 beste Teiler 29.1 (33.) 61.4 (22.) 66.8 (7.)  
 Trefferlage 0.20 mm rechts, 0.26 mm hoch  
 Streuwert 2.15, horizontal: 2.38, vertikal: 1.90

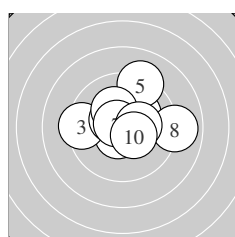
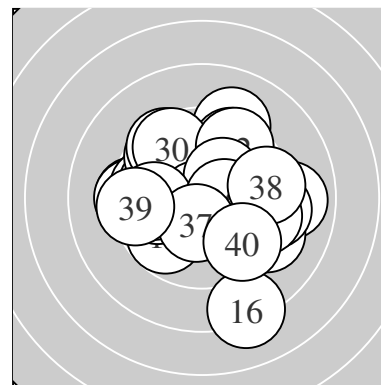

Serie 1:  
 10.2 \*                      10.6 \*                      9.4 ←                      10.5 \*                      9.2 ↗  
 10.2 \*                      10.7 \*                      8.9 →                      10.3 \*                      10.4 \*  
 beste Teiler 66.8 (7.) 91.7 (2.) 124.4 (4.)  
 Trefferlage 0.40 mm rechts, 0.67 mm hoch  
 Streuwert 1.96, horizontal: 2.35, vertikal: 1.45

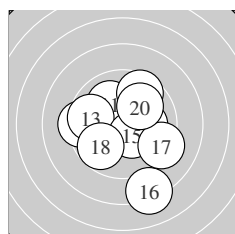

Serie 2:  
 10.0 ↘                      9.4 ←                      9.7 ←                      10.1 →                      10.4 \*  
 8.2 ↓                      9.2 ↘                      9.8 ↗                      9.6 ↗                      10.0 ↗  
 beste Teiler 136.8 (15.) 210.0 (14.) 229.1 (11.)  
 Trefferlage 0.22 mm rechts, 0.44 mm tief  
 Streuwert 2.66, horizontal: 2.63, vertikal: 2.69

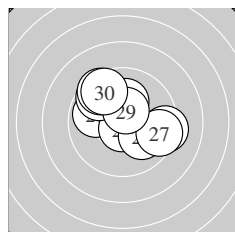

Serie 3:  
 9.9 ←                      10.7 \*                      9.6 ↘                      9.3 →                      10.0 ↘  
 9.5 ↘                      9.5 →                      10.2 \*                      10.5 \*                      9.6 ↘  
 beste Teiler 61.4 (22.) 115.2 (29.) 198.1 (28.)  
 Trefferlage 0.12 mm rechts, 0.84 mm hoch  
 Streuwert 2.08, horizontal: 2.41, vertikal: 1.68

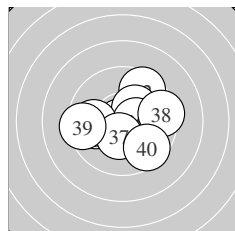

Serie 4:  
 9.9 ←                      9.5 ↗                      10.8 \*                      10.3 \*                      9.8 ←  
 10.4 \*                      10.4 \*                      9.4 →                      9.4 ←                      9.6 ↘  
 beste Teiler 29.1 (33.) 129.0 (36.) 148.7 (37.)  
 Trefferlage 0.06 mm rechts, 0.02 mm tief  
 Streuwert 2.04, horizontal: 2.48, vertikal: 1.49

Unterschrift des Schützen

Meyton Elektronik



Ergebnis: **393** (412.0)  
 Serien: 99 99 99 96  
 Zähler: 33 7 0 0 0 0 0 0 0 0  
 Innenzehner: 30  
 weiteste: 440 (33), 420 (17), 332 (32)  
 beste Teiler 15.5 (35.) 40.5 (18.) 51.7 (36.)  
 Trefferlage 0.36 mm rechts, 0.01 mm tief  
 Streuwert 1.34, horizontal: 1.59, vertikal: 1.02

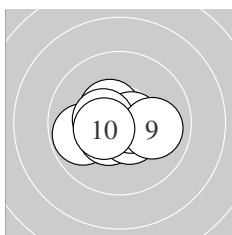
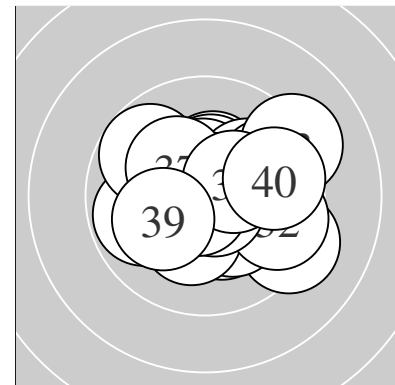

Serie 1:  
 10.6 \*                      10.4 \*                      9.8 ←                      10.5 \*                      10.5 \*  
 10.5 \*                      10.6 \*                      10.5 \*                      10.0 →                      10.5 \*  
 beste Teiler 76.5 (1.) 85.1 (7.) 105.3 (6.)  
 Trefferlage 0.44 mm links, 0.27 mm tief  
 Streuwert 1.08, horizontal: 1.41, vertikal: 0.58

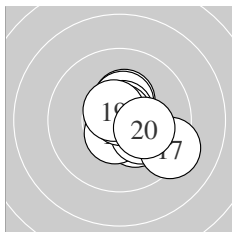

Serie 2:  
 10.4 \*                      10.4 \*                      10.7 \*                      10.3 \*                      10.6 \*  
 10.2 \*                      9.3 ↘                      10.8 \*                      10.6 \*                      10.2 \*  
 beste Teiler 40.5 (18.) 68.3 (13.) 82.1 (19.)  
 Trefferlage 0.83 mm rechts, 0.11 mm tief  
 Streuwert 1.22, horizontal: 1.25, vertikal: 1.18

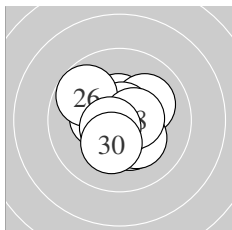

Serie 3:  
 10.3 \*                      10.4 \*                      10.5 \*                      10.1 ↗                      10.7 \*  
 9.8 ↖                      10.2 \*                      10.5 \*                      10.6 \*                      10.2 \*  
 beste Teiler 56.6 (25.) 88.2 (29.) 104.6 (28.)  
 Trefferlage 0.02 mm links, 0.00 mm  
 Streuwert 1.25, horizontal: 1.30, vertikal: 1.20

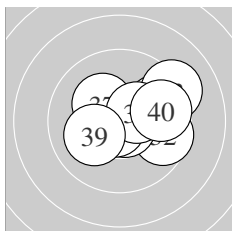

Serie 4:  
 9.8 →                      9.6 →                      9.2 ↗                      10.7 \*                      10.9 \*  
 10.7 \*                      10.2 \*                      10.4 \*                      10.1 ←                      9.7 →  
 beste Teiler 15.5 (35.) 51.7 (36.) 57.9 (34.)  
 Trefferlage 1.08 mm rechts, 0.33 mm hoch  
 Streuwert 1.60, horizontal: 2.01, vertikal: 1.06

Unterschrift des Schützen

Ergebnis: **387** (407.3)  
 Serien: 96 97 97 97  
 Zähler: 27 13 0 0 0 0 0 0 0 0  
 Innenzehner: 23  
 weiteste: 453 (16), 372 (20), 349 (10)  
 beste Teiler 21.0 (25.) 41.0 (36.) 60.1 (37.)  
 Trefferlage 0.06 mm rechts, 0.34 mm tief  
 Streuwert 1.54, horizontal: 1.79, vertikal: 1.24

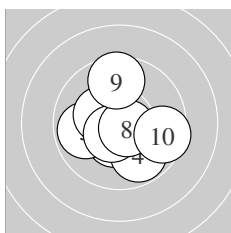
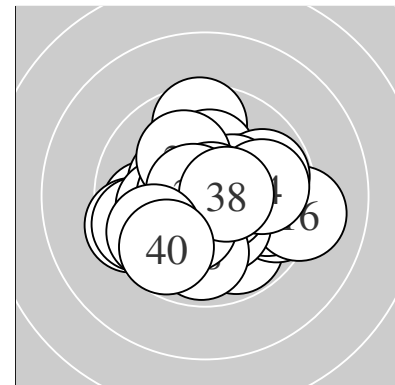

Serie 1:  
 10.4 \* 10.2 \* 10.5 \* 9.8 ↘ 9.9 ←  
 10.3 \* 10.5 \* 10.7 \* 9.6 ↑ 9.6 →  
 beste Teiler 70.4 (8.) 104.4 (7.) 108.4 (3.)  
 Trefferlage 0.06 mm rechts, 0.26 mm tief  
 Streuwert 1.64, horizontal: 1.72, vertikal: 1.56

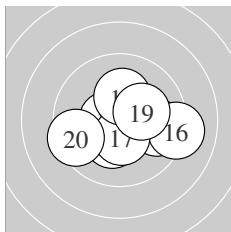

Serie 2:  
 10.3 \* 10.5 \* 9.7 → 10.6 \* 10.6 \*  
 9.1 → 10.4 \* 10.2 \* 10.2 \* 9.5 ←  
 beste Teiler 76.3 (14.) 95.0 (15.) 119.6 (12.)  
 Trefferlage 0.39 mm rechts, 0.30 mm tief  
 Streuwert 1.75, horizontal: 2.23, vertikal: 1.08

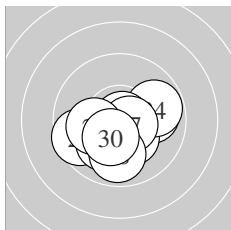

Serie 3:  
 10.0 → 9.6 ← 10.3 \* 9.8 → 10.9 \*  
 10.1 ↙ 10.6 \* 9.9 ↓ 10.1 ← 10.3 \*  
 beste Teiler 21.0 (25.) 85.4 (27.) 152.5 (30.)  
 Trefferlage 0.01 mm links, 0.80 mm tief  
 Streuwert 1.52, horizontal: 1.85, vertikal: 1.09

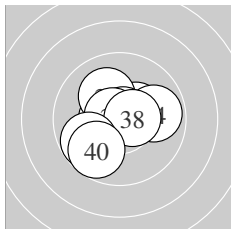

Serie 4:  
 10.4 \* 10.6 \* 10.6 \* 9.9 → 10.1 ↘  
 10.8 \* 10.7 \* 10.5 \* 9.8 ↙ 9.7 ↙  
 beste Teiler 41.0 (36.) 60.1 (37.) 76.0 (33.)  
 Trefferlage 0.20 mm links, 0.00 mm  
 Streuwert 1.39, horizontal: 1.54, vertikal: 1.21

Unterschrift des Schützen

Ergebnis: **389** (406.0)  
 Serien: 98 98 96 97  
 Zähler: 29 11 0 0 0 0 0 0 0 0  
 Innenzehner: 23  
 weiteste: 444 (18), 367 (26), 365 (30)  
 beste Teiler 16.4 (32.) 55.9 (21.) 64.7 (35.)  
 Trefferlage 0.16 mm rechts, 0.31 mm hoch  
 Streuwert 1.58, horizontal: 1.74, vertikal: 1.39

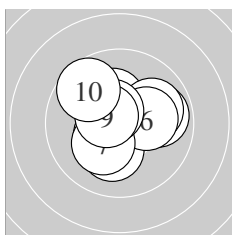
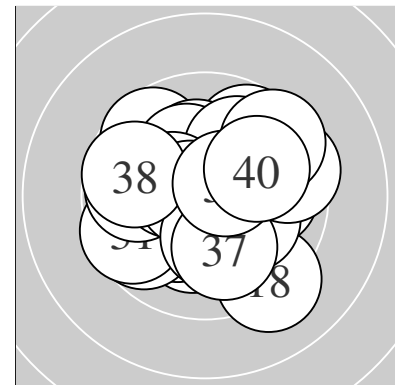

Serie 1:  
 9.9 → 10.3 \* 10.0 → 10.4 \* 10.2 \*  
 10.2 \* 10.2 \* 10.5 \* 10.5 \* 9.7 ↖  
 beste Teiler 101.5 (8.) 105.6 (9.) 130.8 (4.)  
 Trefferlage 0.00 mm , 0.30 mm hoch  
 Streuwert 1.50, horizontal: 1.66, vertikal: 1.32

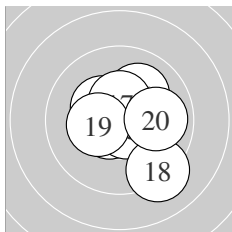

Serie 2:  
 10.3 \* 10.3 \* 10.6 \* 10.5 \* 10.7 \*  
 10.1 ↗ 10.5 \* 9.2 ↘ 10.3 \* 9.9 →  
 beste Teiler 70.0 (15.) 88.2 (13.) 123.0 (14.)  
 Trefferlage 0.56 mm rechts, 0.06 mm hoch  
 Streuwert 1.49, horizontal: 1.46, vertikal: 1.52

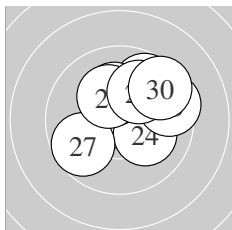

Serie 3:  
 10.7 \* 10.3 \* 9.7 ↗ 10.1 ↘ 10.2 \*  
 9.5 → 9.7 ↙ 10.2 \* 10.0 ↗ 9.5 ↗  
 beste Teiler 55.9 (21.) 172.8 (22.) 184.3 (28.)  
 Trefferlage 0.77 mm rechts, 1.05 mm hoch  
 Streuwert 1.65, horizontal: 1.85, vertikal: 1.42

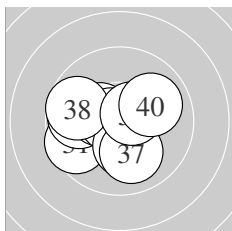

Serie 4:  
 9.6 ↙ 10.9 \* 9.8 ← 10.4 \* 10.7 \*  
 10.2 \* 10.0 ↓ 9.7 ← 10.5 \* 10.0 →  
 beste Teiler 16.4 (32.) 64.7 (35.) 101.8 (39.)  
 Trefferlage 0.68 mm links, 0.18 mm tief  
 Streuwert 1.54, horizontal: 1.84, vertikal: 1.17

Unterschrift des Schützen

Meyton Elektronik

Ergebnis:	<b>380</b>	(395.9)
Serien:	94 95 97 94	
Zähler:	22 16 2 0 0 0 0 0 0 0	
Innenzehner:	10	
weiteste:	549 (10), 549 (33), 491 (7)	
beste Teiler	50.0 (15.) 50.0 (28.) 59.3 (31.)	
Trefferlage	0.56 mm links, 0.55 mm hoch	
Streuwert	2.04, horizontal: 2.33, vertikal: 1.69	

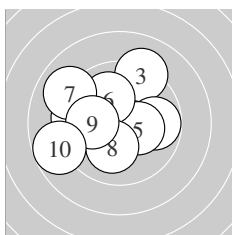
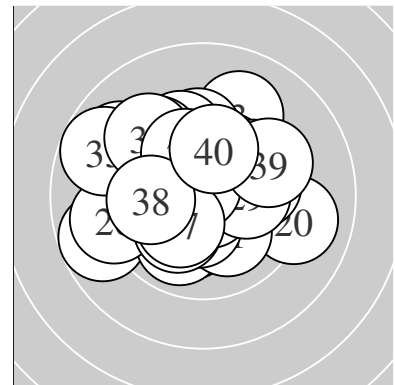

Serie 1:	9.5 ←	10.7 *	9.2 ↑	9.8 →	10.3 *
	10.0 ↘	9.0 ↖	10.1 ↓	10.0 ←	8.8 ←
beste Teiler	59.8 (2.)	161.8 (5.)	207.7 (8.)		
Trefferlage	0.98 mm links, 0.46 mm hoch				
Streuwert	2.38, horizontal: 2.75, vertikal: 1.94				

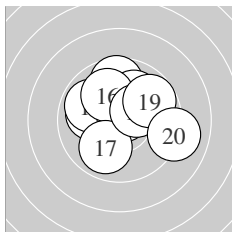

Serie 2:	9.7 ↑	10.0 ↗	10.0 ←	9.9 ↖	10.8 *
	10.0 ↘	9.9 ↓	10.3 *	9.8 ↗	9.1 →
beste Teiler	50.0 (15.)	162.9 (18.)	231.5 (12.)		
Trefferlage	0.28 mm rechts, 0.84 mm hoch				
Streuwert	1.94, horizontal: 2.21, vertikal: 1.62				

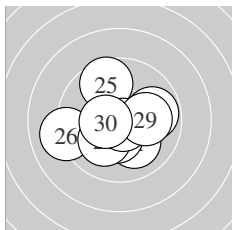

Serie 3:	10.1 ↘	10.5 *	10.4 *	9.8 →	9.6 ↑
	9.1 ←	10.1 ↙	10.8 *	10.1 →	10.5 *
beste Teiler	50.0 (28.)	108.4 (22.)	118.8 (30.)		
Trefferlage	0.21 mm links, 0.39 mm tief				
Streuwert	1.78, horizontal: 2.06, vertikal: 1.45				

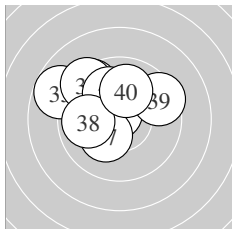

Serie 4:	10.7 *	10.1 ←	8.8 ↖	9.5 ↘	9.3 ↘
	10.0 ↘	10.2 *	9.9 ←	9.5 ↗	10.0 ↑
beste Teiler	59.3 (31.)	180.2 (37.)	212.0 (32.)		
Trefferlage	1.33 mm links, 1.32 mm hoch				
Streuwert	1.90, horizontal: 2.24, vertikal: 1.48				

Unterschrift des Schützen

Meyton Elektronik

Ergebnis: **381** (396.2)  
 Serien: 95 92 97 97  
 Zähler: 23 15 2 0 0 0 0 0 0 0  
 Innenzehner: 14  
 weiteste: 637 (15), 585 (5), 448 (19)  
 beste Teiler 44.1 (12.) 79.7 (34.) 83.1 (39.)  
 Trefferlage 0.68 mm rechts, 0.07 mm hoch  
 Streuwert 2.06, horizontal: 2.47, vertikal: 1.56

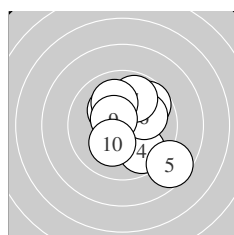
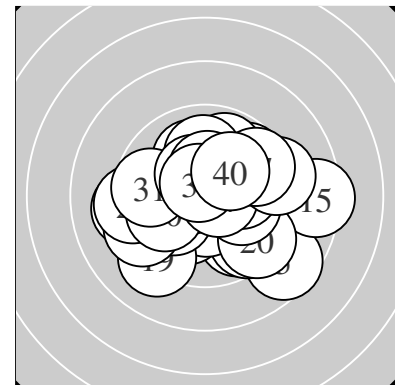

Serie 1:  
 10.2 \*                      9.7 ↗                      10.6 \*                      9.8 ↘                      8.6 ↘  
 10.1 ↗                      9.9 ↗                      10.0 ↘                      10.5 \*                      10.2 \*  
 beste Teiler 96.6 (3.) 103.2 (9.) 182.0 (1.)  
 Trefferlage 0.89 mm rechts, 0.23 mm hoch  
 Streuwert 1.99, horizontal: 1.86, vertikal: 2.11

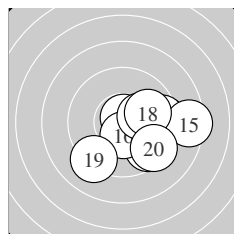

Serie 2:  
 9.3 →                      10.8 \*                      9.5 →                      9.6 ↘                      8.4 →  
 10.5 \*                      10.2 \*                      9.9 →                      9.2 ↙                      9.4 ↘  
 beste Teiler 44.1 (12.) 125.2 (16.) 180.2 (17.)  
 Trefferlage 2.12 mm rechts, 0.75 mm tief  
 Streuwert 2.11, horizontal: 2.54, vertikal: 1.57

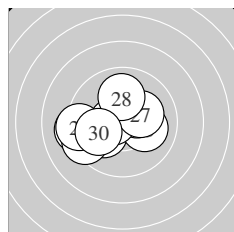

Serie 3:  
 10.1 ↙                      9.2 ←                      10.1 →                      10.3 \*                      9.3 ↙  
 10.6 \*                      10.2 \*                      10.0 ↑                      9.3 ←                      10.0 ↙  
 beste Teiler 93.0 (26.) 155.2 (24.) 187.5 (27.)  
 Trefferlage 1.19 mm links, 0.17 mm tief  
 Streuwert 1.92, horizontal: 2.42, vertikal: 1.21

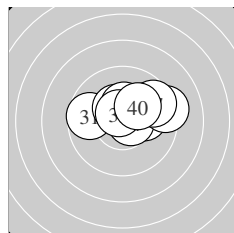

Serie 4:  
 9.7 ←                      10.0 ↗                      10.1 →                      10.6 \*                      9.2 →  
 10.4 \*                      9.6 ↗                      10.4 \*                      10.6 \*                      10.1 ↗  
 beste Teiler 79.7 (34.) 83.1 (39.) 142.6 (36.)  
 Trefferlage 0.92 mm rechts, 0.98 mm hoch  
 Streuwert 1.51, horizontal: 2.06, vertikal: 0.59

Unterschrift des Schützen

Meyton Elektronik

Ergebnis:	<b>379</b>	(397.4)
Serien:	95	97 97 90
Zähler:	21	17 2 0 0 0 0 0 0 0
Innenzehner:	14	
weiteste:	541	(6), 541 (31), 496 (27)
beste Teiler	15.1	(29.) 45.1 (16.) 72.2 (3.)
Trefferlage	0.67 mm	rechts, 0.34 mm hoch
Streuwert	2.00,	horizontal: 2.30, vertikal: 1.65

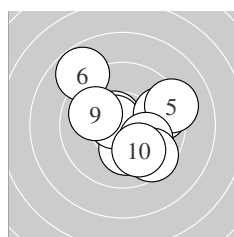
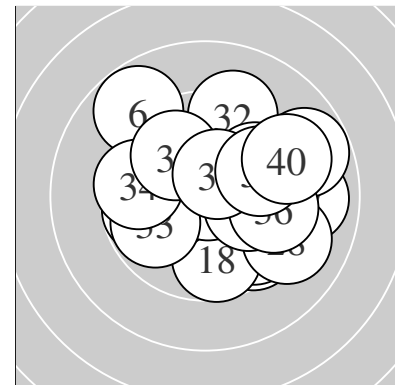

Serie 1:	10.6 *	10.2 *	10.7 *	9.6 →	9.2 →
	8.8 ↘	10.0 ↘	9.6 ↘	10.0 ↖	10.0 ↘
beste Teiler	72.2	(3.) 92.1 (1.)	194.7 (2.)		
Trefferlage	0.62 mm	rechts, 0.09 mm	hoch		
Streuwert	2.23,	horizontal: 2.39,	vertikal: 2.07		

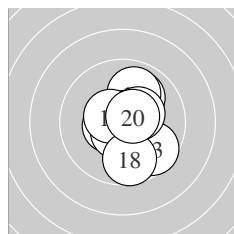

Serie 2:	10.5 *	10.0 ↗	9.6 ↘	10.6 *	9.9 ↗
	10.8 *	10.5 *	9.7 ↓	10.4 *	10.6 *
beste Teiler	45.1	(16.) 94.3 (14.)	97.2 (20.)		
Trefferlage	0.50 mm	rechts, 0.00 mm			
Streuwert	1.44,	horizontal: 1.12,	vertikal: 1.70		

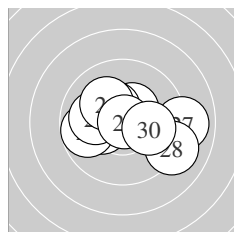

Serie 3:	10.2 *	9.8 ←	10.4 *	10.4 *	10.0 ←
	10.1 ↘	9.0 →	9.1 ↘	10.9 *	10.1 →
beste Teiler	15.1	(29.) 130.6 (23.)	138.6 (24.)		
Trefferlage	0.32 mm	rechts, 0.02 mm	hoch		
Streuwert	2.04,	horizontal: 2.68,	vertikal: 1.08		

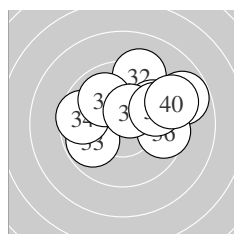

Serie 4:	8.8 →	9.2 ↑	9.8 ←	9.6 ←	9.9 ↘
	9.6 →	9.8 →	10.5 *	9.7 →	9.2 →
beste Teiler	125.3	(38.) 251.2 (35.)	282.7 (33.)		
Trefferlage	1.24 mm	rechts, 1.24 mm	hoch		
Streuwert	2.28,	horizontal: 2.85,	vertikal: 1.50		

Unterschrift des Schützen

Meyton Elektronik

Ergebnis: **371** (389.0)  
 Serien: 91 93 95 92  
 Zähler: 16 20 3 1 0 0 0 0 0 0  
 Innenzehner: 7  
 weiteste: 907 (38), 599 (34), 551 (6)  
 beste Teiler 3.1 (26.) 11.0 (3.) 72.8 (9.)  
 Trefferlage 1.89 mm links, 0.31 mm hoch  
 Streuwert 2.08, horizontal: 2.58, vertikal: 1.41

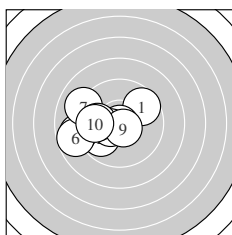
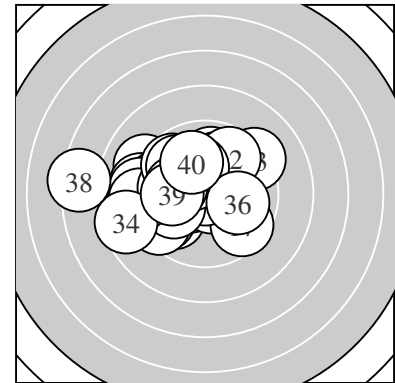

Serie 1:  
 9.6 ↗ 9.8 ↙ 10.9 \* 10.5 \* 8.9 ←  
 8.7 ← 9.1 ↖ 9.9 ← 10.7 \* 9.8 ←  
 beste Teiler 11.0 (3.) 72.8 (9.) 119.4 (4.)  
 Trefferlage 2.02 mm links, 0.17 mm tief  
 Streuwert 2.02, horizontal: 2.54, vertikal: 1.31

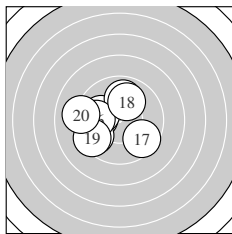

Serie 2:  
 10.0 ← 10.0 ↖ 9.6 ↙ 9.6 ← 9.9 ↑  
 9.8 ← 9.6 ↘ 10.0 ↑ 9.4 ↙ 9.1 ←  
 beste Teiler 233.4 (12.) 234.5 (18.) 245.3 (11.)  
 Trefferlage 1.77 mm links, 0.02 mm hoch  
 Streuwert 2.00, horizontal: 2.29, vertikal: 1.66

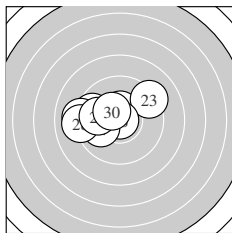

Serie 3:  
 10.0 ← 10.5 \* 9.2 ↗ 9.6 ↖ 9.1 ←  
 10.9 \* 10.0 ← 9.1 ← 9.9 ← 10.4 \*  
 beste Teiler 3.1 (26.) 122.4 (22.) 141.0 (30.)  
 Trefferlage 1.70 mm links, 0.45 mm hoch  
 Streuwert 1.90, horizontal: 2.48, vertikal: 1.02

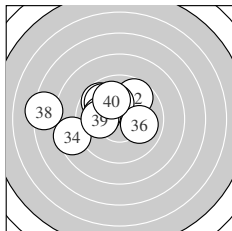

Serie 4:  
 9.7 ↘ 9.7 ↗ 10.2 \* 8.6 ← 9.8 ↖  
 10.0 → 10.1 ← 7.3 ← 10.0 ← 10.0 ↖  
 beste Teiler 197.5 (33.) 214.4 (37.) 235.0 (39.)  
 Trefferlage 2.08 mm links, 0.95 mm hoch  
 Streuwert 2.57, horizontal: 3.31, vertikal: 1.49

Unterschrift des Schützen

Meyton Elektronik

Ergebnis: **367** (383.8)  
 Serien: 93 92 86 96  
 Zähler: 19 17 3 0 0 0 0 0 0 0  
 Innenzehner: 17  
 weiteste: 654 (14), 589 (15), 580 (5)  
 beste Teiler 36.6 (11.) 39.2 (40.) 41.7 (13.)  
 Trefferlage 0.91 mm rechts, 0.21 mm hoch  
 Streuwert 2.23, horizontal: 2.63, vertikal: 1.75

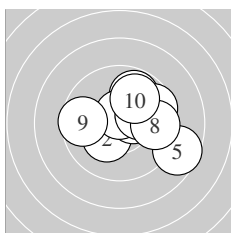
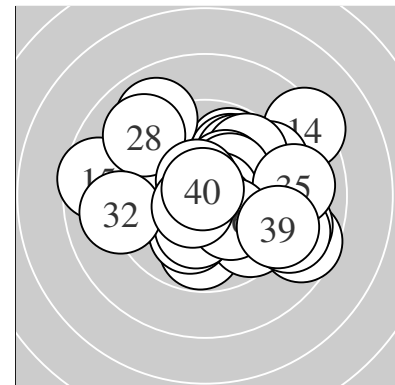

Serie 1:  
 9.8 ↗ 10.3 \* 9.6 ↗ 10.4 \* 8.6 ↘  
 10.6 \* 10.2 \* 9.7 → 9.6 ← 9.9 ↗  
 beste Teiler 78.0 (6.) 128.7 (4.) 172.7 (2.)  
 Trefferlage 1.27 mm rechts, 0.42 mm hoch  
 Streuwert 2.01, horizontal: 2.40, vertikal: 1.51

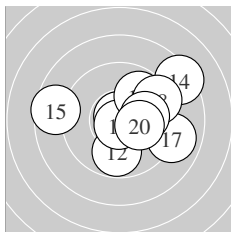

Serie 2:  
 10.8 \* 9.8 ↓ 10.8 \* 8.3 ↗ 8.6 ←  
 9.8 ↗ 9.0 ↘ 9.4 ↗ 10.0 → 10.2 \*  
 beste Teiler 36.6 (11.) 41.7 (13.) 186.7 (20.)  
 Trefferlage 1.31 mm rechts, 0.40 mm hoch  
 Streuwert 2.62, horizontal: 3.19, vertikal: 1.89

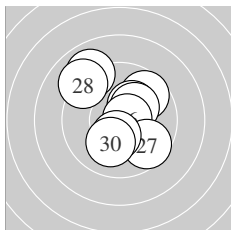

Serie 3:  
 0.0F 9.7 ↗ 9.0 ↘ 10.3 \* 10.2 \*  
 10.7 \*<sup>MIS</sup> 9.6 ↘ 9.1 ↘ 10.4 \* 10.1 ↓  
 beste Teiler 70.4 (26.) 142.2 (29.) 174.7 (24.)  
 Trefferlage 0.08 mm rechts, 0.76 mm hoch  
 Streuwert 2.18, horizontal: 2.05, vertikal: 2.30

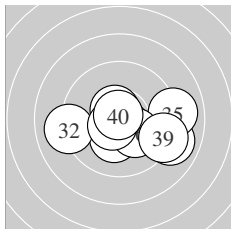

Serie 4:  
 10.2 \* 9.1 ← 10.6 \* 9.0 ↘ 9.0 →  
 10.2 \* 10.6 \* 10.6 \* 9.2 ↘ 10.8 \*  
 beste Teiler 39.2 (40.) 76.6 (33.) 88.6 (38.)  
 Trefferlage 0.89 mm rechts, 0.69 mm tief  
 Streuwert 2.18, horizontal: 2.92, vertikal: 1.00

MIS – Treffer wurde manuell eingefügt, da der Schütze die Scheibe verfehlt hat

Unterschrift des Schützen

Meyton Elektronik



Ergebnis: **398** (417.3)  
 Serien: 99 99 100 100  
 Zähler: 38 2 0 0 0 0 0 0 0 0  
 Innenzehner: 33  
 weiteste: 281 (3), 254 (20), 239 (27)  
 beste Teiler 15.5 (5.) 45.1 (4.) 46.6 (24.)  
 Trefferlage 0.03 mm links, 0.09 mm tief  
 Streuwert 1.05, horizontal: 1.13, vertikal: 0.97

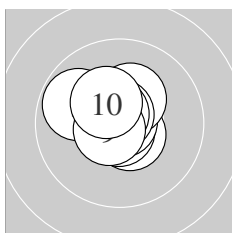
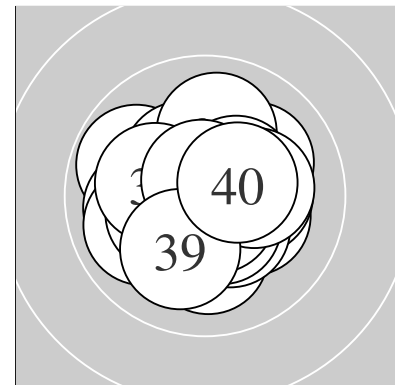

Serie 1:  
 10.7 \*                      10.6 \*                      9.8 ↖                      10.8 \*                      10.9 \*  
 10.3 \*                      10.7 \*                      10.7 \*                      10.7 \*                      10.3 \*  
 beste Teiler 15.5 (5.) 45.1 (4.) 54.9 (7.)  
 Trefferlage 0.30 mm links, 0.42 mm hoch  
 Streuwert 0.86, horizontal: 0.93, vertikal: 0.77

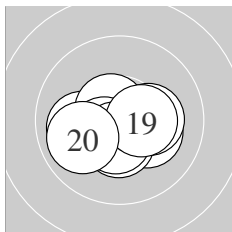

Serie 2:  
 10.2 \*                      10.2 \*                      10.7 \*                      10.4 \*                      10.0 ←  
 10.6 \*                      10.5 \*                      10.5 \*                      10.4 \*                      9.9 ←  
 beste Teiler 72.3 (13.) 84.3 (16.) 112.5 (18.)  
 Trefferlage 0.10 mm links, 0.53 mm tief  
 Streuwert 1.14, horizontal: 1.49, vertikal: 0.61

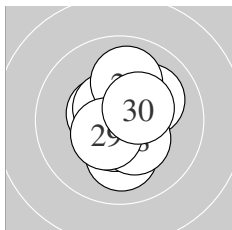

Serie 3:  
 10.1 ↓                      10.5 \*                      10.6 \*                      10.8 \*                      10.1 ↗  
 10.6 \*                      10.0 ↑                      10.4 \*                      10.5 \*                      10.4 \*  
 beste Teiler 46.6 (24.) 98.7 (23.) 100.4 (26.)  
 Trefferlage 0.18 mm rechts, 0.00 mm  
 Streuwert 1.16, horizontal: 0.93, vertikal: 1.35

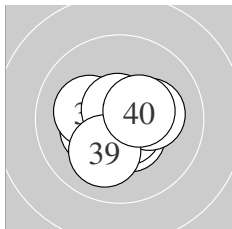

Serie 4:  
 10.6 \*                      10.5 \*                      10.7 \*                      10.3 \*                      10.2 \*  
 10.7 \*                      10.2 \*                      10.7 \*                      10.1 ↙                      10.4 \*  
 beste Teiler 53.8 (36.) 61.6 (38.) 75.4 (33.)  
 Trefferlage 0.08 mm rechts, 0.26 mm tief  
 Streuwert 1.03, horizontal: 1.19, vertikal: 0.85

Unterschrift des Schützen

Ergebnis: **390** (405.0)  
 Serien: 96 99 98 97  
 Zähler: 30 10 0 0 0 0 0 0 0 0  
 Innenzehner: 23  
 weiteste: 486 (1), 457 (4), 403 (39)  
 beste Teiler 43.9 (5.) 50.6 (11.) 53.7 (7.)  
 Trefferlage 0.52 mm rechts, 0.05 mm hoch  
 Streuwert 1.64, horizontal: 1.87, vertikal: 1.36

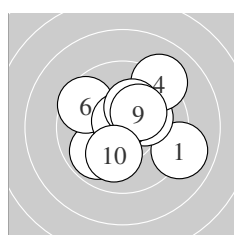
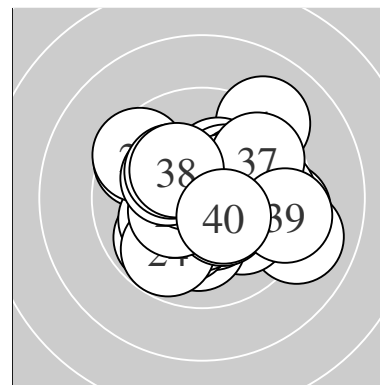

Serie 1:  
 9.0 ↘ 10.2 \* 9.9 ↙ 9.1 ↗ 10.8 \*  
 9.6 ↖ 10.7 \* 10.3 \* 10.3 \* 10.1 ↓  
 beste Teiler 43.9 (5.) 53.7 (7.) 171.9 (9.)  
 Trefferlage 0.51 mm rechts, 0.38 mm hoch  
 Streuwert 2.04, horizontal: 2.22, vertikal: 1.84

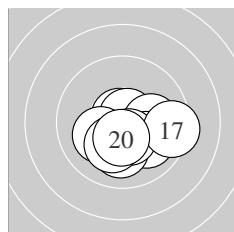

Serie 2:  
 10.8 \* 10.7 \* 10.1 → 10.0 ↘ 10.1 ↓  
 10.4 \* 9.4 → 10.1 ↙ 10.2 \* 10.5 \*  
 beste Teiler 50.6 (11.) 56.7 (12.) 124.4 (20.)  
 Trefferlage 0.58 mm rechts, 0.84 mm tief  
 Streuwert 1.33, horizontal: 1.65, vertikal: 0.90

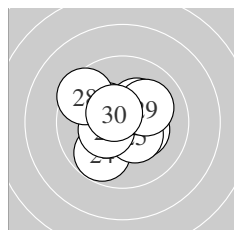

Serie 3:  
 10.4 \* 10.3 \* 10.3 \* 9.8 ↙ 10.4 \*  
 10.4 \* 10.3 \* 9.5 ↖ 10.1 ↗ 10.6 \*  
 beste Teiler 98.3 (30.) 129.5 (21.) 139.3 (25.)  
 Trefferlage 0.11 mm links, 0.13 mm hoch  
 Streuwert 1.50, horizontal: 1.65, vertikal: 1.33

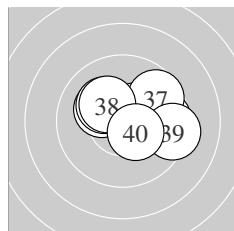

Serie 4:  
 10.2 \* 9.7 → 10.2 \* 10.4 \* 10.4 \*  
 10.1 → 9.7 ↗ 10.2 \* 9.3 → 10.4 \*  
 beste Teiler 135.4 (40.) 137.4 (35.) 139.2 (34.)  
 Trefferlage 1.10 mm rechts, 0.54 mm hoch  
 Streuwert 1.54, horizontal: 1.98, vertikal: 0.89

Unterschrift des Schützen

Meyton Elektronik

Ergebnis: **395** (412.1)  
 Serien: 99 99 98 99  
 Zähler: 35 5 0 0 0 0 0 0 0 0  
 Innenzehner: 29  
 weiteste: 457 (2), 367 (25), 313 (32)  
 beste Teiler 13.0 (14.) 40.4 (20.) 42.2 (33.)  
 Trefferlage 0.05 mm rechts, 0.42 mm tief  
 Streuwert 1.29, horizontal: 1.39, vertikal: 1.19

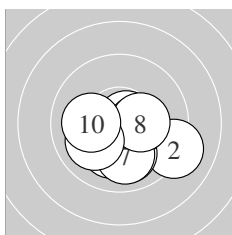
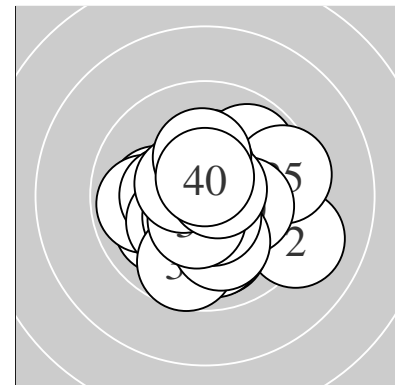

Serie 1:  
 10.7 \* 9.1 ↘ 10.0 ↓ 10.1 ↓ 10.4 \*  
 10.6 \* 10.0 ↓ 10.3 \* 10.0 ↙ 10.1 ←  
 beste Teiler 54.6 (1.) 86.8 (6.) 134.7 (5.)  
 Trefferlage 0.42 mm rechts, 1.05 mm tief  
 Streuwert 1.48, horizontal: 1.80, vertikal: 1.05

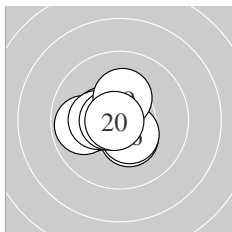

Serie 2:  
 10.4 \* 10.4 \* 10.2 \* 10.9 \* 9.9 ←  
 10.4 \* 10.3 \* 10.6 \* 10.3 \* 10.8 \*  
 beste Teiler 13.0 (14.) 40.4 (20.) 83.0 (18.)  
 Trefferlage 0.69 mm links, 0.08 mm tief  
 Streuwert 1.00, horizontal: 1.16, vertikal: 0.81

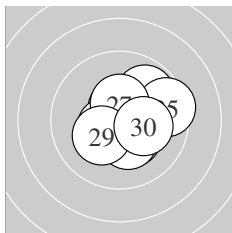

Serie 3:  
 9.9 ↗ 10.3 \* 10.6 \* 10.4 \* 9.5 →  
 10.5 \* 10.5 \* 10.3 \* 10.2 \* 10.2 \*  
 beste Teiler 87.6 (23.) 110.4 (26.) 125.0 (27.)  
 Trefferlage 0.67 mm rechts, 0.11 mm tief  
 Streuwert 1.37, horizontal: 1.46, vertikal: 1.26

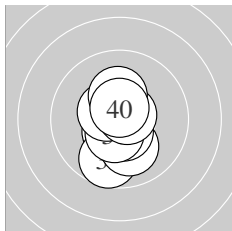

Serie 4:  
 10.5 \* 9.7 ↓ 10.8 \* 10.1 ↓ 10.6 \*  
 10.5 \* 10.5 \* 10.7 \* 10.2 \* 10.6 \*  
 beste Teiler 42.2 (33.) 65.7 (38.) 86.0 (40.)  
 Trefferlage 0.17 mm links, 0.43 mm tief  
 Streuwert 1.10, horizontal: 0.58, vertikal: 1.44

Unterschrift des Schützen

Meyton Elektronik

Ergebnis: **395** (409.4)  
 Serien: 99 99 100 97  
 Zähler: 35 5 0 0 0 0 0 0 0 0  
 Innenzehner: 23  
 weiteste: 371 (7), 331 (36), 306 (39)  
 beste Teiler 47.0 (15.) 51.9 (25.) 61.0 (16.)  
 Trefferlage 0.03 mm links, 0.23 mm hoch  
 Streuwert 1.38, horizontal: 1.50, vertikal: 1.25

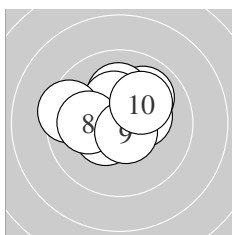
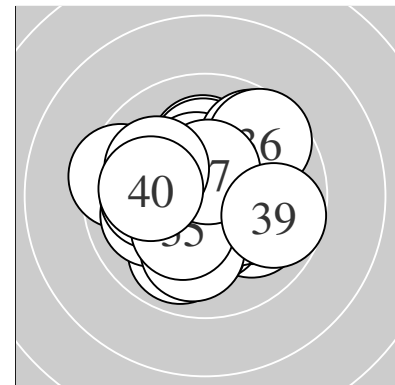

Serie 1:  
 10.3 \* 10.0 ↗ 10.4 \* 10.4 \* 10.1 ↑  
 10.3 \* 9.5 ← 10.1 ← 10.6 \* 10.1 ↗  
 beste Teiler 78.8 (9.) 126.8 (4.) 134.8 (3.)  
 Trefferlage 0.34 mm links, 0.71 mm hoch  
 Streuwert 1.42, horizontal: 1.75, vertikal: 1.00

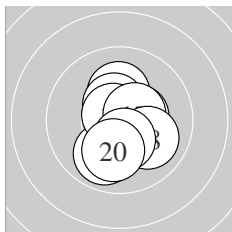

Serie 2:  
 10.2 \* 10.5 \* 10.4 \* 9.9 ↓ 10.8 \*  
 10.7 \* 10.5 \* 10.0 ↘ 10.4 \* 10.1 ↓  
 beste Teiler 47.0 (15.) 61.0 (16.) 114.3 (17.)  
 Trefferlage 0.22 mm rechts, 0.34 mm tief  
 Streuwert 1.21, horizontal: 0.95, vertikal: 1.43

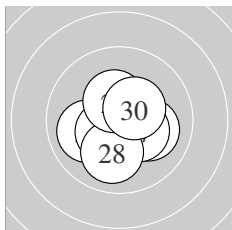

Serie 3:  
 10.1 ↘ 10.5 \* 10.4 \* 10.0 ← 10.7 \*  
 10.5 \* 10.3 \* 10.0 ↓ 10.4 \* 10.4 \*  
 beste Teiler 51.9 (25.) 114.1 (22.) 125.3 (26.)  
 Trefferlage 0.10 mm rechts, 0.08 mm tief  
 Streuwert 1.22, horizontal: 1.26, vertikal: 1.17

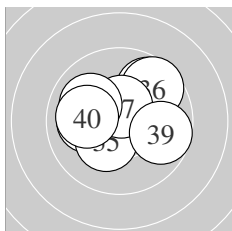

Serie 4:  
 9.7 ↗ 10.0 ← 10.4 \* 10.6 \* 10.3 \*  
 9.6 ↗ 10.5 \* 10.0 ↘ 9.7 → 10.0 ←  
 beste Teiler 89.3 (34.) 103.8 (37.) 146.6 (33.)  
 Trefferlage 0.10 mm links, 0.63 mm hoch  
 Streuwert 1.65, horizontal: 1.99, vertikal: 1.20

Unterschrift des Schützen

Meyton Elektronik

Ergebnis: **394** (413.4)  
 Serien: 98 98 99 99  
 Zähler: 34 6 0 0 0 0 0 0 0 0  
 Innenzehner: 30  
 weiteste: 338 (13), 304 (1), 280 (19)  
 beste Teiler 12.0 (31.) 20.2 (27.) 22.3 (38.)  
 Trefferlage 0.12 mm rechts, 0.09 mm tief  
 Streuwert 1.23, horizontal: 1.34, vertikal: 1.10

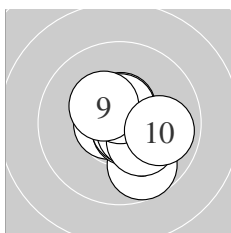
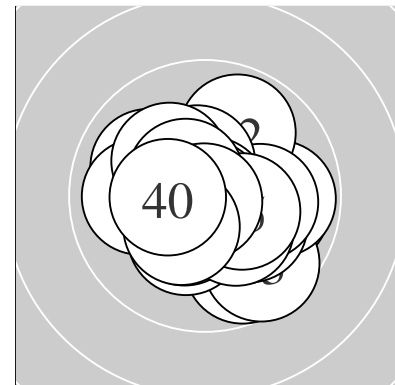

Serie 1:  
 9.7 ↘                      10.7 \*                      10.5 \*                      10.7 \*                      10.7 \*  
 10.6 \*                      10.2 \*                      10.6 \*                      10.4 \*                      9.9 →  
 beste Teiler 53.6 (5.) 67.8 (4.) 71.3 (2.)  
 Trefferlage 0.55 mm rechts, 0.26 mm tief  
 Streuwert 1.10, horizontal: 1.06, vertikal: 1.14

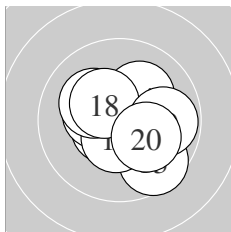

Serie 2:  
 10.2 \*                      10.5 \*                      9.6 ↘                      10.1 ↗                      10.4 \*  
 10.5 \*                      10.2 \*                      10.4 \*                      9.8 →                      10.1 ↘  
 beste Teiler 102.3 (12.) 115.3 (16.) 145.8 (18.)  
 Trefferlage 0.45 mm rechts, 0.09 mm tief  
 Streuwert 1.48, horizontal: 1.66, vertikal: 1.27

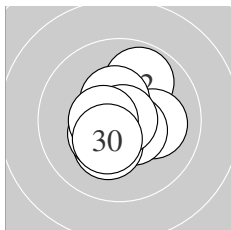

Serie 3:  
 10.4 \*                      9.9 ↗                      10.1 →                      10.5 \*                      10.4 \*  
 10.3 \*                      10.9 \*                      10.4 \*                      10.5 \*                      10.4 \*  
 beste Teiler 20.2 (27.) 105.0 (29.) 106.0 (24.)  
 Trefferlage 0.13 mm rechts, 0.00 mm  
 Streuwert 1.17, horizontal: 1.11, vertikal: 1.22

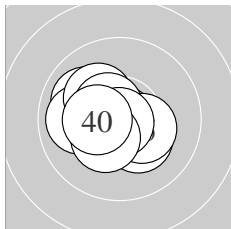

Serie 4:  
 10.9 \*                      10.3 \*                      10.0 ↖                      9.9 ←                      10.3 \*  
 10.2 \*                      10.5 \*                      10.9 \*                      10.4 \*                      10.4 \*  
 beste Teiler 12.0 (31.) 22.3 (38.) 104.6 (37.)  
 Trefferlage 0.65 mm links, 0.02 mm tief  
 Streuwert 1.12, horizontal: 1.32, vertikal: 0.88

Unterschrift des Schützen

Ergebnis: **379** (397.0)  
 Serien: 95 95 94 95  
 Zähler: 20 19 1 0 0 0 0 0 0 0  
 Innenzehner: 13  
 weiteste: 537 (30), 488 (32), 464 (29)  
 beste Teiler 13.1 (12.) 32.5 (23.) 63.6 (36.)  
 Trefferlage 0.13 mm rechts, 1.65 mm hoch  
 Streuwert 1.63, horizontal: 1.62, vertikal: 1.65

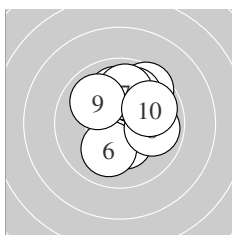
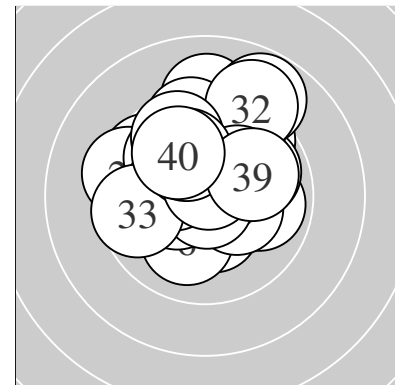

Serie 1:  
 10.0 ↑                      10.3 \*                      10.3 \*                      9.6 ↗                      9.9 ↗  
 10.1 ↘                      9.9 ↑                      9.9 →                      10.0 ↘                      9.9 →  
 beste Teiler 151.6 (3.) 166.8 (2.) 224.5 (6.)  
 Trefferlage 0.53 mm rechts, 1.02 mm hoch  
 Streuwert 1.63, horizontal: 1.52, vertikal: 1.73

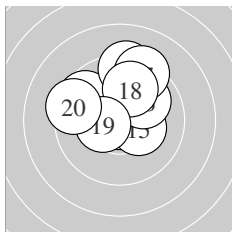

Serie 2:  
 9.6 ↘                      10.9 \*                      9.3 ↑                      10.5 \*                      10.3 \*  
 10.0 ↗                      9.3 ↑                      9.9 ↑                      10.4 \*                      9.4 ←  
 beste Teiler 13.1 (12.) 107.9 (14.) 139.4 (19.)  
 Trefferlage 0.05 mm links, 1.45 mm hoch  
 Streuwert 1.80, horizontal: 1.94, vertikal: 1.64

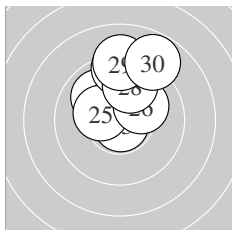

Serie 3:  
 9.9 ↘                      10.3 \*                      10.8 \*                      10.2 \*                      10.3 \*  
 10.1 ↗                      9.3 ↑                      9.8 ↑                      9.1 ↑                      8.8 ↗  
 beste Teiler 32.5 (23.) 153.6 (22.) 161.4 (25.)  
 Trefferlage 0.27 mm rechts, 2.28 mm hoch  
 Streuwert 1.54, horizontal: 1.31, vertikal: 1.74

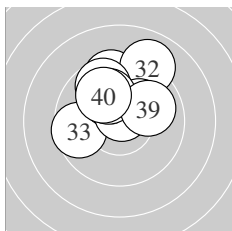

Serie 4:  
 9.5 ↑                      9.0 ↗                      9.6 ←                      10.2 \*                      10.2 \*  
 10.7 \*                      9.7 ↘                      10.1 ↘                      9.9 →                      10.0 ↘  
 beste Teiler 63.6 (36.) 189.8 (34.) 195.8 (35.)  
 Trefferlage 0.19 mm links, 1.85 mm hoch  
 Streuwert 1.63, horizontal: 1.78, vertikal: 1.46

Unterschrift des Schützen

Meyton Elektronik

Ergebnis: **389** (406.1)  
 Serien: 98 97 96 98  
 Zähler: 29 11 0 0 0 0 0 0 0 0  
 Innenzehner: 21  
 weiteste: 383 (35), 382 (27), 374 (36)  
 beste Teiler 45.2 (23.) 56.0 (5.) 59.5 (8.)  
 Trefferlage 0.32 mm rechts, 0.03 mm hoch  
 Streuwert 1.54, horizontal: 1.55, vertikal: 1.53

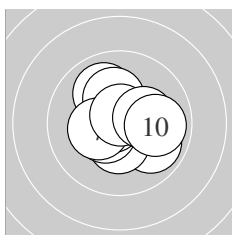
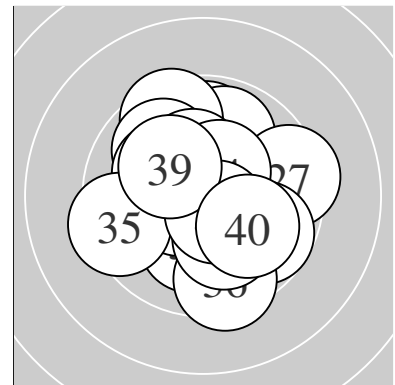

Serie 1:  
 9.9 ↘ 10.4 \* 10.5 \* 10.0 ↖ 10.7 \*  
 10.2 \* 10.3 \* 10.7 \* 10.2 \* 9.9 →  
 beste Teiler 56.0 (5.) 59.5 (8.) 120.9 (3.)  
 Trefferlage 0.19 mm rechts, 0.10 mm hoch  
 Streuwert 1.34, horizontal: 1.48, vertikal: 1.19

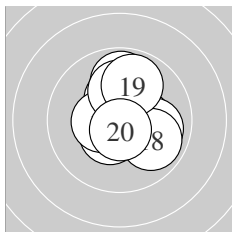

Serie 2:  
 10.5 \* 10.3 \* 10.3 \* 9.9 ↑ 10.4 \*  
 10.1 ↑ 10.0 → 9.9 ↘ 9.9 ↑ 10.7 \*  
 beste Teiler 70.2 (20.) 119.8 (11.) 127.3 (15.)  
 Trefferlage 0.50 mm rechts, 0.49 mm hoch  
 Streuwert 1.42, horizontal: 1.25, vertikal: 1.56

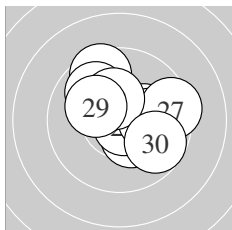

Serie 3:  
 10.2 \* 10.4 \* 10.8 \* 10.1 → 9.5 ↖  
 9.9 ↘ 9.4 → 10.3 \* 10.2 \* 9.7 ↘  
 beste Teiler 45.2 (23.) 147.8 (22.) 160.1 (28.)  
 Trefferlage 0.60 mm rechts, 0.59 mm hoch  
 Streuwert 1.71, horizontal: 1.92, vertikal: 1.48

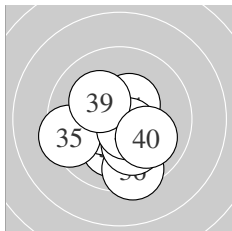

Serie 4:  
 10.1 ↓ 10.5 \* 10.0 ↘ 10.4 \* 9.4 ←  
 9.5 ↓ 10.1 ↘ 10.6 \* 10.2 \* 10.0 ↘  
 beste Teiler 90.2 (38.) 106.6 (32.) 127.0 (34.)  
 Trefferlage 0.01 mm links, 1.05 mm tief  
 Streuwert 1.56, horizontal: 1.66, vertikal: 1.46

Unterschrift des Schützen

Meyton Elektronik

Ergebnis: **378** (394.3)  
 Serien: 95 94 96 93  
 Zähler: 19 20 1 0 0 0 0 0 0 0  
 Innenzehner: 13  
 weiteste: 502 (31), 497 (27), 492 (7)  
 beste Teiler 74.4 (21.) 129.0 (34.) 143.6 (10.)  
 Trefferlage 0.45 mm links, 0.17 mm tief  
 Streuwert 2.09, horizontal: 2.52, vertikal: 1.55

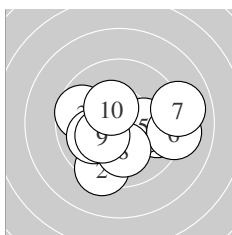
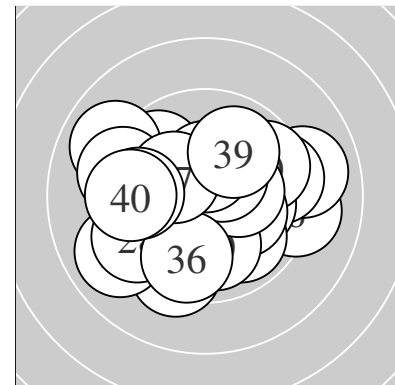

Serie 1:  
 9.7 → 9.4 ↓ 9.7 ← 10.0 ← 10.2 \*  
 9.1 → 9.0 → 10.1 ↓ 10.3 \* 10.4 \*  
 beste Teiler 143.6 (10.) 173.4 (9.) 196.9 (5.)  
 Trefferlage 0.58 mm rechts, 0.61 mm tief  
 Streuwert 2.26, horizontal: 2.81, vertikal: 1.54

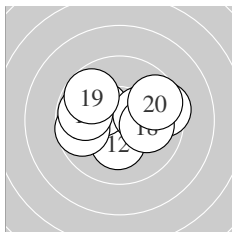

Serie 2:  
 9.9 ↖ 10.2 \* 10.3 \* 10.2 \* 9.5 →  
 9.7 ← 9.8 ← 10.1 → 9.8 ↖ 9.7 →  
 beste Teiler 175.1 (13.) 176.2 (14.) 180.5 (12.)  
 Trefferlage 0.18 mm links, 0.43 mm hoch  
 Streuwert 1.99, horizontal: 2.58, vertikal: 1.11

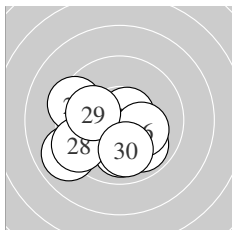

Serie 3:  
 10.7 \* 10.3 \* 9.4 ↖ 9.9 ↘ 10.0 ↓  
 10.2 \* 9.0 ← 9.4 ← 10.1 ← 10.0 ↓  
 beste Teiler 74.4 (21.) 166.1 (22.) 195.2 (26.)  
 Trefferlage 0.85 mm links, 1.16 mm tief  
 Streuwert 1.90, horizontal: 2.26, vertikal: 1.45

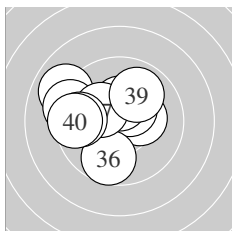

Serie 4:  
 8.9 ↖ 9.3 ← 10.3 \* 10.4 \* 10.4 \*  
 9.7 ↓ 10.2 \* 9.6 ← 9.9 ↗ 9.5 ←  
 beste Teiler 129.0 (34.) 144.0 (35.) 166.5 (33.)  
 Trefferlage 1.38 mm links, 0.64 mm hoch  
 Streuwert 1.96, horizontal: 2.33, vertikal: 1.51

Unterschrift des Schützen



Ergebnis: **395** (413.7)  
 Serien: 97 100 99 99  
 Zähler: 36 3 1 0 0 0 0 0 0 0  
 Innenzehner: 31  
 weiteste: 663 (10), 278 (35), 262 (7)  
 beste Teiler 8.0 (22.) 16.2 (12.) 38.8 (20.)  
 Trefferlage 0.24 mm links, 0.43 mm hoch  
 Streuwert 1.29, horizontal: 1.47, vertikal: 1.08

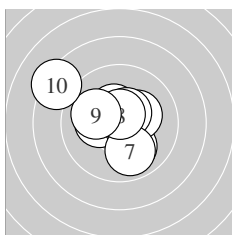
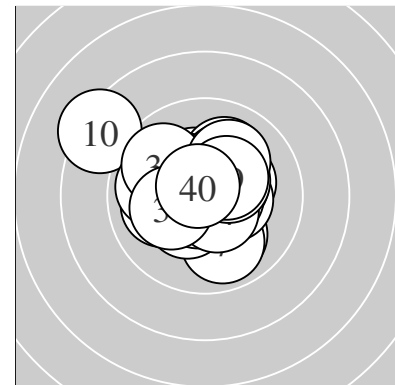

Serie 1:  
 10.0 ↘ 10.2 \* 10.7 \* 10.4 \* 10.3 \*  
 10.5 \* 9.9 ↘ 10.6 \* 10.0 ↖ 8.3 ↖  
 beste Teiler 72.0 (3.) 80.1 (8.) 111.7 (6.)  
 Trefferlage 0.50 mm links, 0.35 mm hoch  
 Streuwert 1.95, horizontal: 2.18, vertikal: 1.68

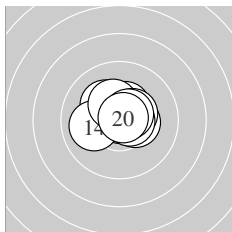

Serie 2:  
 10.4 \* 10.9 \* 10.2 \* 10.0 ← 10.4 \*  
 10.3 \* 10.4 \* 10.6 \* 10.6 \* 10.8 \*  
 beste Teiler 16.2 (12.) 38.8 (20.) 91.2 (18.)  
 Trefferlage 0.09 mm rechts, 0.47 mm hoch  
 Streuwert 0.95, horizontal: 1.17, vertikal: 0.67

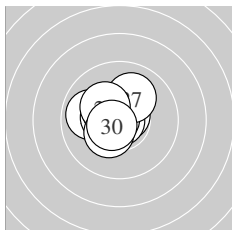

Serie 3:  
 10.7 \* 10.9 \* 9.9 ← 10.8 \* 10.4 \*  
 10.4 \* 10.1 ↗ 10.3 \* 10.4 \* 10.6 \*  
 beste Teiler 8.0 (22.) 46.3 (24.) 63.7 (21.)  
 Trefferlage 0.68 mm links, 0.35 mm hoch  
 Streuwert 0.94, horizontal: 1.02, vertikal: 0.86

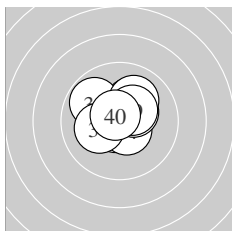

Serie 4:  
 10.7 \* 10.7 \* 10.2 \* 10.5 \* 9.8 ↖  
 10.2 \* 10.4 \* 10.1 ↗ 10.4 \* 10.7 \*  
 beste Teiler 64.6 (31.) 65.8 (40.) 67.9 (32.)  
 Trefferlage 0.10 mm rechts, 0.56 mm hoch  
 Streuwert 1.14, horizontal: 1.28, vertikal: 0.99

Unterschrift des Schützen

Meyton Elektronik

Ergebnis: **399** (420.2)  
 Serien: 99 100 100 100  
 Zähler: 39 1 0 0 0 0 0 0 0 0  
 Innenzehner: 35  
 weiteste: 252 (1), 229 (34), 227 (21)  
 beste Teiler 7.0 (11.) 15.8 (18.) 19.2 (24.)  
 Trefferlage 0.32 mm rechts, 0.12 mm hoch  
 Streuwert 0.89, horizontal: 1.03, vertikal: 0.72

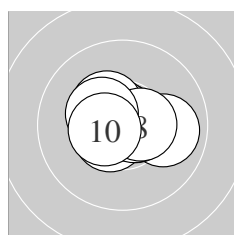
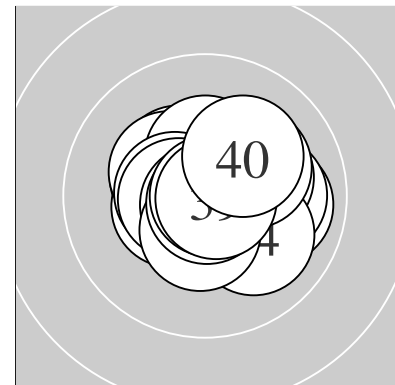

Serie 1:  
 9.9 → 10.6 \* 10.8 \* 10.6 \* 10.7 \*  
 10.7 \* 10.4 \* 10.5 \* 10.4 \* 10.5 \*  
 beste Teiler 37.1 (3.) 68.0 (5.) 70.2 (6.)  
 Trefferlage 0.06 mm rechts, 0.14 mm hoch  
 Streuwert 0.93, horizontal: 1.21, vertikal: 0.53

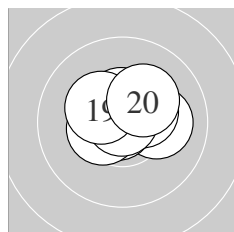

Serie 2:  
 10.9 \* 10.1 → 10.4 \* 10.8 \* 10.6 \*  
 10.4 \* 10.5 \* 10.9 \* 10.3 \* 10.2 \*  
 beste Teiler 7.0 (11.) 15.8 (18.) 33.8 (14.)  
 Trefferlage 0.12 mm rechts, 0.46 mm hoch  
 Streuwert 0.88, horizontal: 1.09, vertikal: 0.60

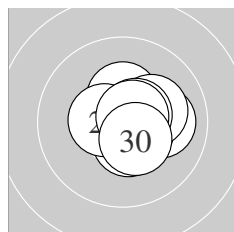

Serie 3:  
 10.0 → 10.5 \* 10.5 \* 10.9 \* 10.4 \*  
 10.2 \* 10.5 \* 10.6 \* 10.7 \* 10.4 \*  
 beste Teiler 19.2 (24.) 68.9 (29.) 92.6 (28.)  
 Trefferlage 0.65 mm rechts, 0.05 mm hoch  
 Streuwert 0.87, horizontal: 0.94, vertikal: 0.79

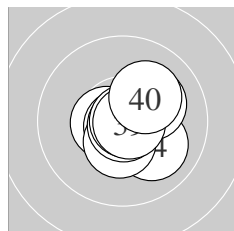

Serie 4:  
 10.7 \* 10.6 \* 10.8 \* 10.0 ↘ 10.4 \*  
 10.2 \* 10.8 \* 10.9 \* 10.8 \* 10.1 ↗  
 beste Teiler 20.0 (38.) 27.8 (37.) 36.6 (33.)  
 Trefferlage 0.47 mm rechts, 0.15 mm tief  
 Streuwert 0.90, horizontal: 0.90, vertikal: 0.89

Unterschrift des Schützen

Meyton Elektronik

Ergebnis: **394** (410.1)  
 Serien: 99 98 99 98  
 Zähler: 34 6 0 0 0 0 0 0 0 0  
 Innenzehner: 21  
 weiteste: 354 (37), 347 (39), 261 (26)  
 beste Teiler 10.7 (29.) 20.6 (7.) 58.2 (25.)  
 Trefferlage 0.45 mm links, 0.11 mm hoch  
 Streuwert 1.32, horizontal: 1.42, vertikal: 1.21

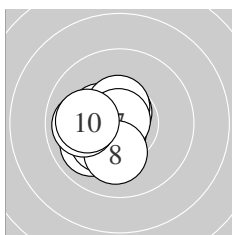
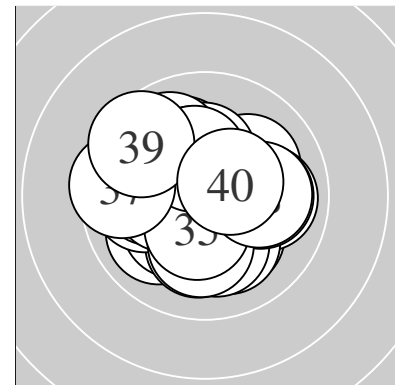

Serie 1:  
 10.7 \*                      10.6 \*                      10.4 \*                      10.0 ↙                      10.5 \*  
 10.2 \*                      10.9 \*                      10.1 ↓                      9.9 ←                      10.0 ←  
 beste Teiler 20.6 (7.) 66.3 (1.) 76.0 (2.)  
 Trefferlage 1.02 mm links, 0.27 mm tief  
 Streuwert 1.02, horizontal: 0.99, vertikal: 1.05

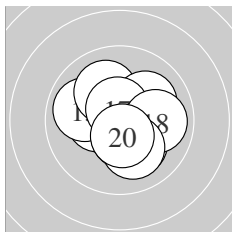

Serie 2:  
 10.3 \*                      10.1 ↘                      9.9 ↖                      10.1 ↗                      10.5 \*  
 10.1 ↗                      10.6 \*                      9.9 →                      10.1 ↓                      10.5 \*  
 beste Teiler 81.3 (17.) 112.6 (20.) 119.4 (15.)  
 Trefferlage 0.17 mm rechts, 0.12 mm tief  
 Streuwert 1.42, horizontal: 1.53, vertikal: 1.31

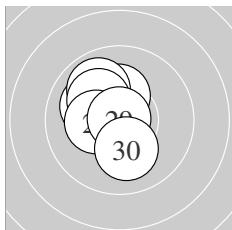

Serie 3:  
 10.3 \*                      10.4 \*                      10.6 \*                      10.1 ↖                      10.7 \*  
 9.9 ↘                      10.1 ↖                      10.3 \*                      10.9 \*                      10.1 ↓  
 beste Teiler 10.7 (29.) 58.2 (25.) 82.3 (23.)  
 Trefferlage 0.87 mm links, 0.51 mm hoch  
 Streuwert 1.02, horizontal: 0.81, vertikal: 1.19

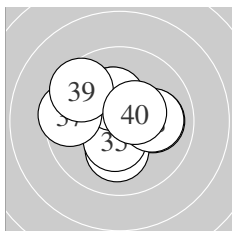

Serie 4:  
 10.3 \*                      10.0 →                      10.1 ↓                      10.6 \*                      10.4 \*  
 10.3 \*                      9.5 ←                      10.0 →                      9.6 ↖                      10.5 \*  
 beste Teiler 87.5 (34.) 122.6 (40.) 135.0 (35.)  
 Trefferlage 0.11 mm links, 0.31 mm hoch  
 Streuwert 1.63, horizontal: 1.91, vertikal: 1.30

Unterschrift des Schützen

Meyton Elektronik

Ergebnis: **395** (412.8)  
 Serien: 98 99 100 98  
 Zähler: 35 5 0 0 0 0 0 0 0 0  
 Innenzehner: 31  
 weiteste: 335 (8), 313 (2), 284 (14)  
 beste Teiler 13.4 (11.) 21.5 (35.) 39.8 (39.)  
 Trefferlage 0.42 mm links, 0.27 mm hoch  
 Streuwert 1.20, horizontal: 1.34, vertikal: 1.03

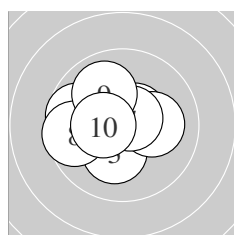
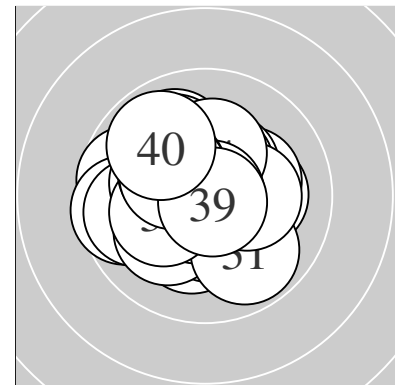

Serie 1:  
 10.5 \*                      9.7 ←                      10.2 \*                      10.3 \*                      10.1 →  
 10.4 \*                      10.7 \*                      9.6 ←                      10.0 ↖                      10.4 \*  
 beste Teiler 70.0 (7.) 105.4 (1.) 133.0 (10.)  
 Trefferlage 0.84 mm links, 0.36 mm hoch  
 Streuwert 1.39, horizontal: 1.65, vertikal: 1.07

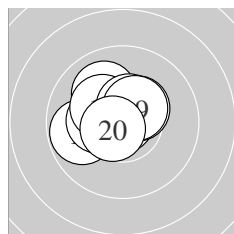

Serie 2:  
 10.9 \*                      10.4 \*                      10.0 ↖                      9.8 ←                      10.4 \*  
 10.3 \*                      10.3 \*                      10.5 \*                      10.4 \*                      10.6 \*  
 beste Teiler 13.4 (11.) 81.5 (20.) 115.3 (18.)  
 Trefferlage 0.67 mm links, 0.56 mm hoch  
 Streuwert 1.02, horizontal: 1.21, vertikal: 0.79

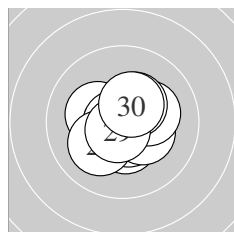

Serie 3:  
 10.4 \*                      10.6 \*                      10.2 \*                      10.3 \*                      10.2 \*  
 10.8 \*                      10.4 \*                      10.1 ↙                      10.7 \*                      10.4 \*  
 beste Teiler 48.2 (26.) 63.8 (29.) 93.4 (22.)  
 Trefferlage 0.10 mm rechts, 0.13 mm tief  
 Streuwert 1.06, horizontal: 1.14, vertikal: 0.98

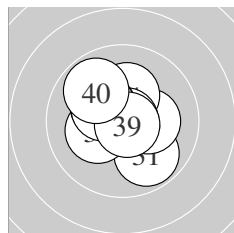

Serie 4:  
 9.8 ↘                      10.6 \*                      10.3 \*                      10.2 \*                      10.9 \*  
 10.2 \*                      10.3 \*                      10.3 \*                      10.8 \*                      9.8 ↘  
 beste Teiler 21.5 (35.) 39.8 (39.) 89.0 (32.)  
 Trefferlage 0.28 mm links, 0.30 mm hoch  
 Streuwert 1.28, horizontal: 1.32, vertikal: 1.25

Unterschrift des Schützen

Meyton Elektronik

Ergebnis: **382** (401.1)  
 Serien: 97 95 94 96  
 Zähler: 22 18 0 0 0 0 0 0 0 0  
 Innenzehner: 14  
 weiteste: 463 (24), 449 (34), 392 (15)  
 beste Teiler 55.3 (32.) 63.5 (31.) 63.9 (12.)  
 Trefferlage 0.08 mm rechts, 0.19 mm hoch  
 Streuwert 1.82, horizontal: 1.95, vertikal: 1.69

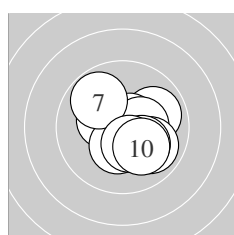
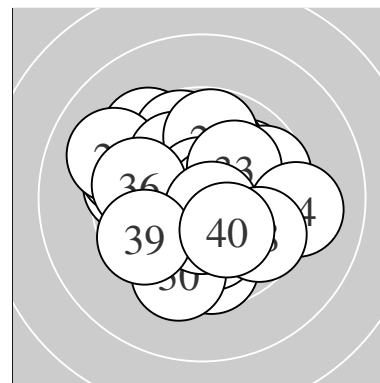

Serie 1:  
 10.4 \* 9.9 ↗ 10.7 \* 10.4 \* 9.9 ↘  
 10.4 \* 9.8 ↘ 10.1 ↘ 10.4 \* 10.1 ↘  
 beste Teiler 69.6 (3.) 141.6 (9.) 141.7 (4.)  
 Trefferlage 0.63 mm rechts, 0.28 mm tief  
 Streuwert 1.38, horizontal: 1.46, vertikal: 1.29

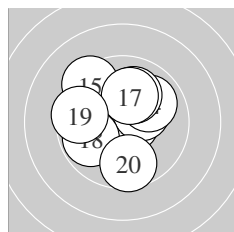

Serie 2:  
 10.1 ↗ 10.7 \* 10.3 \* 9.9 ↗ 9.4 ↘  
 10.0 ↗ 10.1 ↗ 9.8 ↙ 9.6 ← 9.6 ↓  
 beste Teiler 63.9 (12.) 167.2 (13.) 207.0 (11.)  
 Trefferlage 0.15 mm links, 0.72 mm hoch  
 Streuwert 1.89, horizontal: 1.92, vertikal: 1.86

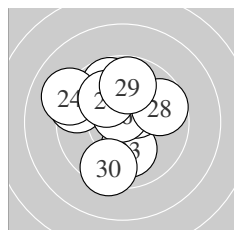

Serie 3:  
 9.7 ↘ 9.4 ↖ 10.1 ↓ 9.1 ↖ 10.4 \*  
 10.7 \* 10.1 ↘ 9.7 ↗ 9.8 ↑ 9.5 ↓  
 beste Teiler 67.9 (26.) 142.8 (25.) 217.1 (23.)  
 Trefferlage 0.64 mm links, 0.81 mm hoch  
 Streuwert 2.10, horizontal: 2.11, vertikal: 2.09

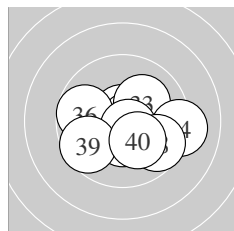

Serie 4:  
 10.7 \* 10.7 \* 10.1 ↗ 9.2 → 10.4 \*  
 9.7 ← 10.7 \* 9.7 ↘ 9.6 ↙ 10.2 \*  
 beste Teiler 55.3 (32.) 63.5 (31.) 70.1 (37.)  
 Trefferlage 0.51 mm rechts, 0.48 mm tief  
 Streuwert 1.78, horizontal: 2.24, vertikal: 1.14

Unterschrift des Schützen

Meyton Elektronik

Ergebnis: **387** (405.3)

Serien: 97 97 98 95

Zähler: 28 11 1 0 0 0 0 0 0 0

Innenzehner: 21

weiteste: 529 (38), 390 (37), 388 (8)

beste Teiler 37.6 (40.) 47.0 (6.) 51.1 (28.)

Trefferlage 0.17 mm rechts, 0.33 mm tief

Streuwert 1.65, horizontal: 1.98, vertikal: 1.24

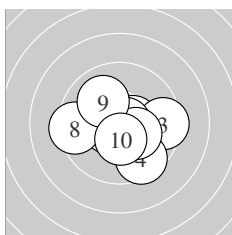
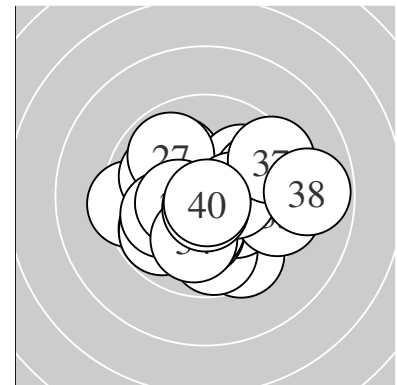

Serie 1:

10.5 *	10.6 *	9.5 →	9.5 ↘	10.5 *
10.8 *	10.3 *	9.4 ←	10.0 ↖	10.4 *

beste Teiler 47.0 (6.) 96.6 (2.) 114.8 (1.)

Trefferlage 0.26 mm rechts, 0.53 mm tief

Streuwert 1.70, horizontal: 2.05, vertikal: 1.26

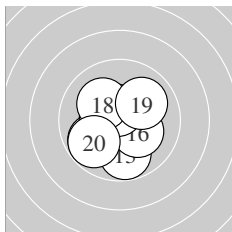

Serie 2:

10.5 *	9.8 ↙	9.8 ↓	10.5 *	10.5 *
10.2 *	10.6 *	10.1 ↘	10.0 ↗	9.8 ↙

beste Teiler 85.7 (17.) 111.5 (14.) 124.0 (11.)

Trefferlage 0.54 mm links, 0.31 mm tief

Streuwert 1.47, horizontal: 1.45, vertikal: 1.49

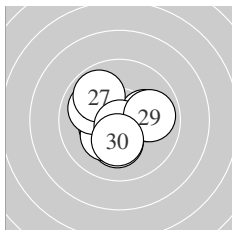

Serie 3:

10.4 *	10.2 *	10.1 →	10.5 *	10.3 *
10.0 ↖	9.9 ↘	10.7 *	9.9 →	10.3 *

beste Teiler 51.1 (28.) 112.2 (24.) 138.5 (21.)

Trefferlage 0.30 mm links, 0.25 mm tief

Streuwert 1.42, horizontal: 1.58, vertikal: 1.24

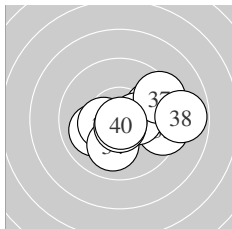

Serie 4:

10.0 ↙	10.4 *	9.4 →	10.0 ↓	9.8 →
10.4 *	9.4 ↗	8.8 →	10.7 *	10.8 *

beste Teiler 37.6 (40.) 63.0 (39.) 142.8 (32.)

Trefferlage 1.26 mm rechts, 0.23 mm tief

Streuwert 1.90, horizontal: 2.45, vertikal: 1.12

Unterschrift des Schützen

Meyton Elektronik

Ergebnis: **386** (403.7)  
 Serien: 97 97 94 98  
 Zähler: 27 12 1 0 0 0 0 0 0 0  
 Innenzehner: 19  
 weiteste: 648 (28), 446 (12), 420 (27)  
 beste Teiler 17.8 (17.) 18.4 (34.) 33.0 (19.)  
 Trefferlage 0.67 mm links, 0.24 mm tief  
 Streuwert 1.72, horizontal: 2.10, vertikal: 1.21

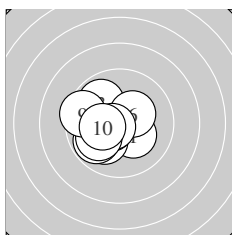
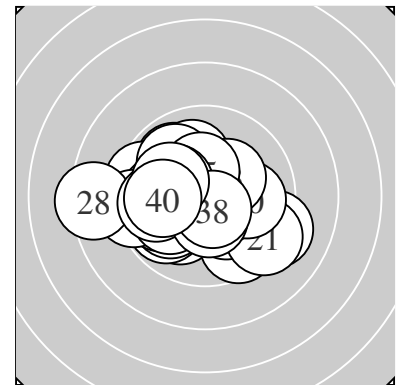

Serie 1:  
 10.3 \* 10.1 ↙ 9.9 ↘ 10.5 \* 9.8 ↙  
 10.3 \* 10.6 \* 10.0 ↙ 9.5 ↖ 10.3 \*  
 beste Teiler 77.8 (7.) 101.2 (4.) 153.4 (6.)  
 Trefferlage 1.17 mm links, 0.33 mm tief  
 Streuwert 1.39, horizontal: 1.52, vertikal: 1.25

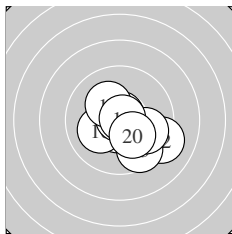

Serie 2:  
 10.6 \* 9.2 ↘ 9.6 ↘ 10.7 \* 9.9 ↘  
 10.1 ↙ 10.9 \* 10.2 \* 10.8 \* 10.2 \*  
 beste Teiler 17.8 (17.) 33.0 (19.) 55.5 (14.)  
 Trefferlage 0.67 mm rechts, 0.66 mm tief  
 Streuwert 1.54, horizontal: 1.76, vertikal: 1.28

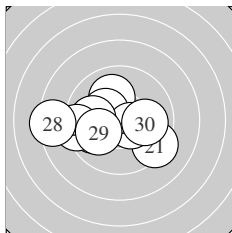

Serie 3:  
 9.3 ↘ 9.9 ↙ 10.0 ↗ 10.3 \* 10.5 \*  
 9.9 ↖ 9.3 ↖ 8.4 ↖ 10.0 ↙ 10.0 →  
 beste Teiler 120.7 (25.) 158.8 (24.) 229.5 (23.)  
 Trefferlage 1.29 mm links, 0.31 mm tief  
 Streuwert 2.29, horizontal: 3.00, vertikal: 1.21

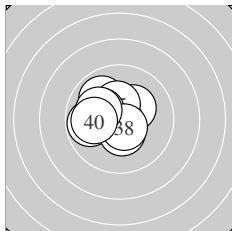

Serie 4:  
 9.8 ↖ 9.9 ↘ 10.3 \* 10.9 \* 10.4 \*  
 10.2 \* 10.4 \* 10.6 \* 10.1 ↖ 10.0 ↖  
 beste Teiler 18.4 (34.) 89.5 (38.) 134.1 (37.)  
 Trefferlage 0.92 mm links, 0.32 mm hoch  
 Streuwert 1.24, horizontal: 1.41, vertikal: 1.04

Unterschrift des Schützen

Ergebnis: **383** (400.6)  
 Serien: 94 97 96 96  
 Zähler: 27 9 4 0 0 0 0 0 0 0  
 Innenzehner: 23  
 weiteste: 593 (38), 581 (10), 518 (16)  
 beste Teiler 13.6 (5.) 43.0 (22.) 48.0 (12.)  
 Trefferlage 0.49 mm links, 0.55 mm hoch  
 Streuwert 1.93, horizontal: 2.23, vertikal: 1.56

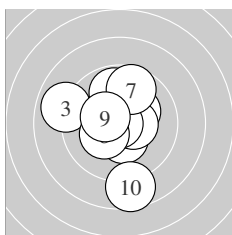
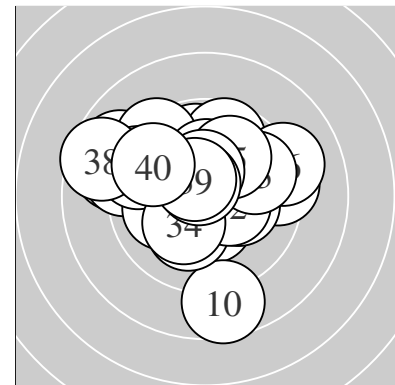

Serie 1:  
 10.2 \*                      10.4 \*                      8.9 ↖                      10.5 \*                      10.9 \*  
 9.8 ↑                      9.7 ↑                      10.3 \*                      10.4 \*                      8.6 ↓  
 beste Teiler 13.6 (5.) 123.4 (4.) 141.9 (9.)  
 Trefferlage 0.31 mm links, 0.06 mm hoch  
 Streuwert 2.21, horizontal: 1.89, vertikal: 2.49

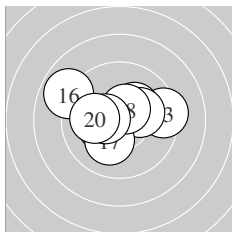

Serie 2:  
 10.3 \*                      10.8 \*                      9.4 →                      10.2 \*                      10.2 \*  
 8.9 ↖                      10.1 ↙                      10.5 \*                      10.4 \*                      10.1 ←  
 beste Teiler 48.0 (12.) 113.1 (18.) 128.5 (19.)  
 Trefferlage 0.33 mm links, 0.40 mm hoch  
 Streuwert 1.86, horizontal: 2.38, vertikal: 1.11

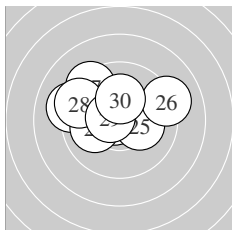

Serie 3:  
 9.1 ↖                      10.8 \*                      10.5 \*                      10.0 ←                      10.2 \*  
 9.1 →                      9.3 ↘                      9.4 ↖                      10.6 \*                      10.2 \*  
 beste Teiler 43.0 (22.) 87.0 (29.) 113.8 (23.)  
 Trefferlage 0.88 mm links, 0.92 mm hoch  
 Streuwert 1.99, horizontal: 2.56, vertikal: 1.17

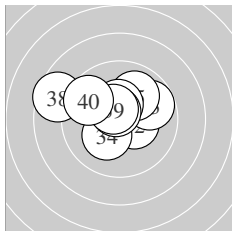

Serie 4:  
 10.6 \*                      10.4 \*                      9.8 ↗                      10.2 \*                      10.0 ↗  
 10.4 \*                      10.7 \*                      8.6 ↖                      10.5 \*                      9.6 ↖  
 beste Teiler 73.7 (37.) 81.7 (31.) 105.1 (39.)  
 Trefferlage 0.43 mm links, 0.81 mm hoch  
 Streuwert 1.86, horizontal: 2.37, vertikal: 1.13

Unterschrift des Schützen

Meyton Elektronik