

Ergebnis: **388** (408.0)
 Serien: 100 97 94 97
 Zähler: 28 12 0 0 0 0 0 0 0 0
 Innenzehner: 23
 weiteste: 354 (36), 342 (17), 336 (28)
 beste Teiler 20.0 (8.) 49.9 (20.) 52.1 (34.)
 Trefferlage 0.24 mm links, 0.04 mm hoch
 Streuwert 1.48, horizontal: 1.62, vertikal: 1.33

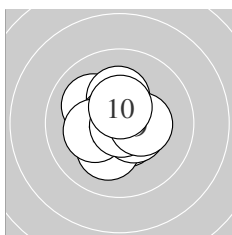

Serie 1:
 10.1 ↖ 10.6 * 10.2 * 10.5 * 10.2 *
 10.7 * 10.2 * 10.9 * 10.4 * 10.5 *
 beste Teiler 20.0 (8.) 60.8 (6.) 97.2 (2.)
 Trefferlage 0.18 mm links, 0.04 mm hoch
 Streuwert 1.09, horizontal: 1.09, vertikal: 1.08

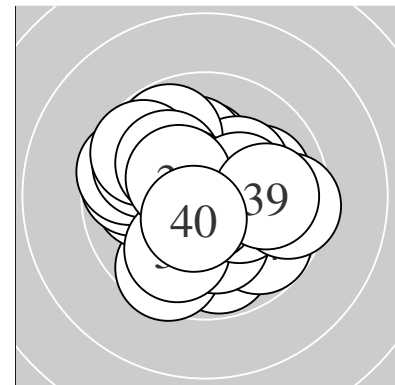
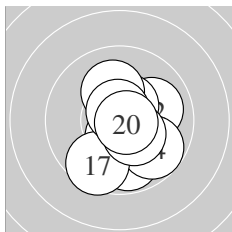

Serie 2:
 9.8 ↓ 10.0 → 10.5 * 9.8 ↘ 10.5 *
 10.1 ↑ 9.6 ↙ 10.4 * 10.7 * 10.8 *
 beste Teiler 49.9 (20.) 65.3 (19.) 113.6 (13.)
 Trefferlage 0.47 mm rechts, 0.55 mm tief
 Streuwert 1.46, horizontal: 1.19, vertikal: 1.69

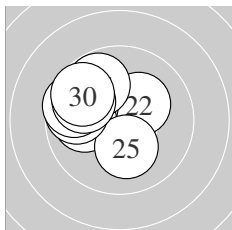

Serie 3:
 10.4 * 10.2 * 9.9 ↖ 10.0 ← 10.2 *
 9.7 ← 9.8 ↘ 9.6 ← 9.8 ↖ 9.7 ↖
 beste Teiler 135.2 (21.) 176.8 (22.) 195.0 (25.)
 Trefferlage 1.65 mm links, 0.86 mm hoch
 Streuwert 1.38, horizontal: 1.56, vertikal: 1.18

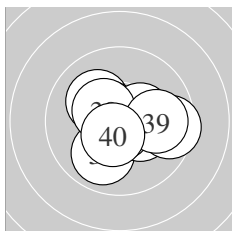

Serie 4:
 9.9 ↙ 10.3 * 10.1 ↖ 10.7 * 10.6 *
 9.5 → 10.3 * 10.4 * 9.9 → 10.5 *
 beste Teiler 52.1 (34.) 99.2 (35.) 108.2 (40.)
 Trefferlage 0.39 mm rechts, 0.15 mm tief
 Streuwert 1.44, horizontal: 1.76, vertikal: 1.04

Unterschrift des Schützen

Meyton Elektronik

Ergebnis: **392** (409.6)
 Serien: 96 99 98 99
 Zähler: 32 8 0 0 0 0 0 0 0 0
 Innenzehner: 26
 weiteste: 382 (30), 307 (11), 289 (8)
 beste Teiler 19.1 (19.) 54.4 (33.) 55.7 (15.)
 Trefferlage 0.07 mm rechts, 0.46 mm hoch
 Streuwert 1.37, horizontal: 1.48, vertikal: 1.25

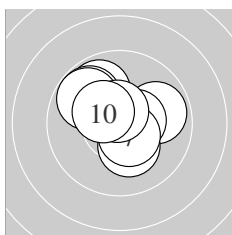
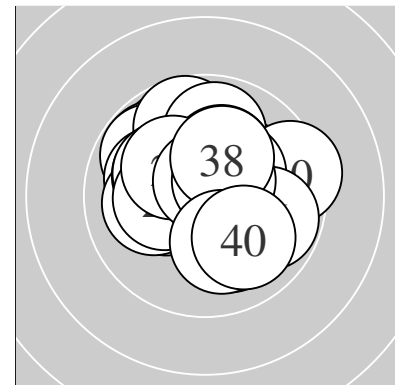

Serie 1:
 9.9 ↘ 10.7 * 9.9 → 10.5 * 9.8 ↘
 10.2 * 10.5 * 9.8 ↘ 10.6 * 10.4 *
 beste Teiler 63.5 (2.) 87.2 (9.) 111.8 (7.)
 Trefferlage 0.23 mm links, 0.66 mm hoch
 Streuwert 1.40, horizontal: 1.56, vertikal: 1.22

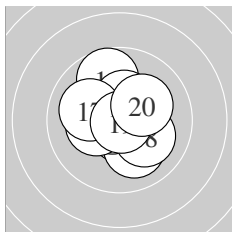

Serie 2:
 9.7 ↑ 10.6 * 10.1 ↓ 10.4 * 10.7 *
 10.3 * 10.1 ← 10.1 ↘ 10.9 * 10.2 *
 beste Teiler 19.1 (19.) 55.7 (15.) 83.6 (12.)
 Trefferlage 0.01 mm links, 0.15 mm hoch
 Streuwert 1.36, horizontal: 1.31, vertikal: 1.41

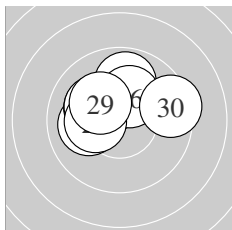

Serie 3:
 10.1 ← 10.2 * 10.4 * 10.3 * 9.9 ↑
 10.2 * 10.2 * 10.3 * 10.2 * 9.4 →
 beste Teiler 150.4 (23.) 174.9 (24.) 175.2 (28.)
 Trefferlage 0.46 mm links, 1.09 mm hoch
 Streuwert 1.42, horizontal: 1.81, vertikal: 0.87

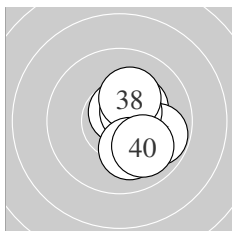

Serie 4:
 10.4 * 10.3 * 10.7 * 10.3 * 10.7 *
 9.8 → 10.5 * 10.2 * 10.1 ↓ 10.0 ↘
 beste Teiler 54.4 (33.) 65.0 (35.) 105.1 (37.)
 Trefferlage 1.02 mm rechts, 0.06 mm tief
 Streuwert 1.06, horizontal: 0.77, vertikal: 1.29

Unterschrift des Schützen

Ergebnis: **385** (401.4)
 Serien: 97 99 95 94
 Zähler: 26 13 1 0 0 0 0 0 0 0
 Innenzehner: 21
 weiteste: 518 (35), 494 (2), 413 (34)
 beste Teiler 70.8 (11.) 78.1 (18.) 80.4 (1.)
 Trefferlage 0.32 mm links, 0.68 mm hoch
 Streuwert 1.74, horizontal: 1.90, vertikal: 1.56

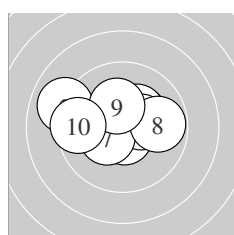
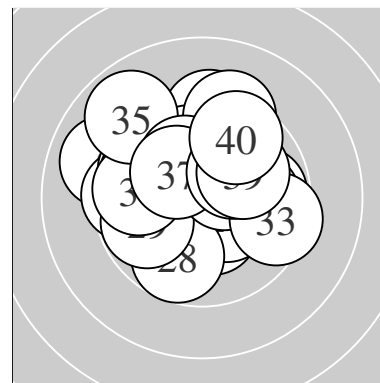

Serie 1:
 10.6 * 9.0 ↖ 10.3 * 10.3 * 10.3 *
 10.6 * 10.4 * 9.8 → 10.2 * 9.5 ←
 beste Teiler 80.4 (1.) 87.6 (6.) 147.5 (7.)
 Trefferlage 0.35 mm links, 0.55 mm hoch
 Streuwert 1.76, horizontal: 2.32, vertikal: 0.90

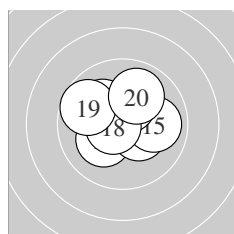

Serie 2:
 10.7 * 10.4 * 10.2 * 10.4 * 10.0 →
 10.3 * 10.1 ↘ 10.6 * 9.7 ↖ 10.0 ↗
 beste Teiler 70.8 (11.) 78.1 (18.) 128.7 (12.)
 Trefferlage 0.26 mm links, 0.50 mm hoch
 Streuwert 1.39, horizontal: 1.59, vertikal: 1.15

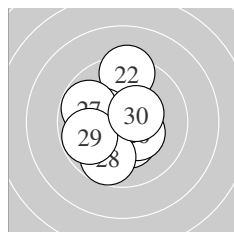

Serie 3:
 10.3 * 9.4 ↑ 10.3 * 10.3 * 9.9 ↙
 10.4 * 9.8 ↖ 9.7 ↓ 9.8 ← 10.4 *
 beste Teiler 128.1 (30.) 145.4 (26.) 154.9 (23.)
 Trefferlage 0.76 mm links, 0.12 mm tief
 Streuwert 1.73, horizontal: 1.44, vertikal: 1.97

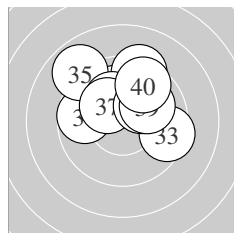

Serie 4:
 9.7 ← 10.0 ↑ 9.5 → 9.3 ↑ 8.9 ↖
 10.2 * 10.3 * 10.2 * 10.0 ↗ 9.6 ↗
 beste Teiler 174.6 (37.) 192.3 (36.) 194.6 (38.)
 Trefferlage 0.08 mm rechts, 1.78 mm hoch
 Streuwert 1.94, horizontal: 2.28, vertikal: 1.53

Unterschrift des Schützen

Meyton Elektronik

Ergebnis: **381** (399.5)
 Serien: 96 93 97 95
 Zähler: 23 15 2 0 0 0 0 0 0 0
 Innenzehner: 16
 weiteste: 550 (17), 505 (38), 488 (12)
 beste Teiler 40.8 (6.) 48.6 (29.) 57.0 (1.)
 Trefferlage 0.02 mm rechts, 0.25 mm hoch
 Streuwert 1.97, horizontal: 2.40, vertikal: 1.40

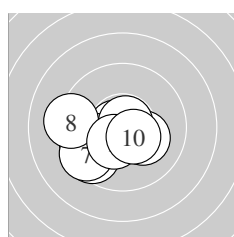
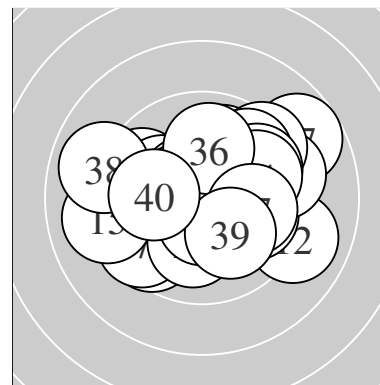

Serie 1:
 10.7 * 9.7 ← 10.2 * 10.0 ← 9.6 ↙
 10.8 * 9.5 ↙ 9.2 ← 10.4 * 10.5 *
 beste Teiler 40.8 (6.) 57.0 (1.) 118.3 (10.)
 Trefferlage 1.32 mm links, 0.89 mm tief
 Streuwert 1.52, horizontal: 1.92, vertikal: 0.97

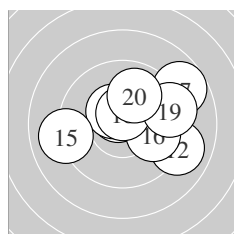

Serie 2:
 10.6 * 9.0 → 10.1 ↗ 10.4 * 9.0 ←
 9.9 → 8.8 ↗ 10.6 * 9.3 → 9.9 ↑
 beste Teiler 82.7 (11.) 89.0 (18.) 130.8 (14.)
 Trefferlage 1.26 mm rechts, 0.65 mm hoch
 Streuwert 2.29, horizontal: 2.88, vertikal: 1.50

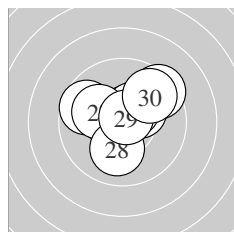

Serie 3:
 9.7 ↖ 10.6 * 9.4 ↗ 10.3 * 10.3 *
 10.4 * 10.1 ↖ 10.1 ↓ 10.8 * 9.7 ↗
 beste Teiler 48.6 (29.) 80.9 (22.) 131.6 (26.)
 Trefferlage 0.11 mm rechts, 0.81 mm hoch
 Streuwert 1.58, horizontal: 1.85, vertikal: 1.25

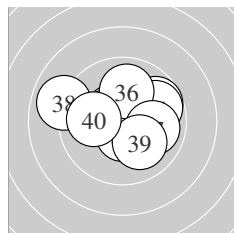

Serie 4:
 9.7 ↗ 10.5 * 10.5 * 9.8 → 10.5 *
 10.0 ↑ 9.9 → 8.9 ← 10.1 ↘ 10.0 ←
 beste Teiler 108.0 (35.) 111.0 (32.) 112.9 (33.)
 Trefferlage 0.06 mm rechts, 0.44 mm hoch
 Streuwert 1.95, horizontal: 2.43, vertikal: 1.28

Unterschrift des Schützen

Meyton Elektronik

Ergebnis:	368	(386.5)
Serien:	89 94 94 91	
Zähler:	16 16 8 0 0 0 0 0 0 0	
Innenzehner:	14	
weiteste:	681 (38), 661 (33), 658 (37)	
beste Teiler	44.4 (20.) 48.0 (24.) 63.8 (39.)	
Trefferlage	0.61 mm links, 0.04 mm tief	
Streuwert	2.66, horizontal: 2.81, vertikal: 2.50	

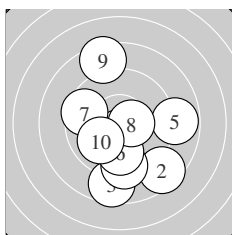
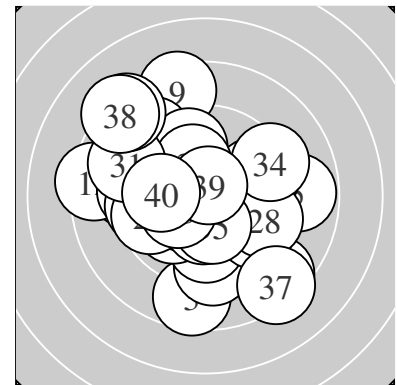

Serie 1:	10.6 *	8.5 ↘	8.6 ↓	9.3 ↓	8.8 →
	9.8 ↓	9.5 ←	10.5 *	8.4 ↑	10.0 ↙
beste Teiler	90.0 (1.) 113.0 (8.) 247.0 (10.)				
Trefferlage	0.34 mm rechts, 1.24 mm tief				
Streuwert	3.05, horizontal: 2.64, vertikal: 3.41				

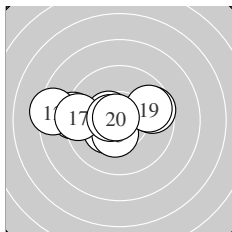

Serie 2:	9.2 ←	8.4 ←	9.6 →	10.3 *	10.4 *
	10.5 *	9.4 ←	10.6 *	9.7 →	10.8 *
beste Teiler	44.4 (20.) 93.3 (18.) 118.0 (16.)				
Trefferlage	1.29 mm links, 0.24 mm hoch				
Streuwert	2.20, horizontal: 3.02, vertikal: 0.79				

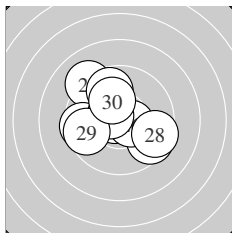

Serie 3:	9.1 ↖	9.8 ↑	9.5 ↘	10.8 *	9.5 ←
	10.5 *	10.6 *	9.5 →	9.6 ←	10.1 ↑
beste Teiler	48.0 (24.) 99.2 (27.) 114.1 (26.)				
Trefferlage	0.53 mm links, 0.32 mm hoch				
Streuwert	2.14, horizontal: 2.41, vertikal: 1.83				

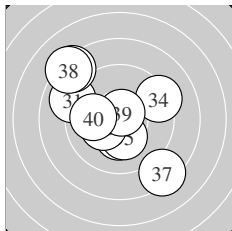

Serie 4:	9.0 ↖	10.3 *	8.3 ↖	9.3 →	10.3 *
	10.3 *	8.3 ↘	8.2 ↖	10.7 *	9.9 ←
beste Teiler	63.8 (39.) 170.2 (32.) 172.2 (35.)				
Trefferlage	0.96 mm links, 0.49 mm hoch				
Streuwert	3.16, horizontal: 3.26, vertikal: 3.05				

Unterschrift des Schützen

Meyton Elektronik

Ergebnis: **384** (402.3)
 Serien: 96 94 97 97
 Zähler: 25 14 1 0 0 0 0 0 0 0
 Innenzehner: 21
 weiteste: 690 (3), 440 (11), 407 (32)
 beste Teiler 53.6 (13.) 63.7 (26.) 66.4 (39.)
 Trefferlage 0.86 mm rechts, 0.26 mm tief
 Streuwert 1.72, horizontal: 2.07, vertikal: 1.29

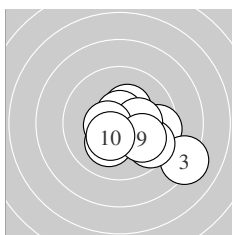
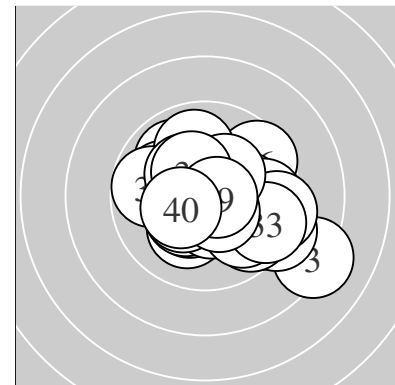

Serie 1:
 10.3 * 9.5 → 8.2 ↘ 10.1 ✓ 10.6 *
 9.6 ↘ 10.3 * 10.5 * 10.0 ↘ 10.4 *
 beste Teiler 78.0 (5.) 111.6 (8.) 146.2 (10.)
 Trefferlage 1.40 mm rechts, 0.81 mm tief
 Streuwert 1.91, horizontal: 2.31, vertikal: 1.41

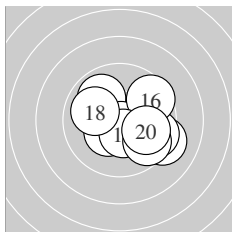

Serie 2:
 9.2 ↘ 9.9 ↖ 10.7 * 9.6 ↘ 10.3 *
 9.6 ↗ 10.4 * 10.0 ← 9.7 ↘ 9.9 →
 beste Teiler 53.6 (13.) 127.6 (17.) 152.7 (15.)
 Trefferlage 1.05 mm rechts, 0.41 mm tief
 Streuwert 1.90, horizontal: 2.24, vertikal: 1.48

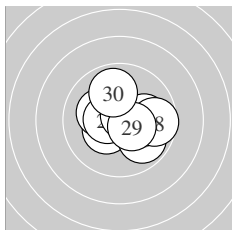

Serie 3:
 10.4 * 10.2 * 10.5 * 10.2 * 9.9 ↘
 10.7 * 10.0 → 9.7 → 10.4 * 9.9 ↑
 beste Teiler 63.7 (26.) 113.2 (23.) 127.4 (29.)
 Trefferlage 0.62 mm rechts, 0.00 mm
 Streuwert 1.46, horizontal: 1.73, vertikal: 1.13

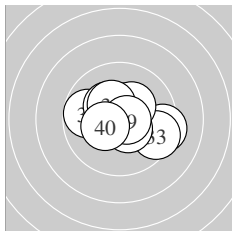

Serie 4:
 9.8 ← 9.3 → 9.5 ↘ 10.3 * 10.5 *
 10.5 * 10.3 * 10.3 * 10.7 * 10.4 *
 beste Teiler 66.4 (39.) 112.1 (35.) 117.5 (36.)
 Trefferlage 0.36 mm rechts, 0.14 mm hoch
 Streuwert 1.68, horizontal: 2.12, vertikal: 1.06

Unterschrift des Schützen

Meyton Elektronik

Ergebnis:	376	(395.9)
Serien:	94 93 96 93	
Zähler:	17 22 1 0 0 0 0 0 0 0	
Innenzehner:	13	
weiteste:	518 (19), 460 (14), 442 (11)	
beste Teiler	25.1 (20.) 52.0 (29.) 56.7 (13.)	
Trefferlage	0.25 mm rechts, 0.12 mm hoch	
Streuwert	2.06, horizontal: 2.37, vertikal: 1.70	

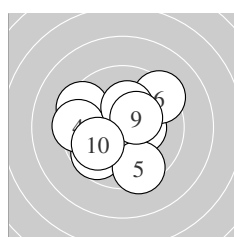
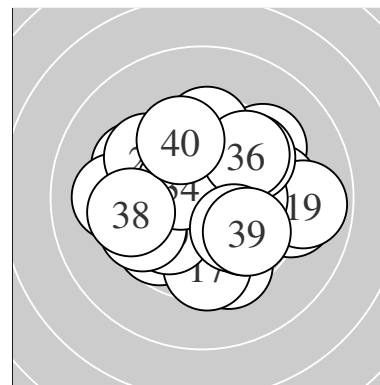

Serie 1:	9.4 ↘	9.7 ↗	10.4 *	9.4 ←	9.5 ↓
	9.3 ↗	10.4 *	10.3 *	10.4 *	9.9 ↙
beste Teiler	134.7 (7.) 140.9 (9.) 150.0 (3.)				
Trefferlage	0.30 mm links, 0.07 mm hoch				
Streuwert	2.14, horizontal: 2.36, vertikal: 1.90				

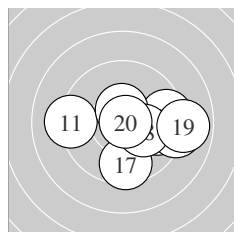

Serie 2:	9.2 ←	9.7 →	10.7 *	9.1 →	9.5 →
	10.5 *	9.5 ↓	10.2 *	8.9 →	10.9 *
beste Teiler	25.1 (20.) 56.7 (13.) 105.3 (16.)				
Trefferlage	1.45 mm rechts, 0.38 mm tief				
Streuwert	2.18, horizontal: 2.83, vertikal: 1.25				

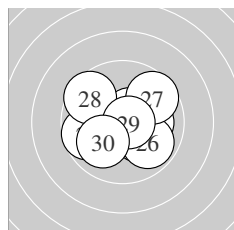

Serie 3:	10.1 →	10.5 *	10.6 *	9.7 ←	10.2 *
	9.9 ↘	9.6 ↗	9.6 ↘	10.7 *	10.0 ↙
beste Teiler	52.0 (29.) 93.4 (23.) 124.0 (22.)				
Trefferlage	0.06 mm rechts, 0.07 mm tief				
Streuwert	1.76, horizontal: 2.08, vertikal: 1.38				

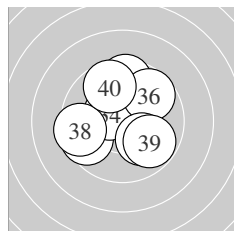

Serie 4:	10.0 ↗	9.7 ↑	9.6 ↙	10.4 *	9.6 ↑
	9.7 ↗	10.1 ↘	9.5 ←	9.8 ↘	9.7 ↑
beste Teiler	126.2 (34.) 224.9 (37.) 244.7 (31.)				
Trefferlage	0.19 mm links, 0.89 mm hoch				
Streuwert	2.09, horizontal: 2.07, vertikal: 2.11				

Unterschrift des Schützen

Ergebnis: **399** (417.3)
 Serien: 100 100 100 99
 Zähler: 39 1 0 0 0 0 0 0 0 0
 Innenzehner: 35
 weiteste: 481 (33), 231 (3), 229 (36)
 beste Teiler 36.2 (31.) 38.0 (1.) 42.4 (17.)
 Trefferlage 0.01 mm links, 0.02 mm hoch
 Streuwert 1.10, horizontal: 1.20, vertikal: 0.98

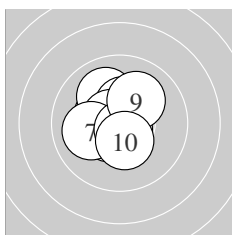
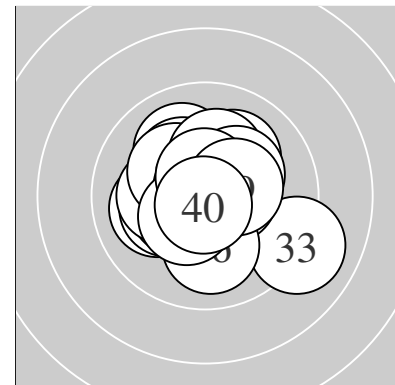

Serie 1:
 10.8 * 10.4 * 10.0 ↗ 10.4 * 10.5 *
 10.7 * 10.0 ← 10.7 * 10.1 ↗ 10.4 *
 beste Teiler 38.0 (1.) 55.5 (8.) 75.5 (6.)
 Trefferlage 0.37 mm links, 0.32 mm hoch
 Streuwert 1.07, horizontal: 1.01, vertikal: 1.13

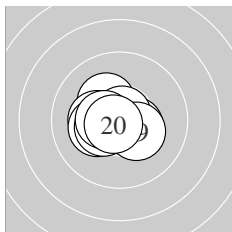

Serie 2:
 10.8 * 10.3 * 10.3 * 10.2 * 10.4 *
 10.5 * 10.8 * 10.5 * 10.3 * 10.7 *
 beste Teiler 42.4 (17.) 46.6 (11.) 57.1 (20.)
 Trefferlage 0.50 mm links, 0.05 mm tief
 Streuwert 0.90, horizontal: 1.09, vertikal: 0.65

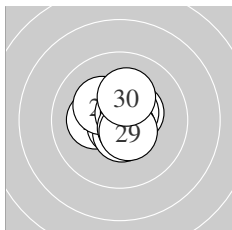

Serie 3:
 10.2 * 10.8 * 10.6 * 10.3 * 10.4 *
 10.7 * 10.6 * 10.6 * 10.5 * 10.2 *
 beste Teiler 50.7 (22.) 62.6 (26.) 79.3 (28.)
 Trefferlage 0.07 mm rechts, 0.17 mm hoch
 Streuwert 0.93, horizontal: 0.96, vertikal: 0.90

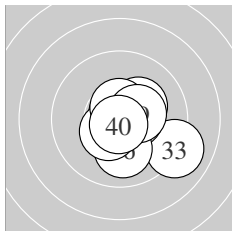

Serie 4:
 10.8 * 10.8 * 9.0 ↘ 10.3 * 10.5 *
 10.0 ↓ 10.4 * 10.6 * 10.4 * 10.8 *
 beste Teiler 36.2 (31.) 42.5 (32.) 42.7 (40.)
 Trefferlage 0.75 mm rechts, 0.36 mm tief
 Streuwert 1.31, horizontal: 1.43, vertikal: 1.17

Unterschrift des Schützen

Meyton Elektronik

Ergebnis: **383** (402.2)
 Serien: 97 96 94 96
 Zähler: 23 17 0 0 0 0 0 0 0 0
 Innenzehner: 20
 weiteste: 468 (25), 418 (34), 411 (37)
 beste Teiler 26.1 (10.) 96.1 (38.) 96.3 (36.)
 Trefferlage 0.13 mm links, 0.50 mm hoch
 Streuwert 1.71, horizontal: 1.97, vertikal: 1.40

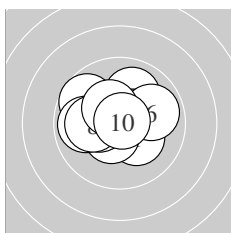
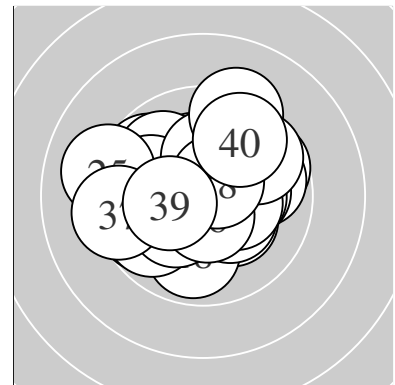

Serie 1:
 10.2 * 10.5 * 10.3 * 9.7 ↘ 10.0 ↗
 9.9 → 9.9 ← 10.1 ← 10.4 * 10.8 *
 beste Teiler 26.1 (10.) 116.7 (2.) 143.9 (9.)
 Trefferlage 0.54 mm links, 0.38 mm hoch
 Streuwert 1.47, horizontal: 1.78, vertikal: 1.09

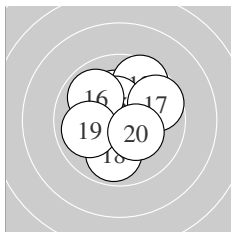

Serie 2:
 10.2 * 10.2 * 9.6 ↗ 10.5 * 10.4 *
 9.9 ↘ 9.7 → 9.9 ↓ 10.0 ← 10.3 *
 beste Teiler 101.4 (14.) 129.7 (15.) 161.6 (20.)
 Trefferlage 0.09 mm rechts, 0.51 mm hoch
 Streuwert 1.68, horizontal: 1.71, vertikal: 1.64

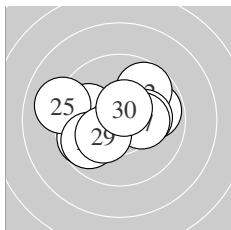

Serie 3:
 9.8 → 9.7 ↗ 9.7 ← 9.9 ← 9.1 ←
 10.2 * 10.3 * 9.8 ← 10.3 * 10.5 *
 beste Teiler 102.5 (30.) 174.8 (29.) 175.0 (27.)
 Trefferlage 0.48 mm links, 0.18 mm hoch
 Streuwert 2.00, horizontal: 2.53, vertikal: 1.27

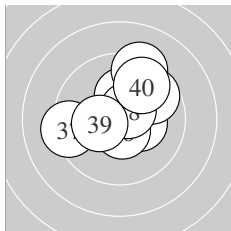

Serie 4:
 10.4 * 10.3 * 10.2 * 9.3 ↗ 9.7 ↗
 10.6 * 9.3 ← 10.6 * 10.3 * 9.7 ↗
 beste Teiler 96.1 (38.) 96.3 (36.) 131.2 (31.)
 Trefferlage 0.37 mm rechts, 0.95 mm hoch
 Streuwert 1.77, horizontal: 1.92, vertikal: 1.61

Unterschrift des Schützen

Meyton Elektronik

Ergebnis: **392** (408.6)
 Serien: 97 98 98 99
 Zähler: 32 8 0 0 0 0 0 0 0 0
 Innenzehner: 24
 weiteste: 437 (16), 409 (36), 359 (6)
 beste Teiler 3.0 (13.) 18.3 (30.) 72.6 (27.)
 Trefferlage 0.05 mm rechts, 0.10 mm hoch
 Streuwert 1.50, horizontal: 1.74, vertikal: 1.20

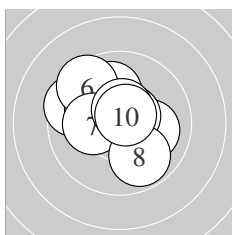
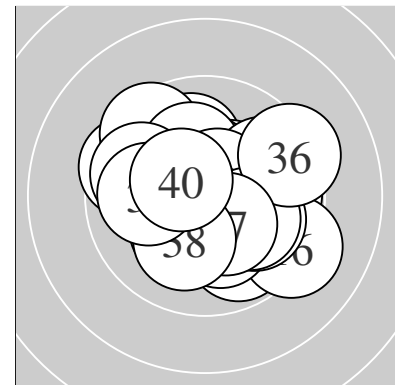

Serie 1:
 9.5 ↖ 10.0 ↑ 10.1 ↖ 10.1 → 10.6 *
 9.5 ↖ 10.2 * 9.8 ↘ 10.5 * 10.7 *
 beste Teiler 73.6 (10.) 91.8 (5.) 101.7 (9.)
 Trefferlage 0.49 mm links, 0.65 mm hoch
 Streuwert 1.62, horizontal: 1.78, vertikal: 1.43

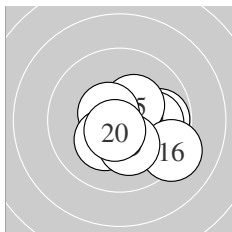

Serie 2:
 10.4 * 9.8 → 10.9 * 10.0 → 10.4 *
 9.2 ↘ 10.6 * 10.2 * 10.2 * 10.6 *
 beste Teiler 3.0 (13.) 82.7 (20.) 95.7 (17.)
 Trefferlage 0.90 mm rechts, 0.59 mm tief
 Streuwert 1.37, horizontal: 1.63, vertikal: 1.06

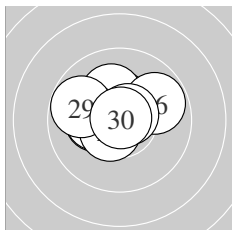

Serie 3:
 10.4 * 10.3 * 10.6 * 10.3 * 10.2 *
 9.8 ↗ 10.7 * 10.5 * 9.8 ↖ 10.9 *
 beste Teiler 18.3 (30.) 72.6 (27.) 86.2 (23.)
 Trefferlage 0.42 mm links, 0.59 mm hoch
 Streuwert 1.18, horizontal: 1.48, vertikal: 0.78

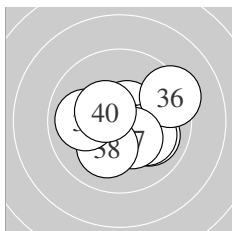

Serie 4:
 10.0 ↘ 10.6 * 10.6 * 10.3 * 10.1 ↘
 9.3 ↗ 10.3 * 10.1 ↓ 10.0 ← 10.5 *
 beste Teiler 88.4 (33.) 91.5 (32.) 125.3 (40.)
 Trefferlage 0.24 mm rechts, 0.22 mm tief
 Streuwert 1.58, horizontal: 1.93, vertikal: 1.11

Unterschrift des Schützen

Meyton Elektronik

Ergebnis: **376** (396.5)
 Serien: 95 93 95 93
 Zähler: 19 18 3 0 0 0 0 0 0
 Innenzehner: 15
 weiteste: 646 (13), 564 (33), 536 (40)
 beste Teiler 28.8 (24.) 53.6 (26.) 57.2 (34.)
 Trefferlage 0.40 mm rechts, 0.09 mm hoch
 Streuwert 2.13, horizontal: 1.95, vertikal: 2.31

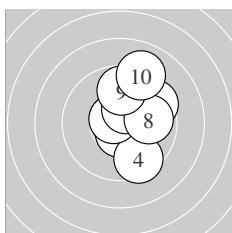
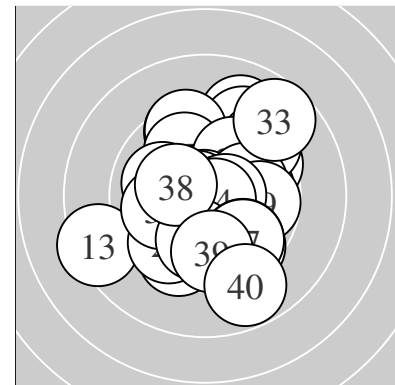

Serie 1:
 10.7 * 10.3 * 10.6 * 9.5 ↘ 9.5 ↗
 10.7 * 10.4 * 9.9 → 9.8 ↑ 9.0 ↑
 beste Teiler 65.1 (1.) 67.6 (6.) 88.0 (3.)
 Trefferlage 1.07 mm rechts, 0.77 mm hoch
 Streuwert 1.73, horizontal: 1.31, vertikal: 2.07

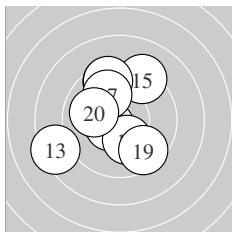

Serie 2:
 9.5 ↑ 10.2 * 8.4 ↙ 10.5 * 9.2 ↗
 9.5 ↑ 9.9 ↘ 10.2 * 9.6 ↘ 10.0 ↖
 beste Teiler 105.1 (14.) 177.1 (12.) 192.4 (18.)
 Trefferlage 0.92 mm links, 0.64 mm hoch
 Streuwert 2.45, horizontal: 2.32, vertikal: 2.57

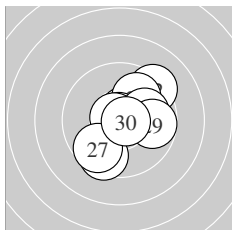

Serie 3:
 10.6 * 9.3 ↗ 9.9 ↗ 10.8 * 9.5 ↘
 10.7 * 9.7 ↙ 10.0 → 9.8 → 10.7 *
 beste Teiler 28.8 (24.) 53.6 (26.) 58.0 (30.)
 Trefferlage 0.68 mm rechts, 0.06 mm hoch
 Streuwert 1.80, horizontal: 1.76, vertikal: 1.85

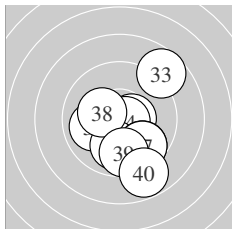

Serie 4:
 10.0 ↖ 10.5 * 8.7 ↗ 10.7 * 10.0 ↓
 9.7 ↘ 9.7 ↘ 10.3 * 9.7 ↓ 8.8 ↘
 beste Teiler 57.2 (34.) 111.1 (32.) 171.2 (38.)
 Trefferlage 0.77 mm rechts, 1.12 mm tief
 Streuwert 2.22, horizontal: 1.89, vertikal: 2.50

Unterschrift des Schützen

Meyton Elektronik

Ergebnis: **383** (403.0)
 Serien: 96 99 95 93
 Zähler: 24 15 1 0 0 0 0 0 0 0
 Innenzehner: 22
 weiteste: 714 (6), 464 (40), 372 (30)
 beste Teiler 55.4 (17.) 87.3 (39.) 88.2 (28.)
 Trefferlage 0.39 mm rechts, 0.32 mm hoch
 Streuwert 1.75, horizontal: 1.97, vertikal: 1.49

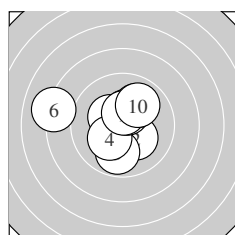
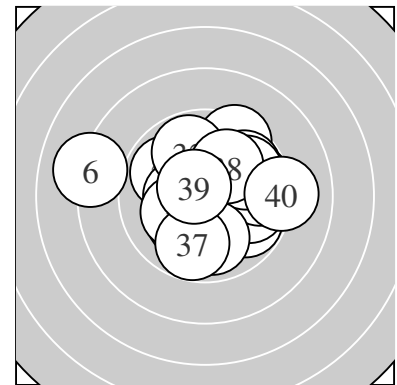

Serie 1:
 10.3 * 10.2 * 9.9 ↓ 10.2 * 10.4 *
 8.1 ← 10.4 * 10.0 ↗ 10.5 * 9.9 ↗
 beste Teiler 124.4 (9.) 130.6 (7.) 140.9 (5.)
 Trefferlage 0.50 mm links, 0.49 mm hoch
 Streuwert 2.11, horizontal: 2.49, vertikal: 1.64

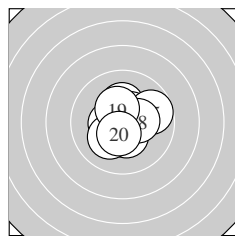

Serie 2:
 10.3 * 10.5 * 10.5 * 10.4 * 9.7 →
 10.2 * 10.7 * 10.3 * 10.4 * 10.5 *
 beste Teiler 55.4 (17.) 115.3 (13.) 122.0 (20.)
 Trefferlage 0.23 mm rechts, 0.13 mm hoch
 Streuwert 1.22, horizontal: 1.27, vertikal: 1.16

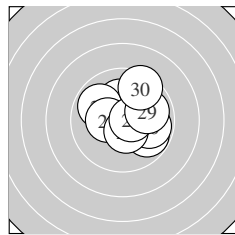

Serie 3:
 9.8 ↘ 10.3 * 10.2 * 9.9 ↖ 10.3 *
 9.9 → 10.5 * 10.6 * 9.9 → 9.5 ↗
 beste Teiler 88.2 (28.) 115.4 (27.) 151.0 (25.)
 Trefferlage 0.80 mm rechts, 0.43 mm hoch
 Streuwert 1.60, horizontal: 1.73, vertikal: 1.45

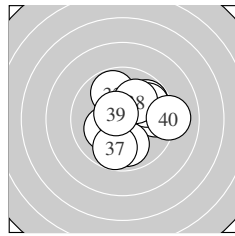

Serie 4:
 9.8 ↗ 9.8 ↖ 9.6 → 9.8 ↗ 10.2 *
 9.9 ↓ 9.8 ↓ 10.1 ↗ 10.6 * 9.1 →
 beste Teiler 87.3 (39.) 193.1 (35.) 221.2 (38.)
 Trefferlage 1.04 mm rechts, 0.23 mm hoch
 Streuwert 1.98, horizontal: 2.11, vertikal: 1.85

Unterschrift des Schützen

Meyton Elektronik

Ergebnis: **376** (394.5)
 Serien: 94 96 90 96
 Zähler: 20 16 4 0 0 0 0 0 0 0
 Innenzehner: 12
 weiteste: 516 (27), 516 (37), 508 (29)
 beste Teiler 48.8 (18.) 93.7 (13.) 98.7 (4.)
 Trefferlage 0.04 mm rechts, 0.64 mm hoch
 Streuwert 2.09, horizontal: 2.20, vertikal: 1.98

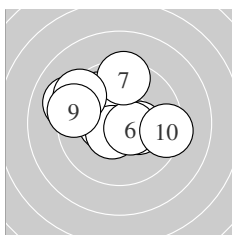
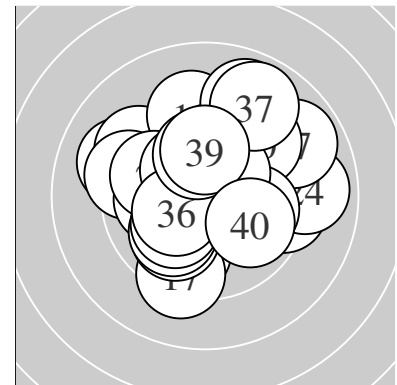

Serie 1:
 9.9 ↘ 10.3 * 10.4 * 10.6 * 9.1 ↖
 10.6 * 9.4 ↑ 9.3 ↙ 9.4 ↖ 9.4 →
 beste Teiler 98.7 (4.) 100.6 (6.) 126.0 (3.)
 Trefferlage 0.83 mm links, 0.86 mm hoch
 Streuwert 2.14, horizontal: 2.60, vertikal: 1.55

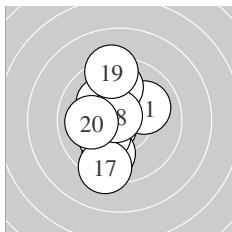

Serie 2:
 10.0 → 9.8 ↑ 10.6 * 9.8 ↓ 10.2 *
 10.1 ↘ 9.3 ↓ 10.8 * 9.3 ↑ 10.0 ←
 beste Teiler 48.8 (18.) 93.7 (13.) 183.1 (15.)
 Trefferlage 0.72 mm links, 0.09 mm hoch
 Streuwert 1.90, horizontal: 1.15, vertikal: 2.42

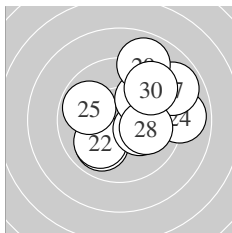

Serie 3:
 9.9 ↙ 10.0 ↙ 10.2 * 8.9 → 9.8 ↖
 9.9 ↗ 8.9 ↗ 10.0 → 8.9 ↑ 9.4 ↗
 beste Teiler 184.4 (23.) 231.0 (28.) 242.2 (22.)
 Trefferlage 1.42 mm rechts, 0.79 mm hoch
 Streuwert 2.37, horizontal: 2.55, vertikal: 2.17

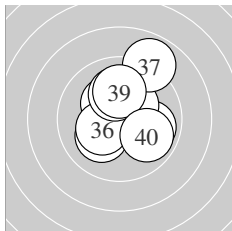

Serie 4:
 9.9 → 10.3 * 10.1 ↙ 10.5 * 10.3 *
 10.3 * 8.9 ↑ 10.1 ↑ 10.0 ↑ 9.9 ↘
 beste Teiler 115.9 (34.) 155.7 (32.) 164.6 (36.)
 Trefferlage 0.33 mm rechts, 0.81 mm hoch
 Streuwert 1.77, horizontal: 1.62, vertikal: 1.90

Unterschrift des Schützen

Meyton Elektronik

Ergebnis: **377** (395.2)
 Serien: 96 90 94 97
 Zähler: 20 17 3 0 0 0 0 0 0 0
 Innenzehner: 17
 weiteste: 645 (20), 582 (16), 528 (33)
 beste Teiler 53.0 (36.) 56.2 (40.) 59.0 (10.)
 Trefferlage 0.27 mm rechts, 0.02 mm tief
 Streuwert 2.20, horizontal: 2.06, vertikal: 2.33

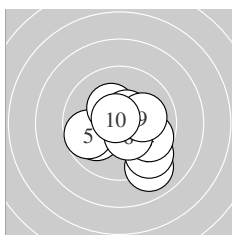
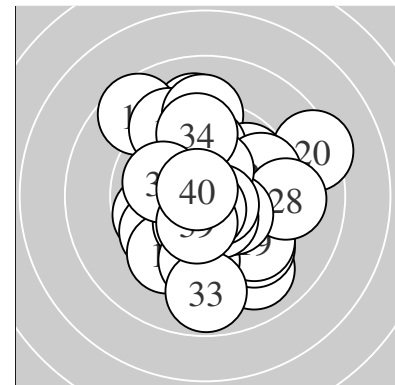

Serie 1:
 9.0 ↘ 10.0 ↙ 9.4 ↘ 9.7 ↘ 9.7 ↙
 10.4 * 10.3 * 10.5 * 10.1 → 10.7 *
 beste Teiler 59.0 (10.) 102.6 (8.) 140.6 (6.)
 Trefferlage 0.55 mm rechts, 0.83 mm tief
 Streuwert 1.89, horizontal: 2.06, vertikal: 1.70

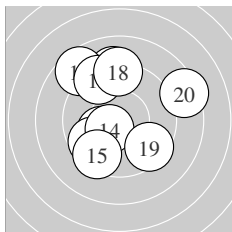

Serie 2:
 10.2 * 9.1 ↑ 9.7 ↙ 10.5 * 9.4 ↙
 8.6 ↘ 9.3 ↘ 9.2 ↑ 9.5 ↘ 8.4 →
 beste Teiler 123.9 (14.) 195.3 (11.) 317.6 (13.)
 Trefferlage 0.49 mm links, 1.03 mm hoch
 Streuwert 3.02, horizontal: 2.84, vertikal: 3.19

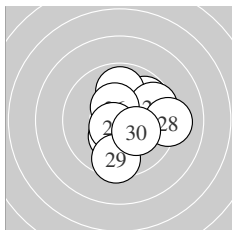

Serie 3:
 9.8 ↗ 9.8 → 9.9 ↑ 9.6 → 10.3 *
 10.4 * 10.6 * 9.2 → 9.5 ↓ 10.2 *
 beste Teiler 85.6 (27.) 126.2 (26.) 162.1 (25.)
 Trefferlage 1.21 mm rechts, 0.06 mm hoch
 Streuwert 1.84, horizontal: 1.85, vertikal: 1.82

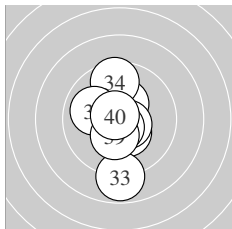

Serie 4:
 10.4 * 10.4 * 8.8 ↓ 9.6 ↑ 10.0 ↙
 10.7 * 10.6 * 10.7 * 10.3 * 10.7 *
 beste Teiler 53.0 (36.) 56.2 (40.) 75.0 (38.)
 Trefferlage 0.16 mm links, 0.38 mm tief
 Streuwert 1.71, horizontal: 0.88, vertikal: 2.25

Unterschrift des Schützen

Meyton Elektronik

Ergebnis: **384** (403.8)
 Serien: 94 96 97 97
 Zähler: 26 12 2 0 0 0 0 0 0 0
 Innenzehner: 21
 weiteste: 610 (38), 539 (28), 479 (11)
 beste Teiler 68.2 (29.) 72.4 (14.) 73.4 (19.)
 Trefferlage 0.53 mm rechts, 0.02 mm hoch
 Streuwert 1.75, horizontal: 1.88, vertikal: 1.60

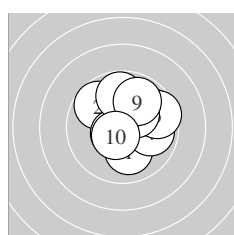
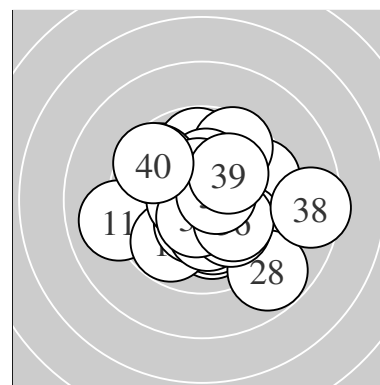

Serie 1:
 10.1 ↓ 9.7 ↖ 9.7 ↗ 9.9 → 9.6 →
 10.3 * 10.6 * 9.8 ↑ 9.8 ↗ 10.5 *
 beste Teiler 95.0 (7.) 101.4 (10.) 171.8 (6.)
 Trefferlage 0.77 mm rechts, 0.71 mm hoch
 Streuwert 1.71, horizontal: 1.78, vertikal: 1.63

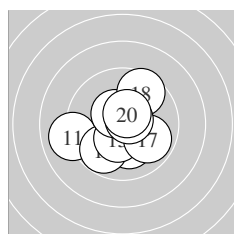

Serie 2:
 9.0 ← 10.1 ↓ 9.8 ↗ 10.7 * 10.4 *
 10.5 * 9.9 ↘ 9.6 ↗ 10.7 * 10.5 *
 beste Teiler 72.4 (14.) 73.4 (19.) 106.2 (20.)
 Trefferlage 0.13 mm links, 0.32 mm tief
 Streuwert 1.81, horizontal: 1.97, vertikal: 1.63

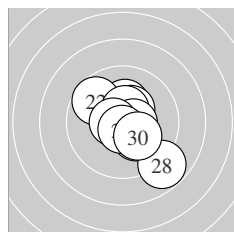

Serie 3:
 10.2 * 9.7 ↖ 10.4 * 10.5 * 10.2 *
 10.6 * 10.6 * 8.8 ↘ 10.7 * 10.2 *
 beste Teiler 68.2 (29.) 87.0 (27.) 100.3 (26.)
 Trefferlage 0.51 mm rechts, 0.13 mm tief
 Streuwert 1.70, horizontal: 1.60, vertikal: 1.80

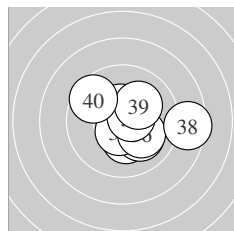

Serie 4:
 10.3 * 10.4 * 10.5 * 10.1 ↘ 10.5 *
 10.1 ↘ 10.6 * 8.5 → 10.1 ↗ 9.6 ↖
 beste Teiler 86.9 (37.) 102.1 (35.) 122.6 (33.)
 Trefferlage 0.98 mm rechts, 0.14 mm tief
 Streuwert 1.84, horizontal: 2.23, vertikal: 1.34

Unterschrift des Schützen

Meyton Elektronik

Ergebnis: **391** (414.4)
 Serien: 97 99 99 96
 Zähler: 31 9 0 0 0 0 0 0 0 0
 Innenzehner: 30
 weiteste: 449 (9), 344 (31), 336 (35)
 beste Teiler 10.0 (2.) 12.3 (19.) 24.0 (23.)
 Trefferlage 0.05 mm rechts, 0.07 mm hoch
 Streuwert 1.29, horizontal: 1.37, vertikal: 1.20

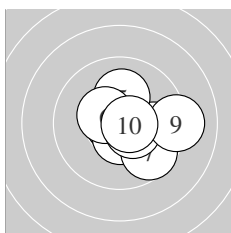
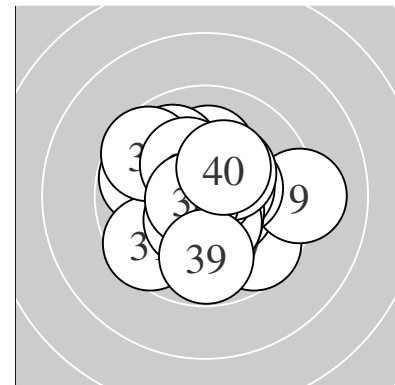

Serie 1:
 9.9 → 10.9 * 10.8 * 10.5 * 10.1 ↑
 10.4 * 9.7 ↘ 10.5 * 9.2 → 10.6 *
 beste Teiler 10.0 (2.) 49.0 (3.) 78.4 (10.)
 Trefferlage 0.99 mm rechts, 0.18 mm tief
 Streuwert 1.44, horizontal: 1.70, vertikal: 1.11

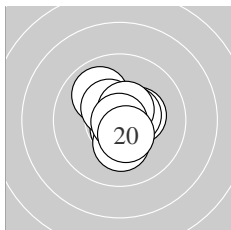

Serie 2:
 10.6 * 9.9 ↖ 10.4 * 10.7 * 10.2 *
 10.4 * 10.5 * 10.6 * 10.9 * 10.5 *
 beste Teiler 12.3 (19.) 69.5 (14.) 93.1 (11.)
 Trefferlage 0.06 mm rechts, 0.16 mm hoch
 Streuwert 1.01, horizontal: 0.88, vertikal: 1.12

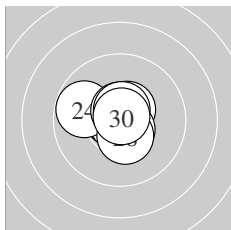

Serie 3:
 10.6 * 10.7 * 10.9 * 9.8 ↖ 10.6 *
 10.5 * 10.6 * 10.4 * 10.6 * 10.8 *
 beste Teiler 24.0 (23.) 33.5 (30.) 60.0 (22.)
 Trefferlage 0.11 mm links, 0.09 mm hoch
 Streuwert 0.89, horizontal: 1.01, vertikal: 0.76

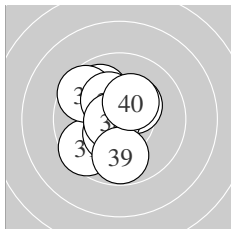

Serie 4:
 9.6 ↙ 10.4 * 10.7 * 9.9 ↖ 9.6 ↖
 10.3 * 10.3 * 10.7 * 9.8 ↓ 10.3 *
 beste Teiler 63.3 (38.) 72.8 (33.) 132.7 (32.)
 Trefferlage 0.74 mm links, 0.20 mm hoch
 Streuwert 1.54, horizontal: 1.28, vertikal: 1.77

Unterschrift des Schützen

Ergebnis: **385** (405.3)
 Serien: 96 97 97 95
 Zähler: 25 15 0 0 0 0 0 0 0 0
 Innenzehner: 18
 weiteste: 378 (33), 375 (5), 321 (23)
 beste Teiler 39.6 (27.) 59.4 (36.) 65.0 (2.)
 Trefferlage 0.26 mm rechts, 0.10 mm tief
 Streuwert 1.61, horizontal: 1.78, vertikal: 1.41

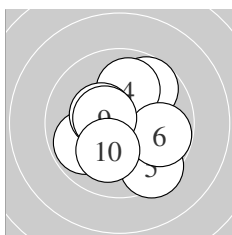
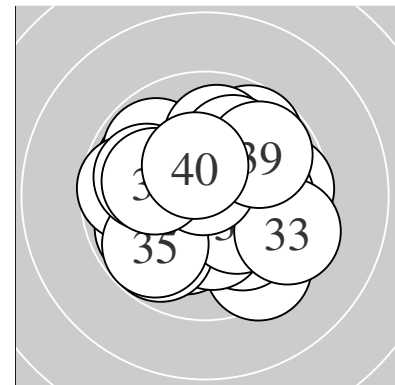

Serie 1:
 10.7 * 10.7 * 9.7 ↗ 10.0 ↑ 9.5 ↘
 9.8 → 9.8 ↙ 10.4 * 10.5 * 10.1 ↓
 beste Teiler 65.0 (2.) 66.7 (1.) 111.3 (9.)
 Trefferlage 0.17 mm rechts, 0.03 mm tief
 Streuwert 1.73, horizontal: 1.71, vertikal: 1.75

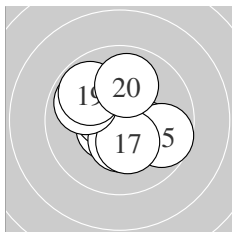

Serie 2:
 10.6 * 10.2 * 10.6 * 10.7 * 9.7 →
 10.4 * 10.3 * 9.9 ↖ 9.8 ↖ 10.0 ↑
 beste Teiler 69.8 (14.) 97.8 (13.) 99.8 (11.)
 Trefferlage 0.02 mm rechts, 0.00 mm
 Streuwert 1.53, horizontal: 1.64, vertikal: 1.41

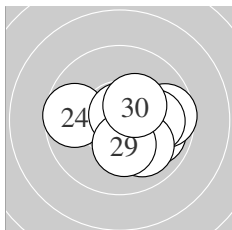

Serie 3:
 9.9 → 10.6 * 9.7 → 9.7 ← 10.3 *
 10.0 → 10.8 * 10.0 ↘ 10.3 * 10.4 *
 beste Teiler 39.6 (27.) 89.1 (22.) 148.5 (30.)
 Trefferlage 0.94 mm rechts, 0.42 mm tief
 Streuwert 1.42, horizontal: 1.76, vertikal: 0.97

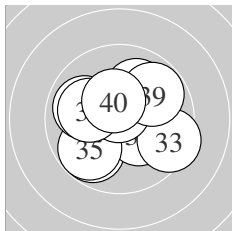

Serie 4:
 9.8 ↙ 10.3 * 9.4 ↘ 10.0 ↗ 9.8 ↙
 10.7 * 9.9 ↖ 10.1 ← 9.8 ↗ 10.4 *
 beste Teiler 59.4 (36.) 134.7 (40.) 170.4 (32.)
 Trefferlage 0.07 mm links, 0.02 mm hoch
 Streuwert 1.85, horizontal: 2.09, vertikal: 1.58

Unterschrift des Schützen

Meyton Elektronik

Ergebnis: **394** (412.0)
 Serien: 98 99 99 98
 Zähler: 34 6 0 0 0 0 0 0 0 0
 Innenzehner: 29
 weiteste: 328 (8), 304 (32), 288 (31)
 beste Teiler 32.7 (34.) 35.2 (23.) 64.1 (28.)
 Trefferlage 0.13 mm links, 0.03 mm hoch
 Streuwert 1.27, horizontal: 1.38, vertikal: 1.15

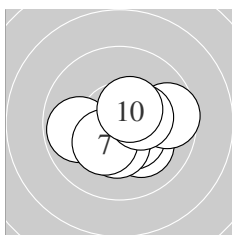
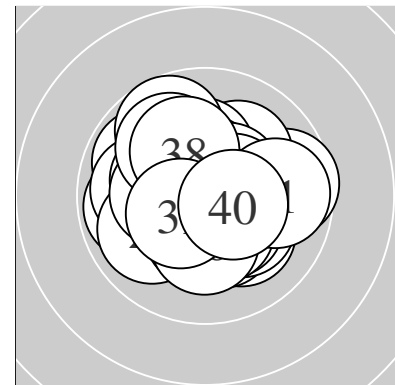

Serie 1:
 10.1 ↘ 10.4 * 10.6 * 9.8 ← 10.6 *
 10.3 * 10.3 * 9.6 → 10.4 * 10.5 *
 beste Teiler 85.0 (5.) 85.7 (3.) 117.2 (10.)
 Trefferlage 0.34 mm rechts, 0.53 mm tief
 Streuwert 1.30, horizontal: 1.62, vertikal: 0.87

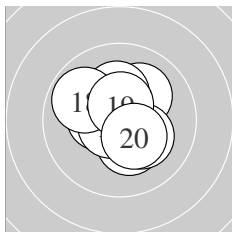

Serie 2:
 10.4 * 10.1 ↗ 10.3 * 10.6 * 10.2 *
 10.7 * 10.2 * 9.9 ↖ 10.5 * 10.4 *
 beste Teiler 71.1 (16.) 97.3 (14.) 105.2 (19.)
 Trefferlage 0.07 mm links, 0.25 mm hoch
 Streuwert 1.24, horizontal: 1.24, vertikal: 1.23

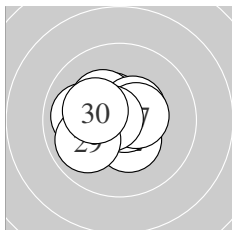

Serie 3:
 10.0 ← 10.4 * 10.8 * 10.5 * 10.3 *
 10.5 * 10.5 * 10.7 * 9.9 ↙ 10.2 *
 beste Teiler 35.2 (23.) 64.1 (28.) 113.6 (24.)
 Trefferlage 0.56 mm links, 0.16 mm hoch
 Streuwert 1.10, horizontal: 1.29, vertikal: 0.88

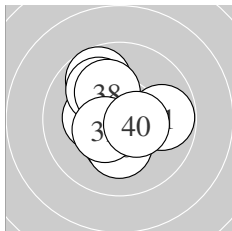

Serie 4:
 9.8 → 9.7 ↖ 10.3 * 10.8 * 10.4 *
 10.2 * 10.0 ↖ 10.1 ↖ 10.5 * 10.5 *
 beste Teiler 32.7 (34.) 120.5 (40.) 123.2 (39.)
 Trefferlage 0.23 mm links, 0.22 mm hoch
 Streuwert 1.45, horizontal: 1.41, vertikal: 1.49

Unterschrift des Schützen

Meyton Elektronik

Ergebnis: **377** (396.1)
 Serien: 95 92 98 92
 Zähler: 20 17 3 0 0 0 0 0 0 0
 Innenzehner: 15
 weiteste: 579 (4), 552 (37), 506 (17)
 beste Teiler 75.8 (30.) 77.1 (1.) 81.3 (33.)
 Trefferlage 0.08 mm rechts, 0.17 mm tief
 Streuwert 2.07, horizontal: 2.44, vertikal: 1.63

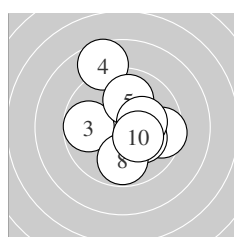
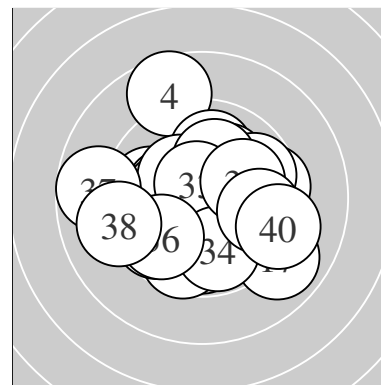

Serie 1:
 10.6 * 10.5 * 9.8 ← 8.6 ↑ 10.0 ↑
 9.6 → 10.2 * 9.8 ↓ 10.2 * 10.3 *
 beste Teiler 77.1 (1.) 116.2 (2.) 159.6 (10.)
 Trefferlage 0.50 mm rechts, 0.34 mm hoch
 Streuwert 2.06, horizontal: 1.83, vertikal: 2.27

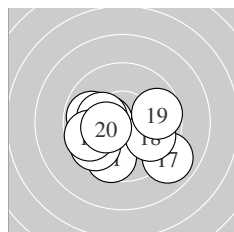

Serie 2:
 9.7 ↓ 9.8 ← 10.4 * 10.2 * 9.7 ↙
 9.7 ← 8.9 ↘ 9.9 ↘ 9.7 → 10.3 *
 beste Teiler 137.1 (13.) 153.3 (20.) 186.1 (14.)
 Trefferlage 0.42 mm links, 0.94 mm tief
 Streuwert 2.08, horizontal: 2.57, vertikal: 1.44

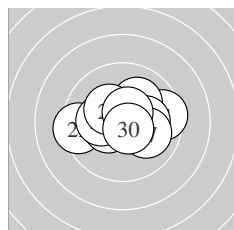

Serie 3:
 9.5 → 9.4 ← 10.1 ↗ 10.2 * 10.4 *
 10.2 * 10.0 ↘ 10.3 * 10.6 * 10.7 *
 beste Teiler 75.8 (30.) 96.6 (29.) 133.8 (25.)
 Trefferlage 0.15 mm rechts, 0.19 mm hoch
 Streuwert 1.68, horizontal: 2.22, vertikal: 0.86

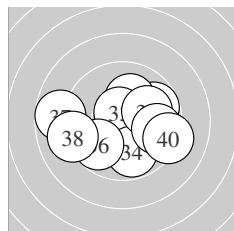

Serie 4:
 9.8 → 10.1 ↑ 10.6 * 9.8 ↓ 10.0 →
 9.8 ↙ 8.7 ← 9.1 ← 9.7 → 9.2 ↘
 beste Teiler 81.3 (33.) 204.9 (32.) 233.2 (35.)
 Trefferlage 0.11 mm rechts, 0.31 mm tief
 Streuwert 2.53, horizontal: 3.22, vertikal: 1.57

Unterschrift des Schützen

Ergebnis: **388** (405.7)
 Serien: 99 97 96 96
 Zähler: 28 12 0 0 0 0 0 0 0 0
 Innenzehner: 22
 weiteste: 375 (30), 370 (27), 340 (24)
 beste Teiler 55.6 (31.) 62.0 (8.) 76.6 (29.)
 Trefferlage 0.04 mm links, 0.05 mm hoch
 Streuwert 1.59, horizontal: 1.81, vertikal: 1.33

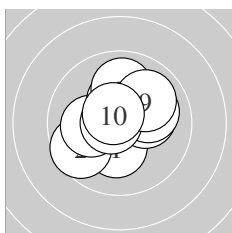
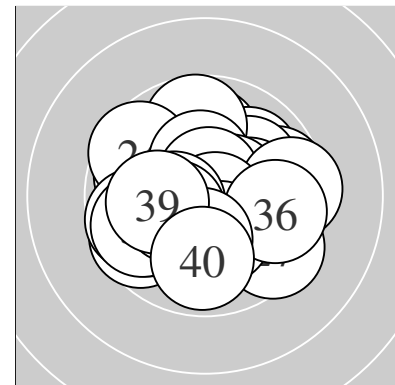

Serie 1:
 10.3 * 9.6 ↙ 10.1 ← 10.3 * 10.2 *
 10.1 → 10.0 ↑ 10.7 * 10.0 ↗ 10.6 *
 beste Teiler 62.0 (8.) 82.9 (10.) 159.8 (4.)
 Trefferlage 0.03 mm links, 0.39 mm hoch
 Streuwert 1.52, horizontal: 1.64, vertikal: 1.38

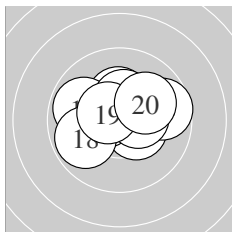

Serie 2:
 10.4 * 10.5 * 10.3 * 9.7 → 9.9 ↖
 10.4 * 10.4 * 9.8 ↙ 10.5 * 10.1 ↗
 beste Teiler 101.0 (19.) 113.1 (12.) 136.4 (16.)
 Trefferlage 0.06 mm rechts, 0.50 mm hoch
 Streuwert 1.46, horizontal: 1.86, vertikal: 0.91

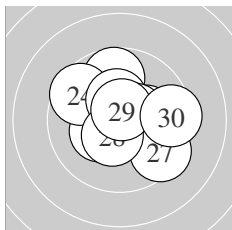

Serie 3:
 10.2 * 9.7 ↑ 10.3 * 9.6 ↘ 10.4 *
 10.5 * 9.5 ↘ 10.5 * 10.6 * 9.5 →
 beste Teiler 76.6 (29.) 115.6 (26.) 122.1 (28.)
 Trefferlage 0.44 mm rechts, 0.40 mm hoch
 Streuwert 1.78, horizontal: 2.00, vertikal: 1.53

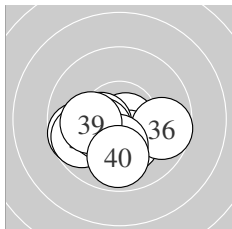

Serie 4:
 10.7 * 9.7 ← 9.7 ← 10.3 * 10.4 *
 9.7 → 10.3 * 10.2 * 10.1 ← 9.9 ↓
 beste Teiler 55.6 (31.) 139.4 (35.) 151.6 (37.)
 Trefferlage 0.66 mm links, 1.08 mm tief
 Streuwert 1.41, horizontal: 1.83, vertikal: 0.80

Unterschrift des Schützen

Meyton Elektronik

Ergebnis: **373** (392.5)
 Serien: 92 94 94 93
 Zähler: 13 27 0 0 0 0 0 0 0 0
 Innenzehner: 11
 weiteste: 500 (32), 448 (38), 445 (37)
 beste Teiler 42.7 (21.) 72.6 (40.) 80.1 (29.)
 Trefferlage 1.22 mm links, 0.38 mm hoch
 Streuwert 2.02, horizontal: 2.24, vertikal: 1.77

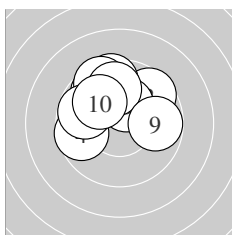
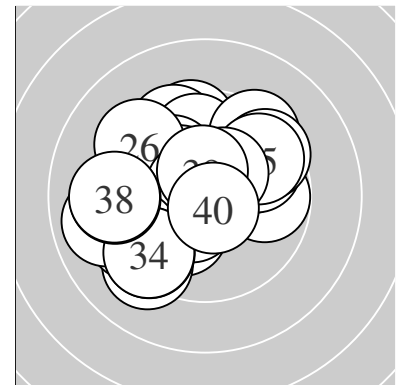

Serie 1:
 9.7 ↘ 9.6 ↗ 9.5 ↑ 9.7 ← 9.5 ↖
 10.3 * 9.8 ← 9.8 ↑ 9.8 → 10.0 ↘
 beste Teiler 162.9 (6.) 239.8 (10.) 284.4 (8.)
 Trefferlage 0.61 mm links, 1.77 mm hoch
 Streuwert 1.76, horizontal: 2.06, vertikal: 1.41

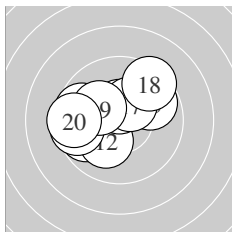

Serie 2:
 9.8 ← 10.1 ↙ 9.8 ↗ 10.5 * 9.5 ←
 9.7 ← 10.3 * 9.4 ↗ 10.2 * 9.5 ←
 beste Teiler 111.0 (14.) 156.7 (17.) 195.5 (19.)
 Trefferlage 1.01 mm links, 0.51 mm hoch
 Streuwert 1.95, horizontal: 2.37, vertikal: 1.41

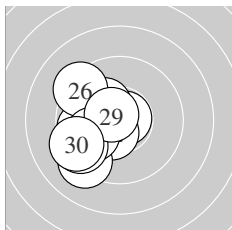

Serie 3:
 10.8 * 10.5 * 9.8 ← 10.2 * 9.2 ↙
 9.3 ↘ 9.9 ← 9.4 ← 10.6 * 9.3 ←
 beste Teiler 42.7 (21.) 80.1 (29.) 123.1 (22.)
 Trefferlage 2.02 mm links, 0.59 mm tief
 Streuwert 1.57, horizontal: 1.37, vertikal: 1.74

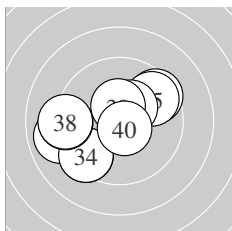

Serie 4:
 9.4 ↙ 9.0 ← 9.5 ↗ 9.4 ↙ 9.7 ↗
 10.4 * 9.2 ← 9.2 ← 10.5 * 10.7 *
 beste Teiler 72.6 (40.) 124.6 (39.) 144.6 (36.)
 Trefferlage 1.25 mm links, 0.13 mm tief
 Streuwert 2.45, horizontal: 2.98, vertikal: 1.76

Unterschrift des Schützen

Meyton Elektronik

Ergebnis: **389** (405.8)
 Serien: 95 97 100 97
 Zähler: 29 11 0 0 0 0 0 0 0 0
 Innenzehner: 21
 weiteste: 406 (7), 381 (32), 366 (38)
 beste Teiler 45.5 (36.) 54.2 (11.) 65.7 (35.)
 Trefferlage 0.42 mm rechts, 0.17 mm tief
 Streuwert 1.58, horizontal: 1.77, vertikal: 1.37

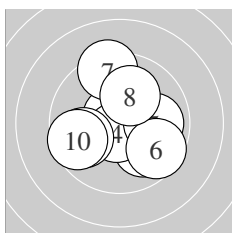
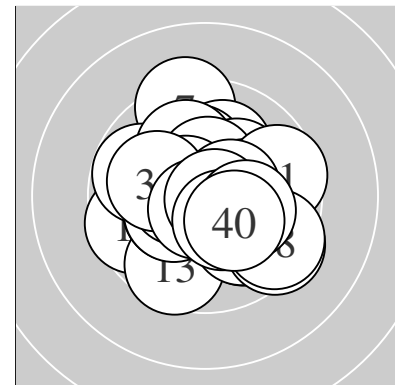

Serie 1:
 10.7 * 10.0 ↘ 10.1 → 10.7 * 9.9 →
 9.6 ↘ 9.3 ↑ 10.1 ↑ 9.8 ← 9.6 ←
 beste Teiler 70.0 (1.) 71.4 (4.) 214.8 (3.)
 Trefferlage 0.24 mm rechts, 0.07 mm tief
 Streuwert 1.97, horizontal: 2.09, vertikal: 1.84

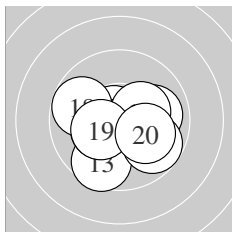

Serie 2:
 10.7 * 10.5 * 9.6 ↙ 10.0 → 10.3 *
 9.8 ↘ 10.3 * 9.8 ← 10.3 * 10.1 ↘
 beste Teiler 54.2 (11.) 122.6 (12.) 156.9 (19.)
 Trefferlage 0.00 mm , 0.54 mm tief
 Streuwert 1.61, horizontal: 1.92, vertikal: 1.22

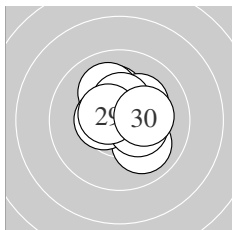

Serie 3:
 10.5 * 10.2 * 10.0 ↘ 10.1 ↖ 10.2 *
 10.4 * 10.5 * 10.4 * 10.6 * 10.2 *
 beste Teiler 97.0 (29.) 104.6 (21.) 116.0 (27.)
 Trefferlage 0.21 mm rechts, 0.52 mm hoch
 Streuwert 1.18, horizontal: 1.22, vertikal: 1.14

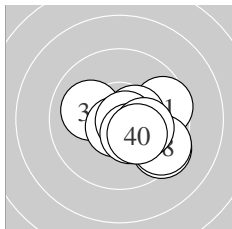

Serie 4:
 9.6 → 9.4 ↘ 10.5 * 10.1 ← 10.7 *
 10.8 * 10.4 * 9.5 ↘ 10.2 * 10.3 *
 beste Teiler 45.5 (36.) 65.7 (35.) 117.3 (33.)
 Trefferlage 1.24 mm rechts, 0.58 mm tief
 Streuwert 1.41, horizontal: 1.70, vertikal: 1.04

Unterschrift des Schützen

Meyton Elektronik

Ergebnis: **391** (408.5)
 Serien: 99 94 99 99
 Zähler: 31 9 0 0 0 0 0 0 0 0
 Innenzehner: 24
 weiteste: 379 (32), 372 (15), 359 (21)
 beste Teiler 49.0 (40.) 54.4 (29.) 66.7 (7.)
 Trefferlage 0.35 mm rechts, 0.24 mm hoch
 Streuwert 1.43, horizontal: 1.64, vertikal: 1.17

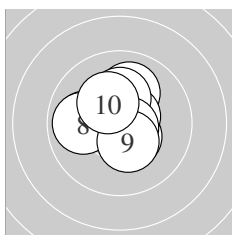
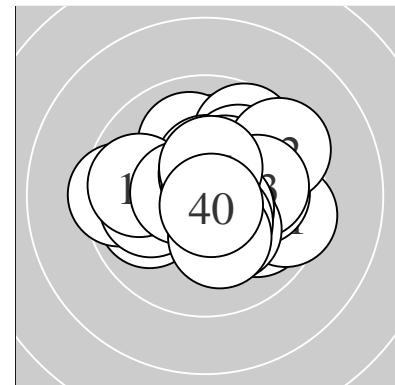

Serie 1:
 10.4 * 10.0 ↗ 10.0 ← 10.7 * 10.6 *
 10.2 * 10.7 * 9.9 ← 10.4 * 10.3 *
 beste Teiler 66.7 (7.) 70.4 (4.) 87.0 (5.)
 Trefferlage 0.29 mm links, 0.39 mm hoch
 Streuwert 1.23, horizontal: 1.31, vertikal: 1.15

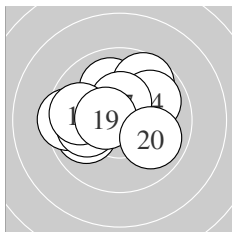

Serie 2:
 10.0 ↗ 9.7 ↗ 9.9 ← 9.9 ↗ 9.5 ←
 10.0 ← 10.4 * 9.8 ← 10.5 * 9.9 ↘
 beste Teiler 101.9 (19.) 127.1 (17.) 236.9 (11.)
 Trefferlage 0.67 mm links, 0.56 mm hoch
 Streuwert 1.80, horizontal: 2.19, vertikal: 1.30

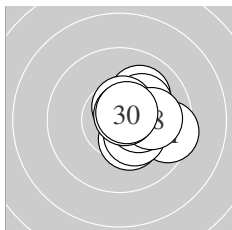

Serie 3:
 9.5 → 10.1 ↗ 10.3 * 10.2 * 10.6 *
 10.3 * 10.4 * 10.0 → 10.7 * 10.7 *
 beste Teiler 54.4 (29.) 74.9 (30.) 97.7 (25.)
 Trefferlage 1.31 mm rechts, 0.14 mm hoch
 Streuwert 1.00, horizontal: 1.00, vertikal: 1.01

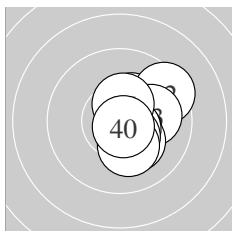

Serie 4:
 10.3 * 9.4 ↗ 10.0 → 10.5 * 10.2 *
 10.6 * 10.5 * 10.4 * 10.2 * 10.8 *
 beste Teiler 49.0 (40.) 94.8 (36.) 106.4 (34.)
 Trefferlage 1.08 mm rechts, 0.11 mm tief
 Streuwert 1.12, horizontal: 0.94, vertikal: 1.28

Unterschrift des Schützen

Meyton Elektronik

Ergebnis: **395** (413.3)
 Serien: 100 100 98 97
 Zähler: 35 5 0 0 0 0 0 0 0 0
 Innenzehner: 27
 weiteste: 395 (30), 326 (36), 273 (31)
 beste Teiler 13.0 (9.) 31.0 (16.) 46.4 (38.)
 Trefferlage 0.57 mm rechts, 0.52 mm hoch
 Streuwert 1.14, horizontal: 1.23, vertikal: 1.04

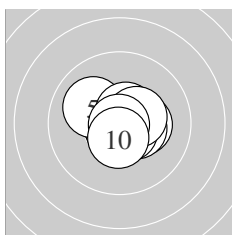
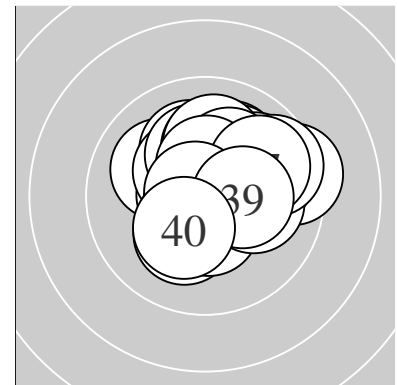

Serie 1:
 10.7 * 10.3 * 10.4 * 10.7 * 10.1 ↘
 10.6 * 10.6 * 10.4 * 10.9 * 10.5 *
 beste Teiler 13.0 (9.) 51.6 (1.) 52.6 (4.)
 Trefferlage 0.22 mm rechts, 0.02 mm tief
 Streuwert 0.88, horizontal: 1.04, vertikal: 0.67

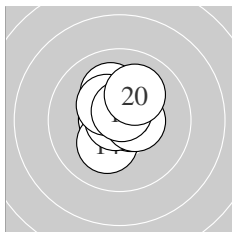

Serie 2:
 10.1 ↗ 10.6 * 10.7 * 10.2 * 10.6 *
 10.8 * 10.4 * 10.5 * 10.7 * 10.1 ↗
 beste Teiler 31.0 (16.) 62.2 (13.) 68.8 (19.)
 Trefferlage 0.06 mm links, 0.44 mm hoch
 Streuwert 0.95, horizontal: 0.83, vertikal: 1.07

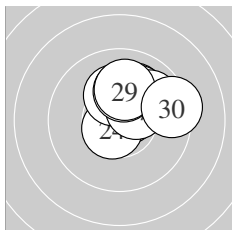

Serie 3:
 10.7 * 10.1 ↗ 10.1 ↗ 10.6 * 9.9 ↗
 10.2 * 10.4 * 10.1 ↑ 10.0 ↑ 9.4 →
 beste Teiler 73.6 (21.) 81.4 (24.) 146.7 (27.)
 Trefferlage 0.98 mm rechts, 1.30 mm hoch
 Streuwert 1.11, horizontal: 1.29, vertikal: 0.89

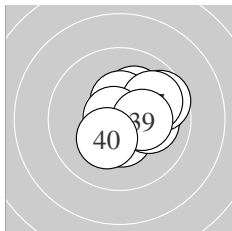

Serie 4:
 9.9 → 10.2 * 10.4 * 10.4 * 10.1 →
 9.6 → 9.9 → 10.8 * 10.3 * 10.3 *
 beste Teiler 46.4 (38.) 128.9 (34.) 130.1 (33.)
 Trefferlage 1.16 mm rechts, 0.35 mm hoch
 Streuwert 1.25, horizontal: 1.38, vertikal: 1.11

Unterschrift des Schützen

Meyton Elektronik

Ergebnis: **379** (399.0)
 Serien: 94 95 93 97
 Zähler: 22 15 3 0 0 0 0 0 0 0
 Innenzehner: 21
 weiteste: 586 (7), 555 (10), 543 (15)
 beste Teiler 30.0 (4.) 67.2 (5.) 80.9 (36.)
 Trefferlage 0.15 mm links, 0.02 mm hoch
 Streuwert 2.02, horizontal: 2.44, vertikal: 1.49

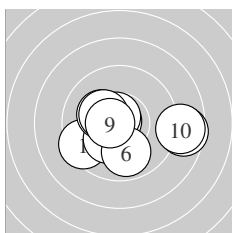
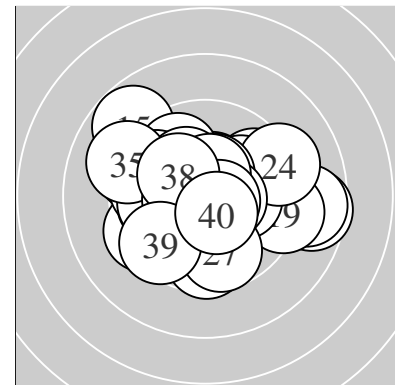

Serie 1:
 9.4 ↙ 10.2 * 10.2 * 10.8 * 10.7 *
 9.9 ↓ 8.6 → 10.3 * 10.6 * 8.7 →
 beste Teiler 30.0 (4.) 67.2 (5.) 87.0 (9.)
 Trefferlage 0.30 mm rechts, 0.48 mm tief
 Streuwert 2.29, horizontal: 3.01, vertikal: 1.18

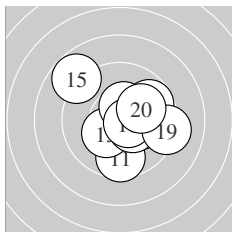

Serie 2:
 9.6 ↓ 10.2 * 10.3 * 10.4 * 8.8 ↖
 9.7 ↗ 10.4 * 10.6 * 9.2 → 10.1 →
 beste Teiler 81.9 (18.) 130.3 (17.) 139.4 (14.)
 Trefferlage 0.80 mm rechts, 0.07 mm hoch
 Streuwert 2.09, horizontal: 2.24, vertikal: 1.92

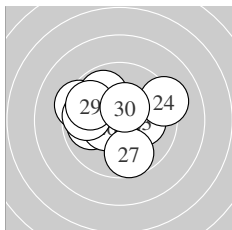

Serie 3:
 9.4 ↖ 9.9 ↖ 10.2 * 9.2 → 9.9 ←
 10.4 * 9.7 ↓ 9.8 ← 9.8 ↖ 10.5 *
 beste Teiler 125.1 (30.) 131.5 (26.) 198.4 (23.)
 Trefferlage 0.72 mm links, 0.41 mm hoch
 Streuwert 2.06, horizontal: 2.49, vertikal: 1.53

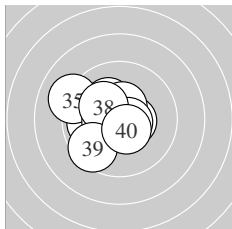

Serie 4:
 10.5 * 10.2 * 10.5 * 9.9 ← 9.1 ↖
 10.6 * 10.5 * 10.2 * 9.5 ↙ 10.5 *
 beste Teiler 80.9 (36.) 111.7 (40.) 114.2 (31.)
 Trefferlage 1.01 mm links, 0.11 mm hoch
 Streuwert 1.55, horizontal: 1.73, vertikal: 1.33

Unterschrift des Schützen

Meyton Elektronik

Ergebnis: **389** (404.7)
 Serien: 97 97 96 99
 Zähler: 30 9 1 0 0 0 0 0 0 0
 Innenzehner: 19
 weiteste: 588 (6), 439 (28), 416 (25)
 beste Teiler 7.6 (31.) 37.5 (22.) 49.3 (10.)
 Trefferlage 0.12 mm links, 0.12 mm hoch
 Streuwert 1.70, horizontal: 1.85, vertikal: 1.55

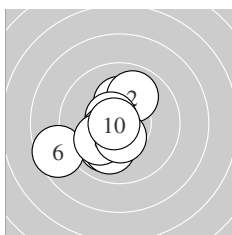
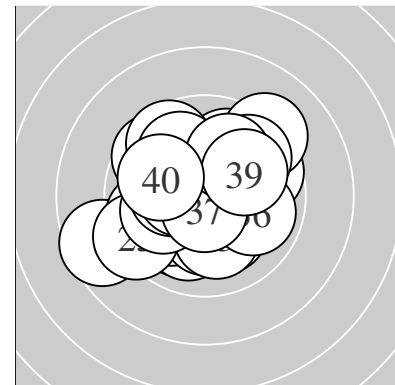

Serie 1:
 10.2 * 9.9 ↗ 10.0 ↘ 10.6 * 10.4 *
 8.6 ↙ 10.0 ↘ 10.1 ↙ 10.5 * 10.8 *
 beste Teiler 49.3 (10.) 87.9 (4.) 120.2 (9.)
 Trefferlage 1.04 mm links, 0.54 mm tief
 Streuwert 1.68, horizontal: 1.72, vertikal: 1.65

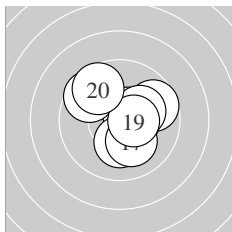

Serie 2:
 9.7 ↗ 10.6 * 10.2 * 10.5 * 10.2 *
 9.6 ↘ 10.1 ↘ 10.2 * 10.5 * 9.6 ↘
 beste Teiler 97.3 (12.) 122.2 (19.) 125.3 (14.)
 Trefferlage 0.52 mm rechts, 0.19 mm hoch
 Streuwert 1.63, horizontal: 1.65, vertikal: 1.61

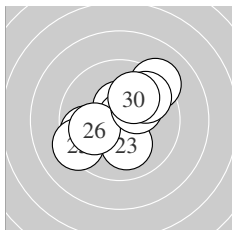

Serie 3:
 10.5 * 10.8 * 10.1 ↘ 9.7 ↙ 9.3 ↙
 10.0 ↙ 10.2 * 9.2 ↗ 9.8 ↗ 10.0 ↗
 beste Teiler 37.5 (22.) 115.2 (21.) 183.4 (27.)
 Trefferlage 0.02 mm rechts, 0.34 mm hoch
 Streuwert 2.03, horizontal: 2.24, vertikal: 1.80

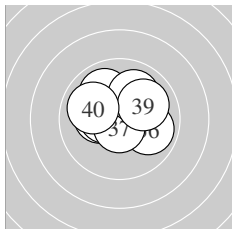

Serie 4:
 10.9 * 10.0 ↘ 10.3 * 10.6 * 10.4 *
 9.9 ↗ 10.7 * 10.0 ↗ 10.0 ↗ 10.0 ↘
 beste Teiler 7.6 (31.) 68.0 (37.) 86.7 (34.)
 Trefferlage 0.00 mm , 0.50 mm hoch
 Streuwert 1.38, horizontal: 1.64, vertikal: 1.05

Unterschrift des Schützen

Meyton Elektronik

Ergebnis:	385	(404.0)
Serien:	94 98 96 97	
Zähler:	27 11 2 0 0 0 0 0 0 0	
Innenzehner:	23	
weiteste:	596 (7), 543 (37), 439 (17)	
beste Teiler	31.7 (12.) 36.1 (18.) 55.0 (20.)	
Trefferlage	0.19 mm rechts, 0.28 mm hoch	
Streuwert	1.77, horizontal: 1.95, vertikal: 1.58	

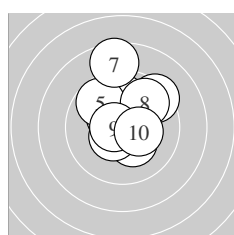
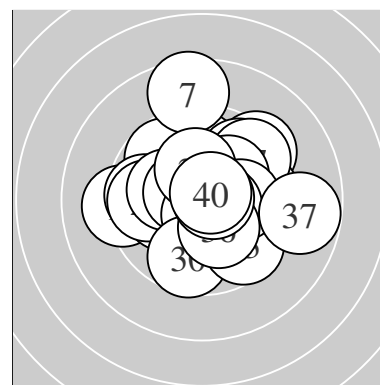

Serie 1:	9.9 ↑	9.4 ↗	10.3 *	10.4 *	9.7 ↖
	10.5 *	8.6 ↑	9.7 ↗	10.6 *	10.3 *
beste Teiler	78.0 (9.)	120.9 (6.)	141.2 (4.)		
Trefferlage	0.18 mm rechts, 1.39 mm hoch				
Streuwert	1.92, horizontal: 1.60, vertikal: 2.19				

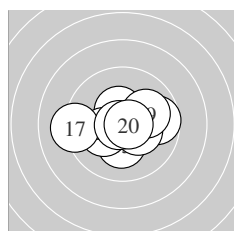

Serie 2:	10.4 *	10.8 *	10.2 *	9.7 →	10.3 *
	10.2 *	9.2 ←	10.8 *	10.0 →	10.7 *
beste Teiler	31.7 (12.)	36.1 (18.)	55.0 (20.)		
Trefferlage	0.03 mm rechts, 0.13 mm tief				
Streuwert	1.59, horizontal: 2.08, vertikal: 0.86				

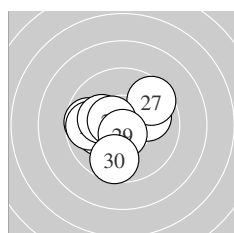

Serie 3:	10.0 →	9.7 ←	10.1 ←	10.3 *	9.8 ←
	10.2 *	9.6 ↗	10.5 *	10.6 *	9.7 ↓
beste Teiler	81.0 (29.)	108.4 (28.)	172.0 (24.)		
Trefferlage	0.87 mm links, 0.03 mm tief				
Streuwert	1.71, horizontal: 1.99, vertikal: 1.37				

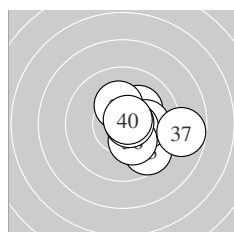

Serie 4:	10.7 *	10.2 *	9.6 ↘	10.1 →	10.5 *
	10.2 *	8.8 →	10.7 *	10.3 *	10.7 *
beste Teiler	61.0 (40.)	62.6 (38.)	75.2 (31.)		
Trefferlage	1.44 mm rechts, 0.09 mm tief				
Streuwert	1.43, horizontal: 1.60, vertikal: 1.24				

Unterschrift des Schützen

Meyton Elektronik

Ergebnis: **396** (414.5)
 Serien: 100 98 99 99
 Zähler: 36 4 0 0 0 0 0 0 0 0
 Innenzehner: 31
 weiteste: 282 (22), 280 (13), 278 (38)
 beste Teiler 15.5 (7.) 20.5 (34.) 37.0 (39.)
 Trefferlage 0.01 mm links, 0.12 mm tief
 Streuwert 1.17, horizontal: 0.91, vertikal: 1.38

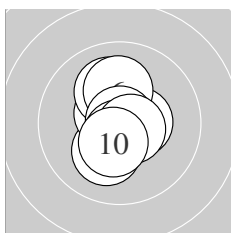
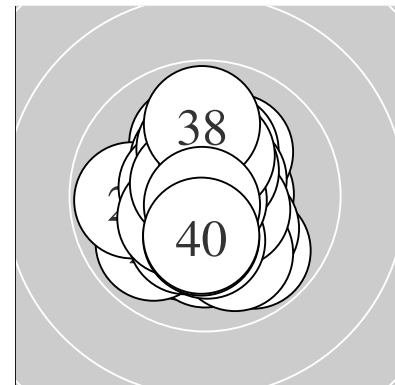

Serie 1:
 10.2 * 10.7 * 10.5 * 10.6 * 10.1 ↗
 10.1 ↑ 10.9 * 10.7 * 10.6 * 10.4 *
 beste Teiler 15.5 (7.) 65.2 (2.) 74.3 (8.)
 Trefferlage 0.02 mm links, 0.10 mm hoch
 Streuwert 1.01, horizontal: 0.68, vertikal: 1.26

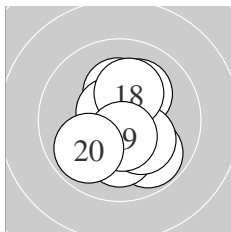

Serie 2:
 10.1 ↗ 10.2 * 9.8 ↘ 10.1 ↓ 10.8 *
 10.7 * 10.2 * 10.2 * 10.5 * 9.9 ↙
 beste Teiler 40.7 (15.) 75.8 (16.) 106.5 (19.)
 Trefferlage 0.28 mm rechts, 0.27 mm tief
 Streuwert 1.37, horizontal: 1.09, vertikal: 1.61

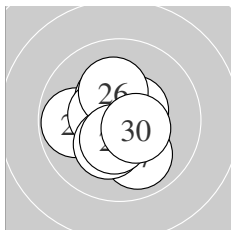

Serie 3:
 10.5 * 9.8 ← 10.4 * 10.5 * 10.4 *
 10.2 * 10.0 ↘ 10.3 * 10.4 * 10.5 *
 beste Teiler 110.6 (21.) 115.4 (24.) 117.6 (30.)
 Trefferlage 0.22 mm links, 0.27 mm tief
 Streuwert 1.27, horizontal: 1.24, vertikal: 1.31

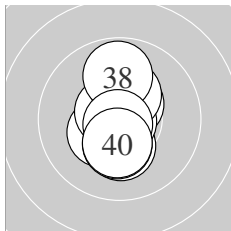

Serie 4:
 10.5 * 10.4 * 10.3 * 10.9 * 10.6 *
 10.3 * 10.3 * 9.8 ↑ 10.8 * 10.3 *
 beste Teiler 20.5 (34.) 37.0 (39.) 81.0 (35.)
 Trefferlage 0.10 mm links, 0.04 mm tief
 Streuwert 1.12, horizontal: 0.51, vertikal: 1.50

Unterschrift des Schützen

Meyton Elektronik

Ergebnis: **376** (393.1)
 Serien: 94 97 93 92
 Zähler: 18 20 2 0 0 0 0 0 0 0
 Innenzehner: 11
 weiteste: 571 (40), 547 (28), 496 (27)
 beste Teiler 43.1 (1.) 49.2 (24.) 142.9 (34.)
 Trefferlage 0.23 mm links, 0.39 mm hoch
 Streuwert 2.17, horizontal: 2.37, vertikal: 1.96

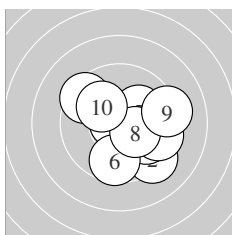
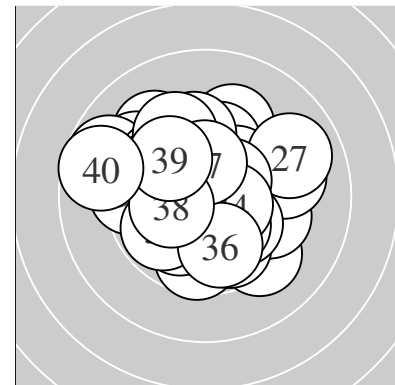

Serie 1:
 10.8 * 9.3 ↘ 9.4 ↖ 9.9 ↘ 10.1 ↗
 9.6 ↓ 9.5 → 10.3 * 9.2 → 10.1 ↖
 beste Teiler 43.1 (1.) 158.5 (8.) 201.9 (5.)
 Trefferlage 1.03 mm rechts, 0.36 mm tief
 Streuwert 2.12, horizontal: 2.33, vertikal: 1.88

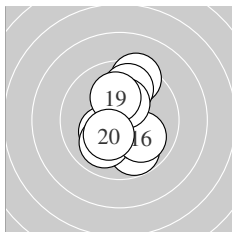

Serie 2:
 10.3 * 10.0 ↘ 9.8 ↘ 10.0 ↗ 9.4 ↗
 10.0 ↘ 9.8 ↗ 10.3 * 10.1 ↑ 10.3 *
 beste Teiler 154.1 (18.) 160.8 (20.) 171.0 (11.)
 Trefferlage 0.32 mm rechts, 0.03 mm tief
 Streuwert 1.83, horizontal: 1.24, vertikal: 2.28

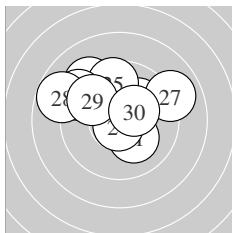

Serie 3:
 10.2 * 9.2 ↖ 10.1 ↗ 10.8 * 9.6 ↑
 9.3 ↖ 9.0 → 8.8 ↖ 9.8 ↖ 10.3 *
 beste Teiler 49.2 (24.) 152.0 (30.) 197.7 (21.)
 Trefferlage 0.58 mm links, 1.50 mm hoch
 Streuwert 2.31, horizontal: 2.88, vertikal: 1.54

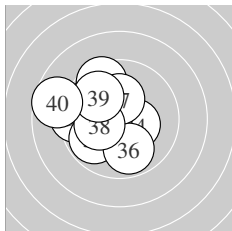

Serie 4:
 9.4 ← 9.8 ↖ 9.5 ↖ 10.4 * 9.8 ↗
 9.9 ↓ 10.2 * 10.2 * 9.9 ↖ 8.7 ←
 beste Teiler 142.9 (34.) 176.0 (37.) 184.6 (38.)
 Trefferlage 1.70 mm links, 0.49 mm hoch
 Streuwert 1.95, horizontal: 2.07, vertikal: 1.82

Unterschrift des Schützen

Meyton Elektronik

Ergebnis: **376** (395.3)
 Serien: 91 96 95 94
 Zähler: 18 20 2 0 0 0 0 0 0 0
 Innenzehner: 11
 weiteste: 526 (26), 512 (1), 473 (5)
 beste Teiler 5.3 (34.) 63.0 (32.) 104.2 (33.)
 Trefferlage 0.17 mm links, 0.00 mm
 Streuwert 2.09, horizontal: 2.38, vertikal: 1.76

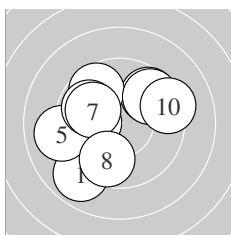
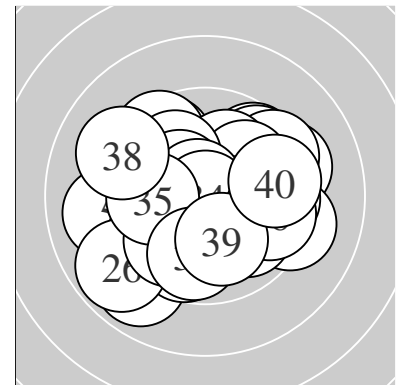

Serie 1:
 8.9 ↙ 10.1 ← 9.7 ↗ 9.7 ↘ 9.1 ←
 9.9 ↖ 10.0 ↖ 9.7 ↓ 9.6 ↗ 9.3 →
 beste Teiler 208.0 (2.) 239.7 (7.) 274.5 (6.)
 Trefferlage 0.86 mm links, 0.29 mm hoch
 Streuwert 2.54, horizontal: 2.79, vertikal: 2.26

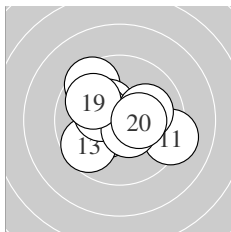

Serie 2:
 9.2 ↘ 10.4 * 9.7 ↙ 9.5 ↘ 10.4 *
 10.3 * 10.1 → 10.5 * 9.9 ↖ 10.3 *
 beste Teiler 107.4 (18.) 131.4 (12.) 139.7 (15.)
 Trefferlage 0.17 mm links, 0.17 mm hoch
 Streuwert 1.87, horizontal: 2.20, vertikal: 1.45

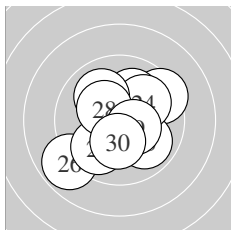

Serie 3:
 9.4 ↗ 10.1 ↗ 9.9 ↘ 10.0 ↗ 10.0 ↘
 8.8 ↙ 9.9 ↙ 10.3 * 10.4 * 10.3 *
 beste Teiler 126.5 (29.) 155.4 (28.) 171.6 (30.)
 Trefferlage 0.07 mm rechts, 0.13 mm tief
 Streuwert 2.10, horizontal: 2.20, vertikal: 2.00

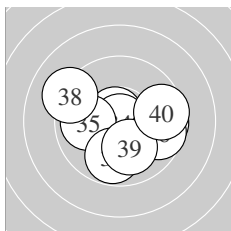

Serie 4:
 9.6 → 10.7 * 10.5 * 10.9 * 9.9 ←
 9.7 → 9.8 ↓ 9.1 ↖ 10.1 ↓ 9.6 →
 beste Teiler 5.3 (34.) 63.0 (32.) 104.2 (33.)
 Trefferlage 0.25 mm rechts, 0.36 mm tief
 Streuwert 2.02, horizontal: 2.49, vertikal: 1.40

Unterschrift des Schützen

Ergebnis:	393	(411.9)							
Serien:	99	97	97	100					
Zähler:	33	7	0	0	0	0	0	0	0
Innenzehner:	28								
weiteste:	357 (19), 317 (9), 309 (29)								
beste Teiler	14.1 (6.) 25.5 (37.) 34.4 (35.)								
Trefferlage	0.39 mm rechts, 0.44 mm hoch								
Streuwert	1.24, horizontal: 1.36, vertikal: 1.11								

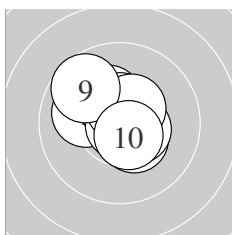
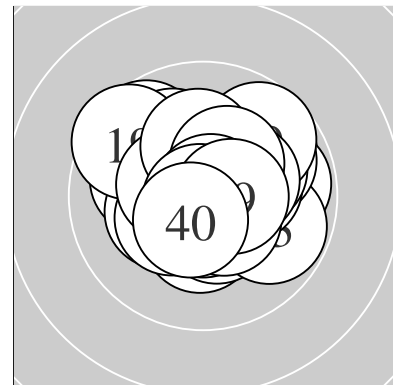

Serie 1:	10.0 ↖	10.4 *	10.5 *	10.6 *	10.3 *
	10.9 *	10.5 *	10.5 *	9.7 ↘	10.6 *
beste Teiler	14.1 (6.) 94.5 (4.) 97.2 (10.)				
Trefferlage	0.17 mm links, 0.51 mm hoch				
Streuwert	1.13, horizontal: 1.20, vertikal: 1.05				

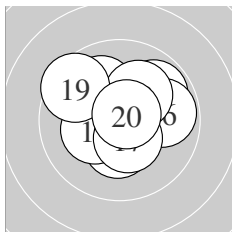

Serie 2:	10.3 *	10.0 ↖	10.3 *	10.2 *	9.8 ↗
	9.8 →	10.4 *	10.1 ↗	9.5 ↘	10.7 *
beste Teiler	58.8 (20.) 129.7 (17.) 154.4 (11.)				
Trefferlage	0.31 mm rechts, 0.56 mm hoch				
Streuwert	1.57, horizontal: 1.80, vertikal: 1.32				

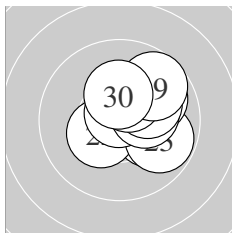

Serie 3:	10.1 ↘	10.4 *	9.8 ↘	9.9 ↗	10.8 *
	10.3 *	10.1 ↗	10.3 *	9.7 ↗	10.3 *
beste Teiler	46.3 (25.) 148.4 (22.) 157.4 (28.)				
Trefferlage	1.15 mm rechts, 0.57 mm hoch				
Streuwert	1.22, horizontal: 1.26, vertikal: 1.18				

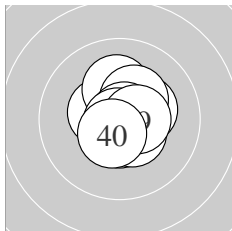

Serie 4:	10.5 *	10.3 *	10.2 *	10.3 *	10.8 *
	10.6 *	10.9 *	10.5 *	10.5 *	10.5 *
beste Teiler	25.5 (37.) 34.4 (35.) 94.0 (36.)				
Trefferlage	0.27 mm rechts, 0.14 mm hoch				
Streuwert	0.89, horizontal: 0.82, vertikal: 0.96				

Unterschrift des Schützen

Meyton Elektronik

Ergebnis: **394** (414.6)
 Serien: 98 100 100 96
 Zähler: 34 6 0 0 0 0 0 0 0 0
 Innenzehner: 29
 weiteste: 319 (37), 301 (38), 270 (9)
 beste Teiler 21.9 (40.) 36.0 (16.) 36.4 (18.)
 Trefferlage 0.03 mm rechts, 0.39 mm hoch
 Streuwert 1.17, horizontal: 1.29, vertikal: 1.04

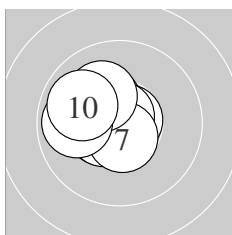
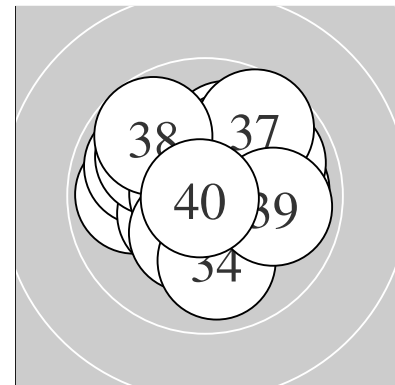

Serie 1:
 10.5 * 10.3 * 10.7 * 10.6 * 10.5 *
 10.8 * 10.6 * 10.1 ↘ 9.9 ← 9.9 ↘
 beste Teiler 43.1 (6.) 52.9 (3.) 88.0 (4.)
 Trefferlage 0.94 mm links, 0.30 mm hoch
 Streuwert 0.94, horizontal: 1.02, vertikal: 0.85

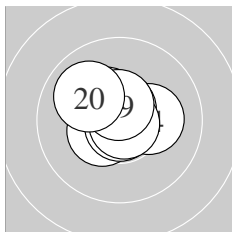

Serie 2:
 10.4 * 10.7 * 10.7 * 10.2 * 10.4 *
 10.8 * 10.7 * 10.8 * 10.6 * 10.0 ↘
 beste Teiler 36.0 (16.) 36.4 (18.) 63.4 (12.)
 Trefferlage 0.17 mm links, 0.32 mm hoch
 Streuwert 0.89, horizontal: 1.02, vertikal: 0.74

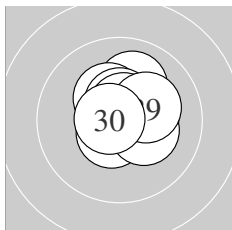

Serie 3:
 10.3 * 10.0 ↗ 10.6 * 10.3 * 10.5 *
 10.6 * 10.6 * 10.3 * 10.2 * 10.7 *
 beste Teiler 64.4 (30.) 80.3 (27.) 90.0 (23.)
 Trefferlage 0.39 mm rechts, 0.58 mm hoch
 Streuwert 0.91, horizontal: 0.93, vertikal: 0.90

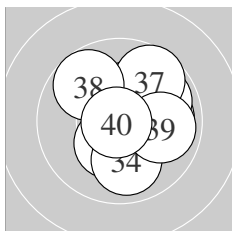

Serie 4:
 10.7 * 10.3 * 10.0 → 10.0 ↓ 9.9 ↗
 10.2 * 9.7 ↗ 9.7 ↘ 9.9 → 10.9 *
 beste Teiler 21.9 (40.) 68.0 (31.) 154.3 (32.)
 Trefferlage 0.85 mm rechts, 0.35 mm hoch
 Streuwert 1.56, horizontal: 1.51, vertikal: 1.61

Unterschrift des Schützen

Meyton Elektronik

Ergebnis: **395** (411.5)
 Serien: 100 100 98 97
 Zähler: 35 5 0 0 0 0 0 0 0 0
 Innenzehner: 27
 weiteste: 385 (25), 380 (27), 377 (34)
 beste Teiler 3.6 (15.) 33.0 (24.) 44.0 (39.)
 Trefferlage 0.14 mm rechts, 0.41 mm hoch
 Streuwert 1.30, horizontal: 1.48, vertikal: 1.09

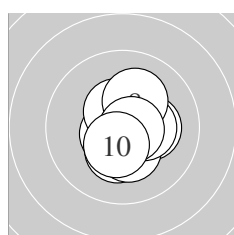
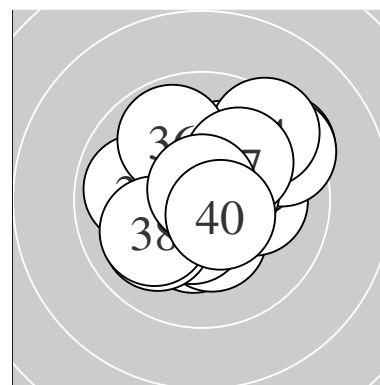

Serie 1:
 10.2 * 10.5 * 10.3 * 10.6 * 10.3 *
 10.4 * 10.5 * 10.2 * 10.7 * 10.4 *
 beste Teiler 62.0 (9.) 83.7 (4.) 102.6 (2.)
 Trefferlage 0.37 mm rechts, 0.29 mm tief
 Streuwert 0.97, horizontal: 0.84, vertikal: 1.08

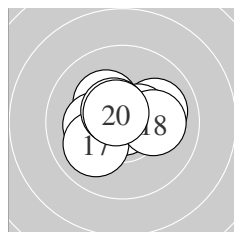

Serie 2:
 10.3 * 10.3 * 10.0 ↗ 10.5 * 10.9 *
 10.2 * 10.0 ↙ 10.1 → 10.6 * 10.6 *
 beste Teiler 3.6 (15.) 77.4 (20.) 98.2 (19.)
 Trefferlage 0.19 mm links, 0.16 mm hoch
 Streuwert 1.21, horizontal: 1.51, vertikal: 0.79

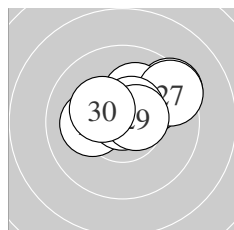

Serie 3:
 10.0 ↗ 10.6 * 10.1 ← 10.8 * 9.4 ↗
 10.1 ↗ 9.4 ↗ 10.5 * 10.6 * 10.3 *
 beste Teiler 33.0 (24.) 82.8 (22.) 97.0 (29.)
 Trefferlage 0.76 mm rechts, 1.03 mm hoch
 Streuwert 1.33, horizontal: 1.72, vertikal: 0.77

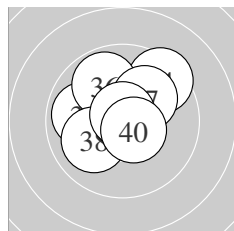

Serie 4:
 10.2 * 10.6 * 9.9 ← 9.4 ↗ 10.6 *
 9.9 ↘ 10.1 ↗ 10.0 ↙ 10.8 * 10.6 *
 beste Teiler 44.0 (39.) 85.0 (35.) 94.4 (32.)
 Trefferlage 0.37 mm links, 0.76 mm hoch
 Streuwert 1.45, horizontal: 1.63, vertikal: 1.24

Unterschrift des Schützen

Meyton Elektronik

Ergebnis: **385** (399.7)
 Serien: 97 98 96 94
 Zähler: 27 11 2 0 0 0 0 0 0 0
 Innenzehner: 21
 weiteste: 603 (26), 587 (33), 466 (35)
 beste Teiler 78.2 (32.) 87.9 (14.) 100.4 (25.)
 Trefferlage 0.13 mm rechts, 0.52 mm tief
 Streuwert 1.91, horizontal: 1.55, vertikal: 2.21

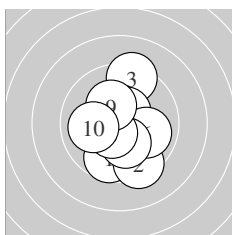
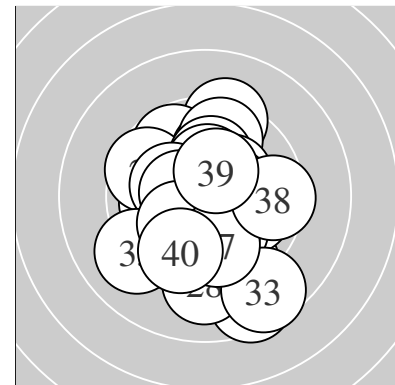

Serie 1:
 9.7 ↓ 9.4 ↘ 9.3 ↑ 10.4 * 10.5 *
 10.0 → 10.2 * 10.5 * 10.3 * 10.0 ←
 beste Teiler 108.4 (8.) 110.5 (5.) 127.8 (4.)
 Trefferlage 0.07 mm rechts, 0.28 mm tief
 Streuwert 1.88, horizontal: 1.41, vertikal: 2.26

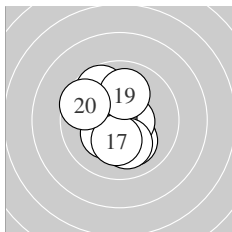

Serie 2:
 10.3 * 10.2 * 10.1 ↘ 10.6 * 10.1 ↓
 10.3 * 10.2 * 9.7 ↘ 10.0 ↑ 9.6 ↘
 beste Teiler 87.9 (14.) 161.0 (11.) 169.0 (16.)
 Trefferlage 0.31 mm links, 0.09 mm tief
 Streuwert 1.62, horizontal: 1.39, vertikal: 1.82

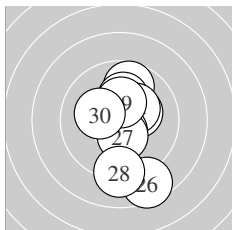

Serie 3:
 9.7 ↑ 10.3 * 10.1 ↑ 10.3 * 10.6 *
 8.5 ↘ 10.4 * 9.1 ↓ 10.3 * 10.2 *
 beste Teiler 100.4 (25.) 141.4 (27.) 156.5 (29.)
 Trefferlage 0.52 mm rechts, 0.36 mm tief
 Streuwert 2.13, horizontal: 1.12, vertikal: 2.79

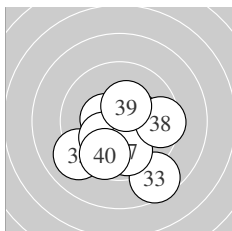

Serie 4:
 10.4 * 10.6 * 8.6 ↘ 10.4 * 9.1 ↘
 10.2 * 9.9 ↓ 9.5 → 10.4 * 9.7 ↓
 beste Teiler 78.2 (32.) 127.2 (34.) 136.8 (31.)
 Trefferlage 0.23 mm rechts, 1.35 mm tief
 Streuwert 2.08, horizontal: 2.20, vertikal: 1.96

Unterschrift des Schützen

Meyton Elektronik

Ergebnis: **380** (397.1)
 Serien: 95 92 98 95
 Zähler: 24 13 2 1 0 0 0 0 0 0
 Innenzehner: 19
 weiteste: 782 (33), 581 (3), 526 (16)
 beste Teiler 41.0 (18.) 64.0 (5.) 67.6 (21.)
 Trefferlage 0.85 mm rechts, 0.07 mm hoch
 Streuwert 2.04, horizontal: 2.39, vertikal: 1.61

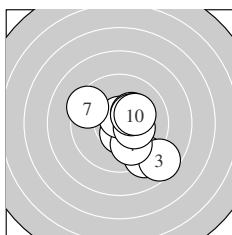
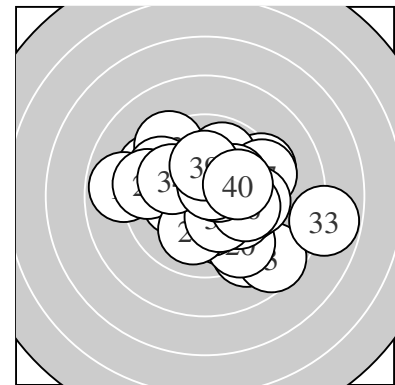

Serie 1:
 10.5 * 9.2 ↘ 8.6 ↘ 9.9 ↘ 10.7 *
 10.3 * 9.4 ↖ 10.3 * 10.3 * 10.2 *
 beste Teiler 64.0 (5.) 107.5 (1.) 155.6 (9.)
 Trefferlage 1.06 mm rechts, 0.61 mm tief
 Streuwert 2.02, horizontal: 2.00, vertikal: 2.04

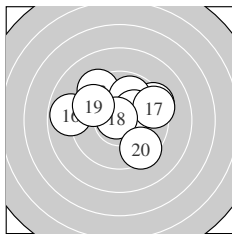

Serie 2:
 10.3 * 9.3 ↗ 9.4 ↖ 9.9 ↗ 10.2 *
 8.8 ← 9.4 ↗ 10.8 * 9.7 ↖ 9.5 ↘
 beste Teiler 41.0 (18.) 157.8 (11.) 185.2 (15.)
 Trefferlage 0.21 mm rechts, 1.06 mm hoch
 Streuwert 2.37, horizontal: 2.90, vertikal: 1.67

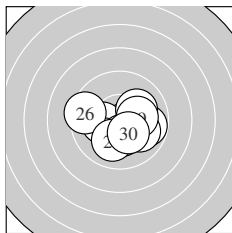

Serie 3:
 10.7 * 10.2 * 10.3 * 9.8 → 10.1 ↗
 9.4 ← 10.0 ↘ 10.0 ↓ 10.2 * 10.3 *
 beste Teiler 67.6 (21.) 164.7 (30.) 165.3 (23.)
 Trefferlage 0.41 mm rechts, 0.54 mm tief
 Streuwert 1.61, horizontal: 2.02, vertikal: 1.06

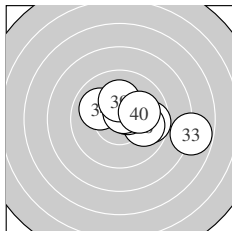

Serie 4:
 9.6 → 10.2 * 7.8 → 10.0 ↖ 10.5 *
 9.9 → 10.5 * 10.6 * 10.2 * 10.1 →
 beste Teiler 83.2 (38.) 103.7 (37.) 106.5 (35.)
 Trefferlage 1.70 mm rechts, 0.40 mm hoch
 Streuwert 1.96, horizontal: 2.59, vertikal: 1.01

Unterschrift des Schützen

Meyton Elektronik

Ergebnis: **369** (389.6)
 Serien: 91 92 91 95
 Zähler: 12 25 3 0 0 0 0 0 0 0
 Innenzehner: 10
 weiteste: 691 (5), 525 (27), 514 (18)
 beste Teiler 47.0 (16.) 87.2 (9.) 130.1 (21.)
 Trefferlage 0.40 mm links, 0.11 mm hoch
 Streuwert 2.35, horizontal: 2.55, vertikal: 2.13

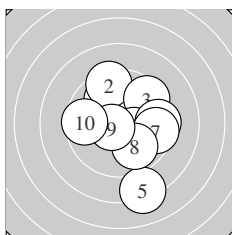
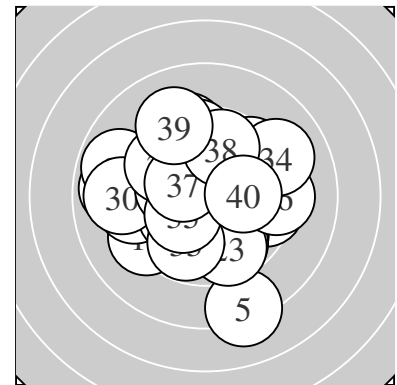

Serie 1:
 9.9 ↖ 9.4 ↖ 9.5 ↗ 10.3 * 8.2 ↘
 9.5 → 9.5 → 9.9 ↘ 10.6 * 9.6 ←
 beste Teiler 87.2 (9.) 156.9 (4.) 263.4 (1.)
 Trefferlage 0.86 mm rechts, 0.19 mm tief
 Streuwert 2.62, horizontal: 2.36, vertikal: 2.87

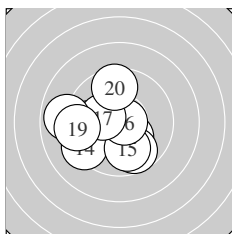

Serie 2:
 9.7 ← 10.2 * 9.7 ↘ 9.3 ↙ 9.9 ↘
 10.8 * 10.3 * 8.9 ← 9.3 ← 9.6 ↑
 beste Teiler 47.0 (16.) 171.1 (17.) 179.4 (12.)
 Trefferlage 1.41 mm links, 0.54 mm tief
 Streuwert 2.14, horizontal: 2.39, vertikal: 1.86

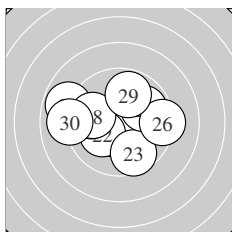

Serie 3:
 10.4 * 10.1 ↙ 9.6 ↘ 9.9 ↗ 9.8 ←
 9.3 → 8.9 ← 9.9 ← 9.8 ↑ 9.0 ←
 beste Teiler 130.1 (21.) 201.6 (22.) 268.6 (24.)
 Trefferlage 0.88 mm links, 0.16 mm hoch
 Streuwert 2.44, horizontal: 3.05, vertikal: 1.62

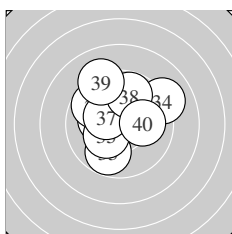

Serie 4:
 10.2 * 10.2 * 9.8 ↘ 9.1 ↗ 10.3 *
 9.7 ↖ 10.4 * 9.8 ↑ 9.2 ↘ 10.1 →
 beste Teiler 148.7 (37.) 168.2 (35.) 180.6 (32.)
 Trefferlage 0.18 mm links, 1.01 mm hoch
 Streuwert 2.04, horizontal: 2.12, vertikal: 1.97

Unterschrift des Schützen

Meyton Elektronik

Ergebnis: **378** (397.5)
 Serien: 97 97 90 94
 Zähler: 20 18 2 0 0 0 0 0 0 0
 Innenzehner: 18
 weiteste: 715 (27), 554 (30), 488 (22)
 beste Teiler 8.5 (3.) 18.8 (11.) 23.8 (8.)
 Trefferlage 0.93 mm links, 0.19 mm hoch
 Streuwert 2.05, horizontal: 1.99, vertikal: 2.11

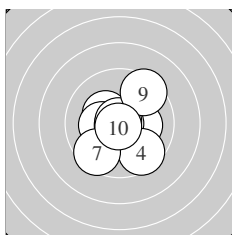
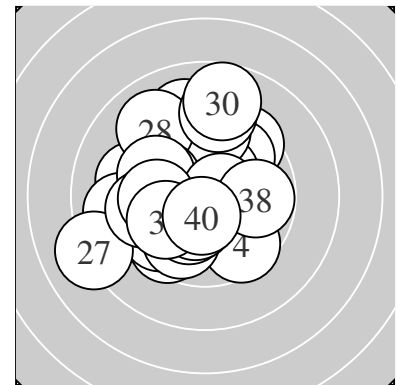

Serie 1:
 10.3 * 10.2 * 10.9 * 9.6 ↘ 10.3 *
 10.8 * 9.5 ↙ 10.9 * 9.4 ↗ 10.8 *
 beste Teiler 8.5 (3.) 23.8 (8.) 26.8 (6.)
 Trefferlage 0.06 mm rechts, 0.24 mm tief
 Streuwert 1.62, horizontal: 1.59, vertikal: 1.65

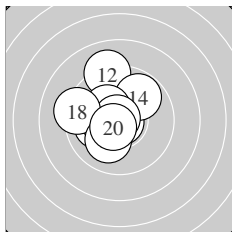

Serie 2:
 10.9 * 9.1 ↑ 10.1 ← 9.8 ↗ 10.4 *
 10.3 * 10.8 * 9.3 ← 10.1 ↙ 10.6 *
 beste Teiler 18.8 (11.) 31.6 (17.) 90.5 (20.)
 Trefferlage 1.00 mm links, 0.54 mm hoch
 Streuwert 1.66, horizontal: 1.52, vertikal: 1.78

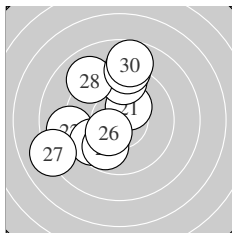

Serie 3:
 10.3 * 9.0 ← 9.6 ↙ 9.4 ↑ 9.8 ↘
 10.3 * 8.1 ← 9.0 ↘ 9.0 ↑ 8.7 ↑
 beste Teiler 154.7 (21.) 157.2 (26.) 287.7 (25.)
 Trefferlage 1.61 mm links, 0.92 mm hoch
 Streuwert 2.95, horizontal: 2.55, vertikal: 3.30

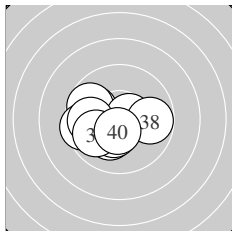

Serie 4:
 9.9 ↖ 9.7 ↖ 10.2 * 10.6 * 9.5 ←
 10.3 * 9.8 ← 9.8 → 9.9 ↙ 10.5 *
 beste Teiler 93.3 (34.) 116.7 (40.) 156.3 (36.)
 Trefferlage 1.17 mm links, 0.43 mm tief
 Streuwert 1.59, horizontal: 2.01, vertikal: 1.02

Unterschrift des Schützen

Meyton Elektronik

Ergebnis: **372** (390.0)
 Serien: 97 85 94 96
 Zähler: 23 14 2 0 0 0 0 0 0 0
 Innenzehner: 18
 weiteste: 2657 (18), 610 (28), 559 (11)
 beste Teiler 18.9 (23.) 20.1 (34.) 45.1 (20.)
 Trefferlage 0.51 mm links, 0.14 mm hoch
 Streuwert 3.58, horizontal: 4.53, vertikal: 2.27

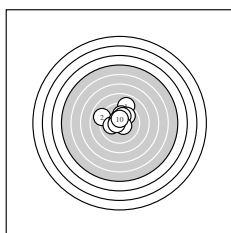
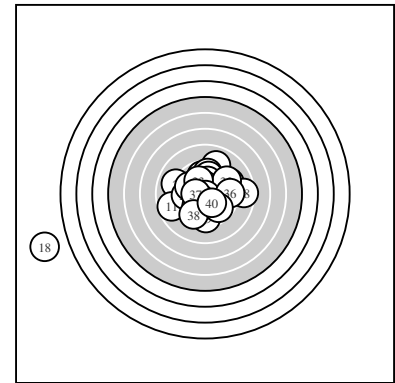

Serie 1:
 9.0 ↗ 9.0 ↖ 10.1 ← 10.0 ↑ 9.9 ↗
 10.2 * 10.5 * 10.6 * 10.6 * 10.5 *
 beste Teiler 82.9 (9.) 99.1 (8.) 115.0 (10.)
 Trefferlage 0.23 mm links, 1.27 mm hoch
 Streuwert 1.76, horizontal: 1.94, vertikal: 1.56

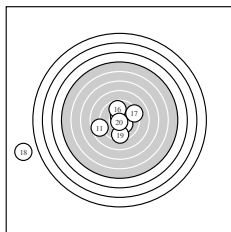

Serie 2:
 8.7 ← 10.6 * 10.5 * 10.7 * 10.3 *
 9.8 ↑ 9.3 → 0.0 ← 9.4 ↓ 10.8 *
 beste Teiler 45.1 (20.) 51.4 (14.) 98.3 (12.)
 Trefferlage 2.48 mm links, 0.95 mm tief
 Streuwert 6.29, horizontal: 8.30, vertikal: 3.21

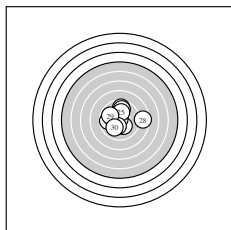

Serie 3:
 9.6 ↑ 10.2 * 10.9 * 9.8 ↑ 10.1 ↑
 9.7 ← 10.3 * 8.5 → 9.9 ↖ 10.0 ↙
 beste Teiler 18.9 (23.) 163.5 (27.) 183.6 (22.)
 Trefferlage 0.11 mm rechts, 0.45 mm hoch
 Streuwert 2.20, horizontal: 2.50, vertikal: 1.85

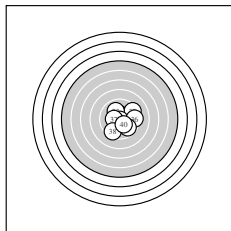

Serie 4:
 10.4 * 9.4 ↗ 10.0 ↖ 10.9 * 10.5 *
 9.4 → 10.4 * 9.5 ↙ 9.7 ↘ 10.3 *
 beste Teiler 20.1 (34.) 108.9 (35.) 136.9 (31.)
 Trefferlage 0.53 mm rechts, 0.20 mm tief
 Streuwert 1.90, horizontal: 2.03, vertikal: 1.76

Unterschrift des Schützen

Meyton Elektronik