

Ergebnis: **387** (405.1)
 Serien: 97 97 99 94
 Zähler: 28 11 1 0 0 0 0 0 0 0
 Innenzehner: 24
 weiteste: 574 (8), 477 (34), 466 (10)
 beste Teiler 32.5 (17.) 38.1 (27.) 43.6 (31.)
 Trefferlage 0.23 mm rechts, 0.29 mm hoch
 Streuwert 1.80, horizontal: 2.29, vertikal: 1.12

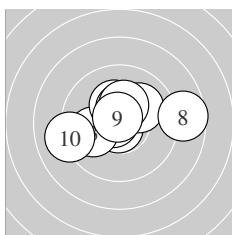

Serie 1:
 10.8 * 10.7 * 10.0 ← 10.3 * 10.4 *
 10.1 ↗ 10.3 * 8.7 → 10.7 * 9.1 ←
 beste Teiler 44.6 (1.) 57.2 (2.) 57.2 (9.)
 Trefferlage 0.03 mm links, 0.47 mm hoch
 Streuwert 2.00, horizontal: 2.63, vertikal: 1.04

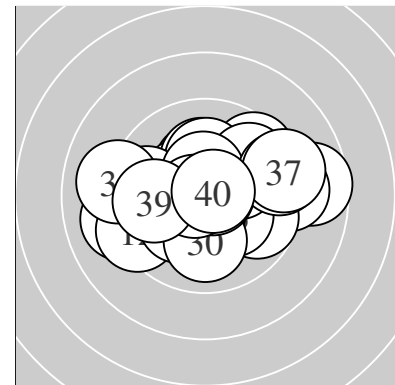
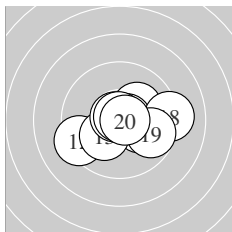

Serie 2:
 10.2 * 9.3 ← 10.2 * 10.2 * 10.7 *
 10.7 * 10.8 * 9.2 → 9.7 → 10.8 *
 beste Teiler 32.5 (17.) 48.0 (20.) 51.0 (16.)
 Trefferlage 0.62 mm rechts, 0.28 mm tief
 Streuwert 1.73, horizontal: 2.25, vertikal: 0.94

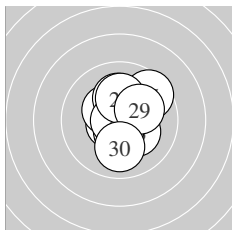

Serie 3:
 10.6 * 10.4 * 10.2 * 10.2 * 9.6 ↗
 10.5 * 10.8 * 10.2 * 10.1 ↗ 10.0 ↓
 beste Teiler 38.1 (27.) 86.4 (21.) 107.4 (26.)
 Trefferlage 0.33 mm rechts, 0.32 mm hoch
 Streuwert 1.39, horizontal: 1.21, vertikal: 1.56

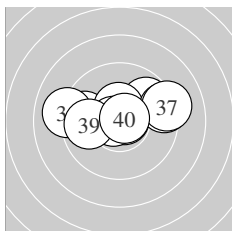

Serie 4:
 10.8 * 9.7 ← 9.8 ↗ 9.0 ← 10.5 *
 9.3 → 9.2 → 10.7 * 9.8 ← 10.8 *
 beste Teiler 43.6 (31.) 50.6 (40.) 56.0 (38.)
 Trefferlage 0.02 mm rechts, 0.67 mm hoch
 Streuwert 2.16, horizontal: 2.98, vertikal: 0.67

Unterschrift des Schützen

Ergebnis: **390** (406.8)
 Serien: 98 97 98 97
 Zähler: 30 10 0 0 0 0 0 0 0 0
 Innenzehner: 24
 weiteste: 497 (10), 405 (40), 376 (25)
 beste Teiler 22.4 (34.) 24.3 (36.) 90.0 (28.)
 Trefferlage 0.26 mm rechts, 0.11 mm tief
 Streuwert 1.56, horizontal: 1.80, vertikal: 1.27

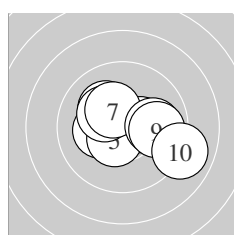
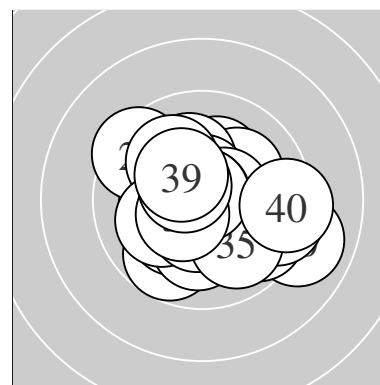

Serie 1:
 10.5 * 10.2 * 10.2 * 10.4 * 10.5 *
 10.2 * 10.3 * 10.0 → 9.9 → 9.0 ↘
 beste Teiler 105.8 (1.) 111.5 (5.) 144.3 (4.)
 Trefferlage 0.43 mm rechts, 0.15 mm hoch
 Streuwert 1.72, horizontal: 2.19, vertikal: 1.05

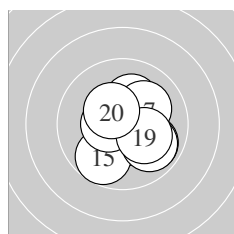

Serie 2:
 10.2 * 10.5 * 9.9 ↘ 10.4 * 9.7 ↘
 9.9 ↘ 10.1 ↗ 10.5 * 10.2 * 10.4 *
 beste Teiler 112.0 (18.) 120.9 (12.) 139.9 (20.)
 Trefferlage 0.66 mm rechts, 0.43 mm tief
 Streuwert 1.40, horizontal: 1.40, vertikal: 1.41

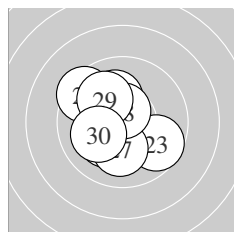

Serie 3:
 10.5 * 10.3 * 9.7 ↘ 10.2 * 9.4 ↘
 10.1 ↑ 10.1 ↓ 10.6 * 10.0 ↘ 10.1 ↙
 beste Teiler 90.0 (28.) 114.5 (21.) 168.6 (22.)
 Trefferlage 0.78 mm links, 0.06 mm hoch
 Streuwert 1.58, horizontal: 1.51, vertikal: 1.65

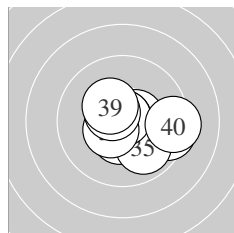

Serie 4:
 9.5 → 10.5 * 10.5 * 10.9 * 9.9 ↘
 10.9 * 10.5 * 10.5 * 10.3 * 9.3 →
 beste Teiler 22.4 (34.) 24.3 (36.) 107.2 (38.)
 Trefferlage 0.74 mm rechts, 0.25 mm tief
 Streuwert 1.46, horizontal: 1.83, vertikal: 0.96

Unterschrift des Schützen

Meyton Elektronik

Ergebnis: **391** (408.9)
 Serien: 96 98 97 100
 Zähler: 31 9 0 0 0 0 0 0 0 0
 Innenzehner: 28
 weiteste: 456 (12), 430 (30), 403 (7)
 beste Teiler 10.4 (36.) 20.2 (18.) 42.7 (39.)
 Trefferlage 0.30 mm rechts, 0.16 mm hoch
 Streuwert 1.51, horizontal: 1.89, vertikal: 1.01

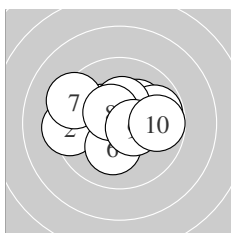
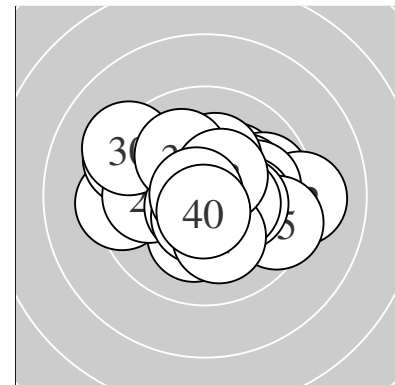

Serie 1:
 10.3 * 9.4 ← 10.2 * 9.8 → 10.4 *
 10.2 * 9.3 ↖ 10.5 * 10.5 * 9.8 →
 beste Teiler 110.2 (8.) 116.6 (9.) 149.2 (5.)
 Trefferlage 0.17 mm links, 0.44 mm hoch
 Streuwert 1.85, horizontal: 2.38, vertikal: 1.10

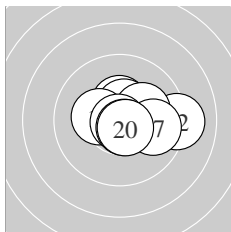

Serie 2:
 10.4 * 9.1 → 10.3 * 10.5 * 10.2 *
 10.3 * 9.9 → 10.9 * 10.7 * 10.7 *
 beste Teiler 20.2 (18.) 68.2 (19.) 75.6 (20.)
 Trefferlage 0.99 mm rechts, 0.17 mm hoch
 Streuwert 1.31, horizontal: 1.72, vertikal: 0.70

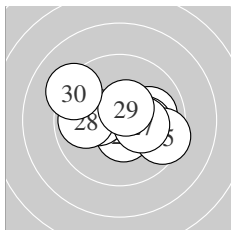

Serie 3:
 10.4 * 10.5 * 10.0 → 10.2 * 9.5 →
 10.3 * 10.2 * 9.9 ← 10.5 * 9.2 ↖
 beste Teiler 109.5 (29.) 113.6 (22.) 130.3 (21.)
 Trefferlage 0.34 mm rechts, 0.01 mm hoch
 Streuwert 1.80, horizontal: 2.32, vertikal: 1.05

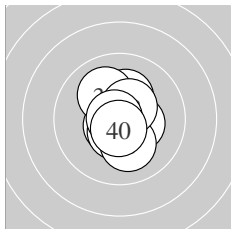

Serie 4:
 10.2 * 10.4 * 10.6 * 10.5 * 10.1 ↖
 10.9 * 10.1 ↓ 10.5 * 10.8 * 10.7 *
 beste Teiler 10.4 (36.) 42.7 (39.) 75.4 (40.)
 Trefferlage 0.07 mm rechts, 0.01 mm hoch
 Streuwert 1.01, horizontal: 0.75, vertikal: 1.22

Unterschrift des Schützen

Ergebnis: **377** (395.7)
 Serien: 94 94 94 95
 Zähler: 21 15 4 0 0 0 0 0 0 0
 Innenzehner: 13
 weiteste: 654 (23), 628 (12), 613 (10)
 beste Teiler 56.4 (35.) 58.3 (27.) 68.0 (30.)
 Trefferlage 0.10 mm rechts, 0.39 mm hoch
 Streuwert 2.16, horizontal: 2.53, vertikal: 1.72

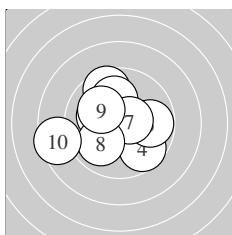
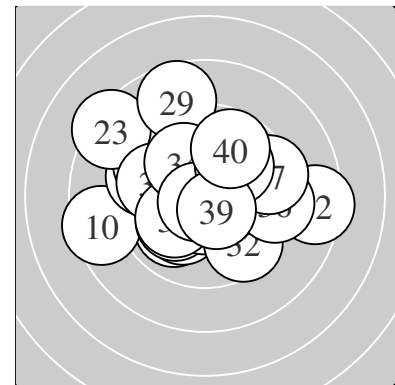

Serie 1:
 10.2 * 9.6 ↖ 10.5 * 9.7 ↘ 9.8 →
 10.0 ↑ 10.6 * 9.9 ↙ 10.1 ↖ 8.5 ←
 beste Teiler 97.8 (7.) 103.9 (3.) 198.0 (1.)
 Trefferlage 0.75 mm links, 0.08 mm hoch
 Streuwert 2.16, horizontal: 2.47, vertikal: 1.81

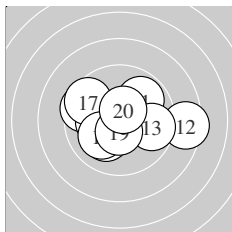

Serie 2:
 9.9 ↗ 8.4 → 9.7 → 10.1 ↙ 9.5 ↖
 10.2 * 9.6 ↖ 10.1 ↙ 10.5 * 10.5 *
 beste Teiler 103.4 (20.) 108.2 (19.) 195.0 (16.)
 Trefferlage 0.02 mm rechts, 0.02 mm hoch
 Streuwert 2.32, horizontal: 3.01, vertikal: 1.32

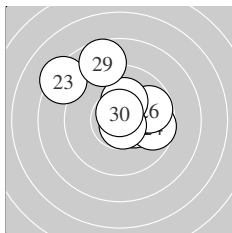

Serie 3:
 10.5 * 10.4 * 8.3 ↖ 9.7 → 10.1 →
 9.8 → 10.7 * 10.2 * 8.7 ↑ 10.7 *
 beste Teiler 58.3 (27.) 68.0 (30.) 107.2 (21.)
 Trefferlage 0.40 mm rechts, 1.18 mm hoch
 Streuwert 2.24, horizontal: 2.45, vertikal: 2.01

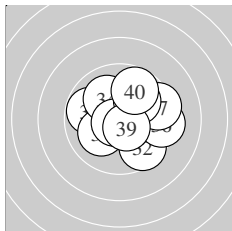

Serie 4:
 9.8 ↖ 9.6 ↘ 10.1 ↙ 10.0 ↖ 10.7 *
 9.4 → 9.4 → 10.0 ↗ 10.5 * 9.7 ↗
 beste Teiler 56.4 (35.) 101.5 (39.) 214.0 (33.)
 Trefferlage 0.73 mm rechts, 0.28 mm hoch
 Streuwert 1.98, horizontal: 2.26, vertikal: 1.65

Unterschrift des Schützen

Meyton Elektronik

Ergebnis:	375	(395.7)
Serien:	93 94 94 94	
Zähler:	20 16 3 1 0 0 0 0 0 0	
Innenzehner:	15	
weiteste:	924 (15), 611 (27), 604 (10)	
beste Teiler	23.4 (13.) 27.0 (33.) 33.0 (29.)	
Trefferlage	0.28 mm links, 0.22 mm hoch	
Streuwert	2.27, horizontal: 2.67, vertikal: 1.77	

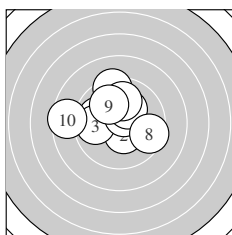
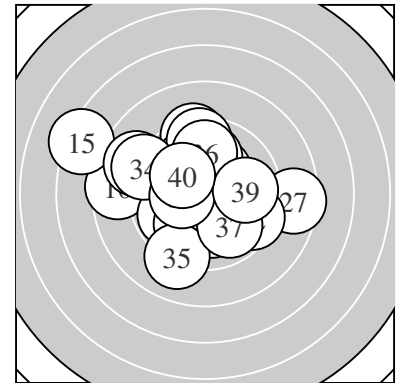

Serie 1:	9.9 ↖	10.4 *	9.8 ←	10.6 *	10.2 *
	9.3 ↑	9.9 ↑	9.5 →	10.0 ↘	8.5 ←
beste Teiler	86.0 (4.) 133.5 (2.) 183.8 (5.)				
Trefferlage	0.76 mm links, 0.95 mm hoch				
Streuwert	2.16, horizontal: 2.57, vertikal: 1.65				

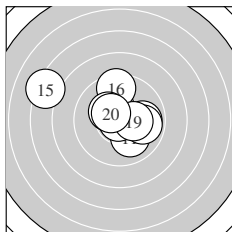

Serie 2:	10.0 ↘	9.9 →	10.9 *	10.4 *	7.3 ↖
	9.5 ↑	10.3 *	9.9 →	10.3 *	10.4 *
beste Teiler	23.4 (13.) 127.2 (20.) 136.3 (14.)				
Trefferlage	0.38 mm links, 0.75 mm hoch				
Streuwert	2.58, horizontal: 3.20, vertikal: 1.77				

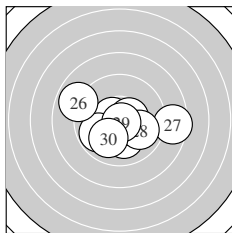

Serie 3:	10.6 *	10.1 ↓	9.8 ↙	10.6 *	10.5 *
	8.9 ↖	8.5 →	9.9 ↘	10.8 *	10.0 ↙
beste Teiler	33.0 (29.) 83.5 (24.) 91.3 (21.)				
Trefferlage	0.16 mm rechts, 0.49 mm tief				
Streuwert	2.23, horizontal: 2.89, vertikal: 1.27				

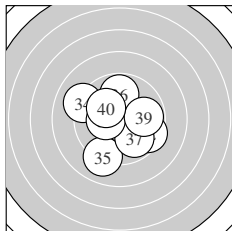

Serie 4:	10.6 *	9.5 ↘	10.8 *	9.1 ↖	9.1 ↙
	9.8 ↑	9.9 ↘	10.3 *	9.8 →	10.1 ↖
beste Teiler	27.0 (33.) 87.9 (31.) 159.4 (38.)				
Trefferlage	0.14 mm links, 0.31 mm tief				
Streuwert	2.19, horizontal: 2.29, vertikal: 2.07				

Unterschrift des Schützen

Ergebnis: **380** (397.9)
 Serien: 96 95 94 95
 Zähler: 22 16 2 0 0 0 0 0 0 0
 Innenzehner: 15
 weiteste: 693 (16), 544 (27), 500 (29)
 beste Teiler 76.2 (40.) 81.3 (13.) 84.2 (22.)
 Trefferlage 0.80 mm rechts, 0.36 mm tief
 Streuwert 1.95, horizontal: 2.41, vertikal: 1.34

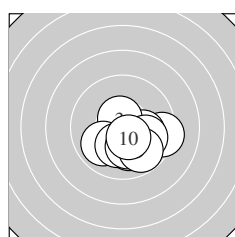
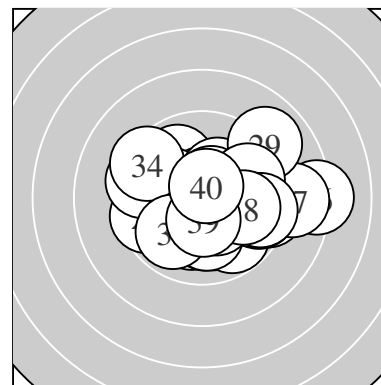

Serie 1:
 9.3 → 10.1 → 10.6 * 10.1 ↓ 9.9 →
 9.9 ↙ 10.2 * 10.1 ↓ 9.8 ↓ 10.5 *
 beste Teiler 93.3 (3.) 117.8 (10.) 189.8 (7.)
 Trefferlage 0.90 mm rechts, 1.22 mm tief
 Streuwert 1.37, horizontal: 1.68, vertikal: 0.96

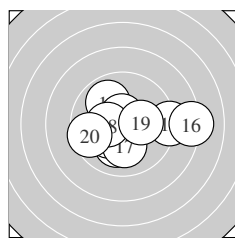

Serie 2:
 9.9 ↖ 10.1 ↓ 10.6 * 9.1 → 10.2 *
 8.2 → 10.1 ↓ 10.3 * 10.2 * 9.6 ←
 beste Teiler 81.3 (13.) 151.0 (18.) 182.2 (15.)
 Trefferlage 0.53 mm rechts, 0.33 mm tief
 Streuwert 2.41, horizontal: 3.14, vertikal: 1.33

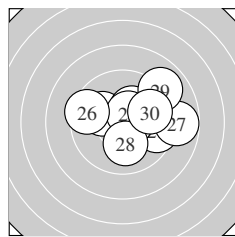

Serie 3:
 9.5 → 10.6 * 10.1 ↖ 10.3 * 10.5 *
 9.5 ↖ 8.8 → 10.1 ↓ 9.0 ↗ 9.8 →
 beste Teiler 84.2 (22.) 105.6 (25.) 168.0 (24.)
 Trefferlage 1.24 mm rechts, 0.53 mm hoch
 Streuwert 2.18, horizontal: 2.73, vertikal: 1.44

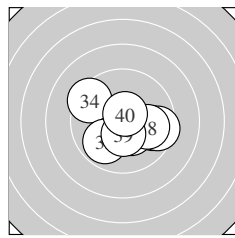

Serie 4:
 10.5 * 10.6 * 9.7 → 9.4 ↖ 9.9 ↙
 9.5 → 10.4 * 9.9 → 10.4 * 10.6 *
 beste Teiler 76.2 (40.) 91.3 (32.) 113.8 (31.)
 Trefferlage 0.53 mm rechts, 0.44 mm tief
 Streuwert 1.73, horizontal: 2.16, vertikal: 1.15

Unterschrift des Schützen

Meyton Elektronik

Ergebnis: **371** (390.7)
 Serien: 92 92 94 93
 Zähler: 17 19 2 2 0 0 0 0 0 0
 Innenzehner: 12
 weiteste: 843 (4), 815 (13), 597 (8)
 beste Teiler 70.2 (15.) 76.9 (25.) 96.6 (34.)
 Trefferlage 0.32 mm rechts, 0.75 mm hoch
 Streuwert 2.41, horizontal: 2.55, vertikal: 2.27

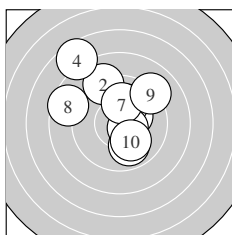
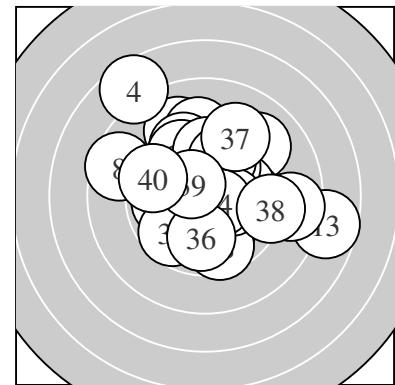

Serie 1:
 9.9 ↘ 9.1 ↖ 10.3 * 7.6 ↗ 10.1 ↗
 10.5 * 10.1 ↑ 8.6 ↖ 9.1 ↗ 10.1 ↘
 beste Teiler 102.5 (6.) 161.1 (3.) 220.3 (7.)
 Trefferlage 0.30 mm links, 1.66 mm hoch
 Streuwert 2.86, horizontal: 2.87, vertikal: 2.85

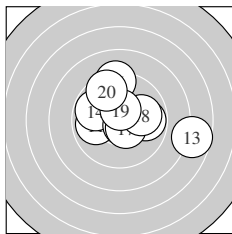

Serie 2:
 9.9 ← 9.8 → 7.7 → 9.8 ↖ 10.7 *
 9.2 ↑ 10.5 * 10.0 → 10.5 * 9.5 ↘
 beste Teiler 70.2 (15.) 109.4 (17.) 113.4 (19.)
 Trefferlage 0.72 mm rechts, 0.65 mm hoch
 Streuwert 2.58, horizontal: 3.13, vertikal: 1.88

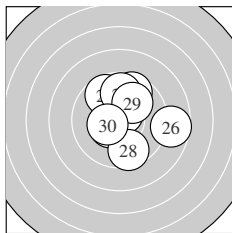

Serie 3:
 9.6 ↗ 9.7 ↘ 10.2 * 10.4 * 10.6 *
 8.7 → 9.8 ↑ 9.6 ↓ 10.0 ↗ 10.4 *
 beste Teiler 76.9 (25.) 131.4 (24.) 141.3 (30.)
 Trefferlage 0.67 mm rechts, 0.78 mm hoch
 Streuwert 2.06, horizontal: 2.05, vertikal: 2.07

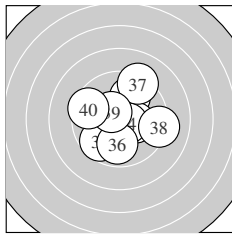

Serie 4:
 9.9 ↙ 9.9 ↗ 10.3 * 10.6 * 9.7 ↙
 9.9 ↓ 9.2 ↗ 9.2 → 10.5 * 9.5 ↖
 beste Teiler 96.6 (34.) 118.4 (39.) 174.4 (33.)
 Trefferlage 0.19 mm rechts, 0.07 mm tief
 Streuwert 2.21, horizontal: 2.27, vertikal: 2.14

Unterschrift des Schützen

Meyton Elektronik

Ergebnis: **374** (392.4)
 Serien: 93 95 94 92
 Zähler: 17 20 3 0 0 0 0 0 0 0
 Innenzehner: 13
 weiteste: 712 (35), 656 (7), 615 (21)
 beste Teiler 38.2 (38.) 59.0 (33.) 96.1 (16.)
 Trefferlage 0.17 mm links, 0.23 mm tief
 Streuwert 2.31, horizontal: 2.90, vertikal: 1.51

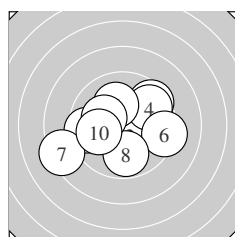
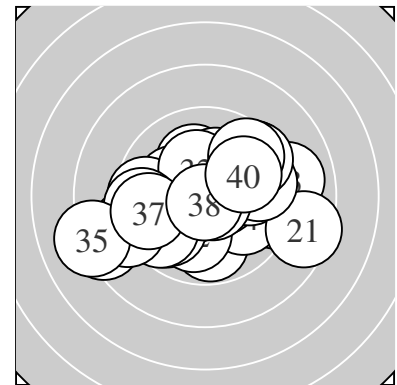

Serie 1:
 9.5 ↗ 10.5 * 9.5 ← 9.7 ↗ 10.1 ↑
 9.3 → 8.3 ← 9.8 ↓ 10.2 * 10.0 ←
 beste Teiler 122.0 (2.) 195.7 (9.) 209.0 (5.)
 Trefferlage 0.37 mm links, 0.18 mm tief
 Streuwert 2.56, horizontal: 3.13, vertikal: 1.81

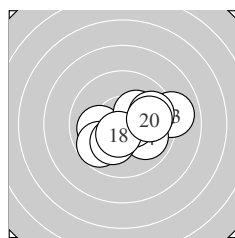

Serie 2:
 10.0 ← 9.7 ↖ 9.0 → 9.9 ↘ 10.2 *
 10.6 * 10.3 * 10.5 * 9.8 → 9.9 →
 beste Teiler 96.1 (16.) 107.7 (18.) 171.9 (17.)
 Trefferlage 0.88 mm rechts, 0.28 mm tief
 Streuwert 1.85, horizontal: 2.34, vertikal: 1.16

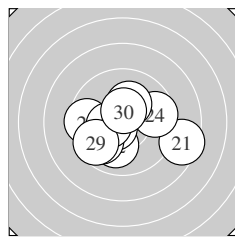

Serie 3:
 8.5 → 10.0 ↓ 10.6 * 9.6 → 10.2 *
 9.5 ← 9.8 ↖ 10.4 * 9.6 ↖ 10.5 *
 beste Teiler 97.6 (23.) 112.4 (30.) 138.5 (28.)
 Trefferlage 0.13 mm links, 0.52 mm tief
 Streuwert 2.24, horizontal: 2.81, vertikal: 1.46

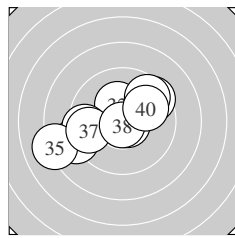

Serie 4:
 9.0 ← 10.3 * 10.7 * 9.4 ← 8.1 ←
 9.5 ↗ 9.6 ← 10.8 * 9.6 ↗ 9.9 →
 beste Teiler 38.2 (38.) 59.0 (33.) 171.7 (32.)
 Trefferlage 1.07 mm links, 0.06 mm hoch
 Streuwert 2.63, horizontal: 3.31, vertikal: 1.70

Unterschrift des Schützen

Meyton Elektronik

Ergebnis: **388** (406.8)
 Serien: 95 97 99 97
 Zähler: 29 10 1 0 0 0 0 0 0 0
 Innenzehner: 23
 weiteste: 574 (2), 376 (37), 361 (16)
 beste Teiler 22.2 (28.) 54.0 (5.) 73.3 (15.)
 Trefferlage 0.25 mm rechts, 0.17 mm hoch
 Streuwert 1.58, horizontal: 1.78, vertikal: 1.35

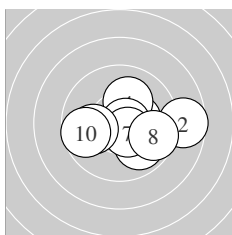
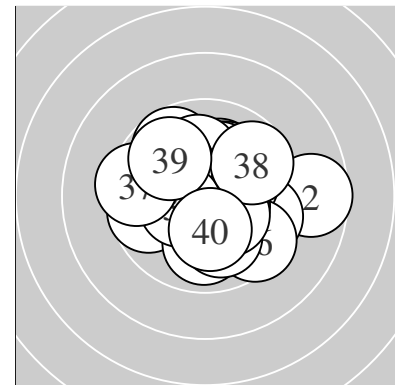

Serie 1:
 10.3 * 8.7 → 10.5 * 10.1 ↗ 10.7 *
 9.9 ↘ 10.5 * 9.7 → 10.0 ← 9.7 ←
 beste Teiler 54.0 (5.) 103.4 (3.) 109.0 (7.)
 Trefferlage 0.93 mm rechts, 0.21 mm tief
 Streuwert 1.92, horizontal: 2.49, vertikal: 1.09

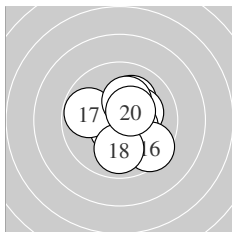

Serie 2:
 10.1 ↗ 10.2 * 10.4 * 10.6 * 10.7 *
 9.5 ↘ 9.8 ← 9.9 ↓ 10.2 * 10.4 *
 beste Teiler 73.3 (15.) 89.1 (14.) 128.5 (20.)
 Trefferlage 0.53 mm rechts, 0.13 mm tief
 Streuwert 1.51, horizontal: 1.47, vertikal: 1.54

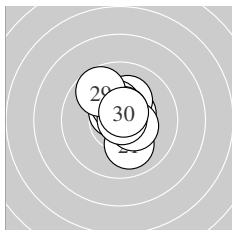

Serie 3:
 10.0 ↘ 10.5 * 10.2 * 10.6 * 10.4 *
 10.4 * 10.6 * 10.9 * 9.7 ↖ 10.6 *
 beste Teiler 22.2 (28.) 79.6 (30.) 84.5 (27.)
 Trefferlage 0.21 mm rechts, 0.58 mm hoch
 Streuwert 1.11, horizontal: 0.89, vertikal: 1.30

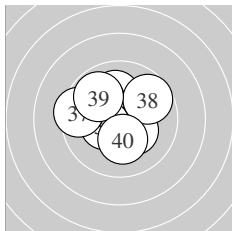

Serie 4:
 10.3 * 10.1 ↑ 10.7 * 10.4 * 10.0 ↖
 10.4 * 9.4 ← 9.7 ↗ 9.8 ↖ 10.2 *
 beste Teiler 73.5 (33.) 131.0 (34.) 142.8 (36.)
 Trefferlage 0.65 mm links, 0.46 mm hoch
 Streuwert 1.60, horizontal: 1.76, vertikal: 1.43

Unterschrift des Schützen

Meyton Elektronik

Ergebnis: **387** (406.2)
 Serien: 94 97 97 99
 Zähler: 29 9 2 0 0 0 0 0 0 0
 Innenzehner: 20
 weiteste: 509 (9), 503 (4), 434 (7)
 beste Teiler 27.4 (31.) 37.0 (37.) 43.5 (38.)
 Trefferlage 0.10 mm rechts, 0.65 mm hoch
 Streuwert 1.62, horizontal: 1.75, vertikal: 1.48

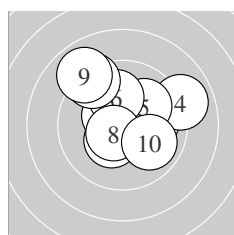
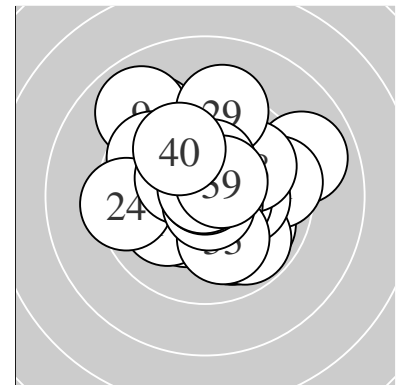

Serie 1:
 10.0 → 10.4 * 10.4 * 8.9 → 10.0 ↗
 10.0 ↑ 9.2 ↘ 10.6 * 8.9 ↘ 9.9 ↘
 beste Teiler 97.0 (8.) 132.4 (3.) 150.2 (2.)
 Trefferlage 0.21 mm rechts, 1.10 mm hoch
 Streuwert 2.17, horizontal: 2.42, vertikal: 1.90

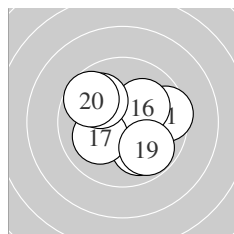

Serie 2:
 9.5 → 10.6 * 10.0 ↘ 10.1 ↘ 10.5 *
 10.1 ↗ 10.1 ↖ 10.0 ↘ 9.8 ↘ 9.7 ↘
 beste Teiler 77.9 (12.) 108.4 (15.) 204.1 (16.)
 Trefferlage 0.09 mm links, 0.28 mm hoch
 Streuwert 1.78, horizontal: 2.03, vertikal: 1.49

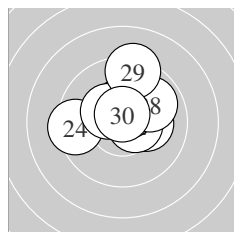

Serie 3:
 10.2 * 10.5 * 10.5 * 9.4 ← 10.6 *
 10.4 * 10.5 * 9.9 ↗ 9.3 ↑ 10.7 *
 beste Teiler 64.1 (30.) 97.4 (25.) 101.9 (27.)
 Trefferlage 0.11 mm rechts, 0.94 mm hoch
 Streuwert 1.51, horizontal: 1.71, vertikal: 1.28

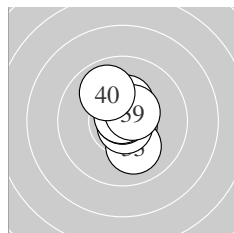

Serie 4:
 10.8 * 10.7 * 10.1 ↘ 10.7 * 10.4 *
 10.8 * 10.8 * 10.8 * 10.5 * 9.9 ↘
 beste Teiler 27.4 (31.) 37.0 (37.) 43.5 (38.)
 Trefferlage 0.19 mm rechts, 0.28 mm hoch
 Streuwert 0.92, horizontal: 0.59, vertikal: 1.16

Unterschrift des Schützen

Meyton Elektronik

Ergebnis: **385** (400.4)
 Serien: 91 99 97 98
 Zähler: 25 15 0 0 0 0 0 0 0 0
 Innenzehner: 16
 weiteste: 488 (33), 427 (5), 365 (28)
 beste Teiler 33.2 (20.) 53.3 (18.) 93.6 (30.)
 Trefferlage 0.46 mm rechts, 0.11 mm tief
 Streuwert 1.80, horizontal: 2.06, vertikal: 1.50

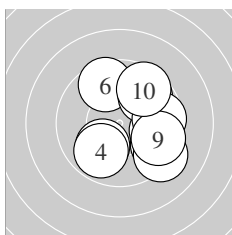
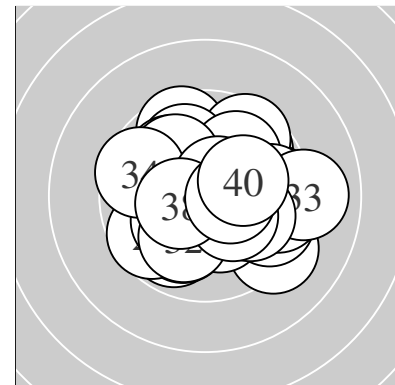

Serie 1:
 10.0 ↙ 9.7 → 9.5 ↘ 9.9 ↙ 9.2 ↘
 9.6 ↖ 9.7 ↗ 9.6 → 9.6 → 9.6 ↗
 beste Teiler 236.6 (1.) 275.1 (4.) 306.2 (7.)
 Trefferlage 1.60 mm rechts, 0.18 mm tief
 Streuwert 2.15, horizontal: 2.11, vertikal: 2.20

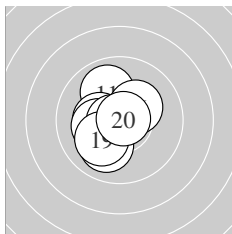

Serie 2:
 9.9 ↖ 10.4 * 10.0 ↙ 10.3 * 10.2 *
 10.3 * 10.2 * 10.7 * 10.1 ↙ 10.8 *
 beste Teiler 33.2 (20.) 53.3 (18.) 146.6 (12.)
 Trefferlage 0.85 mm links, 0.26 mm tief
 Streuwert 1.14, horizontal: 0.98, vertikal: 1.28

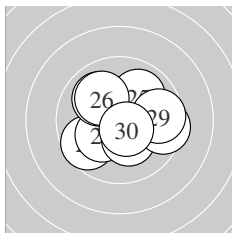

Serie 3:
 9.7 ↙ 10.2 * 10.0 ↖ 10.3 * 10.0 ↗
 10.0 ↖ 10.3 * 9.5 → 9.7 → 10.6 *
 beste Teiler 93.6 (30.) 157.9 (24.) 171.7 (27.)
 Trefferlage 0.30 mm rechts, 0.13 mm hoch
 Streuwert 1.83, horizontal: 2.11, vertikal: 1.51

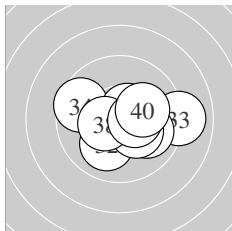

Serie 4:
 10.4 * 10.0 ↙ 9.0 → 9.6 ↖ 10.0 ↘
 10.3 * 10.6 * 10.4 * 10.4 * 10.1 →
 beste Teiler 95.5 (37.) 126.4 (39.) 127.7 (38.)
 Trefferlage 0.80 mm rechts, 0.13 mm tief
 Streuwert 1.72, horizontal: 2.22, vertikal: 0.98

Unterschrift des Schützen

Ergebnis: **381** (401.5)
 Serien: 96 98 92 95
 Zähler: 24 13 3 0 0 0 0 0 0 0
 Innenzehner: 18
 weiteste: 629 (24), 620 (39), 506 (27)
 beste Teiler 36.4 (29.) 50.2 (3.) 54.6 (22.)
 Trefferlage 0.12 mm rechts, 0.35 mm hoch
 Streuwert 1.90, horizontal: 1.72, vertikal: 2.07

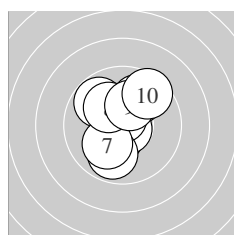
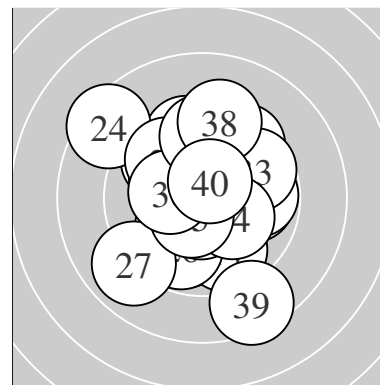

Serie 1:
 9.9 ↗ 10.5 * 10.8 * 10.7 * 9.9 ↘
 9.8 ↘ 10.1 ↙ 10.1 ↘ 10.2 * 9.5 ↗
 beste Teiler 50.2 (3.) 66.4 (4.) 109.7 (2.)
 Trefferlage 0.15 mm links, 0.55 mm hoch
 Streuwert 1.60, horizontal: 1.31, vertikal: 1.84

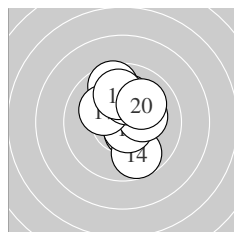

Serie 2:
 10.5 * 10.7 * 9.6 ↑ 9.7 ↓ 10.7 *
 10.2 * 10.2 * 10.1 ↑ 10.0 ↑ 10.0 ↗
 beste Teiler 67.1 (15.) 68.6 (12.) 106.5 (11.)
 Trefferlage 0.36 mm rechts, 0.73 mm hoch
 Streuwert 1.47, horizontal: 1.09, vertikal: 1.77

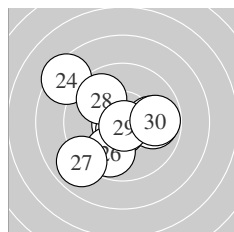

Serie 3:
 10.0 → 10.7 * 10.7 * 8.4 ↘ 9.9 →
 9.8 ↘ 8.9 ↙ 9.8 ↘ 10.8 * 9.8 →
 beste Teiler 36.4 (29.) 54.6 (22.) 68.6 (23.)
 Trefferlage 0.40 mm links, 0.14 mm tief
 Streuwert 2.38, horizontal: 2.66, vertikal: 2.07

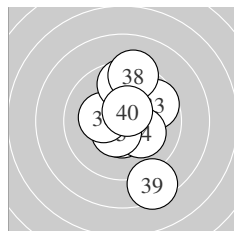

Serie 4:
 10.3 * 10.5 * 9.7 ↗ 10.2 * 10.5 *
 10.3 * 9.6 ↑ 9.3 ↑ 8.5 ↓ 10.6 *
 beste Teiler 98.4 (40.) 104.1 (32.) 110.2 (35.)
 Trefferlage 0.71 mm rechts, 0.27 mm hoch
 Streuwert 2.16, horizontal: 1.40, vertikal: 2.71

Unterschrift des Schützen

Ergebnis: **388** (403.1)
 Serien: 98 97 98 95
 Zähler: 28 12 0 0 0 0 0 0 0 0
 Innenzehner: 21
 weiteste: 468 (18), 459 (29), 444 (24)
 beste Teiler 24.0 (32.) 74.4 (30.) 77.1 (23.)
 Trefferlage 0.75 mm rechts, 0.42 mm tief
 Streuwert 1.64, horizontal: 1.80, vertikal: 1.47

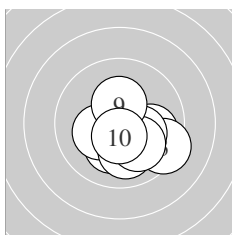
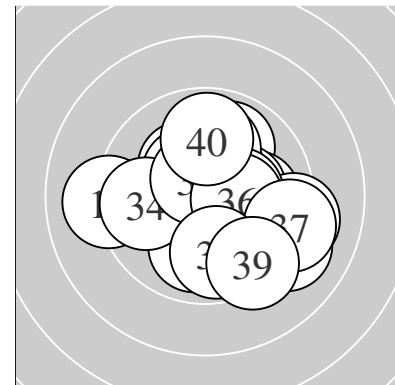

Serie 1:
 9.9 → 10.2 * 9.4 ↘ 10.2 * 10.3 *
 10.0 ↓ 10.2 * 10.1 ↘ 10.3 * 10.5 *
 beste Teiler 104.0 (10.) 154.0 (9.) 174.5 (5.)
 Trefferlage 0.88 mm rechts, 1.03 mm tief
 Streuwert 1.32, horizontal: 1.53, vertikal: 1.06

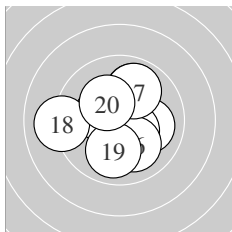

Serie 2:
 9.9 ↗ 10.4 * 10.0 → 10.4 * 10.4 *
 10.1 ↘ 9.9 ↗ 9.1 ← 10.0 ↓ 10.3 *
 beste Teiler 129.7 (14.) 147.3 (15.) 147.7 (12.)
 Trefferlage 0.00 mm , 0.04 mm tief
 Streuwert 1.84, horizontal: 2.00, vertikal: 1.66

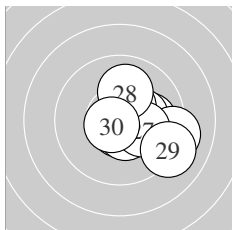

Serie 3:
 10.0 → 10.3 * 10.6 * 9.2 → 10.5 *
 10.4 * 10.2 * 10.0 ↑ 9.1 ↘ 10.7 *
 beste Teiler 74.4 (30.) 77.1 (23.) 112.3 (25.)
 Trefferlage 1.50 mm rechts, 0.27 mm tief
 Streuwert 1.48, horizontal: 1.65, vertikal: 1.29

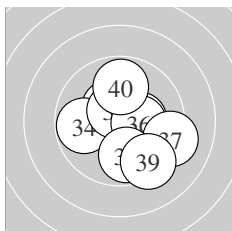

Serie 4:
 10.3 * 10.9 * 10.4 * 9.8 ← 10.6 *
 10.3 * 9.2 → 9.8 ↓ 9.4 ↘ 9.8 ↑
 beste Teiler 24.0 (32.) 94.3 (35.) 136.4 (33.)
 Trefferlage 0.60 mm rechts, 0.34 mm tief
 Streuwert 1.85, horizontal: 1.91, vertikal: 1.79

Unterschrift des Schützen

Meyton Elektronik

Ergebnis: **380** (397.3)
 Serien: 98 97 93 92
 Zähler: 20 20 0 0 0 0 0 0 0 0
 Innenzehner: 13
 weiteste: 455 (19), 453 (25), 444 (34)
 beste Teiler 56.1 (4.) 62.0 (9.) 77.8 (7.)
 Trefferlage 0.32 mm links, 0.39 mm tief
 Streuwert 1.94, horizontal: 2.29, vertikal: 1.51

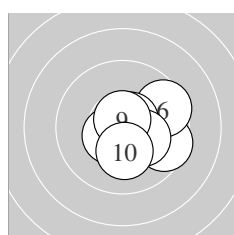
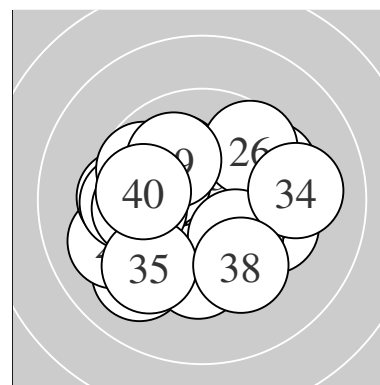

Serie 1:
 10.5 * 10.5 * 10.0 → 10.7 * 9.6 →
 9.5 ↗ 10.6 * 10.3 * 10.7 * 10.2 *
 beste Teiler 56.1 (4.) 62.0 (9.) 77.8 (7.)
 Trefferlage 1.11 mm rechts, 0.28 mm tief
 Streuwert 1.25, horizontal: 1.44, vertikal: 1.03

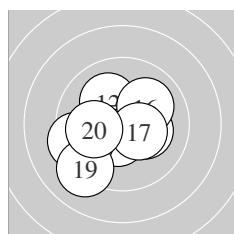

Serie 2:
 10.2 * 10.1 ↖ 10.5 * 10.5 * 9.6 ←
 10.0 ↗ 10.4 * 9.4 ← 9.1 ↙ 10.0 ←
 beste Teiler 110.3 (13.) 114.1 (14.) 139.2 (17.)
 Trefferlage 0.92 mm links, 0.64 mm tief
 Streuwert 1.77, horizontal: 2.03, vertikal: 1.47

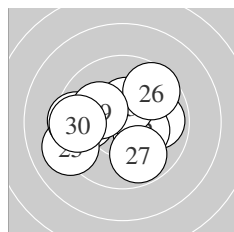

Serie 3:
 9.9 → 10.3 * 10.4 * 9.8 ← 9.1 ←
 9.6 ↗ 9.8 ↘ 9.5 ← 10.1 ↖ 9.5 ←
 beste Teiler 129.4 (23.) 159.4 (22.) 203.9 (29.)
 Trefferlage 0.81 mm links, 0.02 mm tief
 Streuwert 2.14, horizontal: 2.66, vertikal: 1.45

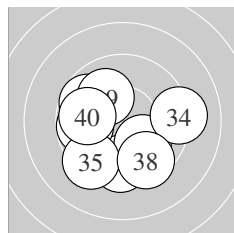

Serie 4:
 9.6 ↓ 9.8 ← 10.0 ↘ 9.2 → 9.4 ↙
 9.9 ↖ 9.7 ↖ 9.5 ↘ 10.0 ↖ 9.8 ←
 beste Teiler 230.8 (39.) 235.7 (33.) 263.4 (36.)
 Trefferlage 0.68 mm links, 0.60 mm tief
 Streuwert 2.30, horizontal: 2.53, vertikal: 2.06

Unterschrift des Schützen

Ergebnis: **385** (399.1)
 Serien: 97 96 95 97
 Zähler: 27 11 2 0 0 0 0 0 0 0
 Innenzehner: 17
 weiteste: 716 (17), 588 (29), 466 (13)
 beste Teiler 14.7 (37.) 68.4 (7.) 71.6 (15.)
 Trefferlage 0.85 mm rechts, 0.29 mm tief
 Streuwert 1.92, horizontal: 2.09, vertikal: 1.72

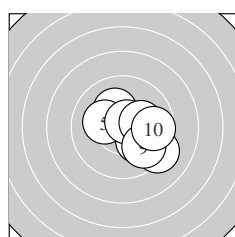
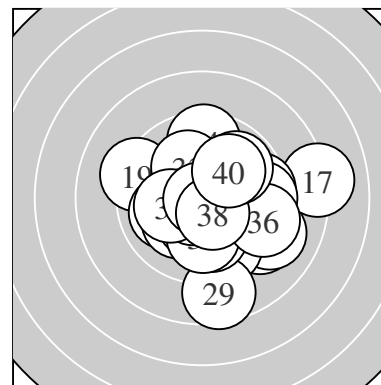

Serie 1:
 10.4 * 10.2 * 10.0 ↘ 9.2 ↘ 10.2 *
 10.1 ↘ 10.7 * 10.2 * 9.8 ↘ 9.7 →
 beste Teiler 68.4 (7.) 131.5 (1.) 190.5 (5.)
 Trefferlage 1.09 mm rechts, 0.32 mm tief
 Streuwert 1.61, horizontal: 1.81, vertikal: 1.39

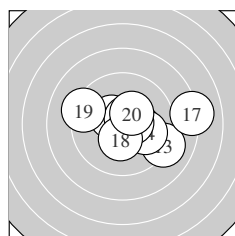

Serie 2:
 10.3 * 10.4 * 9.1 ↘ 10.0 → 10.7 *
 10.6 * 8.1 → 10.3 * 9.3 ← 10.4 *
 beste Teiler 71.6 (15.) 95.0 (16.) 133.1 (12.)
 Trefferlage 1.20 mm rechts, 0.03 mm hoch
 Streuwert 2.27, horizontal: 2.98, vertikal: 1.20

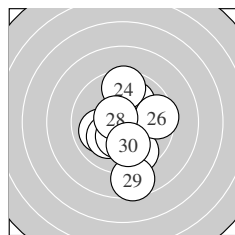

Serie 3:
 10.0 ← 10.1 ↗ 10.1 ↙ 9.6 ↑ 9.6 ↓
 9.5 → 10.3 * 10.6 * 8.6 ↓ 10.0 ↓
 beste Teiler 82.1 (28.) 152.5 (27.) 205.7 (23.)
 Trefferlage 0.27 mm rechts, 0.84 mm tief
 Streuwert 2.19, horizontal: 1.63, vertikal: 2.63

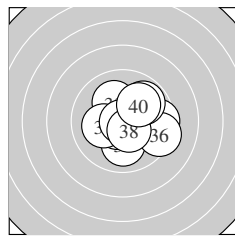

Serie 4:
 10.0 ↓ 9.5 → 10.1 ↖ 10.6 * 10.2 *
 9.4 → 10.9 * 10.5 * 9.8 ↗ 10.0 ↗
 beste Teiler 14.7 (37.) 84.5 (34.) 113.4 (38.)
 Trefferlage 0.83 mm rechts, 0.04 mm tief
 Streuwert 1.68, horizontal: 1.89, vertikal: 1.44

Unterschrift des Schützen

Ergebnis: **365** (381.9)
 Serien: 88 92 92 93
 Zähler: 18 13 6 2 1 0 0 0 0 0
 Innenzehner: 11
 weiteste: 1106 (8), 768 (11), 752 (36)
 beste Teiler 70.7 (26.) 84.0 (17.) 90.6 (20.)
 Trefferlage 0.81 mm links, 0.21 mm hoch
 Streuwert 2.93, horizontal: 3.67, vertikal: 1.94

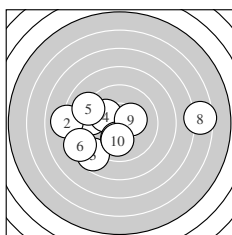
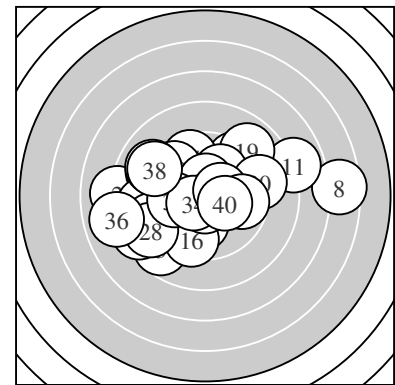

Serie 1:
 9.4 ← 8.1 ← 8.7 ↙ 10.1 ↘ 9.1 ↘
 8.5 ↙ 10.1 ↓ 6.5 → 10.3 * 10.0 ↓
 beste Teiler 160.6 (9.) 209.9 (7.) 215.2 (4.)
 Trefferlage 1.44 mm links, 0.65 mm tief
 Streuwert 3.90, horizontal: 5.12, vertikal: 2.07

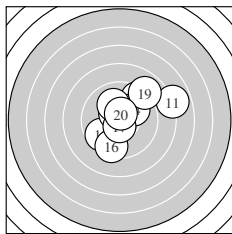

Serie 2:
 7.9 → 9.4 ↗ 9.7 ↙ 10.0 ↗ 10.5 *
 9.5 ↓ 10.6 * 10.1 ↘ 8.9 ↗ 10.6 *
 beste Teiler 84.0 (17.) 90.6 (20.) 109.2 (15.)
 Trefferlage 1.01 mm rechts, 0.82 mm hoch
 Streuwert 2.59, horizontal: 2.84, vertikal: 2.31

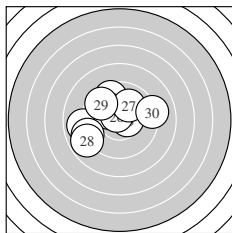

Serie 3:
 8.9 ← 10.3 * 9.0 ↙ 9.6 ↗ 10.5 *
 10.7 * 10.0 ↗ 8.8 ↙ 9.6 ↘ 9.1 →
 beste Teiler 70.7 (26.) 104.0 (25.) 168.9 (22.)
 Trefferlage 1.26 mm links, 0.45 mm hoch
 Streuwert 2.50, horizontal: 3.00, vertikal: 1.88

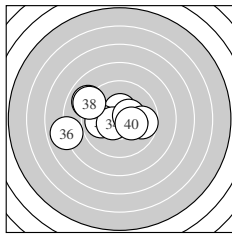

Serie 4:
 10.1 ← 10.5 * 9.9 ← 10.5 * 9.0 ↘
 7.9 ← 10.4 * 9.1 ↘ 9.7 → 10.3 *
 beste Teiler 110.9 (34.) 124.1 (32.) 135.4 (37.)
 Trefferlage 1.54 mm links, 0.23 mm hoch
 Streuwert 2.44, horizontal: 3.17, vertikal: 1.36

Unterschrift des Schützen

Ergebnis: **397** (419.2)
 Serien: 99 100 98 100
 Zähler: 37 3 0 0 0 0 0 0 0 0
 Innenzehner: 32
 weiteste: 414 (28), 295 (2), 282 (29)
 beste Teiler 6.4 (9.) 12.7 (34.) 16.1 (24.)
 Trefferlage 0.18 mm rechts, 0.18 mm hoch
 Streuwert 1.06, horizontal: 1.28, vertikal: 0.78

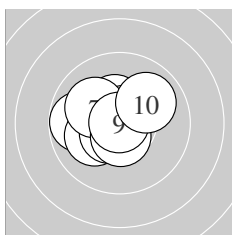
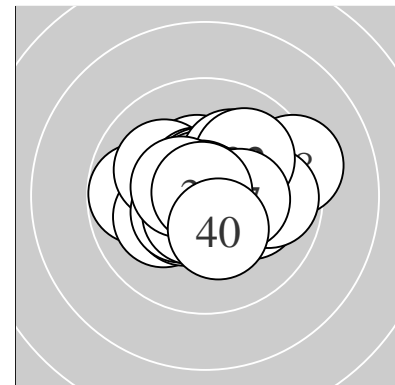

Serie 1:
 10.4 * 9.8 ← 10.1 ↙ 10.5 * 10.7 *
 10.9 * 10.1 ↘ 10.6 * 10.9 * 10.0 ↗
 beste Teiler 6.4 (9.) 16.5 (6.) 72.8 (5.)
 Trefferlage 0.52 mm links, 0.22 mm hoch
 Streuwert 1.18, horizontal: 1.39, vertikal: 0.93

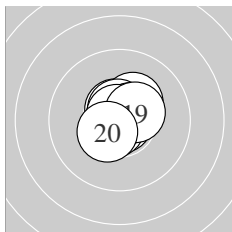

Serie 2:
 10.9 * 10.6 * 10.3 * 10.7 * 10.8 *
 10.6 * 10.6 * 10.8 * 10.4 * 10.5 *
 beste Teiler 24.8 (11.) 36.8 (15.) 45.1 (18.)
 Trefferlage 0.08 mm rechts, 0.28 mm hoch
 Streuwert 0.67, horizontal: 0.68, vertikal: 0.67

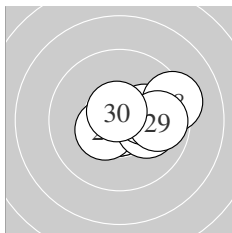

Serie 3:
 10.8 * 10.8 * 10.8 * 10.9 * 10.4 *
 10.1 → 10.2 * 9.3 → 9.8 → 10.7 *
 beste Teiler 16.1 (24.) 31.0 (23.) 42.0 (22.)
 Trefferlage 0.94 mm rechts, 0.03 mm hoch
 Streuwert 1.22, horizontal: 1.60, vertikal: 0.64

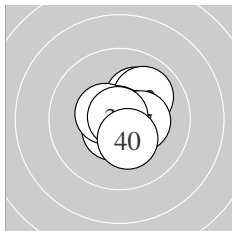

Serie 4:
 10.2 * 10.0 ↗ 10.7 * 10.9 * 10.8 *
 10.6 * 10.3 * 10.5 * 10.9 * 10.3 *
 beste Teiler 12.7 (34.) 21.2 (39.) 27.8 (35.)
 Trefferlage 0.24 mm rechts, 0.18 mm hoch
 Streuwert 0.96, horizontal: 0.98, vertikal: 0.95

Unterschrift des Schützen

Ergebnis: **393** (412.9)
 Serien: 97 100 98 98
 Zähler: 33 7 0 0 0 0 0 0 0 0
 Innenzehner: 28
 weiteste: 385 (24), 376 (2), 368 (27)
 beste Teiler 19.4 (35.) 23.7 (1.) 28.0 (18.)
 Trefferlage 0.16 mm links, 0.43 mm hoch
 Streuwert 1.30, horizontal: 1.55, vertikal: 0.99

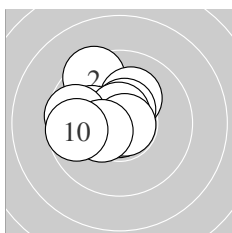
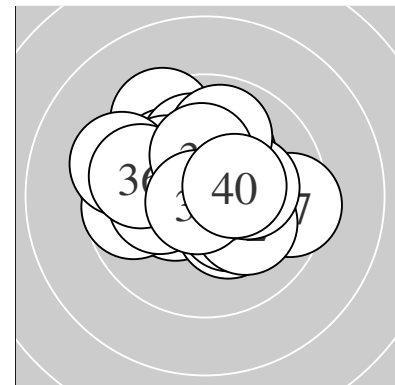

Serie 1:
 10.9 * 9.4 ↖ 10.2 * 10.5 * 10.1 ↖
 10.7 * 10.8 * 9.7 ← 10.4 * 9.7 ←
 beste Teiler 23.7 (1.) 37.9 (7.) 70.2 (6.)
 Trefferlage 0.99 mm links, 0.63 mm hoch
 Streuwert 1.33, horizontal: 1.47, vertikal: 1.18

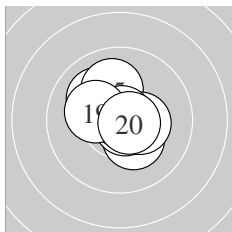

Serie 2:
 10.1 ↖ 10.3 * 10.6 * 10.4 * 10.1 ↖
 10.7 * 10.4 * 10.8 * 10.2 * 10.7 *
 beste Teiler 28.0 (18.) 51.2 (16.) 71.8 (20.)
 Trefferlage 0.10 mm links, 0.45 mm hoch
 Streuwert 1.04, horizontal: 1.05, vertikal: 1.03

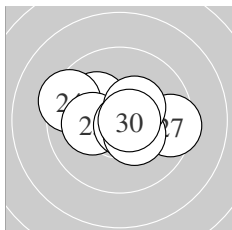

Serie 3:
 10.5 * 10.8 * 10.1 ↖ 9.4 ↖ 10.2 *
 10.7 * 9.5 → 10.4 * 10.4 * 10.7 *
 beste Teiler 48.0 (22.) 53.0 (26.) 70.0 (30.)
 Trefferlage 0.12 mm rechts, 0.12 mm hoch
 Streuwert 1.54, horizontal: 2.03, vertikal: 0.79

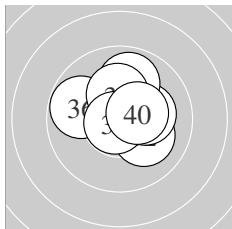

Serie 4:
 10.5 * 10.1 ↖ 10.2 * 10.7 * 10.9 *
 9.8 ← 9.9 ↑ 10.2 * 10.8 * 10.4 *
 beste Teiler 19.4 (35.) 42.6 (39.) 67.4 (34.)
 Trefferlage 0.30 mm rechts, 0.53 mm hoch
 Streuwert 1.21, horizontal: 1.36, vertikal: 1.03

Unterschrift des Schützen

Meyton Elektronik

Ergebnis: **389** (405.0)
 Serien: 98 97 97 97
 Zähler: 29 11 0 0 0 0 0 0 0 0
 Innenzehner: 20
 weiteste: 437 (35), 434 (5), 395 (23)
 beste Teiler 30.8 (4.) 65.1 (9.) 77.8 (36.)
 Trefferlage 0.37 mm links, 0.66 mm tief
 Streuwert 1.53, horizontal: 1.62, vertikal: 1.45

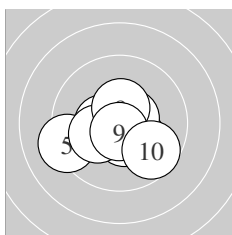
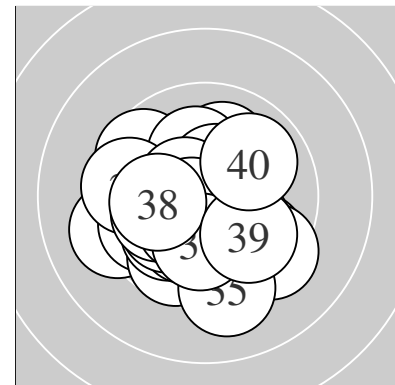

Serie 1:
 10.2 * 10.4 * 10.5 * 10.8 * 9.2 ←
 10.2 * 10.6 * 10.5 * 10.7 * 9.7 ↘
 beste Teiler 30.8 (4.) 65.1 (9.) 89.9 (7.)
 Trefferlage 0.22 mm links, 0.60 mm tief
 Streuwert 1.44, horizontal: 1.79, vertikal: 0.96

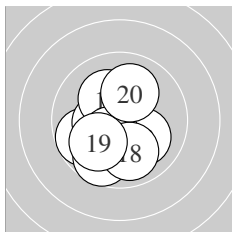

Serie 2:
 9.7 ← 10.5 * 10.1 ↘ 9.7 ↓ 10.4 *
 10.2 * 10.4 * 9.9 ↓ 10.0 ✓ 10.1 ↑
 beste Teiler 109.6 (12.) 139.4 (17.) 144.1 (15.)
 Trefferlage 0.63 mm links, 0.64 mm tief
 Streuwert 1.52, horizontal: 1.34, vertikal: 1.68

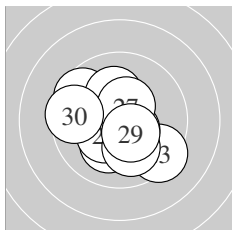

Serie 3:
 9.6 ↘ 10.2 * 9.4 ↘ 10.5 * 10.1 ↓
 10.3 * 10.5 * 10.0 ↓ 10.4 * 9.5 ←
 beste Teiler 114.7 (24.) 120.3 (27.) 131.1 (29.)
 Trefferlage 0.26 mm links, 0.40 mm tief
 Streuwert 1.78, horizontal: 1.93, vertikal: 1.62

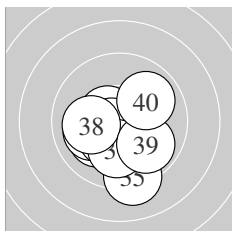

Serie 4:
 10.1 ✓ 10.0 ← 10.5 * 10.3 * 9.2 ↓
 10.6 * 10.1 ↓ 10.1 ← 9.9 ↘ 9.9 ↗
 beste Teiler 77.8 (36.) 104.2 (33.) 157.2 (34.)
 Trefferlage 0.36 mm links, 1.02 mm tief
 Streuwert 1.57, horizontal: 1.57, vertikal: 1.57

Unterschrift des Schützen

LG Liga – Wertung – offene Klasse

StartNr: 60

StandNr: 122

12. Januar 2019 17:45

Bauhofer, Markus #77

Walchsee / Walchsee

Ergebnis: **382** (403.5)
 Serien: 96 98 93 95
 Zähler: 22 18 0 0 0 0 0 0 0
 Innenzehner: 17
 weiteste: 493 (32), 436 (31), 310 (34)
 beste Teiler 11.0 (39.) 12.0 (26.) 70.3 (35.)
 Trefferlage 0.00 mm , 0.14 mm tief
 Streuwert 1.70, horizontal: 1.94, vertikal: 1.42

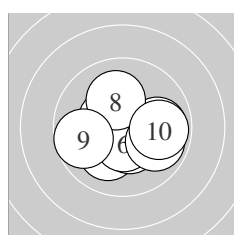
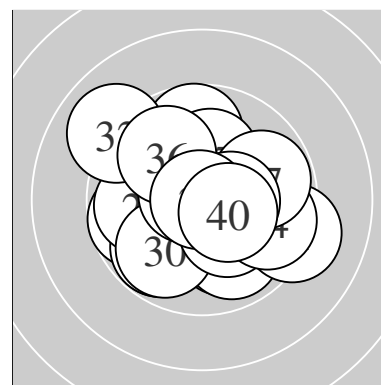

Serie 1:
 10.5 * 10.1 ↙ 10.4 * 10.4 * 9.9 →
 10.5 * 9.9 → 10.1 ↑ 9.7 ← 9.9 →
 beste Teiler 113.3 (6.) 124.3 (1.) 138.7 (3.)
 Trefferlage 0.39 mm rechts, 0.43 mm tief
 Streuwert 1.55, horizontal: 1.89, vertikal: 1.11

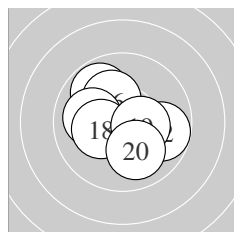

Serie 2:
 10.2 * 9.8 → 9.8 ↘ 10.7 * 10.5 *
 10.2 * 10.0 ← 10.3 * 10.4 * 10.0 ↓
 beste Teiler 75.4 (14.) 104.8 (15.) 139.0 (19.)
 Trefferlage 0.44 mm links, 0.17 mm hoch
 Streuwert 1.47, horizontal: 1.67, vertikal: 1.23

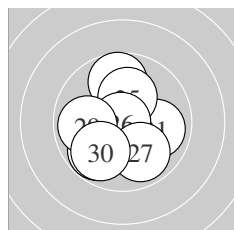

Serie 3:
 9.9 → 10.0 ← 9.8 ↙ 9.7 ↑ 10.2 *
 10.9 * 9.9 ↘ 9.8 ↙ 9.9 ← 9.8 ↙
 beste Teiler 12.0 (26.) 193.5 (25.) 229.1 (22.)
 Trefferlage 0.67 mm links, 0.49 mm tief
 Streuwert 1.77, horizontal: 1.71, vertikal: 1.83

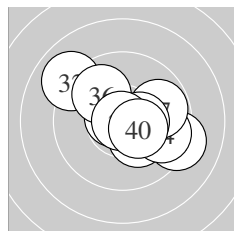

Serie 4:
 9.2 → 9.0 ↘ 10.3 * 9.7 → 10.7 *
 9.9 ↘ 9.8 → 10.4 * 10.9 * 10.4 *
 beste Teiler 11.0 (39.) 70.3 (35.) 130.0 (38.)
 Trefferlage 0.71 mm rechts, 0.19 mm hoch
 Streuwert 1.96, horizontal: 2.37, vertikal: 1.45

Unterschrift des Schützen

Meyton Elektronik

Ergebnis: **376** (395.8)
 Serien: 93 95 93 95
 Zähler: 17 22 1 0 0 0 0 0 0 0
 Innenzehner: 13
 weiteste: 569 (23), 462 (13), 428 (24)
 beste Teiler 88.6 (6.) 89.8 (7.) 114.0 (25.)
 Trefferlage 0.02 mm rechts, 1.01 mm hoch
 Streuwert 1.92, horizontal: 2.38, vertikal: 1.31

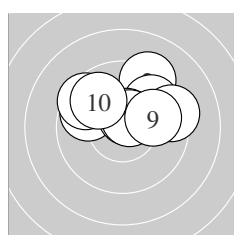
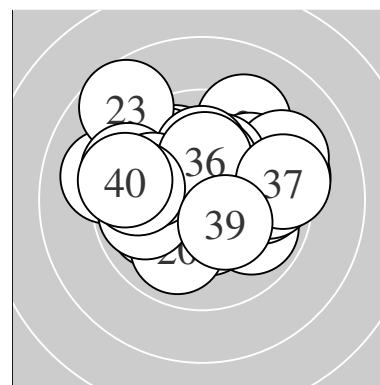

Serie 1:
 10.1 ↗ 9.3 ↗ 9.8 ↗ 9.8 ↖ 9.5 ↖
 10.6 * 10.6 * 9.3 → 9.9 → 9.8 ↖
 beste Teiler 88.6 (6.) 89.8 (7.) 208.7 (1.)
 Trefferlage 0.51 mm rechts, 1.59 mm hoch
 Streuwert 1.77, horizontal: 2.33, vertikal: 0.92

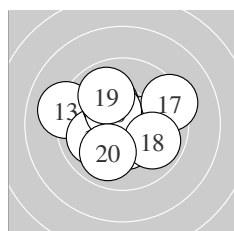

Serie 2:
 10.4 * 10.4 * 9.1 ↖ 10.0 ↖ 10.2 *
 10.5 * 9.3 → 9.9 ↘ 9.9 ↖ 9.9 ↙
 beste Teiler 125.8 (16.) 137.8 (12.) 148.1 (11.)
 Trefferlage 0.30 mm links, 0.17 mm hoch
 Streuwert 2.00, horizontal: 2.36, vertikal: 1.56

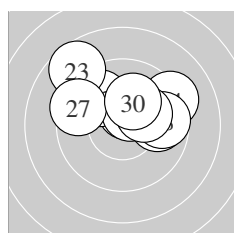

Serie 3:
 10.5 * 9.8 ↖ 8.7 ↖ 9.2 ↗ 10.5 *
 9.8 → 9.4 ↖ 9.7 → 10.2 * 10.1 ↗
 beste Teiler 114.0 (25.) 114.4 (21.) 191.8 (29.)
 Trefferlage 0.41 mm rechts, 1.53 mm hoch
 Streuwert 2.05, horizontal: 2.63, vertikal: 1.21

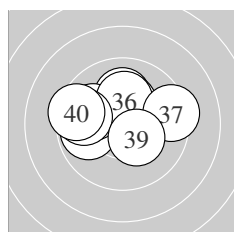

Serie 4:
 10.5 * 9.8 ← 10.1 ↑ 10.3 * 9.9 ↖
 10.2 * 9.4 → 9.7 ← 10.3 * 9.4 ←
 beste Teiler 117.0 (31.) 153.4 (39.) 173.6 (34.)
 Trefferlage 0.50 mm links, 0.75 mm hoch
 Streuwert 1.84, horizontal: 2.37, vertikal: 1.06

Unterschrift des Schützen

Meyton Elektronik

Ergebnis: **378** (396.7)
 Serien: 94 93 95 96
 Zähler: 21 16 3 0 0 0 0 0 0 0
 Innenzehner: 15
 weiteste: 633 (6), 601 (18), 506 (34)
 beste Teiler 18.1 (19.) 61.0 (15.) 74.4 (39.)
 Trefferlage 0.25 mm rechts, 0.13 mm tief
 Streuwert 2.13, horizontal: 2.18, vertikal: 2.07

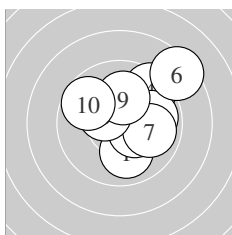
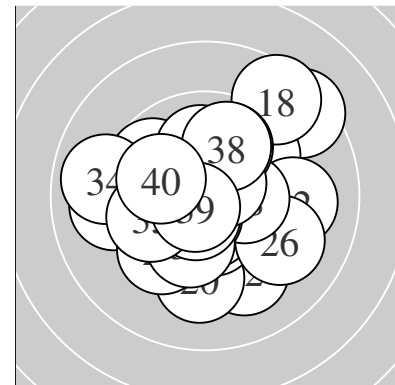

Serie 1:
 10.0 ↓ 10.6 * 10.4 * 9.4 ↗ 9.9 →
 8.4 ↗ 9.9 → 10.4 * 10.1 ↑ 9.7 ↘
 beste Teiler 77.6 (2.) 142.2 (3.) 145.4 (8.)
 Trefferlage 1.04 mm rechts, 0.90 mm hoch
 Streuwert 2.03, horizontal: 2.17, vertikal: 1.88

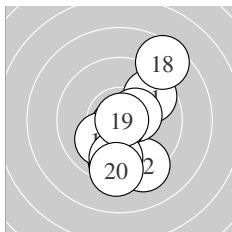

Serie 2:
 9.7 ↗ 9.3 ↓ 9.6 ↓ 10.4 * 10.7 *
 10.1 ↗ 9.7 ↓ 8.5 ↗ 10.9 * 9.3 ↓
 beste Teiler 18.1 (19.) 61.0 (15.) 136.9 (14.)
 Trefferlage 0.68 mm rechts, 0.92 mm tief
 Streuwert 2.32, horizontal: 1.59, vertikal: 2.87

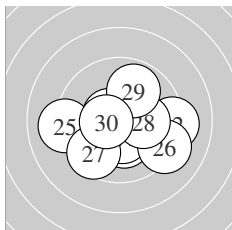

Serie 3:
 10.2 * 9.2 → 10.6 * 10.4 * 9.1 ←
 9.2 ↘ 9.6 ↗ 10.2 * 9.9 ↗ 10.5 *
 beste Teiler 94.8 (23.) 112.8 (30.) 141.2 (24.)
 Trefferlage 0.32 mm rechts, 0.62 mm tief
 Streuwert 2.18, horizontal: 2.70, vertikal: 1.48

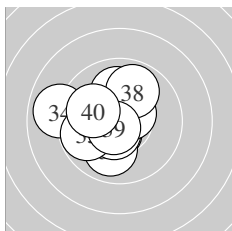

Serie 4:
 10.5 * 10.0 ↓ 10.5 * 8.9 ← 9.8 ←
 10.0 ↑ 10.5 * 9.9 ↗ 10.7 * 10.0 ↘
 beste Teiler 74.4 (39.) 104.8 (37.) 107.5 (31.)
 Trefferlage 1.03 mm links, 0.11 mm hoch
 Streuwert 1.69, horizontal: 1.81, vertikal: 1.57

Unterschrift des Schützen

Meyton Elektronik

Ergebnis: **369** (385.1)
 Serien: 92 92 90 95
 Zähler: 14 22 3 1 0 0 0 0 0 0
 Innenzehner: 6
 weiteste: 774 (21), 557 (16), 532 (28)
 beste Teiler 104.0 (6.) 122.6 (40.) 135.3 (8.)
 Trefferlage 0.04 mm rechts, 0.39 mm tief
 Streuwert 2.56, horizontal: 3.04, vertikal: 1.96

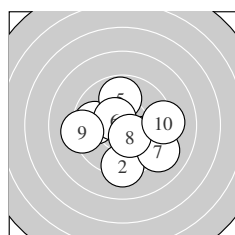
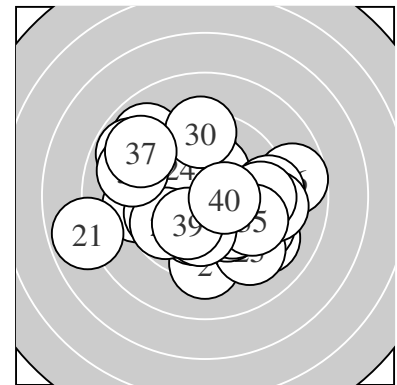

Serie 1:
 9.8 ↘ 9.3 ↓ 9.6 ↘ 9.8 ← 9.8 ↑
 10.5 * 9.1 ↘ 10.4 * 9.2 ← 9.2 →
 beste Teiler 104.0 (6.) 135.3 (8.) 280.1 (5.)
 Trefferlage 0.61 mm rechts, 0.73 mm tief
 Streuwert 2.42, horizontal: 2.83, vertikal: 1.91

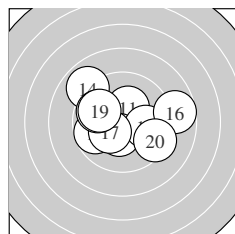

Serie 2:
 10.3 * 10.4 * 9.7 ← 8.9 ↘ 10.0 →
 8.7 → 10.3 * 9.8 ↙ 9.9 ↘ 9.4 ↘
 beste Teiler 138.7 (12.) 162.9 (11.) 167.0 (17.)
 Trefferlage 0.13 mm links, 0.26 mm hoch
 Streuwert 2.47, horizontal: 3.05, vertikal: 1.70

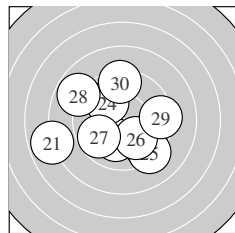

Serie 3:
 7.9 ← 9.4 ↘ 10.1 ↓ 10.0 ↘ 9.2 ↘
 10.0 ↘ 9.7 ← 8.8 ↙ 9.3 → 9.4 ↑
 beste Teiler 221.0 (23.) 234.4 (26.) 242.4 (24.)
 Trefferlage 0.62 mm links, 0.56 mm tief
 Streuwert 3.11, horizontal: 3.56, vertikal: 2.58

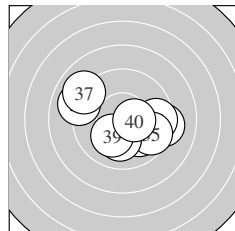

Serie 4:
 9.0 ↙ 10.0 ↘ 9.2 → 9.6 → 9.6 ↘
 10.1 ↓ 9.0 ↙ 10.1 ↓ 10.1 ↓ 10.5 *
 beste Teiler 122.6 (40.) 201.8 (36.) 204.4 (39.)
 Trefferlage 0.34 mm rechts, 0.55 mm tief
 Streuwert 2.42, horizontal: 3.00, vertikal: 1.65

Unterschrift des Schützen

Meyton Elektronik

Ergebnis: **361** (381.2)
 Serien: 88 90 95 88
 Zähler: 11 21 7 0 1 0 0 0 0 0
 Innenzehner: 8
 weiteste: 1027 (34), 703 (36), 635 (1)
 beste Teiler 57.0 (4.) 98.0 (14.) 126.5 (23.)
 Trefferlage 0.16 mm rechts, 0.35 mm tief
 Streuwert 2.85, horizontal: 3.09, vertikal: 2.57

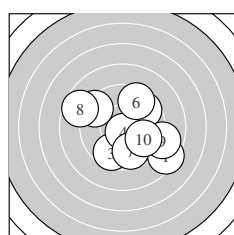
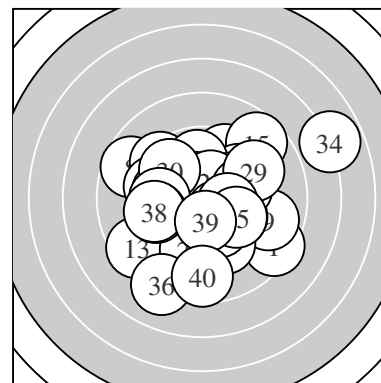

Serie 1:
 8.4 ↘ 9.6 ↗ 9.6 ↓ 10.7 * 9.3 ↖
 9.5 ↗ 9.7 ↓ 8.7 ↖ 8.9 → 9.8 ↘
 beste Teiler 57.0 (4.) 290.3 (10.) 306.7 (7.)
 Trefferlage 0.80 mm rechts, 0.31 mm tief
 Streuwert 3.00, horizontal: 3.38, vertikal: 2.55

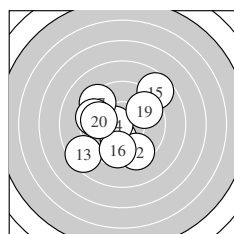

Serie 2:
 10.2 * 9.5 ↓ 8.5 ↖ 10.6 * 8.7 ↗
 9.7 ↓ 9.3 ↖ 9.5 ← 9.7 ↗ 9.8 ←
 beste Teiler 98.0 (14.) 182.2 (11.) 294.9 (20.)
 Trefferlage 0.80 mm links, 0.21 mm tief
 Streuwert 2.78, horizontal: 2.88, vertikal: 2.67

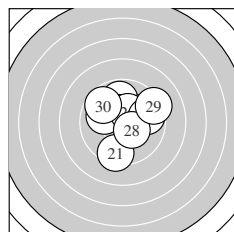

Serie 3:
 9.4 ↓ 9.8 ↑ 10.4 * 10.0 → 10.0 ↖
 10.4 * 9.7 → 10.4 * 9.2 → 9.7 ↖
 beste Teiler 126.5 (23.) 140.4 (26.) 148.2 (28.)
 Trefferlage 0.42 mm rechts, 0.70 mm hoch
 Streuwert 1.98, horizontal: 2.09, vertikal: 1.87

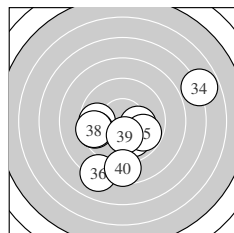

Serie 4:
 10.2 * 10.0 ↓ 9.7 ← 6.8 → 9.8 ↘
 8.1 ↓ 9.5 ← 9.5 ← 10.3 * 8.6 ↓
 beste Teiler 173.8 (39.) 192.6 (31.) 247.3 (32.)
 Trefferlage 0.23 mm rechts, 1.58 mm tief
 Streuwert 3.49, horizontal: 3.97, vertikal: 2.94

Unterschrift des Schützen

Meyton Elektronik

Ergebnis: **390** (409.2)
 Serien: 96 99 99 96
 Zähler: 30 10 0 0 0 0 0 0 0 0
 Innenzehner: 24
 weiteste: 372 (5), 357 (38), 325 (10)
 beste Teiler 41.3 (21.) 45.3 (34.) 48.2 (29.)
 Trefferlage 0.62 mm rechts, 0.14 mm tief
 Streuwert 1.37, horizontal: 1.51, vertikal: 1.22

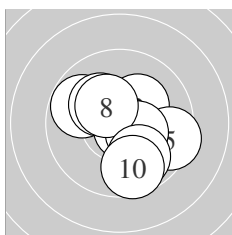
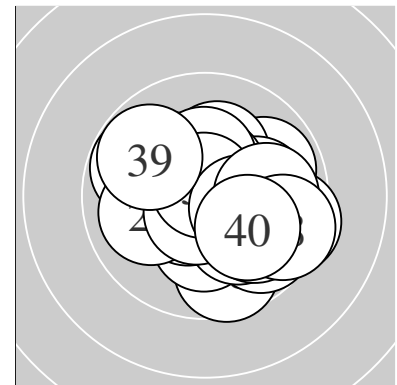

Serie 1:
 10.6 * 10.2 * 9.8 ↖ 10.2 * 9.5 ↘
 10.7 * 10.4 * 10.3 * 9.9 ↘ 9.7 ↘
 beste Teiler 55.1 (6.) 82.6 (1.) 138.7 (7.)
 Trefferlage 0.40 mm rechts, 0.18 mm tief
 Streuwert 1.68, horizontal: 1.73, vertikal: 1.62

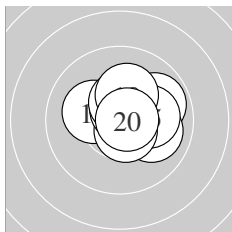

Serie 2:
 9.9 → 10.3 * 10.2 * 10.0 → 10.1 →
 10.6 * 10.7 * 10.5 * 10.2 * 10.7 *
 beste Teiler 53.1 (20.) 73.1 (17.) 86.4 (16.)
 Trefferlage 0.82 mm rechts, 0.38 mm hoch
 Streuwert 1.12, horizontal: 1.32, vertikal: 0.87

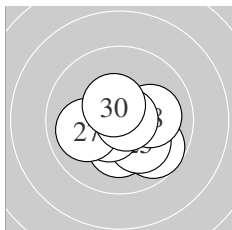

Serie 3:
 10.8 * 10.3 * 9.7 ↘ 10.2 * 10.1 ↘
 10.5 * 10.0 ← 10.1 → 10.8 * 10.5 *
 beste Teiler 41.3 (21.) 48.2 (29.) 102.5 (26.)
 Trefferlage 0.38 mm rechts, 0.70 mm tief
 Streuwert 1.21, horizontal: 1.41, vertikal: 0.97

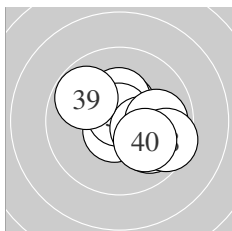

Serie 4:
 10.5 * 10.6 * 10.3 * 10.8 * 10.3 *
 9.9 → 9.9 ↘ 9.5 → 9.8 ↖ 10.1 ↘
 beste Teiler 45.3 (34.) 77.4 (32.) 112.5 (31.)
 Trefferlage 0.89 mm rechts, 0.06 mm tief
 Streuwert 1.47, horizontal: 1.70, vertikal: 1.20

Unterschrift des Schützen

Meyton Elektronik

Ergebnis: **385** (405.1)
 Serien: 94 95 98 98
 Zähler: 26 13 1 0 0 0 0 0 0 0
 Innenzehner: 22
 weiteste: 706 (4), 478 (2), 401 (1)
 beste Teiler 34.4 (21.) 44.7 (39.) 56.7 (16.)
 Trefferlage 0.39 mm links, 0.73 mm tief
 Streuwert 1.67, horizontal: 1.99, vertikal: 1.28

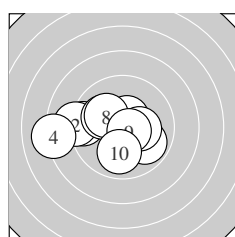
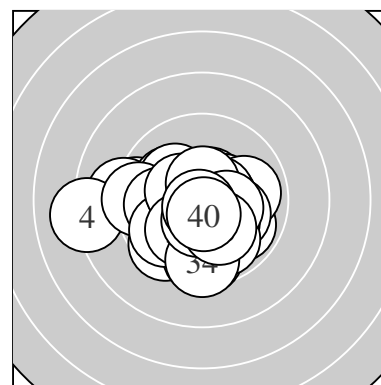

Serie 1:
 9.3 ← 9.0 ← 10.1 ↘ 8.1 ← 9.9 ↘
 10.5 * 10.3 * 10.1 ↘ 10.7 * 9.9 ↓
 beste Teiler 75.6 (9.) 104.6 (6.) 170.8 (7.)
 Trefferlage 1.46 mm links, 0.16 mm tief
 Streuwert 2.29, horizontal: 3.01, vertikal: 1.19

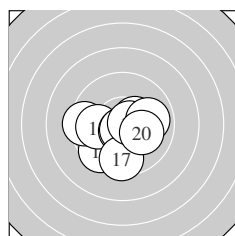

Serie 2:
 9.6 ↙ 9.4 ← 9.9 ← 10.4 * 10.7 *
 10.7 * 9.6 ↓ 10.7 * 9.9 → 10.1 ↘
 beste Teiler 56.7 (16.) 69.9 (15.) 71.8 (18.)
 Trefferlage 0.25 mm links, 0.73 mm tief
 Streuwert 1.73, horizontal: 2.05, vertikal: 1.33

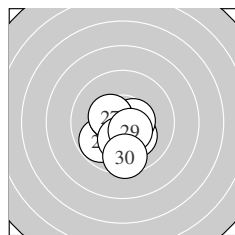

Serie 3:
 10.8 * 9.8 ↙ 10.2 * 10.5 * 10.4 *
 10.7 * 10.4 * 10.3 * 10.5 * 9.6 ↓
 beste Teiler 34.4 (21.) 72.4 (26.) 107.7 (24.)
 Trefferlage 0.19 mm links, 0.90 mm tief
 Streuwert 1.17, horizontal: 1.10, vertikal: 1.24

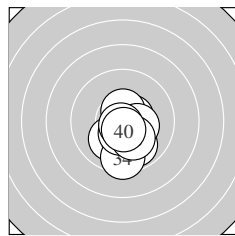

Serie 4:
 10.6 * 9.9 ↘ 10.1 ↙ 9.5 ↓ 10.5 *
 10.5 * 10.3 * 10.2 * 10.8 * 10.6 *
 beste Teiler 44.7 (39.) 87.5 (40.) 99.4 (31.)
 Trefferlage 0.32 mm rechts, 1.11 mm tief
 Streuwert 1.13, horizontal: 0.84, vertikal: 1.36

Unterschrift des Schützen

Meyton Elektronik

Ergebnis:	387	(405.6)
Serien:	95 98 96 98	
Zähler:	27 13 0 0 0 0 0 0 0 0	
Innenzehner:	22	
weiteste:	465 (34), 442 (6), 375 (38)	
beste Teiler	40.7 (23.) 56.6 (24.) 79.0 (20.)	
Trefferlage	0.30 mm rechts, 0.15 mm hoch	
Streuwert	1.62, horizontal: 1.94, vertikal: 1.22	

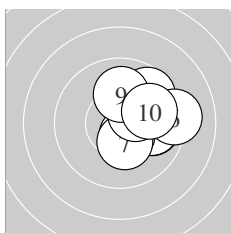
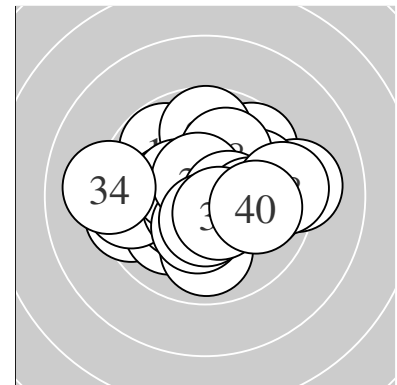

Serie 1:				
9.9 →	9.7 ↗	10.2 *	9.9 →	10.5 *
9.2 →	10.3 *	10.4 *	10.0 ↑	9.9 →
beste Teiler	111.2 (5.)	149.3 (8.)	155.7 (7.)	
Trefferlage	1.85 mm rechts, 0.33 mm hoch			
Streuwert	1.28, horizontal: 1.29, vertikal: 1.27			

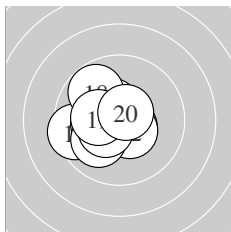

Serie 2:				
10.6 *	10.5 *	9.5 ←	10.3 *	10.4 *
10.0 ↙	10.4 *	9.8 ↘	10.3 *	10.6 *
beste Teiler	79.0 (20.)	96.8 (11.)	118.1 (12.)	
Trefferlage	1.02 mm links, 0.07 mm tief			
Streuwert	1.28, horizontal: 1.40, vertikal: 1.14			

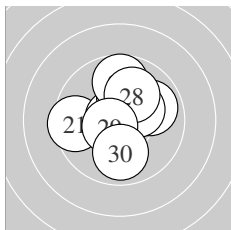

Serie 3:				
9.5 ←	9.9 →	10.8 *	10.7 *	10.3 *
10.2 *	9.7 ↑	10.1 ↑	10.6 *	9.9 ↓
beste Teiler	40.7 (23.)	56.6 (24.)	92.9 (29.)	
Trefferlage	0.03 mm rechts, 0.60 mm hoch			
Streuwert	1.58, horizontal: 1.59, vertikal: 1.57			

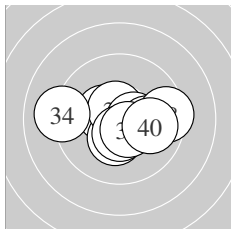

Serie 4:				
10.4 *	10.3 *	10.6 *	9.1 ←	10.5 *
10.1 →	10.5 *	9.5 →	10.5 *	10.0 →
beste Teiler	87.8 (33.)	107.4 (39.)	113.2 (35.)	
Trefferlage	0.36 mm rechts, 0.24 mm tief			
Streuwert	1.73, horizontal: 2.32, vertikal: 0.77			

Unterschrift des Schützen

Ergebnis: **388** (409.3)
 Serien: 97 98 96 97
 Zähler: 28 12 0 0 0 0 0 0 0 0
 Innenzehner: 25
 weiteste: 488 (20), 344 (31), 338 (39)
 beste Teiler 8.5 (23.) 10.0 (34.) 51.0 (19.)
 Trefferlage 0.15 mm links, 0.07 mm hoch
 Streuwert 1.49, horizontal: 1.54, vertikal: 1.42

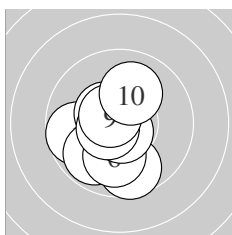
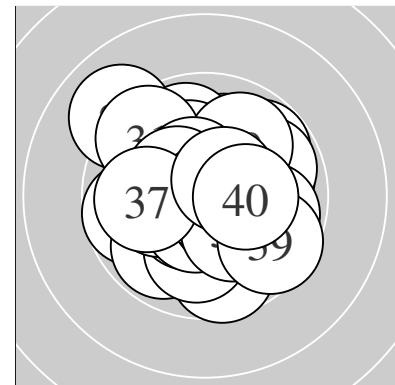

Serie 1:
 9.7 ← 10.4 * 9.8 ↘ 9.7 ↓ 10.5 *
 10.0 ↓ 10.7 * 10.6 * 10.6 * 10.1 ↑
 beste Teiler 61.8 (7.) 84.6 (9.) 91.0 (8.)
 Trefferlage 0.63 mm links, 0.72 mm tief
 Streuwert 1.38, horizontal: 1.14, vertikal: 1.58

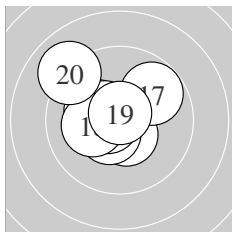

Serie 2:
 10.5 * 10.5 * 10.5 * 10.2 * 10.6 *
 10.5 * 9.8 ↗ 10.2 * 10.7 * 9.0 ↖
 beste Teiler 51.0 (19.) 85.0 (15.) 112.7 (11.)
 Trefferlage 0.80 mm links, 0.41 mm hoch
 Streuwert 1.45, horizontal: 1.55, vertikal: 1.34

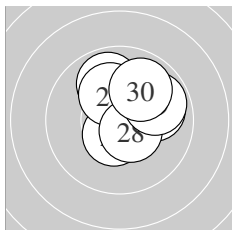

Serie 3:
 10.6 * 9.9 ↖ 10.9 * 10.7 * 9.9 →
 10.5 * 10.2 * 10.5 * 9.8 → 9.9 ↑
 beste Teiler 8.5 (23.) 57.6 (24.) 97.7 (21.)
 Trefferlage 0.55 mm rechts, 0.54 mm hoch
 Streuwert 1.29, horizontal: 1.23, vertikal: 1.34

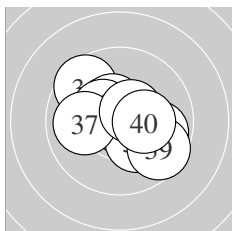

Serie 4:
 9.6 ↖ 10.5 * 10.4 * 10.9 * 10.2 *
 9.8 → 10.0 ← 10.5 * 9.6 ↘ 10.3 *
 beste Teiler 10.0 (34.) 106.4 (38.) 122.1 (32.)
 Trefferlage 0.26 mm rechts, 0.05 mm hoch
 Streuwert 1.62, horizontal: 1.91, vertikal: 1.27

Unterschrift des Schützen

Meyton Elektronik

Ergebnis:	373	(393.8)
Serien:	93	92 95 93
Zähler:	16 22 1 1 0 0 0 0 0 0	
Innenzehner:	14	
weiteste:	763 (9), 695 (35), 491 (38)	
beste Teiler	42.2 (4.) 85.4 (34.) 99.4 (17.)	
Trefferlage	0.18 mm links, 0.15 mm hoch	
Streuwert	2.25, horizontal: 2.77, vertikal: 1.56	

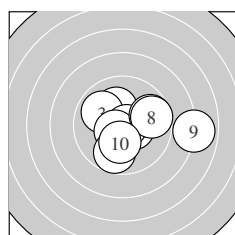
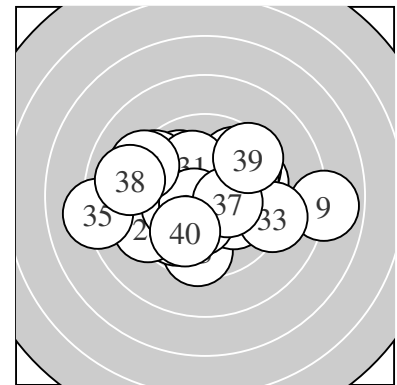

Serie 1:	10.2 *	10.5 *	9.9 ↘	10.8 *	10.5 *
	9.7 ↓	9.7 →	9.7 →	7.9 →	10.2 *
beste Teiler	42.2 (4.) 101.8 (5.) 120.1 (2.)				
Trefferlage	1.04 mm rechts, 0.12 mm tief				
Streuwert	2.27, horizontal: 2.86, vertikal: 1.47				

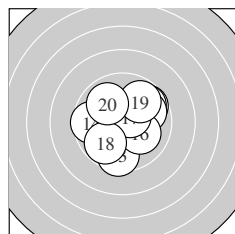

Serie 2:	9.7 ↗	9.8 ↗	9.5 ↓	9.6 ←	9.9 →
	10.1 ↘	10.6 *	9.8 ↙	9.8 ↗	9.9 ↘
beste Teiler	99.4 (17.) 218.8 (16.) 254.2 (20.)				
Trefferlage	0.47 mm rechts, 0.23 mm hoch				
Streuwert	2.05, horizontal: 2.14, vertikal: 1.96				

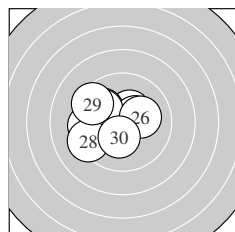

Serie 3:	10.5 *	10.4 *	9.9 ↘	10.4 *	9.9 ↘
	10.2 *	9.5 ←	9.3 ↙	9.4 ↘	10.3 *
beste Teiler	113.6 (21.) 139.8 (22.) 144.6 (24.)				
Trefferlage	1.07 mm links, 0.39 mm hoch				
Streuwert	1.77, horizontal: 2.14, vertikal: 1.32				

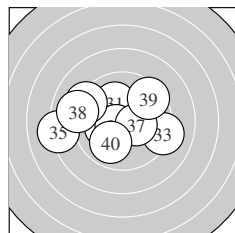

Serie 4:	10.1 ↖	10.2 *	9.1 →	10.6 *	8.2 ←
	9.2 ↘	10.4 *	9.0 ←	9.5 ↗	9.9 ↙
beste Teiler	85.4 (34.) 149.4 (37.) 194.8 (32.)				
Trefferlage	1.16 mm links, 0.10 mm hoch				
Streuwert	2.68, horizontal: 3.44, vertikal: 1.61				

Unterschrift des Schützen

Ergebnis: **376** (396.2)
 Serien: 95 95 90 96
 Zähler: 19 18 3 0 0 0 0 0 0 0
 Innenzehner: 14
 weiteste: 675 (28), 645 (4), 537 (23)
 beste Teiler 31.2 (39.) 39.1 (8.) 44.9 (12.)
 Trefferlage 0.13 mm rechts, 0.67 mm hoch
 Streuwert 2.14, horizontal: 2.31, vertikal: 1.95

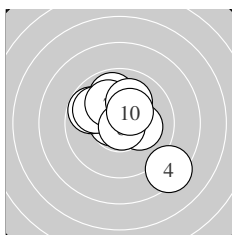
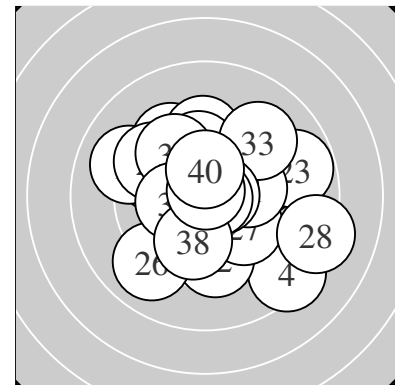

Serie 1:
 10.7 * 10.2 * 9.9 ↑ 8.4 ↘ 9.8 ↖
 9.9 ↖ 10.1 ↖ 10.8 * 10.1 ↑ 10.4 *
 beste Teiler 39.1 (8.) 73.2 (1.) 147.2 (10.)
 Trefferlage 0.12 mm rechts, 0.51 mm hoch
 Streuwert 2.09, horizontal: 2.17, vertikal: 2.00

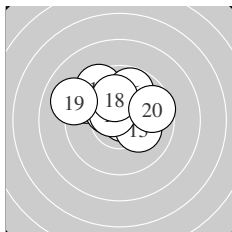

Serie 2:
 9.5 ↖ 10.8 * 10.2 * 9.5 ↖ 10.4 *
 9.8 ↑ 10.6 * 10.1 ↑ 9.1 ↖ 9.6 →
 beste Teiler 44.9 (12.) 95.4 (17.) 140.4 (15.)
 Trefferlage 0.53 mm links, 1.37 mm hoch
 Streuwert 1.81, horizontal: 2.26, vertikal: 1.21

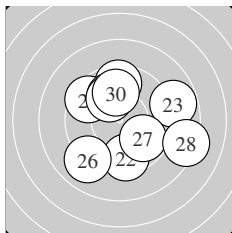

Serie 3:
 9.5 ↖ 9.5 ↓ 8.8 → 9.5 ↑ 10.0 ↑
 9.0 ↙ 9.8 ↘ 8.3 → 10.0 ↖ 9.9 ↑
 beste Teiler 229.0 (29.) 247.9 (25.) 266.5 (30.)
 Trefferlage 0.59 mm rechts, 0.28 mm hoch
 Streuwert 2.97, horizontal: 3.15, vertikal: 2.78

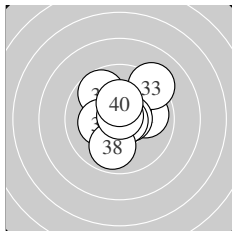

Serie 4:
 9.9 → 10.6 * 9.2 ↗ 9.7 ↖ 10.2 *
 10.6 * 10.8 * 9.9 ↓ 10.8 * 10.3 *
 beste Teiler 31.2 (39.) 50.6 (37.) 89.0 (36.)
 Trefferlage 0.35 mm rechts, 0.54 mm hoch
 Streuwert 1.59, horizontal: 1.58, vertikal: 1.59

Unterschrift des Schützen

Meyton Elektronik

Ergebnis: **373** (392.2)
 Serien: 94 97 92 90
 Zähler: 16 21 3 0 0 0 0 0 0 0
 Innenzehner: 12
 weiteste: 622 (22), 585 (40), 542 (27)
 beste Teiler 55.0 (20.) 70.5 (24.) 90.2 (10.)
 Trefferlage 0.01 mm links, 0.44 mm tief
 Streuwert 2.26, horizontal: 2.89, vertikal: 1.38

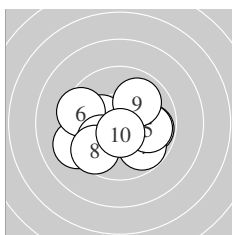
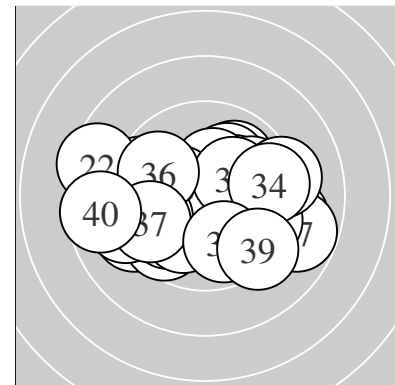

Serie 1:
 9.8 → 10.3 * 9.2 ↙ 9.8 ↘ 9.9 →
 9.5 ← 10.1 ↖ 9.6 ↗ 10.0 ↗ 10.6 *
 beste Teiler 90.2 (10.) 172.0 (2.) 225.3 (7.)
 Trefferlage 0.39 mm links, 0.65 mm tief
 Streuwert 2.07, horizontal: 2.55, vertikal: 1.42

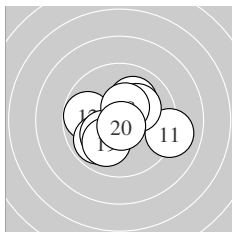

Serie 2:
 9.1 → 9.8 ← 9.9 ↖ 10.1 ↗ 10.2 *
 10.2 * 10.2 * 10.4 * 10.0 ↖ 10.7 *
 beste Teiler 55.0 (20.) 129.4 (18.) 194.5 (17.)
 Trefferlage 0.08 mm links, 0.38 mm tief
 Streuwert 1.84, horizontal: 2.19, vertikal: 1.40

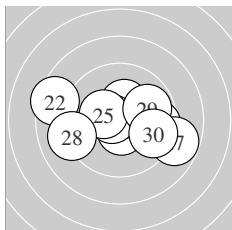

Serie 3:
 10.6 * 8.5 ← 10.3 * 10.7 * 10.3 *
 9.6 → 8.8 ↘ 9.1 ← 9.9 → 9.6 ↘
 beste Teiler 70.5 (24.) 100.4 (21.) 157.0 (23.)
 Trefferlage 0.21 mm rechts, 0.10 mm tief
 Streuwert 2.65, horizontal: 3.51, vertikal: 1.30

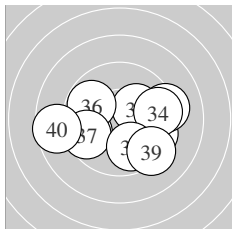

Serie 4:
 9.6 → 9.2 → 10.2 * 9.5 → 9.7 ←
 9.8 ← 9.6 ← 9.9 ↘ 9.3 ↘ 8.6 ←
 beste Teiler 183.8 (33.) 274.4 (38.) 290.6 (36.)
 Trefferlage 0.20 mm rechts, 0.63 mm tief
 Streuwert 2.70, horizontal: 3.49, vertikal: 1.55

Unterschrift des Schützen

Ergebnis: **364** (383.6)
 Serien: 90 91 94 89
 Zähler: 13 19 7 1 0 0 0 0 0 0
 Innenzehner: 11
 weiteste: 940 (40), 700 (21), 674 (18)
 beste Teiler 31.9 (31.) 77.1 (25.) 80.5 (30.)
 Trefferlage 0.49 mm links, 0.46 mm tief
 Streuwert 2.76, horizontal: 3.34, vertikal: 2.02

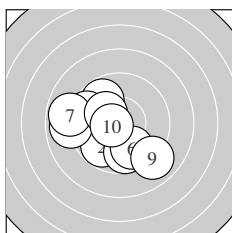
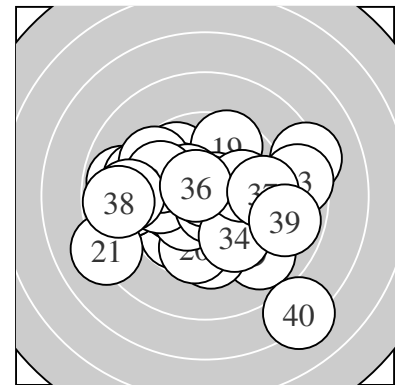

Serie 1:
 9.8 ↘ 9.8 ↙ 9.5 ↖ 8.9 ← 9.7 ↓
 9.8 ↓ 8.9 ← 10.2 * 9.0 ↘ 10.6 *
 beste Teiler 86.1 (10.) 177.4 (8.) 285.3 (6.)
 Trefferlage 1.42 mm links, 0.66 mm tief
 Streuwert 2.42, horizontal: 2.73, vertikal: 2.07

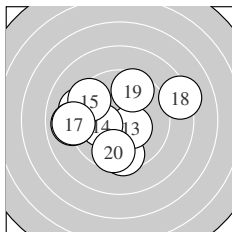

Serie 2:
 9.5 ↓ 9.2 ↖ 10.4 * 10.2 * 9.4 ↘
 9.0 ← 9.0 ← 8.3 → 9.6 ↑ 9.6 ↓
 beste Teiler 138.4 (13.) 198.9 (14.) 329.2 (20.)
 Trefferlage 1.03 mm links, 0.00 mm
 Streuwert 2.95, horizontal: 3.51, vertikal: 2.24

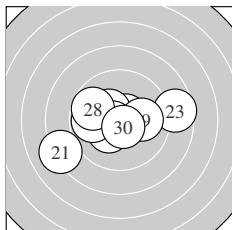

Serie 3:
 8.2 ↙ 10.6 * 8.6 → 10.4 * 10.6 *
 10.3 * 9.8 ← 9.7 ↖ 10.0 → 10.6 *
 beste Teiler 77.1 (25.) 80.5 (30.) 80.8 (22.)
 Trefferlage 0.55 mm links, 0.18 mm tief
 Streuwert 2.46, horizontal: 3.21, vertikal: 1.34

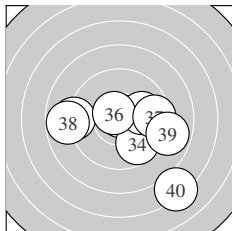

Serie 4:
 10.8 * 9.0 ← 9.9 → 9.7 ↘ 10.0 →
 10.6 * 9.5 → 8.8 ← 8.9 → 7.2 ↘
 beste Teiler 31.9 (31.) 85.6 (36.) 239.4 (35.)
 Trefferlage 1.05 mm rechts, 0.99 mm tief
 Streuwert 3.19, horizontal: 3.79, vertikal: 2.45

Unterschrift des Schützen

Meyton Elektronik

Ergebnis: **389** (407.8)
 Serien: 96 97 99 97
 Zähler: 29 11 0 0 0 0 0 0 0 0
 Innenzehner: 26
 weiteste: 445 (18), 355 (12), 346 (38)
 beste Teiler 53.3 (16.) 58.0 (14.) 60.0 (33.)
 Trefferlage 0.16 mm rechts, 0.21 mm hoch
 Streuwert 1.50, horizontal: 1.42, vertikal: 1.58

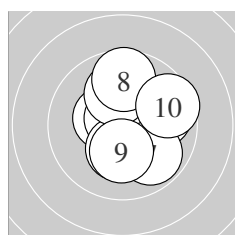
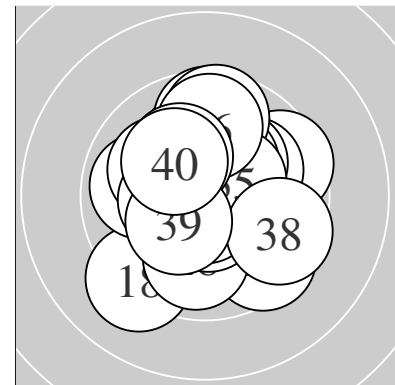

Serie 1:
 10.3 * 10.4 * 10.7 * 10.3 * 9.9 →
 10.1 ↑ 9.8 ↘ 9.7 ↑ 10.2 * 9.6 →
 beste Teiler 66.4 (3.) 135.5 (2.) 158.6 (1.)
 Trefferlage 0.65 mm rechts, 0.22 mm hoch
 Streuwert 1.64, horizontal: 1.51, vertikal: 1.76

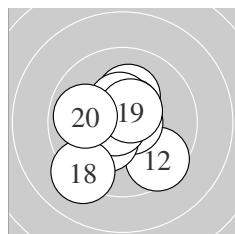

Serie 2:
 10.2 * 9.5 ↘ 10.6 * 10.7 * 10.3 *
 10.7 * 10.4 * 9.2 ↗ 10.6 * 9.9 ←
 beste Teiler 53.3 (16.) 58.0 (14.) 96.2 (19.)
 Trefferlage 0.27 mm links, 0.23 mm tief
 Streuwert 1.64, horizontal: 1.58, vertikal: 1.71

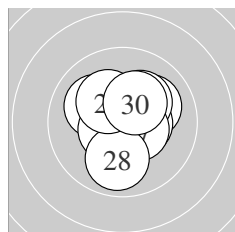

Serie 3:
 10.1 ↗ 10.7 * 10.4 * 10.1 ↖ 10.2 *
 10.5 * 10.5 * 9.9 ↓ 10.2 * 10.3 *
 beste Teiler 73.7 (22.) 103.0 (26.) 113.5 (27.)
 Trefferlage 0.27 mm rechts, 0.32 mm hoch
 Streuwert 1.25, horizontal: 1.23, vertikal: 1.27

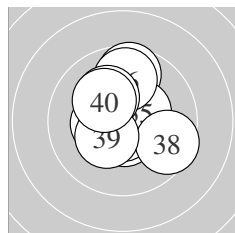

Serie 4:
 10.6 * 10.4 * 10.7 * 9.6 ↑ 10.4 *
 9.8 ↑ 10.2 * 9.6 ↘ 10.3 * 10.2 *
 beste Teiler 60.0 (33.) 96.0 (31.) 134.2 (35.)
 Trefferlage 0.01 mm rechts, 0.56 mm hoch
 Streuwert 1.55, horizontal: 1.40, vertikal: 1.70

Unterschrift des Schützen

Meyton Elektronik

Ergebnis: **393** (410.5)
 Serien: 98 99 99 97
 Zähler: 33 7 0 0 0 0 0 0 0 0
 Innenzehner: 25
 weiteste: 375 (12), 286 (9), 285 (24)
 beste Teiler 42.1 (19.) 53.4 (28.) 67.0 (17.)
 Trefferlage 0.36 mm links, 0.42 mm hoch
 Streuwert 1.29, horizontal: 1.21, vertikal: 1.37

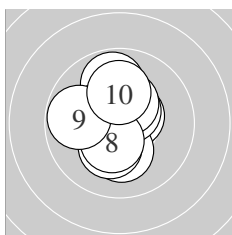
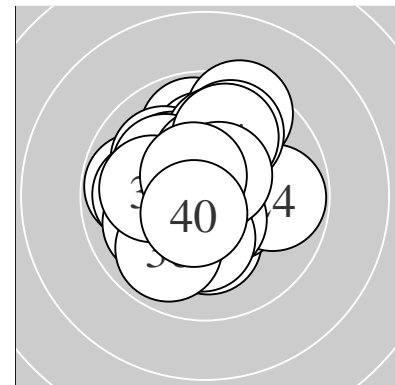

Serie 1:
 10.5 * 9.8 ↑ 10.2 * 10.5 * 10.4 *
 10.2 * 10.4 * 10.4 * 9.8 ← 10.1 ↑
 beste Teiler 103.4 (1.) 108.4 (4.) 133.9 (8.)
 Trefferlage 0.36 mm links, 0.39 mm hoch
 Streuwert 1.35, horizontal: 1.09, vertikal: 1.56

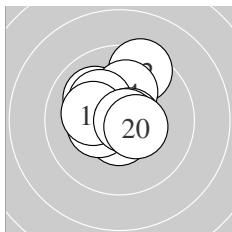

Serie 2:
 10.6 * 9.5 ↑ 10.0 ↘ 10.1 ↑ 10.2 *
 10.4 * 10.7 * 10.2 * 10.8 * 10.5 *
 beste Teiler 42.1 (19.) 67.0 (17.) 94.0 (11.)
 Trefferlage 0.23 mm links, 0.69 mm hoch
 Streuwert 1.31, horizontal: 1.25, vertikal: 1.36

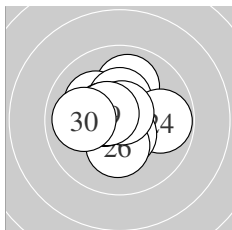

Serie 3:
 10.0 ↑ 10.1 ↘ 10.4 * 9.8 → 10.5 *
 10.2 * 10.5 * 10.7 * 10.6 * 10.0 ←
 beste Teiler 53.4 (28.) 99.2 (29.) 105.9 (25.)
 Trefferlage 0.23 mm links, 0.35 mm hoch
 Streuwert 1.33, horizontal: 1.45, vertikal: 1.18

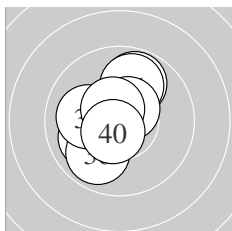

Serie 4:
 10.5 * 10.0 ← 9.8 ↑ 9.9 ↑ 10.5 *
 9.9 ↙ 10.5 * 10.1 ← 10.6 * 10.6 *
 beste Teiler 87.6 (40.) 98.1 (39.) 104.5 (37.)
 Trefferlage 0.64 mm links, 0.25 mm hoch
 Streuwert 1.36, horizontal: 1.17, vertikal: 1.52

Unterschrift des Schützen

Ergebnis:	380	(400.9)
Serien:	95	97 94 94
Zähler:	23	14 3 0 0 0 0 0 0 0
Innenzehner:	21	
weiteste:	598	(9), 550 (40), 533 (26)
beste Teiler	43.9	(31.) 63.1 (1.) 83.4 (25.)
Trefferlage	0.77	mm rechts, 0.14 mm hoch
Streuwert	1.84,	horizontal: 2.04, vertikal: 1.62

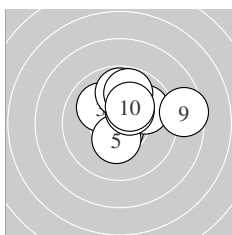
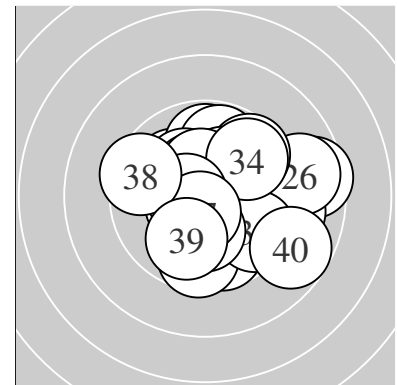

Serie 1:	10.7 *	10.0 ↑	10.1 ↘	9.9 ↗	10.4 *
	10.4 *	9.8 ↑	9.8 ↑	8.6 →	10.2 *
beste Teiler	63.1	(1.) 147.2 (6.)	148.0 (5.)		
Trefferlage	0.89	mm rechts, 1.21 mm hoch			
Streuwert	1.74,	horizontal: 2.04, vertikal: 1.36			

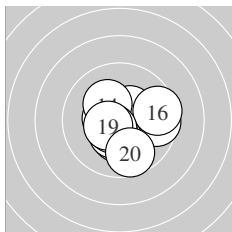

Serie 2:	10.5 *	10.4 *	9.6 →	10.2 *	10.3 *
	9.5 →	10.4 *	10.5 *	10.5 *	9.7 ↓
beste Teiler	102.8	(18.) 116.7 (19.)	120.2 (11.)		
Trefferlage	0.39	mm rechts, 0.38 mm tief			
Streuwert	1.57,	horizontal: 1.77, vertikal: 1.33			

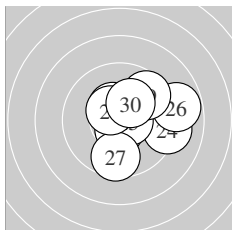

Serie 3:	10.4 *	10.6 *	9.9 ↗	9.2 →	10.6 *
	8.8 →	9.6 ↓	10.5 *	9.6 ↗	10.2 *
beste Teiler	83.4	(25.) 90.0 (22.)	122.3 (28.)		
Trefferlage	1.43	mm rechts, 0.29 mm hoch			
Streuwert	1.89,	horizontal: 2.11, vertikal: 1.64			

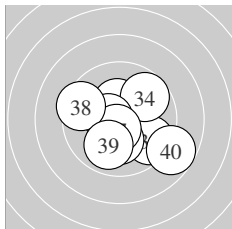

Serie 4:	10.8 *	9.6 ↘	10.4 *	9.7 ↗	10.2 *
	10.5 *	10.6 *	9.5 ↖	9.9 ↓	8.8 ↘
beste Teiler	43.9	(31.) 94.2 (37.)	103.3 (36.)		
Trefferlage	0.40	mm rechts, 0.54 mm tief			
Streuwert	2.04,	horizontal: 2.32, vertikal: 1.72			

Unterschrift des Schützen

Meyton Elektronik

Ergebnis: **389** (404.9)
 Serien: 96 100 97 96
 Zähler: 29 11 0 0 0 0 0 0 0 0
 Innenzehner: 19
 weiteste: 461 (2), 456 (3), 363 (34)
 beste Teiler 29.1 (27.) 34.1 (17.) 69.6 (22.)
 Trefferlage 0.17 mm links, 0.27 mm hoch
 Streuwert 1.64, horizontal: 1.75, vertikal: 1.51

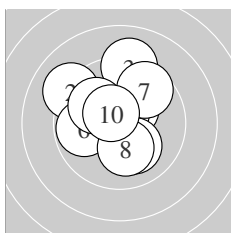
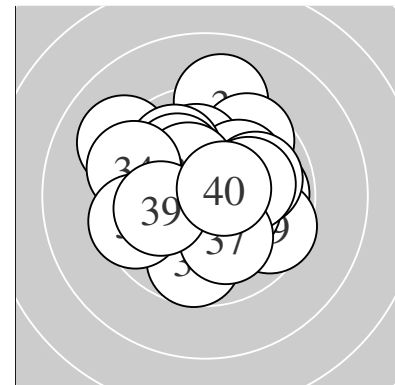

Serie 1:
 10.4 * 9.1 ↘ 9.1 ↑ 10.7 * 10.1 ↘
 9.8 ← 9.6 ↗ 10.2 * 10.0 ↘ 10.5 *
 beste Teiler 70.7 (4.) 104.2 (10.) 141.6 (1.)
 Trefferlage 0.38 mm links, 0.95 mm hoch
 Streuwert 1.94, horizontal: 1.88, vertikal: 2.00

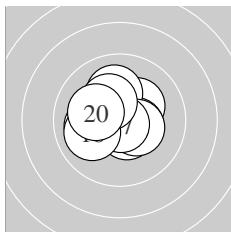

Serie 2:
 10.3 * 10.5 * 10.1 ← 10.4 * 10.1 ↑
 10.4 * 10.8 * 10.0 ← 10.3 * 10.2 *
 beste Teiler 34.1 (17.) 107.0 (12.) 133.7 (14.)
 Trefferlage 0.28 mm links, 0.16 mm hoch
 Streuwert 1.27, horizontal: 1.43, vertikal: 1.08

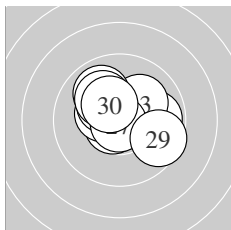

Serie 3:
 9.9 → 10.7 * 10.1 ↗ 10.4 * 10.3 *
 9.9 ↘ 10.8 * 10.1 ↘ 9.6 ↘ 10.4 *
 beste Teiler 29.1 (27.) 69.6 (22.) 142.8 (24.)
 Trefferlage 0.07 mm rechts, 0.60 mm hoch
 Streuwert 1.46, horizontal: 1.74, vertikal: 1.11

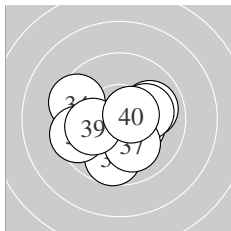

Serie 4:
 10.4 * 9.9 → 10.1 → 9.5 ↘ 10.2 *
 9.7 ↓ 10.1 ↘ 9.5 ← 10.1 ← 10.6 *
 beste Teiler 96.5 (40.) 148.7 (31.) 178.7 (35.)
 Trefferlage 0.11 mm links, 0.60 mm tief
 Streuwert 1.80, horizontal: 2.14, vertikal: 1.39

Unterschrift des Schützen

Ergebnis: **381** (395.0)
 Serien: 96 94 93 98
 Zähler: 22 17 1 0 0 0 0 0 0 0
 Innenzehner: 10
 weiteste: 681 (31), 479 (17), 455 (9)
 beste Teiler 44.0 (25.) 99.8 (34.) 108.1 (8.)
 Trefferlage 0.38 mm links, 0.43 mm hoch
 Streuwert 2.06, horizontal: 2.18, vertikal: 1.94

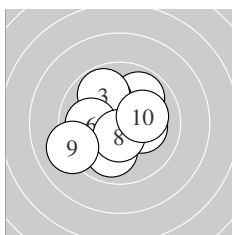
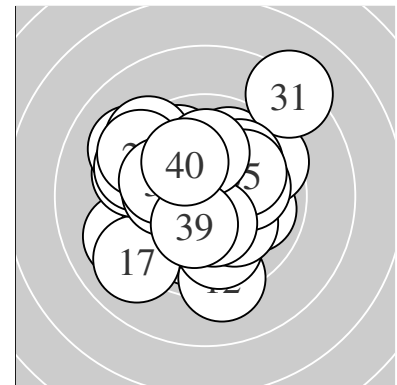

Serie 1:
 9.9 ↗ 10.0 ↘ 9.8 ↘ 10.2 * 9.9 ↙
 10.0 ← 10.0 ↓ 10.5 * 9.1 ↖ 10.1 →
 beste Teiler 108.1 (8.) 189.8 (4.) 204.6 (10.)
 Trefferlage 0.63 mm links, 0.03 mm tief
 Streuwert 1.90, horizontal: 2.00, vertikal: 1.78

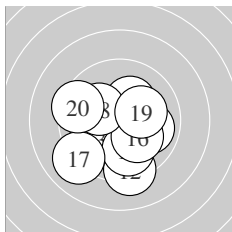

Serie 2:
 10.2 * 9.2 ↓ 9.9 ↙ 9.9 → 9.9 ↓
 10.1 ↘ 9.0 ↖ 10.2 * 10.2 * 9.4 ↖
 beste Teiler 177.5 (11.) 196.8 (19.) 198.6 (18.)
 Trefferlage 0.26 mm links, 0.93 mm tief
 Streuwert 2.13, horizontal: 2.26, vertikal: 2.00

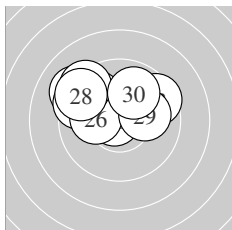

Serie 3:
 9.2 ↖ 9.8 ↘ 9.5 ↗ 9.4 ↖ 10.8 *
 10.1 ← 9.3 ↘ 9.4 ↖ 10.1 → 9.9 ↗
 beste Teiler 44.0 (25.) 204.7 (26.) 221.8 (29.)
 Trefferlage 1.15 mm links, 1.57 mm hoch
 Streuwert 1.92, horizontal: 2.52, vertikal: 1.01

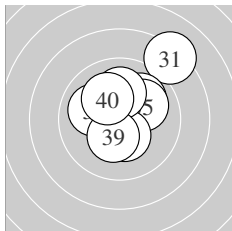

Serie 4:
 8.2 ↗ 10.0 ↗ 10.3 * 10.6 * 10.0 ↗
 10.0 ↖ 10.4 * 10.1 ↑ 10.3 * 10.1 ↘
 beste Teiler 99.8 (34.) 146.7 (37.) 156.9 (39.)
 Trefferlage 0.49 mm rechts, 1.14 mm hoch
 Streuwert 1.91, horizontal: 1.89, vertikal: 1.92

Unterschrift des Schützen

Ergebnis: **390** (407.8)
 Serien: 94 98 100 98
 Zähler: 31 8 1 0 0 0 0 0 0 0
 Innenzehner: 21
 weiteste: 515 (9), 301 (7), 296 (8)
 beste Teiler 36.4 (5.) 45.5 (11.) 53.1 (21.)
 Trefferlage 0.01 mm rechts, 0.23 mm hoch
 Streuwert 1.49, horizontal: 1.62, vertikal: 1.34

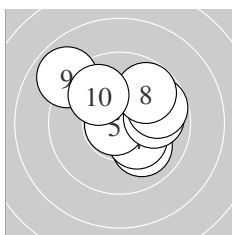
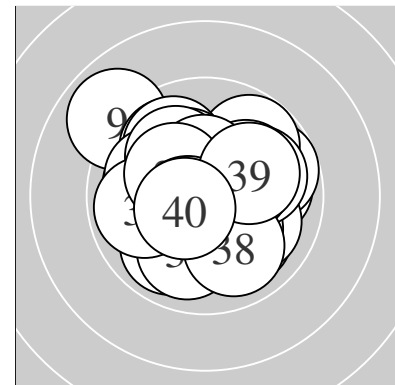

Serie 1:
 10.4 * 10.0 ↘ 10.5 * 10.3 * 10.8 *
 9.9 → 9.7 → 9.8 ↗ 8.9 ↖ 9.9 ↖
 beste Teiler 36.4 (5.) 106.8 (3.) 134.5 (1.)
 Trefferlage 0.60 mm rechts, 0.80 mm hoch
 Streuwert 1.81, horizontal: 2.04, vertikal: 1.55

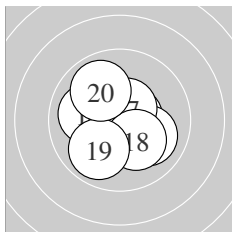

Serie 2:
 10.8 * 10.4 * 10.1 ↙ 10.0 ← 10.6 *
 10.0 ↘ 10.6 * 10.2 * 9.9 ↙ 9.9 ↖
 beste Teiler 45.5 (11.) 95.3 (15.) 99.9 (17.)
 Trefferlage 0.30 mm links, 0.14 mm tief
 Streuwert 1.39, horizontal: 1.44, vertikal: 1.35

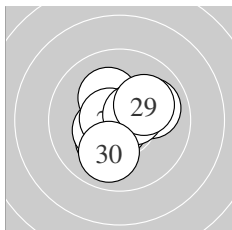

Serie 3:
 10.7 * 10.2 * 10.2 * 10.4 * 10.7 *
 10.2 * 10.0 → 10.5 * 10.1 → 10.0 ↓
 beste Teiler 53.1 (21.) 73.9 (25.) 107.7 (28.)
 Trefferlage 0.20 mm rechts, 0.00 mm
 Streuwert 1.31, horizontal: 1.36, vertikal: 1.25

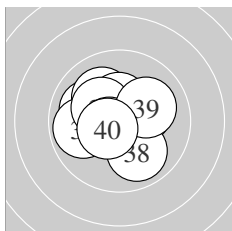

Serie 4:
 10.3 * 10.0 ← 10.1 ↖ 9.9 ← 10.4 *
 10.3 * 10.6 * 9.9 ↘ 10.1 → 10.5 *
 beste Teiler 89.8 (37.) 106.0 (40.) 135.1 (35.)
 Trefferlage 0.44 mm links, 0.27 mm hoch
 Streuwert 1.41, horizontal: 1.60, vertikal: 1.19

Unterschrift des Schützen

Ergebnis: **379** (399.9)
 Serien: 97 93 95 94
 Zähler: 19 21 0 0 0 0 0 0 0 0
 Innenzehner: 16
 weiteste: 486 (2), 433 (18), 431 (40)
 beste Teiler 9.4 (37.) 11.4 (26.) 46.4 (9.)
 Trefferlage 0.14 mm rechts, 0.52 mm tief
 Streuwert 1.92, horizontal: 2.26, vertikal: 1.49

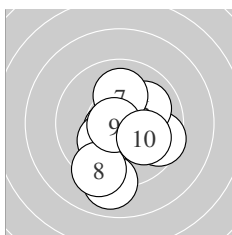
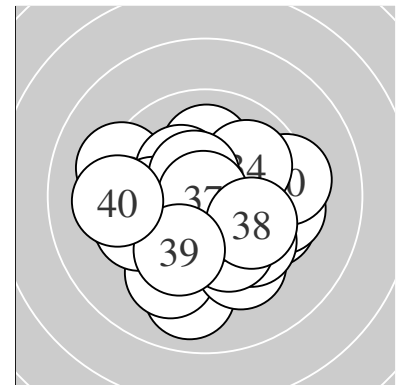

Serie 1:
 10.6 * 9.0 ↓ 10.2 * 9.6 ↘ 10.2 *
 10.0 ↗ 10.1 ↑ 9.3 ↓ 10.8 * 10.0 ↘
 beste Teiler 46.4 (9.) 87.9 (1.) 188.5 (3.)
 Trefferlage 0.42 mm rechts, 1.04 mm tief
 Streuwert 1.89, horizontal: 1.69, vertikal: 2.08

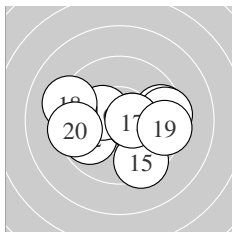

Serie 2:
 9.6 → 9.8 ↙ 9.5 → 10.5 * 9.4 ↓
 10.3 * 10.5 * 9.2 ↖ 9.5 → 9.5 ←
 beste Teiler 101.1 (14.) 104.0 (17.) 152.3 (16.)
 Trefferlage 0.29 mm rechts, 0.31 mm tief
 Streuwert 2.33, horizontal: 3.01, vertikal: 1.33

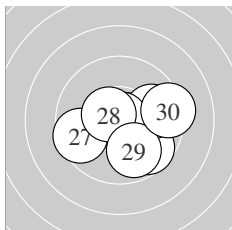

Serie 3:
 10.5 * 9.7 ↘ 10.7 * 10.7 * 9.9 →
 10.9 * 9.6 ↖ 10.6 * 9.9 ↓ 9.3 →
 beste Teiler 11.4 (26.) 55.0 (24.) 64.2 (23.)
 Trefferlage 0.82 mm rechts, 0.47 mm tief
 Streuwert 1.63, horizontal: 1.99, vertikal: 1.16

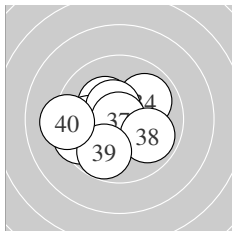

Serie 4:
 10.6 * 9.5 ↖ 10.3 * 9.9 ↗ 9.9 ←
 10.5 * 10.9 * 9.9 ↘ 9.8 ↓ 9.2 ←
 beste Teiler 9.4 (37.) 84.7 (31.) 111.0 (36.)
 Trefferlage 0.95 mm links, 0.27 mm tief
 Streuwert 1.74, horizontal: 2.09, vertikal: 1.30

Unterschrift des Schützen

Meyton Elektronik

Ergebnis: **385** (405.2)
 Serien: 96 98 98 93
 Zähler: 27 12 0 1 0 0 0 0 0 0
 Innenzehner: 24
 weiteste: 848 (31), 415 (29), 399 (37)
 beste Teiler 47.4 (3.) 49.0 (15.) 50.9 (28.)
 Trefferlage 0.02 mm rechts, 0.49 mm hoch
 Streuwert 1.77, horizontal: 2.04, vertikal: 1.45

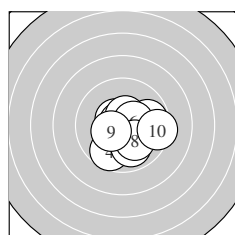
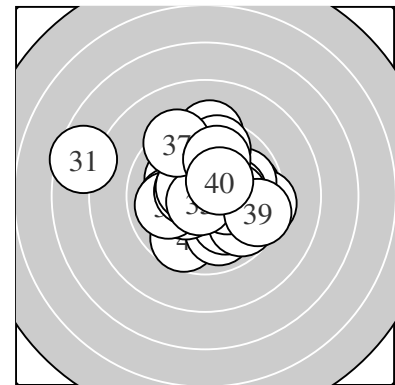

Serie 1:
 9.8 → 10.5 * 10.8 * 9.7 ↙ 10.5 *
 10.4 * 9.9 ↘ 10.1 ↘ 10.4 * 9.4 →
 beste Teiler 47.4 (3.) 107.1 (2.) 107.2 (5.)
 Trefferlage 0.65 mm rechts, 0.49 mm tief
 Streuwert 1.56, horizontal: 1.73, vertikal: 1.37

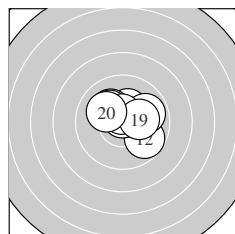

Serie 2:
 10.3 * 9.7 ↘ 10.4 * 9.9 → 10.8 *
 10.2 * 10.2 * 10.6 * 10.2 * 10.1 ↘
 beste Teiler 49.0 (15.) 89.5 (18.) 130.7 (13.)
 Trefferlage 0.38 mm rechts, 0.67 mm hoch
 Streuwert 1.32, horizontal: 1.60, vertikal: 0.96

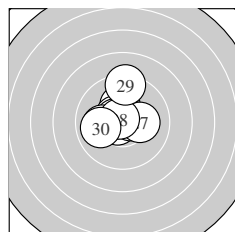

Serie 3:
 10.2 * 10.5 * 10.7 * 10.6 * 10.6 *
 10.0 ← 10.2 * 10.8 * 9.3 ↑ 9.9 ←
 beste Teiler 50.9 (28.) 65.7 (23.) 87.7 (24.)
 Trefferlage 0.44 mm links, 0.62 mm hoch
 Streuwert 1.37, horizontal: 1.31, vertikal: 1.42

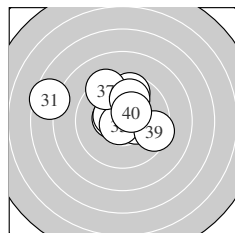

Serie 4:
 7.6 ↖ 10.3 * 10.5 * 10.5 * 10.7 *
 9.7 ↑ 9.4 ↘ 9.9 ↑ 9.5 → 10.4 *
 beste Teiler 51.6 (35.) 120.0 (33.) 120.4 (34.)
 Trefferlage 0.50 mm links, 1.16 mm hoch
 Streuwert 2.47, horizontal: 3.10, vertikal: 1.62

Unterschrift des Schützen

Meyton Elektronik