

Ergebnis: **377** (395.3)
 Serien: 93 92 95 97
 Zaehler: 19 19 2 0 0 0 0 0 0 0
 Innenzehner: 14
 weiteste: 592 (16), 508 (40), 489 (14)
 beste Teiler 72.1 (4.) 72.7 (12.) 102.6 (32.)
 Trefferlage 0.76 mm rechts, 0.10 mm hoch
 Streuwert 2.03, horizontal: 2.46, vertikal: 1.47

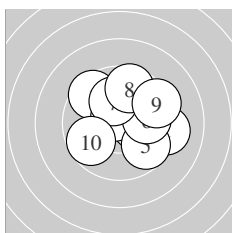

Serie 1:
 9.5 ↘ 9.2 → 10.4 * 10.7 * 9.7 ↘
 9.9 → 10.1 ↑ 9.6 ↑ 9.4 ↗ 9.7 ↖
 beste Teiler 72.1 (4.) 148.9 (3.) 208.6 (7.)
 Trefferlage 0.88 mm rechts, 0.61 mm hoch
 Streuwert 2.08, horizontal: 2.36, vertikal: 1.77

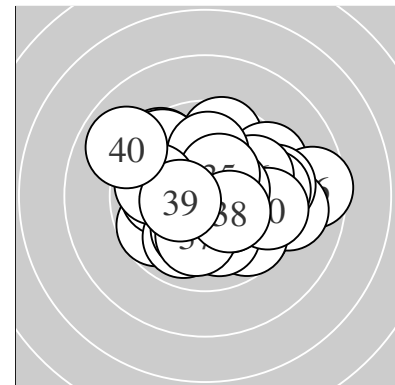
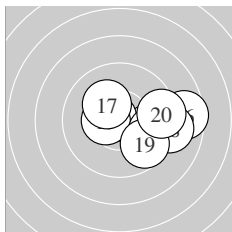

Serie 2:
 9.8 → 10.7 * 10.4 * 9.0 → 9.7 →
 8.6 → 10.2 * 9.1 → 9.7 ↘ 9.4 →
 beste Teiler 72.7 (12.) 127.0 (13.) 186.3 (17.)
 Trefferlage 2.41 mm rechts, 0.19 mm tief
 Streuwert 1.98, horizontal: 2.62, vertikal: 1.01

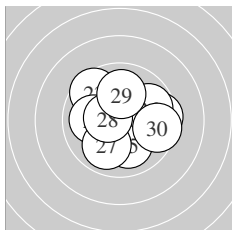

Serie 3:
 10.4 * 9.5 → 9.6 ↘ 10.0 ← 10.0 ↓
 9.8 ↗ 9.9 ↙ 10.5 * 10.0 ↑ 9.5 →
 beste Teiler 109.0 (28.) 143.1 (21.) 230.9 (25.)
 Trefferlage 0.23 mm rechts, 0.20 mm hoch
 Streuwert 1.98, horizontal: 2.29, vertikal: 1.62

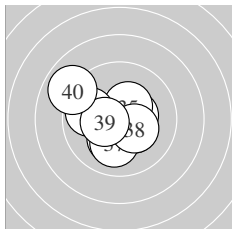

Serie 4:
 10.3 * 10.5 * 10.4 * 10.2 * 10.4 *
 9.8 ← 10.1 ↓ 10.3 * 10.4 * 8.9 ↘
 beste Teiler 102.6 (32.) 136.0 (33.) 139.4 (39.)
 Trefferlage 0.47 mm links, 0.21 mm tief
 Streuwert 1.69, horizontal: 1.90, vertikal: 1.46

Unterschrift des Schuetzen

Meyton Elektronik

Ergebnis:	376	(392.2)
Serien:	93	96 94 93
Zaehler:	21 15 3 1 0 0 0 0 0 0	
Innenzehner:	12	
weiteste:	755 (34), 676 (21), 580 (23)	
beste Teiler	87.9 (2.) 107.8 (39.) 123.8 (12.)	
Trefferlage	0.38 mm rechts, 0.32 mm hoch	
Streuwert	2.31, horizontal: 2.47, vertikal: 2.13	

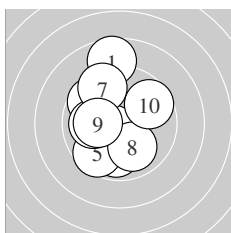
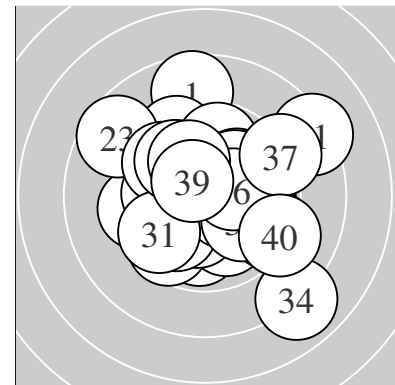

Serie 1:	8.7 ↑	10.6 *	9.9 ↓	9.7 ↖	9.6 ↙
	10.0 ←	9.5 ↗	10.0 ↘	10.2 *	9.7 ↘
beste Teiler	87.9 (2.) 199.0 (9.) 241.0 (6.)				
Trefferlage	0.83 mm links, 0.45 mm hoch				
Streuwert	2.27, horizontal: 1.68, vertikal: 2.73				

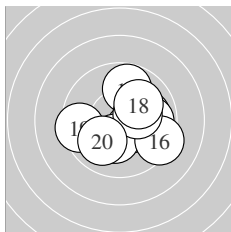

Serie 2:	9.8 ↑	10.5 *	10.0 →	9.9 →	10.3 *
	9.3 ↘	10.3 *	10.1 ↗	9.5 ←	10.0 ↙
beste Teiler	123.8 (12.) 172.6 (17.) 175.1 (15.)				
Trefferlage	0.81 mm rechts, 0.16 mm tief				
Streuwert	1.89, horizontal: 2.18, vertikal: 1.55				

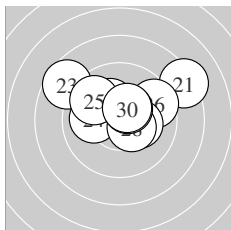

Serie 3:	8.2 ↗	10.2 *	8.6 ↖	10.0 ←	9.8 ↖
	9.6 ↗	10.3 *	10.4 *	10.4 *	10.4 *
beste Teiler	126.4 (29.) 127.2 (28.) 130.1 (30.)				
Trefferlage	0.29 mm rechts, 1.27 mm hoch				
Streuwert	2.35, horizontal: 3.04, vertikal: 1.35				

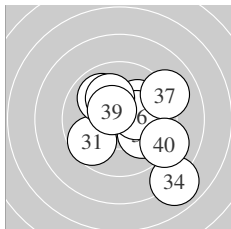

Serie 4:	9.7 ↙	10.1 ↗	10.0 ↘	7.9 ↘	9.9 ↖
	10.3 *	9.1 ↗	10.1 ↖	10.5 *	9.1 ↘
beste Teiler	107.8 (39.) 158.1 (36.) 209.3 (38.)				
Trefferlage	1.27 mm rechts, 0.25 mm tief				
Streuwert	2.57, horizontal: 2.63, vertikal: 2.51				

Unterschrift des Schuetzen

Meyton Elektronik

Ergebnis: **385** (403.5)
 Serien: 97 97 96 95
 Zaehler: 27 11 2 0 0 0 0 0 0 0
 Innenzehner: 21
 weiteste: 590 (29), 509 (32), 407 (22)
 beste Teiler 33.9 (31.) 45.2 (11.) 60.4 (5.)
 Trefferlage 0.15 mm rechts, 0.13 mm tief
 Streuwert 1.78, horizontal: 2.07, vertikal: 1.42

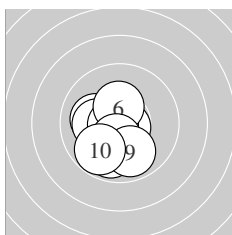
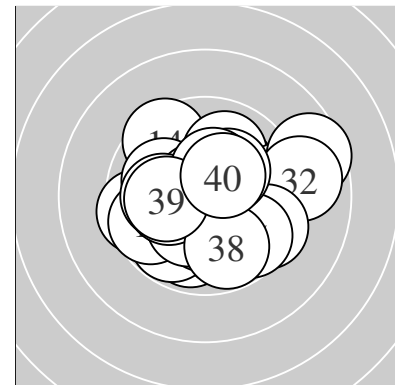

Serie 1:
 10.1 ← 10.3 * 10.2 * 10.7 * 10.7 *
 10.4 * 9.9 ↓ 10.4 * 9.9 ↓ 9.8 ↙
 beste Teiler 60.4 (5.) 62.2 (4.) 144.9 (8.)
 Trefferlage 0.60 mm links, 0.91 mm tief
 Streuwert 1.22, horizontal: 1.05, vertikal: 1.36

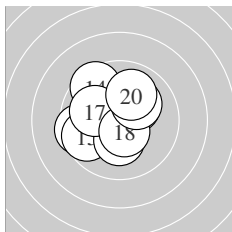

Serie 2:
 10.8 * 10.3 * 9.5 ← 9.5 ↘ 9.7 ←
 10.2 * 10.0 ← 10.5 * 10.1 ↗ 10.0 ↗
 beste Teiler 45.2 (11.) 107.5 (18.) 175.8 (12.)
 Trefferlage 0.61 mm links, 0.39 mm hoch
 Streuwert 1.73, horizontal: 1.87, vertikal: 1.59

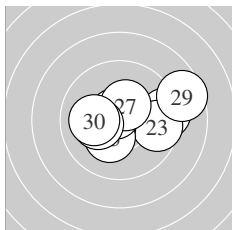

Serie 3:
 10.3 * 9.3 → 9.6 → 10.5 * 10.3 *
 10.7 * 10.4 * 10.2 * 8.6 → 10.1 ←
 beste Teiler 69.4 (26.) 106.0 (24.) 140.9 (27.)
 Trefferlage 0.56 mm rechts, 0.09 mm hoch
 Streuwert 2.07, horizontal: 2.73, vertikal: 1.07

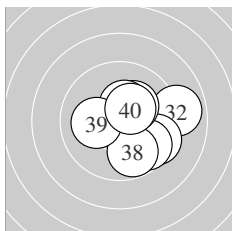

Serie 4:
 10.8 * 8.9 → 10.7 * 9.5 ↘ 9.7 ↘
 10.2 * 10.4 * 9.8 ↓ 10.1 ← 10.4 *
 beste Teiler 33.9 (31.) 68.2 (33.) 142.3 (37.)
 Trefferlage 1.25 mm rechts, 0.09 mm tief
 Streuwert 1.73, horizontal: 1.93, vertikal: 1.50

Unterschrift des Schuetzen

Meyton Elektronik

Ergebnis:	389	(406.8)
Serien:	98 98 94 99	
Zaehler:	29 11 0 0 0 0 0 0 0 0	
Innenzehner:	19	
weiteste:	430 (37), 385 (30), 313 (15)	
beste Teiler	22.2 (14.) 34.0 (25.) 56.2 (24.)	
Trefferlage	0.00 mm , 0.44 mm hoch	
Streuwert	1.51, horizontal: 1.45, vertikal: 1.57	

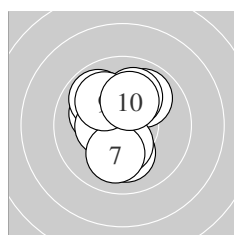
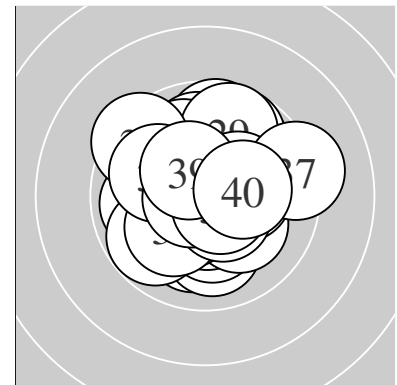

Serie 1:

10.1 ↓	9.9 ↗	10.1 ↖	9.9 ↘	10.4 *
10.4 *	10.1 ↓	10.0 ↑	10.0 ↘	10.2 *
beste Teiler	140.2 (5.)	143.2 (6.)	192.4 (10.)	
Trefferlage	0.38 mm links, 0.49 mm hoch			
Streuwert	1.53, horizontal: 1.20, vertikal: 1.80			

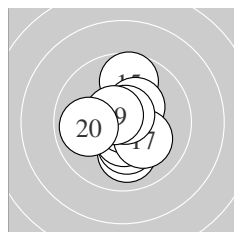

Serie 2:

10.0 ↓	10.3 *	10.5 *	10.9 *	9.7 ↑
10.3 *	10.1 ↘	10.7 *	10.6 *	9.9 ←
beste Teiler	22.2 (14.)	59.4 (18.)	84.6 (19.)	
Trefferlage	0.09 mm rechts, 0.16 mm tief			
Streuwert	1.37, horizontal: 1.10, vertikal: 1.59			

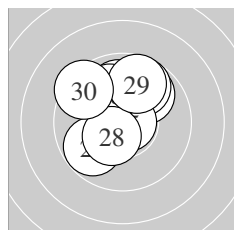

Serie 3:

9.9 ↗	9.7 ↗	9.9 ↑	10.7 *	10.8 *
10.0 ↘	9.8 ↙	10.4 *	9.7 ↑	9.4 ↘
beste Teiler	34.0 (25.)	56.2 (24.)	134.6 (28.)	
Trefferlage	0.27 mm links, 1.25 mm hoch			
Streuwert	1.63, horizontal: 1.54, vertikal: 1.72			

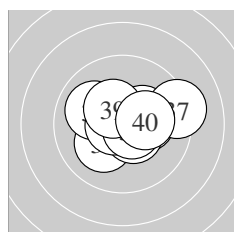

Serie 4:

10.1 ↙	10.3 *	10.5 *	10.3 *	10.0 ↘
10.7 *	9.2 →	10.6 *	10.4 *	10.3 *
beste Teiler	62.9 (36.)	81.9 (38.)	111.8 (33.)	
Trefferlage	0.56 mm rechts, 0.17 mm hoch			
Streuwert	1.45, horizontal: 1.86, vertikal: 0.87			

Unterschrift des Schuetzen

Ergebnis:	384	(402.2)
Serien:	97 97 99 91	
Zaehler:	26 13 0 1 0 0 0 0 0 0	
Innenzehner:	20	
weiteste:	953 (35), 477 (37), 442 (9)	
beste Teiler	23.3 (17.) 38.3 (25.) 46.1 (14.)	
Trefferlage	0.52 mm links, 0.22 mm tief	
Streuwert	1.92, horizontal: 2.29, vertikal: 1.45	

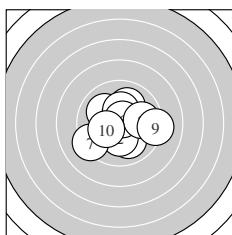
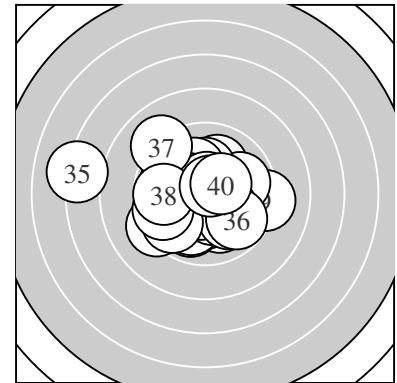

Serie 1:	10.0 ↘	10.2 *	10.0 ↖	10.0 ↗	10.3 *
	10.7 *	9.2 ↙	9.9 →	9.2 →	10.2 *
beste Teiler	58.4 (6.)	159.8 (5.)	179.5 (10.)		
Trefferlage	0.25 mm rechts, 0.15 mm tief				
Streuwert	1.97, horizontal: 2.28, vertikal: 1.59				

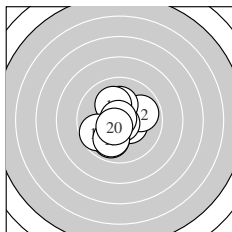

Serie 2:	10.4 *	9.9 →	9.9 ↙	10.8 *	10.2 *
	10.1 ↖	10.9 *	9.7 ↙	10.0 ↙	10.5 *
beste Teiler	23.3 (17.)	46.1 (14.)	101.5 (20.)		
Trefferlage	0.23 mm links, 0.31 mm tief				
Streuwert	1.47, horizontal: 1.41, vertikal: 1.53				

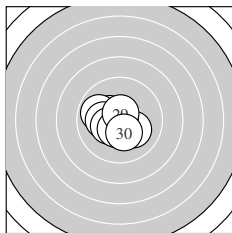

Serie 3:	10.1 ↘	10.4 *	9.9 ↖	10.2 *	10.8 *
	10.5 *	10.4 *	10.5 *	10.6 *	10.3 *
beste Teiler	38.3 (25.)	85.8 (29.)	118.1 (28.)		
Trefferlage	0.52 mm links, 0.27 mm tief				
Streuwert	1.11, horizontal: 1.25, vertikal: 0.95				

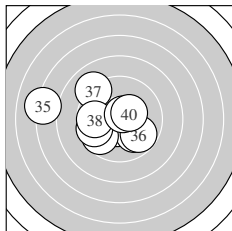

Serie 4:	10.5 *	9.9 ↘	9.7 ↙	9.6 ↙	7.1 ←
	9.8 ↘	9.0 ↘	9.7 ←	10.7 *	10.4 *
beste Teiler	69.3 (39.)	117.4 (31.)	138.9 (40.)		
Trefferlage	1.58 mm links, 0.15 mm tief				
Streuwert	2.76, horizontal: 3.47, vertikal: 1.81				

Unterschrift des Schuetzen

Meyton Elektronik

Ergebnis: **382** (400.3)
 Serien: 94 95 97 96
 Zaehler: 24 14 2 0 0 0 0 0 0 0
 Innenzehner: 17
 weiteste: 661 (6), 547 (21), 498 (14)
 beste Teiler 13.3 (28.) 45.4 (13.) 55.0 (33.)
 Trefferlage 0.16 mm links, 0.14 mm hoch
 Streuwert 1.97, horizontal: 2.38, vertikal: 1.44

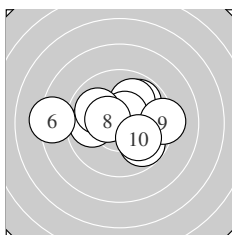
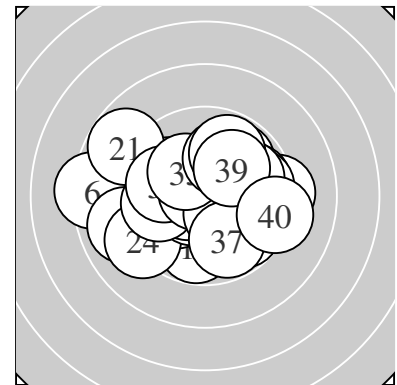

Serie 1:
 9.8 ↗ 9.9 ← 10.0 ↗ 10.5 * 9.8 ↘
 8.3 ← 10.0 ↖ 10.5 * 9.3 → 10.0 ↘
 beste Teiler 101.2 (4.) 123.0 (8.) 233.2 (10.)
 Trefferlage 0.07 mm links, 0.36 mm hoch
 Streuwert 2.40, horizontal: 3.13, vertikal: 1.33

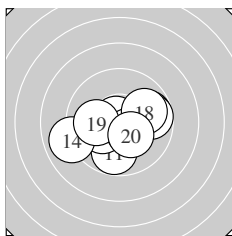

Serie 2:
 9.8 ↓ 10.2 * 10.8 * 9.0 ← 10.5 *
 9.8 → 9.7 → 9.9 → 10.0 ← 10.3 *
 beste Teiler 45.4 (13.) 125.8 (15.) 165.0 (20.)
 Trefferlage 0.07 mm rechts, 0.48 mm tief
 Streuwert 1.96, horizontal: 2.47, vertikal: 1.25

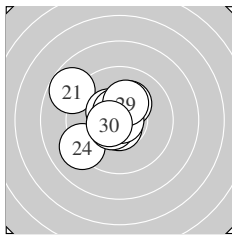

Serie 3:
 8.8 ↖ 10.2 * 10.4 * 9.2 ↙ 10.7 *
 10.6 * 10.6 * 10.9 * 10.2 * 10.5 *
 beste Teiler 13.3 (28.) 74.1 (25.) 91.2 (26.)
 Trefferlage 0.99 mm links, 0.34 mm hoch
 Streuwert 1.68, horizontal: 1.80, vertikal: 1.55

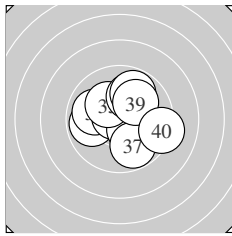

Serie 4:
 9.9 ← 10.0 ← 10.7 * 10.4 * 10.2 *
 10.0 ↗ 9.8 ↘ 9.8 ↗ 10.0 ↗ 9.3 →
 beste Teiler 55.0 (33.) 142.8 (34.) 182.0 (35.)
 Trefferlage 0.34 mm rechts, 0.35 mm hoch
 Streuwert 1.86, horizontal: 2.06, vertikal: 1.64

Unterschrift des Schuetzen

Meyton Elektronik

Ergebnis: **382** (400.3)
 Serien: 94 97 97 94
 Zaehler: 23 16 1 0 0 0 0 0 0 0
 Innenzehner: 14
 weiteste: 549 (7), 457 (28), 456 (14)
 beste Teiler 42.2 (21.) 45.6 (23.) 46.0 (24.)
 Trefferlage 0.34 mm links, 0.67 mm hoch
 Streuwert 1.85, horizontal: 2.13, vertikal: 1.51

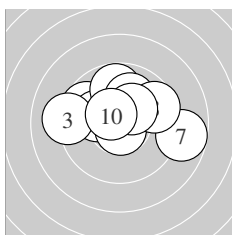
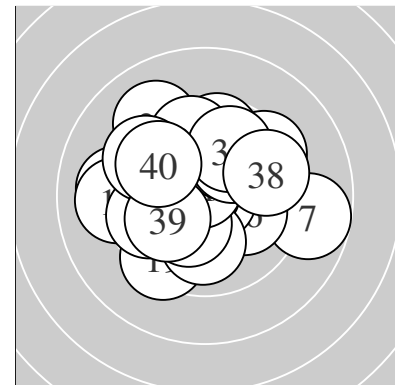

Serie 1:
 9.7 ↖ 10.1 ↖ 9.1 ← 9.8 ↑ 10.7 *
 10.0 ↗ 8.8 → 9.6 ↗ 10.3 * 10.5 *
 beste Teiler 55.7 (5.) 107.5 (10.) 162.3 (9.)
 Trefferlage 0.00 mm , 0.92 mm hoch
 Streuwert 2.18, horizontal: 2.85, vertikal: 1.18

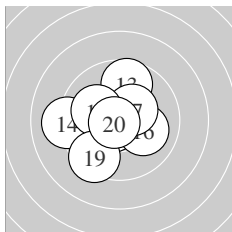

Serie 2:
 10.6 * 10.5 * 9.7 ↑ 9.1 ← 10.6 *
 10.1 ↘ 10.4 * 10.1 ↖ 9.4 ↙ 10.7 *
 beste Teiler 51.4 (20.) 82.1 (15.) 96.8 (11.)
 Trefferlage 0.43 mm links, 0.07 mm hoch
 Streuwert 1.81, horizontal: 1.99, vertikal: 1.60

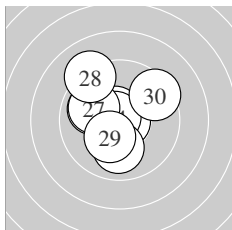

Serie 3:
 10.8 * 10.6 * 10.8 * 10.8 * 10.0 ↓
 9.9 ↖ 10.0 ↖ 9.1 ↖ 10.3 * 9.4 ↗
 beste Teiler 42.2 (21.) 45.6 (23.) 46.0 (24.)
 Trefferlage 0.52 mm links, 0.45 mm hoch
 Streuwert 1.71, horizontal: 1.67, vertikal: 1.76

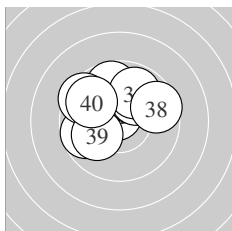

Serie 4:
 10.7 * 9.7 ↑ 10.0 ↗ 9.7 ← 10.0 ↗
 9.8 ↗ 9.5 ↖ 9.6 → 10.0 ← 9.8 ↖
 beste Teiler 61.7 (31.) 229.2 (39.) 230.0 (33.)
 Trefferlage 0.44 mm links, 1.25 mm hoch
 Streuwert 1.82, horizontal: 2.16, vertikal: 1.40

Unterschrift des Schuetzen

Meyton Elektronik

Ergebnis:	377	(395.9)
Serien:	92 94 97 94	
Zaehler:	20 17 3 0 0 0 0 0 0 0	
Innenzehner:	12	
weiteste:	592 (17), 555 (4), 524 (1)	
beste Teiler	51.1 (11.) 76.3 (19.) 81.4 (32.)	
Trefferlage	0.46 mm rechts, 0.42 mm hoch	
Streuwert	2.05, horizontal: 2.35, vertikal: 1.70	

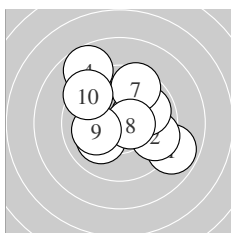
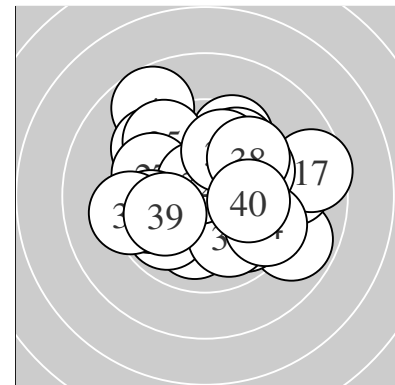

Serie 1:	8.9 ↘	9.6 ↘	10.3 *	8.7 ↖	9.9 ↗
	10.1 ↙	9.5 ↗	10.6 *	10.1 ←	9.4 ↖
beste Teiler	98.3 (8.) 158.4 (3.) 218.9 (9.)				
Trefferlage	0.47 mm rechts, 0.67 mm hoch				
Streuwert	2.48, horizontal: 2.68, vertikal: 2.26				

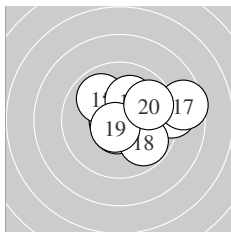

Serie 2:	10.7 *	9.1 →	10.6 *	10.0 ↗	9.9 ↖
	10.1 ↗	8.6 →	9.8 ↘	10.6 *	9.8 ↗
beste Teiler	51.1 (11.) 76.3 (19.) 82.9 (13.)				
Trefferlage	1.54 mm rechts, 0.48 mm hoch				
Streuwert	1.91, horizontal: 2.39, vertikal: 1.27				

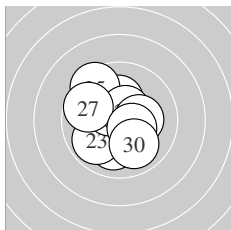

Serie 3:	10.0 ↓	10.2 *	9.9 ↙	10.5 *	9.5 ↖
	10.5 *	9.7 ↖	10.3 *	10.4 *	10.0 ↓
beste Teiler	102.2 (26.) 121.0 (24.) 132.8 (29.)				
Trefferlage	0.39 mm links, 0.08 mm hoch				
Streuwert	1.69, horizontal: 1.60, vertikal: 1.77				

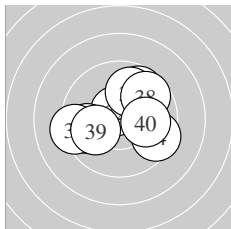

Serie 4:	10.2 *	10.6 *	9.7 ←	9.5 ↘	9.7 ↗
	9.3 ←	9.9 ↗	9.7 ↗	10.0 ←	10.0 →
beste Teiler	81.4 (32.) 188.3 (31.) 237.5 (40.)				
Trefferlage	0.22 mm rechts, 0.46 mm hoch				
Streuwert	2.09, horizontal: 2.51, vertikal: 1.57				

Unterschrift des Schuetzen

Meyton Elektronik

Ergebnis:	377	(398.4)
Serien:	96	95 90 96
Zaehler:	20	17 3 0 0 0 0 0 0 0
Innenzehner:	16	
weiteste:	543	(21), 542 (29), 517 (30)
beste Teiler	70.0	(3.) 80.0 (8.) 82.0 (5.)
Trefferlage	0.58 mm	rechts, 0.57 mm hoch
Streuwert	1.93,	horizontal: 2.29, vertikal: 1.48

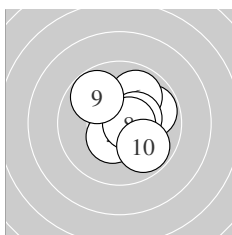
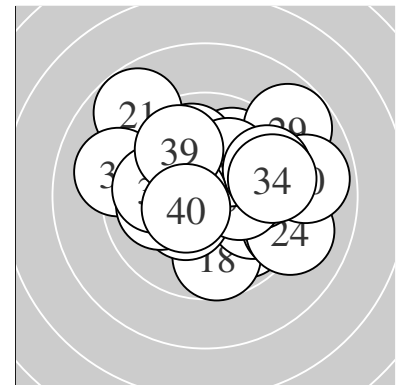

Serie 1:	10.3 *	9.8 →	10.7 *	10.4 *	10.6 *
	9.9 ↗	10.4 *	10.6 *	9.8 ↘	9.8 ↘
beste Teiler	70.0	(3.) 80.0 (8.) 82.0 (5.)			
Trefferlage	0.72 mm	rechts, 0.51 mm hoch			
Streuwert	1.32,	horizontal: 1.30, vertikal: 1.34			

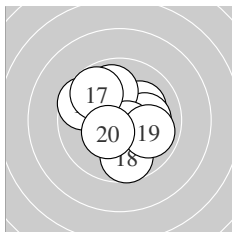

Serie 2:	10.6 *	10.2 *	9.6 ↘	10.1 →	9.9 ↗
	10.6 *	9.8 ↘	9.7 ↓	9.9 →	10.4 *
beste Teiler	88.3	(16.) 100.6 (11.) 140.7 (20.)			
Trefferlage	0.01 mm	links, 0.15 mm hoch			
Streuwert	1.75,	horizontal: 1.81, vertikal: 1.69			

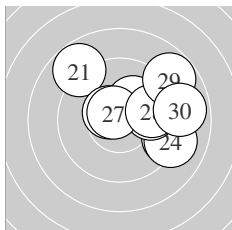

Serie 3:	8.8 ↘	9.2 →	10.2 *	9.1 →	9.9 →
	10.5 *	10.6 *	9.8 →	8.8 ↗	8.9 →
beste Teiler	82.4	(27.) 112.4 (26.) 188.6 (23.)			
Trefferlage	1.93 mm	rechts, 0.94 mm hoch			
Streuwert	2.37,	horizontal: 2.79, vertikal: 1.86			

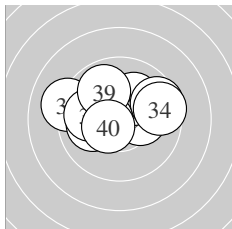

Serie 4:	10.3 *	10.1 ↗	9.6 →	9.5 →	10.5 *
	9.1 ←	10.0 ←	10.0 ←	9.9 ↘	10.5 *
beste Teiler	114.0	(35.) 115.6 (40.) 175.0 (31.)			
Trefferlage	0.30 mm	links, 0.67 mm hoch			
Streuwert	1.95,	horizontal: 2.58, vertikal: 0.98			

Unterschrift des Schuetzen

Meyton Elektronik

Ergebnis:	366	(380.1)
Serien:	90 90 93 93	
Zaehler:	15 20 3 1 0 1 0 0 0 0	
Innenzehner:	7	
weiteste:	1335 (2), 870 (32), 645 (28)	
beste Teiler	50.9 (5.) 98.7 (26.) 149.2 (11.)	
Trefferlage	1.08 mm links, 0.19 mm tief	
Streuwert	2.94, horizontal: 3.41, vertikal: 2.40	

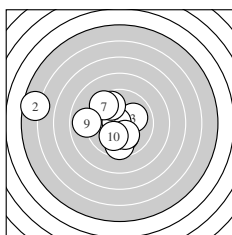
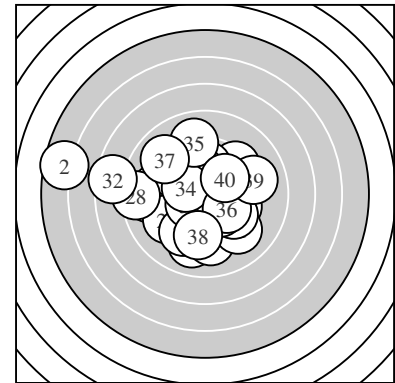

Serie 1:	10.1 ↘	5.6 ←	10.0 →	9.6 ↓	10.8 *
	9.7 ↗	9.5 ↗	10.2 *	8.9 ←	10.1 ↘
beste Teiler	50.9 (5.)	199.5 (8.)	215.3 (1.)		
Trefferlage	1.97 mm links, 0.00 mm				
Streuwert	3.48, horizontal: 4.38, vertikal: 2.25				

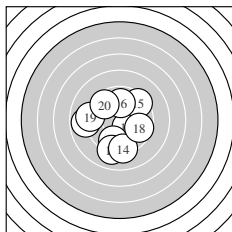

Serie 2:	10.4 *	9.6 ↓	9.0 ↓	9.2 ↓	9.4 ↗
	9.9 ↑	8.8 ←	9.7 →	9.1 ←	9.6 ↗
beste Teiler	149.2 (11.)	264.5 (16.)	325.1 (18.)		
Trefferlage	0.67 mm links, 0.64 mm tief				
Streuwert	2.79, horizontal: 2.80, vertikal: 2.77				

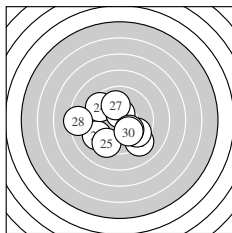

Serie 3:	9.2 ↘	9.6 ↘	9.3 ↙	9.5 ↖	9.3 ↙
	10.6 *	10.0 ↑	8.4 ←	10.1 ↘	10.1 ↘
beste Teiler	98.7 (26.)	212.1 (29.)	223.4 (30.)		
Trefferlage	0.69 mm links, 0.92 mm tief				
Streuwert	2.62, horizontal: 3.05, vertikal: 2.10				

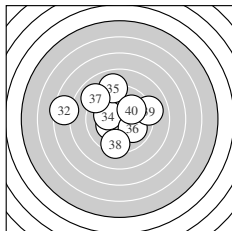

Serie 4:	10.3 *	7.5 ←	10.3 *	10.2 *	9.0 ↑
	10.0 ↘	9.0 ↖	9.4 ↓	9.1 →	10.0 ↗
beste Teiler	152.2 (31.)	172.5 (33.)	187.2 (34.)		
Trefferlage	0.98 mm links, 0.77 mm hoch				
Streuwert	3.04, horizontal: 3.56, vertikal: 2.41				

Unterschrift des Schuetzen

Ergebnis:	365	(385.0)
Serien:	89 94 91 91	
Zaehler:	12 24 1 3 0 0 0 0 0 0	
Innenzehner:	11	
weiteste:	848 (3), 825 (23), 780 (31)	
beste Teiler	52.5 (20.) 67.7 (36.) 78.1 (30.)	
Trefferlage	0.08 mm rechts, 0.28 mm hoch	
Streuwert	2.74, horizontal: 3.21, vertikal: 2.17	

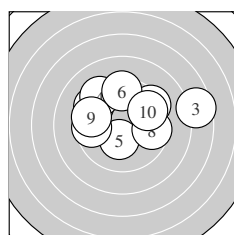
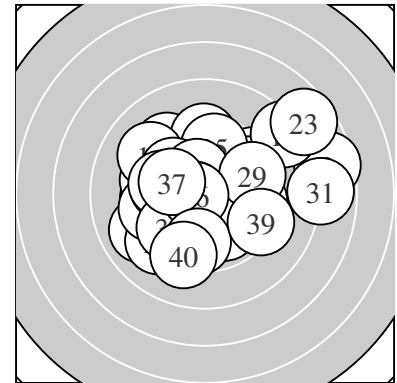

Serie 1:

9.4 ↗	9.4 ↘	7.6 →	9.3 ↖	10.3 *
9.4 ↑	9.6 ←	9.6 →	9.5 ↖	9.6 ↗
beste Teiler	165.4 (5.)	326.2 (10.)	333.4 (8.)	
Trefferlage	0.42 mm rechts, 1.36 mm hoch			
Streuwert	3.02, horizontal: 3.91, vertikal: 1.72			

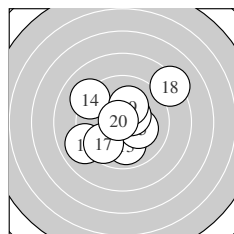

Serie 2:

10.4 *	9.0 ↙	9.9 ↓	9.2 ↖	10.2 *
10.5 *	9.7 ↙	8.3 ↗	10.2 *	10.7 *
beste Teiler	52.5 (20.)	120.0 (16.)	148.7 (11.)	
Trefferlage	0.09 mm links, 0.27 mm hoch			
Streuwert	2.54, horizontal: 2.78, vertikal: 2.28			

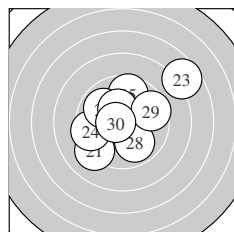

Serie 3:

9.2 ↙	10.5 *	7.7 ↗	9.5 ←	9.7 ↑
9.9 ↘	10.3 *	9.9 ↘	9.6 →	10.6 *
beste Teiler	78.1 (30.)	108.1 (22.)	156.9 (27.)	
Trefferlage	0.23 mm rechts, 0.51 mm hoch			
Streuwert	2.78, horizontal: 3.08, vertikal: 2.45			

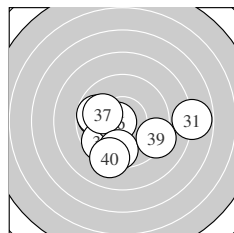

Serie 4:

7.8 →	10.5 *	9.8 ←	9.8 ←	9.6 ↙
10.7 *	10.0 ↖	9.6 ↓	9.3 ↘	9.2 ↓
beste Teiler	67.7 (36.)	122.6 (32.)	238.5 (37.)	
Trefferlage	0.25 mm links, 1.00 mm tief			
Streuwert	2.72, horizontal: 3.43, vertikal: 1.76			

Unterschrift des Schuetzen

Meyton Elektronik

Ergebnis: **393** (410.0)
 Serien: 99 97 99 98
 Zaehler: 33 7 0 0 0 0 0 0 0 0
 Innenzehner: 27
 weiteste: 407 (1), 320 (16), 297 (35)
 beste Teiler 66.8 (23.) 69.5 (22.) 92.9 (2.)
 Trefferlage 0.41 mm links, 0.10 mm hoch
 Streuwert 1.35, horizontal: 1.44, vertikal: 1.26

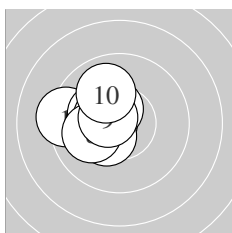
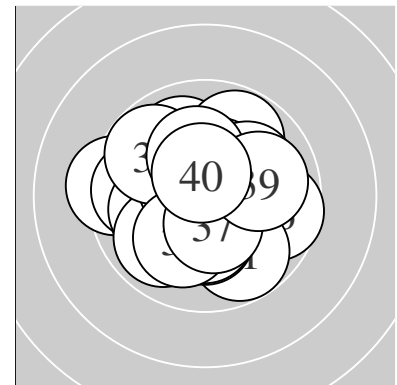

Serie 1:
 9.3 ← 10.6 * 10.5 * 10.4 * 10.2 *
 10.2 * 10.4 * 10.1 ← 10.6 * 10.0 ↗
 beste Teiler 92.9 (2.) 97.9 (9.) 116.4 (3.)
 Trefferlage 1.51 mm links, 0.37 mm hoch
 Streuwert 0.97, horizontal: 1.02, vertikal: 0.91

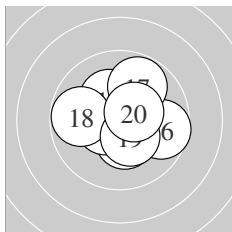

Serie 2:
 10.5 * 10.4 * 10.5 * 10.5 * 10.2 *
 9.7 → 9.8 ↗ 9.8 ← 10.4 * 10.5 *
 beste Teiler 101.1 (11.) 112.2 (13.) 121.7 (14.)
 Trefferlage 0.19 mm rechts, 0.32 mm hoch
 Streuwert 1.46, horizontal: 1.63, vertikal: 1.27

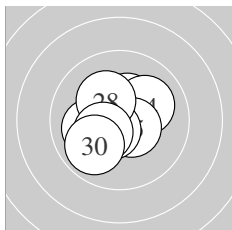

Serie 3:
 10.4 * 10.7 * 10.7 * 10.1 ↗ 10.5 *
 10.6 * 10.1 ← 10.2 * 10.3 * 9.9 ↙
 beste Teiler 66.8 (23.) 69.5 (22.) 97.8 (26.)
 Trefferlage 0.31 mm links, 0.04 mm hoch
 Streuwert 1.21, horizontal: 1.29, vertikal: 1.12

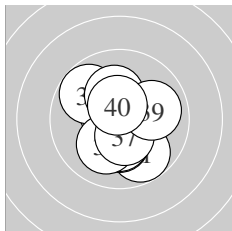

Serie 4:
 9.8 ↘ 10.2 * 10.3 * 10.6 * 9.8 ↖
 10.1 ↙ 10.4 * 10.2 * 10.0 → 10.5 *
 beste Teiler 97.3 (34.) 105.3 (40.) 130.3 (37.)
 Trefferlage 0.03 mm links, 0.31 mm tief
 Streuwert 1.50, horizontal: 1.31, vertikal: 1.67

Unterschrift des Schuetzen

Meyton Elektronik

Ergebnis: **389** (406.5)
 Serien: 96 99 97 97
 Zaehler: 29 11 0 0 0 0 0 0 0 0
 Innenzehner: 21
 weiteste: 442 (27), 386 (36), 379 (8)
 beste Teiler 6.7 (15.) 40.3 (20.) 76.9 (14.)
 Trefferlage 0.13 mm rechts, 0.10 mm tief
 Streuwert 1.57, horizontal: 1.61, vertikal: 1.53

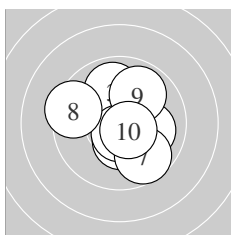
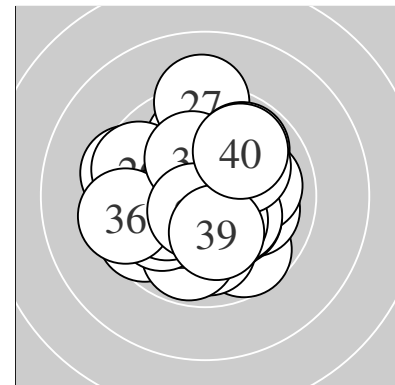

Serie 1:
 10.4 * 10.4 * 9.9 ↑ 10.5 * 10.1 →
 10.6 * 9.7 ↘ 9.4 ← 9.9 ↗ 10.6 *
 beste Teiler 79.0 (6.) 87.6 (10.) 104.2 (4.)
 Trefferlage 0.42 mm rechts, 0.08 mm tief
 Streuwert 1.62, horizontal: 1.66, vertikal: 1.58

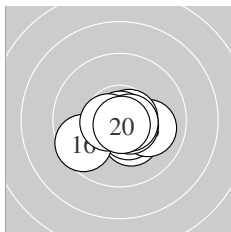

Serie 2:
 10.3 * 10.5 * 10.0 → 10.6 * 10.9 *
 9.6 ↙ 10.6 * 10.6 * 10.6 * 10.8 *
 beste Teiler 6.7 (15.) 40.3 (20.) 76.9 (14.)
 Trefferlage 0.26 mm rechts, 0.56 mm tief
 Streuwert 1.05, horizontal: 1.34, vertikal: 0.62

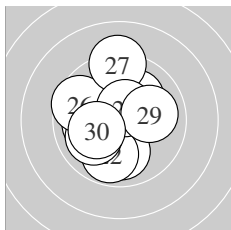

Serie 3:
 10.0 ↓ 9.8 ↓ 10.1 ↗ 10.0 ← 10.0 ↙
 9.6 ↖ 9.2 ↑ 10.5 * 10.0 → 10.2 *
 beste Teiler 102.9 (28.) 196.5 (30.) 213.2 (23.)
 Trefferlage 0.59 mm links, 0.12 mm hoch
 Streuwert 1.93, horizontal: 1.72, vertikal: 2.12

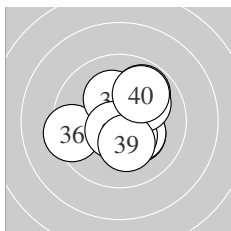

Serie 4:
 10.3 * 10.3 * 10.4 * 9.8 ↗ 10.0 ↗
 9.4 ← 10.2 * 10.6 * 10.2 * 9.9 ↗
 beste Teiler 85.7 (38.) 135.6 (33.) 167.8 (32.)
 Trefferlage 0.44 mm rechts, 0.09 mm hoch
 Streuwert 1.64, horizontal: 1.71, vertikal: 1.55

Unterschrift des Schuetzen

Meyton Elektronik

Ergebnis: **380** (399.2)
 Serien: 95 95 95 95
 Zaehler: 22 16 2 0 0 0 0 0 0 0
 Innenzehner: 20
 weiteste: 538 (11), 518 (4), 471 (34)
 beste Teiler 4.1 (10.) 43.9 (12.) 54.4 (31.)
 Trefferlage 0.20 mm rechts, 0.92 mm hoch
 Streuwert 1.88, horizontal: 2.38, vertikal: 1.19

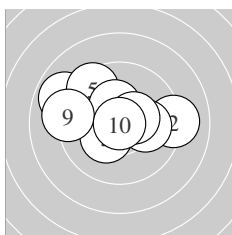
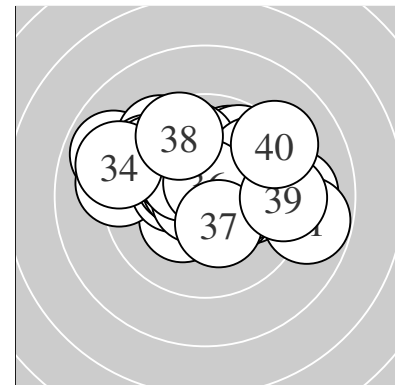

Serie 1:
 10.6 * 9.1 → 10.3 * 8.9 ↖ 9.5 ↗
 10.3 * 10.1 → 10.4 * 9.2 ← 10.9 *
 beste Teiler 4.1 (10.) 97.8 (1.) 129.0 (8.)
 Trefferlage 0.57 mm links, 0.70 mm hoch
 Streuwert 2.20, horizontal: 2.86, vertikal: 1.20

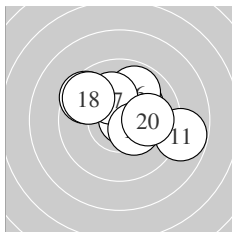

Serie 2:
 8.8 → 10.8 * 10.3 * 10.2 * 9.5 ↖
 9.9 ↗ 10.2 * 9.6 ↖ 10.4 * 10.0 →
 beste Teiler 43.9 (12.) 145.4 (19.) 155.0 (13.)
 Trefferlage 0.73 mm rechts, 0.75 mm hoch
 Streuwert 1.93, horizontal: 2.41, vertikal: 1.28

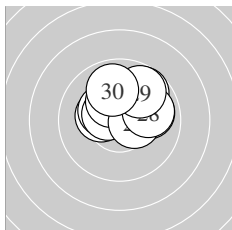

Serie 3:
 10.3 * 10.3 * 9.7 ↗ 10.5 * 10.3 *
 9.9 → 10.4 * 9.9 → 9.8 ↗ 9.9 ↗
 beste Teiler 113.6 (24.) 128.2 (27.) 157.0 (22.)
 Trefferlage 0.47 mm rechts, 1.18 mm hoch
 Streuwert 1.36, horizontal: 1.66, vertikal: 0.98

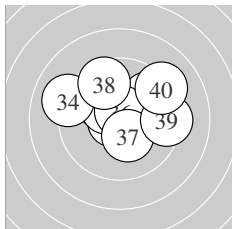

Serie 4:
 10.7 * 10.2 * 10.4 * 9.1 ↖ 9.7 ↗
 10.7 * 10.3 * 9.6 ↖ 9.3 → 9.2 ↗
 beste Teiler 54.4 (31.) 67.6 (36.) 145.3 (33.)
 Trefferlage 0.20 mm rechts, 1.04 mm hoch
 Streuwert 2.07, horizontal: 2.59, vertikal: 1.37

Unterschrift des Schuetzen

Meyton Elektronik

Ergebnis: **393** (409.2)
 Serien: 99 99 96 99
 Zaehler: 33 7 0 0 0 0 0 0 0 0
 Innenzehner: 23
 weiteste: 456 (22), 358 (25), 312 (6)
 beste Teiler 14.8 (18.) 61.7 (39.) 66.4 (28.)
 Trefferlage 0.31 mm links, 0.28 mm hoch
 Streuwert 1.41, horizontal: 1.60, vertikal: 1.20

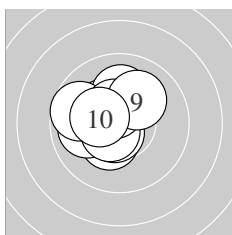
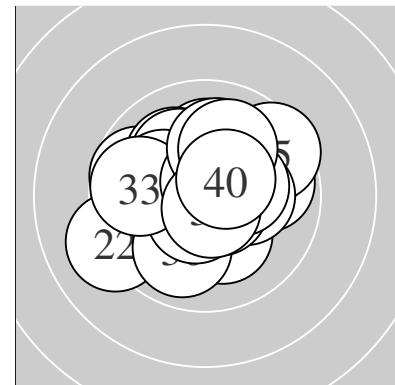

Serie 1:
 10.4 * 10.6 * 10.0 ← 10.3 * 10.1 ↑
 9.7 ↖ 10.6 * 10.5 * 10.1 ↗ 10.3 *
 beste Teiler 82.2 (2.) 96.2 (7.) 115.1 (8.)
 Trefferlage 0.91 mm links, 0.43 mm hoch
 Streuwert 1.19, horizontal: 1.23, vertikal: 1.15

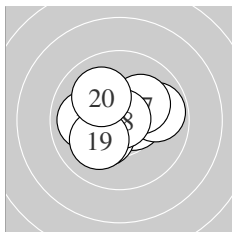

Serie 2:
 10.3 * 10.0 ← 10.5 * 10.3 * 9.8 →
 10.5 * 10.2 * 10.9 * 10.1 ↙ 10.1 ↘
 beste Teiler 14.8 (18.) 102.0 (13.) 120.0 (16.)
 Trefferlage 0.32 mm links, 0.21 mm hoch
 Streuwert 1.37, horizontal: 1.65, vertikal: 1.01

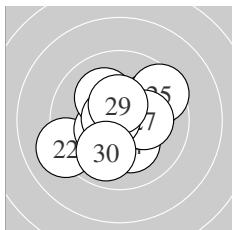

Serie 3:
 9.9 ↗ 9.1 ↖ 10.4 * 10.2 * 9.5 ↗
 10.1 ↘ 10.2 * 10.7 * 10.5 * 9.9 ↙
 beste Teiler 66.4 (28.) 117.6 (29.) 138.9 (23.)
 Trefferlage 0.03 mm links, 0.05 mm tief
 Streuwert 1.86, horizontal: 2.08, vertikal: 1.61

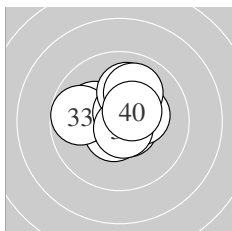

Serie 4:
 10.6 * 10.1 ↖ 9.8 ← 10.6 * 10.7 *
 10.3 * 10.1 ↑ 10.0 ↑ 10.7 * 10.5 *
 beste Teiler 61.7 (39.) 68.6 (35.) 78.0 (34.)
 Trefferlage 0.00 mm , 0.55 mm hoch
 Streuwert 1.22, horizontal: 1.40, vertikal: 1.02

Unterschrift des Schuetzen

Meyton Elektronik

Ergebnis: **389** (402.2)
 Serien: 96 98 99 96
 Zaehler: 30 9 1 0 0 0 0 0 0 0
 Innenzehner: 17
 weiteste: 550 (40), 427 (38), 399 (2)
 beste Teiler 57.0 (19.) 68.8 (9.) 104.4 (7.)
 Trefferlage 0.64 mm rechts, 0.02 mm hoch
 Streuwert 1.68, horizontal: 1.80, vertikal: 1.56

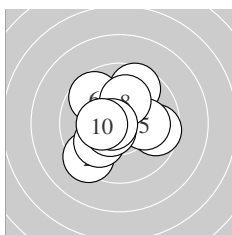
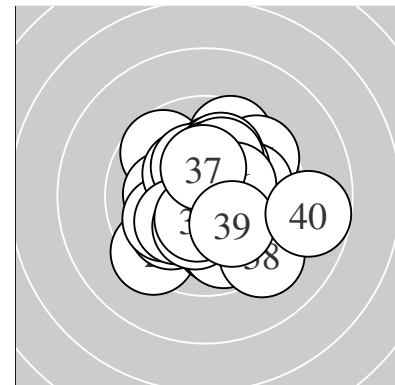

Serie 1:
 9.7 → 9.4 ↙ 9.6 ↑ 10.0 ↙ 10.1 →
 9.7 ↘ 10.5 * 10.1 ↑ 10.7 * 10.3 *
 beste Teiler 68.8 (9.) 104.4 (7.) 155.3 (10.)
 Trefferlage 0.25 mm links, 0.11 mm hoch
 Streuwert 1.90, horizontal: 1.97, vertikal: 1.82

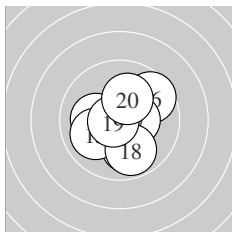

Serie 2:
 10.1 ← 10.5 * 10.0 ↓ 10.1 ↗ 10.0 ↙
 9.6 ↗ 10.4 * 9.8 ↓ 10.7 * 10.2 *
 beste Teiler 57.0 (19.) 107.4 (12.) 131.0 (17.)
 Trefferlage 0.39 mm rechts, 0.01 mm tief
 Streuwert 1.57, horizontal: 1.54, vertikal: 1.61

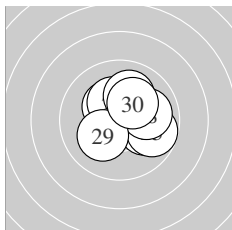

Serie 3:
 10.0 → 10.4 * 10.0 ↘ 10.3 * 9.8 →
 10.3 * 10.0 ↑ 10.0 → 10.2 * 10.2 *
 beste Teiler 150.0 (22.) 157.2 (24.) 165.2 (26.)
 Trefferlage 0.99 mm rechts, 0.43 mm hoch
 Streuwert 1.37, horizontal: 1.54, vertikal: 1.18

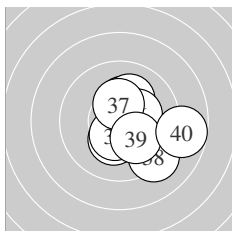

Serie 4:
 10.3 * 10.1 ↑ 10.3 * 9.6 ↘ 10.4 *
 10.3 * 10.4 * 9.2 ↘ 10.1 ↘ 8.8 →
 beste Teiler 126.8 (35.) 147.2 (37.) 159.5 (36.)
 Trefferlage 1.44 mm rechts, 0.41 mm tief
 Streuwert 1.79, horizontal: 1.88, vertikal: 1.69

Unterschrift des Schuetzen

Meyton Elektronik

Ergebnis:	383	(402.4)
Serien:	96	96 95 96
Zähler:	23	17 0 0 0 0 0 0 0 0
Innenzehner:	19	
weiteste:	422	(22), 418 (32), 403 (33)
beste Teiler	11.7	(11.) 39.9 (28.) 46.0 (26.)
Trefferlage	0.11 mm	rechts, 0.03 mm hoch
Streuwert	1.76,	horizontal: 2.00, vertikal: 1.49

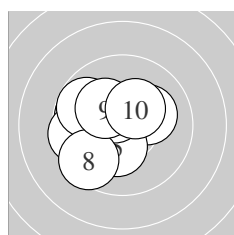
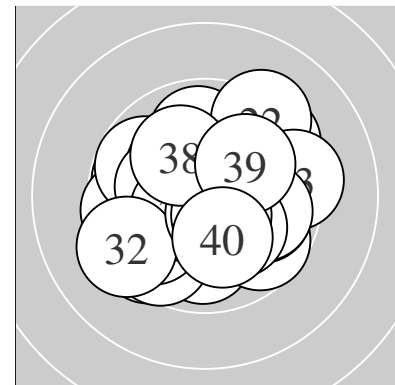

Serie 1:	9.8 ↙	10.2 *	10.2 *	9.6 ↙	10.3 *
	10.5 *	9.8 ↙	9.5 ↘	10.2 *	10.3 *
beste Teiler	109.8	(6.) 155.4 (10.)	163.9 (5.)		
Trefferlage	1.23 mm	links, 0.25 mm hoch			
Streuwert	1.55,	horizontal: 1.70, vertikal: 1.37			

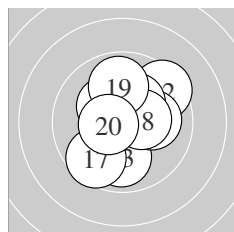

Serie 2:	10.9 *	9.4 ↗	9.9 ↓	10.1 →	10.3 *
	10.3 *	9.6 ↘	10.4 *	9.9 ↑	10.5 *
beste Teiler	11.7	(11.) 107.5 (20.)	142.4 (18.)		
Trefferlage	0.29 mm	rechts, 0.25 mm hoch			
Streuwert	1.69,	horizontal: 1.56, vertikal: 1.81			

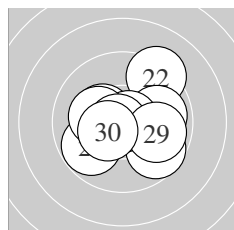

Serie 3:	10.3 *	9.3 ↗	9.8 ↘	9.9 →	9.7 ↘
	10.8 *	10.2 *	10.8 *	9.9 →	10.4 *
beste Teiler	39.9	(28.) 46.0 (26.)	128.6 (30.)		
Trefferlage	0.34 mm	rechts, 0.02 mm tief			
Streuwert	1.78,	horizontal: 2.02, vertikal: 1.50			

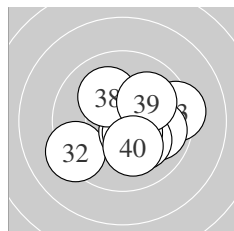

Serie 4:	9.6 →	9.3 ↙	9.3 →	9.9 →	10.2 *
	10.6 *	10.5 *	10.1 ↘	10.0 ↗	10.1 ↓
beste Teiler	91.0	(36.) 112.8 (37.)	200.8 (35.)		
Trefferlage	1.05 mm	rechts, 0.34 mm tief			
Streuwert	1.83,	horizontal: 2.18, vertikal: 1.38			

Unterschrift des Schuetzen

Ergebnis:	379	(394.1)
Serien:	94 97 93 95	
Zaehler:	22 15 3 0 0 0 0 0 0 0	
Innenzehner:	15	
weiteste:	583 (9), 549 (21), 532 (28)	
beste Teiler	84.0 (16.) 102.1 (11.) 112.8 (18.)	
Trefferlage	0.26 mm rechts, 0.23 mm tief	
Streuwert	2.16, horizontal: 2.39, vertikal: 1.90	

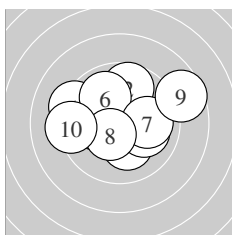
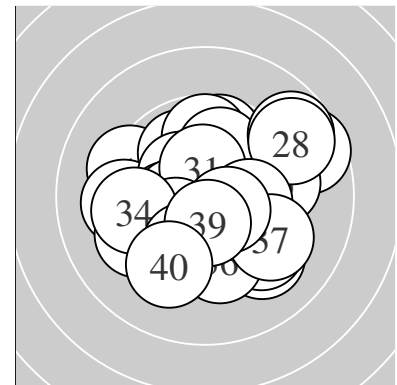

Serie 1:	9.3 ↖	9.7 ↑	10.2 *	10.1 ←	10.1 →
	9.9 ↘	10.0 →	10.4 *	8.6 ↗	9.3 ←
beste Teiler	127.1 (8.) 194.5 (3.) 211.1 (4.)				
Trefferlage	0.10 mm links, 0.51 mm hoch				
Streuwert	2.40, horizontal: 2.97, vertikal: 1.63				

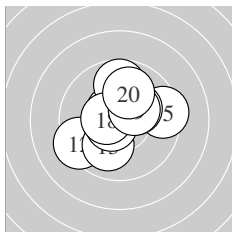

Serie 2:	10.5 *	9.3 ↙	10.0 ↘	9.7 ↑	9.4 →
	10.6 *	10.3 *	10.5 *	10.3 *	10.0 ↑
beste Teiler	84.0 (16.) 102.1 (11.) 112.8 (18.)				
Trefferlage	0.02 mm rechts, 0.43 mm hoch				
Streuwert	1.81, horizontal: 1.94, vertikal: 1.66				

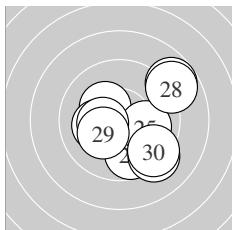

Serie 3:	8.8 ↗	10.3 *	10.2 *	9.7 ↓	10.0 →
	9.2 ↘	10.4 *	8.8 ↗	10.2 *	9.4 ↘
beste Teiler	149.4 (27.) 166.5 (22.) 181.6 (29.)				
Trefferlage	1.20 mm rechts, 0.39 mm tief				
Streuwert	2.40, horizontal: 2.55, vertikal: 2.24				

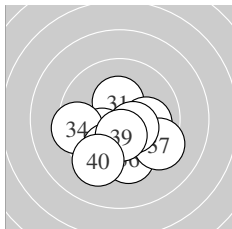

Serie 4:	10.4 *	10.0 →	10.2 *	9.5 ←	9.8 ↘
	9.6 ↓	9.3 ↘	10.4 *	10.4 *	9.3 ↘
beste Teiler	137.0 (38.) 141.6 (39.) 147.5 (31.)				
Trefferlage	0.04 mm links, 1.47 mm tief				
Streuwert	1.83, horizontal: 2.09, vertikal: 1.52				

Unterschrift des Schuetzen

Meyton Elektronik

Ergebnis: **377** (393.2)
 Serien: 94 97 91 95
 Zaehler: 19 19 2 0 0 0 0 0 0 0
 Innenzehner: 13
 weiteste: 666 (2), 534 (25), 499 (14)
 beste Teiler 8.4 (37.) 62.5 (13.) 89.5 (9.)
 Trefferlage 0.95 mm rechts, 0.27 mm hoch
 Streuwert 2.14, horizontal: 2.57, vertikal: 1.59

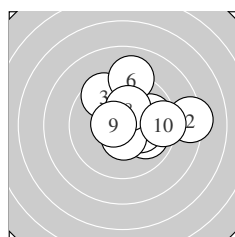
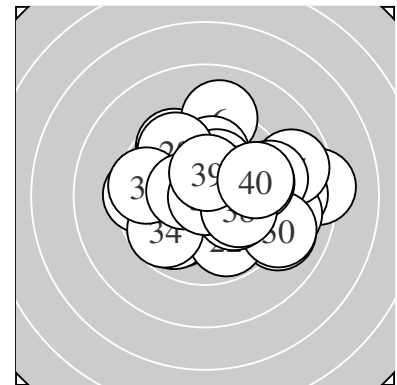

Serie 1:
 10.0 ↘ 8.3 → 9.6 ↖ 10.2 * 9.8 →
 9.1 ↑ 10.5 * 10.3 * 10.6 * 9.4 →
 beste Teiler 89.5 (9.) 118.6 (7.) 172.6 (8.)
 Trefferlage 1.60 mm rechts, 0.80 mm hoch
 Streuwert 2.16, horizontal: 2.46, vertikal: 1.80

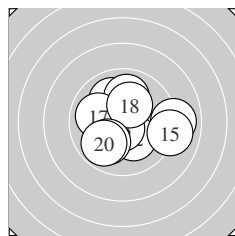

Serie 2:
 10.0 ↖ 10.2 * 10.7 * 9.0 → 9.0 →
 10.0 ↑ 10.0 ← 10.2 * 10.0 ↙ 9.9 ↙
 beste Teiler 62.5 (13.) 181.6 (18.) 188.9 (12.)
 Trefferlage 0.49 mm rechts, 0.02 mm tief
 Streuwert 2.16, horizontal: 2.54, vertikal: 1.69

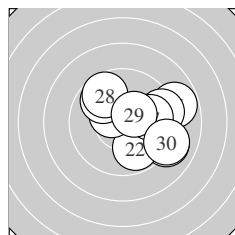

Serie 3:
 9.0 ↘ 9.8 ↘ 10.4 * 9.8 ↖ 8.8 →
 9.4 → 9.9 → 9.7 ↖ 10.4 * 9.1 →
 beste Teiler 128.1 (23.) 136.7 (29.) 275.8 (27.)
 Trefferlage 1.79 mm rechts, 0.28 mm hoch
 Streuwert 2.29, horizontal: 2.66, vertikal: 1.84

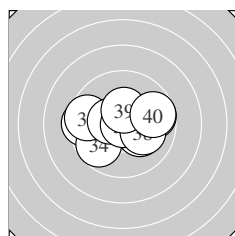

Serie 4:
 9.4 ← 9.7 → 10.2 * 9.7 ↙ 9.5 ←
 10.5 * 10.9 * 10.1 ↘ 10.4 * 9.7 →
 beste Teiler 8.4 (37.) 125.1 (36.) 136.6 (39.)
 Trefferlage 0.09 mm links, 0.02 mm hoch
 Streuwert 1.93, horizontal: 2.54, vertikal: 1.01

Unterschrift des Schuetzen

Meyton Elektronik

Ergebnis: **382** (400.8)
 Serien: 93 95 98 96
 Zaehler: 26 10 4 0 0 0 0 0 0 0
 Innenzehner: 21
 weiteste: 575 (18), 567 (4), 509 (6)
 beste Teiler 41.1 (40.) 50.1 (3.) 67.3 (2.)
 Trefferlage 0.21 mm links, 0.57 mm tief
 Streuwert 1.90, horizontal: 2.18, vertikal: 1.58

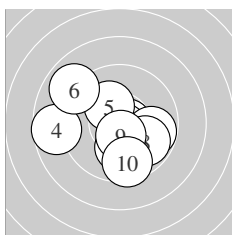
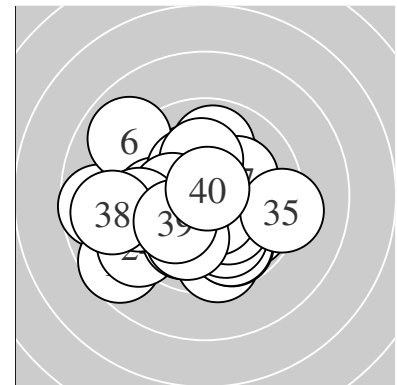

Serie 1:
 10.1 ↓ 10.7 * 10.8 * 8.7 ← 10.2 *
 8.9 ↖ 9.8 → 9.8 ↘ 10.5 * 9.5 ↓
 beste Teiler 50.1 (3.) 67.3 (2.) 110.5 (9.)
 Trefferlage 0.37 mm links, 0.55 mm tief
 Streuwert 2.26, horizontal: 2.63, vertikal: 1.83

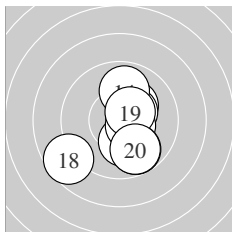

Serie 2:
 10.2 * 10.5 * 10.4 * 9.9 ↑ 10.2 *
 10.5 * 9.8 ↘ 8.7 ↙ 10.5 * 9.8 ↘
 beste Teiler 108.6 (16.) 108.7 (12.) 119.0 (19.)
 Trefferlage 0.43 mm rechts, 0.52 mm tief
 Streuwert 1.91, horizontal: 1.79, vertikal: 2.02

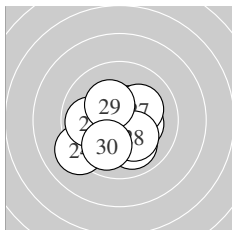

Serie 3:
 10.5 * 10.5 * 10.0 ↘ 9.2 ↙ 9.9 ←
 10.3 * 10.2 * 10.2 * 10.3 * 10.0 ↙
 beste Teiler 109.4 (22.) 109.7 (21.) 162.5 (29.)
 Trefferlage 0.13 mm links, 0.68 mm tief
 Streuwert 1.66, horizontal: 1.85, vertikal: 1.44

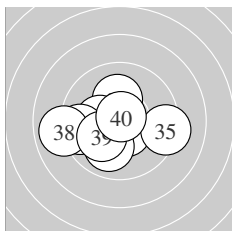

Serie 4:
 10.2 * 10.6 * 10.5 * 10.3 * 9.3 →
 10.0 ↙ 9.5 ← 8.9 ← 10.1 ↙ 10.8 *
 beste Teiler 41.1 (40.) 89.4 (32.) 109.9 (33.)
 Trefferlage 0.77 mm links, 0.54 mm tief
 Streuwert 1.93, horizontal: 2.48, vertikal: 1.13

Unterschrift des Schuetzen

Meyton Elektronik

LG Liga – Wertung – offene Klasse

StartNr: 2

StandNr: 104

25. Februar 2017 15:42

Strillinger, Sonja #70804326

Angerberg / Angerberg

Ergebnis: **395** (408.5)
 Serien: 98 99 99 99
 Zaehler: 35 5 0 0 0 0 0 0 0 0
 Innenzehner: 24
 weiteste: 378 (34), 362 (3), 297 (16)
 beste Teiler 30.5 (40.) 59.1 (11.) 63.6 (4.)
 Trefferlage 0.30 mm links, 0.25 mm tief
 Streuwert 1.39, horizontal: 1.44, vertikal: 1.33

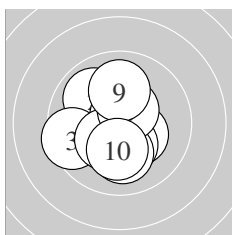
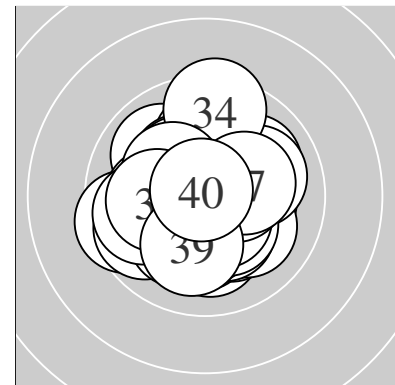

Serie 1:
 10.3 * 9.9 ↘ 9.5 ← 10.7 * 10.3 *
 10.1 ↓ 10.3 * 10.5 * 10.0 ↑ 10.2 *
 beste Teiler 63.6 (4.) 113.4 (8.) 154.5 (1.)
 Trefferlage 0.37 mm links, 0.30 mm tief
 Streuwert 1.51, horizontal: 1.40, vertikal: 1.61

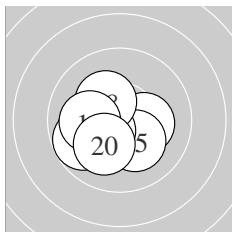

Serie 2:
 10.7 * 10.0 ← 10.2 * 10.0 ← 10.2 *
 9.8 ← 10.4 * 10.3 * 10.1 ← 10.1 ↙
 beste Teiler 59.1 (11.) 133.2 (17.) 168.6 (18.)
 Trefferlage 1.01 mm links, 0.58 mm tief
 Streuwert 1.21, horizontal: 1.47, vertikal: 0.89

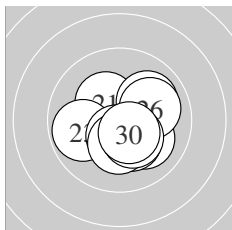

Serie 3:
 10.3 * 10.0 ↗ 9.8 ← 10.1 ↘ 10.3 *
 10.0 → 10.5 * 10.3 * 10.3 * 10.5 *
 beste Teiler 115.0 (30.) 115.9 (27.) 157.0 (29.)
 Trefferlage 0.44 mm rechts, 0.50 mm tief
 Streuwert 1.35, horizontal: 1.50, vertikal: 1.18

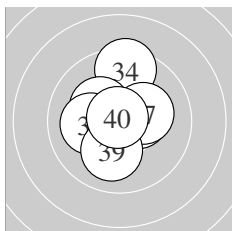

Serie 4:
 10.5 * 10.5 * 10.5 * 9.4 ↑ 10.4 *
 10.3 * 10.2 * 10.1 ← 10.1 ↓ 10.8 *
 beste Teiler 30.5 (40.) 101.6 (31.) 102.2 (33.)
 Trefferlage 0.26 mm links, 0.36 mm hoch
 Streuwert 1.36, horizontal: 1.20, vertikal: 1.50

Unterschrift des Schuetzen

Meyton Elektronik

Ergebnis: **377** (397.9)
 Serien: 94 97 90 96
 Zaehler: 19 19 2 0 0 0 0 0 0 0
 Innenzehner: 14
 weiteste: 607 (27), 558 (7), 478 (2)
 beste Teiler 4.4 (13.) 14.1 (4.) 60.0 (20.)
 Trefferlage 0.48 mm rechts, 0.16 mm hoch
 Streuwert 2.01, horizontal: 2.24, vertikal: 1.74

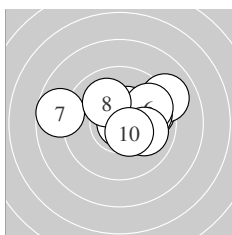
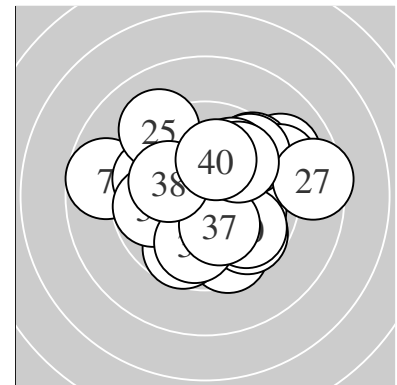

Serie 1:
 9.8 → 9.0 ↗ 9.9 → 10.9 * 10.4 *
 9.7 ↗ 8.7 ← 10.1 ↘ 10.0 → 10.5 *
 beste Teiler 14.1 (4.) 120.3 (10.) 135.4 (5.)
 Trefferlage 0.96 mm rechts, 0.79 mm hoch
 Streuwert 2.09, horizontal: 2.76, vertikal: 1.05

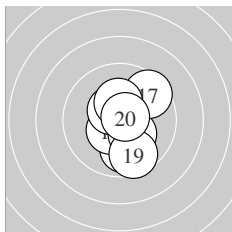

Serie 2:
 9.9 ↓ 10.6 * 10.9 * 10.5 * 10.3 *
 10.5 * 9.5 ↗ 10.3 * 9.6 ↓ 10.7 *
 beste Teiler 4.4 (13.) 60.0 (20.) 94.0 (12.)
 Trefferlage 0.42 mm rechts, 0.37 mm tief
 Streuwert 1.45, horizontal: 1.04, vertikal: 1.76

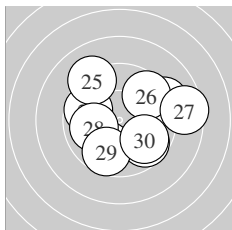

Serie 3:
 9.7 ↘ 9.9 ↓ 9.7 ← 9.2 → 9.2 ↘
 9.6 ↗ 8.5 → 10.0 ← 9.7 ↓ 9.8 ↘
 beste Teiler 247.2 (28.) 265.4 (22.) 288.8 (30.)
 Trefferlage 0.70 mm rechts, 0.02 mm tief
 Streuwert 2.73, horizontal: 3.13, vertikal: 2.26

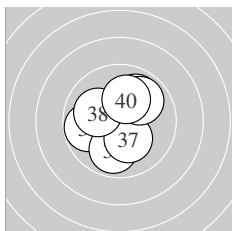

Serie 4:
 10.3 * 10.4 * 9.8 ← 9.9 ↓ 10.2 *
 9.9 ↗ 10.2 * 10.1 ← 9.9 ↗ 10.1 ↑
 beste Teiler 149.8 (32.) 175.1 (31.) 179.7 (37.)
 Trefferlage 0.15 mm links, 0.25 mm hoch
 Streuwert 1.67, horizontal: 1.58, vertikal: 1.74

Unterschrift des Schuetzen

Ergebnis: **380** (399.3)
 Serien: 97 95 93 95
 Zaehler: 20 20 0 0 0 0 0 0 0 0
 Innenzehner: 13
 weiteste: 449 (25), 382 (22), 382 (36)
 beste Teiler 72.0 (15.) 81.4 (1.) 82.4 (38.)
 Trefferlage 0.39 mm links, 0.26 mm hoch
 Streuwert 1.82, horizontal: 2.12, vertikal: 1.45

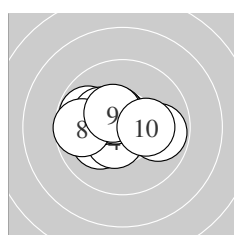
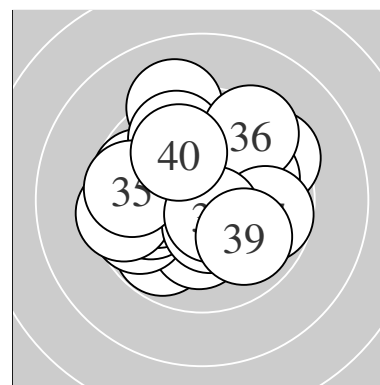

Serie 1:
 10.6 * 9.8 ↖ 10.1 ↙ 10.5 * 9.8 →
 10.2 * 10.5 * 9.7 ← 10.4 * 10.2 *
 beste Teiler 81.4 (1.) 108.4 (7.) 113.4 (4.)
 Trefferlage 0.69 mm links, 0.21 mm hoch
 Streuwert 1.42, horizontal: 1.84, vertikal: 0.81

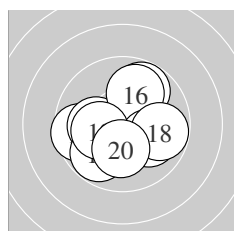

Serie 2:
 9.6 ← 9.8 ↗ 10.1 ← 9.8 ↘ 10.7 *
 9.9 ↗ 10.0 ↘ 9.8 → 10.2 * 10.2 *
 beste Teiler 72.0 (15.) 183.9 (19.) 191.5 (20.)
 Trefferlage 0.11 mm links, 0.24 mm tief
 Streuwert 1.83, horizontal: 2.04, vertikal: 1.59

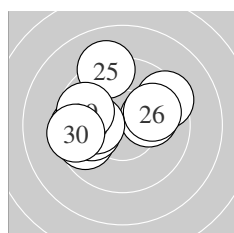

Serie 3:
 9.6 ← 9.4 ↗ 9.7 ← 10.1 → 9.2 ↗
 9.9 → 10.0 ← 10.1 ← 9.7 ↖ 9.5 ←
 beste Teiler 209.0 (28.) 210.3 (24.) 244.5 (27.)
 Trefferlage 1.09 mm links, 0.63 mm hoch
 Streuwert 2.17, horizontal: 2.61, vertikal: 1.60

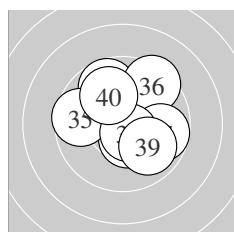

Serie 4:
 9.7 ↖ 10.5 * 10.3 * 10.5 * 9.6 ←
 9.4 ↗ 9.7 → 10.6 * 9.9 ↘ 10.0 ↖
 beste Teiler 82.4 (38.) 103.2 (32.) 122.0 (34.)
 Trefferlage 0.34 mm rechts, 0.46 mm hoch
 Streuwert 1.82, horizontal: 1.92, vertikal: 1.72

Unterschrift des Schuetzen

Meyton Elektronik

Ergebnis: **374** (393.0)
 Serien: 95 94 93 92
 Zaehler: 15 24 1 0 0 0 0 0 0 0
 Innenzehner: 11
 weiteste: 516 (24), 479 (21), 433 (1)
 beste Teiler 17.0 (25.) 74.5 (30.) 81.4 (33.)
 Trefferlage 0.26 mm links, 0.42 mm tief
 Streuwert 2.16, horizontal: 2.47, vertikal: 1.81

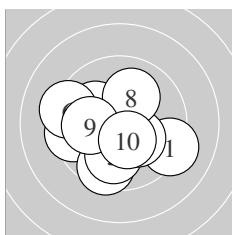
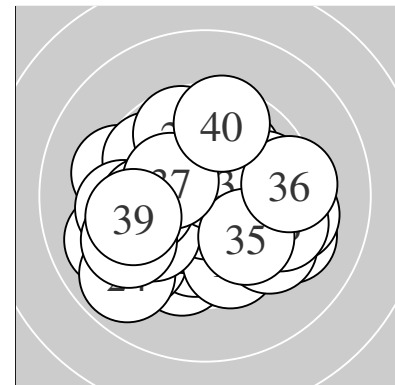

Serie 1:
 9.2 ↘ 10.1 ↖ 9.5 ← 9.5 ↓ 9.9 ↓
 9.3 ← 10.2 * 10.1 ↑ 10.0 ← 10.4 *
 beste Teiler 143.1 (10.) 179.3 (7.) 214.3 (2.)
 Trefferlage 0.65 mm links, 0.69 mm tief
 Streuwert 2.10, horizontal: 2.43, vertikal: 1.70

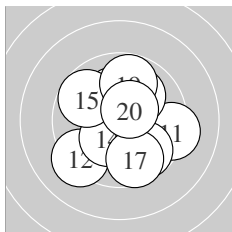

Serie 2:
 9.3 → 9.3 ↙ 10.2 * 10.3 * 9.7 ↖
 9.8 ↘ 9.7 ↓ 10.0 ↗ 9.8 ↑ 10.5 *
 beste Teiler 114.6 (20.) 163.6 (14.) 195.7 (13.)
 Trefferlage 0.29 mm rechts, 0.13 mm tief
 Streuwert 2.17, horizontal: 2.12, vertikal: 2.22

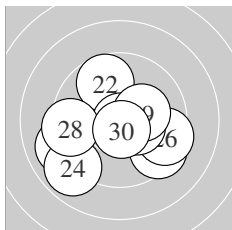

Serie 3:
 9.0 ← 9.7 ↖ 9.4 ↘ 8.9 ↙ 10.9 *
 9.5 → 10.4 * 9.4 ← 10.2 * 10.7 *
 beste Teiler 17.0 (25.) 74.5 (30.) 142.0 (27.)
 Trefferlage 0.30 mm links, 0.77 mm tief
 Streuwert 2.38, horizontal: 2.86, vertikal: 1.78

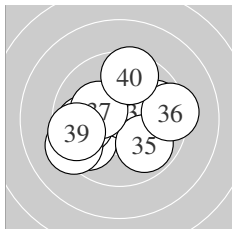

Serie 4:
 9.8 → 9.7 ↙ 10.6 * 9.9 ← 9.9 ↘
 9.4 → 10.3 * 9.3 ↙ 9.6 ← 9.6 ↑
 beste Teiler 81.4 (33.) 175.5 (37.) 271.5 (35.)
 Trefferlage 0.38 mm links, 0.10 mm tief
 Streuwert 2.25, horizontal: 2.70, vertikal: 1.67

Unterschrift des Schuetzen

Meyton Elektronik

Ergebnis: **374** (393.3)
 Serien: 96 93 90 95
 Zaehler: 19 16 5 0 0 0 0 0 0 0
 Innenzehner: 17
 weiteste: 675 (38), 637 (28), 531 (14)
 beste Teiler 60.8 (36.) 71.1 (2.) 76.8 (12.)
 Trefferlage 0.45 mm links, 0.08 mm hoch
 Streuwert 2.30, horizontal: 2.37, vertikal: 2.22

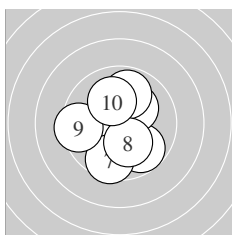
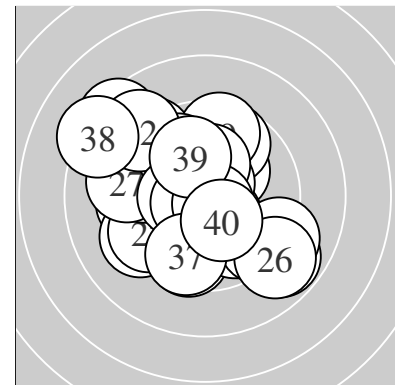

Serie 1:
 9.8 ↘ 10.7 * 10.6 * 10.2 * 10.2 *
 9.9 ↑ 9.6 ↓ 10.2 * 9.4 ← 10.1 ↑
 beste Teiler 71.1 (2.) 81.7 (3.) 176.0 (4.)
 Trefferlage 0.08 mm links, 0.01 mm tief
 Streuwert 1.81, horizontal: 1.57, vertikal: 2.01

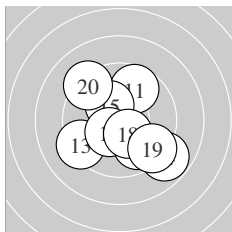

Serie 2:
 9.7 ↑ 10.6 * 9.3 ↙ 8.8 ↘ 10.3 *
 9.8 ↘ 10.4 * 10.4 * 9.4 ↘ 9.2 ↖
 beste Teiler 76.8 (12.) 144.6 (17.) 146.8 (18.)
 Trefferlage 0.23 mm rechts, 0.61 mm tief
 Streuwert 2.38, horizontal: 2.44, vertikal: 2.31

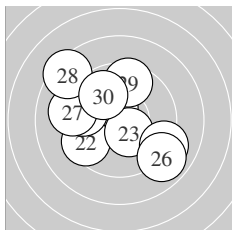

Serie 3:
 10.5 * 9.5 ↙ 10.4 * 9.6 ← 9.1 ↘
 8.9 ↘ 9.2 ← 8.4 ↖ 9.5 ↑ 9.9 ↖
 beste Teiler 117.6 (21.) 141.8 (23.) 274.5 (30.)
 Trefferlage 0.79 mm links, 0.37 mm hoch
 Streuwert 2.88, horizontal: 3.18, vertikal: 2.54

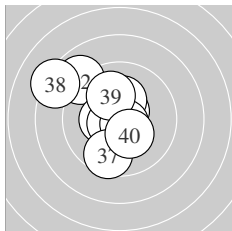

Serie 4:
 10.6 * 8.9 ↖ 10.4 * 10.6 * 10.3 *
 10.7 * 9.6 ↓ 8.3 ↖ 10.0 ↑ 10.3 *
 beste Teiler 60.8 (36.) 84.9 (34.) 85.4 (31.)
 Trefferlage 1.15 mm links, 0.60 mm hoch
 Streuwert 2.12, horizontal: 2.12, vertikal: 2.12

Unterschrift des Schuetzen

Meyton Elektronik

Ergebnis: **380** (398.2)
 Serien: 93 97 95 95
 Zaehler: 21 18 1 0 0 0 0 0 0 0
 Innenzehner: 17
 weiteste: 563 (18), 476 (22), 449 (31)
 beste Teiler 47.6 (20.) 65.8 (39.) 83.8 (30.)
 Trefferlage 0.99 mm rechts, 0.54 mm hoch
 Streuwert 1.81, horizontal: 2.23, vertikal: 1.26

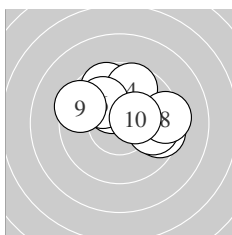
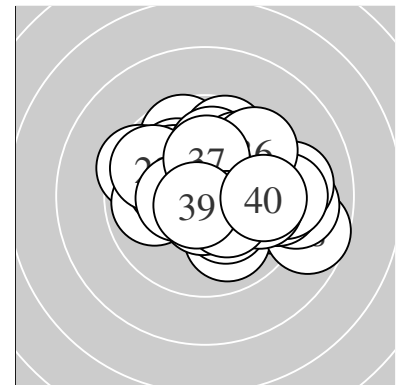

Serie 1:
 10.4 * 9.5 → 9.7 ↖ 9.7 ↑ 9.5 →
 10.0 ↘ 9.8 → 9.3 → 9.5 ↖ 10.4 *
 beste Teiler 142.6 (10.) 149.4 (1.) 230.3 (6.)
 Trefferlage 0.96 mm rechts, 1.03 mm hoch
 Streuwert 2.02, horizontal: 2.54, vertikal: 1.32

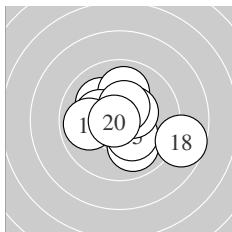

Serie 2:
 10.1 ↘ 10.0 ↘ 10.0 ↑ 10.3 * 10.3 *
 9.9 ← 10.4 * 8.7 → 10.5 * 10.8 *
 beste Teiler 47.6 (20.) 123.9 (19.) 130.5 (17.)
 Trefferlage 0.30 mm rechts, 0.03 mm hoch
 Streuwert 1.88, horizontal: 2.22, vertikal: 1.48

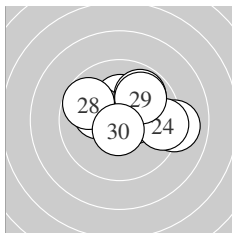

Serie 3:
 10.5 * 9.0 → 10.5 * 9.4 → 10.3 *
 10.2 * 9.8 ↗ 9.7 ↖ 9.9 ↗ 10.6 *
 beste Teiler 83.8 (30.) 105.5 (23.) 124.0 (21.)
 Trefferlage 0.91 mm rechts, 0.73 mm hoch
 Streuwert 1.78, horizontal: 2.28, vertikal: 1.08

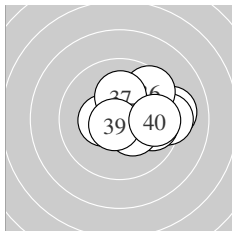

Serie 4:
 9.2 → 9.3 → 9.8 → 10.2 * 10.4 *
 9.6 ↗ 10.2 * 10.4 * 10.7 * 9.7 →
 beste Teiler 65.8 (39.) 137.5 (35.) 148.3 (38.)
 Trefferlage 1.79 mm rechts, 0.38 mm hoch
 Streuwert 1.58, horizontal: 1.95, vertikal: 1.10

Unterschrift des Schuetzen

Meyton Elektronik

Ergebnis: **365** (379.1)
 Serien: 94 92 88 91
 Zaehler: 15 17 6 2 0 0 0 0 0 0
 Innenzehner: 10
 weiteste: 885 (9), 849 (25), 703 (35)
 beste Teiler 82.2 (1.) 93.3 (33.) 97.1 (7.)
 Trefferlage 0.41 mm rechts, 0.62 mm tief
 Streuwert 2.95, horizontal: 3.18, vertikal: 2.70

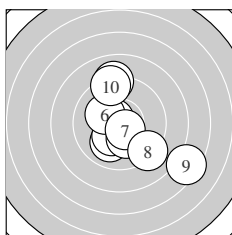
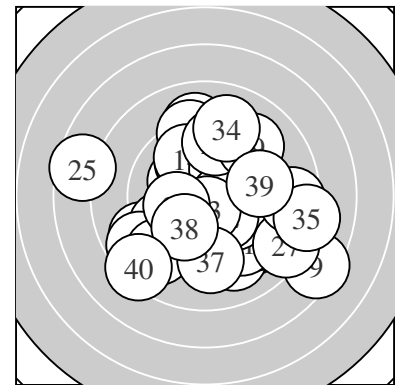

Serie 1:
 10.6 * 9.0 ↑ 10.0 ↙ 10.3 * 10.2 *
 10.2 * 10.6 * 9.2 ↘ 7.4 ↘ 9.2 ↑
 beste Teiler 82.2 (1.) 97.1 (7.) 167.0 (4.)
 Trefferlage 0.60 mm rechts, 0.33 mm tief
 Streuwert 2.91, horizontal: 2.80, vertikal: 3.01

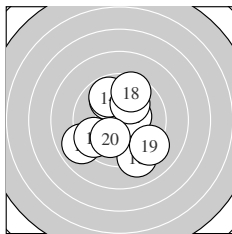

Serie 2:
 8.9 ↙ 10.4 * 9.9 ↖ 9.8 ↖ 9.6 ↙
 9.1 ↘ 10.1 ↗ 9.6 ↑ 9.2 ↘ 10.1 ↙
 beste Teiler 143.2 (12.) 217.2 (17.) 222.8 (20.)
 Trefferlage 0.14 mm links, 0.32 mm tief
 Streuwert 2.52, horizontal: 2.37, vertikal: 2.67

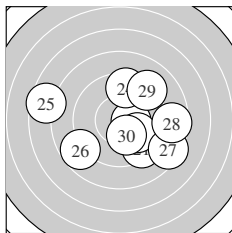

Serie 3:
 9.4 ↘ 10.4 * 10.0 ↘ 9.5 ↑ 7.6 ↖
 8.7 ↙ 8.4 ↘ 8.6 → 9.1 ↗ 10.2 *
 beste Teiler 129.4 (22.) 185.7 (30.) 244.4 (23.)
 Trefferlage 0.89 mm rechts, 0.43 mm tief
 Streuwert 3.58, horizontal: 4.31, vertikal: 2.64

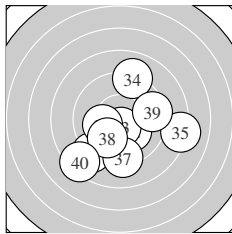

Serie 4:
 9.0 ↙ 10.2 * 10.6 * 9.0 ↑ 8.1 →
 10.1 ← 9.2 ↓ 9.9 ↙ 9.4 → 8.3 ↙
 beste Teiler 93.3 (33.) 195.1 (32.) 203.0 (36.)
 Trefferlage 0.29 mm rechts, 1.40 mm tief
 Streuwert 3.05, horizontal: 3.33, vertikal: 2.75

Unterschrift des Schuetzen

Meyton Elektronik

Ergebnis:	392	(408.2)
Serien:	97 97 100 98	
Zaehler:	32 8 0 0 0 0 0 0 0 0	
Innenzehner:	24	
weiteste:	379 (40), 340 (2), 330 (18)	
beste Teiler	51.3 (22.) 58.4 (14.) 82.6 (19.)	
Trefferlage	0.08 mm rechts, 0.45 mm hoch	
Streuwert	1.43, horizontal: 1.58, vertikal: 1.25	

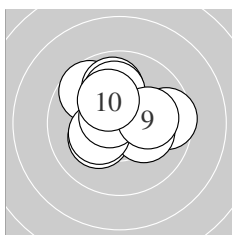
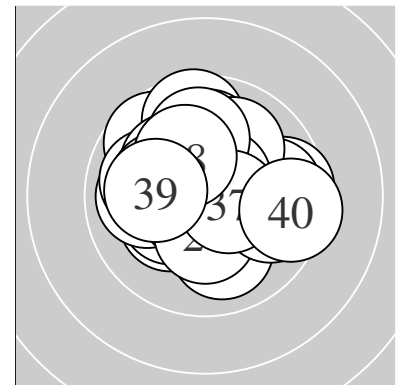

Serie 1:	9.7 ↘	9.6 →	9.9 ↑	10.0 ↑	10.2 *
	10.2 *	10.3 *	10.6 *	10.1 →	10.2 *
beste Teiler	85.4 (8.)	164.5 (7.)	183.3 (5.)		
Trefferlage	0.04 mm links, 0.75 mm hoch				
Streuwert	1.60, horizontal: 1.81, vertikal: 1.35				

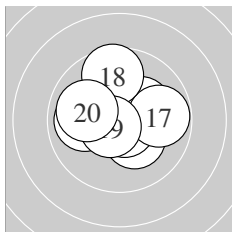

Serie 2:	10.5 *	10.3 *	10.2 *	10.7 *	9.9 ←
	10.6 *	9.8 →	9.6 ↑	10.6 *	10.0 ←
beste Teiler	58.4 (14.)	82.6 (19.)	93.6 (16.)		
Trefferlage	0.02 mm links, 0.26 mm hoch				
Streuwert	1.49, horizontal: 1.68, vertikal: 1.27				

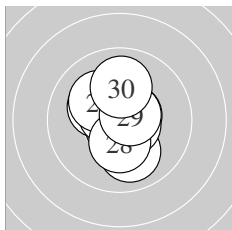

Serie 3:	10.2 *	10.7 *	10.6 *	10.0 ↓	10.6 *
	10.2 *	10.6 *	10.3 *	10.6 *	10.0 ↑
beste Teiler	51.3 (22.)	82.7 (27.)	85.8 (29.)		
Trefferlage	0.08 mm links, 0.12 mm hoch				
Streuwert	1.16, horizontal: 0.92, vertikal: 1.36				

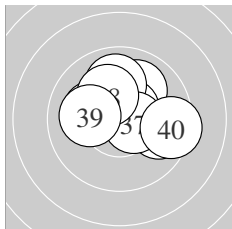

Serie 4:	10.6 *	9.8 →	10.0 ↗	10.6 *	10.0 ↑
	10.2 *	10.5 *	10.2 *	10.1 ←	9.4 →
beste Teiler	93.4 (31.)	94.0 (34.)	105.9 (37.)		
Trefferlage	0.49 mm rechts, 0.67 mm hoch				
Streuwert	1.55, horizontal: 1.89, vertikal: 1.10				

Unterschrift des Schuetzen

Ergebnis: **395** (411.8)
 Serien: 99 99 99 98
 Zaehler: 35 5 0 0 0 0 0 0 0 0
 Innenzehner: 28
 weiteste: 431 (31), 391 (27), 365 (40)
 beste Teiler 26.4 (37.) 31.0 (19.) 40.0 (20.)
 Trefferlage 0.30 mm rechts, 0.47 mm tief
 Streuwert 1.31, horizontal: 1.45, vertikal: 1.15

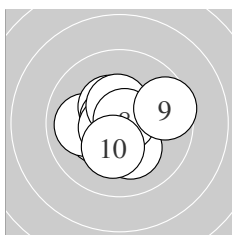
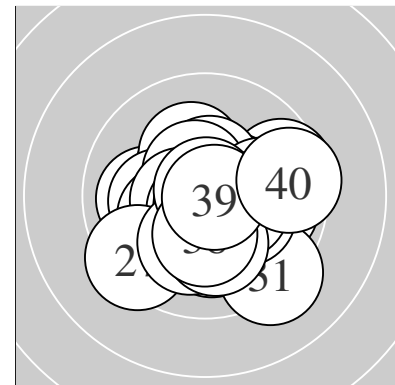

Serie 1:
 10.2 * 10.3 * 10.0 ← 10.4 * 10.7 *
 10.6 * 10.5 * 10.8 * 9.6 → 10.3 *
 beste Teiler 42.1 (8.) 66.7 (5.) 76.5 (6.)
 Trefferlage 0.21 mm links, 0.05 mm tief
 Streuwert 1.31, horizontal: 1.51, vertikal: 1.08

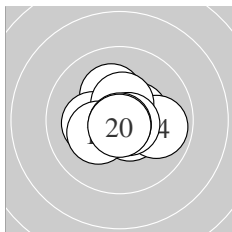

Serie 2:
 10.6 * 10.2 * 10.4 * 9.9 → 10.2 *
 10.5 * 10.2 * 10.7 * 10.8 * 10.8 *
 beste Teiler 31.0 (19.) 40.0 (20.) 68.0 (18.)
 Trefferlage 0.13 mm rechts, 0.01 mm hoch
 Streuwert 1.10, horizontal: 1.31, vertikal: 0.86

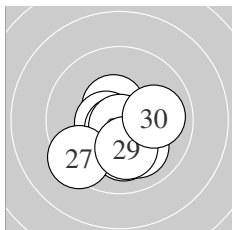

Serie 3:
 10.5 * 10.6 * 10.1 ↓ 10.7 * 10.2 *
 10.8 * 9.4 ↙ 10.0 ↘ 10.1 ↓ 10.0 →
 beste Teiler 41.1 (26.) 65.3 (24.) 98.6 (22.)
 Trefferlage 0.17 mm rechts, 0.87 mm tief
 Streuwert 1.36, horizontal: 1.51, vertikal: 1.19

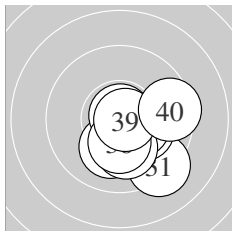

Serie 4:
 9.2 ↘ 10.3 * 10.2 * 10.1 ↓ 10.4 *
 10.1 ↓ 10.8 * 10.3 * 10.8 * 9.5 →
 beste Teiler 26.4 (37.) 40.4 (39.) 143.8 (35.)
 Trefferlage 1.13 mm rechts, 0.96 mm tief
 Streuwert 1.28, horizontal: 1.34, vertikal: 1.23

Unterschrift des Schuetzen

Meyton Elektronik

Ergebnis:	392	(408.4)
Serien:	97	99 99 97
Zaehler:	32	8 0 0 0 0 0 0 0 0
Innenzehner:	24	
weiteste:	451	(36), 390 (20), 317 (32)
beste Teiler	32.8	(22.) 42.4 (28.) 76.8 (21.)
Trefferlage	0.10 mm	links, 0.26 mm hoch
Streuwert	1.47,	horizontal: 1.56, vertikal: 1.37

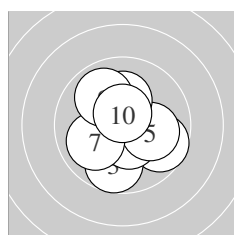
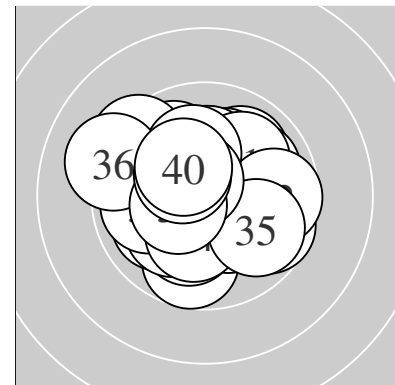

Serie 1:

9.7 ↘	10.4 *	9.7 ↓	10.5 *	10.1 →
10.3 *	10.0 ↙	10.2 *	9.9 ↖	10.6 *
beste Teiler	91.0 (10.)	124.4 (4.)	138.7 (2.)	
Trefferlage	0.05 mm links, 0.12 mm tief			
Streuwert	1.61, horizontal: 1.56, vertikal: 1.67			

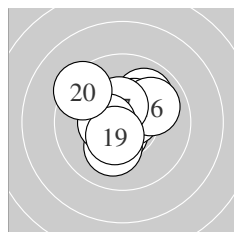

Serie 2:

10.0 ↗	10.6 *	10.6 *	10.1 ↓	10.4 *
10.0 ↗	10.4 *	10.5 *	10.5 *	9.4 ↖
beste Teiler	79.0 (13.)	90.7 (12.)	119.2 (19.)	
Trefferlage	0.08 mm links, 0.44 mm hoch			
Streuwert	1.45, horizontal: 1.51, vertikal: 1.39			

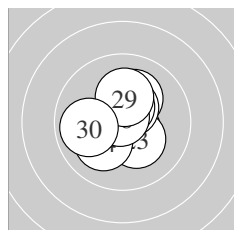

Serie 3:

10.6 *	10.8 *	10.3 *	10.1 ↙	10.2 *
10.5 *	10.5 *	10.8 *	10.2 *	9.9 ←
beste Teiler	32.8 (22.)	42.4 (28.)	76.8 (21.)	
Trefferlage	0.11 mm links, 0.28 mm hoch			
Streuwert	1.17, horizontal: 1.13, vertikal: 1.21			

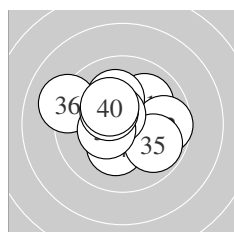

Serie 4:

10.0 ↗	9.7 →	10.1 ↖	10.2 *	9.8 ↘
9.1 ↖	10.6 *	10.4 *	10.4 *	10.3 *
beste Teiler	85.1 (37.)	131.2 (38.)	142.8 (39.)	
Trefferlage	0.18 mm links, 0.45 mm hoch			
Streuwert	1.76, horizontal: 2.12, vertikal: 1.31			

Unterschrift des Schuetzen

Meyton Elektronik

Ergebnis: **389** (407.7)
 Serien: 97 97 99 96
 Zaehler: 29 11 0 0 0 0 0 0 0 0
 Innenzehner: 24
 weiteste: 444 (38), 399 (3), 348 (31)
 beste Teiler 30.1 (36.) 56.7 (30.) 60.0 (39.)
 Trefferlage 0.28 mm rechts, 0.41 mm hoch
 Streuwert 1.49, horizontal: 1.57, vertikal: 1.40

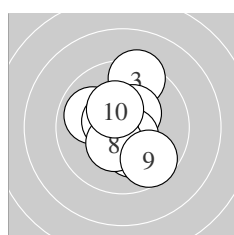
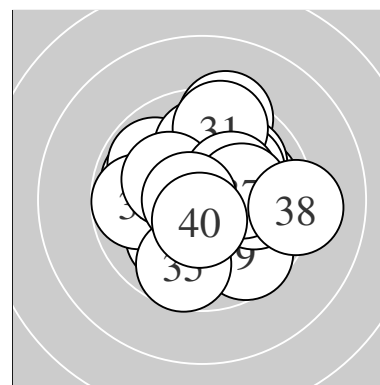

Serie 1:
 10.6 * 10.2 * 9.4 ↑ 9.9 ↖ 10.4 *
 10.6 * 10.5 * 10.4 * 9.7 ↘ 10.3 *
 beste Teiler 92.9 (1.) 93.8 (6.) 108.2 (7.)
 Trefferlage 0.12 mm rechts, 0.07 mm hoch
 Streuwert 1.58, horizontal: 1.27, vertikal: 1.85

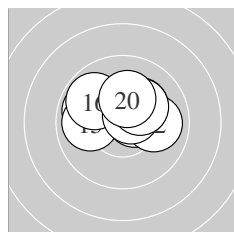

Serie 2:
 10.6 * 10.0 → 9.9 ↖ 10.2 * 9.9 ←
 9.8 ↖ 10.3 * 10.6 * 10.2 * 10.2 *
 beste Teiler 84.6 (18.) 98.7 (11.) 157.8 (17.)
 Trefferlage 0.05 mm rechts, 0.89 mm hoch
 Streuwert 1.37, horizontal: 1.81, vertikal: 0.69

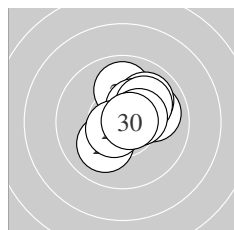

Serie 3:
 10.0 → 9.9 ↑ 10.7 * 10.0 ↗ 10.4 *
 10.1 ↗ 10.1 ↙ 10.4 * 10.6 * 10.7 *
 beste Teiler 56.7 (30.) 75.6 (23.) 86.0 (29.)
 Trefferlage 0.72 mm rechts, 0.59 mm hoch
 Streuwert 1.17, horizontal: 1.15, vertikal: 1.19

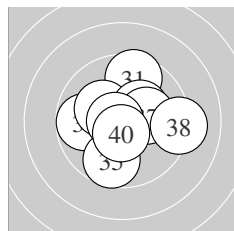

Serie 4:
 9.6 ↑ 9.8 ← 10.2 * 10.3 * 9.7 ↓
 10.8 * 10.2 * 9.2 → 10.7 * 10.6 *
 beste Teiler 30.1 (36.) 60.0 (39.) 96.7 (40.)
 Trefferlage 0.23 mm rechts, 0.10 mm hoch
 Streuwert 1.85, horizontal: 2.04, vertikal: 1.62

Unterschrift des Schuetzen

Meyton Elektronik

Ergebnis: **387** (405.3)
 Serien: 98 98 97 94
 Zaehler: 28 11 1 0 0 0 0 0 0 0
 Innenzehner: 21
 weiteste: 555 (32), 328 (39), 320 (31)
 beste Teiler 22.8 (30.) 30.4 (36.) 80.3 (27.)
 Trefferlage 0.38 mm links, 0.02 mm tief
 Streuwert 1.60, horizontal: 1.73, vertikal: 1.47

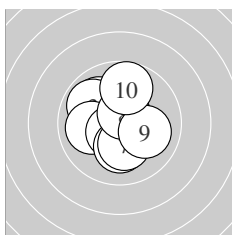
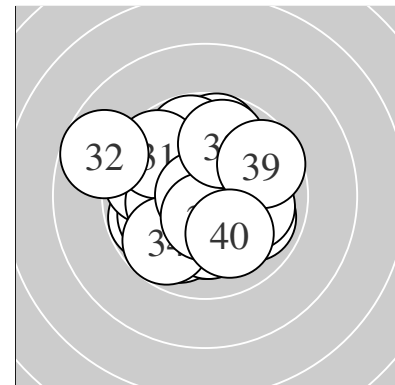

Serie 1:
 10.3 * 10.0 ↘ 9.9 ↘ 10.0 ← 10.6 *
 10.2 * 10.2 * 10.6 * 10.0 → 9.7 ↑
 beste Teiler 92.4 (8.) 97.1 (5.) 153.0 (1.)
 Trefferlage 0.41 mm links, 0.28 mm hoch
 Streuwert 1.53, horizontal: 1.41, vertikal: 1.63

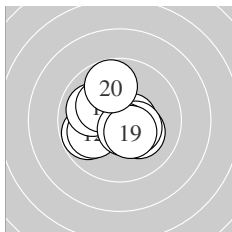

Serie 2:
 9.8 ← 10.0 ← 10.0 ↘ 10.6 * 10.2 *
 10.2 * 10.4 * 10.6 * 10.4 * 9.8 ↑
 beste Teiler 84.5 (18.) 90.0 (14.) 135.2 (19.)
 Trefferlage 0.43 mm links, 0.05 mm tief
 Streuwert 1.49, horizontal: 1.65, vertikal: 1.32

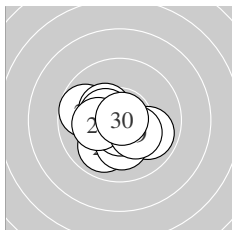

Serie 3:
 9.7 ↘ 10.3 * 9.9 ↘ 10.4 * 9.9 ↙
 10.2 * 10.6 * 10.2 * 10.3 * 10.9 *
 beste Teiler 22.8 (30.) 80.3 (27.) 127.4 (24.)
 Trefferlage 0.42 mm links, 0.52 mm tief
 Streuwert 1.35, horizontal: 1.57, vertikal: 1.09

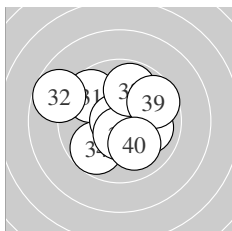

Serie 4:
 9.7 ↘ 8.7 ↘ 10.5 * 9.8 ↙ 10.0 →
 10.8 * 10.5 * 9.8 ↑ 9.6 → 10.0 ↘
 beste Teiler 30.4 (36.) 105.0 (37.) 107.9 (33.)
 Trefferlage 0.27 mm links, 0.17 mm hoch
 Streuwert 2.12, horizontal: 2.39, vertikal: 1.82

Unterschrift des Schuetzen

Meyton Elektronik

Ergebnis: **377** (392.3)
 Serien: 94 93 93 97
 Zaehler: 21 15 4 0 0 0 0 0 0 0
 Innenzehner: 15
 weiteste: 705 (19), 628 (21), 537 (1)
 beste Teiler 38.2 (29.) 63.0 (40.) 98.4 (28.)
 Trefferlage 0.22 mm rechts, 0.90 mm hoch
 Streuwert 2.24, horizontal: 2.67, vertikal: 1.69

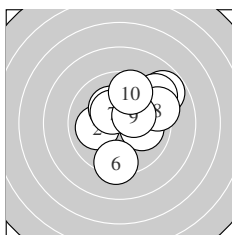
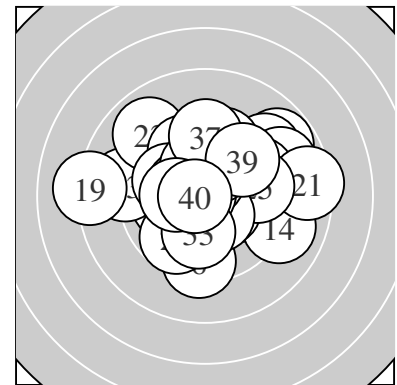

Serie 1:
 8.8 ↗ 10.0 ← 10.2 * 9.1 ↗ 10.0 →
 9.4 ↓ 10.4 * 9.3 → 10.3 * 9.6 ↑
 beste Teiler 135.6 (7.) 165.6 (9.) 178.1 (3.)
 Trefferlage 1.24 mm rechts, 0.89 mm hoch
 Streuwert 2.23, horizontal: 2.29, vertikal: 2.16

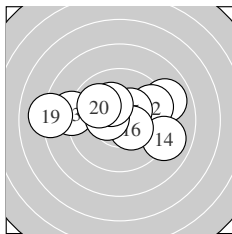

Serie 2:
 9.0 → 9.6 → 9.0 ← 9.0 → 10.4 *
 10.4 * 10.4 * 10.2 * 8.1 ← 9.9 ↖
 beste Teiler 127.5 (17.) 142.0 (16.) 148.5 (15.)
 Trefferlage 0.15 mm links, 0.61 mm hoch
 Streuwert 2.86, horizontal: 3.86, vertikal: 1.18

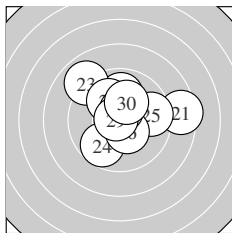

Serie 3:
 8.4 → 9.9 ↑ 8.9 ↘ 9.7 ✓ 9.7 →
 10.4 * 10.0 ↘ 10.6 * 10.8 * 10.2 *
 beste Teiler 38.2 (29.) 98.4 (28.) 140.0 (26.)
 Trefferlage 0.46 mm rechts, 0.89 mm hoch
 Streuwert 2.28, horizontal: 2.67, vertikal: 1.82

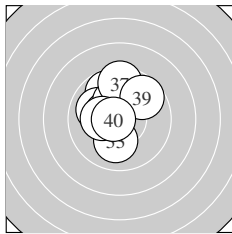

Serie 4:
 10.0 ↑ 9.8 ↘ 10.1 ↓ 10.0 ↖ 10.4 *
 10.2 * 9.5 ↑ 10.2 * 9.7 ↗ 10.7 *
 beste Teiler 63.0 (40.) 143.0 (35.) 176.1 (38.)
 Trefferlage 0.64 mm links, 1.20 mm hoch
 Streuwert 1.48, horizontal: 1.23, vertikal: 1.69

Unterschrift des Schuetzen

Meyton Elektronik

Ergebnis: **363** (381.8)
 Serien: 89 89 91 94
 Zaehler: 12 20 7 1 0 0 0 0 0 0
 Innenzehner: 10
 weiteste: 845 (8), 747 (14), 682 (22)
 beste Teiler 25.7 (36.) 78.0 (27.) 80.9 (19.)
 Trefferlage 0.25 mm links, 0.44 mm hoch
 Streuwert 2.82, horizontal: 3.56, vertikal: 1.80

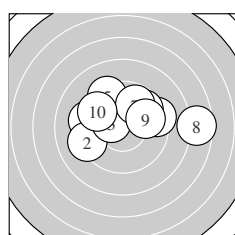
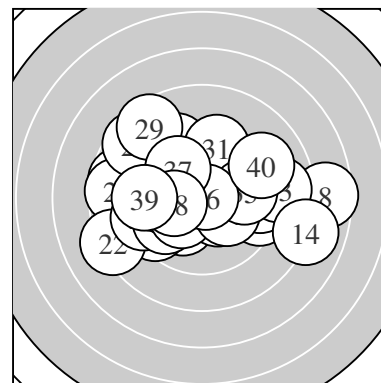

Serie 1:
 9.3 ← 9.2 ← 10.4 * 9.3 → 9.4 ↖
 9.7 ↗ 9.8 ↗ 7.6 → 9.8 → 9.6 ↖
 beste Teiler 138.3 (3.) 279.3 (9.) 294.5 (7.)
 Trefferlage 0.48 mm rechts, 1.18 mm hoch
 Streuwert 3.00, horizontal: 4.00, vertikal: 1.43

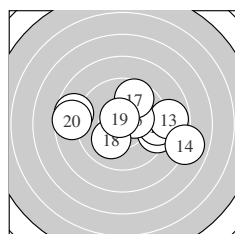

Serie 2:
 9.3 → 9.4 → 8.8 → 8.0 → 10.3 *
 8.7 ← 9.7 ↗ 10.1 ↙ 10.6 * 8.6 ←
 beste Teiler 80.9 (19.) 151.2 (15.) 214.6 (18.)
 Trefferlage 0.99 mm rechts, 0.13 mm hoch
 Streuwert 3.25, horizontal: 4.34, vertikal: 1.52

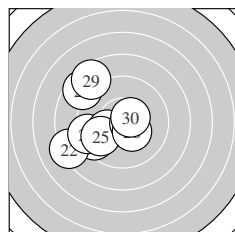

Serie 3:
 9.4 ← 8.2 ← 9.3 ← 10.2 * 9.8 ↖
 8.6 ↖ 10.6 * 10.3 * 8.5 ↖ 10.5 *
 beste Teiler 78.0 (27.) 104.9 (30.) 152.0 (28.)
 Trefferlage 2.30 mm links, 0.10 mm tief
 Streuwert 2.51, horizontal: 2.51, vertikal: 2.52

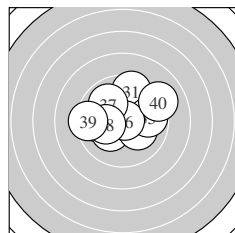

Serie 4:
 9.5 ↗ 9.7 ← 10.2 * 10.1 ↘ 9.8 →
 10.9 * 9.9 ↖ 10.2 * 9.4 ← 9.1 →
 beste Teiler 25.7 (36.) 183.6 (33.) 194.5 (38.)
 Trefferlage 0.20 mm links, 0.54 mm hoch
 Streuwert 2.15, horizontal: 2.63, vertikal: 1.52

Unterschrift des Schuetzen

Meyton Elektronik

Ergebnis: **378** (397.7)
 Serien: 96 94 92 96
 Zaehler: 20 18 2 0 0 0 0 0 0 0
 Innenzehner: 14
 weiteste: 591 (25), 511 (15), 430 (22)
 beste Teiler 50.2 (13.) 96.0 (37.) 96.8 (11.)
 Trefferlage 0.14 mm links, 0.71 mm hoch
 Streuwert 1.94, horizontal: 2.39, vertikal: 1.36

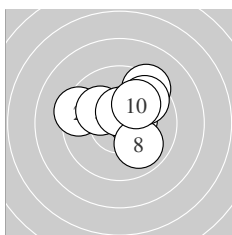
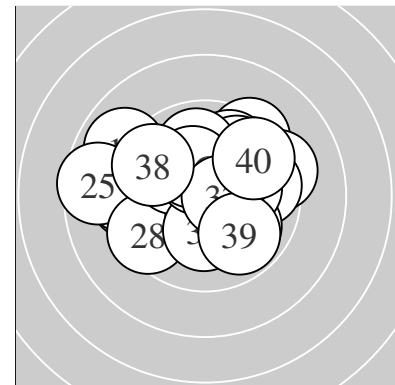

Serie 1:
 10.4 * 9.4 ← 10.5 * 10.5 * 10.1 ↘
 9.4 ↗ 10.5 * 9.9 ↘ 9.7 ↗ 10.0 ↗
 beste Teiler 105.0 (7.) 122.1 (4.) 125.9 (3.)
 Trefferlage 0.54 mm rechts, 1.07 mm hoch
 Streuwert 1.65, horizontal: 1.94, vertikal: 1.30

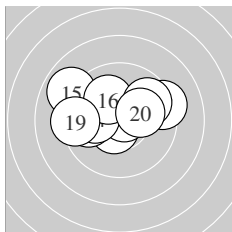

Serie 2:
 10.6 * 9.8 ← 10.8 * 10.1 ← 8.9 ↘
 10.1 ↘ 9.3 → 9.8 ↗ 9.3 ← 10.2 *
 beste Teiler 50.2 (13.) 96.8 (11.) 200.8 (20.)
 Trefferlage 0.63 mm links, 0.74 mm hoch
 Streuwert 2.14, horizontal: 2.83, vertikal: 1.09

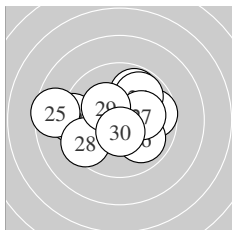

Serie 3:
 9.8 ↗ 9.2 ← 9.7 → 9.8 ↗ 8.6 ←
 9.9 ↘ 10.1 → 9.5 ↙ 10.3 * 10.5 *
 beste Teiler 106.2 (30.) 171.8 (29.) 202.8 (27.)
 Trefferlage 0.44 mm links, 0.29 mm hoch
 Streuwert 2.41, horizontal: 3.06, vertikal: 1.50

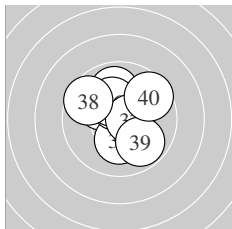

Serie 4:
 10.1 ↘ 9.9 ↑ 10.2 * 10.4 * 10.5 *
 10.3 * 10.6 * 9.6 ↘ 9.8 ↘ 9.6 ↗
 beste Teiler 96.0 (37.) 116.0 (35.) 126.5 (34.)
 Trefferlage 0.02 mm links, 0.75 mm hoch
 Streuwert 1.60, horizontal: 1.62, vertikal: 1.59

Unterschrift des Schuetzen

Meyton Elektronik

Ergebnis:	392	(409.5)								
Serien:	97	98	99	98						
Zaehler:	32	8	0	0	0	0	0	0	0	
Innenzehner:	24									
weiteste:	444 (1), 411 (15), 339 (31)									
beste Teiler	38.8 (25.) 47.0 (32.) 49.0 (30.)									
Trefferlage	0.09 mm rechts, 0.24 mm hoch									
Streuwert	1.44, horizontal: 1.65, vertikal: 1.19									

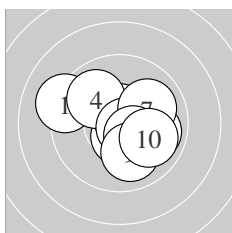
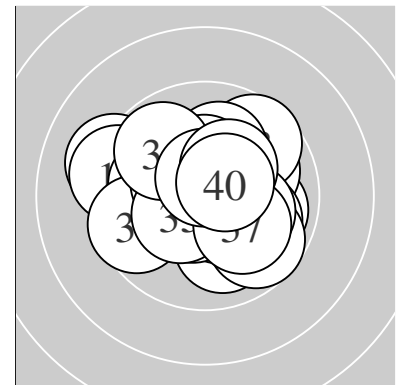

Serie 1:	9.2 ↙	10.5 *	10.6 *	9.9 ↘	10.7 *
	9.9 →	10.0 ↗	10.4 *	10.0 ↓	10.0 ↘
beste Teiler	54.4 (5.) 77.0 (3.) 101.0 (2.)				
Trefferlage	0.31 mm rechts, 0.09 mm tief				
Streuwert	1.72, horizontal: 2.03, vertikal: 1.34				

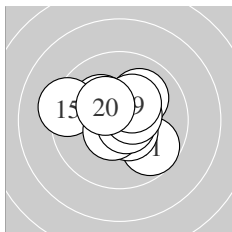

Serie 2:	9.7 ↘	10.0 ↗	10.5 *	10.2 *	9.3 ↙
	10.6 *	10.7 *	10.5 *	10.3 *	10.3 *
beste Teiler	59.3 (17.) 99.2 (16.) 108.0 (18.)				
Trefferlage	0.00 mm , 0.27 mm hoch				
Streuwert	1.55, horizontal: 1.82, vertikal: 1.21				

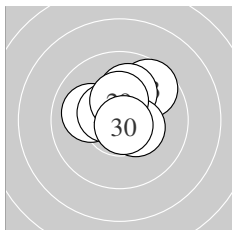

Serie 3:	10.6 *	10.4 *	9.6 ↗	10.1 ↑	10.8 *
	10.0 ↙	10.5 *	10.4 *	10.4 *	10.8 *
beste Teiler	38.8 (25.) 49.0 (30.) 77.6 (21.)				
Trefferlage	0.23 mm rechts, 0.74 mm hoch				
Streuwert	1.12, horizontal: 1.20, vertikal: 1.04				

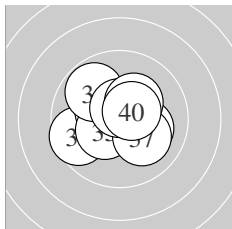

Serie 4:	9.6 ↙	10.8 *	10.1 ↘	10.4 *	10.4 *
	9.8 ↘	10.1 ↘	10.6 *	10.3 *	10.5 *
beste Teiler	47.0 (32.) 84.0 (38.) 110.9 (40.)				
Trefferlage	0.17 mm links, 0.07 mm hoch				
Streuwert	1.43, horizontal: 1.65, vertikal: 1.16				

Unterschrift des Schuetzen

Meyton Elektronik

Ergebnis: **398** (418.0)
 Serien: 98 100 100 100
 Zaehler: 38 2 0 0 0 0 0 0 0 0
 Innenzehner: 34
 weiteste: 350 (3), 335 (7), 236 (14)
 beste Teiler 8.2 (4.) 9.8 (18.) 38.8 (12.)
 Trefferlage 0.00 mm , 0.19 mm tief
 Streuwert 1.05, horizontal: 1.21, vertikal: 0.85

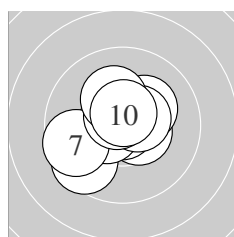
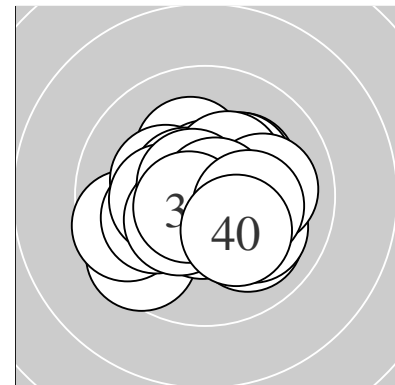

Serie 1:
 10.5 * 10.2 * 9.6 ↙ 10.9 * 10.5 *
 10.5 * 9.6 ↙ 10.7 * 10.2 * 10.6 *
 beste Teiler 8.2 (4.) 71.8 (8.) 81.2 (10.)
 Trefferlage 0.41 mm links, 0.02 mm hoch
 Streuwert 1.36, horizontal: 1.51, vertikal: 1.20

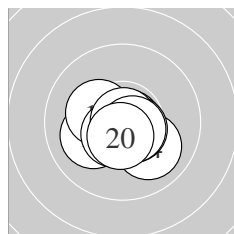

Serie 2:
 10.1 ↙ 10.8 * 10.7 * 10.0 ↘ 10.6 *
 10.3 * 10.6 * 10.9 * 10.6 * 10.6 *
 beste Teiler 9.8 (18.) 38.8 (12.) 64.0 (13.)
 Trefferlage 0.01 mm links, 0.49 mm tief
 Streuwert 0.90, horizontal: 1.11, vertikal: 0.62

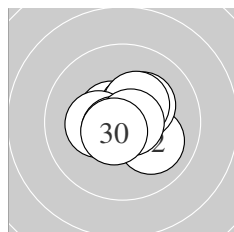

Serie 3:
 10.7 * 10.0 ↘ 10.6 * 10.3 * 10.5 *
 10.4 * 10.3 * 10.7 * 10.7 * 10.6 *
 beste Teiler 55.0 (29.) 71.3 (21.) 73.5 (28.)
 Trefferlage 0.11 mm rechts, 0.12 mm hoch
 Streuwert 0.97, horizontal: 1.11, vertikal: 0.80

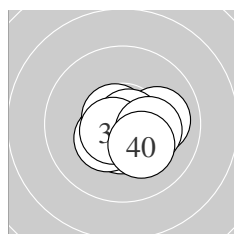

Serie 4:
 10.5 * 10.6 * 10.7 * 10.4 * 10.0 →
 10.7 * 10.8 * 10.6 * 10.2 * 10.2 *
 beste Teiler 42.4 (37.) 51.2 (33.) 68.6 (36.)
 Trefferlage 0.28 mm rechts, 0.43 mm tief
 Streuwert 0.91, horizontal: 1.14, vertikal: 0.60

Unterschrift des Schuetzen

Ergebnis: **396** (413.3)
 Serien: 96 100 100 100
 Zaehler: 36 4 0 0 0 0 0 0 0 0
 Innenzehner: 30
 weiteste: 380 (3), 336 (1), 276 (4)
 beste Teiler 13.3 (35.) 31.7 (19.) 41.1 (9.)
 Trefferlage 0.00 mm , 0.28 mm tief
 Streuwert 1.23, horizontal: 1.33, vertikal: 1.12

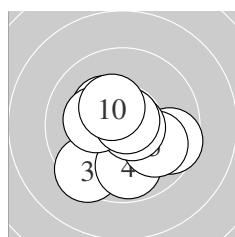
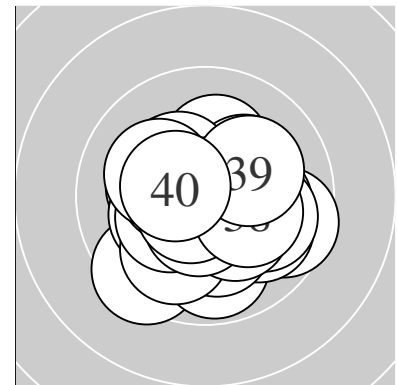

Serie 1:
 9.6 → 10.1 ↓ 9.4 ↙ 9.8 ↓ 9.9 →
 10.7 * 10.3 * 10.2 * 10.8 * 10.4 *
 beste Teiler 41.1 (9.) 67.9 (6.) 141.3 (10.)
 Trefferlage 0.07 mm rechts, 0.73 mm tief
 Streuwert 1.63, horizontal: 1.71, vertikal: 1.54

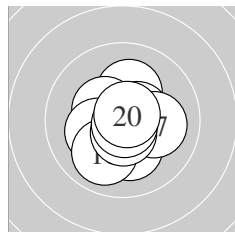

Serie 2:
 10.2 * 10.4 * 10.2 * 10.5 * 10.2 *
 10.0 ↙ 10.1 → 10.6 * 10.8 * 10.8 *
 beste Teiler 31.7 (19.) 48.4 (20.) 86.2 (18.)
 Trefferlage 0.04 mm rechts, 0.29 mm tief
 Streuwert 1.17, horizontal: 1.14, vertikal: 1.20

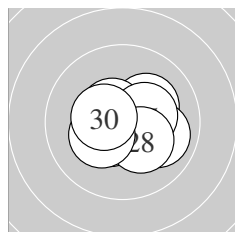

Serie 3:
 10.2 * 10.0 → 10.5 * 10.6 * 10.3 *
 10.4 * 10.5 * 10.3 * 10.3 * 10.4 *
 beste Teiler 92.1 (24.) 101.1 (23.) 109.6 (27.)
 Trefferlage 0.05 mm rechts, 0.21 mm tief
 Streuwert 1.15, horizontal: 1.43, vertikal: 0.79

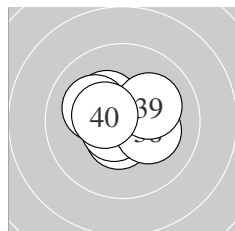

Serie 4:
 10.8 * 10.8 * 10.3 * 10.5 * 10.9 *
 10.7 * 10.1 ↖ 10.2 * 10.1 → 10.4 *
 beste Teiler 13.3 (35.) 44.7 (31.) 48.5 (32.)
 Trefferlage 0.18 mm links, 0.09 mm hoch
 Streuwert 0.99, horizontal: 1.18, vertikal: 0.76

Unterschrift des Schuetzen

Meyton Elektronik

