

Ergebnis: **388** (405.3)
 Serien: 97 94 98 99
 Zähler: 28 12 0 0 0 0 0 0 0 0
 Innenzehner: 21
 weiteste: 470 (1), 427 (10), 397 (13)
 beste Teiler 17.1 (27.) 42.4 (22.) 54.7 (3.)
 Trefferlage 0.13 mm links, 0.07 mm tief
 Streuwert 1.65, horizontal: 1.75, vertikal: 1.55

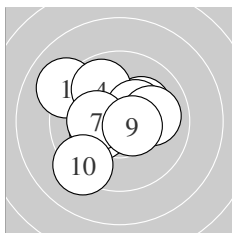

Serie 1:
 9.1 ↘ 10.2 * 10.7 * 9.9 ↘ 10.4 *
 10.3 * 10.3 * 10.0 → 10.5 * 9.2 ↙
 beste Teiler 54.7 (3.) 101.2 (9.) 146.8 (5.)
 Trefferlage 0.57 mm links, 0.28 mm hoch
 Streuwert 1.86, horizontal: 2.06, vertikal: 1.65

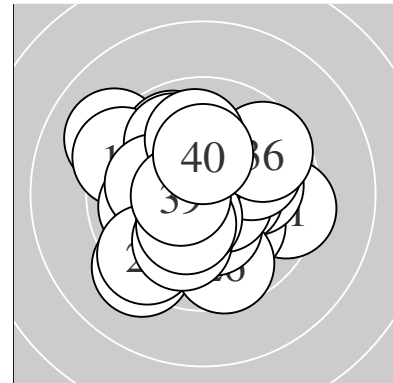
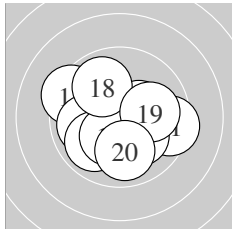

Serie 2:
 9.4 → 10.1 ↘ 9.4 ↘ 9.9 ← 10.3 *
 9.9 ↙ 10.3 * 9.9 ↘ 10.0 → 9.9 ↓
 beste Teiler 152.4 (15.) 159.7 (17.) 202.2 (12.)
 Trefferlage 0.07 mm links, 0.35 mm tief
 Streuwert 1.97, horizontal: 2.32, vertikal: 1.54

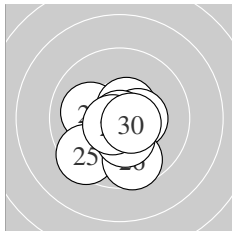

Serie 3:
 10.1 ← 10.8 * 10.6 * 10.4 * 9.5 ↘
 9.6 ↓ 10.9 * 10.4 * 10.7 * 10.6 *
 beste Teiler 17.1 (27.) 42.4 (22.) 72.1 (29.)
 Trefferlage 0.11 mm links, 0.75 mm tief
 Streuwert 1.29, horizontal: 1.30, vertikal: 1.29

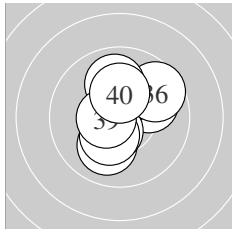

Serie 4:
 10.5 * 10.0 ↗ 10.3 * 10.0 ↓ 10.5 *
 9.6 ↗ 10.0 ↑ 10.3 * 10.6 * 10.2 *
 beste Teiler 100.3 (39.) 114.5 (31.) 114.9 (35.)
 Trefferlage 0.21 mm rechts, 0.53 mm hoch
 Streuwert 1.44, horizontal: 1.28, vertikal: 1.58

Unterschrift des Schützen

Ergebnis: **388** (405.2)
 Serien: 98 97 97 96
 Zähler: 28 12 0 0 0 0 0 0 0 0
 Innenzehner: 22
 weiteste: 476 (16), 470 (20), 460 (29)
 beste Teiler 45.6 (31.) 52.6 (6.) 55.7 (25.)
 Trefferlage 0.22 mm links, 0.82 mm hoch
 Streuwert 1.61, horizontal: 1.50, vertikal: 1.71

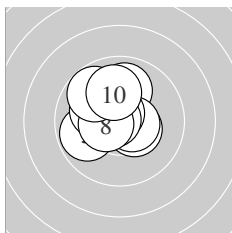
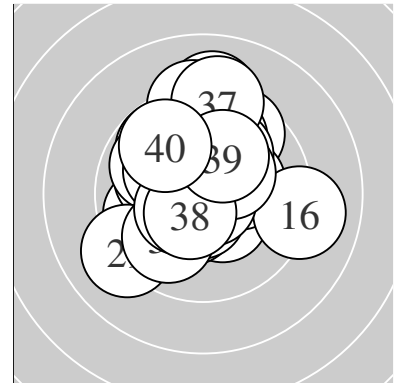

Serie 1:
 10.0 ↑ 10.4 * 10.5 * 10.7 * 9.8 ←
 10.7 * 10.2 * 10.5 * 9.8 ↘ 10.0 ↑
 beste Teiler 52.6 (6.) 68.0 (4.) 103.5 (3.)
 Trefferlage 0.61 mm links, 0.65 mm hoch
 Streuwert 1.28, horizontal: 1.28, vertikal: 1.27

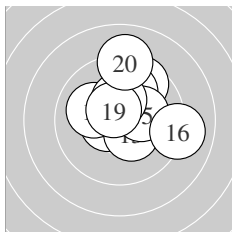

Serie 2:
 10.6 * 9.6 ↗ 10.4 * 10.0 ↑ 10.2 *
 9.0 → 10.1 ↖ 10.3 * 10.6 * 9.1 ↑
 beste Teiler 95.8 (19.) 100.2 (11.) 143.0 (13.)
 Trefferlage 0.68 mm rechts, 1.14 mm hoch
 Streuwert 1.82, horizontal: 1.84, vertikal: 1.80

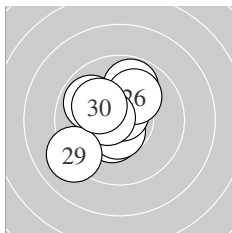

Serie 3:
 10.4 * 10.6 * 10.7 * 9.8 ↑ 10.7 *
 10.1 ↗ 10.6 * 9.9 ↘ 9.1 ↙ 10.2 *
 beste Teiler 55.7 (25.) 74.3 (23.) 92.3 (22.)
 Trefferlage 0.70 mm links, 0.37 mm hoch
 Streuwert 1.56, horizontal: 1.50, vertikal: 1.62

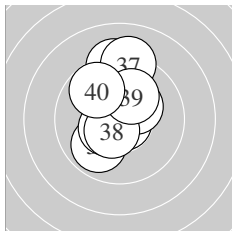

Serie 4:
 10.8 * 10.3 * 9.2 ↑ 9.9 ↙ 10.4 *
 10.4 * 9.2 ↑ 10.5 * 10.1 ↑ 9.8 ↘
 beste Teiler 45.6 (31.) 111.5 (38.) 130.9 (35.)
 Trefferlage 0.25 mm links, 1.13 mm hoch
 Streuwert 1.72, horizontal: 1.09, vertikal: 2.18

Unterschrift des Schützen

Meyton Elektronik

Ergebnis: **391** (413.7)
 Serien: 97 99 98 97
 Zähler: 31 9 0 0 0 0 0 0 0 0
 Innenzehner: 29
 weiteste: 399 (29), 375 (5), 304 (25)
 beste Teiler 19.1 (21.) 34.8 (23.) 49.3 (30.)
 Trefferlage 0.05 mm rechts, 0.39 mm tief
 Streuwert 1.24, horizontal: 1.31, vertikal: 1.18

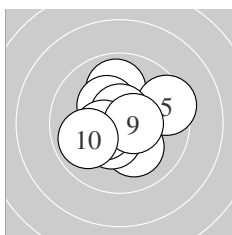
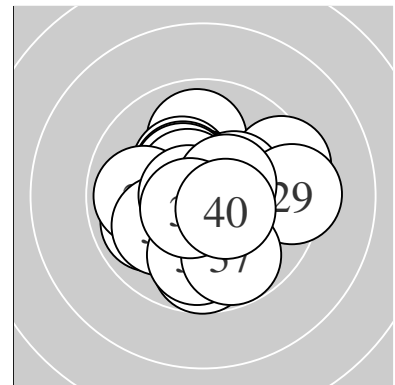

Serie 1:
 10.3 * 9.9 ↑ 10.1 ↘ 10.3 * 9.5 →
 10.4 * 10.7 * 10.4 * 10.5 * 9.9 ←
 beste Teiler 69.1 (7.) 103.0 (9.) 130.7 (8.)
 Trefferlage 0.11 mm links, 0.03 mm hoch
 Streuwert 1.53, horizontal: 1.66, vertikal: 1.39

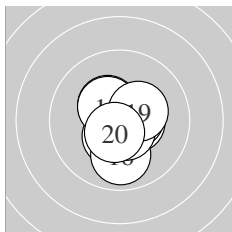

Serie 2:
 10.5 * 10.4 * 10.8 * 10.4 * 10.5 *
 9.9 ↓ 10.6 * 10.4 * 10.3 * 10.6 *
 beste Teiler 49.8 (13.) 87.8 (17.) 99.5 (20.)
 Trefferlage 0.13 mm rechts, 0.22 mm tief
 Streuwert 1.02, horizontal: 0.85, vertikal: 1.16

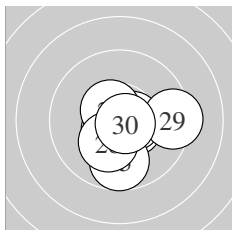

Serie 3:
 10.9 * 10.5 * 10.8 * 10.6 * 9.7 ↓
 10.6 * 10.5 * 10.2 * 9.4 → 10.8 *
 beste Teiler 19.1 (21.) 34.8 (23.) 49.3 (30.)
 Trefferlage 0.37 mm rechts, 0.57 mm tief
 Streuwert 1.25, horizontal: 1.42, vertikal: 1.06

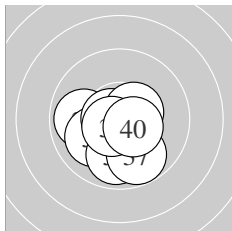

Serie 4:
 9.9 ← 10.7 * 10.0 ↙ 10.7 * 10.7 *
 9.9 ↓ 9.8 ↘ 10.5 * 10.6 * 10.5 *
 beste Teiler 65.0 (35.) 65.2 (32.) 66.3 (34.)
 Trefferlage 0.18 mm links, 0.81 mm tief
 Streuwert 1.19, horizontal: 1.30, vertikal: 1.08

Unterschrift des Schützen

Meyton Elektronik

Ergebnis: **385** (402.5)
 Serien: 97 95 97 96
 Zähler: 25 15 0 0 0 0 0 0 0 0
 Innenzehner: 19
 weiteste: 417 (14), 390 (19), 381 (35)
 beste Teiler 81.0 (2.) 84.7 (8.) 94.3 (26.)
 Trefferlage 0.13 mm links, 0.04 mm hoch
 Streuwert 1.71, horizontal: 1.79, vertikal: 1.62

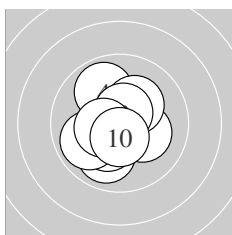
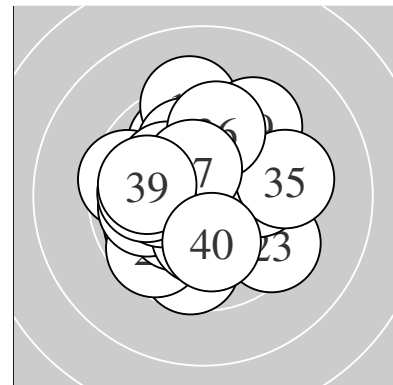

Serie 1:
 9.9 ↘ 10.6 * 10.3 * 9.9 ↗ 10.2 *
 10.2 * 9.9 ↙ 10.6 * 10.4 * 10.5 *
 beste Teiler 81.0 (2.) 84.7 (8.) 106.0 (10.)
 Trefferlage 0.41 mm links, 0.31 mm tief
 Streuwert 1.32, horizontal: 1.21, vertikal: 1.43

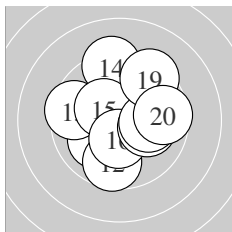

Serie 2:
 10.0 ↙ 9.7 ↓ 9.5 ← 9.3 ↑ 10.4 *
 10.4 * 10.1 → 10.1 → 9.4 ↗ 9.6 →
 beste Teiler 142.2 (16.) 150.6 (15.) 215.8 (17.)
 Trefferlage 0.22 mm rechts, 0.25 mm hoch
 Streuwert 2.17, horizontal: 2.16, vertikal: 2.17

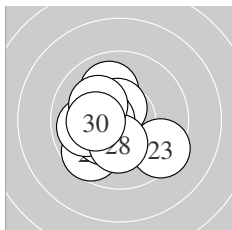

Serie 3:
 9.7 ↙ 10.0 ↗ 9.4 ↘ 10.3 * 9.9 ←
 10.6 * 10.5 * 10.2 * 10.2 * 10.2 *
 beste Teiler 94.3 (26.) 109.0 (27.) 168.3 (24.)
 Trefferlage 0.84 mm links, 0.38 mm tief
 Streuwert 1.56, horizontal: 1.60, vertikal: 1.52

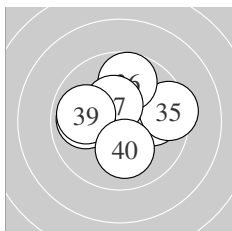

Serie 4:
 10.4 * 10.2 * 10.0 → 10.5 * 9.4 →
 9.7 ↑ 10.4 * 9.9 ← 9.9 ← 10.1 ↓
 beste Teiler 114.2 (34.) 131.6 (37.) 144.0 (31.)
 Trefferlage 0.49 mm rechts, 0.60 mm hoch
 Streuwert 1.67, horizontal: 1.99, vertikal: 1.27

Unterschrift des Schützen

Ergebnis: **385** (404.4)
 Serien: 98 96 94 97
 Zähler: 26 13 1 0 0 0 0 0 0 0
 Innenzehner: 19
 weiteste: 557 (23), 366 (17), 323 (25)
 beste Teiler 52.8 (5.) 62.3 (6.) 64.6 (27.)
 Trefferlage 0.07 mm links, 0.01 mm tief
 Streuwert 1.68, horizontal: 1.75, vertikal: 1.59

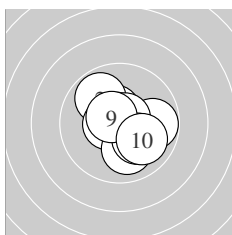
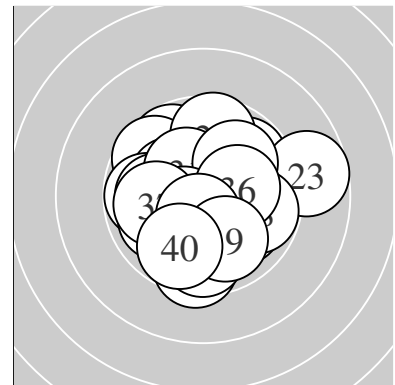

Serie 1:
 10.5 * 9.9 ↖ 10.6 * 9.8 → 10.7 *
 10.7 * 10.0 ↓ 10.1 ↘ 10.6 * 10.0 ↘
 beste Teiler 52.8 (5.) 62.3 (6.) 88.4 (9.)
 Trefferlage 0.34 mm rechts, 0.04 mm tief
 Streuwert 1.38, horizontal: 1.44, vertikal: 1.31

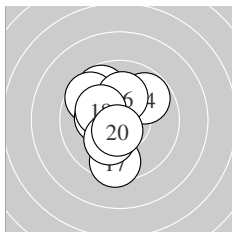

Serie 2:
 9.7 ↖ 10.4 * 9.7 ↖ 9.8 ↗ 10.3 *
 10.1 ↑ 9.5 ↓ 10.2 * 10.2 * 10.6 *
 beste Teiler 93.3 (20.) 144.8 (12.) 173.1 (15.)
 Trefferlage 0.70 mm links, 0.46 mm hoch
 Streuwert 1.69, horizontal: 1.33, vertikal: 1.99

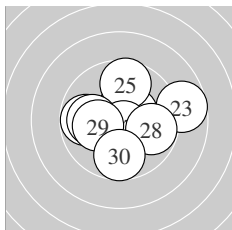

Serie 3:
 9.8 ← 10.4 * 8.7 → 10.5 * 9.7 ↑
 10.0 ← 10.7 * 9.8 → 10.2 * 9.7 ↓
 beste Teiler 64.6 (27.) 124.9 (24.) 137.9 (22.)
 Trefferlage 0.34 mm rechts, 0.13 mm hoch
 Streuwert 2.11, horizontal: 2.50, vertikal: 1.63

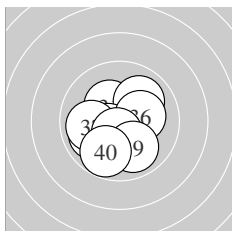

Serie 4:
 10.3 * 10.0 ↗ 10.5 * 9.9 ↙ 10.4 *
 10.2 * 10.0 ← 10.5 * 9.9 ↓ 9.8 ↙
 beste Teiler 110.6 (38.) 122.0 (33.) 128.0 (35.)
 Trefferlage 0.28 mm links, 0.59 mm tief
 Streuwert 1.48, horizontal: 1.54, vertikal: 1.42

Unterschrift des Schützen

Meyton Elektronik

Ergebnis: **379** (400.5)
 Serien: 95 95 93 96
 Zähler: 22 15 3 0 0 0 0 0 0 0
 Innenzehner: 18
 weiteste: 591 (10), 554 (23), 513 (15)
 beste Teiler 29.6 (32.) 76.0 (40.) 77.0 (36.)
 Trefferlage 0.46 mm links, 0.19 mm hoch
 Streuwert 1.90, horizontal: 2.12, vertikal: 1.65

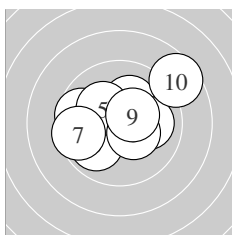
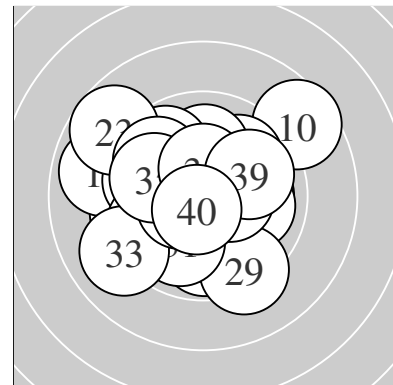

Serie 1:
 10.4 * 9.6 ← 9.9 ↙ 10.2 * 10.2 *
 10.0 → 9.5 ← 10.4 * 10.4 * 8.6 ↗
 beste Teiler 129.0 (9.) 141.7 (8.) 149.5 (1.)
 Trefferlage 0.12 mm rechts, 0.55 mm hoch
 Streuwert 2.11, horizontal: 2.57, vertikal: 1.51

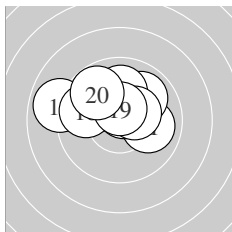

Serie 2:
 10.0 → 9.9 ↗ 10.6 * 10.4 * 8.9 ←
 10.0 ↑ 10.4 * 9.8 ← 10.6 * 9.8 ↘
 beste Teiler 77.8 (13.) 95.0 (19.) 133.4 (14.)
 Trefferlage 0.43 mm links, 1.14 mm hoch
 Streuwert 1.70, horizontal: 2.24, vertikal: 0.85

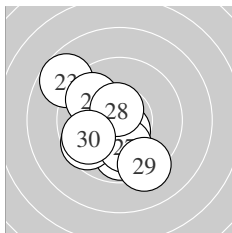

Serie 3:
 10.6 * 10.6 * 8.7 ↘ 9.8 ↓ 9.6 ↙
 9.8 ↘ 10.1 ↓ 10.6 * 9.3 ↓ 9.8 ↙
 beste Teiler 91.2 (28.) 94.9 (21.) 95.8 (22.)
 Trefferlage 1.03 mm links, 0.67 mm tief
 Streuwert 2.06, horizontal: 1.94, vertikal: 2.17

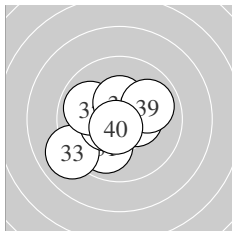

Serie 4:
 9.9 ↙ 10.8 * 9.0 ↙ 10.5 * 9.9 ←
 10.6 * 10.4 * 10.4 * 9.9 → 10.6 *
 beste Teiler 29.6 (32.) 76.0 (40.) 77.0 (36.)
 Trefferlage 0.50 mm links, 0.23 mm tief
 Streuwert 1.61, horizontal: 1.80, vertikal: 1.38

Unterschrift des Schützen

Meyton Elektronik

Ergebnis: **381** (397.4)
 Serien: 94 97 91 99
 Zähler: 24 13 3 0 0 0 0 0 0 0
 Innenzehner: 19
 weiteste: 600 (21), 550 (7), 516 (11)
 beste Teiler 11.4 (28.) 47.7 (17.) 76.2 (31.)
 Trefferlage 0.03 mm rechts, 0.10 mm tief
 Streuwert 2.10, horizontal: 2.44, vertikal: 1.69

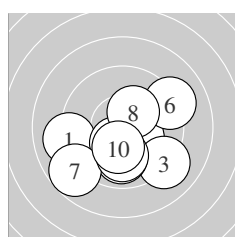
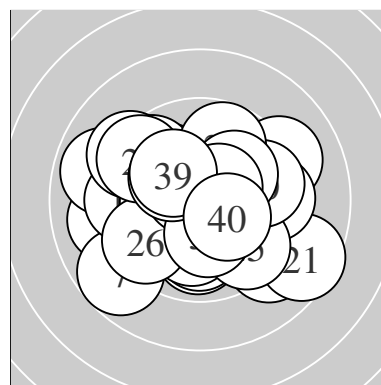

Serie 1:
 9.1 ← 10.3 * 9.1 ↘ 9.9 ↓ 10.4 *
 9.1 → 8.8 ↙ 10.3 * 10.0 ↓ 10.2 *
 beste Teiler 147.3 (5.) 158.0 (2.) 159.5 (8.)
 Trefferlage 0.00 mm , 1.33 mm tief
 Streuwert 2.36, horizontal: 2.78, vertikal: 1.83

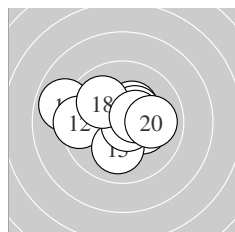

Serie 2:
 8.9 ↖ 9.5 ← 10.3 * 10.4 * 10.1 ↓
 10.4 * 10.8 * 10.0 ↘ 10.5 * 10.0 →
 beste Teiler 47.7 (17.) 120.0 (19.) 136.2 (16.)
 Trefferlage 0.33 mm links, 0.29 mm hoch
 Streuwert 1.89, horizontal: 2.41, vertikal: 1.15

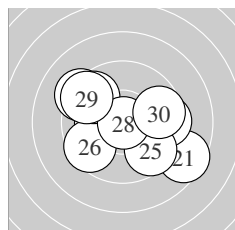

Serie 3:
 8.6 ↗ 10.2 * 9.5 → 9.2 ↖ 9.6 ↘
 9.6 ↙ 9.6 ↘ 10.9 * 9.5 ↖ 9.7 →
 beste Teiler 11.4 (28.) 188.2 (22.) 324.0 (30.)
 Trefferlage 0.07 mm rechts, 0.00 mm
 Streuwert 2.69, horizontal: 3.27, vertikal: 1.93

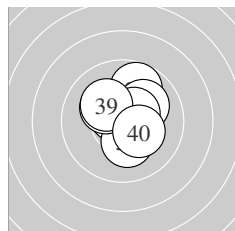

Serie 4:
 10.6 * 10.4 * 10.6 * 9.8 ↗ 10.1 ↗
 10.5 * 10.2 * 10.2 * 10.2 * 10.3 *
 beste Teiler 76.2 (31.) 91.4 (33.) 116.7 (36.)
 Trefferlage 0.41 mm rechts, 0.63 mm hoch
 Streuwert 1.20, horizontal: 1.15, vertikal: 1.24

Unterschrift des Schützen

Meyton Elektronik

Ergebnis:	381	(400.7)
Serien:	96 96 92 97	
Zähler:	23 15 2 0 0 0 0 0 0 0	
Innenzehner:	18	
weiteste:	544 (27), 502 (22), 446 (11)	
beste Teiler	40.3 (6.) 40.4 (10.) 74.0 (14.)	
Trefferlage	0.15 mm links, 0.36 mm hoch	
Streuwert	1.87, horizontal: 2.33, vertikal: 1.24	

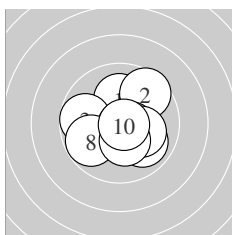
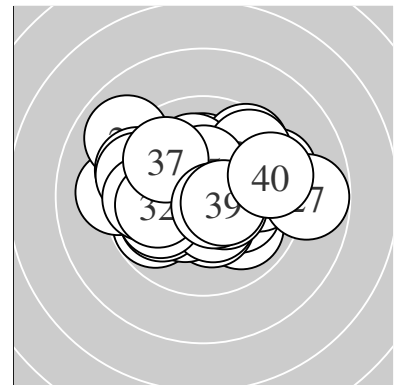

Serie 1:	10.1 ↑	9.6 ↗	9.7 ←	10.5 *	9.9 ↘
	10.8 *	10.2 *	9.8 ↙	10.3 *	10.8 *
beste Teiler	40.3 (6.) 40.4 (10.) 103.8 (4.)				
Trefferlage	0.26 mm rechts, 0.11 mm tief				
Streuwert	1.62, horizontal: 1.78, vertikal: 1.46				

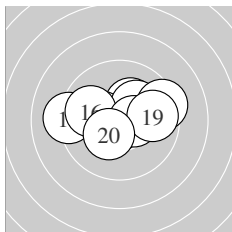

Serie 2:	9.2 ←	10.3 *	10.3 *	10.7 *	10.2 *
	9.9 ←	10.5 *	9.4 →	9.8 →	10.3 *
beste Teiler	74.0 (14.) 124.4 (17.) 154.8 (20.)				
Trefferlage	0.03 mm rechts, 0.37 mm hoch				
Streuwert	1.88, horizontal: 2.51, vertikal: 0.87				

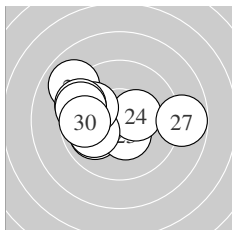

Serie 3:	10.0 ↙	8.9 ↖	10.4 *	10.4 *	10.0 ↖
	9.9 ↖	8.8 →	9.5 ↖	9.5 ↖	9.7 ←
beste Teiler	134.8 (23.) 149.0 (24.) 245.2 (25.)				
Trefferlage	1.32 mm links, 0.33 mm hoch				
Streuwert	2.30, horizontal: 2.95, vertikal: 1.36				

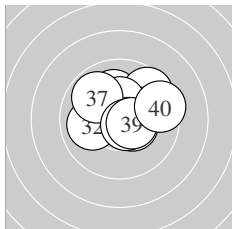

Serie 4:	10.3 *	10.0 ←	10.1 ↑	9.6 ↗	10.4 *
	10.4 *	9.9 ↖	10.6 *	10.5 *	9.5 →
beste Teiler	77.2 (38.) 113.2 (39.) 126.1 (36.)				
Trefferlage	0.39 mm rechts, 0.85 mm hoch				
Streuwert	1.53, horizontal: 1.81, vertikal: 1.19				

Unterschrift des Schützen

Ergebnis: **397** (412.2)
 Serien: 99 100 99 99
 Zähler: 37 3 0 0 0 0 0 0 0 0
 Innenzehner: 25
 weiteste: 329 (8), 282 (31), 277 (28)
 beste Teiler 36.0 (25.) 36.4 (12.) 44.7 (15.)
 Trefferlage 0.11 mm rechts, 0.05 mm tief
 Streuwert 1.27, horizontal: 1.37, vertikal: 1.17

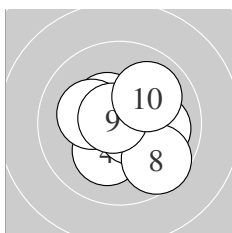
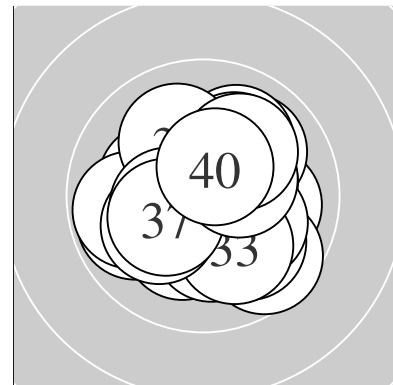

Serie 1:
 10.4 * 10.4 * 10.4 * 10.2 * 10.2 *
 10.0 → 10.6 * 9.6 ↘ 10.7 * 10.0 ↗
 beste Teiler 53.6 (9.) 91.2 (7.) 127.4 (1.)
 Trefferlage 0.50 mm rechts, 0.21 mm tief
 Streuwert 1.36, horizontal: 1.44, vertikal: 1.27

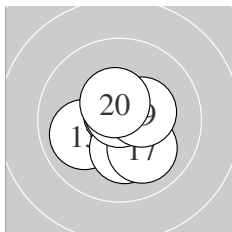

Serie 2:
 10.6 * 10.8 * 10.0 ↙ 10.6 * 10.8 *
 10.2 * 10.0 ↘ 10.8 * 10.4 * 10.5 *
 beste Teiler 36.4 (12.) 44.7 (15.) 50.0 (18.)
 Trefferlage 0.06 mm rechts, 0.22 mm tief
 Streuwert 1.05, horizontal: 1.10, vertikal: 1.01

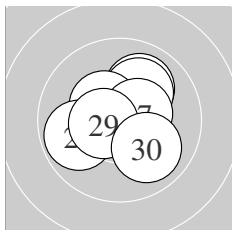

Serie 3:
 10.7 * 10.6 * 10.0 ↗ 10.1 ↗ 10.8 *
 10.4 * 10.5 * 9.8 ↙ 10.5 * 10.0 ↘
 beste Teiler 36.0 (25.) 68.7 (21.) 96.7 (22.)
 Trefferlage 0.10 mm rechts, 0.25 mm hoch
 Streuwert 1.27, horizontal: 1.38, vertikal: 1.15

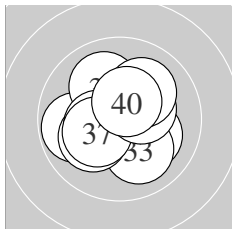

Serie 4:
 9.8 ↙ 10.1 ↘ 10.0 ↘ 10.1 ↙ 10.0 ↖
 10.4 * 10.3 * 10.3 * 10.1 ↗ 10.5 *
 beste Teiler 121.0 (40.) 139.5 (36.) 153.4 (38.)
 Trefferlage 0.19 mm links, 0.02 mm tief
 Streuwert 1.48, horizontal: 1.62, vertikal: 1.33

Unterschrift des Schützen

Meyton Elektronik

Ergebnis: **389** (406.6)
 Serien: 97 96 99 97
 Zähler: 29 11 0 0 0 0 0 0 0 0
 Innenzehner: 22
 weiteste: 408 (6), 379 (8), 355 (19)
 beste Teiler 15.6 (38.) 39.8 (26.) 70.0 (15.)
 Trefferlage 0.37 mm rechts, 0.69 mm hoch
 Streuwert 1.46, horizontal: 1.75, vertikal: 1.09

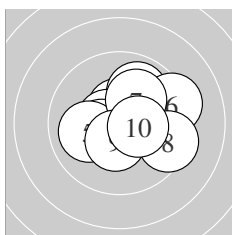
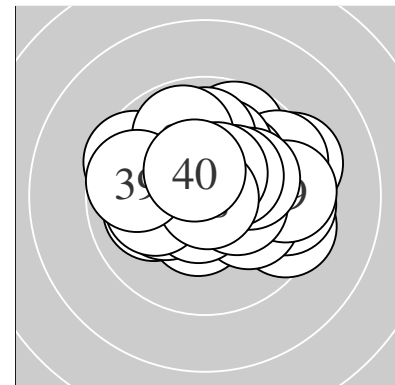

Serie 1:
 10.5 * 9.9 ↗ 10.6 * 10.4 * 10.0 ←
 9.3 ↘ 10.1 ↗ 9.4 ↘ 10.4 * 10.4 *
 beste Teiler 92.8 (3.) 104.9 (1.) 131.4 (9.)
 Trefferlage 0.63 mm rechts, 0.27 mm hoch
 Streuwert 1.68, horizontal: 2.00, vertikal: 1.28

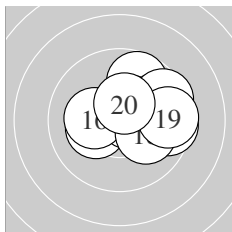

Serie 2:
 9.7 ↗ 10.2 * 10.4 * 9.5 → 10.7 *
 10.2 * 9.5 ↘ 10.1 ↘ 9.5 → 10.4 *
 beste Teiler 70.0 (15.) 126.9 (20.) 131.4 (13.)
 Trefferlage 1.17 mm rechts, 0.51 mm hoch
 Streuwert 1.60, horizontal: 1.95, vertikal: 1.13

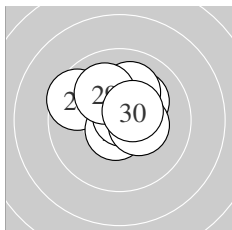

Serie 3:
 10.4 * 9.6 ↖ 10.5 * 10.6 * 10.2 *
 10.8 * 10.1 ↗ 10.4 * 10.1 ↖ 10.5 *
 beste Teiler 39.8 (26.) 76.6 (24.) 116.4 (30.)
 Trefferlage 0.01 mm rechts, 0.92 mm hoch
 Streuwert 1.16, horizontal: 1.36, vertikal: 0.93

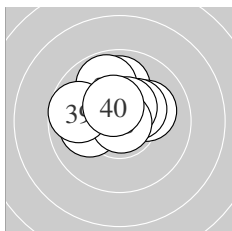

Serie 4:
 10.3 * 10.1 ← 9.9 ↑ 10.1 → 10.4 *
 9.8 ↘ 10.5 * 10.9 * 9.7 ← 10.5 *
 beste Teiler 15.6 (38.) 112.2 (37.) 121.0 (40.)
 Trefferlage 0.29 mm links, 1.06 mm hoch
 Streuwert 1.25, horizontal: 1.48, vertikal: 0.98

Unterschrift des Schützen

Ergebnis: **387** (405.9)
 Serien: 95 97 97 98
 Zähler: 28 11 1 0 0 0 0 0 0 0
 Innenzehner: 21
 weiteste: 557 (1), 496 (29), 406 (3)
 beste Teiler 25.6 (34.) 37.0 (15.) 49.0 (2.)
 Trefferlage 0.09 mm links, 0.20 mm hoch
 Streuwert 1.67, horizontal: 2.00, vertikal: 1.25

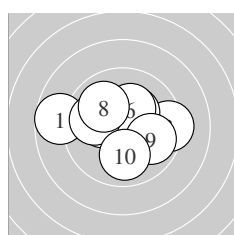
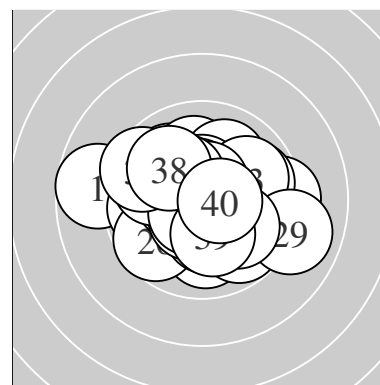

Serie 1:
 8.7 ← 10.8 * 9.3 → 10.3 * 10.2 *
 10.3 * 9.9 ← 10.0 ↘ 9.9 → 10.0 ↓
 beste Teiler 49.0 (2.) 166.4 (4.) 175.6 (6.)
 Trefferlage 0.29 mm links, 0.36 mm hoch
 Streuwert 2.12, horizontal: 2.71, vertikal: 1.28

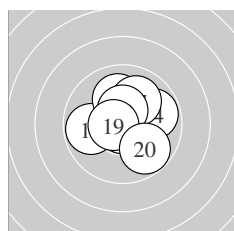

Serie 2:
 10.6 * 10.4 * 9.8 ← 9.8 → 10.8 *
 10.1 ↑ 10.0 ↗ 10.5 * 10.6 * 9.8 ↘
 beste Teiler 37.0 (15.) 81.3 (19.) 91.0 (11.)
 Trefferlage 0.21 mm rechts, 0.37 mm hoch
 Streuwert 1.45, horizontal: 1.60, vertikal: 1.29

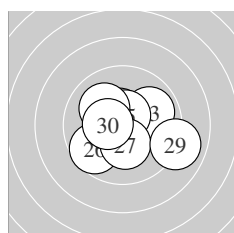

Serie 3:
 10.7 * 10.4 * 9.9 ↗ 10.5 * 10.6 *
 9.7 ↙ 10.3 * 10.1 ↘ 9.0 → 10.4 *
 beste Teiler 65.6 (21.) 89.0 (25.) 105.7 (24.)
 Trefferlage 0.30 mm rechts, 0.04 mm hoch
 Streuwert 1.74, horizontal: 2.07, vertikal: 1.33

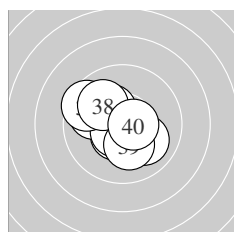

Serie 4:
 10.0 ↘ 10.3 * 10.5 * 10.9 * 9.9 ←
 10.6 * 9.5 ↘ 10.0 ↘ 10.2 * 10.6 *
 beste Teiler 25.6 (34.) 92.0 (36.) 95.1 (40.)
 Trefferlage 0.60 mm links, 0.04 mm hoch
 Streuwert 1.43, horizontal: 1.58, vertikal: 1.27

Unterschrift des Schützen

Ergebnis: **385** (400.9)
 Serien: 96 95 99 95
 Zähler: 25 15 0 0 0 0 0 0 0 0
 Innenzehner: 18
 weiteste: 468 (4), 464 (19), 449 (6)
 beste Teiler 1.4 (13.) 7.8 (22.) 19.2 (12.)
 Trefferlage 0.24 mm links, 0.03 mm tief
 Streuwert 1.93, horizontal: 2.20, vertikal: 1.63

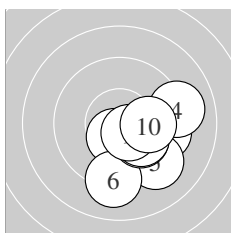
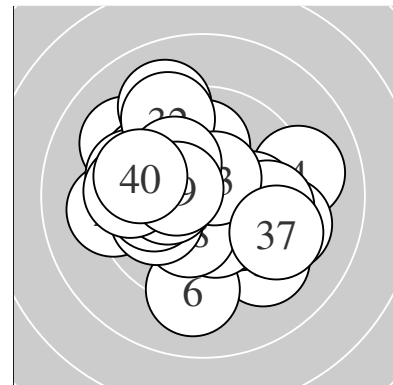

Serie 1:
 10.5 * 10.5 * 9.5 → 9.1 → 9.3 ↘
 9.2 ↓ 10.1 ↘ 10.1 ↘ 10.5 * 10.0 →
 beste Teiler 107.4 (9.) 111.6 (1.) 115.5 (2.)
 Trefferlage 1.66 mm rechts, 1.27 mm tief
 Streuwert 1.61, horizontal: 1.68, vertikal: 1.53

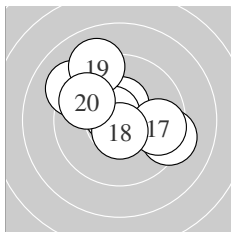

Serie 2:
 9.3 → 10.9 * 10.9 * 9.2 ↖ 10.5 *
 10.6 * 9.7 → 10.6 * 9.1 ↗ 9.7 ↖
 beste Teiler 1.4 (13.) 19.2 (12.) 77.6 (16.)
 Trefferlage 0.17 mm links, 0.73 mm hoch
 Streuwert 2.04, horizontal: 2.32, vertikal: 1.70

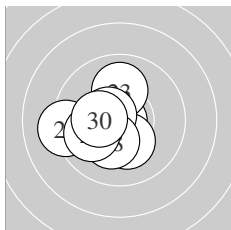

Serie 3:
 10.8 * 10.9 * 10.0 ↑ 10.2 * 10.5 *
 10.6 * 9.2 ← 10.2 * 10.0 ← 10.3 *
 beste Teiler 7.8 (22.) 46.2 (21.) 97.1 (26.)
 Trefferlage 1.06 mm links, 0.22 mm tief
 Streuwert 1.29, horizontal: 1.40, vertikal: 1.18

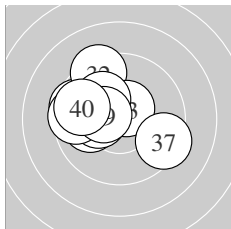

Serie 4:
 9.5 ↖ 9.3 ↖ 10.6 * 10.0 ← 10.3 *
 9.6 ← 9.4 ↘ 10.1 ↖ 10.4 * 9.7 ↖
 beste Teiler 100.4 (33.) 131.7 (39.) 169.1 (35.)
 Trefferlage 1.41 mm links, 0.63 mm hoch
 Streuwert 1.79, horizontal: 2.10, vertikal: 1.41

Unterschrift des Schützen

Meyton Elektronik

Ergebnis: **376** (393.8)
 Serien: 94 93 96 93
 Zähler: 17 22 1 0 0 0 0 0 0 0
 Innenzehner: 7
 weiteste: 571 (12), 486 (28), 467 (16)
 beste Teiler 39.2 (9.) 59.4 (37.) 75.6 (27.)
 Trefferlage 0.11 mm rechts, 0.14 mm hoch
 Streuwert 2.16, horizontal: 2.32, vertikal: 1.99

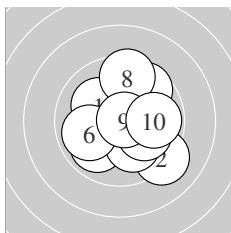
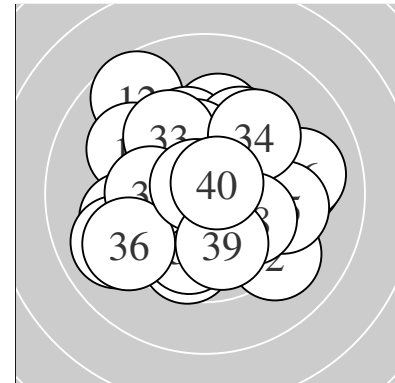

Serie 1:
 10.1 ↘ 9.2 ↘ 9.9 ↙ 9.7 ↗ 10.1 ↘
 9.9 ↙ 10.1 ↘ 9.5 ↑ 10.8 * 9.8 →
 beste Teiler 39.2 (9.) 210.6 (1.) 214.9 (5.)
 Trefferlage 0.63 mm rechts, 0.10 mm tief
 Streuwert 2.04, horizontal: 2.02, vertikal: 2.05

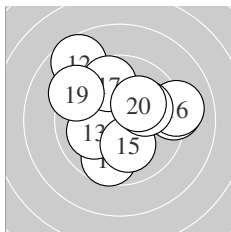

Serie 2:
 9.7 ↓ 8.7 ↘ 10.1 ↙ 9.2 → 10.1 ↘
 9.1 → 9.7 ↑ 10.0 → 9.3 ↘ 10.1 ↗
 beste Teiler 201.3 (20.) 207.1 (15.) 222.9 (13.)
 Trefferlage 0.26 mm rechts, 0.77 mm hoch
 Streuwert 2.61, horizontal: 2.89, vertikal: 2.29

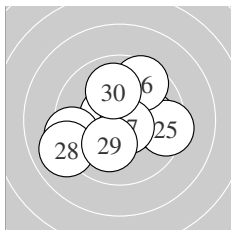

Serie 3:
 10.0 → 10.4 * 10.5 * 9.3 ↙ 9.4 →
 9.6 ↗ 10.7 * 9.0 ↙ 10.1 ↓ 10.0 ↑
 beste Teiler 75.6 (27.) 105.3 (23.) 129.5 (22.)
 Trefferlage 0.17 mm links, 0.03 mm hoch
 Streuwert 2.17, horizontal: 2.53, vertikal: 1.74

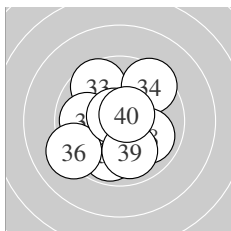

Serie 4:
 9.9 ↓ 10.5 * 9.6 ↘ 9.5 ↗ 9.9 ←
 9.2 ↙ 10.7 * 9.9 ↘ 9.9 ↓ 10.6 *
 beste Teiler 59.4 (37.) 78.5 (40.) 117.2 (32.)
 Trefferlage 0.25 mm links, 0.10 mm tief
 Streuwert 2.01, horizontal: 1.99, vertikal: 2.02

Unterschrift des Schützen

Meyton Elektronik

Ergebnis: **379** (396.4)
 Serien: 95 97 93 94
 Zähler: 21 17 2 0 0 0 0 0 0 0
 Innenzehner: 16
 weiteste: 543 (5), 508 (29), 478 (25)
 beste Teiler 64.9 (17.) 71.7 (39.) 79.6 (1.)
 Trefferlage 0.65 mm links, 0.35 mm hoch
 Streuwert 2.00, horizontal: 2.08, vertikal: 1.92

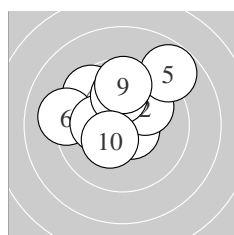
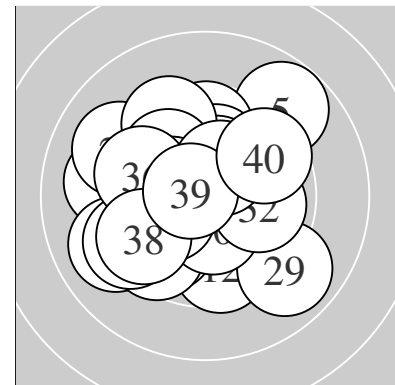

Serie 1:
 10.6 * 10.0 ↗ 10.0 ↘ 9.6 ↘ 8.8 ↗
 9.2 ← 10.2 * 10.0 ↑ 9.7 ↑ 10.4 *
 beste Teiler 79.6 (1.) 150.8 (10.) 189.3 (7.)
 Trefferlage 0.53 mm links, 1.47 mm hoch
 Streuwert 1.98, horizontal: 2.26, vertikal: 1.65

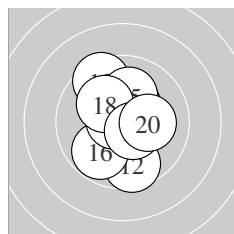

Serie 2:
 10.4 * 9.6 ↓ 9.5 ↘ 10.3 * 10.1 ↑
 9.8 ↗ 10.7 * 10.2 * 10.5 * 10.2 *
 beste Teiler 64.9 (17.) 106.4 (19.) 137.2 (11.)
 Trefferlage 0.01 mm rechts, 0.31 mm hoch
 Streuwert 1.67, horizontal: 1.29, vertikal: 1.98

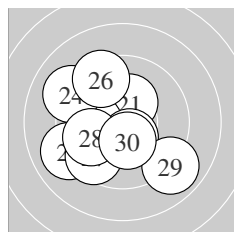

Serie 3:
 10.3 * 10.0 ← 10.4 * 9.1 ↘ 9.0 ↗
 9.4 ↘ 9.6 ↗ 9.9 ↗ 8.9 ↘ 10.4 *
 beste Teiler 132.4 (23.) 150.8 (30.) 162.8 (21.)
 Trefferlage 1.17 mm links, 0.51 mm tief
 Streuwert 2.35, horizontal: 2.46, vertikal: 2.24

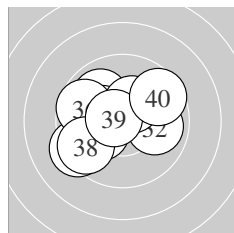

Serie 4:
 9.9 ↘ 9.9 → 9.3 ↗ 10.3 * 10.2 *
 9.7 ← 10.4 * 9.6 ↗ 10.7 * 9.6 ↗
 beste Teiler 71.7 (39.) 149.9 (37.) 167.2 (34.)
 Trefferlage 0.90 mm links, 0.15 mm hoch
 Streuwert 1.89, horizontal: 2.24, vertikal: 1.46

Unterschrift des Schützen

Meyton Elektronik

Ergebnis: **353** (374.0)
 Serien: 87 89 87 90
 Zähler: 10 16 11 3 0 0 0 0 0 0
 Innenzehner: 10
 weiteste: 855 (10), 804 (24), 770 (16)
 beste Teiler 44.2 (8.) 64.3 (32.) 98.4 (34.)
 Trefferlage 1.56 mm links, 0.81 mm tief
 Streuwert 2.96, horizontal: 3.21, vertikal: 2.69

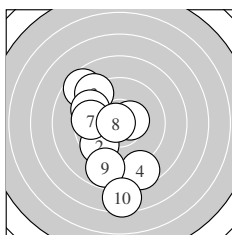
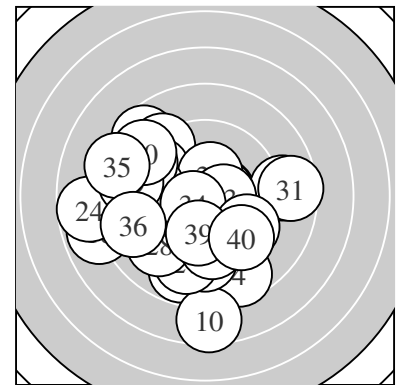

Serie 1:
 8.6 ↘ 9.6 ↙ 9.1 ↘ 8.6 ↓ 9.5 ↖
 10.5 * 9.6 ← 10.8 * 8.8 ↓ 7.5 ↓
 beste Teiler 44.2 (8.) 122.9 (6.) 333.2 (7.)
 Trefferlage 1.44 mm links, 1.17 mm tief
 Streuwert 3.29, horizontal: 2.19, vertikal: 4.10

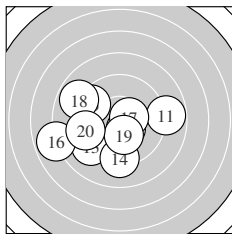

Serie 2:
 8.8 → 10.5 * 9.2 ↙ 9.2 ↓ 9.5 ↖
 7.9 ← 10.5 * 8.9 ↖ 10.2 * 9.3 ←
 beste Teiler 113.8 (17.) 121.6 (12.) 176.6 (19.)
 Trefferlage 1.48 mm links, 0.85 mm tief
 Streuwert 3.00, horizontal: 3.66, vertikal: 2.13

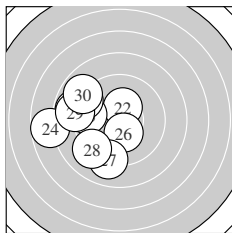

Serie 3:
 8.8 ← 10.3 * 9.4 ← 7.7 ← 9.1 ↖
 10.3 * 9.1 ↓ 9.1 ↙ 8.9 ← 8.9 ↖
 beste Teiler 151.1 (26.) 151.3 (22.) 376.4 (23.)
 Trefferlage 3.40 mm links, 0.06 mm tief
 Streuwert 2.53, horizontal: 2.62, vertikal: 2.44

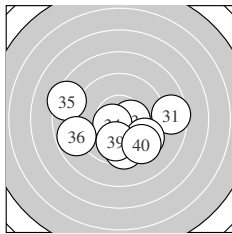

Serie 4:
 8.6 → 10.7 * 10.4 * 10.6 * 8.4 ↖
 8.8 ← 9.5 ↓ 9.5 ↘ 9.9 ↓ 9.4 ↓
 beste Teiler 64.3 (32.) 98.4 (34.) 128.1 (33.)
 Trefferlage 0.06 mm rechts, 1.16 mm tief
 Streuwert 2.80, horizontal: 3.56, vertikal: 1.74

Unterschrift des Schützen

Meyton Elektronik

Ergebnis: **383** (401.6)
 Serien: 94 95 97 97
 Zähler: 25 13 2 0 0 0 0 0 0 0
 Innenzehner: 17
 weiteste: 514 (1), 504 (5), 479 (33)
 beste Teiler 30.8 (34.) 56.7 (31.) 60.2 (29.)
 Trefferlage 0.18 mm rechts, 0.55 mm hoch
 Streuwert 1.80, horizontal: 2.14, vertikal: 1.39

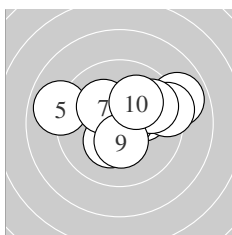
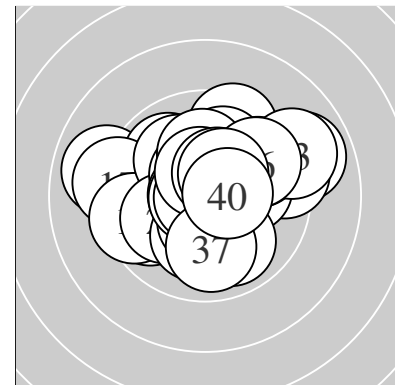

Serie 1:
 8.9 → 10.1 → 10.3 * 9.3 → 8.9 ←
 10.6 * 10.2 * 9.8 → 10.4 * 10.1 →
 beste Teiler 77.0 (6.) 147.5 (9.) 164.1 (3.)
 Trefferlage 0.84 mm rechts, 0.70 mm hoch
 Streuwert 2.16, horizontal: 2.79, vertikal: 1.23

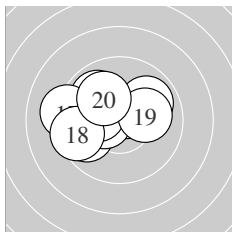

Serie 2:
 10.6 * 9.8 ← 10.4 * 9.9 ↘ 10.2 *
 9.9 → 9.2 ← 9.5 ← 10.1 → 10.1 ↘
 beste Teiler 91.2 (11.) 126.5 (13.) 185.0 (15.)
 Trefferlage 1.19 mm links, 0.49 mm hoch
 Streuwert 1.74, horizontal: 2.21, vertikal: 1.07

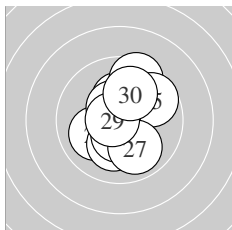

Serie 3:
 10.1 ← 10.1 ↓ 10.3 * 9.5 ↑ 9.7 →
 10.5 * 9.9 ↘ 10.5 * 10.7 * 10.0 ↑
 beste Teiler 60.2 (29.) 116.7 (28.) 125.6 (26.)
 Trefferlage 0.23 mm rechts, 0.34 mm hoch
 Streuwert 1.64, horizontal: 1.31, vertikal: 1.92

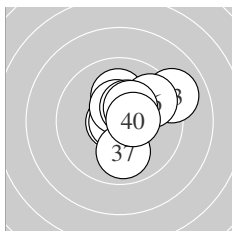

Serie 4:
 10.7 * 10.1 ↑ 9.0 → 10.8 * 10.5 *
 9.7 → 9.9 ↓ 10.4 * 10.4 * 10.5 *
 beste Teiler 30.8 (34.) 56.7 (31.) 112.7 (40.)
 Trefferlage 0.85 mm rechts, 0.67 mm hoch
 Streuwert 1.45, horizontal: 1.52, vertikal: 1.39

Unterschrift des Schützen

Meyton Elektronik

Ergebnis: **396** (416.0)
 Serien: 98 100 98 100
 Zähler: 36 4 0 0 0 0 0 0 0 0
 Innenzehner: 31
 weiteste: 298 (6), 278 (5), 263 (28)
 beste Teiler 24.0 (38.) 29.4 (2.) 29.8 (4.)
 Trefferlage 0.18 mm links, 0.29 mm hoch
 Streuwert 1.11, horizontal: 1.10, vertikal: 1.12

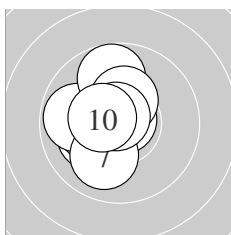
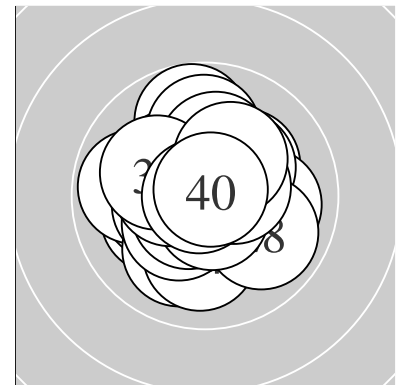

Serie 1:
 10.1 ↙ 10.8 * 10.2 * 10.8 * 9.8 ←
 9.8 ↑ 10.0 ↘ 10.3 * 10.8 * 10.5 *
 beste Teiler 29.4 (2.) 29.8 (4.) 50.1 (9.)
 Trefferlage 0.88 mm links, 0.29 mm hoch
 Streuwert 1.18, horizontal: 1.02, vertikal: 1.33

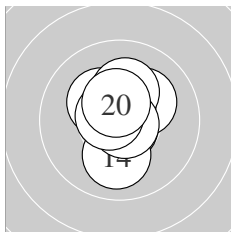

Serie 2:
 10.5 * 10.5 * 10.7 * 10.0 ↓ 10.3 *
 10.2 * 10.2 * 10.8 * 10.7 * 10.5 *
 beste Teiler 42.8 (18.) 56.8 (13.) 72.6 (19.)
 Trefferlage 0.08 mm rechts, 0.47 mm hoch
 Streuwert 1.00, horizontal: 0.75, vertikal: 1.21

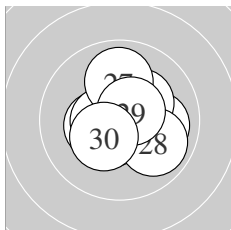

Serie 3:
 10.6 * 10.7 * 10.4 * 10.6 * 10.0 →
 10.3 * 9.9 ↑ 9.9 ↘ 10.6 * 10.4 *
 beste Teiler 69.5 (22.) 94.8 (29.) 100.1 (24.)
 Trefferlage 0.20 mm rechts, 0.03 mm tief
 Streuwert 1.27, horizontal: 1.37, vertikal: 1.17

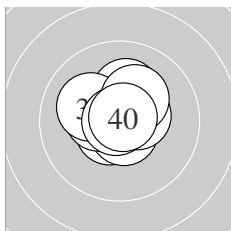

Serie 4:
 10.7 * 10.2 * 10.6 * 10.7 * 10.4 *
 10.5 * 10.1 ↖ 10.9 * 10.2 * 10.8 *
 beste Teiler 24.0 (38.) 33.3 (40.) 71.5 (31.)
 Trefferlage 0.15 mm links, 0.43 mm hoch
 Streuwert 0.89, horizontal: 0.97, vertikal: 0.81

Unterschrift des Schützen

Ergebnis: **398** (417.6)
 Serien: 99 99 100 100
 Zähler: 38 2 0 0 0 0 0 0 0 0
 Innenzehner: 37
 weiteste: 267 (11), 254 (4), 249 (10)
 beste Teiler 35.4 (24.) 44.0 (8.) 61.7 (17.)
 Trefferlage 0.00 mm , 0.23 mm hoch
 Streuwert 0.98, horizontal: 1.10, vertikal: 0.85

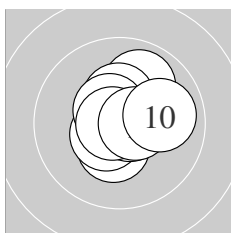
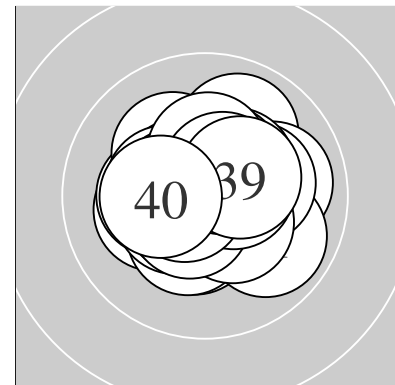

Serie 1:
 10.4 * 10.5 * 10.5 * 9.9 ↗ 10.4 *
 10.6 * 10.7 * 10.8 * 10.6 * 10.0 →
 beste Teiler 44.0 (8.) 62.8 (7.) 94.0 (9.)
 Trefferlage 0.37 mm rechts, 0.34 mm hoch
 Streuwert 1.03, horizontal: 1.02, vertikal: 1.03

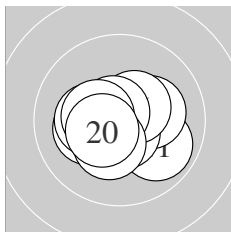

Serie 2:
 9.9 ↘ 10.2 * 10.2 * 10.6 * 10.3 *
 10.5 * 10.7 * 10.4 * 10.3 * 10.5 *
 beste Teiler 61.7 (17.) 78.7 (14.) 119.7 (16.)
 Trefferlage 0.18 mm links, 0.27 mm tief
 Streuwert 1.17, horizontal: 1.45, vertikal: 0.80

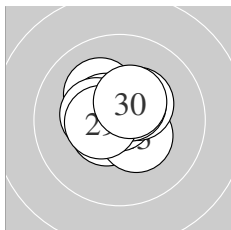

Serie 3:
 10.6 * 10.2 * 10.4 * 10.8 * 10.4 *
 10.5 * 10.5 * 10.4 * 10.5 * 10.4 *
 beste Teiler 35.4 (24.) 96.8 (21.) 105.2 (26.)
 Trefferlage 0.21 mm links, 0.43 mm hoch
 Streuwert 0.89, horizontal: 0.98, vertikal: 0.79

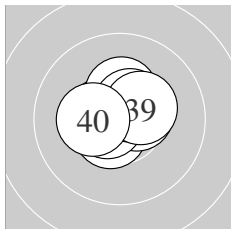

Serie 4:
 10.5 * 10.7 * 10.6 * 10.5 * 10.5 *
 10.3 * 10.6 * 10.5 * 10.4 * 10.3 *
 beste Teiler 75.3 (32.) 77.1 (37.) 96.8 (33.)
 Trefferlage 0.00 mm , 0.42 mm hoch
 Streuwert 0.82, horizontal: 0.96, vertikal: 0.66

Unterschrift des Schützen

Ergebnis:	373	(393.5)
Serien:	96	92 92 93
Zähler:	17	19 4 0 0 0 0 0 0 0
Innenzehner:	15	
weiteste:	584	(2), 577 (35), 546 (12)
beste Teiler	22.6	(1.) 34.1 (18.) 41.4 (7.)
Trefferlage	0.52 mm	rechts, 0.15 mm tief
Streuwert	2.25,	horizontal: 2.60, vertikal: 1.84

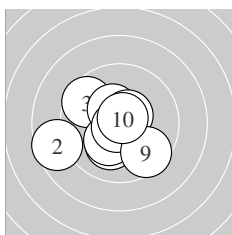
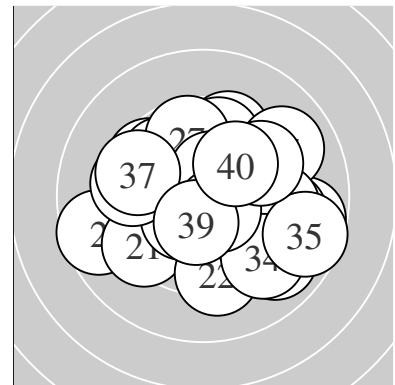

Serie 1:	10.9 *	8.6 ←	9.6 ↘	10.1 ↓	10.2 *
	10.4 *	10.8 *	10.6 *	9.6 ↘	10.7 *
beste Teiler	22.6	(1.) 41.4 (7.)	52.4 (10.)		
Trefferlage	0.74 mm	links, 0.41 mm	tief		
Streuwert	1.84,	horizontal: 2.14,	vertikal: 1.49		

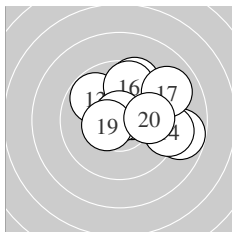

Serie 2:	10.5 *	8.8 →	9.8 ↘	9.2 →	9.5 ↑
	9.7 ↑	9.0 →	10.8 *	10.5 *	9.9 →
beste Teiler	34.1	(18.) 119.4 (11.)	119.7 (19.)		
Trefferlage	1.63 mm	rechts, 0.91 mm	hoch		
Streuwert	2.09,	horizontal: 2.45,	vertikal: 1.65		

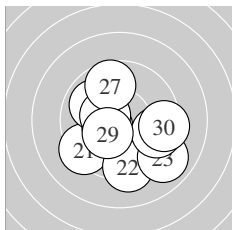

Serie 3:	9.3 ↙	9.3 ↓	8.9 ↘	10.5 *	9.9 ↘
	10.4 *	9.7 ↑	9.6 →	10.3 *	9.4 →
beste Teiler	123.0	(24.) 134.4 (26.)	156.4 (29.)		
Trefferlage	0.22 mm	rechts, 0.84 mm	tief		
Streuwert	2.37,	horizontal: 2.58,	vertikal: 2.14		

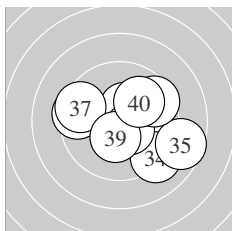

Serie 4:	9.6 ↘	9.4 ←	10.4 *	9.1 ↘	8.6 →
	10.5 *	9.5 ←	9.5 →	10.4 *	10.0 →
beste Teiler	111.1	(36.) 126.6 (33.)	145.7 (39.)		
Trefferlage	0.98 mm	rechts, 0.29 mm	tief		
Streuwert	2.43,	horizontal: 2.92,	vertikal: 1.81		

Unterschrift des Schützen

Ergebnis: **387** (406.3)
 Serien: 95 97 96 99
 Zähler: 27 13 0 0 0 0 0 0 0 0
 Innenzehner: 22
 weiteste: 424 (7), 405 (22), 378 (8)
 beste Teiler 14.7 (20.) 48.2 (19.) 84.5 (32.)
 Trefferlage 0.32 mm links, 0.26 mm hoch
 Streuwert 1.59, horizontal: 1.75, vertikal: 1.42

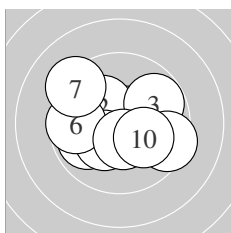
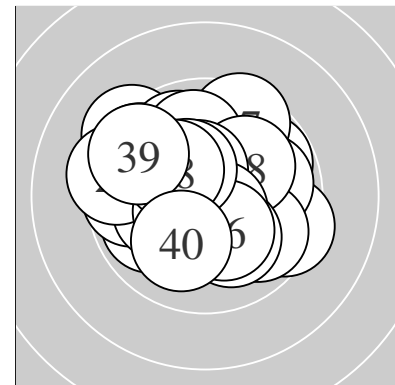

Serie 1:
 10.6 * 10.2 * 9.8 ↗ 9.9 ↖ 10.3 *
 9.7 ← 9.3 ↘ 9.4 → 10.5 * 10.1 ↘
 beste Teiler 88.2 (1.) 123.9 (9.) 170.0 (5.)
 Trefferlage 0.24 mm links, 0.01 mm tief
 Streuwert 1.99, horizontal: 2.41, vertikal: 1.45

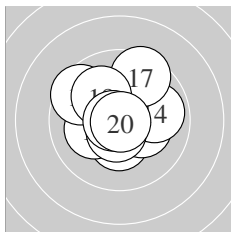

Serie 2:
 10.3 * 10.2 * 10.3 * 9.9 → 10.6 *
 9.6 ↘ 9.5 ↗ 10.1 ↘ 10.8 * 10.9 *
 beste Teiler 14.7 (20.) 48.2 (19.) 90.2 (15.)
 Trefferlage 0.10 mm links, 0.37 mm hoch
 Streuwert 1.59, horizontal: 1.69, vertikal: 1.49

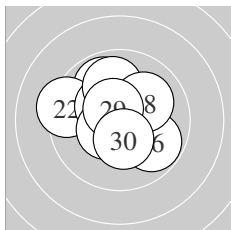

Serie 3:
 9.9 ↘ 9.3 ← 10.6 * 10.4 * 10.5 *
 9.8 ↘ 9.9 ↑ 10.1 ↗ 10.6 * 10.4 *
 beste Teiler 97.6 (29.) 100.8 (23.) 119.8 (25.)
 Trefferlage 0.45 mm links, 0.60 mm hoch
 Streuwert 1.59, horizontal: 1.73, vertikal: 1.43

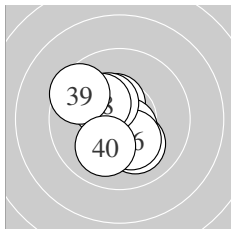

Serie 4:
 10.5 * 10.6 * 10.1 ↘ 10.5 * 10.6 *
 10.3 * 10.4 * 10.2 * 9.6 ↘ 10.0 ↖
 beste Teiler 84.5 (32.) 87.3 (35.) 111.5 (31.)
 Trefferlage 0.50 mm links, 0.10 mm hoch
 Streuwert 1.34, horizontal: 1.21, vertikal: 1.46

Unterschrift des Schützen

Meyton Elektronik

Ergebnis: **387** (403.6)
 Serien: 96 95 99 97
 Zähler: 28 11 1 0 0 0 0 0 0 0
 Innenzehner: 19
 weiteste: 584 (20), 490 (10), 451 (12)
 beste Teiler 31.0 (26.) 69.8 (23.) 76.0 (14.)
 Trefferlage 0.84 mm links, 0.23 mm hoch
 Streuwert 1.67, horizontal: 1.89, vertikal: 1.42

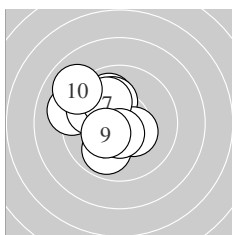
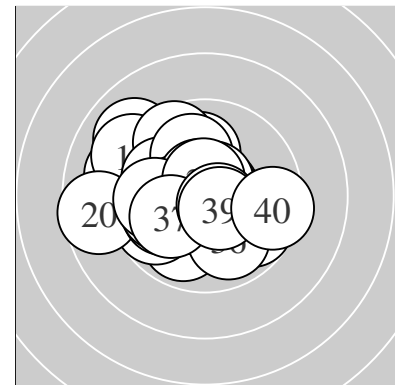

Serie 1:
 9.2 ↖ 10.0 ↗ 9.9 ↙ 10.1 ↕ 9.8 ↘
 10.4 * 10.1 ↖ 10.6 * 10.3 * 9.0 ↘
 beste Teiler 93.0 (8.) 145.1 (6.) 153.2 (9.)
 Trefferlage 1.46 mm links, 0.65 mm hoch
 Streuwert 1.73, horizontal: 1.69, vertikal: 1.78

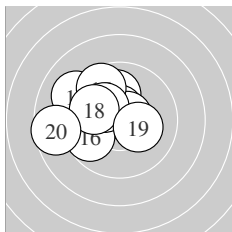

Serie 2:
 10.0 ↕ 9.1 ↖ 10.6 * 10.6 * 9.6 ↗
 9.7 ↙ 10.2 * 10.0 ↖ 10.2 * 8.6 ←
 beste Teiler 76.0 (14.) 94.2 (13.) 178.9 (17.)
 Trefferlage 1.57 mm links, 0.78 mm hoch
 Streuwert 1.88, horizontal: 2.22, vertikal: 1.46

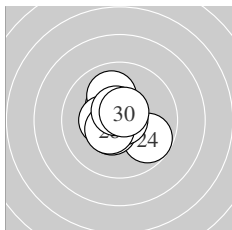

Serie 3:
 10.4 * 10.0 ↗ 10.7 * 9.8 ↘ 10.5 *
 10.8 * 10.4 * 10.5 * 10.6 * 10.6 *
 beste Teiler 31.0 (26.) 69.8 (23.) 83.2 (30.)
 Trefferlage 0.21 mm links, 0.21 mm hoch
 Streuwert 1.12, horizontal: 1.11, vertikal: 1.13

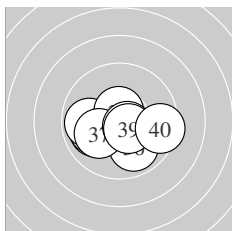

Serie 4:
 10.0 ← 10.0 ← 9.9 ← 10.2 * 10.6 *
 9.9 ↘ 10.1 ← 10.6 * 10.5 * 9.5 →
 beste Teiler 84.3 (38.) 88.3 (35.) 104.9 (39.)
 Trefferlage 0.13 mm links, 0.72 mm tief
 Streuwert 1.59, horizontal: 2.10, vertikal: 0.80

Unterschrift des Schützen

Ergebnis: **379** (397.3)
 Serien: 95 96 93 95
 Zähler: 21 17 2 0 0 0 0 0 0 0
 Innenzehner: 16
 weiteste: 644 (16), 618 (23), 443 (10)
 beste Teiler 50.2 (30.) 56.6 (17.) 89.7 (8.)
 Trefferlage 0.69 mm rechts, 0.28 mm hoch
 Streuwert 2.02, horizontal: 2.55, vertikal: 1.27

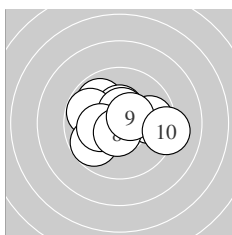
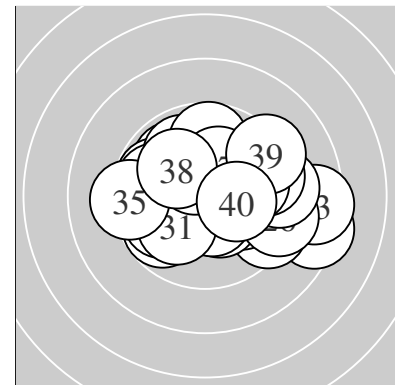

Serie 1:
 9.9 ↘ 10.4 * 9.8 ↖ 9.8 ↙ 10.5 *
 10.2 * 9.8 → 10.6 * 10.5 * 9.2 →
 beste Teiler 89.7 (8.) 111.8 (5.) 117.6 (9.)
 Trefferlage 0.06 mm links, 0.25 mm hoch
 Streuwert 1.83, horizontal: 2.31, vertikal: 1.17

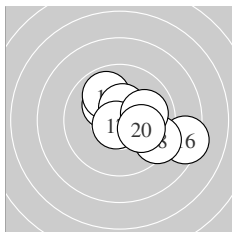

Serie 2:
 10.4 * 10.2 * 10.4 * 9.9 ↖ 10.5 *
 8.4 → 10.7 * 9.4 ↘ 10.0 → 10.1 →
 beste Teiler 56.6 (17.) 121.0 (15.) 135.6 (11.)
 Trefferlage 1.22 mm rechts, 0.14 mm hoch
 Streuwert 1.97, horizontal: 2.39, vertikal: 1.42

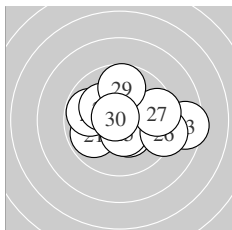

Serie 3:
 9.9 ↙ 9.8 ↖ 8.5 → 10.4 * 10.5 *
 9.2 → 9.5 → 10.1 ↖ 9.7 ↑ 10.8 *
 beste Teiler 50.2 (30.) 123.0 (25.) 148.9 (24.)
 Trefferlage 0.81 mm rechts, 0.07 mm hoch
 Streuwert 2.32, horizontal: 2.95, vertikal: 1.42

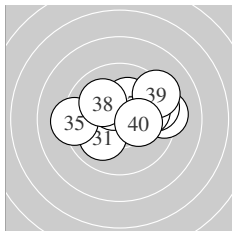

Serie 4:
 10.0 ↙ 9.3 → 10.4 * 9.5 → 9.3 ←
 9.9 → 10.2 * 10.1 ↖ 9.3 ↗ 10.2 *
 beste Teiler 131.5 (33.) 180.8 (40.) 183.0 (37.)
 Trefferlage 0.80 mm rechts, 0.68 mm hoch
 Streuwert 2.11, horizontal: 2.75, vertikal: 1.16

Unterschrift des Schützen

Meyton Elektronik

Ergebnis: **375** (390.8)
 Serien: 92 96 95 92
 Zähler: 20 16 3 1 0 0 0 0 0 0
 Innenzehner: 11
 weiteste: 834 (31), 698 (1), 545 (33)
 beste Teiler 57.0 (19.) 136.7 (3.) 139.7 (25.)
 Trefferlage 0.02 mm links, 0.15 mm hoch
 Streuwert 2.39, horizontal: 2.88, vertikal: 1.76

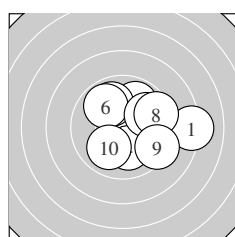
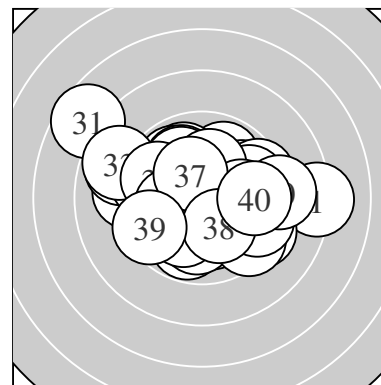

Serie 1:
 8.2 → 9.9 ↗ 10.4 * 10.1 ↓ 9.9 ↖
 9.9 ↘ 9.9 ↘ 9.5 → 9.3 ↘ 10.0 ↖
 beste Teiler 136.7 (3.) 217.8 (4.) 246.2 (10.)
 Trefferlage 1.47 mm rechts, 0.20 mm hoch
 Streuwert 2.33, horizontal: 2.69, vertikal: 1.90

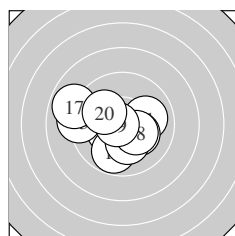

Serie 2:
 10.0 → 10.3 * 9.2 ← 10.2 * 9.8 ↓
 10.2 * 8.9 ← 10.3 * 10.7 * 10.1 ↖
 beste Teiler 57.0 (19.) 156.3 (12.) 160.0 (18.)
 Trefferlage 0.83 mm links, 0.30 mm tief
 Streuwert 1.97, horizontal: 2.42, vertikal: 1.38

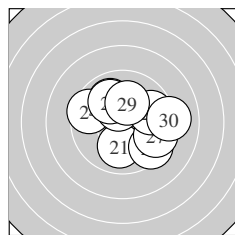

Serie 3:
 10.0 ↓ 9.4 ↘ 10.0 ↖ 9.5 ← 10.4 *
 10.0 ↘ 9.5 ↘ 9.7 → 10.2 * 9.1 →
 beste Teiler 139.7 (25.) 199.3 (29.) 241.9 (21.)
 Trefferlage 0.75 mm rechts, 0.36 mm hoch
 Streuwert 2.21, horizontal: 2.56, vertikal: 1.80

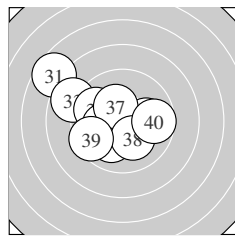

Serie 4:
 7.6 ↘ 10.0 → 8.8 ↘ 9.8 ↘ 10.2 *
 10.1 ↖ 10.3 * 10.2 * 9.5 ↖ 9.7 →
 beste Teiler 162.8 (37.) 191.1 (35.) 199.6 (38.)
 Trefferlage 1.49 mm links, 0.36 mm hoch
 Streuwert 2.67, horizontal: 3.17, vertikal: 2.07

Unterschrift des Schützen

Meyton Elektronik

Ergebnis: **369** (385.5)
 Serien: 93 90 91 95
 Zähler: 15 20 4 1 0 0 0 0 0 0
 Innenzehner: 10
 weiteste: 936 (34), 652 (18), 569 (15)
 beste Teiler 60.8 (36.) 86.7 (35.) 98.0 (23.)
 Trefferlage 0.34 mm links, 0.80 mm hoch
 Streuwert 2.59, horizontal: 2.42, vertikal: 2.76

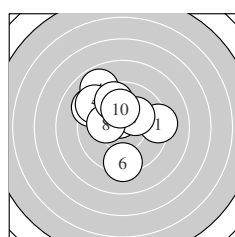
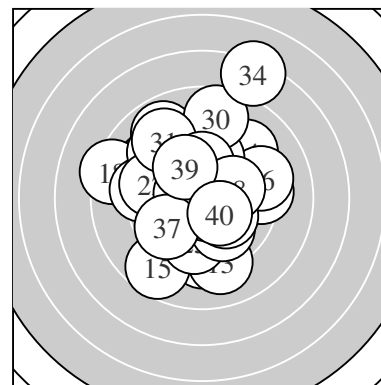

Serie 1:
 9.3 → 10.5 * 9.2 ↖ 8.9 ↗ 9.3 ↘
 9.3 ↓ 10.2 * 10.2 * 9.7 ↑ 10.1 ↑
 beste Teiler 103.4 (2.) 196.4 (7.) 196.5 (8.)
 Trefferlage 0.75 mm links, 1.36 mm hoch
 Streuwert 2.32, horizontal: 2.35, vertikal: 2.29

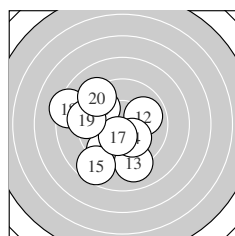

Serie 2:
 9.5 ↙ 9.9 → 9.1 ↓ 10.2 * 8.7 ↘
 9.7 ↖ 10.4 * 8.3 ← 9.3 ← 9.2 ↘
 beste Teiler 149.8 (17.) 192.2 (14.) 256.0 (12.)
 Trefferlage 1.67 mm links, 0.68 mm tief
 Streuwert 2.74, horizontal: 2.71, vertikal: 2.77

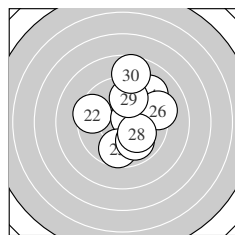

Serie 3:
 9.7 ↗ 9.5 ← 10.6 * 9.2 ↗ 9.7 ↓
 9.2 → 9.9 ↘ 10.1 ↘ 9.8 ↑ 8.7 ↑
 beste Teiler 98.0 (23.) 209.0 (28.) 259.0 (27.)
 Trefferlage 1.04 mm rechts, 1.06 mm hoch
 Streuwert 2.38, horizontal: 2.05, vertikal: 2.67

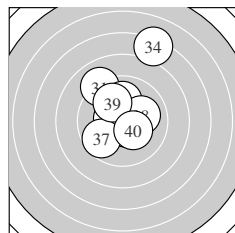

Serie 4:
 9.0 ↘ 10.5 * 10.0 ↑ 7.2 ↑ 10.6 *
 10.7 * 9.7 ↙ 10.1 → 10.0 ↘ 10.3 *
 beste Teiler 60.8 (36.) 86.7 (35.) 117.4 (32.)
 Trefferlage 0.01 mm rechts, 1.48 mm hoch
 Streuwert 2.59, horizontal: 1.96, vertikal: 3.09

Unterschrift des Schützen

Meyton Elektronik

Ergebnis: **395** (414.9)
 Serien: 99 98 99 99
 Zähler: 35 5 0 0 0 0 0 0 0 0
 Innenzehner: 34
 weiteste: 437 (23), 354 (6), 343 (17)
 beste Teiler 13.4 (21.) 17.4 (15.) 25.0 (35.)
 Trefferlage 0.06 mm links, 0.03 mm hoch
 Streuwert 1.24, horizontal: 1.41, vertikal: 1.06

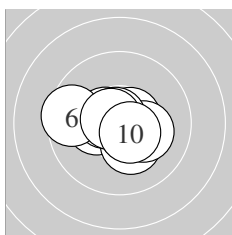
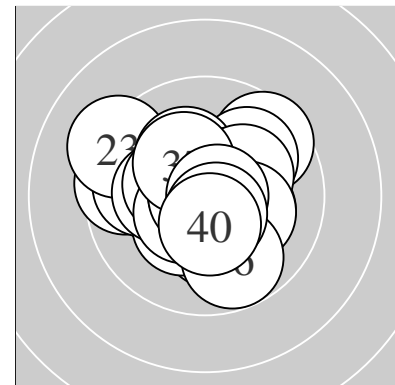

Serie 1:
 10.3 * 10.3 * 10.6 * 10.5 * 10.6 *
 9.5 ← 10.2 * 10.8 * 10.7 * 10.5 *
 beste Teiler 49.0 (8.) 69.7 (9.) 85.4 (3.)
 Trefferlage 0.23 mm links, 0.15 mm tief
 Streuwert 1.19, horizontal: 1.55, vertikal: 0.67

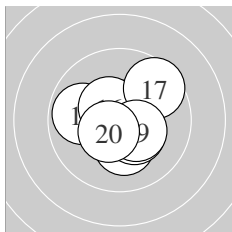

Serie 2:
 10.2 * 10.6 * 9.9 ← 10.7 * 10.9 *
 10.5 * 9.6 ↗ 10.4 * 10.4 * 10.5 *
 beste Teiler 17.4 (15.) 68.7 (14.) 93.2 (12.)
 Trefferlage 0.19 mm rechts, 0.04 mm hoch
 Streuwert 1.31, horizontal: 1.41, vertikal: 1.19

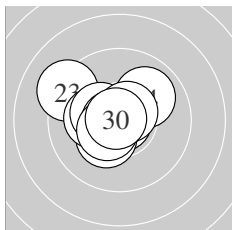

Serie 3:
 10.9 * 10.3 * 9.2 ↖ 10.0 ↗ 10.2 *
 10.4 * 10.6 * 10.7 * 10.5 * 10.8 *
 beste Teiler 13.4 (21.) 29.1 (30.) 56.5 (28.)
 Trefferlage 0.72 mm links, 0.30 mm hoch
 Streuwert 1.28, horizontal: 1.51, vertikal: 1.01

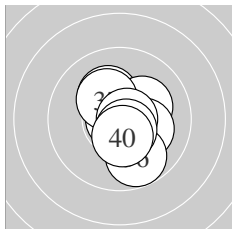

Serie 4:
 10.2 * 10.3 * 10.2 * 10.2 * 10.9 *
 9.8 ↓ 10.3 * 10.7 * 10.6 * 10.4 *
 beste Teiler 25.0 (35.) 54.0 (38.) 91.5 (39.)
 Trefferlage 0.51 mm rechts, 0.06 mm tief
 Streuwert 1.18, horizontal: 0.98, vertikal: 1.34

Unterschrift des Schützen

Meyton Elektronik

Ergebnis: **394** (412.7)
 Serien: 99 98 98 99
 Zähler: 34 6 0 0 0 0 0 0 0 0
 Innenzehner: 30
 weiteste: 412 (29), 356 (22), 300 (20)
 beste Teiler 33.5 (25.) 38.0 (10.) 38.1 (4.)
 Trefferlage 0.01 mm links, 0.36 mm hoch
 Streuwert 1.27, horizontal: 1.42, vertikal: 1.10

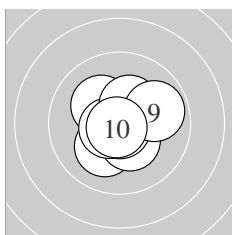
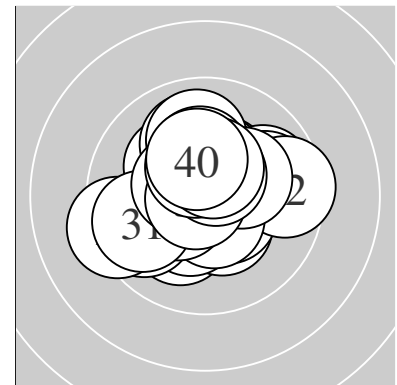

Serie 1:
 10.5 * 10.1 ↘ 10.4 * 10.8 * 10.7 *
 10.2 * 10.6 * 10.4 * 9.9 → 10.8 *
 beste Teiler 38.0 (10.) 38.1 (4.) 55.9 (5.)
 Trefferlage 0.14 mm rechts, 0.10 mm hoch
 Streuwert 1.10, horizontal: 1.13, vertikal: 1.07

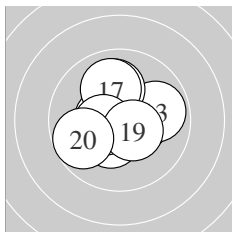

Serie 2:
 10.3 * 10.4 * 9.9 → 10.4 * 10.5 *
 10.0 ↑ 10.0 ↑ 10.5 * 10.5 * 9.8 ←
 beste Teiler 108.7 (15.) 123.2 (19.) 124.3 (18.)
 Trefferlage 0.00 mm , 0.14 mm hoch
 Streuwert 1.45, horizontal: 1.60, vertikal: 1.29

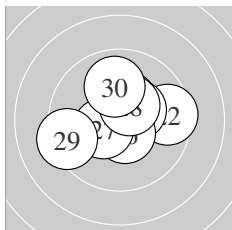

Serie 3:
 10.4 * 9.5 → 10.4 * 10.7 * 10.8 *
 10.5 * 10.4 * 10.4 * 9.3 ← 10.0 ↑
 beste Teiler 33.5 (25.) 74.2 (24.) 104.0 (26.)
 Trefferlage 0.05 mm rechts, 0.39 mm hoch
 Streuwert 1.56, horizontal: 1.87, vertikal: 1.16

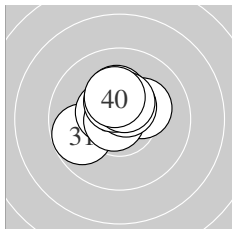

Serie 4:
 9.8 ← 10.4 * 10.5 * 10.2 * 10.8 *
 10.5 * 10.4 * 10.3 * 10.4 * 10.3 *
 beste Teiler 42.7 (35.) 103.7 (36.) 114.4 (33.)
 Trefferlage 0.25 mm links, 0.82 mm hoch
 Streuwert 1.01, horizontal: 1.13, vertikal: 0.87

Unterschrift des Schützen

Ergebnis: **382** (400.8)
 Serien: 97 97 96 92
 Zähler: 25 13 1 1 0 0 0 0 0 0
 Innenzehner: 21
 weiteste: 890 (32), 544 (20), 494 (38)
 beste Teiler 17.0 (4.) 30.3 (18.) 58.5 (14.)
 Trefferlage 0.12 mm links, 0.47 mm hoch
 Streuwert 2.05, horizontal: 2.28, vertikal: 1.79

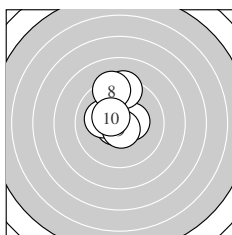
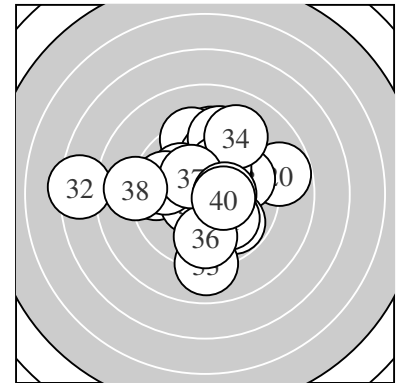

Serie 1:
 10.5 * 10.7 * 10.2 * 10.9 * 9.9 ↑
 10.4 * 9.4 ↑ 9.4 ↑ 10.7 * 10.4 *
 beste Teiler 17.0 (4.) 67.4 (2.) 72.2 (9.)
 Trefferlage 0.40 mm links, 1.14 mm hoch
 Streuwert 1.36, horizontal: 0.91, vertikal: 1.69

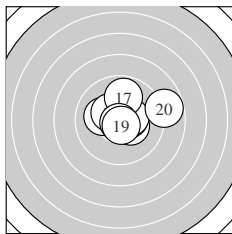

Serie 2:
 10.4 * 10.1 ← 10.5 * 10.7 * 10.4 *
 10.4 * 9.9 ↑ 10.8 * 10.7 * 8.8 →
 beste Teiler 30.3 (18.) 58.5 (14.) 63.6 (19.)
 Trefferlage 0.68 mm rechts, 0.41 mm hoch
 Streuwert 1.54, horizontal: 1.92, vertikal: 1.03

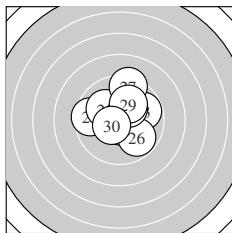

Serie 3:
 10.3 * 10.7 * 9.8 → 9.6 ← 10.1 ↘
 9.8 ↘ 9.3 ↑ 10.3 * 10.1 ↑ 10.5 *
 beste Teiler 70.8 (22.) 113.4 (30.) 154.6 (21.)
 Trefferlage 0.33 mm rechts, 0.65 mm hoch
 Streuwert 1.77, horizontal: 1.88, vertikal: 1.66

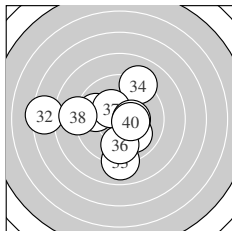

Serie 4:
 10.0 ↘ 7.4 ← 9.0 ↓ 9.1 ↑ 9.8 ←
 9.7 ↓ 10.3 * 9.0 ← 10.4 * 10.4 *
 beste Teiler 133.4 (40.) 139.0 (39.) 157.8 (37.)
 Trefferlage 1.10 mm links, 0.30 mm tief
 Streuwert 3.03, horizontal: 3.52, vertikal: 2.46

Unterschrift des Schützen

Meyton Elektronik

Ergebnis: **396** (411.4)
 Serien: 100 100 99 97
 Zähler: 36 4 0 0 0 0 0 0 0 0
 Innenzehner: 24
 weiteste: 351 (28), 306 (38), 261 (32)
 beste Teiler 5.3 (13.) 48.6 (4.) 64.3 (3.)
 Trefferlage 0.16 mm rechts, 0.15 mm hoch
 Streuwert 1.29, horizontal: 1.34, vertikal: 1.24

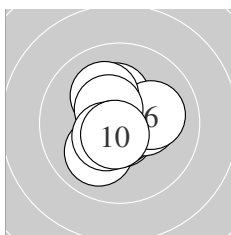
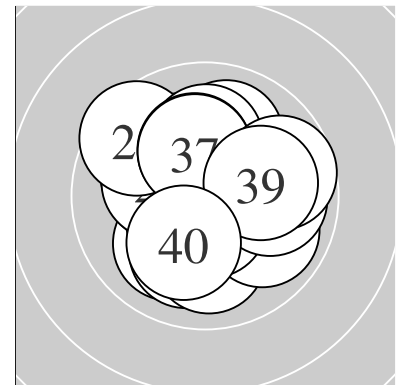

Serie 1:
 10.3 * 10.0 ↙ 10.7 * 10.8 * 10.3 *
 10.1 → 10.1 ↘ 10.5 * 10.5 * 10.6 *
 beste Teiler 48.6 (4.) 64.3 (3.) 81.1 (10.)
 Trefferlage 0.07 mm links, 0.04 mm hoch
 Streuwert 1.14, horizontal: 1.10, vertikal: 1.19

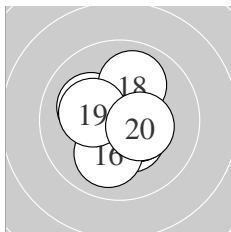

Serie 2:
 10.4 * 10.4 * 10.9 * 10.5 * 10.6 *
 10.0 ↓ 10.1 ↖ 10.0 ↑ 10.2 * 10.4 *
 beste Teiler 5.3 (13.) 94.3 (15.) 116.7 (14.)
 Trefferlage 0.00 mm , 0.05 mm tief
 Streuwert 1.21, horizontal: 1.22, vertikal: 1.21

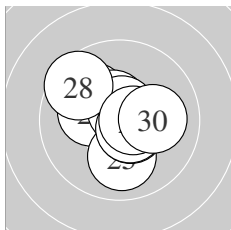

Serie 3:
 10.0 ↘ 10.5 * 10.2 * 10.7 * 10.0 ↓
 10.6 * 10.6 * 9.5 ↙ 10.6 * 10.1 →
 beste Teiler 66.4 (24.) 87.4 (27.) 89.0 (29.)
 Trefferlage 0.18 mm links, 0.25 mm hoch
 Streuwert 1.39, horizontal: 1.49, vertikal: 1.28

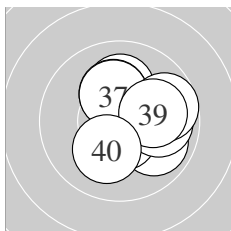

Serie 4:
 10.4 * 9.9 ↘ 10.6 * 10.1 ↑ 9.9 →
 10.2 * 10.2 * 9.7 → 10.1 → 10.1 ↓
 beste Teiler 99.4 (33.) 126.9 (31.) 179.5 (37.)
 Trefferlage 0.91 mm rechts, 0.39 mm hoch
 Streuwert 1.41, horizontal: 1.42, vertikal: 1.40

Unterschrift des Schützen

Meyton Elektronik

Ergebnis: **379** (395.0)
 Serien: 96 96 94 93
 Zähler: 22 15 3 0 0 0 0 0 0 0
 Innenzehner: 18
 weiteste: 719 (30), 534 (35), 504 (7)
 beste Teiler 70.2 (16.) 74.3 (4.) 115.3 (2.)
 Trefferlage 0.38 mm links, 1.29 mm hoch
 Streuwert 1.96, horizontal: 2.17, vertikal: 1.73

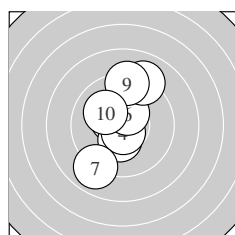
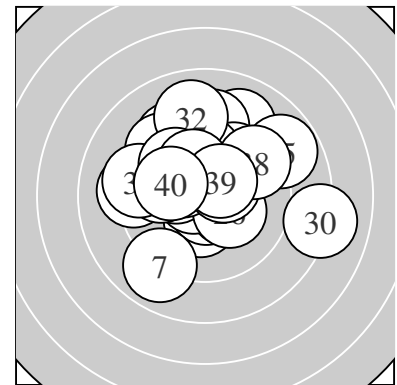

Serie 1:
 10.5 * 10.5 * 10.3 * 10.7 * 10.4 *
 10.4 * 8.9 ↙ 9.1 ↗ 9.2 ↑ 10.1 ↘
 beste Teiler 74.3 (4.) 115.3 (2.) 121.4 (1.)
 Trefferlage 0.25 mm links, 0.76 mm hoch
 Streuwert 2.02, horizontal: 1.33, vertikal: 2.54

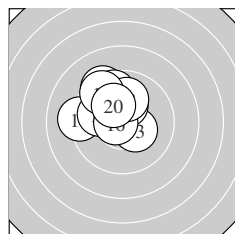

Serie 2:
 9.2 ← 9.3 ↖ 10.3 * 10.3 * 10.0 ↗
 10.7 * 9.7 ↗ 10.0 ↑ 9.5 ↖ 10.2 *
 beste Teiler 70.2 (16.) 151.6 (13.) 173.3 (14.)
 Trefferlage 1.13 mm links, 1.55 mm hoch
 Streuwert 1.55, horizontal: 1.65, vertikal: 1.44

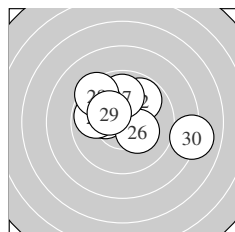

Serie 3:
 10.2 * 9.8 ↗ 9.8 ← 10.2 * 10.2 *
 10.3 * 9.9 ↑ 9.4 ↖ 10.3 * 8.1 →
 beste Teiler 164.7 (29.) 175.9 (26.) 178.2 (25.)
 Trefferlage 0.01 mm rechts, 1.03 mm hoch
 Streuwert 2.29, horizontal: 2.90, vertikal: 1.43

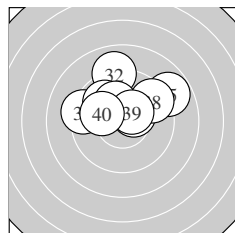

Serie 4:
 9.9 ↖ 9.0 ↑ 9.3 ← 10.4 * 8.8 ↗
 9.9 ↖ 10.2 * 9.5 ↗ 10.4 * 10.1 ↖
 beste Teiler 128.8 (34.) 130.1 (39.) 194.7 (37.)
 Trefferlage 0.16 mm links, 1.83 mm hoch
 Streuwert 2.03, horizontal: 2.59, vertikal: 1.25

Unterschrift des Schützen

Meyton Elektronik

Ergebnis: **391** (406.5)
 Serien: 98 99 99 95
 Zähler: 32 7 1 0 0 0 0 0 0
 Innenzehner: 22
 weiteste: 743 (39), 384 (33), 298 (32)
 beste Teiler 51.6 (25.) 63.6 (16.) 67.2 (5.)
 Trefferlage 0.12 mm rechts, 0.09 mm hoch
 Streuwert 1.62, horizontal: 1.99, vertikal: 1.15

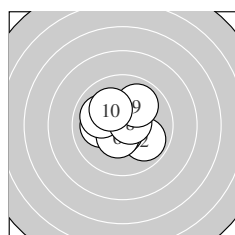
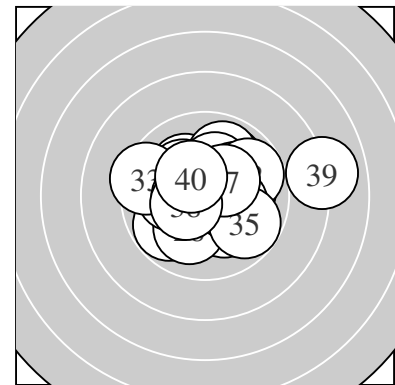

Serie 1:
 10.7 * 9.9 ↘ 10.1 ← 10.6 * 10.7 *
 10.4 * 10.0 ↖ 10.6 * 9.9 ↗ 10.1 ↘
 beste Teiler 67.2 (5.) 70.3 (1.) 78.2 (4.)
 Trefferlage 0.24 mm links, 0.25 mm hoch
 Streuwert 1.31, horizontal: 1.45, vertikal: 1.15

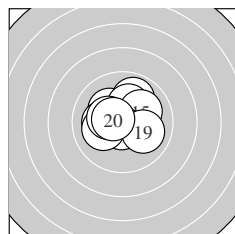

Serie 2:
 10.2 * 9.9 ↗ 10.1 ← 10.2 * 10.1 ↗
 10.7 * 10.1 ← 10.3 * 10.0 ↘ 10.5 *
 beste Teiler 63.6 (16.) 103.7 (20.) 155.6 (18.)
 Trefferlage 0.22 mm links, 0.49 mm hoch
 Streuwert 1.36, horizontal: 1.57, vertikal: 1.12

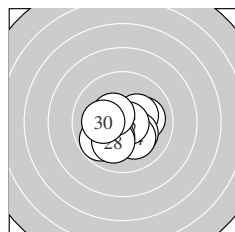

Serie 3:
 10.1 → 10.3 * 10.2 * 10.2 * 10.7 *
 9.8 ↙ 10.2 * 10.1 ↓ 10.5 * 10.1 ←
 beste Teiler 51.6 (25.) 125.4 (29.) 162.8 (22.)
 Trefferlage 0.04 mm links, 0.64 mm tief
 Streuwert 1.37, horizontal: 1.59, vertikal: 1.09

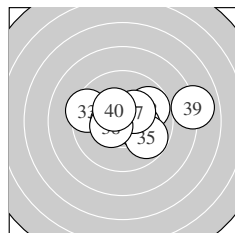

Serie 4:
 10.3 * 9.8 ↗ 9.4 ↖ 10.3 * 9.8 ↘
 10.5 * 10.3 * 10.4 * 8.0 → 10.4 *
 beste Teiler 110.1 (36.) 128.1 (38.) 148.2 (40.)
 Trefferlage 0.99 mm rechts, 0.28 mm hoch
 Streuwert 2.24, horizontal: 2.98, vertikal: 1.05

Unterschrift des Schützen

Meyton Elektronik

Ergebnis: **378** (398.6)
 Serien: 94 98 94 92
 Zähler: 18 22 0 0 0 0 0 0 0 0
 Innenzehner: 13
 weiteste: 466 (6), 425 (3), 419 (22)
 beste Teiler 49.3 (39.) 57.5 (30.) 67.7 (11.)
 Trefferlage 0.37 mm links, 0.00 mm
 Streuwert 1.92, horizontal: 2.18, vertikal: 1.61

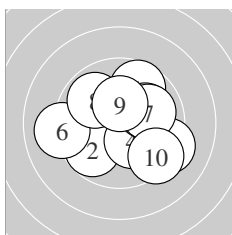
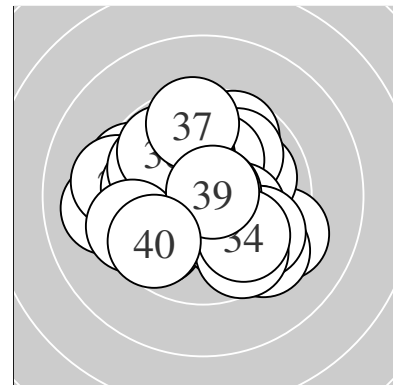

Serie 1:
 9.7 ↗ 9.8 ↙ 9.3 ↘ 10.3 * 10.0 ↗
 9.1 ← 10.0 → 9.9 ↘ 10.3 * 9.4 ↘
 beste Teiler 157.0 (9.) 172.0 (4.) 227.6 (5.)
 Trefferlage 0.48 mm rechts, 0.04 mm tief
 Streuwert 2.31, horizontal: 2.66, vertikal: 1.90

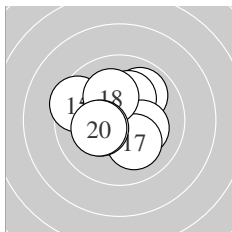

Serie 2:
 10.7 * 9.9 ↗ 10.6 * 10.2 * 9.5 ↖
 10.2 * 10.1 ↘ 10.1 ↘ 10.3 * 10.2 *
 beste Teiler 67.7 (11.) 97.6 (13.) 164.9 (19.)
 Trefferlage 0.08 mm links, 0.22 mm hoch
 Streuwert 1.53, horizontal: 1.68, vertikal: 1.36

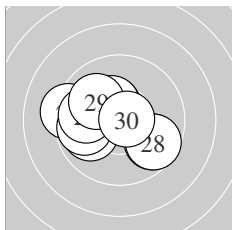

Serie 3:
 9.9 ↙ 9.3 ← 10.5 * 9.8 ← 9.9 ←
 10.4 * 9.7 ↘ 9.7 ↘ 10.0 ↘ 10.7 *
 beste Teiler 57.5 (30.) 125.3 (23.) 147.5 (26.)
 Trefferlage 0.91 mm links, 0.00 mm
 Streuwert 1.85, horizontal: 2.31, vertikal: 1.23

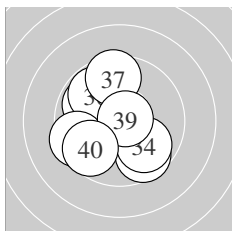

Serie 4:
 9.7 ↙ 9.9 ↖ 9.6 ↘ 9.9 ↘ 10.7 *
 9.8 ↘ 9.5 ↑ 9.5 ← 10.8 * 9.7 ↙
 beste Teiler 49.3 (39.) 68.2 (35.) 272.1 (32.)
 Trefferlage 0.97 mm links, 0.18 mm tief
 Streuwert 1.99, horizontal: 1.94, vertikal: 2.04

Unterschrift des Schützen

Meyton Elektronik

Ergebnis: **376** (395.8)
 Serien: 91 94 97 94
 Zähler: 17 22 1 0 0 0 0 0 0 0
 Innenzehner: 11
 weiteste: 621 (9), 476 (20), 460 (13)
 beste Teiler 69.3 (5.) 74.0 (23.) 74.3 (21.)
 Trefferlage 0.06 mm rechts, 0.06 mm tief
 Streuwert 2.10, horizontal: 2.52, vertikal: 1.57

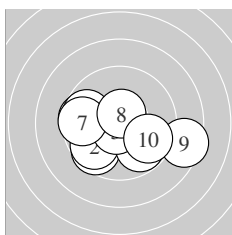
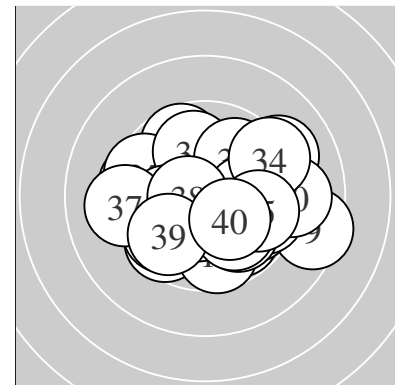

Serie 1:
 9.6 ↙ 9.7 ↙ 9.8 ↘ 9.6 ← 10.7 *
 9.7 ← 9.6 ← 10.6 * 8.5 → 9.8 ↘
 beste Teiler 69.3 (5.) 89.6 (8.) 290.3 (3.)
 Trefferlage 0.40 mm links, 0.82 mm tief
 Streuwert 2.39, horizontal: 3.11, vertikal: 1.33

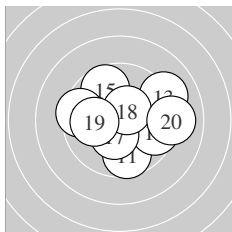

Serie 2:
 9.7 ↓ 10.4 * 9.1 ↗ 9.6 → 9.7 ↖
 9.5 ← 10.4 * 10.5 * 10.0 ← 9.0 →
 beste Teiler 113.6 (18.) 133.1 (12.) 145.1 (17.)
 Trefferlage 0.47 mm rechts, 0.19 mm hoch
 Streuwert 2.32, horizontal: 2.78, vertikal: 1.75

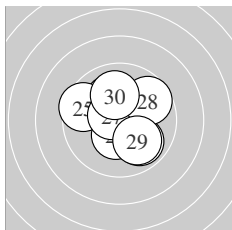

Serie 3:
 10.7 * 9.9 ↘ 10.7 * 10.1 ↖ 9.5 ←
 10.4 * 10.6 * 9.7 ↗ 10.0 ↘ 10.0 ↑
 beste Teiler 74.0 (23.) 74.3 (21.) 84.0 (27.)
 Trefferlage 0.03 mm rechts, 0.25 mm hoch
 Streuwert 1.65, horizontal: 1.71, vertikal: 1.59

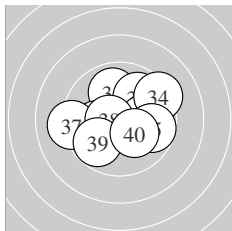

Serie 4:
 9.9 ↑ 9.9 ↗ 10.0 → 9.3 ↗ 9.7 →
 10.1 ← 9.2 ← 10.6 * 9.8 ↙ 10.2 *
 beste Teiler 94.1 (38.) 188.1 (40.) 217.0 (36.)
 Trefferlage 0.16 mm rechts, 0.12 mm hoch
 Streuwert 2.14, horizontal: 2.58, vertikal: 1.56

Unterschrift des Schützen

Meyton Elektronik

Ergebnis: **388** (406.8)
 Serien: 97 97 97 97
 Zähler: 29 10 1 0 0 0 0 0 0 0
 Innenzehner: 22
 weiteste: 503 (5), 453 (16), 396 (27)
 beste Teiler 5.3 (12.) 39.4 (38.) 49.3 (34.)
 Trefferlage 1.09 mm links, 0.62 mm hoch
 Streuwert 1.32, horizontal: 1.49, vertikal: 1.13

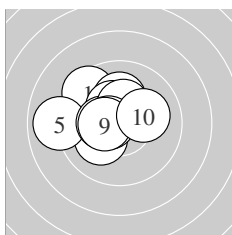
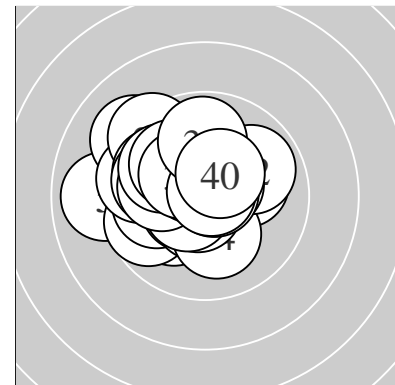

Serie 1:
 9.5 ↘ 10.1 ↑ 10.1 ↙ 10.4 * 8.9 ←
 10.4 * 10.4 * 10.6 * 10.5 * 10.1 →
 beste Teiler 91.0 (8.) 125.2 (9.) 141.0 (6.)
 Trefferlage 1.11 mm links, 0.67 mm hoch
 Streuwert 1.55, horizontal: 1.86, vertikal: 1.16

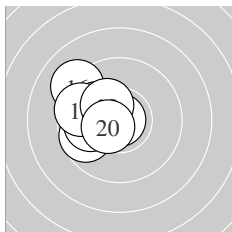

Serie 2:
 10.2 * 10.9 * 10.2 * 9.7 ↙ 10.0 ←
 9.1 ↘ 10.1 ↘ 9.6 ← 10.3 * 10.5 *
 beste Teiler 5.3 (12.) 112.3 (20.) 163.8 (19.)
 Trefferlage 1.96 mm links, 0.45 mm hoch
 Streuwert 1.12, horizontal: 1.09, vertikal: 1.15

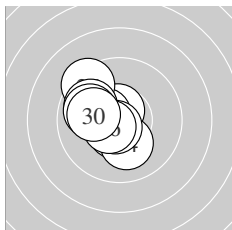

Serie 3:
 10.5 * 10.6 * 10.4 * 10.2 * 10.7 *
 10.5 * 9.4 ↘ 9.9 ↘ 9.9 ↘ 10.1 ←
 beste Teiler 69.1 (25.) 81.3 (22.) 102.9 (26.)
 Trefferlage 1.22 mm links, 0.26 mm hoch
 Streuwert 1.26, horizontal: 1.15, vertikal: 1.35

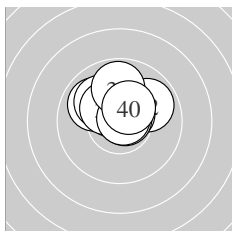

Serie 4:
 9.9 ↘ 9.9 ↗ 10.6 * 10.8 * 10.0 ↘
 10.5 * 10.3 * 10.8 * 9.8 ↑ 10.4 *
 beste Teiler 39.4 (38.) 49.3 (34.) 93.0 (33.)
 Trefferlage 0.09 mm links, 1.11 mm hoch
 Streuwert 1.07, horizontal: 1.31, vertikal: 0.75

Unterschrift des Schützen

Meyton Elektronik

Ergebnis:	381	(399.1)
Serien:	96 93 95 97	
Zähler:	23 15 2 0 0 0 0 0 0 0	
Innenzehner:	17	
weiteste:	569 (23), 542 (18), 461 (4)	
beste Teiler	72.1 (5.) 86.4 (36.) 92.6 (11.)	
Trefferlage	0.11 mm links, 0.33 mm tief	
Streuwert	1.96, horizontal: 2.24, vertikal: 1.62	

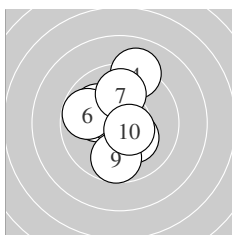
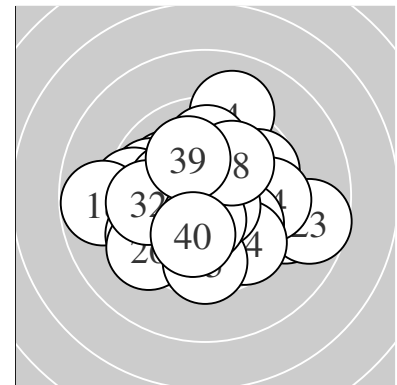

Serie 1:	10.1 ↖	10.6 *	10.0 ↖	9.1 ↗	10.7 *
	9.8 ↖	9.9 ↑	10.2 *	9.7 ↓	10.5 *
beste Teiler	72.1 (5.)	94.3 (2.)	102.9 (10.)		
Trefferlage	0.32 mm links, 0.46 mm hoch				
Streuwert	1.79, horizontal: 1.48, vertikal: 2.06				

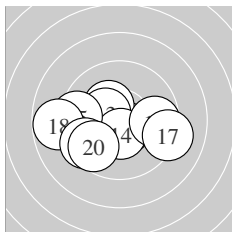

Serie 2:	10.6 *	10.3 *	10.4 *	10.5 *	9.4 ←
	9.7 →	9.2 ↘	8.8 ←	9.5 ↙	9.6 ↙
beste Teiler	92.6 (11.)	121.4 (14.)	138.2 (13.)		
Trefferlage	0.86 mm links, 0.59 mm tief				
Streuwert	2.28, horizontal: 3.01, vertikal: 1.15				

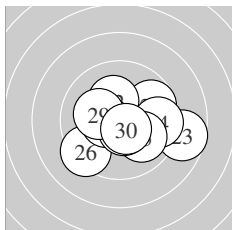

Serie 3:	9.7 ↗	10.2 *	8.7 ↘	9.6 →	10.0 ↘
	9.3 ↙	10.5 *	10.6 *	10.2 *	10.6 *
beste Teiler	96.0 (28.)	96.6 (30.)	119.2 (27.)		
Trefferlage	0.80 mm rechts, 0.40 mm tief				
Streuwert	2.08, horizontal: 2.62, vertikal: 1.34				

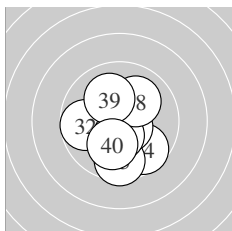

Serie 4:	10.5 *	9.7 ←	10.3 *	9.7 ↘	9.6 ↓
	10.6 *	10.4 *	10.1 ↗	10.1 ↖	10.1 ↓
beste Teiler	86.4 (36.)	120.3 (31.)	127.1 (37.)		
Trefferlage	0.07 mm links, 0.81 mm tief				
Streuwert	1.60, horizontal: 1.46, vertikal: 1.73				

Unterschrift des Schützen

Ergebnis:	387	(405.8)
Serien:	96	97 98 96
Zähler:	27	13 0 0 0 0 0 0 0 0
Innenzehner:	18	
weiteste:	483	(35), 363 (16), 347 (7)
beste Teiler	46.0	(9.) 50.6 (19.) 56.7 (29.)
Trefferlage	0.38 mm links, 0.17 mm tief	
Streuwert	1.57, horizontal: 1.61, vertikal: 1.53	

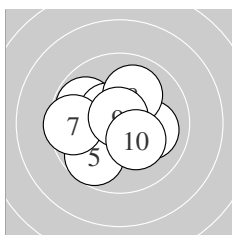
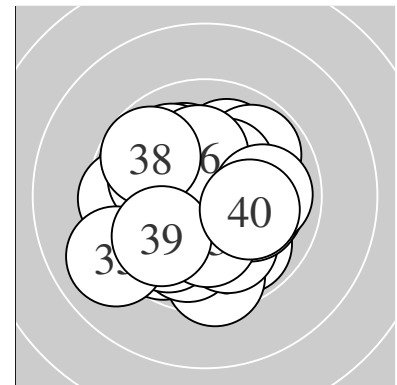

Serie 1:

9.9 ↙	9.8 ↖	10.5 *	10.6 *	9.7 ↘
10.1 →	9.6 ←	10.0 ↑	10.8 *	10.3 *
beste Teiler	46.0 (9.) 89.3 (4.) 113.1 (3.)			
Trefferlage	0.55 mm links, 0.11 mm tief			
Streuwert	1.64, horizontal: 1.88, vertikal: 1.36			

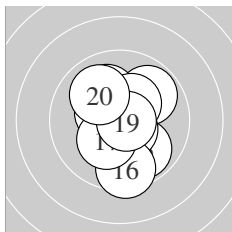

Serie 2:

9.8 ↗	10.1 ↖	9.9 ↘	10.5 *	10.6 *
9.5 ↓	10.3 *	10.3 *	10.8 *	10.0 ↖
beste Teiler	50.6 (19.) 92.7 (15.) 125.6 (14.)			
Trefferlage	0.16 mm rechts, 0.04 mm tief			
Streuwert	1.61, horizontal: 1.24, vertikal: 1.91			

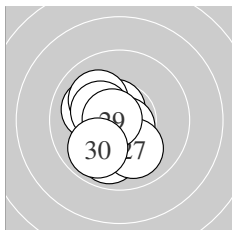

Serie 3:

10.6 *	10.3 *	10.0 ↖	10.1 ↖	9.9 ↘
10.7 *	10.0 ↘	10.3 *	10.7 *	9.9 ↘
beste Teiler	56.7 (29.) 64.8 (26.) 87.0 (21.)			
Trefferlage	0.86 mm links, 0.32 mm tief			
Streuwert	1.24, horizontal: 1.01, vertikal: 1.43			

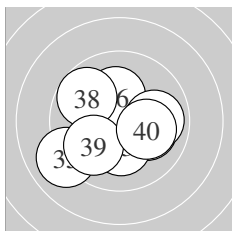

Serie 4:

10.7 *	10.1 →	10.2 *	10.4 *	9.0 ↙
10.2 *	9.9 →	9.7 ↖	9.9 ↙	10.1 →
beste Teiler	69.8 (31.) 144.3 (34.) 185.2 (36.)			
Trefferlage	0.28 mm links, 0.21 mm tief			
Streuwert	1.88, horizontal: 2.12, vertikal: 1.60			

Unterschrift des Schützen

Meyton Elektronik

Ergebnis: **386** (403.0)
 Serien: 96 95 99 96
 Zähler: 27 12 1 0 0 0 0 0 0 0
 Innenzehner: 20
 weiteste: 512 (16), 461 (11), 454 (33)
 beste Teiler 46.1 (12.) 61.0 (5.) 73.2 (21.)
 Trefferlage 0.19 mm rechts, 0.63 mm hoch
 Streuwert 1.71, horizontal: 1.88, vertikal: 1.53

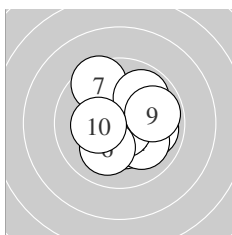
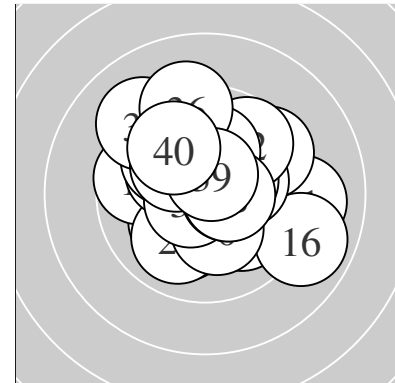

Serie 1:
 10.4 * 9.9 → 10.4 * 10.0 ↘ 10.7 *
 10.1 ↙ 9.5 ↘ 9.9 ↗ 9.9 → 10.3 *
 beste Teiler 61.0 (5.) 149.2 (3.) 149.4 (1.)
 Trefferlage 0.56 mm rechts, 0.13 mm hoch
 Streuwert 1.64, horizontal: 1.61, vertikal: 1.67

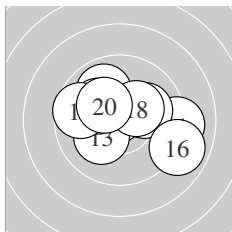

Serie 2:
 9.1 → 10.8 * 10.2 * 10.1 → 9.9 ↘
 8.9 → 10.1 ↘ 10.3 * 9.7 ← 10.3 *
 beste Teiler 46.1 (12.) 163.1 (18.) 171.8 (20.)
 Trefferlage 0.35 mm rechts, 0.36 mm hoch
 Streuwert 2.12, horizontal: 2.70, vertikal: 1.31

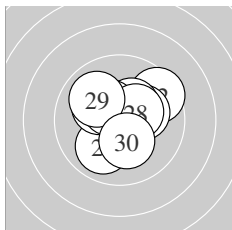

Serie 3:
 10.7 * 9.5 ↗ 10.2 * 10.0 ↙ 10.2 *
 10.4 * 10.4 * 10.4 * 10.0 ↘ 10.2 *
 beste Teiler 73.2 (21.) 126.0 (27.) 146.2 (28.)
 Trefferlage 0.13 mm rechts, 0.42 mm hoch
 Streuwert 1.50, horizontal: 1.63, vertikal: 1.35

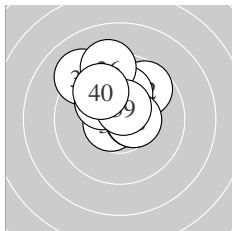

Serie 4:
 10.6 * 9.7 ↗ 9.1 ↘ 10.5 * 10.1 ↑
 9.3 ↑ 10.2 * 10.5 * 10.6 * 9.9 ↘
 beste Teiler 77.8 (31.) 98.9 (39.) 108.0 (34.)
 Trefferlage 0.25 mm links, 1.61 mm hoch
 Streuwert 1.52, horizontal: 1.52, vertikal: 1.51

Unterschrift des Schützen

Meyton Elektronik

Ergebnis: **384** (403.9)
 Serien: 94 95 97 98
 Zähler: 25 14 1 0 0 0 0 0 0 0
 Innenzehner: 19
 weiteste: 511 (12), 480 (8), 408 (4)
 beste Teiler 33.0 (26.) 53.9 (21.) 60.8 (36.)
 Trefferlage 0.24 mm links, 0.02 mm tief
 Streuwert 1.73, horizontal: 2.01, vertikal: 1.40

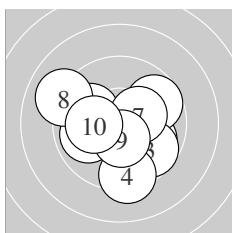
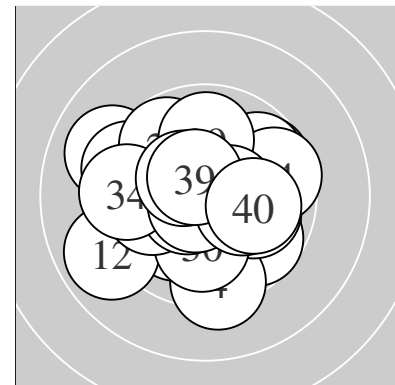

Serie 1:
 9.9 ↘ 9.7 ↗ 9.7 ↘ 9.3 ↓ 9.9 ←
 10.0 ↖ 10.3 * 9.0 ↖ 10.5 * 10.1 ←
 beste Teiler 121.8 (9.) 160.8 (7.) 201.3 (10.)
 Trefferlage 0.15 mm links, 0.44 mm tief
 Streuwert 2.16, horizontal: 2.46, vertikal: 1.82

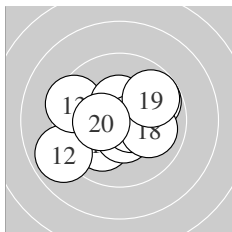

Serie 2:
 10.1 ↙ 8.9 ↖ 9.4 ↖ 10.4 * 9.8 ↗
 10.5 * 10.6 * 10.0 → 9.8 ↗ 10.4 *
 beste Teiler 95.5 (17.) 115.5 (16.) 128.1 (14.)
 Trefferlage 0.22 mm links, 0.09 mm tief
 Streuwert 2.03, horizontal: 2.45, vertikal: 1.49

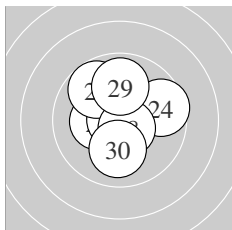

Serie 3:
 10.7 * 10.2 * 10.7 * 9.6 → 10.3 *
 10.8 * 9.8 ↘ 10.6 * 9.9 ↑ 10.0 ↓
 beste Teiler 33.0 (26.) 53.9 (21.) 67.6 (23.)
 Trefferlage 0.16 mm links, 0.44 mm hoch
 Streuwert 1.45, horizontal: 1.42, vertikal: 1.49

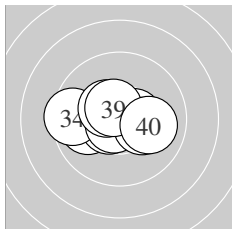

Serie 4:
 9.9 ← 10.5 * 10.6 * 9.5 ← 10.6 *
 10.7 * 10.2 * 10.4 * 10.6 * 10.0 →
 beste Teiler 60.8 (36.) 78.0 (35.) 96.8 (33.)
 Trefferlage 0.44 mm links, 0.00 mm
 Streuwert 1.35, horizontal: 1.82, vertikal: 0.57

Unterschrift des Schützen

Meyton Elektronik

Ergebnis: **377** (392.2)
 Serien: 95 94 95 93
 Zähler: 20 17 3 0 0 0 0 0 0 0
 Innenzehner: 12
 weiteste: 572 (17), 546 (35), 519 (23)
 beste Teiler 91.7 (1.) 92.7 (3.) 135.7 (33.)
 Trefferlage 0.13 mm links, 0.54 mm hoch
 Streuwert 2.22, horizontal: 2.53, vertikal: 1.86

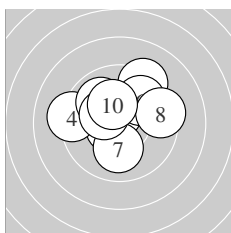
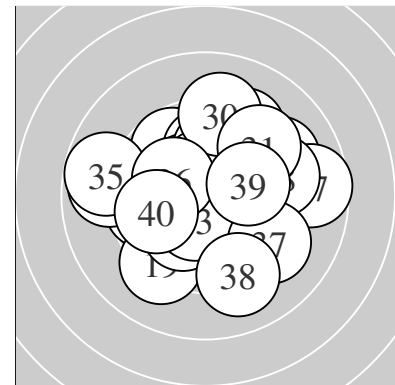

Serie 1:
 10.6 * 9.3 ↗ 10.6 * 9.2 ← 9.9 ↖
 9.8 ↗ 10.1 ↓ 9.4 → 10.3 * 10.2 *

beste Teiler 91.7 (1.) 92.7 (3.) 158.4 (9.)
 Trefferlage 0.14 mm links, 0.97 mm hoch
 Streuwert 1.93, horizontal: 2.25, vertikal: 1.55

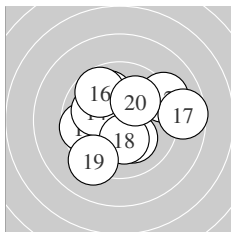

Serie 2:
 9.7 ← 9.2 ↗ 10.0 ↖ 10.0 ↖ 10.2 *
 9.7 ↖ 8.7 → 10.3 * 9.2 ↘ 10.1 ↗

beste Teiler 174.8 (18.) 199.0 (15.) 223.1 (20.)
 Trefferlage 0.22 mm rechts, 0.23 mm hoch
 Streuwert 2.51, horizontal: 2.89, vertikal: 2.04

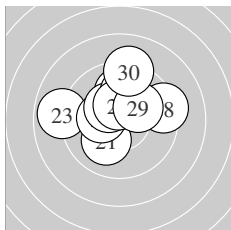

Serie 3:
 10.1 ↘ 10.0 ↑ 8.9 ← 10.3 * 10.4 *
 9.9 ↑ 10.4 * 9.3 → 10.1 ↗ 9.2 ↑

beste Teiler 136.7 (27.) 148.9 (25.) 164.2 (24.)
 Trefferlage 0.22 mm links, 1.30 mm hoch
 Streuwert 2.03, horizontal: 2.37, vertikal: 1.63

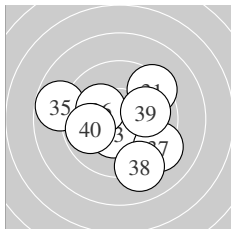

Serie 4:
 9.4 ↗ 10.4 * 10.4 * 9.8 ← 8.8 ←
 10.2 * 9.2 ↘ 9.1 ↓ 10.0 → 9.8 ←

beste Teiler 135.7 (33.) 147.4 (32.) 192.8 (36.)
 Trefferlage 0.39 mm links, 0.34 mm tief
 Streuwert 2.49, horizontal: 2.91, vertikal: 1.97

Unterschrift des Schützen

Meyton Elektronik

Ergebnis: **379** (398.3)
 Serien: 94 92 96 97
 Zähler: 22 15 3 0 0 0 0 0 0 0
 Innenzehner: 19
 weiteste: 671 (30), 539 (6), 517 (13)
 beste Teiler 36.4 (39.) 59.6 (26.) 66.7 (35.)
 Trefferlage 0.23 mm rechts, 0.20 mm hoch
 Streuwert 2.06, horizontal: 2.33, vertikal: 1.75

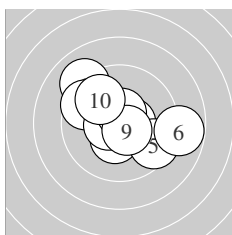
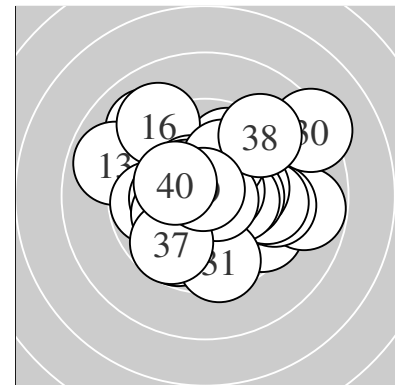

Serie 1:
 9.1 ↖ 9.6 ↖ 10.4 * 10.5 * 9.5 ↘
 8.8 → 10.5 * 10.6 * 10.6 * 9.8 ↖
 beste Teiler 91.5 (8.) 91.9 (9.) 101.0 (4.)
 Trefferlage 0.08 mm rechts, 0.35 mm hoch
 Streuwert 2.22, horizontal: 2.65, vertikal: 1.69

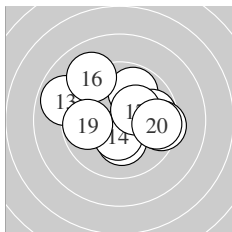

Serie 2:
 10.2 * 9.8 ↗ 8.9 ↖ 10.4 * 9.8 →
 9.1 ↖ 10.3 * 9.4 → 9.8 ← 9.6 →
 beste Teiler 136.7 (14.) 170.3 (17.) 184.0 (11.)
 Trefferlage 0.24 mm rechts, 0.51 mm hoch
 Streuwert 2.40, horizontal: 2.89, vertikal: 1.78

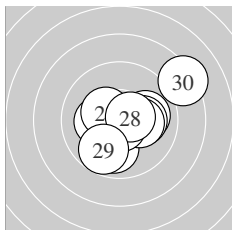

Serie 3:
 10.0 → 9.9 ↓ 10.2 * 10.1 → 10.2 *
 10.7 * 10.4 * 10.6 * 9.8 ↙ 8.3 ↗
 beste Teiler 59.6 (26.) 100.9 (28.) 143.3 (27.)
 Trefferlage 0.78 mm rechts, 0.11 mm tief
 Streuwert 2.03, horizontal: 2.29, vertikal: 1.73

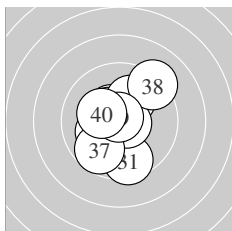

Serie 4:
 9.5 ↓ 10.4 * 10.5 * 10.1 ↗ 10.7 *
 10.2 * 9.7 ↙ 9.2 ↗ 10.8 * 10.3 *
 beste Teiler 36.4 (39.) 66.7 (35.) 125.8 (33.)
 Trefferlage 0.16 mm links, 0.08 mm hoch
 Streuwert 1.78, horizontal: 1.53, vertikal: 1.99

Unterschrift des Schützen

Meyton Elektronik

Ergebnis: **349** (368.3)
 Serien: 88 83 89 89
 Zähler: 10 16 9 4 0 1 0 0 0 0
 Innenzehner: 7
 weiteste: 1350 (16), 975 (25), 916 (39)
 beste Teiler 81.5 (8.) 92.7 (29.) 117.0 (40.)
 Trefferlage 0.69 mm rechts, 1.01 mm hoch
 Streuwert 3.56, horizontal: 4.28, vertikal: 2.65

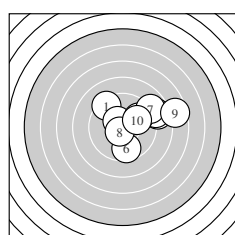
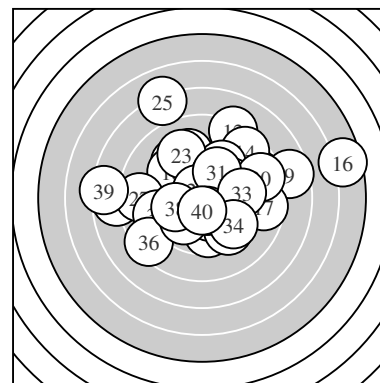

Serie 1:
 9.3 ↘ 8.6 → 10.5 * 8.7 → 9.8 ↗
 9.6 ↓ 8.9 ↗ 10.6 * 7.6 → 10.0 ↗
 beste Teiler 81.5 (8.) 124.9 (3.) 249.0 (10.)
 Trefferlage 2.45 mm rechts, 1.21 mm hoch
 Streuwert 2.72, horizontal: 3.32, vertikal: 1.93

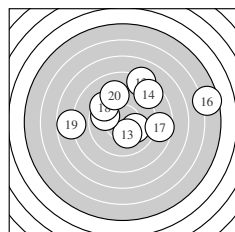

Serie 2:
 10.1 ↘ 8.2 ↗ 10.2 * 8.6 ↗ 9.8 ↖
 5.6 → 8.6 → 9.5 ↘ 7.8 ← 9.2 ↗
 beste Teiler 190.1 (13.) 216.0 (11.) 287.8 (15.)
 Trefferlage 1.36 mm rechts, 1.77 mm hoch
 Streuwert 4.48, horizontal: 5.72, vertikal: 2.72

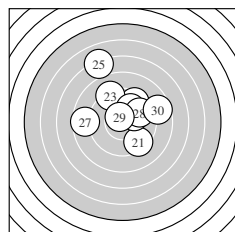

Serie 3:
 9.4 ↘ 9.5 ↗ 9.1 ↘ 10.2 * 7.1 ↖
 10.0 ↗ 8.6 ← 9.7 ↗ 10.6 * 8.6 →
 beste Teiler 92.7 (29.) 200.8 (24.) 249.0 (26.)
 Trefferlage 0.34 mm rechts, 2.05 mm hoch
 Streuwert 3.23, horizontal: 3.35, vertikal: 3.11

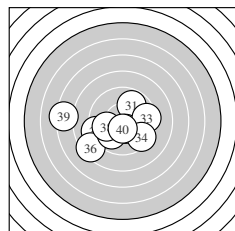

Serie 4:
 9.8 ↗ 10.4 * 9.5 → 9.4 ↘ 9.2 ←
 8.4 ↙ 9.9 ↙ 9.9 ← 7.3 ← 10.5 *
 beste Teiler 117.0 (40.) 129.2 (32.) 262.4 (38.)
 Trefferlage 1.39 mm links, 0.96 mm tief
 Streuwert 3.07, horizontal: 3.94, vertikal: 1.84

Unterschrift des Schützen

Meyton Elektronik