

Ergebnis: **399** (419.5)
 Serien: 100 100 100 99
 Zaehler: 39 1 0 0 0 0 0 0 0 0
 Innenzehner: 37
 weiteste: 372 (40), 246 (10), 204 (35)
 beste Teiler 11.1 (27.) 22.1 (29.) 55.5 (31.)
 Trefferlage 0.15 mm rechts, 0.10 mm hoch
 Streuwert 0.95, horizontal: 1.05, vertikal: 0.84

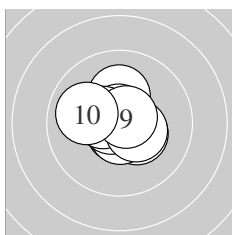

Serie 1:
 10.2 * 10.4 * 10.7 * 10.7 * 10.7 *
 10.7 * 10.5 * 10.4 * 10.7 * 10.0 ←
 beste Teiler 57.4 (4.) 57.5 (3.) 60.0 (6.)
 Trefferlage 0.14 mm links, 0.15 mm hoch
 Streuwert 0.97, horizontal: 1.07, vertikal: 0.84

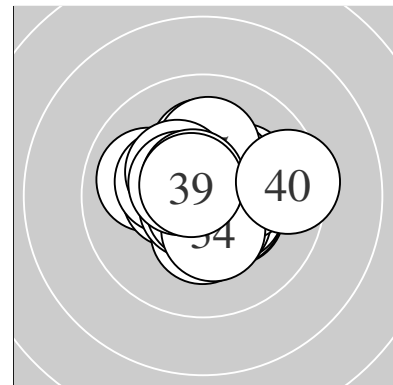
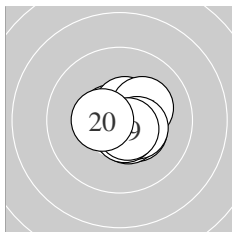

Serie 2:
 10.7 * 10.4 * 10.5 * 10.6 * 10.2 *
 10.5 * 10.4 * 10.6 * 10.6 * 10.5 *
 beste Teiler 72.4 (11.) 86.3 (19.) 89.0 (18.)
 Trefferlage 0.50 mm rechts, 0.11 mm tief
 Streuwert 0.80, horizontal: 0.88, vertikal: 0.70

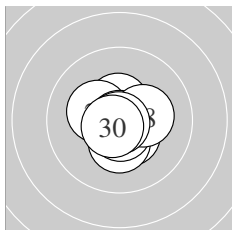

Serie 3:
 10.4 * 10.7 * 10.3 * 10.7 * 10.5 *
 10.3 * 10.9 * 10.3 * 10.9 * 10.7 *
 beste Teiler 11.1 (27.) 22.1 (29.) 68.7 (30.)
 Trefferlage 0.06 mm rechts, 0.14 mm tief
 Streuwert 0.83, horizontal: 0.83, vertikal: 0.83

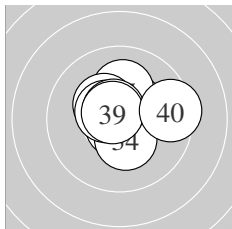

Serie 4:
 10.7 * 10.6 * 10.4 * 10.4 * 10.1 ↑
 10.3 * 10.5 * 10.6 * 10.7 * 9.5 →
 beste Teiler 55.5 (31.) 69.3 (39.) 76.8 (38.)
 Trefferlage 0.19 mm rechts, 0.51 mm hoch
 Streuwert 1.17, horizontal: 1.37, vertikal: 0.93

Unterschrift des Schuetzen

Ergebnis:	395	(411.8)
Serien:	99 98 98 100	
Zaehler:	35 5 0 0 0 0 0 0 0 0	
Innenzehner:	27	
weiteste:	367 (10), 367 (18), 367 (25)	
beste Teiler	46.1 (12.) 46.6 (35.) 49.0 (3.)	
Trefferlage	0.16 mm rechts, 0.19 mm tief	
Streuwert	1.33, horizontal: 1.52, vertikal: 1.10	

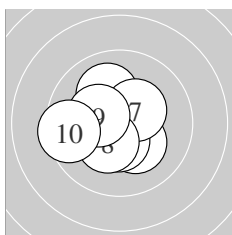
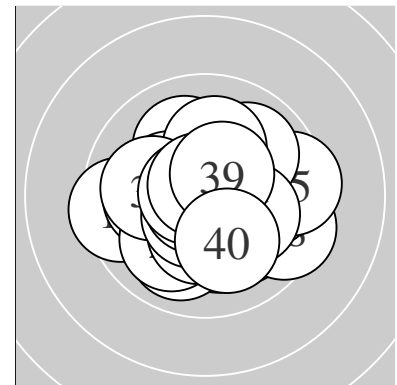

Serie 1:	10.6 *	10.2 *	10.8 *	10.4 *	10.5 *
	10.1 ↖	10.4 *	10.3 *	10.3 *	9.5 ←
beste Teiler	49.0 (3.) 99.0 (1.) 125.2 (5.)				
Trefferlage	0.66 mm links, 0.16 mm tief				
Streuwert	1.27, horizontal: 1.39, vertikal: 1.14				

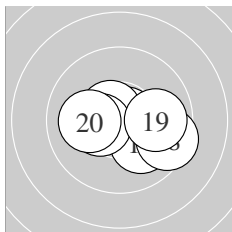

Serie 2:	10.4 *	10.8 *	10.4 *	10.6 *	10.1 ↘
	10.6 *	10.4 *	9.5 ↗	9.9 →	10.1 ←
beste Teiler	46.1 (12.) 88.4 (16.) 100.5 (14.)				
Trefferlage	0.53 mm rechts, 0.37 mm tief				
Streuwert	1.37, horizontal: 1.79, vertikal: 0.72				

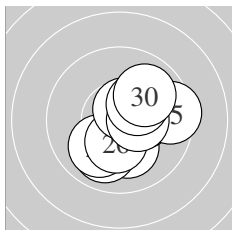

Serie 3:	10.2 *	10.3 *	10.0 ↙	10.0 ↘	9.5 →
	10.3 *	10.6 *	10.4 *	10.3 *	9.9 ↗
beste Teiler	85.2 (27.) 130.0 (28.) 157.0 (26.)				
Trefferlage	0.78 mm rechts, 0.31 mm tief				
Streuwert	1.47, horizontal: 1.49, vertikal: 1.45				

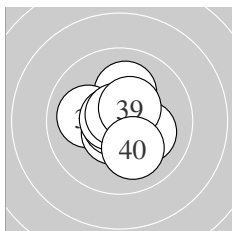

Serie 4:	10.1 ↑	10.7 *	10.0 ←	10.6 *	10.8 *
	10.2 *	10.7 *	10.7 *	10.5 *	10.1 ↘
beste Teiler	46.6 (35.) 52.3 (38.) 65.7 (37.)				
Trefferlage	0.02 mm rechts, 0.07 mm hoch				
Streuwert	1.10, horizontal: 1.11, vertikal: 1.10				

Unterschrift des Schuetzen

Meyton Elektronik

Ergebnis: **398** (415.9)
 Serien: 99 99 100 100
 Zaehler: 38 2 0 0 0 0 0 0 0 0
 Innenzehner: 32
 weiteste: 315 (1), 257 (13), 248 (20)
 beste Teiler 30.3 (2.) 36.4 (17.) 41.7 (15.)
 Trefferlage 0.21 mm rechts, 0.72 mm tief
 Streuwert 0.96, horizontal: 1.05, vertikal: 0.87

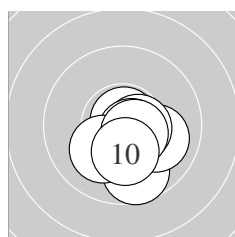
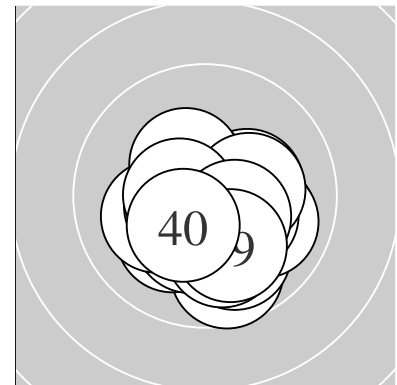

Serie 1:
 9.7 ↘ 10.8 * 10.3 * 10.5 * 10.0 ↘
 10.5 * 10.7 * 10.1 ↗ 10.6 * 10.3 *
 beste Teiler 30.3 (2.) 75.2 (7.) 94.8 (9.)
 Trefferlage 0.58 mm rechts, 1.02 mm tief
 Streuwert 0.94, horizontal: 0.93, vertikal: 0.94

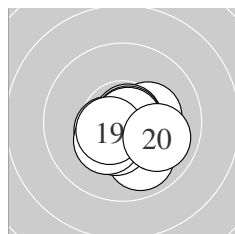

Serie 2:
 10.5 * 10.3 * 9.9 ↘ 10.8 * 10.8 *
 10.4 * 10.8 * 10.3 * 10.5 * 10.0 ↘
 beste Teiler 36.4 (17.) 41.7 (15.) 44.8 (14.)
 Trefferlage 0.29 mm rechts, 0.60 mm tief
 Streuwert 1.01, horizontal: 1.15, vertikal: 0.86

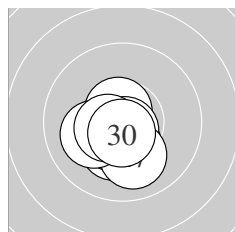

Serie 3:
 10.5 * 10.3 * 10.3 * 10.5 * 10.6 *
 10.7 * 10.0 ↘ 10.1 ↖ 10.5 * 10.7 *
 beste Teiler 57.9 (26.) 73.3 (30.) 78.5 (25.)
 Trefferlage 0.43 mm links, 0.86 mm tief
 Streuwert 0.80, horizontal: 0.78, vertikal: 0.81

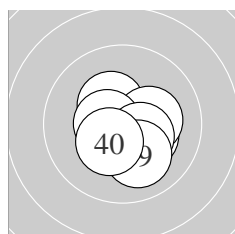

Serie 4:
 10.4 * 10.4 * 10.3 * 10.6 * 10.2 *
 10.6 * 10.5 * 10.4 * 10.1 ↘ 10.4 *
 beste Teiler 93.8 (34.) 97.2 (36.) 102.0 (37.)
 Trefferlage 0.41 mm rechts, 0.42 mm tief
 Streuwert 1.02, horizontal: 1.13, vertikal: 0.88

Unterschrift des Schuetzen

Ergebnis: **392** (411.0)
 Serien: 97 99 98 98
 Zaehler: 32 8 0 0 0 0 0 0 0 0
 Innenzehner: 24
 weiteste: 357 (9), 345 (24), 314 (21)
 beste Teiler 13.3 (3.) 18.3 (4.) 36.8 (7.)
 Trefferlage 0.03 mm rechts, 0.15 mm hoch
 Streuwert 1.36, horizontal: 1.57, vertikal: 1.11

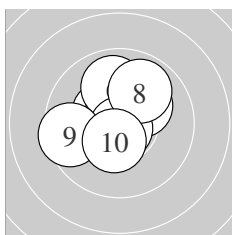
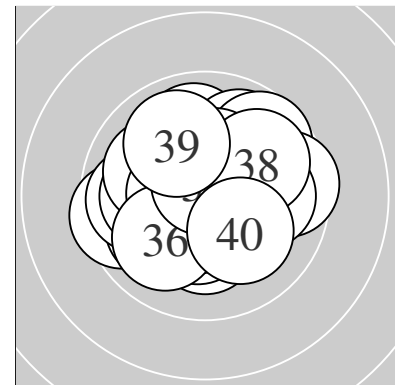

Serie 1:
 10.4 * 10.6 * 10.9 * 10.9 * 10.2 *
 9.9 ↑ 10.8 * 9.9 ↗ 9.5 ← 10.4 *
 beste Teiler 13.3 (3.) 18.3 (4.) 36.8 (7.)
 Trefferlage 0.25 mm links, 0.53 mm hoch
 Streuwert 1.32, horizontal: 1.39, vertikal: 1.24

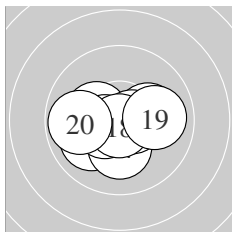

Serie 2:
 10.0 ↙ 10.6 * 10.1 → 10.2 * 10.3 *
 10.5 * 10.6 * 10.8 * 10.0 → 9.8 ←
 beste Teiler 40.1 (18.) 76.5 (12.) 87.8 (17.)
 Trefferlage 0.15 mm links, 0.38 mm tief
 Streuwert 1.31, horizontal: 1.71, vertikal: 0.74

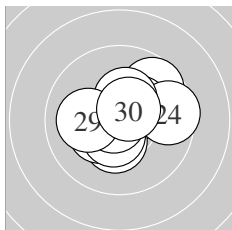

Serie 3:
 9.7 ↗ 10.3 * 10.3 * 9.6 → 10.3 *
 10.5 * 10.3 * 10.8 * 10.1 ← 10.6 *
 beste Teiler 41.5 (28.) 99.4 (30.) 113.4 (26.)
 Trefferlage 0.33 mm rechts, 0.23 mm hoch
 Streuwert 1.44, horizontal: 1.68, vertikal: 1.14

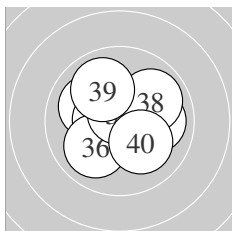

Serie 4:
 10.0 ↖ 10.5 * 10.6 * 10.4 * 10.0 →
 10.0 ↙ 10.7 * 9.9 ↗ 9.9 ↘ 10.1 ↘
 beste Teiler 59.1 (37.) 81.3 (33.) 108.4 (32.)
 Trefferlage 0.20 mm rechts, 0.24 mm hoch
 Streuwert 1.45, horizontal: 1.64, vertikal: 1.22

Unterschrift des Schuetzen

Meyton Elektronik

Ergebnis: **373** (395.4)
 Serien: 91 93 96 93
 Zaehler: 15 23 2 0 0 0 0 0 0 0
 Innenzehner: 10
 weiteste: 606 (5), 552 (26), 496 (18)
 beste Teiler 41.5 (19.) 44.7 (36.) 71.8 (32.)
 Trefferlage 0.08 mm rechts, 0.49 mm tief
 Streuwert 2.10, horizontal: 1.95, vertikal: 2.24

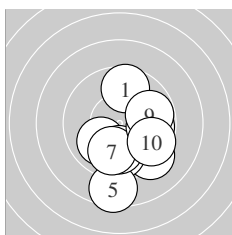
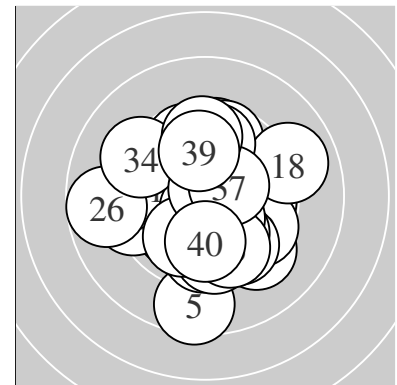

Serie 1:
 9.6 ↑ 10.0 ↙ 9.3 ↘ 9.8 ↓ 8.5 ↓
 10.0 ↓ 9.9 ↓ 9.8 → 9.8 → 9.6 ↘
 beste Teiler 241.1 (2.) 247.0 (6.) 265.6 (7.)
 Trefferlage 0.90 mm rechts, 1.66 mm tief
 Streuwert 2.16, horizontal: 1.79, vertikal: 2.48

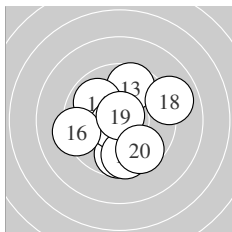

Serie 2:
 9.7 ↓ 10.4 * 9.7 ↑ 9.9 ↘ 10.7 *
 9.3 ← 9.7 ↓ 9.0 → 10.8 * 9.6 ↘
 beste Teiler 41.5 (19.) 72.4 (15.) 130.2 (12.)
 Trefferlage 0.11 mm rechts, 0.23 mm tief
 Streuwert 2.26, horizontal: 2.28, vertikal: 2.25

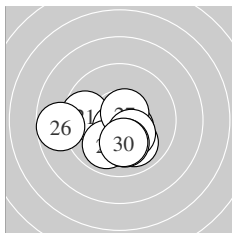

Serie 3:
 9.7 ← 10.6 * 9.9 ↙ 10.5 * 10.0 ↓
 8.7 ← 10.6 * 10.3 * 10.1 ↓ 10.1 ↓
 beste Teiler 80.4 (22.) 81.0 (27.) 115.0 (24.)
 Trefferlage 0.55 mm links, 1.06 mm tief
 Streuwert 1.73, horizontal: 2.20, vertikal: 1.07

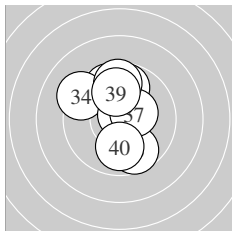

Serie 4:
 9.8 ↑ 10.7 * 9.7 ↖ 9.3 ↘ 9.7 ↓
 10.8 * 10.4 * 9.6 ↑ 9.9 ↑ 9.9 ↓
 beste Teiler 44.7 (36.) 71.8 (32.) 145.0 (37.)
 Trefferlage 0.14 mm links, 1.00 mm hoch
 Streuwert 1.86, horizontal: 1.42, vertikal: 2.22

Unterschrift des Schuetzen

Meyton Elektronik

Ergebnis: **382** (402.1)
 Serien: 97 93 96 96
 Zaehler: 22 18 0 0 0 0 0 0 0 0
 Innenzehner: 20
 weiteste: 401 (1), 382 (13), 365 (16)
 beste Teiler 65.3 (29.) 80.2 (7.) 104.0 (9.)
 Trefferlage 0.54 mm links, 0.69 mm hoch
 Streuwert 1.61, horizontal: 1.75, vertikal: 1.45

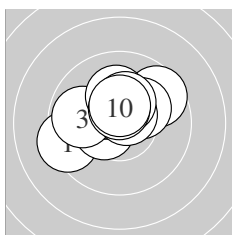
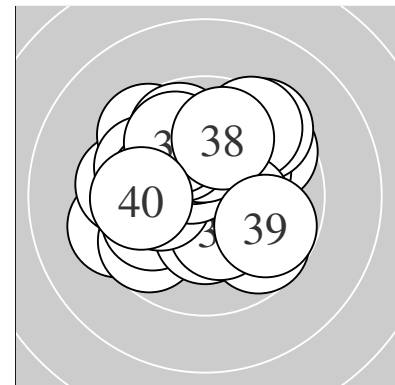

Serie 1:
 9.3 ← 10.5 * 9.9 ← 9.6 ↗ 10.2 *
 10.2 * 10.6 * 10.3 * 10.5 * 10.4 *
 beste Teiler 80.2 (7.) 104.0 (9.) 119.9 (2.)
 Trefferlage 0.27 mm links, 0.81 mm hoch
 Streuwert 1.53, horizontal: 1.89, vertikal: 1.04

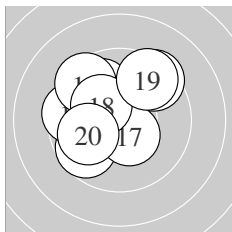

Serie 2:
 9.9 ↘ 9.7 ↗ 9.4 ↗ 10.2 * 9.6 ←
 9.5 ↘ 10.4 * 10.3 * 9.5 ↗ 9.9 ←
 beste Teiler 130.0 (17.) 172.1 (18.) 177.5 (14.)
 Trefferlage 0.98 mm links, 0.79 mm hoch
 Streuwert 1.94, horizontal: 2.03, vertikal: 1.86

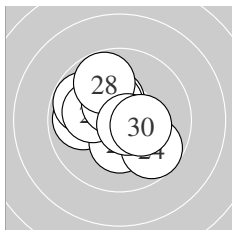

Serie 3:
 9.9 ← 10.3 * 9.8 ↘ 9.7 ↘ 10.4 *
 10.1 ← 10.4 * 9.8 ↘ 10.7 * 10.3 *
 beste Teiler 65.3 (29.) 133.4 (27.) 149.3 (25.)
 Trefferlage 0.48 mm links, 0.29 mm hoch
 Streuwert 1.57, horizontal: 1.68, vertikal: 1.45

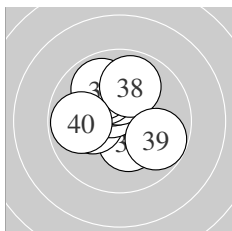

Serie 4:
 10.3 * 10.2 * 10.5 * 10.2 * 10.2 *
 10.0 ↘ 9.9 ↘ 9.9 ↑ 9.8 ↘ 9.8 ←
 beste Teiler 119.7 (33.) 157.9 (31.) 196.2 (34.)
 Trefferlage 0.43 mm links, 0.87 mm hoch
 Streuwert 1.53, horizontal: 1.54, vertikal: 1.51

Unterschrift des Schuetzen

Meyton Elektronik

Ergebnis:	383	(399.7)
Serien:	95 95 97 96	
Zähler:	23 17 0 0 0 0 0 0 0 0	
Innenzehner:	12	
weiteste:	448 (4), 418 (1), 396 (34)	
beste Teiler	53.8 (16.) 57.0 (26.) 62.5 (2.)	
Trefferlage	0.56 mm rechts, 0.08 mm tief	
Streuwert	1.83, horizontal: 1.90, vertikal: 1.75	

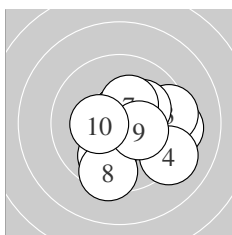
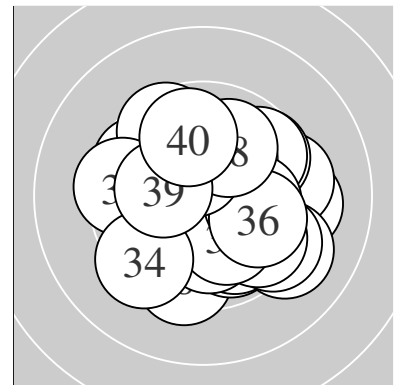

Serie 1:	9.3 →	10.7 *	9.4 →	9.2 ↘	10.1 ↗
	9.9 ↓	10.3 *	9.4 ↓	10.3 *	10.3 *
beste Teiler	62.5 (2.)	156.1 (10.)	158.8 (9.)		
Trefferlage	1.22 mm rechts, 0.57 mm tief				
Streuwert	1.93, horizontal: 2.11, vertikal: 1.73				

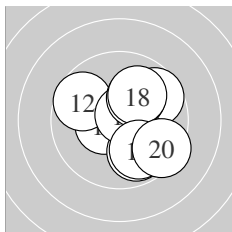

Serie 2:	10.5 *	9.7 ↖	9.7 ↗	9.9 ↘	10.0 ↘
	10.7 *	10.1 ↗	10.0 ↗	9.9 ↘	9.4 ↘
beste Teiler	53.8 (16.)	122.4 (11.)	210.4 (17.)		
Trefferlage	0.91 mm rechts, 0.16 mm tief				
Streuwert	1.80, horizontal: 1.77, vertikal: 1.82				

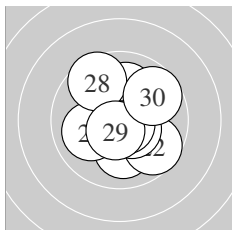

Serie 3:	10.1 ↓	9.7 ↘	10.5 *	10.0 ←	10.5 *
	10.7 *	10.1 ↑	9.6 ↖	10.6 *	9.7 ↗
beste Teiler	57.0 (26.)	85.2 (29.)	104.2 (25.)		
Trefferlage	0.36 mm rechts, 0.09 mm hoch				
Streuwert	1.65, horizontal: 1.53, vertikal: 1.76				

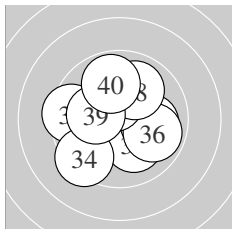

Serie 4:	10.1 ↑	10.1 ↘	9.5 ←	9.4 ↗	10.0 →
	9.9 →	10.4 *	10.0 ↑	10.2 *	9.8 ↑
beste Teiler	135.9 (37.)	185.1 (39.)	206.5 (31.)		
Trefferlage	0.26 mm links, 0.28 mm hoch				
Streuwert	1.95, horizontal: 2.07, vertikal: 1.83				

Unterschrift des Schuetzen

LG Liga – Wertung – offene Klasse

StartNr: 8

StandNr: 110

25. Februar 2017 17:48

Melmer, Christof #198

Mieming / Mieming

Ergebnis: **380** (399.6)
 Serien: 94 97 96 93
 Zaehler: 21 18 1 0 0 0 0 0 0 0
 Innenzehner: 14
 weiteste: 516 (5), 464 (9), 452 (23)
 beste Teiler 15.5 (14.) 19.0 (36.) 21.3 (17.)
 Trefferlage 0.21 mm links, 0.03 mm tief
 Streuwert 1.94, horizontal: 2.14, vertikal: 1.73

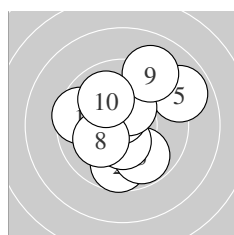
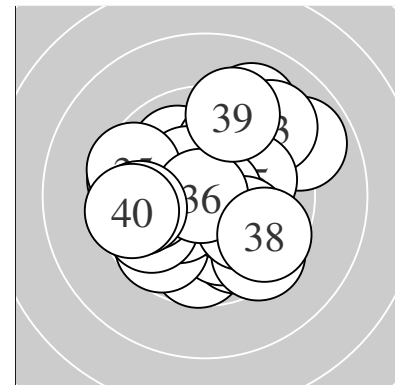

Serie 1:
 9.6 ← 9.7 ↓ 9.8 ↘ 10.4 * 8.9 ↗
 10.7 * 10.4 * 10.1 ↙ 9.1 ↗ 10.0 ↘
 beste Teiler 75.3 (6.) 128.0 (4.) 148.6 (7.)
 Trefferlage 0.17 mm rechts, 0.36 mm hoch
 Streuwert 2.25, horizontal: 2.21, vertikal: 2.29

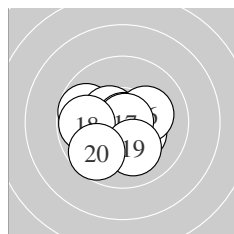

Serie 2:
 9.7 ← 10.5 * 10.3 * 10.9 * 10.7 *
 10.2 * 10.9 * 9.8 ← 10.1 ↓ 9.7 ↙
 beste Teiler 15.5 (14.) 21.3 (17.) 57.9 (15.)
 Trefferlage 0.49 mm links, 0.36 mm tief
 Streuwert 1.41, horizontal: 1.67, vertikal: 1.10

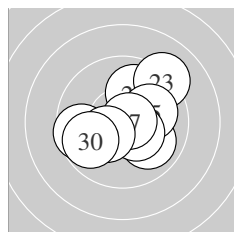

Serie 3:
 10.0 ↘ 10.0 ↑ 9.1 ↗ 9.7 ← 10.0 →
 10.4 * 10.8 * 9.6 ← 10.3 * 9.8 ↙
 beste Teiler 49.6 (27.) 139.0 (26.) 158.4 (29.)
 Trefferlage 0.02 mm links, 0.00 mm
 Streuwert 2.00, horizontal: 2.31, vertikal: 1.64

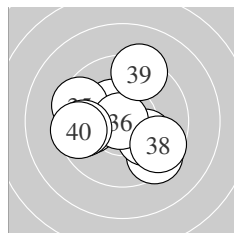

Serie 4:
 9.5 ↘ 9.9 ← 10.4 * 10.1 ↘ 9.5 ↖
 10.9 * 9.7 ← 9.6 ↘ 9.3 ↑ 9.5 ←
 beste Teiler 19.0 (36.) 134.4 (33.) 222.0 (34.)
 Trefferlage 0.51 mm links, 0.13 mm tief
 Streuwert 2.22, horizontal: 2.53, vertikal: 1.86

Unterschrift des Schuetzen

Meyton Elektronik

Ergebnis: **396** (412.9)
 Serien: 100 98 99 99
 Zaehler: 36 4 0 0 0 0 0 0 0 0
 Innenzehner: 32
 weiteste: 334 (26), 300 (20), 283 (19)
 beste Teiler 27.0 (32.) 35.3 (5.) 83.1 (14.)
 Trefferlage 0.00 mm , 0.07 mm hoch
 Streuwert 1.22, horizontal: 1.20, vertikal: 1.24

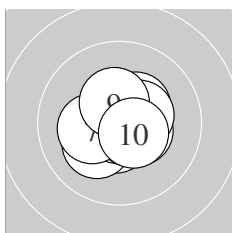
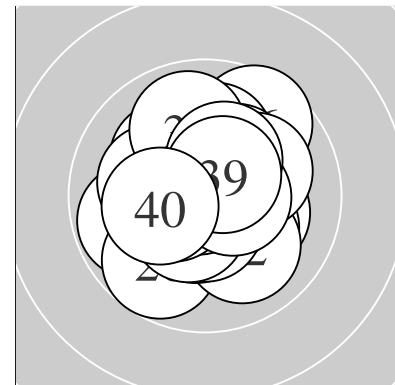

Serie 1:
 10.6 * 10.4 * 10.2 * 10.4 * 10.8 *
 10.6 * 10.2 * 10.4 * 10.4 * 10.5 *
 beste Teiler 35.3 (5.) 87.6 (6.) 97.9 (1.)
 Trefferlage 0.12 mm rechts, 0.17 mm tief
 Streuwert 0.97, horizontal: 1.08, vertikal: 0.85

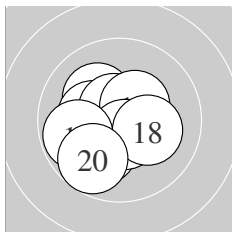

Serie 2:
 10.6 * 10.2 * 10.3 * 10.6 * 10.4 *
 10.1 ↘ 10.6 * 10.2 * 9.8 ← 9.8 ↙
 beste Teiler 83.1 (14.) 91.4 (11.) 97.4 (17.)
 Trefferlage 0.64 mm links, 0.42 mm tief
 Streuwert 1.31, horizontal: 1.37, vertikal: 1.25

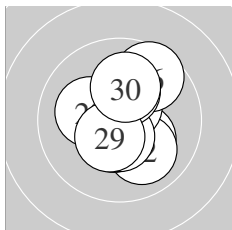

Serie 3:
 10.2 * 10.0 ↘ 10.5 * 10.5 * 10.5 *
 9.6 ↗ 10.2 * 10.2 * 10.5 * 10.1 ↑
 beste Teiler 103.3 (23.) 105.0 (25.) 115.7 (24.)
 Trefferlage 0.30 mm rechts, 0.18 mm hoch
 Streuwert 1.41, horizontal: 1.12, vertikal: 1.66

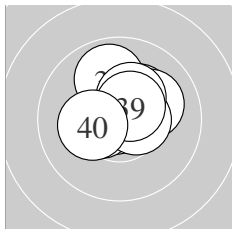

Serie 4:
 10.3 * 10.8 * 10.4 * 10.1 ↗ 9.9 ↑
 10.5 * 10.5 * 10.3 * 10.5 * 10.2 *
 beste Teiler 27.0 (32.) 106.5 (39.) 107.1 (37.)
 Trefferlage 0.23 mm rechts, 0.72 mm hoch
 Streuwert 1.04, horizontal: 1.16, vertikal: 0.92

Unterschrift des Schuetzen

Meyton Elektronik

Ergebnis:	392	(414.2)
Serien:	98	100 96 98
Zähler:	32	8 0 0 0 0 0 0 0 0
Innenzehner:	29	
weiteste:	403	(26), 307 (23), 302 (8)
beste Teiler	11.4	(3.) 39.8 (16.) 43.2 (11.)
Trefferlage	0.25 mm	rechts, 0.16 mm hoch
Streuwert	1.24,	horizontal: 1.35, vertikal: 1.12

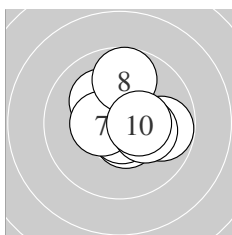
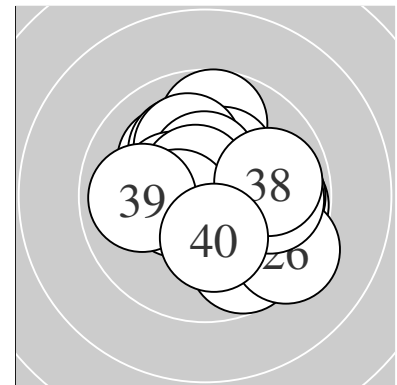

Serie 1:	10.6 *	9.8 →	10.9 *	10.6 *	10.2 *
	10.7 *	10.5 *	9.7 ↑	10.2 *	10.4 *
beste Teiler	11.4 (3.)	58.8 (6.)	83.6 (1.)		
Trefferlage	0.49 mm rechts, 0.13 mm hoch				
Streuwert	1.24, horizontal: 1.26, vertikal: 1.21				

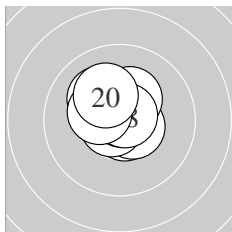

Serie 2:	10.8 *	10.7 *	10.6 *	10.3 *	10.7 *
	10.8 *	10.1 ↘	10.8 *	10.4 *	10.2 *
beste Teiler	39.8 (16.)	43.2 (11.)	50.3 (18.)		
Trefferlage	0.14 mm links, 0.43 mm hoch				
Streuwert	0.86, horizontal: 0.86, vertikal: 0.86				

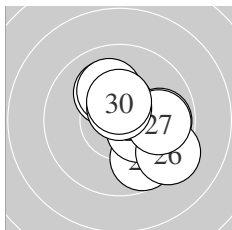

Serie 3:	10.6 *	10.1 ↘	9.7 ↘	9.8 →	10.4 *
	9.3 ↘	9.9 →	10.1 ↘	10.6 *	10.4 *
beste Teiler	84.0 (29.)	99.1 (21.)	127.0 (30.)		
Trefferlage	1.01 mm rechts, 0.12 mm hoch				
Streuwert	1.58, horizontal: 1.55, vertikal: 1.60				

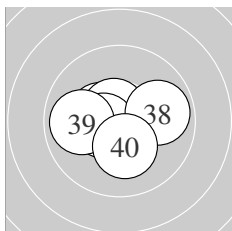

Serie 4:	10.6 *	10.7 *	10.4 *	10.7 *	10.8 *
	10.6 *	10.5 *	9.9 →	9.9 ←	10.2 *
beste Teiler	46.1 (35.)	56.8 (32.)	65.4 (34.)		
Trefferlage	0.36 mm links, 0.04 mm tief				
Streuwert	1.09, horizontal: 1.35, vertikal: 0.75				

Unterschrift des Schuetzen

Ergebnis:	386	(403.3)
Serien:	95	97 97 97
Zaehler:	26	14 0 0 0 0 0 0 0 0
Innenzehner:	17	
weiteste:	496	(33), 402 (26), 398 (9)
beste Teiler	49.2	(38.) 62.3 (29.) 76.0 (34.)
Trefferlage	0.03 mm	rechts, 0.18 mm tief
Streuwert	1.71,	horizontal: 1.95, vertikal: 1.44

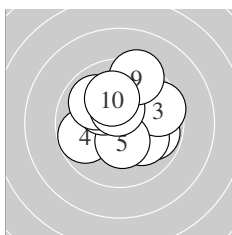
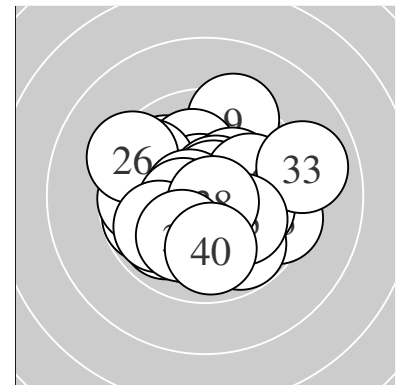

Serie 1:	9.8 →	10.1 ↘	9.6 →	9.8 ←	10.4 *
	10.2 *	9.9 ↙	10.5 *	9.4 ↑	10.1 ↑
beste Teiler	120.5	(8.) 146.8 (5.)	183.8 (6.)		
Trefferlage	0.24 mm	rechts, 0.66 mm hoch			
Streuwert	1.85,	horizontal: 1.99, vertikal: 1.70			

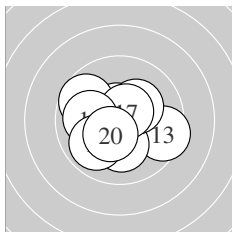

Serie 2:	10.6 *	10.4 *	9.5 →	10.2 *	9.7 ↙
	10.3 *	10.6 *	10.0 ←	9.9 ↘	10.4 *
beste Teiler	82.8	(11.) 88.6 (17.)	136.4 (20.)		
Trefferlage	0.39 mm	links, 0.17 mm tief			
Streuwert	1.61,	horizontal: 1.90, vertikal: 1.26			

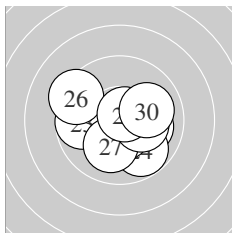

Serie 3:	10.1 →	10.2 *	9.7 ←	9.8 ↘	10.5 *
	9.3 ↙	10.1 ↓	10.2 *	10.7 *	10.0 →
beste Teiler	62.3	(29.) 106.6 (25.)	181.6 (28.)		
Trefferlage	0.31 mm	rechts, 0.28 mm tief			
Streuwert	1.76,	horizontal: 2.12, vertikal: 1.29			

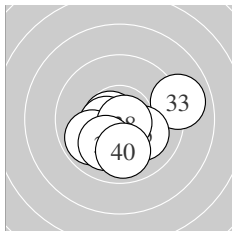

Serie 4:	10.1 ↘	10.3 *	9.0 →	10.6 *	10.1 ↘
	10.5 *	9.9 ↙	10.8 *	10.1 ↘	9.9 ↓
beste Teiler	49.2	(38.) 76.0 (34.)	113.8 (36.)		
Trefferlage	0.01 mm	links, 0.96 mm tief			
Streuwert	1.65,	horizontal: 2.02, vertikal: 1.16			

Unterschrift des Schuetzen

Meyton Elektronik

Ergebnis: **391** (407.9)
 Serien: 99 97 99 96
 Zaehler: 31 9 0 0 0 0 0 0 0 0
 Innenzehner: 22
 weiteste: 425 (39), 394 (31), 344 (34)
 beste Teiler 19.2 (22.) 46.4 (28.) 53.9 (10.)
 Trefferlage 0.02 mm links, 0.07 mm tief
 Streuwert 1.53, horizontal: 1.50, vertikal: 1.56

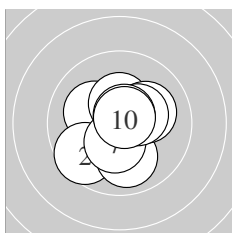
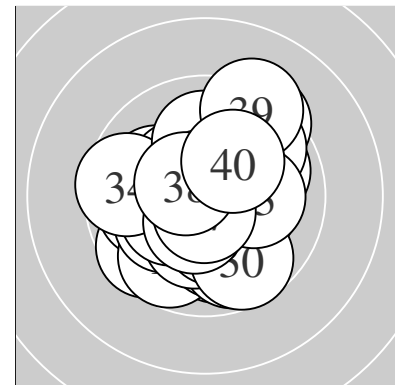

Serie 1:
 10.2 * 9.6 ↙ 10.4 * 10.5 * 10.0 ↓
 10.1 → 10.4 * 10.4 * 10.7 * 10.7 *
 beste Teiler 53.9 (10.) 66.7 (9.) 108.0 (4.)
 Trefferlage 0.03 mm links, 0.24 mm tief
 Streuwert 1.35, horizontal: 1.31, vertikal: 1.39

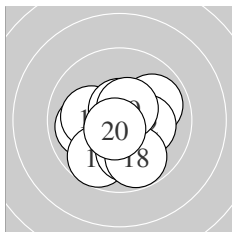

Serie 2:
 9.9 → 10.2 * 10.0 ← 10.1 ← 9.7 ↙
 10.6 * 10.0 ↓ 9.8 ↓ 10.5 * 10.7 *
 beste Teiler 72.9 (20.) 78.0 (16.) 101.7 (19.)
 Trefferlage 0.00 mm , 0.60 mm tief
 Streuwert 1.53, horizontal: 1.62, vertikal: 1.44

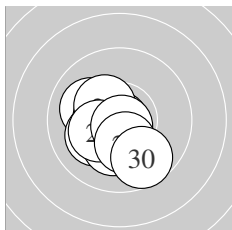

Serie 3:
 10.0 ↖ 10.9 * 10.5 * 10.4 * 10.1 ↙
 10.2 * 10.3 * 10.8 * 10.3 * 9.7 ↓
 beste Teiler 19.2 (22.) 46.4 (28.) 115.7 (23.)
 Trefferlage 0.59 mm links, 0.64 mm tief
 Streuwert 1.17, horizontal: 1.13, vertikal: 1.20

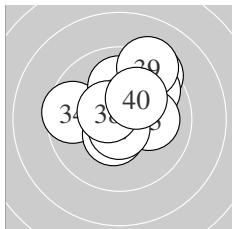

Serie 4:
 9.4 ↗ 9.8 ↗ 10.1 → 9.6 ← 10.5 *
 10.0 ↑ 10.7 * 10.6 * 9.3 ↗ 10.2 *
 beste Teiler 68.1 (37.) 99.3 (38.) 122.5 (35.)
 Trefferlage 0.51 mm rechts, 1.19 mm hoch
 Streuwert 1.74, horizontal: 1.84, vertikal: 1.63

Unterschrift des Schuetzen

Meyton Elektronik

Ergebnis:	374	(391.3)
Serien:	91 93 97 93	
Zaehler:	19 16 5 0 0 0 0 0 0 0	
Innenzehner:	12	
weiteste:	591 (15), 541 (33), 519 (3)	
beste Teiler	33.2 (12.) 61.0 (26.) 75.1 (34.)	
Trefferlage	0.33 mm links, 0.61 mm tief	
Streuwert	2.31, horizontal: 2.44, vertikal: 2.16	

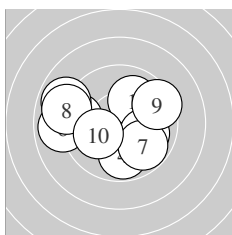
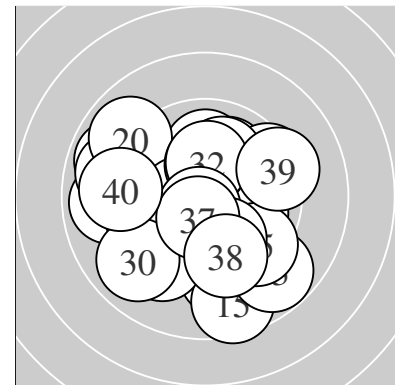

Serie 1:	10.0 ↗	9.4 ←	8.9 ↖	9.8 ↓	10.0 →
	8.9 ←	9.8 ↘	9.0 ←	9.4 ↗	10.1 ←
beste Teiler	214.6 (10.)	235.6 (1.)	243.0 (5.)		
Trefferlage	1.12 mm links, 0.03 mm hoch				
Streuwert	2.64, horizontal: 3.33, vertikal: 1.70				

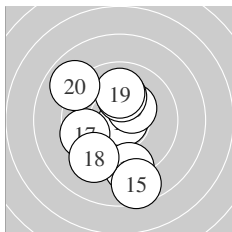

Serie 2:	10.0 ↙	10.8 *	10.3 *	9.2 ↓	8.6 ↓
	10.1 ↑	9.6 ←	9.3 ↙	10.0 ↑	8.9 ↖
beste Teiler	33.2 (12.)	153.4 (13.)	210.8 (16.)		
Trefferlage	0.66 mm links, 0.79 mm tief				
Streuwert	2.53, horizontal: 1.91, vertikal: 3.03				

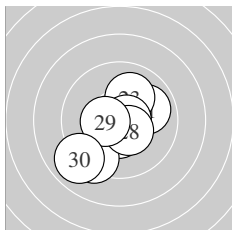

Serie 3:	9.9 →	10.4 *	10.1 ↗	10.6 *	10.5 *
	10.7 *	9.3 ↙	10.5 *	10.4 *	9.0 ↙
beste Teiler	61.0 (26.)	79.0 (24.)	120.1 (25.)		
Trefferlage	0.30 mm links, 0.81 mm tief				
Streuwert	1.72, horizontal: 1.73, vertikal: 1.72				

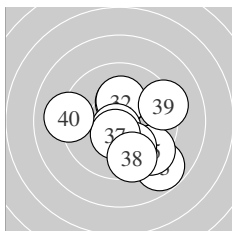

Serie 4:	10.3 *	10.2 *	8.8 ↘	10.7 *	9.4 ↘
	9.9 ↓	10.5 *	9.6 ↓	9.3 →	9.1 ←
beste Teiler	75.1 (34.)	125.2 (37.)	169.1 (31.)		
Trefferlage	0.74 mm rechts, 0.87 mm tief				
Streuwert	2.31, horizontal: 2.46, vertikal: 2.15				

Unterschrift des Schuetzen

Meyton Elektronik

Ergebnis: **391** (404.5)
 Serien: 97 97 100 97
 Zaehler: 32 7 1 0 0 0 0 0 0 0
 Innenzehner: 21
 weiteste: 579 (37), 453 (20), 407 (10)
 beste Teiler 60.0 (35.) 76.2 (34.) 76.5 (1.)
 Trefferlage 0.03 mm links, 0.73 mm hoch
 Streuwert 1.61, horizontal: 1.89, vertikal: 1.27

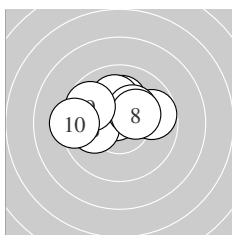
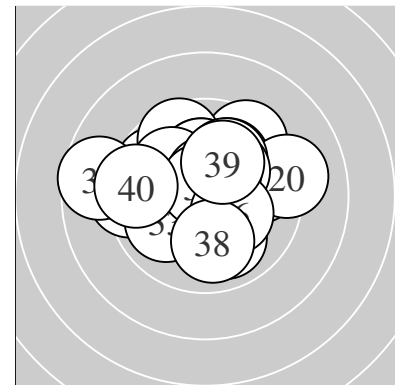

Serie 1:
 10.6 * 10.2 * 10.1 ↑ 10.1 ↑ 9.8 →
 10.0 ← 10.3 * 10.3 * 9.7 ↘ 9.3 ←
 beste Teiler 76.5 (1.) 165.5 (7.) 166.9 (8.)
 Trefferlage 0.40 mm links, 1.04 mm hoch
 Streuwert 1.59, horizontal: 2.09, vertikal: 0.85

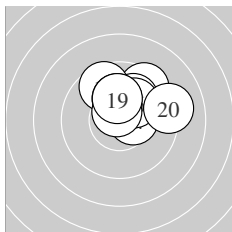

Serie 2:
 9.5 ↗ 10.0 ↗ 10.6 * 10.5 * 9.6 ↖
 10.1 ↗ 10.2 * 10.6 * 10.2 * 9.1 →
 beste Teiler 79.0 (18.) 84.2 (13.) 122.0 (14.)
 Trefferlage 0.86 mm rechts, 1.58 mm hoch
 Streuwert 1.34, horizontal: 1.62, vertikal: 0.96

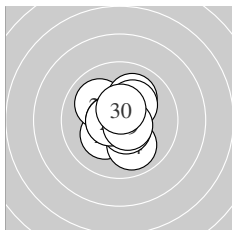

Serie 3:
 10.2 * 10.0 ↘ 10.1 ↗ 10.0 ↓ 10.6 *
 10.6 * 10.2 * 10.6 * 10.6 * 10.6 *
 beste Teiler 81.0 (26.) 82.3 (28.) 86.8 (29.)
 Trefferlage 0.00 mm , 0.08 mm hoch
 Streuwert 1.23, horizontal: 1.11, vertikal: 1.34

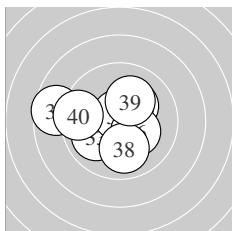

Serie 4:
 10.2 * 10.3 * 10.0 ← 10.6 * 10.7 *
 10.3 * 8.6 ← 10.0 ↓ 10.1 ↗ 9.4 ←
 beste Teiler 60.0 (35.) 76.2 (34.) 154.0 (32.)
 Trefferlage 0.62 mm links, 0.23 mm hoch
 Streuwert 1.96, horizontal: 2.42, vertikal: 1.36

Unterschrift des Schuetzen

Ergebnis: **367** (383.5)
 Serien: 90 89 94 94
 Zaehler: 15 17 8 0 0 0 0 0 0 0
 Innenzehner: 11
 weiteste: 748 (16), 718 (3), 687 (40)
 beste Teiler 103.8 (29.) 125.0 (23.) 127.6 (31.)
 Trefferlage 0.16 mm rechts, 0.23 mm hoch
 Streuwert 2.75, horizontal: 2.95, vertikal: 2.54

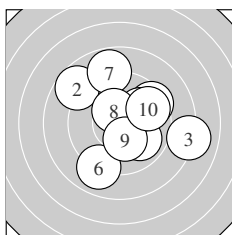
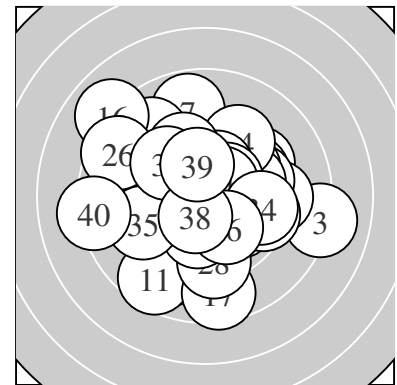

Serie 1:
 9.4 ↗ 8.7 ↘ 8.1 → 9.9 ↘ 10.0 ↗
 9.0 ↘ 8.8 ↑ 10.4 * 10.3 * 9.7 ↗
 beste Teiler 140.5 (8.) 171.4 (9.) 249.8 (5.)
 Trefferlage 0.98 mm rechts, 0.57 mm hoch
 Streuwert 3.03, horizontal: 3.20, vertikal: 2.86

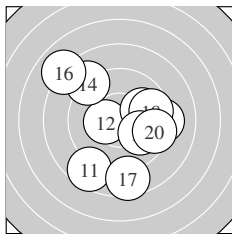

Serie 2:
 8.6 ↘ 10.4 * 9.2 → 9.0 ↘ 9.9 ↗
 8.0 ↘ 8.6 ↓ 9.6 → 10.0 ↘ 9.5 →
 beste Teiler 144.1 (12.) 245.2 (19.) 252.4 (15.)
 Trefferlage 0.28 mm rechts, 0.29 mm tief
 Streuwert 3.39, horizontal: 3.42, vertikal: 3.36

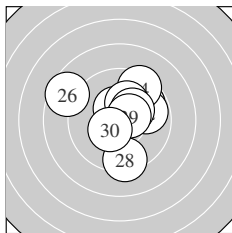

Serie 3:
 9.8 ↗ 9.8 → 10.5 * 9.4 ↗ 10.2 *
 8.6 ↘ 10.3 * 9.3 ↓ 10.5 * 10.4 *
 beste Teiler 103.8 (29.) 125.0 (23.) 137.1 (30.)
 Trefferlage 0.38 mm rechts, 0.78 mm hoch
 Streuwert 2.19, horizontal: 2.31, vertikal: 2.05

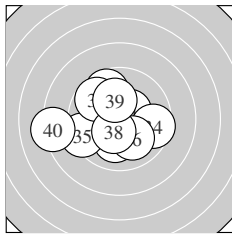

Serie 4:
 10.4 * 9.7 ↘ 10.1 ↓ 9.6 → 9.3 ←
 10.0 ↘ 9.7 ↘ 10.4 * 10.2 * 8.2 ←
 beste Teiler 127.6 (31.) 138.2 (38.) 196.9 (39.)
 Trefferlage 1.00 mm links, 0.12 mm tief
 Streuwert 2.39, horizontal: 2.84, vertikal: 1.84

Unterschrift des Schuetzen

Meyton Elektronik

Ergebnis:	381	(398.9)
Serien:	95 95 96 95	
Zaehler:	23 15 2 0 0 0 0 0 0 0	
Innenzehner:	18	
weiteste:	599 (2), 501 (20), 497 (30)	
beste Teiler	44.7 (1.) 52.0 (36.) 53.1 (22.)	
Trefferlage	0.58 mm links, 0.03 mm hoch	
Streuwert	1.97, horizontal: 2.21, vertikal: 1.69	

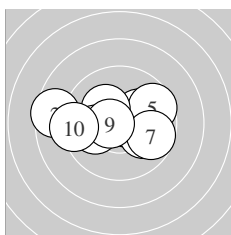
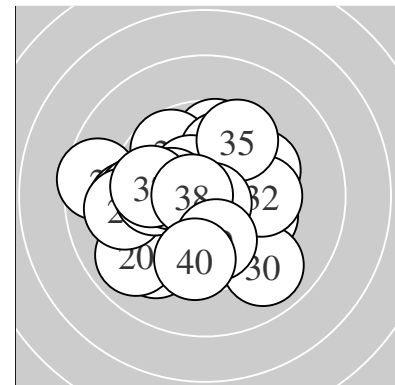

Serie 1:				
	10.8 *	8.6 ←	10.0 ↘	10.2 *
	10.2 *	9.7 ↘	10.0 ←	9.6 ↗
beste Teiler	44.7 (1.)	89.0 (9.)	183.1 (6.)	
Trefferlage	0.42 mm links, 0.15 mm hoch			
Streuwert	2.25, horizontal: 3.05, vertikal: 0.93			

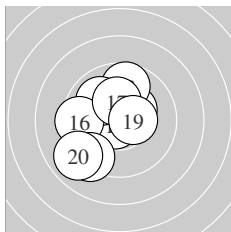

Serie 2:				
	10.3 *	10.3 *	9.7 ↑	10.7 *
	9.5 ←	10.3 *	9.2 ↙	10.0 ↘
beste Teiler	56.5 (14.)	124.0 (19.)	153.0 (11.)	
Trefferlage	1.11 mm links, 0.09 mm hoch			
Streuwert	1.99, horizontal: 1.88, vertikal: 2.08			

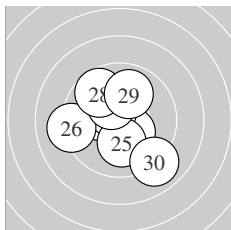

Serie 3:				
	10.3 *	10.7 *	10.4 *	10.6 *
	9.2 ←	10.3 *	9.7 ↘	10.1 ↓
beste Teiler	53.1 (22.)	100.4 (24.)	150.6 (23.)	
Trefferlage	0.41 mm links, 0.01 mm hoch			
Streuwert	2.01, horizontal: 2.04, vertikal: 1.98			

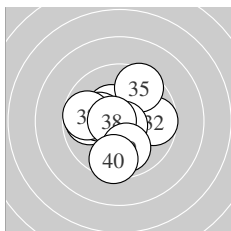

Serie 4:				
	9.9 ←	9.7 →	10.4 *	10.2 *
	10.7 *	9.7 ←	10.7 *	10.0 ↓
beste Teiler	52.0 (36.)	71.1 (38.)	134.2 (33.)	
Trefferlage	0.38 mm links, 0.11 mm tief			
Streuwert	1.86, horizontal: 1.92, vertikal: 1.80			

Unterschrift des Schuetzen

Ergebnis: **389** (406.7)
 Serien: 97 97 97 98
 Zaehler: 29 11 0 0 0 0 0 0 0 0
 Innenzehner: 24
 weiteste: 390 (3), 385 (40), 373 (2)
 beste Teiler 60.1 (5.) 61.0 (34.) 65.1 (8.)
 Trefferlage 0.63 mm rechts, 0.00 mm
 Streuwert 1.53, horizontal: 1.71, vertikal: 1.33

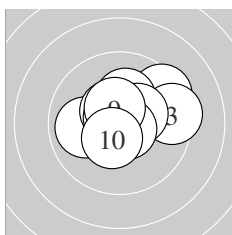
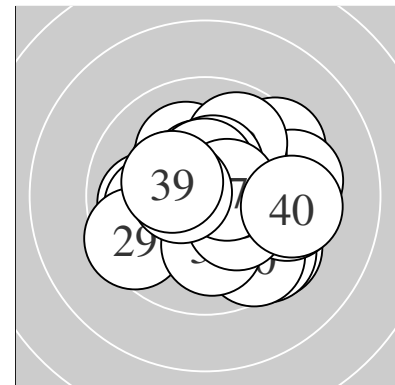

Serie 1:
 9.9 ← 9.5 ↗ 9.4 → 10.5 * 10.7 *
 10.2 * 10.4 * 10.7 * 10.5 * 10.5 *
 beste Teiler 60.1 (5.) 65.1 (8.) 113.4 (4.)
 Trefferlage 0.46 mm rechts, 0.58 mm hoch
 Streuwert 1.50, horizontal: 1.88, vertikal: 0.99

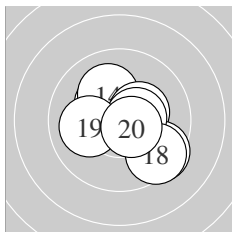

Serie 2:
 9.6 ↘ 10.3 * 10.4 * 10.1 ↖ 10.3 *
 9.5 ↘ 10.5 * 9.5 ↘ 10.1 ← 10.6 *
 beste Teiler 100.3 (20.) 122.9 (17.) 129.6 (13.)
 Trefferlage 0.68 mm rechts, 0.30 mm tief
 Streuwert 1.70, horizontal: 1.82, vertikal: 1.57

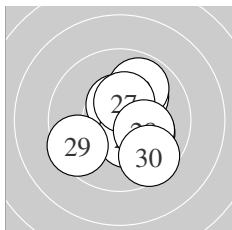

Serie 3:
 10.1 ↗ 9.9 ↗ 10.5 * 10.6 * 10.1 ↘
 10.4 * 10.4 * 10.2 * 9.5 ↙ 9.6 ↘
 beste Teiler 90.3 (24.) 114.3 (23.) 135.3 (27.)
 Trefferlage 0.69 mm rechts, 0.13 mm tief
 Streuwert 1.60, horizontal: 1.52, vertikal: 1.66

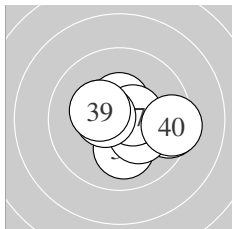

Serie 4:
 9.5 → 10.3 * 10.1 ↓ 10.7 * 10.3 *
 10.5 * 10.6 * 10.5 * 10.3 * 9.4 →
 beste Teiler 61.0 (34.) 100.6 (37.) 107.2 (38.)
 Trefferlage 0.68 mm rechts, 0.14 mm tief
 Streuwert 1.49, horizontal: 1.88, vertikal: 0.97

Unterschrift des Schuetzen

Meyton Elektronik

Ergebnis: **386** (405.4)
 Serien: 98 96 94 98
 Zaehler: 27 12 1 0 0 0 0 0 0 0
 Innenzehner: 23
 weiteste: 520 (28), 400 (21), 378 (27)
 beste Teiler 40.1 (31.) 42.0 (22.) 60.2 (24.)
 Trefferlage 0.60 mm rechts, 0.38 mm hoch
 Streuwert 1.56, horizontal: 1.60, vertikal: 1.51

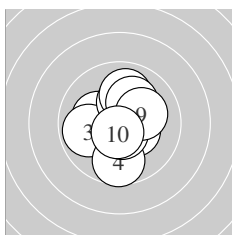
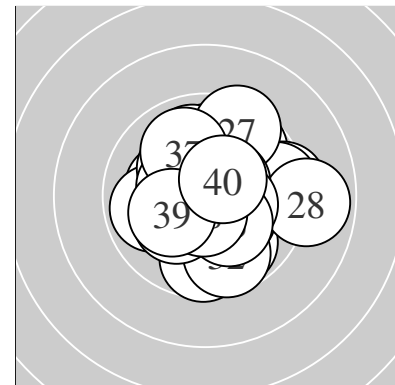

Serie 1:
 10.4 * 10.2 * 9.9 ← 9.7 ↓ 10.6 *
 10.2 * 10.0 ↑ 10.1 ↑ 10.1 → 10.6 *
 beste Teiler 80.0 (10.) 87.5 (5.) 139.5 (1.)
 Trefferlage 0.03 mm rechts, 0.11 mm hoch
 Streuwert 1.53, horizontal: 1.37, vertikal: 1.67

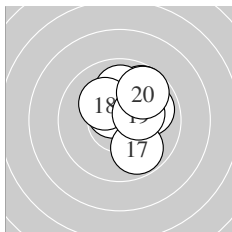

Serie 2:
 9.7 ↗ 10.2 * 10.0 ↑ 10.5 * 9.9 →
 10.6 * 9.8 ↘ 10.2 * 10.3 * 9.7 ↗
 beste Teiler 90.4 (16.) 113.5 (14.) 171.0 (19.)
 Trefferlage 0.93 mm rechts, 1.05 mm hoch
 Streuwert 1.32, horizontal: 1.19, vertikal: 1.44

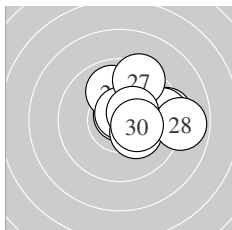

Serie 3:
 9.4 → 10.8 * 9.9 ↑ 10.7 * 9.5 →
 10.3 * 9.4 ↑ 8.9 → 10.4 * 10.3 *
 beste Teiler 42.0 (22.) 60.2 (24.) 127.6 (29.)
 Trefferlage 1.78 mm rechts, 0.67 mm hoch
 Streuwert 1.63, horizontal: 1.89, vertikal: 1.33

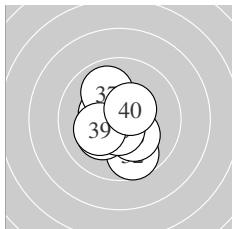

Serie 4:
 10.8 * 9.7 ↓ 10.2 * 10.4 * 10.2 *
 10.6 * 9.9 ↘ 10.6 * 10.2 * 10.5 *
 beste Teiler 40.1 (31.) 86.3 (38.) 91.4 (36.)
 Trefferlage 0.34 mm links, 0.30 mm tief
 Streuwert 1.29, horizontal: 1.09, vertikal: 1.46

Unterschrift des Schuetzen

Ergebnis:	389	(404.1)
Serien:	99	94 96 100
Zaehler:	29	11 0 0 0 0 0 0 0 0
Innenzehner:	23	
weiteste:	489 (14), 427 (30), 404 (29)	
beste Teiler	59.9 (1.) 61.8 (8.) 91.2 (32.)	
Trefferlage	0.06 mm links, 0.11 mm hoch	
Streuwert	1.68, horizontal: 1.95, vertikal: 1.35	

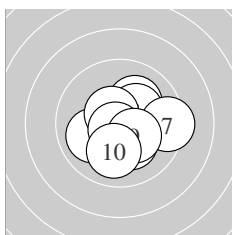
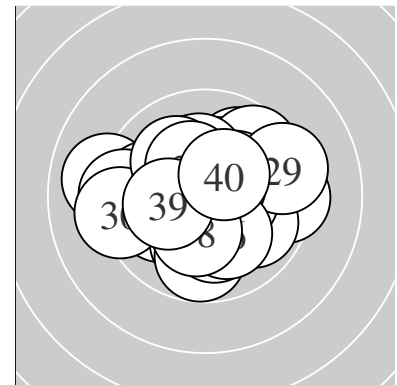

Serie 1:	10.7 *	10.0 ←	10.1 ↗	10.3 *	10.2 *
	10.5 *	9.4 →	10.7 *	10.3 *	10.0 ↓
beste Teiler	59.9 (1.) 61.8 (8.) 102.1 (6.)				
Trefferlage	0.50 mm rechts, 0.36 mm tief				
Streuwert	1.44, horizontal: 1.63, vertikal: 1.22				

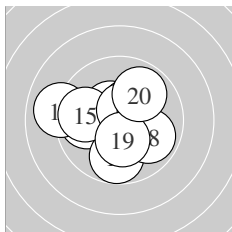

Serie 2:	9.9 ←	10.5 *	9.8 ↓	9.0 ←	9.8 ←
	10.4 *	10.6 *	9.9 ↘	10.3 *	9.9 ↗
beste Teiler	91.9 (17.) 123.8 (12.) 140.6 (16.)				
Trefferlage	0.59 mm links, 0.04 mm hoch				
Streuwert	1.91, horizontal: 2.22, vertikal: 1.54				

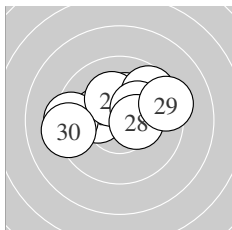

Serie 3:	10.2 *	10.3 *	10.2 *	9.4 ←	10.2 *
	9.7 ↗	10.3 *	10.4 *	9.3 →	9.2 ←
beste Teiler	138.8 (28.) 171.0 (22.) 175.2 (27.)				
Trefferlage	0.06 mm rechts, 0.80 mm hoch				
Streuwert	2.01, horizontal: 2.68, vertikal: 0.96				

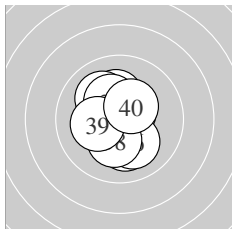

Serie 4:	10.2 *	10.6 *	10.1 ↘	10.1 ↓	10.3 *
	10.1 ↓	10.4 *	10.2 *	10.2 *	10.4 *
beste Teiler	91.2 (32.) 129.7 (37.) 140.9 (40.)				
Trefferlage	0.24 mm links, 0.03 mm tief				
Streuwert	1.30, horizontal: 1.01, vertikal: 1.53				

Unterschrift des Schuetzen

Meyton Elektronik

Ergebnis: **379** (397.5)
 Serien: 94 96 94 95
 Zaehler: 19 21 0 0 0 0 0 0 0 0
 Innenzehner: 12
 weiteste: 464 (10), 444 (15), 443 (28)
 beste Teiler 51.7 (31.) 80.8 (22.) 93.6 (8.)
 Trefferlage 0.32 mm links, 0.14 mm hoch
 Streuwert 1.95, horizontal: 1.88, vertikal: 2.01

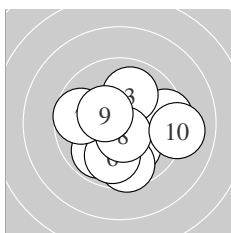
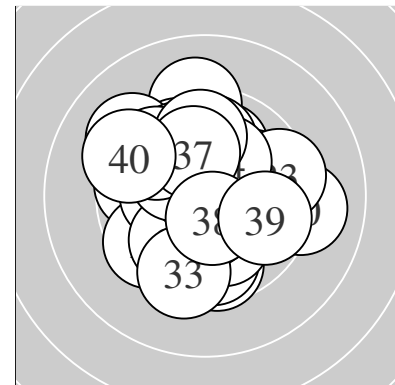

Serie 1:
 9.5 → 9.9 ↙ 10.0 ↑ 10.1 ↘ 9.6 ↓
 9.9 ↓ 9.7 ← 10.6 * 10.4 * 9.1 →
 beste Teiler 93.6 (8.) 139.5 (9.) 215.5 (4.)
 Trefferlage 0.45 mm rechts, 0.73 mm tief
 Streuwert 2.06, horizontal: 2.33, vertikal: 1.76

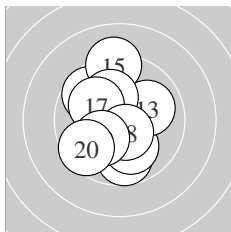

Serie 2:
 9.7 ↓ 10.0 ↘ 10.0 → 9.7 ↖ 9.2 ↑
 10.2 * 10.1 ↗ 10.5 * 10.1 ↙ 9.6 ↙
 beste Teiler 109.1 (18.) 197.7 (16.) 206.4 (19.)
 Trefferlage 0.56 mm links, 0.07 mm hoch
 Streuwert 2.02, horizontal: 1.57, vertikal: 2.38

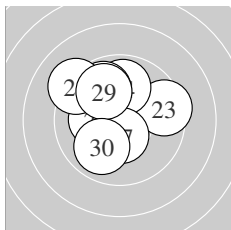

Serie 3:
 10.5 * 10.6 * 9.5 → 9.9 ↑ 10.2 *
 9.8 ↘ 10.5 * 9.2 ↖ 9.9 ↘ 9.9 ↙
 beste Teiler 80.8 (22.) 106.0 (21.) 124.4 (27.)
 Trefferlage 0.64 mm links, 0.62 mm hoch
 Streuwert 1.83, horizontal: 1.84, vertikal: 1.83

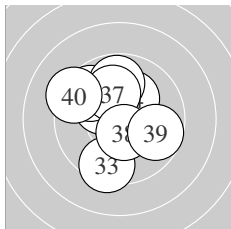

Serie 4:
 10.7 * 10.2 * 9.4 ↓ 10.2 * 9.7 ↖
 9.8 ↑ 10.1 ↑ 10.5 * 9.7 → 9.3 ↖
 beste Teiler 51.7 (31.) 113.5 (38.) 177.0 (32.)
 Trefferlage 0.54 mm links, 0.61 mm hoch
 Streuwert 1.90, horizontal: 1.80, vertikal: 2.01

Unterschrift des Schuetzen

Meyton Elektronik

Ergebnis: **370** (389.8)
 Serien: 92 92 94 92
 Zaehler: 13 24 3 0 0 0 0 0 0 0
 Innenzehner: 7
 weiteste: 578 (34), 547 (14), 512 (40)
 beste Teiler 102.5 (24.) 105.7 (31.) 112.1 (3.)
 Trefferlage 0.86 mm rechts, 0.13 mm hoch
 Streuwert 2.26, horizontal: 2.57, vertikal: 1.90

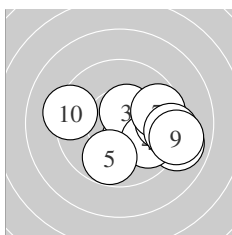
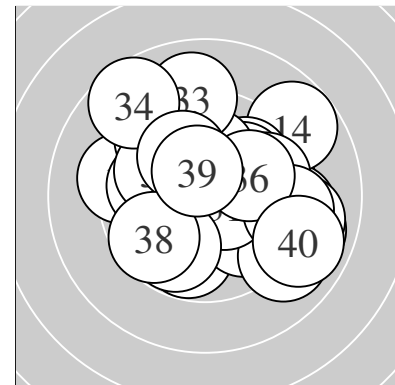

Serie 1:
 9.0 → 10.4 * 10.5 * 9.9 ↘ 9.8 ↙
 9.5 → 9.6 → 9.2 → 9.0 → 9.3 ←
 beste Teiler 112.1 (3.) 148.1 (2.) 275.2 (4.)
 Trefferlage 1.91 mm rechts, 0.60 mm tief
 Streuwert 2.19, horizontal: 2.82, vertikal: 1.29

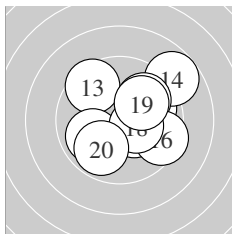

Serie 2:
 9.9 → 10.4 * 9.5 ↘ 8.8 ↗ 9.9 ↗
 9.5 ↘ 9.9 ← 10.4 * 10.0 ↗ 9.9 ↙
 beste Teiler 144.8 (18.) 147.8 (12.) 229.4 (19.)
 Trefferlage 1.05 mm rechts, 0.38 mm hoch
 Streuwert 2.12, horizontal: 2.30, vertikal: 1.93

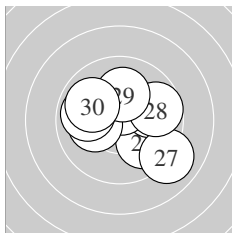

Serie 3:
 9.9 ↘ 10.1 ← 9.9 → 10.5 * 10.1 ←
 9.9 ← 9.0 ↘ 9.7 → 10.1 ↑ 9.9 ↘
 beste Teiler 102.5 (24.) 204.3 (25.) 211.4 (29.)
 Trefferlage 0.27 mm rechts, 0.19 mm hoch
 Streuwert 2.03, horizontal: 2.45, vertikal: 1.51

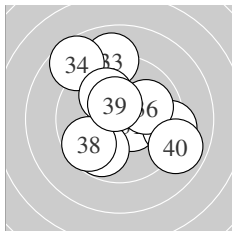

Serie 4:
 10.5 * 9.3 → 9.0 ↑ 8.6 ↘ 9.8 ↙
 10.0 → 10.1 ↘ 9.7 ↙ 10.4 * 8.9 ↘
 beste Teiler 105.7 (31.) 129.0 (39.) 225.2 (37.)
 Trefferlage 0.22 mm rechts, 0.57 mm hoch
 Streuwert 2.69, horizontal: 2.71, vertikal: 2.66

Unterschrift des Schuetzen

Meyton Elektronik

Ergebnis:	366	(386.9)
Serien:	95 90 94 87	
Zaehler:	13 20 7 0 0 0 0 0 0 0	
Innenzehner:	12	
weiteste:	734 (33), 603 (16), 590 (37)	
beste Teiler	72.9 (19.) 92.2 (8.) 96.9 (28.)	
Trefferlage	1.16 mm links, 0.00 mm	
Streuwert	2.48, horizontal: 2.73, vertikal: 2.20	

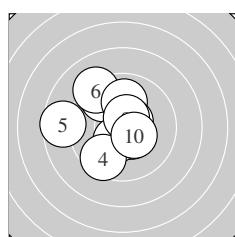
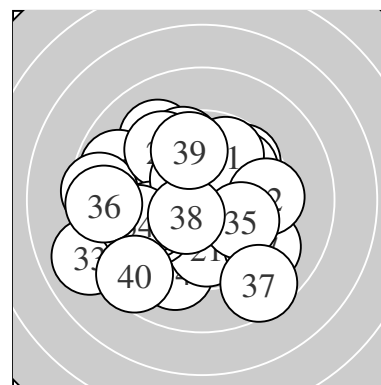

Serie 1:	9.6 ↘	10.5 *	10.4 *	9.6 ✓	8.6 ←
	9.2 ↘	10.0 ↑	10.6 *	10.6 *	10.4 *
beste Teiler	92.2 (8.) 99.1 (9.) 122.3 (2.)				
Trefferlage	0.95 mm links, 0.47 mm hoch				
Streuwert	2.10, horizontal: 2.15, vertikal: 2.04				

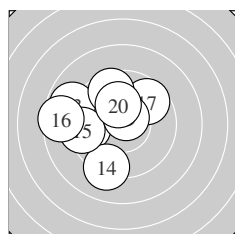

Serie 2:	9.3 ←	9.6 ←	8.9 ↖	9.2 ↓	9.4 ←
	8.5 ←	9.7 ↗	9.6 ↘	10.7 *	10.2 *
beste Teiler	72.9 (19.) 193.8 (20.) 321.2 (17.)				
Trefferlage	2.27 mm links, 0.56 mm hoch				
Streuwert	2.35, horizontal: 2.62, vertikal: 2.05				

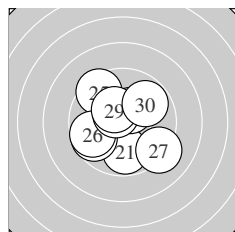

Serie 3:	9.8 ↓	10.5 *	10.4 *	9.7 ✓	9.5 ↘
	9.7 ←	9.2 ↘	10.6 *	10.4 *	9.8 ↗
beste Teiler	96.9 (28.) 118.0 (22.) 133.1 (23.)				
Trefferlage	0.32 mm links, 0.05 mm hoch				
Streuwert	2.04, horizontal: 2.10, vertikal: 1.98				

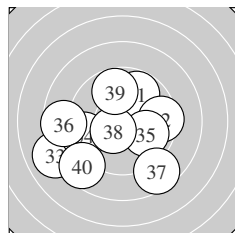

Serie 4:	9.8 ↗	9.5 →	8.0 ✓	9.4 ✓	9.9 ↘
	8.7 ←	8.6 ↘	10.4 *	9.8 ↑	8.6 ✓
beste Teiler	129.4 (38.) 257.2 (35.) 294.7 (31.)				
Trefferlage	1.09 mm links, 1.05 mm tief				
Streuwert	3.24, horizontal: 3.76, vertikal: 2.62				

Unterschrift des Schuetzen

Meyton Elektronik

Ergebnis: **381** (398.8)
 Serien: 94 97 96 94
 Zaehler: 23 15 2 0 0 0 0 0 0 0
 Innenzehner: 16
 weiteste: 568 (34), 526 (9), 455 (28)
 beste Teiler 56.3 (30.) 62.2 (16.) 65.7 (4.)
 Trefferlage 0.04 mm links, 0.03 mm tief
 Streuwert 2.00, horizontal: 2.27, vertikal: 1.68

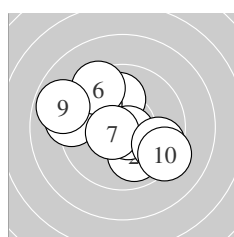
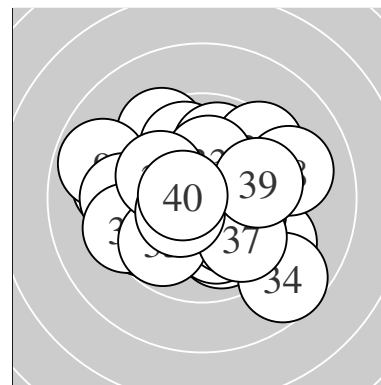

Serie 1:
 10.6 * 10.0 ↘ 10.0 ↑ 10.7 * 9.2 ←
 9.4 ↖ 10.6 * 9.6 → 8.8 ↙ 9.3 ↘
 beste Teiler 65.7 (4.) 87.2 (1.) 96.6 (7.)
 Trefferlage 0.54 mm links, 0.10 mm hoch
 Streuwert 2.36, horizontal: 2.75, vertikal: 1.89

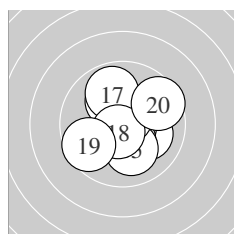

Serie 2:
 10.1 ↖ 10.1 → 10.7 * 10.4 * 10.1 ↘
 10.7 * 9.9 ↖ 10.7 * 9.6 ↙ 9.6 →
 beste Teiler 62.2 (16.) 67.1 (13.) 74.4 (18.)
 Trefferlage 0.20 mm rechts, 0.01 mm tief
 Streuwert 1.62, horizontal: 1.61, vertikal: 1.63

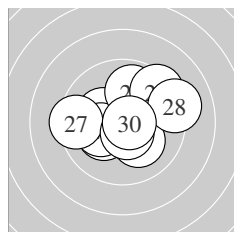

Serie 3:
 10.2 * 10.2 * 10.2 * 9.9 ↑ 10.1 ↘
 9.4 ↗ 9.4 ← 9.1 → 10.6 * 10.7 *
 beste Teiler 56.3 (30.) 96.7 (29.) 176.6 (22.)
 Trefferlage 0.13 mm rechts, 0.30 mm hoch
 Streuwert 2.00, horizontal: 2.43, vertikal: 1.45

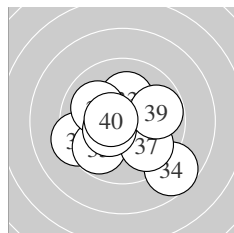

Serie 4:
 9.3 ← 10.3 * 10.2 * 8.7 ↘ 9.8 ↙
 10.0 ↖ 9.8 ↘ 10.4 * 9.8 → 10.6 *
 beste Teiler 97.7 (40.) 130.9 (38.) 152.5 (32.)
 Trefferlage 0.01 mm rechts, 0.52 mm tief
 Streuwert 2.17, horizontal: 2.44, vertikal: 1.87

Unterschrift des Schuetzen

Meyton Elektronik

Ergebnis:	383	(400.5)
Serien:	96	96 96 95
Zaehler:	24	15 1 0 0 0 0 0 0 0
Innenzehner:	17	
weiteste:	672	(37), 478 (40), 462 (19)
beste Teiler	13.3	(25.) 25.4 (18.) 51.0 (10.)
Trefferlage	1.03	mm rechts, 0.24 mm hoch
Streuwert	1.82,	horizontal: 1.97, vertikal: 1.66

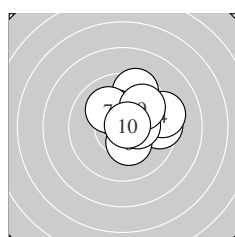
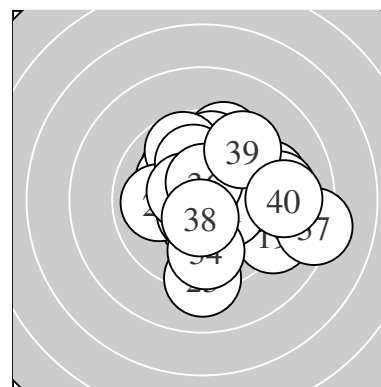

Serie 1:	9.5 →	10.0 ↗	9.5 ↗	9.3 →	10.3 *
	10.3 *	10.1 ↘	10.4 *	9.9 ↗	10.7 *
beste Teiler	51.0	(10.) 144.6	(8.) 153.9	(5.)	
Trefferlage	1.22	mm rechts,	1.09	mm hoch	
Streuwert	1.52,	horizontal: 1.65,	vertikal: 1.39		

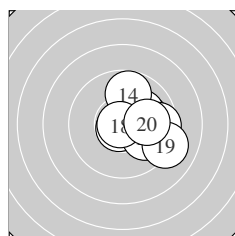

Serie 2:	10.3 *	10.0 →	10.1 ↗	9.8 ↑	9.6 →
	10.7 *	9.9 ↘	10.9 *	9.1 ↘	10.0 →
beste Teiler	25.4	(18.) 55.3	(16.) 152.0	(11.)	
Trefferlage	1.70	mm rechts,	0.21	mm hoch	
Streuwert	1.44,	horizontal: 1.50,	vertikal: 1.39		

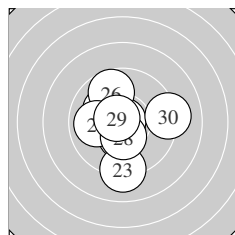

Serie 3:	10.1 ↘	10.4 *	9.1 ↓	10.7 *	10.9 *
	9.7 ↘	9.9 ←	10.4 *	10.7 *	9.2 →
beste Teiler	13.3	(25.) 67.1	(29.) 71.4	(24.)	
Trefferlage	0.14	mm links,	0.30	mm tief	
Streuwert	1.89,	horizontal: 1.82,	vertikal: 1.96		

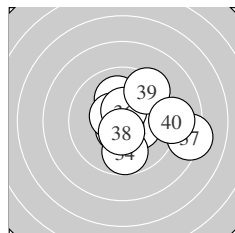

Serie 4:	10.3 *	10.6 *	10.1 ↑	9.8 ↓	10.5 *
	10.5 *	8.3 →	10.5 *	9.4 ↗	9.0 →
beste Teiler	86.7	(32.) 103.6	(36.) 105.5	(38.)	
Trefferlage	1.35	mm rechts,	0.01	mm tief	
Streuwert	2.16,	horizontal: 2.51,	vertikal: 1.75		

Unterschrift des Schuetzen

Meyton Elektronik

Ergebnis: **394** (410.9)
 Serien: 97 100 98 99
 Zaehler: 34 6 0 0 0 0 0 0 0 0
 Innenzehner: 26
 weiteste: 365 (29), 309 (7), 297 (32)
 beste Teiler 13.3 (40.) 33.5 (36.) 48.5 (37.)
 Trefferlage 0.02 mm rechts, 0.13 mm hoch
 Streuwert 1.32, horizontal: 1.45, vertikal: 1.18

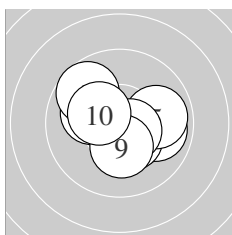
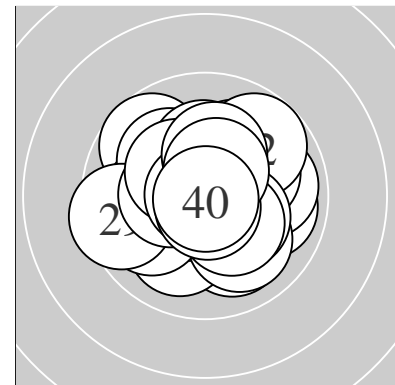

Serie 1:
 10.4 * 10.7 * 9.9 → 10.4 * 9.9 →
 10.1 ↖ 9.7 ↖ 10.6 * 10.3 * 10.3 *
 beste Teiler 58.1 (2.) 91.2 (8.) 138.0 (4.)
 Trefferlage 0.23 mm rechts, 0.11 mm tief
 Streuwert 1.44, horizontal: 1.71, vertikal: 1.10

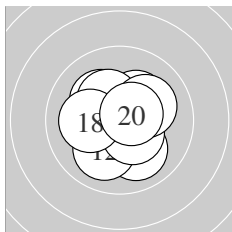

Serie 2:
 10.0 ↘ 10.0 ↘ 10.3 * 10.2 * 10.6 *
 10.3 * 10.4 * 10.1 ← 10.1 → 10.6 *
 beste Teiler 94.8 (20.) 99.3 (15.) 130.1 (17.)
 Trefferlage 0.03 mm rechts, 0.13 mm hoch
 Streuwert 1.33, horizontal: 1.31, vertikal: 1.35

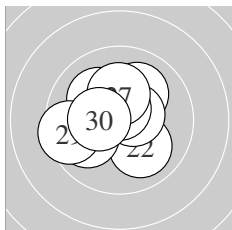

Serie 3:
 10.3 * 10.0 ↘ 10.1 ↖ 10.1 ↗ 10.5 *
 10.6 * 10.2 * 9.9 ↙ 9.5 ← 10.4 *
 beste Teiler 81.0 (26.) 104.1 (25.) 145.1 (30.)
 Trefferlage 0.68 mm links, 0.26 mm hoch
 Streuwert 1.48, horizontal: 1.66, vertikal: 1.27

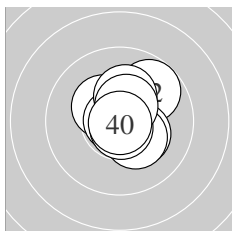

Serie 4:
 10.3 * 9.8 ↗ 10.5 * 10.3 * 10.3 *
 10.8 * 10.8 * 10.2 * 10.5 * 10.9 *
 beste Teiler 13.3 (40.) 33.5 (36.) 48.5 (37.)
 Trefferlage 0.49 mm rechts, 0.26 mm hoch
 Streuwert 1.04, horizontal: 0.92, vertikal: 1.15

Unterschrift des Schuetzen

Ergebnis: **386** (404.1)
 Serien: 97 96 96 97
 Zaehler: 26 14 0 0 0 0 0 0 0 0
 Innenzehner: 24
 weiteste: 454 (26), 418 (30), 408 (12)
 beste Teiler 46.3 (13.) 78.3 (27.) 83.7 (34.)
 Trefferlage 0.16 mm links, 0.36 mm tief
 Streuwert 1.68, horizontal: 1.66, vertikal: 1.71

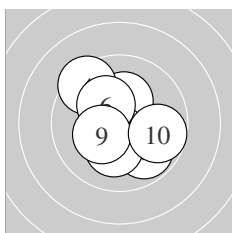
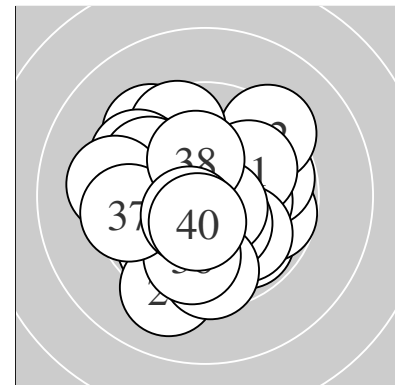

Serie 1:
 10.4 * 10.3 * 10.5 * 9.4 ↘ 10.6 *
 10.3 * 9.8 ↘ 10.2 * 10.3 * 9.7 →
 beste Teiler 85.5 (5.) 117.8 (3.) 128.1 (1.)
 Trefferlage 0.09 mm links, 0.04 mm tief
 Streuwert 1.63, horizontal: 1.56, vertikal: 1.69

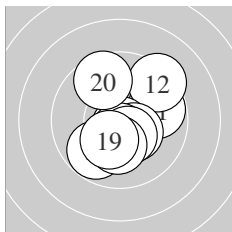

Serie 2:
 9.8 → 9.3 ↗ 10.8 * 10.4 * 9.8 ↖
 10.6 * 10.4 * 10.2 * 10.3 * 9.6 ↘
 beste Teiler 46.3 (13.) 93.0 (16.) 134.2 (17.)
 Trefferlage 0.35 mm rechts, 0.24 mm tief
 Streuwert 1.74, horizontal: 1.57, vertikal: 1.89

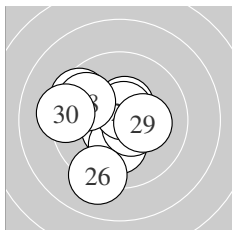

Serie 3:
 10.5 * 9.5 ↖ 10.6 * 10.2 * 10.5 *
 9.1 ↓ 10.6 * 9.8 ↖ 10.2 * 9.3 ←
 beste Teiler 78.3 (27.) 96.2 (23.) 102.7 (25.)
 Trefferlage 0.89 mm links, 0.20 mm tief
 Streuwert 1.85, horizontal: 1.91, vertikal: 1.79

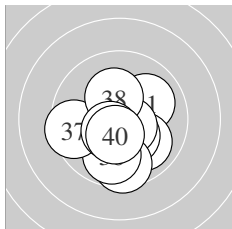

Serie 4:
 10.0 ↗ 10.0 ↘ 10.3 * 10.6 * 9.6 ↓
 9.8 ↓ 9.5 ← 10.3 * 10.5 * 10.5 *
 beste Teiler 83.7 (34.) 114.4 (39.) 125.0 (40.)
 Trefferlage 0.00 mm , 0.96 mm tief
 Streuwert 1.56, horizontal: 1.56, vertikal: 1.57

Unterschrift des Schuetzen

Meyton Elektronik

Ergebnis: **391** (413.3)
 Serien: 97 98 97 99
 Zaehler: 31 9 0 0 0 0 0 0 0 0
 Innenzehner: 28
 weiteste: 369 (19), 342 (29), 332 (11)
 beste Teiler 9.0 (8.) 12.3 (13.) 19.1 (16.)
 Trefferlage 0.26 mm links, 0.30 mm hoch
 Streuwert 1.29, horizontal: 1.47, vertikal: 1.08

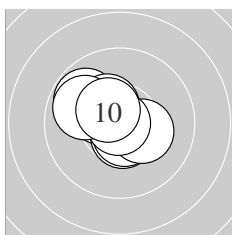
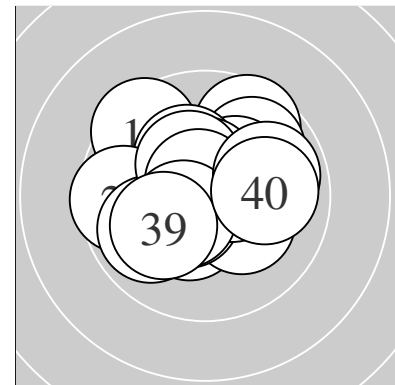

Serie 1:
 10.4 * 10.6 * 9.9 ↘ 9.8 ↘ 10.4 *
 10.6 * 10.3 * 10.9 * 9.9 ↘ 10.5 *
 beste Teiler 9.0 (8.) 84.5 (6.) 93.6 (2.)
 Trefferlage 0.79 mm links, 0.47 mm hoch
 Streuwert 1.15, horizontal: 1.32, vertikal: 0.94

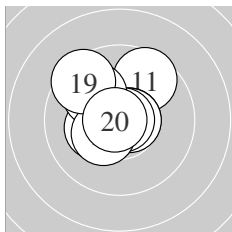

Serie 2:
 9.6 ↗ 10.3 * 10.9 * 10.7 * 10.7 *
 10.9 * 10.0 ↘ 10.4 * 9.5 ↘ 10.8 *
 beste Teiler 12.3 (13.) 19.1 (16.) 34.0 (20.)
 Trefferlage 0.39 mm links, 0.58 mm hoch
 Streuwert 1.33, horizontal: 1.33, vertikal: 1.34

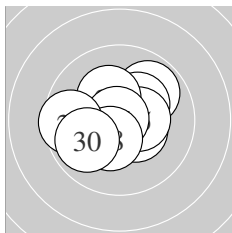

Serie 3:
 10.8 * 9.9 ↗ 10.3 * 10.4 * 10.4 *
 10.3 * 10.9 * 10.4 * 9.6 ← 9.9 ↙
 beste Teiler 22.3 (27.) 42.7 (21.) 131.1 (25.)
 Trefferlage 0.20 mm links, 0.11 mm hoch
 Streuwert 1.44, horizontal: 1.70, vertikal: 1.12

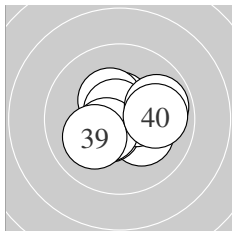

Serie 4:
 10.5 * 10.2 * 10.5 * 10.5 * 10.4 *
 10.7 * 10.5 * 9.9 → 10.1 ↙ 10.0 →
 beste Teiler 61.7 (36.) 105.0 (31.) 108.1 (33.)
 Trefferlage 0.33 mm rechts, 0.05 mm hoch
 Streuwert 1.25, horizontal: 1.50, vertikal: 0.93

Unterschrift des Schuetzen

Meyton Elektronik

Ergebnis: **383** (399.4)
 Serien: 95 96 98 94
 Zaehler: 23 17 0 0 0 0 0 0 0 0
 Innenzehner: 18
 weiteste: 497 (34), 482 (35), 482 (40)
 beste Teiler 14.7 (10.) 37.4 (37.) 46.6 (21.)
 Trefferlage 0.17 mm links, 0.35 mm hoch
 Streuwert 1.94, horizontal: 2.39, vertikal: 1.35

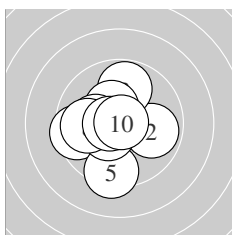
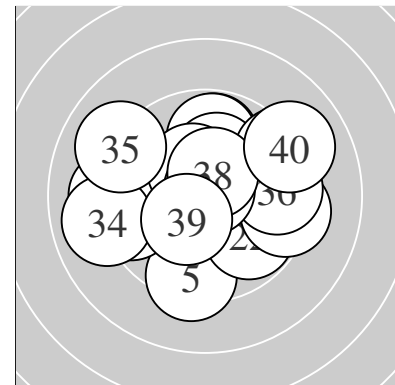

Serie 1:
 9.5 ← 9.9 → 9.8 ↑ 10.4 * 9.4 ↓
 10.2 * 10.5 * 9.9 ← 10.6 * 10.9 *
 beste Teiler 14.7 (10.) 81.0 (9.) 125.3 (7.)
 Trefferlage 0.80 mm links, 0.21 mm tief
 Streuwert 1.71, horizontal: 1.70, vertikal: 1.71

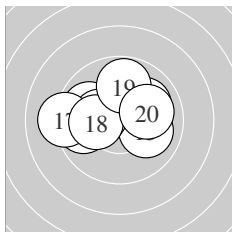

Serie 2:
 9.9 ↖ 10.0 ↗ 9.7 ← 10.2 * 10.0 →
 10.3 * 9.2 ← 10.2 * 9.8 ↑ 10.0 →
 beste Teiler 164.9 (16.) 182.4 (14.) 194.7 (18.)
 Trefferlage 0.49 mm links, 0.43 mm hoch
 Streuwert 1.92, horizontal: 2.50, vertikal: 1.06

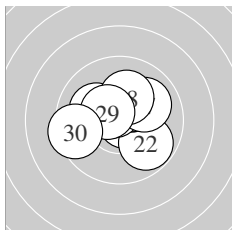

Serie 3:
 10.8 * 9.8 ↘ 10.1 ↖ 10.3 * 10.2 *
 10.6 * 10.0 ↗ 10.2 * 10.5 * 9.4 ←
 beste Teiler 46.6 (21.) 91.3 (26.) 119.8 (29.)
 Trefferlage 0.05 mm rechts, 0.51 mm hoch
 Streuwert 1.53, horizontal: 1.83, vertikal: 1.15

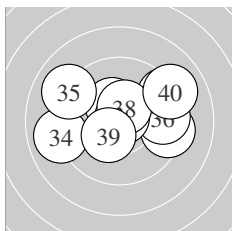

Serie 4:
 9.2 ↗ 10.4 * 9.3 → 9.0 ← 9.0 ↖
 9.5 → 10.8 * 10.5 * 10.4 * 9.0 →
 beste Teiler 37.4 (37.) 119.5 (38.) 146.7 (32.)
 Trefferlage 0.54 mm rechts, 0.69 mm hoch
 Streuwert 2.55, horizontal: 3.31, vertikal: 1.42

Unterschrift des Schuetzen

Meyton Elektronik

Ergebnis: **387** (407.0)
 Serien: 96 96 97 98
 Zaehler: 29 9 2 0 0 0 0 0 0 0
 Innenzehner: 27
 weiteste: 550 (29), 501 (17), 483 (10)
 beste Teiler 23.7 (26.) 38.8 (30.) 41.3 (16.)
 Trefferlage 0.08 mm links, 0.27 mm hoch
 Streuwert 1.69, horizontal: 2.06, vertikal: 1.21

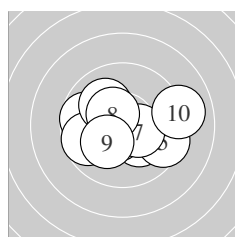
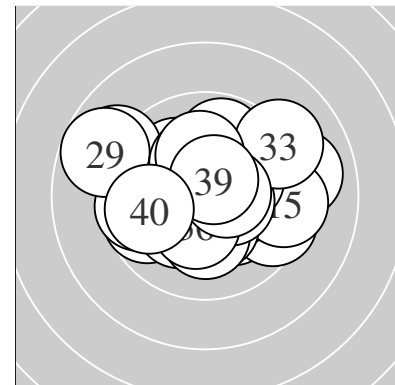

Serie 1:
 9.7 ← 9.7 ← 10.2 * 10.1 ↘ 9.5 →
 10.6 * 10.4 * 10.4 * 10.2 * 9.0 →
 beste Teiler 94.5 (6.) 126.1 (8.) 139.7 (7.)
 Trefferlage 0.08 mm rechts, 0.20 mm tief
 Streuwert 2.01, horizontal: 2.58, vertikal: 1.17

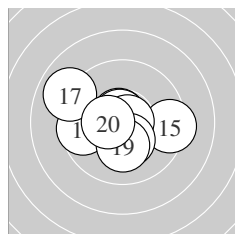

Serie 2:
 10.7 * 10.7 * 10.6 * 9.6 ← 9.4 →
 10.8 * 8.9 ↘ 10.3 * 10.2 * 10.5 *
 beste Teiler 41.3 (16.) 57.6 (12.) 68.4 (11.)
 Trefferlage 0.54 mm links, 0.11 mm tief
 Streuwert 1.81, horizontal: 2.27, vertikal: 1.18

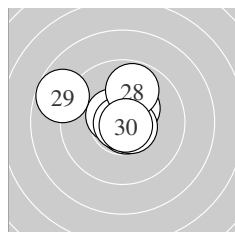

Serie 3:
 10.6 * 10.5 * 10.7 * 10.5 * 10.4 *
 10.9 * 10.6 * 9.8 ↑ 8.8 ↙ 10.8 *
 beste Teiler 23.7 (26.) 38.8 (30.) 53.2 (23.)
 Trefferlage 0.27 mm links, 0.73 mm hoch
 Streuwert 1.46, horizontal: 1.76, vertikal: 1.09

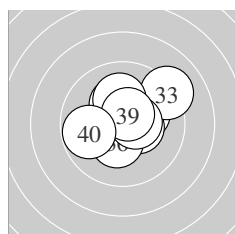

Serie 4:
 10.2 * 10.4 * 9.1 ↗ 10.3 * 10.6 *
 10.3 * 10.1 ↑ 10.5 * 10.6 * 9.8 ←
 beste Teiler 90.5 (35.) 93.0 (39.) 109.8 (38.)
 Trefferlage 0.40 mm rechts, 0.66 mm hoch
 Streuwert 1.51, horizontal: 1.73, vertikal: 1.26

Unterschrift des Schuetzen

Meyton Elektronik

Ergebnis: **373** (394.7)
 Serien: 94 93 94 92
 Zaehler: 19 15 6 0 0 0 0 0 0 0
 Innenzehner: 16
 weiteste: 620 (38), 607 (10), 583 (21)
 beste Teiler 62.2 (27.) 81.4 (4.) 88.2 (7.)
 Trefferlage 0.45 mm rechts, 0.24 mm hoch
 Streuwert 2.23, horizontal: 2.73, vertikal: 1.59

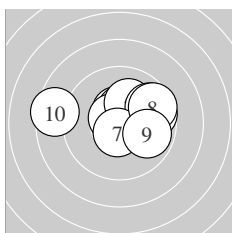
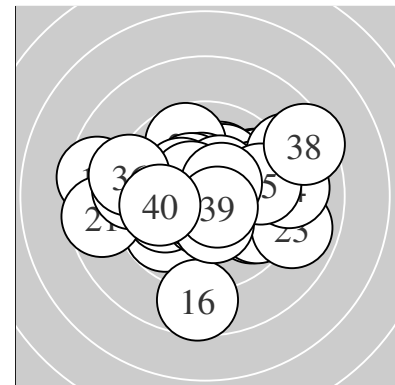

Serie 1:
 10.5 * 9.7 → 10.5 * 10.6 * 10.1 ↗
 9.7 ↗ 10.6 * 9.6 ↗ 9.9 → 8.5 ←
 beste Teiler 81.4 (4.) 88.2 (7.) 117.6 (1.)
 Trefferlage 0.52 mm rechts, 0.77 mm hoch
 Streuwert 2.05, horizontal: 2.73, vertikal: 0.97

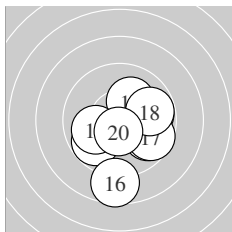

Serie 2:
 9.8 ↘ 10.4 * 10.1 ↗ 9.8 → 9.8 ↗
 8.6 ↓ 9.7 ↘ 9.8 → 10.0 ← 10.5 *
 beste Teiler 105.5 (20.) 138.7 (12.) 201.6 (13.)
 Trefferlage 0.83 mm rechts, 0.89 mm tief
 Streuwert 2.06, horizontal: 2.00, vertikal: 2.11

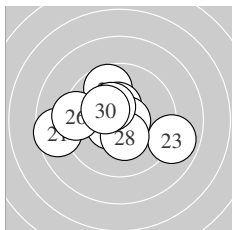

Serie 3:
 8.6 ← 9.7 ↖ 8.9 ↘ 10.6 * 10.4 *
 9.3 ← 10.7 * 10.3 * 10.4 * 10.3 *
 beste Teiler 62.2 (27.) 98.0 (24.) 127.4 (25.)
 Trefferlage 0.80 mm links, 0.18 mm hoch
 Streuwert 2.23, horizontal: 2.80, vertikal: 1.46

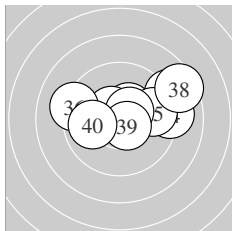

Serie 4:
 10.4 * 10.5 * 8.9 ↗ 9.1 → 9.7 →
 9.2 ← 10.5 * 8.5 ↗ 10.6 * 9.9 ←
 beste Teiler 92.0 (39.) 109.6 (32.) 114.8 (37.)
 Trefferlage 1.27 mm rechts, 0.89 mm hoch
 Streuwert 2.39, horizontal: 3.21, vertikal: 1.09

Unterschrift des Schuetzen

Meyton Elektronik

Ergebnis: **376** (393.3)
 Serien: 96 95 95 90
 Zaehler: 21 14 5 0 0 0 0 0 0 0
 Innenzehner: 14
 weiteste: 645 (34), 619 (24), 604 (19)
 beste Teiler 41.1 (29.) 62.3 (6.) 85.4 (20.)
 Trefferlage 0.50 mm rechts, 0.01 mm hoch
 Streuwert 2.27, horizontal: 2.46, vertikal: 2.05

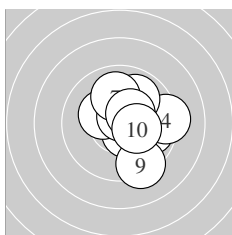
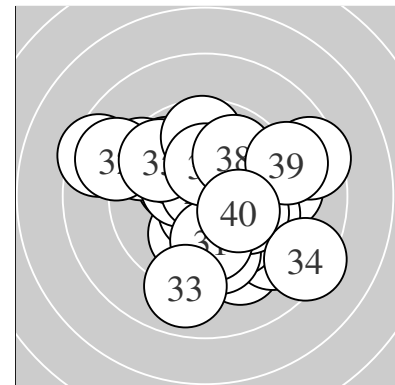

Serie 1:
 9.8 → 10.5 * 10.3 * 9.3 → 9.9 ↗
 10.7 * 10.0 ↑ 10.4 * 9.3 ↓ 10.3 *
 beste Teiler 62.3 (6.) 109.2 (2.) 131.0 (8.)
 Trefferlage 1.16 mm rechts, 0.15 mm hoch
 Streuwert 1.67, horizontal: 1.60, vertikal: 1.74

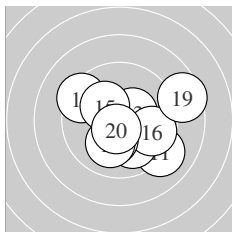

Serie 2:
 9.1 ↘ 9.4 ↖ 10.4 * 10.0 ↓ 10.2 *
 9.7 → 10.2 * 10.1 ↓ 8.5 → 10.6 *
 beste Teiler 85.4 (20.) 136.1 (13.) 185.3 (15.)
 Trefferlage 0.81 mm rechts, 0.46 mm tief
 Streuwert 2.30, horizontal: 2.70, vertikal: 1.83

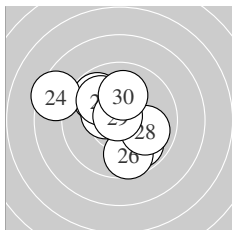

Serie 3:
 9.8 ↖ 9.9 ↘ 10.5 * 8.5 ↖ 10.4 *
 9.7 ↓ 10.0 ↖ 10.0 → 10.8 * 10.0 ↑
 beste Teiler 41.1 (29.) 105.3 (23.) 138.3 (25.)
 Trefferlage 0.49 mm links, 0.25 mm hoch
 Streuwert 2.13, horizontal: 2.35, vertikal: 1.89

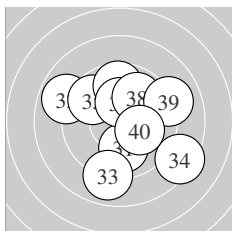

Serie 4:
 10.0 ↓ 8.9 ↖ 8.9 ↓ 8.4 ↘ 9.7 ↖
 9.7 ↑ 10.3 * 9.9 ↗ 9.0 → 10.2 *
 beste Teiler 170.0 (37.) 199.6 (40.) 244.5 (31.)
 Trefferlage 0.51 mm rechts, 0.11 mm hoch
 Streuwert 2.93, horizontal: 3.04, vertikal: 2.81

Unterschrift des Schuetzen

Ergebnis: **364** (382.9)
 Serien: 89 95 91 89
 Zaehler: 11 22 7 0 0 0 0 0 0 0
 Innenzehner: 8
 weiteste: 654 (25), 630 (3), 622 (6)
 beste Teiler 51.2 (22.) 62.0 (16.) 92.1 (17.)
 Trefferlage 0.13 mm rechts, 0.14 mm hoch
 Streuwert 2.71, horizontal: 2.91, vertikal: 2.51

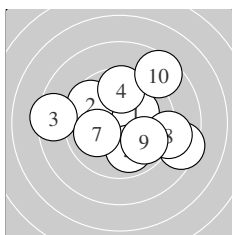
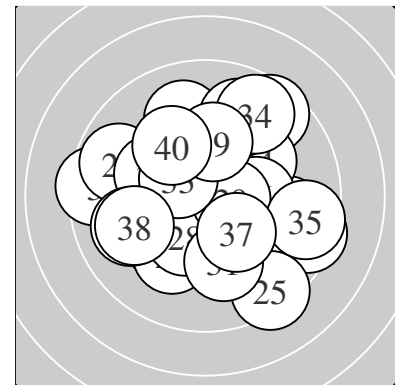

Serie 1:
 10.2 * 9.6 ↖ 8.4 ← 9.7 ↑ 9.9 ↓
 8.5 → 10.0 ← 9.0 → 9.8 ↘ 8.6 ↗
 beste Teiler 181.9 (1.) 232.4 (7.) 258.4 (5.)
 Trefferlage 0.79 mm rechts, 0.30 mm hoch
 Streuwert 3.11, horizontal: 3.70, vertikal: 2.38

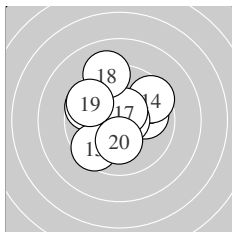

Serie 2:
 10.6 * 10.0 → 9.7 ↖ 9.5 ↗ 9.6 ↘
 10.7 * 10.6 * 9.1 ↑ 9.6 ↖ 10.2 *
 beste Teiler 62.0 (16.) 92.1 (17.) 95.9 (11.)
 Trefferlage 0.35 mm links, 0.67 mm hoch
 Streuwert 2.01, horizontal: 2.06, vertikal: 1.95

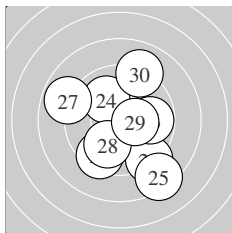

Serie 3:
 9.1 ↓ 10.7 * 9.4 ↙ 10.0 ↖ 8.3 ↓
 9.8 → 8.8 ↖ 9.9 ↙ 10.4 * 9.0 ↑
 beste Teiler 51.2 (22.) 149.0 (29.) 232.7 (24.)
 Trefferlage 0.37 mm rechts, 0.62 mm tief
 Streuwert 2.87, horizontal: 2.69, vertikal: 3.04

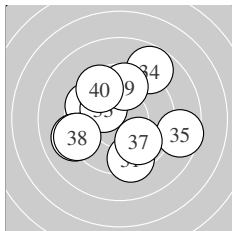

Serie 4:
 9.4 ↓ 9.7 ↖ 10.2 * 8.8 ↗ 8.6 →
 9.1 ← 9.9 ↓ 9.2 ← 9.7 ↑ 9.6 ↖
 beste Teiler 180.8 (33.) 274.4 (37.) 311.4 (39.)
 Trefferlage 0.27 mm links, 0.22 mm hoch
 Streuwert 2.99, horizontal: 3.23, vertikal: 2.74

Unterschrift des Schuetzen

Meyton Elektronik

Ergebnis: **394** (411.9)
 Serien: 99 98 99 98
 Zaehler: 34 6 0 0 0 0 0 0 0 0
 Innenzehner: 30
 weiteste: 334 (38), 330 (10), 321 (27)
 beste Teiler 43.0 (4.) 61.2 (15.) 64.0 (2.)
 Trefferlage 0.63 mm links, 0.57 mm hoch
 Streuwert 1.15, horizontal: 1.15, vertikal: 1.15

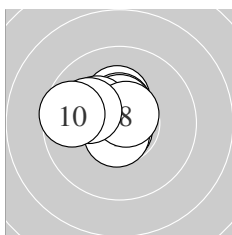
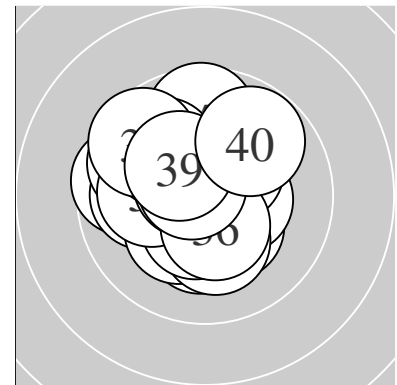

Serie 1:
 10.3 * 10.7 * 10.5 * 10.8 * 10.5 *
 10.2 * 10.6 * 10.7 * 10.0 ↖ 9.6 ↖
 beste Teiler 43.0 (4.) 64.0 (2.) 75.2 (8.)
 Trefferlage 0.72 mm links, 0.63 mm hoch
 Streuwert 0.98, horizontal: 1.18, vertikal: 0.73

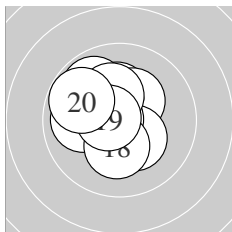

Serie 2:
 10.3 * 10.3 * 9.9 ↖ 10.3 * 10.7 *
 10.0 ↖ 10.3 * 10.2 * 10.6 * 9.8 ↖
 beste Teiler 61.2 (15.) 79.4 (19.) 157.5 (12.)
 Trefferlage 0.73 mm links, 0.54 mm hoch
 Streuwert 1.27, horizontal: 1.23, vertikal: 1.31

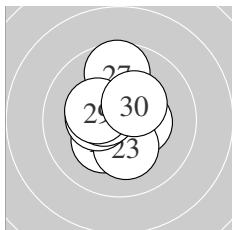

Serie 3:
 10.4 * 10.3 * 10.2 * 10.5 * 10.4 *
 10.4 * 9.7 ↑ 10.5 * 10.3 * 10.4 *
 beste Teiler 109.6 (24.) 116.4 (28.) 133.1 (26.)
 Trefferlage 0.41 mm links, 0.39 mm hoch
 Streuwert 1.22, horizontal: 1.02, vertikal: 1.39

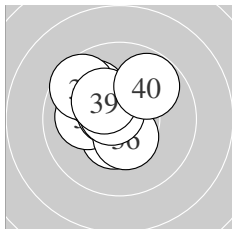

Serie 4:
 10.5 * 10.5 * 10.1 ↖ 10.6 * 10.0 ↖
 10.4 * 10.7 * 9.6 ↖ 10.3 * 9.8 ↗
 beste Teiler 70.9 (37.) 87.8 (34.) 106.4 (31.)
 Trefferlage 0.69 mm links, 0.72 mm hoch
 Streuwert 1.26, horizontal: 1.29, vertikal: 1.23

Unterschrift des Schuetzen

Ergebnis: **384** (403.9)
 Serien: 96 96 96 96
 Zaehler: 25 14 1 0 0 0 0 0 0 0
 Innenzehner: 22
 weiteste: 690 (13), 443 (25), 423 (34)
 beste Teiler 52.5 (39.) 53.7 (18.) 59.6 (32.)
 Trefferlage 0.04 mm rechts, 0.80 mm tief
 Streuwert 1.68, horizontal: 2.04, vertikal: 1.23

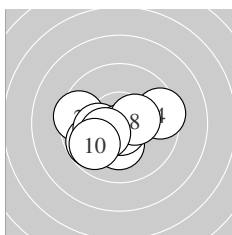
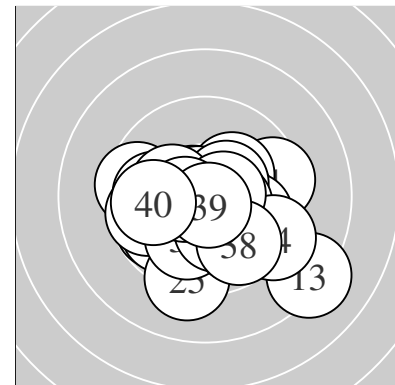

Serie 1:
 10.2 * 9.5 ← 9.8 ↙ 9.5 → 10.2 *
 10.2 * 10.7 * 10.4 * 10.3 * 9.8 ↙
 beste Teiler 59.8 (7.) 137.5 (8.) 155.3 (9.)
 Trefferlage 0.80 mm links, 0.65 mm tief
 Streuwert 1.64, horizontal: 2.10, vertikal: 0.98

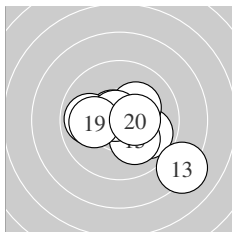

Serie 2:
 9.9 ↘ 10.5 * 8.2 ↘ 10.7 * 10.1 ↘
 10.2 * 9.9 ← 10.7 * 10.1 ← 10.4 *
 beste Teiler 53.7 (18.) 73.4 (14.) 121.1 (12.)
 Trefferlage 0.74 mm rechts, 0.52 mm tief
 Streuwert 1.98, horizontal: 2.36, vertikal: 1.51

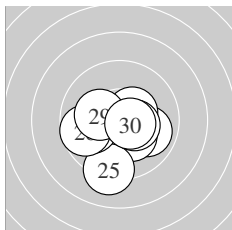

Serie 3:
 10.6 * 9.9 ↘ 10.3 * 10.4 * 9.2 ↓
 10.4 * 9.9 ← 9.7 ← 10.2 * 10.6 *
 beste Teiler 81.1 (21.) 98.9 (30.) 129.6 (24.)
 Trefferlage 0.21 mm links, 0.79 mm tief
 Streuwert 1.62, horizontal: 1.82, vertikal: 1.40

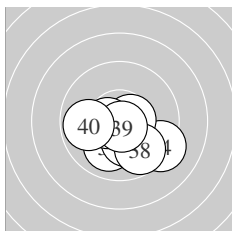

Serie 4:
 10.0 ↓ 10.7 * 9.8 ↘ 9.3 ↘ 10.6 *
 10.2 * 10.5 * 9.7 ↘ 10.7 * 9.9 ←
 beste Teiler 52.5 (39.) 59.6 (32.) 96.5 (35.)
 Trefferlage 0.44 mm rechts, 1.23 mm tief
 Streuwert 1.45, horizontal: 1.76, vertikal: 1.04

Unterschrift des Schuetzen

Meyton Elektronik

Ergebnis: **375** (392.6)
 Serien: 92 95 94 94
 Zaehler: 18 19 3 0 0 0 0 0 0 0
 Innenzehner: 12
 weiteste: 741 (32), 591 (8), 506 (10)
 beste Teiler 57.7 (26.) 63.8 (7.) 64.1 (29.)
 Trefferlage 0.28 mm links, 0.23 mm hoch
 Streuwert 2.30, horizontal: 2.94, vertikal: 1.39

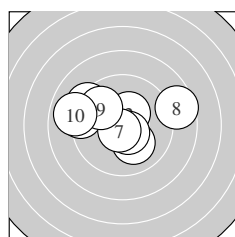
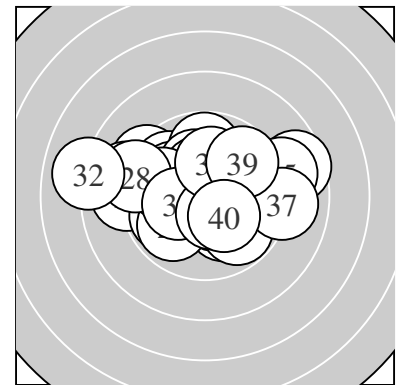

Serie 1:
 9.1 ↖ 10.4 * 9.3 ↘ 9.2 ↖ 10.1 ↘
 10.6 * 10.7 * 8.6 → 9.8 ↘ 8.9 ↖
 beste Teiler 63.8 (7.) 96.8 (6.) 138.6 (2.)
 Trefferlage 1.19 mm links, 0.72 mm hoch
 Streuwert 2.54, horizontal: 3.33, vertikal: 1.32

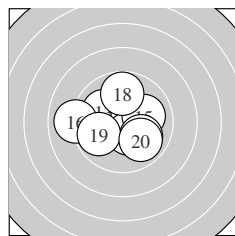

Serie 2:
 9.9 ↙ 10.2 * 10.0 ↘ 10.4 * 10.0 →
 9.0 ← 10.0 ↘ 9.8 ↑ 9.8 ↙ 9.9 ↘
 beste Teiler 133.7 (14.) 194.9 (12.) 227.2 (13.)
 Trefferlage 0.71 mm links, 0.26 mm tief
 Streuwert 1.98, horizontal: 2.37, vertikal: 1.48

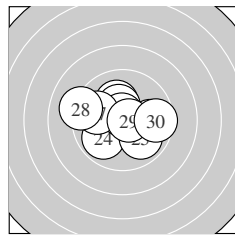

Serie 3:
 10.2 * 9.8 → 10.3 * 9.9 ↙ 9.9 ↘
 10.7 * 9.9 ↖ 9.2 ↖ 10.7 * 9.6 →
 beste Teiler 57.7 (26.) 64.1 (29.) 151.3 (23.)
 Trefferlage 0.12 mm links, 0.21 mm hoch
 Streuwert 1.95, horizontal: 2.46, vertikal: 1.26

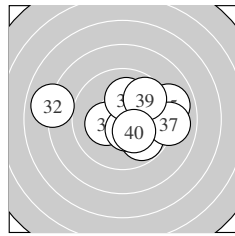

Serie 4:
 10.3 * 8.0 ↖ 9.8 ↘ 10.5 * 9.0 →
 10.0 ↗ 9.0 → 10.1 ↑ 9.7 ↗ 10.3 *
 beste Teiler 117.1 (34.) 171.8 (40.) 175.0 (31.)
 Trefferlage 0.89 mm rechts, 0.26 mm hoch
 Streuwert 2.68, horizontal: 3.47, vertikal: 1.51

Unterschrift des Schuetzen

Meyton Elektronik

Ergebnis: **379** (394.1)
 Serien: 93 95 95 96
 Zaehler: 19 21 0 0 0 0 0 0 0 0
 Innenzehner: 13
 weiteste: 491 (30), 464 (32), 458 (4)
 beste Teiler 25.0 (11.) 36.2 (15.) 92.8 (6.)
 Trefferlage 0.55 mm rechts, 0.83 mm hoch
 Streuwert 2.01, horizontal: 2.30, vertikal: 1.66

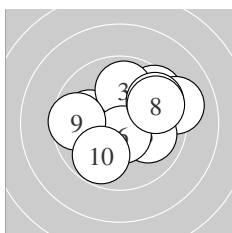
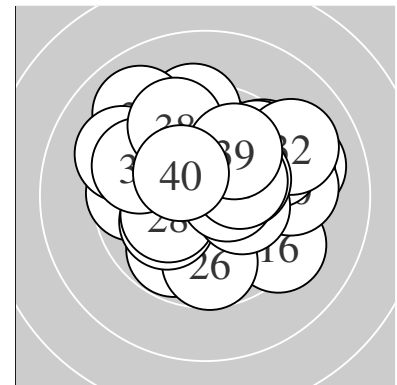

Serie 1:
 10.0 ← 9.5 ↗ 9.9 ↑ 9.1 → 10.0 →
 10.6 * 9.7 ↗ 9.7 ↗ 9.6 ← 9.8 ↘
 beste Teiler 92.8 (6.) 236.6 (1.) 239.0 (5.)
 Trefferlage 0.83 mm rechts, 0.56 mm hoch
 Streuwert 2.14, horizontal: 2.56, vertikal: 1.62

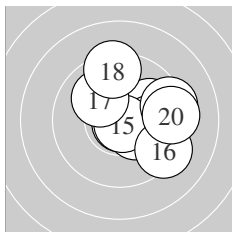

Serie 2:
 10.9 * 9.9 ↗ 10.0 → 10.3 * 10.8 *
 9.3 ↘ 10.0 ↘ 9.4 ↑ 9.3 → 9.3 →
 beste Teiler 25.0 (11.) 36.2 (15.) 151.7 (14.)
 Trefferlage 1.54 mm rechts, 0.42 mm hoch
 Streuwert 1.82, horizontal: 1.95, vertikal: 1.68

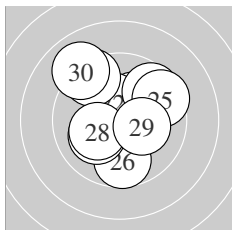

Serie 3:
 10.2 * 10.3 * 9.4 ↘ 9.6 ↗ 9.5 →
 9.7 ↓ 10.1 ↙ 10.2 * 10.2 * 9.0 ↘
 beste Teiler 154.7 (22.) 180.7 (29.) 188.2 (21.)
 Trefferlage 0.05 mm links, 0.84 mm hoch
 Streuwert 2.16, horizontal: 2.13, vertikal: 2.19

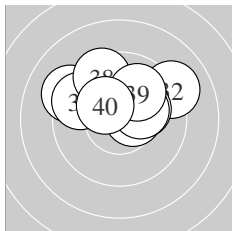

Serie 4:
 9.2 ↘ 9.1 ↗ 10.2 * 10.5 * 10.2 *
 9.6 ↘ 10.2 * 9.5 ↘ 10.0 ↗ 10.3 *
 beste Teiler 105.5 (34.) 155.6 (40.) 177.3 (37.)
 Trefferlage 0.09 mm links, 1.50 mm hoch
 Streuwert 1.86, horizontal: 2.46, vertikal: 0.93

Unterschrift des Schuetzen

Meyton Elektronik

Ergebnis: **375** (392.0)
 Serien: 92 93 92 98
 Zaehler: 20 16 3 1 0 0 0 0 0 0
 Innenzehner: 9
 weiteste: 928 (26), 613 (10), 553 (11)
 beste Teiler 73.5 (40.) 80.1 (4.) 85.0 (24.)
 Trefferlage 0.09 mm rechts, 0.15 mm tief
 Streuwert 2.36, horizontal: 2.79, vertikal: 1.83

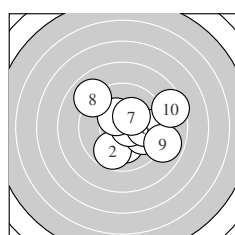
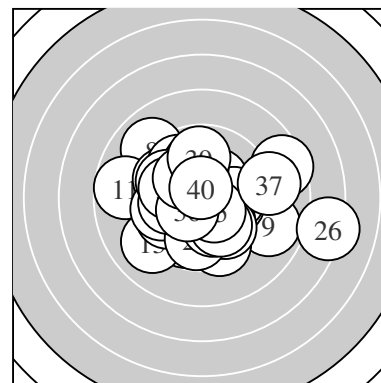

Serie 1:
 10.1 ↓ 9.8 ↙ 9.9 → 10.6 * 10.4 *
 9.9 → 10.3 * 9.0 ↘ 8.9 → 8.5 →
 beste Teiler 80.1 (4.) 145.4 (5.) 166.3 (7.)
 Trefferlage 1.22 mm rechts, 0.04 mm hoch
 Streuwert 2.44, horizontal: 2.79, vertikal: 2.02

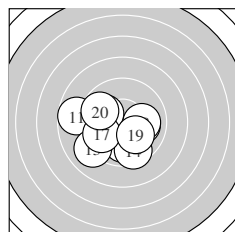

Serie 2:
 8.7 ← 9.9 ↓ 9.1 ↙ 9.5 ↓ 10.0 ↘
 10.0 → 9.8 ↙ 10.0 → 10.1 ↓ 9.7 ↘
 beste Teiler 214.2 (19.) 228.0 (18.) 228.1 (16.)
 Trefferlage 0.90 mm links, 0.92 mm tief
 Streuwert 2.28, horizontal: 2.72, vertikal: 1.72

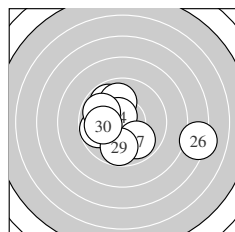

Serie 3:
 10.2 * 9.8 ↘ 10.0 ↑ 10.6 * 9.8 ←
 7.2 → 9.9 ↓ 9.8 ↘ 9.8 ↓ 10.0 ←
 beste Teiler 85.0 (24.) 199.4 (21.) 234.6 (30.)
 Trefferlage 0.18 mm links, 0.06 mm tief
 Streuwert 2.82, horizontal: 3.49, vertikal: 1.91

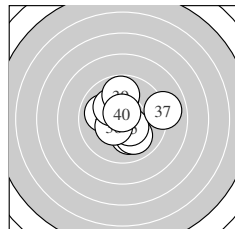

Serie 4:
 10.1 ↓ 10.0 ← 10.0 ↓ 10.1 ↑ 10.4 *
 10.4 * 9.0 → 10.2 * 9.8 ↑ 10.7 *
 beste Teiler 73.5 (40.) 128.0 (35.) 135.7 (36.)
 Trefferlage 0.24 mm rechts, 0.32 mm hoch
 Streuwert 1.81, horizontal: 1.94, vertikal: 1.68

Unterschrift des Schuetzen

Meyton Elektronik

Ergebnis: **387** (404.9)
 Serien: 95 97 99 96
 Zaehler: 27 13 0 0 0 0 0 0 0 0
 Innenzehner: 21
 weiteste: 448 (36), 392 (6), 382 (39)
 beste Teiler 14.7 (10.) 37.3 (18.) 48.0 (32.)
 Trefferlage 0.51 mm links, 0.47 mm tief
 Streuwert 1.57, horizontal: 1.25, vertikal: 1.85

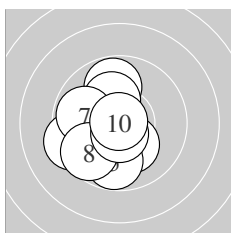
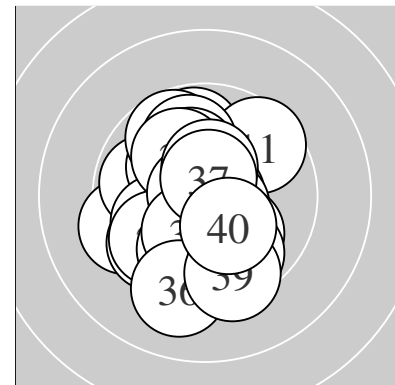

Serie 1:
 10.1 ← 9.8 ↑ 10.2 * 10.2 * 9.8 ↓
 9.4 ← 9.8 ← 9.7 ↙ 10.6 * 10.9 *
 beste Teiler 14.7 (10.) 81.0 (9.) 185.6 (3.)
 Trefferlage 1.14 mm links, 0.32 mm tief
 Streuwert 1.63, horizontal: 1.43, vertikal: 1.80

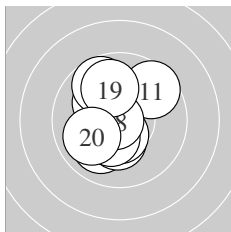

Serie 2:
 9.6 ↗ 10.0 ↘ 10.3 * 10.2 * 10.5 *
 10.4 * 9.7 ↘ 10.8 * 9.9 ↑ 10.0 ←
 beste Teiler 37.3 (18.) 114.0 (15.) 150.2 (16.)
 Trefferlage 0.60 mm links, 0.15 mm hoch
 Streuwert 1.60, horizontal: 1.28, vertikal: 1.87

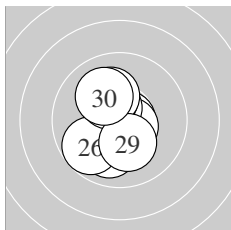

Serie 3:
 10.2 * 10.7 * 10.0 ↓ 10.6 * 10.5 *
 9.8 ↙ 10.3 * 10.2 * 10.2 * 10.1 ↘
 beste Teiler 55.0 (22.) 90.4 (24.) 107.3 (25.)
 Trefferlage 0.55 mm links, 0.16 mm tief
 Streuwert 1.34, horizontal: 0.96, vertikal: 1.64

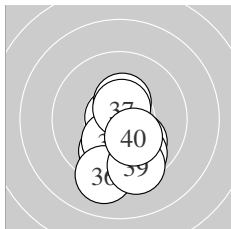

Serie 4:
 9.9 ↓ 10.8 * 10.0 ↘ 10.2 * 10.4 *
 9.2 ↓ 10.6 * 9.7 ↘ 9.4 ↓ 10.2 *
 beste Teiler 48.0 (32.) 85.5 (37.) 133.6 (35.)
 Trefferlage 0.23 mm rechts, 1.55 mm tief
 Streuwert 1.50, horizontal: 1.03, vertikal: 1.85

Unterschrift des Schuetzen

Meyton Elektronik

Ergebnis:	362	(381.8)
Serien:	89 87 96 90	
Zaehler:	15 14 9 2 0 0 0 0 0 0	
Innenzehner:	12	
weiteste:	998 (37), 816 (16), 736 (3)	
beste Teiler	53.0 (9.) 60.0 (25.) 67.4 (13.)	
Trefferlage	0.28 mm rechts, 0.19 mm tief	
Streuwert	2.97, horizontal: 3.19, vertikal: 2.73	

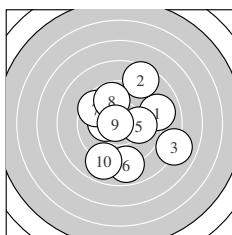
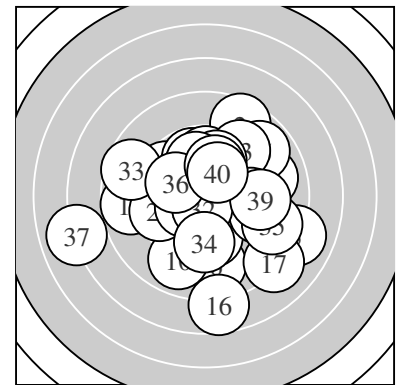

Serie 1:

9.0 →	8.6 ↗	8.0 ↘	10.3 *	10.0 →
8.9 ↓	9.6 ↖	9.8 ↕	10.7 *	8.9 ↙
beste Teiler	53.0 (9.)	172.0 (4.)	240.2 (5.)	
Trefferlage	0.90 mm rechts, 0.16 mm tief			
Streuwert	3.22, horizontal: 3.14, vertikal: 3.30			

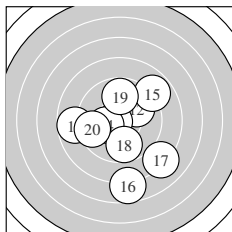

Serie 2:

8.7 ←	9.9 ↗	10.7 *	10.2 *	8.9 ↗
7.7 ↓	8.1 ↘	9.7 ↓	9.8 ↑	9.5 ←
beste Teiler	67.4 (13.)	181.2 (14.)	253.7 (12.)	
Trefferlage	0.16 mm rechts, 1.08 mm tief			
Streuwert	3.37, horizontal: 3.22, vertikal: 3.51			

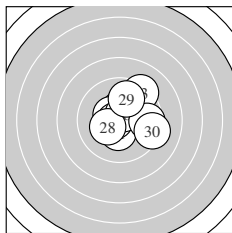

Serie 3:

10.3 *	10.4 *	9.2 ↗	10.5 *	10.7 *
10.6 *	9.6 →	10.3 *	9.9 ↑	9.3 →
beste Teiler	60.0 (25.)	91.4 (26.)	125.9 (24.)	
Trefferlage	0.80 mm rechts, 0.49 mm hoch			
Streuwert	1.77, horizontal: 1.90, vertikal: 1.62			

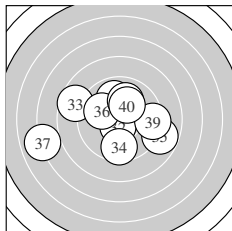

Serie 4:

9.9 ↑	10.6 *	8.6 ↖	9.6 ↓	8.8 →
10.0 ↖	7.0 ←	10.0 ↑	9.3 →	10.2 *
beste Teiler	92.4 (32.)	196.8 (40.)	237.4 (38.)	
Trefferlage	0.74 mm links, 0.01 mm tief			
Streuwert	3.41, horizontal: 4.27, vertikal: 2.23			

Unterschrift des Schuetzen

Meyton Elektronik

Ergebnis:	366	(383.5)
Serien:	91 90 96 89	
Zaehler:	14 19 6 1 0 0 0 0 0 0	
Innenzehner:	12	
weiteste:	916 (34), 710 (35), 654 (20)	
beste Teiler	82.6 (16.) 90.4 (5.) 98.2 (8.)	
Trefferlage	0.91 mm rechts, 0.02 mm tief	
Streuwert	2.72, horizontal: 3.09, vertikal: 2.30	

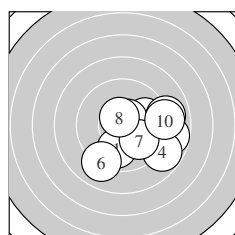
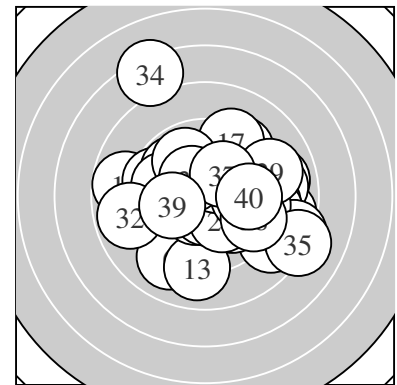

Serie 1:	9.9 ↘	8.8 →	9.9 →	8.8 ↘	10.6 *
	9.0 ↙	10.0 ↘	10.6 *	9.0 →	9.0 →
beste Teiler	90.4 (5.)	98.2 (8.)	248.0 (7.)		
Trefferlage	2.10 mm rechts, 0.83 mm tief				
Streuwert	2.37, horizontal: 2.74, vertikal: 1.93				

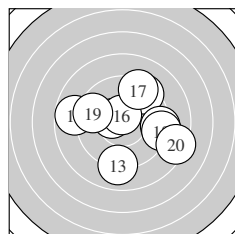

Serie 2:	9.4 ↗	8.8 ←	9.0 ↓	9.2 →	10.4 *
	10.6 *	9.3 ↗	9.1 →	9.5 ←	8.3 ↘
beste Teiler	82.6 (16.)	127.7 (15.)	353.6 (19.)		
Trefferlage	0.82 mm rechts, 0.10 mm hoch				
Streuwert	3.13, horizontal: 3.64, vertikal: 2.52				

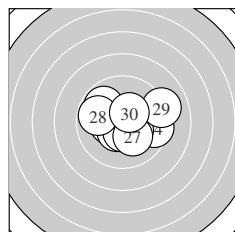

Serie 3:	9.8 ↘	10.4 *	10.4 *	9.5 →	10.3 *
	10.5 *	10.2 *	9.8 ←	9.1 →	10.4 *
beste Teiler	113.0 (26.)	127.4 (23.)	132.8 (30.)		
Trefferlage	0.40 mm rechts, 0.03 mm tief				
Streuwert	1.87, horizontal: 2.33, vertikal: 1.25				

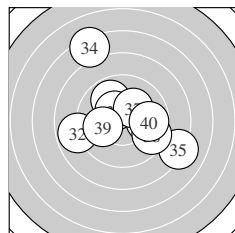

Serie 4:	9.9 ↘	8.8 ←	10.4 *	7.3 ↗	8.1 ↘
	9.9 →	10.2 *	9.5 ↘	10.0 ←	9.8 →
beste Teiler	146.8 (33.)	191.1 (37.)	233.2 (39.)		
Trefferlage	0.31 mm rechts, 0.65 mm hoch				
Streuwert	3.38, horizontal: 3.58, vertikal: 3.16				

Unterschrift des Schuetzen

Meyton Elektronik