

Ergebnis:	<b>389</b>	(406.4)
Serien:	96 98 97 98	
Zähler:	29 11 0 0 0 0 0 0 0 0	
Innenzehner:	22	
weiteste:	393 (3), 354 (33), 337 (13)	
beste Teiler	30.8 (18.) 45.5 (20.) 77.8 (34.)	
Trefferlage	0.43 mm links, 0.35 mm hoch	
Streuwert	1.48, horizontal: 1.65, vertikal: 1.29	

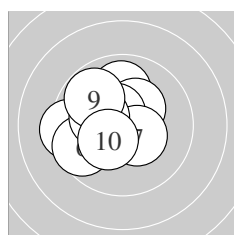

Serie 1:	9.9 ↑	10.0 ←	9.4 ←	10.3 *	10.5 *
	9.6 ↙	10.4 *	10.2 *	9.8 ↘	10.3 *
beste Teiler	102.3 (5.)	132.4 (7.)	152.0 (10.)		
Trefferlage	1.26 mm links, 0.40 mm hoch				
Streuwert	1.49, horizontal: 1.63, vertikal: 1.33				

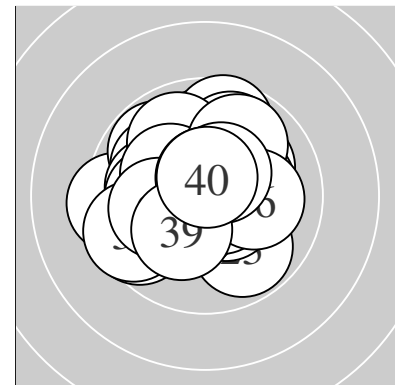
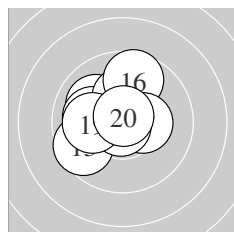

Serie 2:	10.0 ↘	10.2 *	9.6 ↙	10.1 ←	10.2 *
	9.7 ↑	10.4 *	10.8 *	10.1 ←	10.8 *
beste Teiler	30.8 (18.)	45.5 (20.)	149.1 (17.)		
Trefferlage	0.90 mm links, 0.48 mm hoch				
Streuwert	1.42, horizontal: 1.51, vertikal: 1.33				

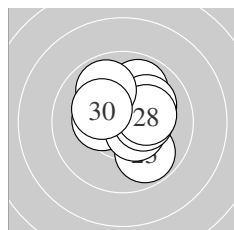

Serie 3:	10.3 *	10.3 *	9.8 ↘	9.9 ↗	10.5 *
	10.1 ↗	10.3 *	10.2 *	9.9 ↘	10.2 *
beste Teiler	113.4 (25.)	152.5 (21.)	153.3 (27.)		
Trefferlage	0.59 mm rechts, 0.55 mm hoch				
Streuwert	1.40, horizontal: 1.42, vertikal: 1.38				

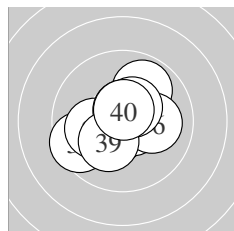

Serie 4:	10.5 *	9.9 ↗	9.5 ↙	10.6 *	10.1 ←
	10.1 →	10.6 *	10.5 *	10.2 *	10.6 *
beste Teiler	77.8 (34.)	81.0 (37.)	83.4 (40.)		
Trefferlage	0.17 mm links, 0.01 mm tief				
Streuwert	1.44, horizontal: 1.61, vertikal: 1.24				

Unterschrift des Schützen

Meyton Elektronik

Ergebnis: **387** (402.3)  
 Serien: 97 94 98 98  
 Zähler: 29 9 2 0 0 0 0 0 0 0  
 Innenzehner: 26  
 weiteste: 680 (20), 608 (2), 481 (39)  
 beste Teiler 35.7 (35.) 46.0 (4.) 75.0 (8.)  
 Trefferlage 0.74 mm links, 0.03 mm hoch  
 Streuwert 1.83, horizontal: 2.25, vertikal: 1.29

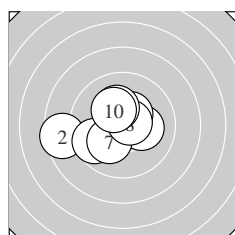
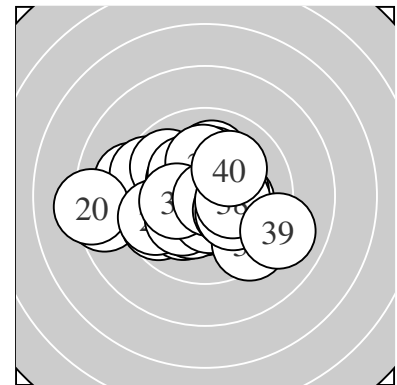

Serie 1:  
 10.6 \*                      8.5 ←                      9.7 ↙                      10.8 \*                      10.2 \*  
 10.4 \*                      10.1 ↙                      10.7 \*                      10.2 \*                      10.3 \*  
 beste Teiler 46.0 (4.) 75.0 (8.) 81.7 (1.)  
 Trefferlage 0.94 mm links, 0.02 mm tief  
 Streuwert 1.76, horizontal: 2.18, vertikal: 1.19

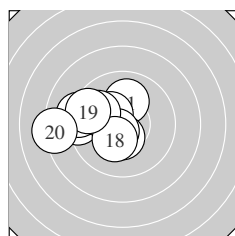

Serie 2:  
 10.0 ↑                      9.2 ←                      10.3 \*                      9.2 ←                      10.4 \*  
 10.6 \*                      9.9 ↖                      10.3 \*                      9.5 ↖                      8.2 ←  
 beste Teiler 92.1 (16.) 130.0 (15.) 154.9 (13.)  
 Trefferlage 2.37 mm links, 0.26 mm hoch  
 Streuwert 1.87, horizontal: 2.33, vertikal: 1.25

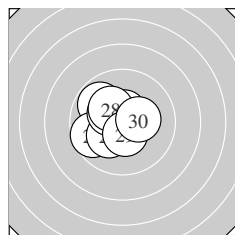

Serie 3:  
 10.2 \*                      9.8 ↘                      9.7 ↙                      10.2 \*                      10.6 \*  
 10.3 \*                      10.6 \*                      10.2 \*                      10.5 \*                      10.3 \*  
 beste Teiler 93.6 (25.) 97.1 (27.) 118.8 (29.)  
 Trefferlage 0.89 mm links, 0.10 mm hoch  
 Streuwert 1.25, horizontal: 1.30, vertikal: 1.20

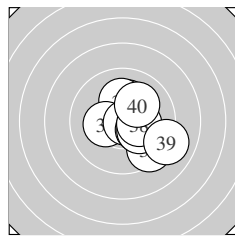

Serie 4:  
 9.4 ↘                      10.2 \*                      10.2 \*                      10.3 \*                      10.8 \*  
 10.3 \*                      10.2 \*                      10.3 \*                      9.0 ↘                      10.1 ↗  
 beste Teiler 35.7 (35.) 167.3 (38.) 170.8 (34.)  
 Trefferlage 1.22 mm rechts, 0.19 mm tief  
 Streuwert 1.63, horizontal: 1.63, vertikal: 1.63

Unterschrift des Schützen

Ergebnis: **387** (405.0)  
 Serien: 96 97 97 97  
 Zähler: 27 13 0 0 0 0 0 0 0 0  
 Innenzehner: 25  
 weiteste: 449 (35), 429 (27), 412 (32)  
 beste Teiler 72.9 (1.) 73.4 (24.) 81.9 (33.)  
 Trefferlage 0.91 mm rechts, 0.25 mm tief  
 Streuwert 1.50, horizontal: 1.61, vertikal: 1.39

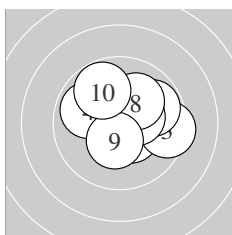
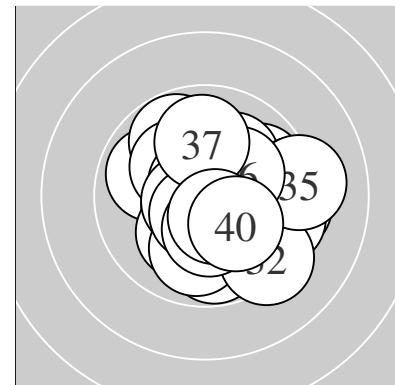

Serie 1:  
 10.7 \* 10.4 \* 9.4 → 9.9 ↖ 9.8 ↗  
 10.2 \* 10.4 \* 10.1 ↗ 10.4 \* 9.8 ↖  
 beste Teiler 72.9 (1.) 126.5 (2.) 141.2 (9.)  
 Trefferlage 0.63 mm rechts, 0.50 mm hoch  
 Streuwert 1.59, horizontal: 1.84, vertikal: 1.28

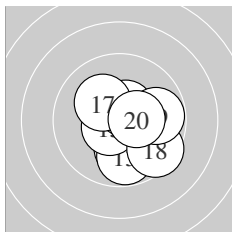

Serie 2:  
 10.2 \* 10.1 ↓ 9.8 ↓ 10.6 \* 10.6 \*  
 10.5 \* 10.2 \* 9.5 ↘ 9.8 → 10.4 \*  
 beste Teiler 94.0 (15.) 99.6 (14.) 102.8 (16.)  
 Trefferlage 0.89 mm rechts, 0.48 mm tief  
 Streuwert 1.42, horizontal: 1.39, vertikal: 1.45

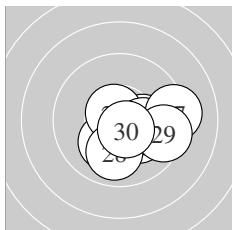

Serie 3:  
 10.2 \* 10.3 \* 10.2 \* 10.7 \* 10.2 \*  
 10.2 \* 9.2 → 9.9 ↓ 9.5 → 10.6 \*  
 beste Teiler 73.4 (24.) 88.4 (30.) 151.1 (22.)  
 Trefferlage 1.11 mm rechts, 0.81 mm tief  
 Streuwert 1.43, horizontal: 1.78, vertikal: 0.97

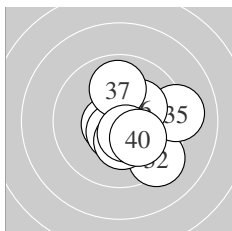

Serie 4:  
 10.4 \* 9.3 ↘ 10.6 \* 10.6 \* 9.2 →  
 10.2 \* 9.9 ↑ 10.3 \* 10.5 \* 10.2 \*  
 beste Teiler 81.9 (33.) 92.1 (34.) 109.1 (39.)  
 Trefferlage 1.00 mm rechts, 0.24 mm tief  
 Streuwert 1.62, horizontal: 1.63, vertikal: 1.61

Unterschrift des Schützen

Ergebnis: **377** (395.7)  
 Serien: 98 95 94 90  
 Zähler: 20 17 3 0 0 0 0 0 0 0  
 Innenzehner: 13  
 weiteste: 649 (14), 526 (32), 513 (25)  
 beste Teiler 24.7 (20.) 75.1 (13.) 81.9 (1.)  
 Trefferlage 0.34 mm rechts, 0.14 mm tief  
 Streuwert 2.15, horizontal: 2.50, vertikal: 1.72

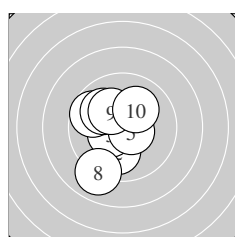
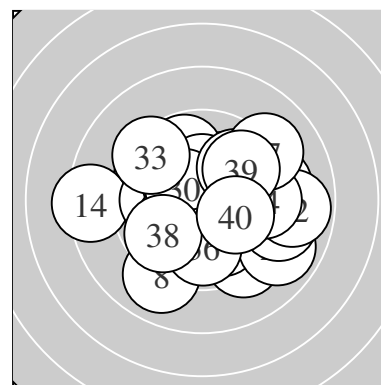

Serie 1:  
 10.6 \* 10.0 ↓ 10.4 \* 10.6 \* 10.6 \*  
 9.7 ↖ 10.0 ↖ 9.0 ↙ 10.2 \* 10.1 ↗  
 beste Teiler 81.9 (1.) 92.3 (4.) 94.3 (5.)  
 Trefferlage 0.77 mm links, 0.06 mm tief  
 Streuwert 1.70, horizontal: 1.40, vertikal: 1.96

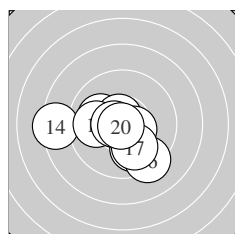

Serie 2:  
 9.9 ↓ 10.1 ↖ 10.7 \* 8.4 ← 10.5 \*  
 9.3 ↓ 10.0 ↓ 9.9 ← 10.6 \* 10.9 \*  
 beste Teiler 24.7 (20.) 75.1 (13.) 83.0 (19.)  
 Trefferlage 0.69 mm links, 0.74 mm tief  
 Streuwert 2.06, horizontal: 2.55, vertikal: 1.40

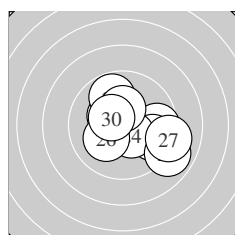

Serie 3:  
 10.3 \* 9.6 → 9.7 ↘ 10.4 \* 8.9 ↘  
 10.1 ↗ 9.1 → 9.8 ↘ 10.3 \* 10.4 \*  
 beste Teiler 126.7 (24.) 128.9 (30.) 151.4 (21.)  
 Trefferlage 1.10 mm rechts, 0.16 mm tief  
 Streuwert 2.07, horizontal: 2.43, vertikal: 1.63

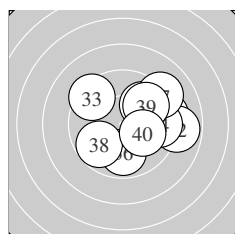

Serie 4:  
 9.3 → 8.8 → 9.4 ↘ 9.5 → 9.9 ↗  
 9.9 ↓ 9.1 ↗ 9.8 ↗ 9.8 ↗ 10.1 ↘  
 beste Teiler 212.6 (40.) 269.4 (35.) 273.0 (36.)  
 Trefferlage 1.75 mm rechts, 0.38 mm hoch  
 Streuwert 2.35, horizontal: 2.72, vertikal: 1.91

Unterschrift des Schützen

Meyton Elektronik

Ergebnis:	<b>342</b>	(358.8)			
Serien:	96	94	93	59	
Zähler:	20	14	2	0	0 0 0 0 0 0
Innenzehner:	16				
weiteste:	597 (19), 524 (25), 472 (18)				
beste Teiler	48.1 (36.) 60.4 (17.) 62.1 (6.)				
Trefferlage	1.14 mm rechts, 0.52 mm hoch				
Streuwert	1.86, horizontal: 1.82, vertikal: 1.90				

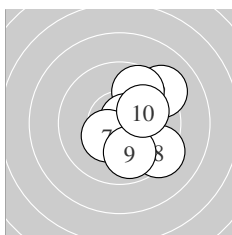
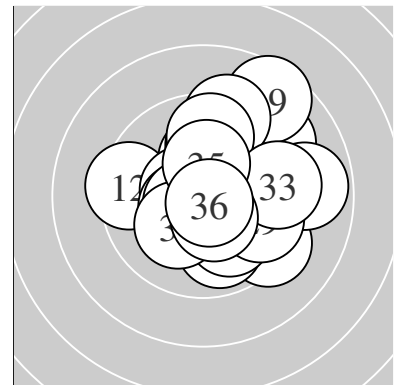

Serie 1:	10.6 *	9.2 ↗	10.7 *	9.7 ↗	10.0 ↘
	10.7 *	10.4 *	9.3 ↘	9.9 ↘	10.1 ↗
beste Teiler	62.1 (6.) 69.6 (3.) 81.5 (1.)				
Trefferlage	1.29 mm rechts, 0.24 mm tief				
Streuwert	1.69, horizontal: 1.40, vertikal: 1.94				

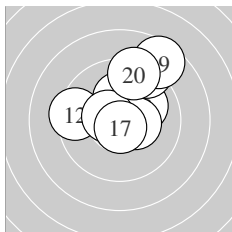

Serie 2:	9.6 ↗	9.4 ←	10.0 ↗	10.2 *	10.4 *
	10.5 *	10.7 *	9.1 ↗	8.6 ↗	9.3 ↗
beste Teiler	60.4 (17.) 105.9 (16.) 136.8 (15.)				
Trefferlage	0.66 mm rechts, 1.93 mm hoch				
Streuwert	2.01, horizontal: 2.01, vertikal: 2.01				

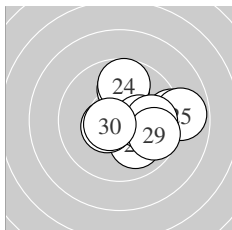

Serie 3:	9.9 ↗	9.2 →	10.0 ↘	9.7 ↗	8.9 →
	10.5 *	10.3 *	9.9 →	9.7 ↘	10.6 *
beste Teiler	91.3 (30.) 121.1 (26.) 170.2 (27.)				
Trefferlage	1.71 mm rechts, 0.24 mm hoch				
Streuwert	1.85, horizontal: 2.12, vertikal: 1.54				

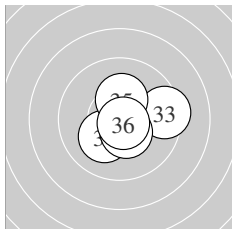

Serie 4:	10.5 *	10.2 *	9.4 →	10.5 *	10.3 *
	10.8 *				
beste Teiler	48.1 (36.) 105.9 (31.) 125.6 (34.)				
Trefferlage	0.76 mm rechts, 0.04 mm tief				
Streuwert	1.46, horizontal: 1.69, vertikal: 1.17				

Unterschrift des Schützen

Meyton Elektronik

Ergebnis: **381** (402.2)  
 Serien: 95 94 96 96  
 Zähler: 21 19 0 0 0 0 0 0 0 0  
 Innenzehner: 19  
 weiteste: 420 (29), 383 (19), 378 (39)  
 beste Teiler 44.2 (34.) 50.2 (14.) 63.1 (12.)  
 Trefferlage 0.42 mm links, 0.59 mm hoch  
 Streuwert 1.67, horizontal: 1.63, vertikal: 1.71

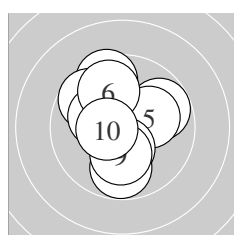
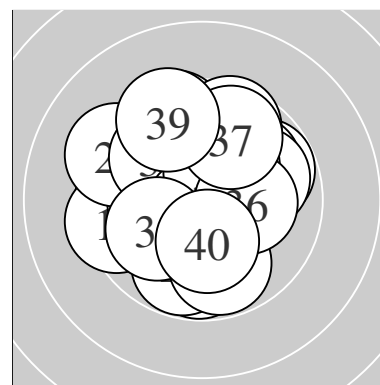

Serie 1:  
 9.5 ↖ 9.8 ↗ 9.7 ↘ 10.2 \* 10.1 ↗  
 9.8 ↖ 10.3 \* 9.8 ↓ 10.2 \* 10.5 \*  
 beste Teiler 114.8 (10.) 154.3 (7.) 189.3 (4.)  
 Trefferlage 0.30 mm links, 0.42 mm hoch  
 Streuwert 1.83, horizontal: 1.58, vertikal: 2.05

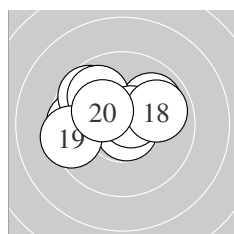

Serie 2:  
 9.6 ← 10.7 \* 9.7 ↘ 10.8 \* 9.9 ↗  
 9.9 ↘ 10.6 \* 9.9 ↗ 9.4 ← 10.3 \*  
 beste Teiler 50.2 (14.) 63.1 (12.) 80.8 (17.)  
 Trefferlage 0.71 mm links, 0.73 mm hoch  
 Streuwert 1.66, horizontal: 2.14, vertikal: 0.97

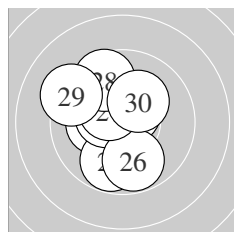

Serie 3:  
 10.6 \* 10.2 \* 9.8 ↓ 10.4 \* 10.4 \*  
 9.8 ↓ 10.4 \* 9.6 ↖ 9.3 ↘ 10.2 \*  
 beste Teiler 85.0 (21.) 127.4 (25.) 132.2 (27.)  
 Trefferlage 0.69 mm links, 0.42 mm hoch  
 Streuwert 1.70, horizontal: 1.48, vertikal: 1.89

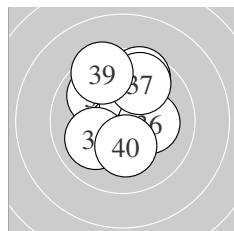

Serie 4:  
 9.9 ↘ 10.5 \* 9.6 ↑ 10.8 \* 10.4 \*  
 10.2 \* 9.8 ↑ 10.0 ← 9.4 ↖ 10.2 \*  
 beste Teiler 44.2 (34.) 104.6 (32.) 133.7 (35.)  
 Trefferlage 0.01 mm rechts, 0.78 mm hoch  
 Streuwert 1.67, horizontal: 1.36, vertikal: 1.94

Unterschrift des Schützen

Meyton Elektronik

Ergebnis: **380** (395.8)  
 Serien: 94 98 95 93  
 Zähler: 20 20 0 0 0 0 0 0 0 0  
 Innenzehner: 13  
 weiteste: 486 (24), 485 (3), 484 (31)  
 beste Teiler 62.8 (5.) 80.4 (19.) 96.3 (30.)  
 Trefferlage 0.04 mm rechts, 0.32 mm tief  
 Streuwert 2.05, horizontal: 2.47, vertikal: 1.52

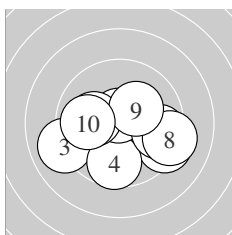
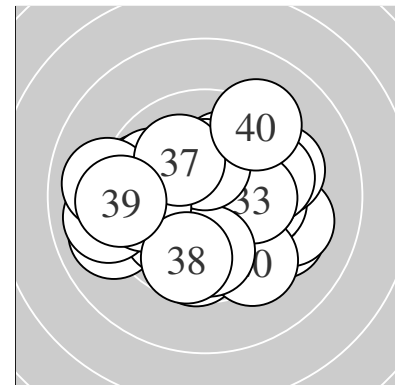

Serie 1:  
 9.3 ↘                      10.6 \*                      9.0 ←                      9.7 ↓                      10.7 \*  
 9.6 →                      10.1 ←                      9.2 →                      10.2 \*                      9.9 ←  
 beste Teiler 62.8 (5.) 98.0 (2.) 179.3 (9.)  
 Trefferlage 0.34 mm rechts, 0.59 mm tief  
 Streuwert 2.25, horizontal: 2.86, vertikal: 1.40

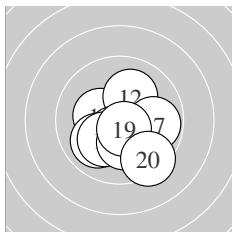

Serie 2:  
 10.3 \*                      10.1 ↗                      10.0 ↙                      10.5 \*                      10.2 \*  
 10.2 \*                      9.8 →                      10.2 \*                      10.6 \*                      9.4 ↘  
 beste Teiler 80.4 (19.) 118.1 (14.) 163.0 (11.)  
 Trefferlage 0.29 mm rechts, 0.94 mm tief  
 Streuwert 1.48, horizontal: 1.58, vertikal: 1.38

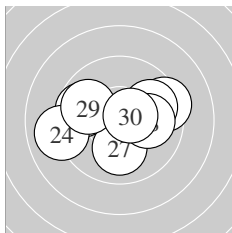

Serie 3:  
 9.4 →                      9.7 ←                      9.9 →                      9.0 ←                      10.5 \*  
 10.4 \*                      10.0 ↓                      10.0 →                      9.8 ↖                      10.6 \*  
 beste Teiler 96.3 (30.) 108.1 (25.) 133.0 (26.)  
 Trefferlage 0.13 mm rechts, 0.09 mm hoch  
 Streuwert 2.08, horizontal: 2.73, vertikal: 1.11

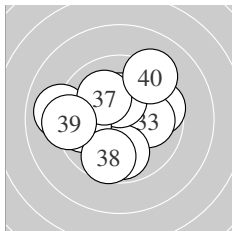

Serie 4:  
 9.0 ←                      9.6 →                      10.0 →                      9.9 ↓                      10.3 \*  
 9.8 ←                      10.1 ↘                      9.7 ↓                      9.3 ←                      9.2 ↗  
 beste Teiler 154.0 (35.) 216.4 (37.) 230.2 (33.)  
 Trefferlage 0.58 mm links, 0.16 mm hoch  
 Streuwert 2.42, horizontal: 2.78, vertikal: 1.99

Unterschrift des Schützen

Meyton Elektronik

Ergebnis: **377** (396.7)  
 Serien: 94 93 91 99  
 Zähler: 20 17 3 0 0 0 0 0 0 0  
 Innenzehner: 20  
 weiteste: 590 (22), 560 (2), 502 (28)  
 beste Teiler 85.4 (11.) 87.3 (35.) 111.0 (33.)  
 Trefferlage 1.12 mm rechts, 0.14 mm hoch  
 Streuwert 1.88, horizontal: 2.13, vertikal: 1.61

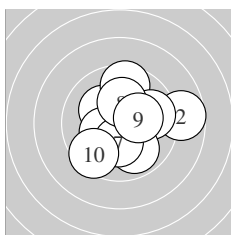
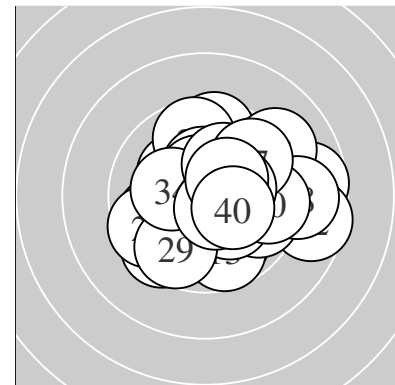

Serie 1:  
 10.2 \*                      8.7 →                      10.3 \*                      9.6 ↑                      9.8 →  
 9.9 ↘                      10.3 \*                      10.2 \*                      10.3 \*                      9.5 ↙  
 beste Teiler 162.6 (3.) 171.2 (7.) 175.6 (9.)  
 Trefferlage 0.67 mm rechts, 0.08 mm hoch  
 Streuwert 2.14, horizontal: 2.33, vertikal: 1.94

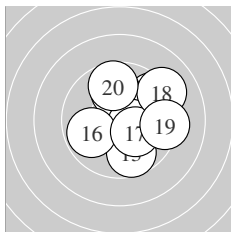

Serie 2:  
 10.6 \*                      9.5 ↗                      9.7 ↘                      9.9 ↑                      10.5 \*  
 9.8 ←                      10.2 \*                      9.1 ↗                      9.3 →                      9.7 ↑  
 beste Teiler 85.4 (11.) 121.1 (15.) 176.6 (17.)  
 Trefferlage 1.17 mm rechts, 0.46 mm hoch  
 Streuwert 2.02, horizontal: 2.05, vertikal: 1.99

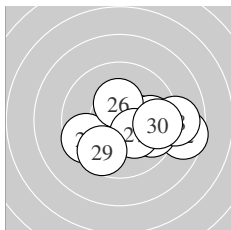

Serie 3:  
 10.3 \*                      8.6 →                      9.7 →                      9.8 →                      9.6 ←  
 10.3 \*                      10.2 \*                      8.9 →                      9.7 ↙                      9.6 →  
 beste Teiler 151.4 (26.) 157.0 (21.) 180.6 (27.)  
 Trefferlage 1.80 mm rechts, 0.69 mm tief  
 Streuwert 2.14, horizontal: 2.78, vertikal: 1.17

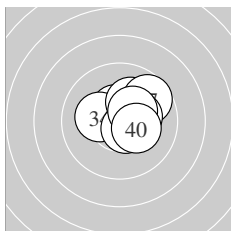

Serie 4:  
 10.5 \*                      10.2 \*                      10.5 \*                      10.2 \*                      10.6 \*  
 10.2 \*                      9.7 ↗                      10.3 \*                      10.4 \*                      10.3 \*  
 beste Teiler 87.3 (35.) 111.0 (33.) 121.2 (31.)  
 Trefferlage 0.83 mm rechts, 0.71 mm hoch  
 Streuwert 1.05, horizontal: 1.18, vertikal: 0.89

Unterschrift des Schützen

Meyton Elektronik



Ergebnis: **388** (407.1)  
 Serien: 98 96 99 95  
 Zähler: 29 10 1 0 0 0 0 0 0 0  
 Innenzehner: 23  
 weiteste: 547 (32), 340 (11), 308 (38)  
 beste Teiler 38.2 (22.) 50.0 (24.) 82.3 (4.)  
 Trefferlage 0.89 mm links, 0.47 mm tief  
 Streuwert 1.37, horizontal: 1.36, vertikal: 1.37

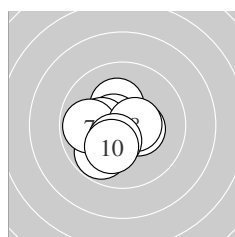
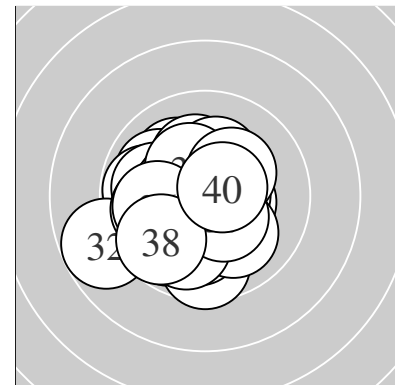

Serie 1:  
 10.3 \* 9.8 ↘ 10.4 \* 10.6 \* 10.3 \*  
 10.4 \* 9.9 ← 10.5 \* 10.4 \* 10.2 \*  
 beste Teiler 82.3 (4.) 102.1 (8.) 134.6 (6.)  
 Trefferlage 0.80 mm links, 0.40 mm tief  
 Streuwert 1.18, horizontal: 1.23, vertikal: 1.12

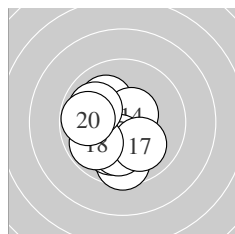

Serie 2:  
 9.6 ↓ 10.1 ↖ 10.0 ↙ 10.6 \* 10.3 \*  
 10.1 ↓ 10.0 ↘ 9.8 ↗ 9.9 ↖ 9.8 ←  
 beste Teiler 96.4 (14.) 162.7 (15.) 216.5 (12.)  
 Trefferlage 0.81 mm links, 0.92 mm tief  
 Streuwert 1.54, horizontal: 1.38, vertikal: 1.70

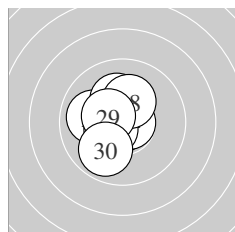

Serie 3:  
 10.5 \* 10.8 \* 10.5 \* 10.8 \* 10.0 ←  
 10.5 \* 10.2 \* 10.2 \* 10.4 \* 9.9 ↙  
 beste Teiler 38.2 (22.) 50.0 (24.) 109.0 (21.)  
 Trefferlage 0.76 mm links, 0.04 mm hoch  
 Streuwert 1.06, horizontal: 0.89, vertikal: 1.20

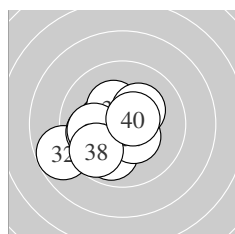

Serie 4:  
 10.4 \* 8.8 ↗ 9.9 ← 9.9 ↓ 10.3 \*  
 10.0 ← 10.4 \* 9.7 ↗ 10.3 \* 10.6 \*  
 beste Teiler 96.1 (40.) 138.7 (37.) 142.7 (31.)  
 Trefferlage 1.19 mm links, 0.59 mm tief  
 Streuwert 1.69, horizontal: 1.92, vertikal: 1.41

Unterschrift des Schützen

Meyton Elektronik

Ergebnis: **366** (383.1)  
 Serien: 98 99 99 70  
 Zähler: 33 4 0 0 0 0 0 0 0 0  
 Innenzehner: 27  
 weiteste: 326 (28), 323 (1), 300 (5)  
 beste Teiler 26.5 (25.) 28.0 (6.) 30.0 (12.)  
 Trefferlage 0.23 mm rechts, 0.44 mm hoch  
 Streuwert 1.18, horizontal: 1.31, vertikal: 1.04

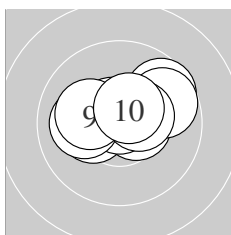
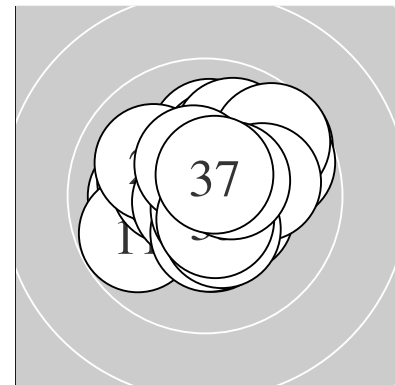

Serie 1:  
 9.7 ↗ 10.3 \* 10.6 \* 10.5 \* 9.8 ↗  
 10.8 \* 10.1 ← 10.4 \* 10.2 \* 10.5 \*  
 beste Teiler 28.0 (6.) 83.6 (3.) 105.6 (4.)  
 Trefferlage 0.19 mm rechts, 0.56 mm hoch  
 Streuwert 1.34, horizontal: 1.78, vertikal: 0.67

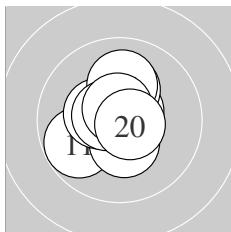

Serie 2:  
 9.8 ↙ 10.8 \* 10.6 \* 10.2 \* 10.4 \*  
 10.4 \* 10.1 ↑ 10.6 \* 10.6 \* 10.7 \*  
 beste Teiler 30.0 (12.) 71.3 (20.) 76.2 (19.)  
 Trefferlage 0.25 mm links, 0.30 mm hoch  
 Streuwert 1.12, horizontal: 1.03, vertikal: 1.20

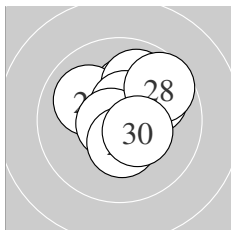

Serie 3:  
 10.0 ↗ 10.2 \* 10.0 ↘ 10.0 ↗ 10.8 \*  
 10.6 \* 10.7 \* 9.6 ↗ 10.4 \* 10.4 \*  
 beste Teiler 26.5 (25.) 58.3 (27.) 96.5 (26.)  
 Trefferlage 0.50 mm rechts, 0.71 mm hoch  
 Streuwert 1.28, horizontal: 1.30, vertikal: 1.25

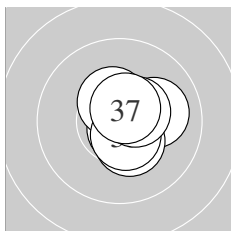

Serie 4:  
 10.1 → 10.7 \* 10.4 \* 10.4 \* 10.6 \*  
 10.5 \* 10.6 \*  
 beste Teiler 52.8 (32.) 88.6 (37.) 97.1 (35.)  
 Trefferlage 0.61 mm rechts, 0.06 mm hoch  
 Streuwert 0.89, horizontal: 0.82, vertikal: 0.95

Unterschrift des Schützen

Ergebnis: **391** (405.4)  
 Serien: 96 98 99 98  
 Zähler: 31 9 0 0 0 0 0 0 0 0  
 Innenzehner: 24  
 weiteste: 421 (19), 412 (33), 370 (8)  
 beste Teiler 50.0 (18.) 90.6 (28.) 92.0 (21.)  
 Trefferlage 0.20 mm rechts, 0.22 mm hoch  
 Streuwert 1.58, horizontal: 1.69, vertikal: 1.45

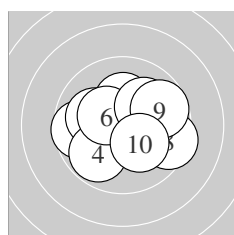
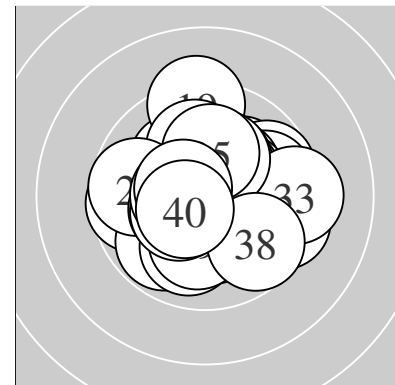

Serie 1:  
 9.7 ←                      10.1 ←                      10.4 \*                      9.8 ↙                      10.2 \*  
 10.4 \*                      10.1 ↗                      9.5 →                      9.7 →                      10.2 \*  
 beste Teiler 143.5 (6.) 143.9 (3.) 179.0 (5.)  
 Trefferlage 0.22 mm rechts, 0.12 mm hoch  
 Streuwert 1.85, horizontal: 2.27, vertikal: 1.30

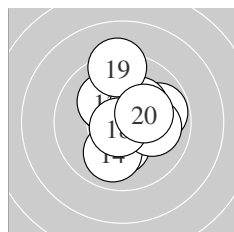

Serie 2:  
 10.2 \*                      10.2 \*                      10.2 \*                      10.0 ↓                      9.8 →  
 10.0 →                      10.3 \*                      10.8 \*                      9.3 ↑                      10.2 \*  
 beste Teiler 50.0 (18.) 173.9 (17.) 176.4 (11.)  
 Trefferlage 0.38 mm rechts, 0.50 mm hoch  
 Streuwert 1.67, horizontal: 1.46, vertikal: 1.86

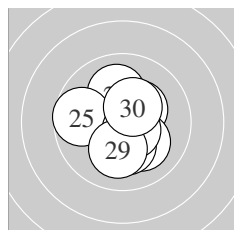

Serie 3:  
 10.6 \*                      10.3 \*                      10.3 \*                      10.1 ↑                      9.7 ←  
 10.1 ↘                      10.2 \*                      10.6 \*                      10.1 ↓                      10.4 \*  
 beste Teiler 90.6 (28.) 92.0 (21.) 139.7 (30.)  
 Trefferlage 0.05 mm links, 0.09 mm hoch  
 Streuwert 1.40, horizontal: 1.30, vertikal: 1.49

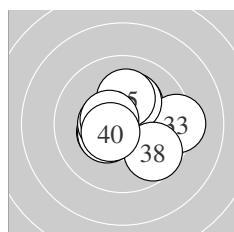

Serie 4:  
 10.2 \*                      10.4 \*                      9.3 →                      10.2 \*                      10.2 \*  
 10.4 \*                      10.5 \*                      9.7 ↘                      10.5 \*                      10.5 \*  
 beste Teiler 106.5 (39.) 111.2 (40.) 120.0 (37.)  
 Trefferlage 0.26 mm rechts, 0.15 mm hoch  
 Streuwert 1.57, horizontal: 1.81, vertikal: 1.28

Unterschrift des Schützen

Meyton Elektronik

Ergebnis: **293** (304.2)  
 Serien: 98 99 96  
 Zähler: 23 7 0 0 0 0 0 0 0 0  
 Innenzehner: 19  
 weiteste: 462 (5), 423 (30), 418 (15)  
 beste Teiler 47.5 (7.) 66.2 (22.) 73.6 (26.)  
 Trefferlage 0.03 mm rechts, 0.91 mm tief  
 Streuwert 1.54, horizontal: 1.78, vertikal: 1.24

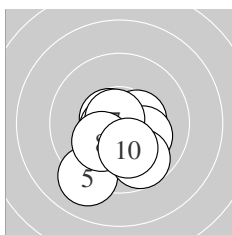
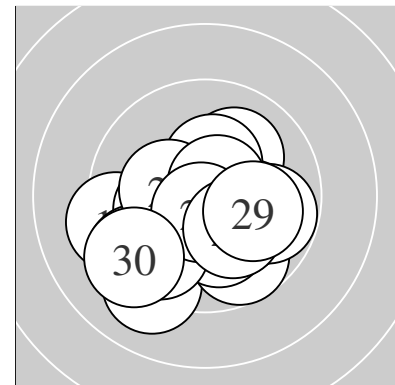

Serie 1:  
 10.4 \*                      10.6 \*                      10.4 \*                      10.2 \*                      9.1 ↙  
 10.6 \*                      10.8 \*                      10.2 \*                      9.7 ↘                      10.2 \*  
 beste Teiler 47.5 (7.) 82.8 (6.) 85.4 (2.)  
 Trefferlage 0.04 mm rechts, 1.12 mm tief  
 Streuwert 1.39, horizontal: 1.38, vertikal: 1.41

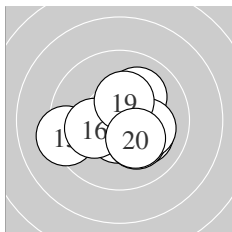

Serie 2:  
 10.6 \*                      10.1 ↗                      10.2 \*                      10.1 ↘                      9.3 ←  
 10.2 \*                      10.2 \*                      10.1 →                      10.4 \*                      10.2 \*  
 beste Teiler 99.1 (11.) 146.9 (19.) 180.5 (13.)  
 Trefferlage 0.32 mm rechts, 0.52 mm tief  
 Streuwert 1.57, horizontal: 1.91, vertikal: 1.14

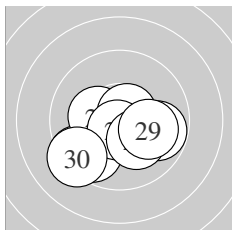

Serie 3:  
 9.3 ↙                      10.7 \*                      9.7 ↙                      9.8 →                      10.3 \*  
 10.7 \*                      10.6 \*                      10.2 \*                      10.0 →                      9.3 ↙  
 beste Teiler 66.2 (22.) 73.6 (26.) 76.1 (27.)  
 Trefferlage 0.28 mm links, 1.11 mm tief  
 Streuwert 1.72, horizontal: 2.12, vertikal: 1.17

Unterschrift des Schützen

Ergebnis: **308** (322.4)  
 Serien: 95 97 96 20  
 Zähler: 20 12 0 0 0 0 0 0 0 0  
 Innenzehner: 15  
 weiteste: 450 (2), 434 (20), 392 (3)  
 beste Teiler 64.5 (13.) 74.6 (1.) 76.1 (7.)  
 Trefferlage 0.77 mm links, 0.02 mm tief  
 Streuwert 1.65, horizontal: 1.84, vertikal: 1.44

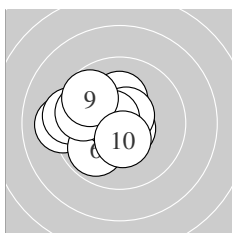
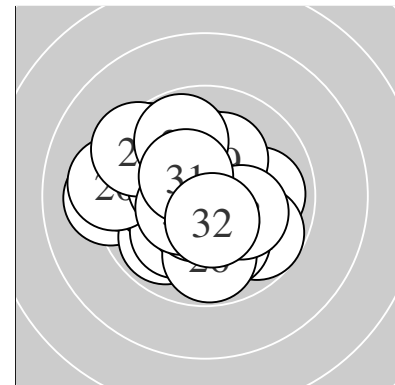

Serie 1:  
 10.7 \*                      9.2 ←                      9.4 ←                      10.2 \*                      10.6 \*  
 9.9 ↙                      10.6 \*                      9.8 ←                      9.7 ↘                      10.4 \*  
 beste Teiler 74.6 (1.) 76.1 (7.) 80.9 (5.)  
 Trefferlage 1.47 mm links, 0.24 mm hoch  
 Streuwert 1.60, horizontal: 1.88, vertikal: 1.25

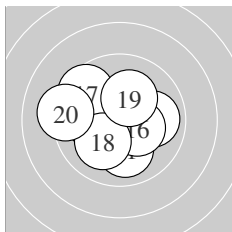

Serie 2:  
 10.0 ↓                      9.9 →                      10.7 \*                      10.1 ↖                      10.1 ←  
 10.3 \*                      9.6 ↘                      10.1 ↙                      10.2 \*                      9.2 ←  
 beste Teiler 64.5 (13.) 151.7 (16.) 189.8 (19.)  
 Trefferlage 0.71 mm links, 0.15 mm hoch  
 Streuwert 1.78, horizontal: 2.10, vertikal: 1.39

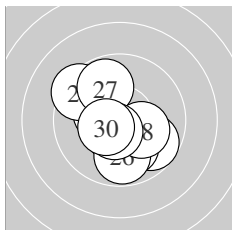

Serie 3:  
 10.3 \*                      9.4 ↖                      10.5 \*                      9.7 ↘                      10.0 ↓  
 9.8 ↓                      9.8 ↖                      10.2 \*                      10.6 \*                      10.5 \*  
 beste Teiler 97.5 (29.) 113.1 (23.) 120.7 (30.)  
 Trefferlage 0.24 mm links, 0.45 mm tief  
 Streuwert 1.71, horizontal: 1.64, vertikal: 1.77

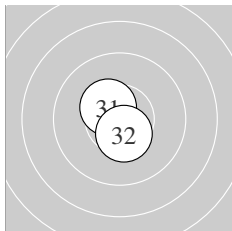

Serie 4:  
 10.4 \*                      10.5 \*  
 beste Teiler 120.8 (32.) 130.1 (31.)  
 Trefferlage 0.28 mm links, 0.11 mm tief  
 Streuwert 1.22, horizontal: 0.88, vertikal: 1.48

Unterschrift des Schützen

Meyton Elektronik

Ergebnis: **386** (404.0)  
 Serien: 98 94 98 96  
 Zähler: 27 12 1 0 0 0 0 0 0 0  
 Innenzehner: 20  
 weiteste: 509 (37), 438 (16), 360 (11)  
 beste Teiler 65.7 (18.) 85.8 (22.) 89.8 (40.)  
 Trefferlage 0.37 mm rechts, 0.71 mm hoch  
 Streuwert 1.59, horizontal: 1.62, vertikal: 1.56

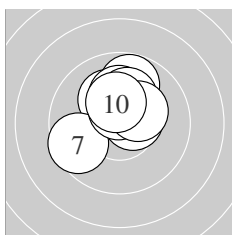
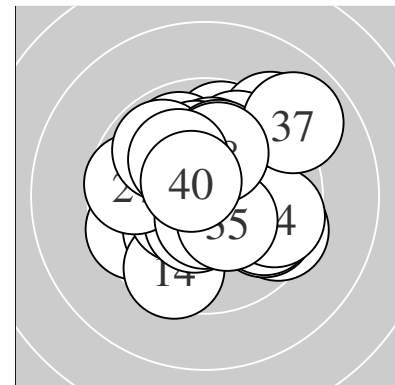

Serie 1:  
 10.5 \*                      10.3 \*                      9.8 ↑                      10.2 \*                      10.1 ↑  
 10.2 \*                      9.6 ↙                      10.5 \*                      10.3 \*                      10.3 \*  
 beste Teiler 101.3 (8.) 101.6 (1.) 154.3 (2.)  
 Trefferlage 0.00 mm , 1.21 mm hoch  
 Streuwert 1.22, horizontal: 1.26, vertikal: 1.19

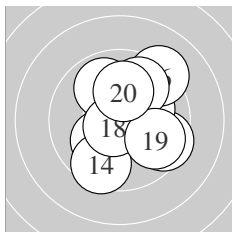

Serie 2:  
 9.5 ↘                      9.9 ↖                      10.1 ↗                      9.6 ↓                      10.1 ↗  
 9.2 ↗                      9.8 ↑                      10.7 \*                      9.8 ↘                      10.1 ↑  
 beste Teiler 65.7 (18.) 202.8 (15.) 205.8 (13.)  
 Trefferlage 0.79 mm rechts, 0.29 mm hoch  
 Streuwert 2.03, horizontal: 1.85, vertikal: 2.21

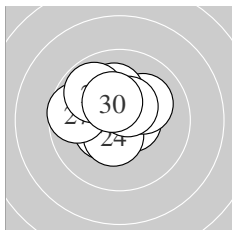

Serie 3:  
 10.4 \*                      10.6 \*                      10.4 \*                      10.5 \*                      10.1 ↗  
 10.1 ↑                      9.7 ←                      9.8 ↖                      10.5 \*                      10.4 \*  
 beste Teiler 85.8 (22.) 117.9 (29.) 125.7 (24.)  
 Trefferlage 0.32 mm links, 0.68 mm hoch  
 Streuwert 1.30, horizontal: 1.49, vertikal: 1.07

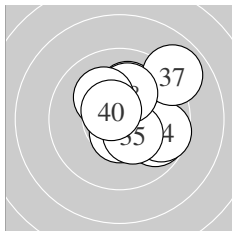

Serie 4:  
 10.4 \*                      10.6 \*                      9.8 ↘                      9.7 →                      10.4 \*  
 10.1 ↑                      8.9 ↗                      10.2 \*                      10.2 \*                      10.6 \*  
 beste Teiler 89.8 (40.) 100.0 (32.) 141.2 (31.)  
 Trefferlage 1.03 mm rechts, 0.65 mm hoch  
 Streuwert 1.64, horizontal: 1.66, vertikal: 1.63

Unterschrift des Schützen

Meyton Elektronik

Ergebnis: **385** (403.1)  
 Serien: 95 97 95 98  
 Zähler: 25 15 0 0 0 0 0 0 0 0  
 Innenzehner: 17  
 weiteste: 487 (38), 423 (30), 418 (6)  
 beste Teiler 14.0 (4.) 21.2 (10.) 39.2 (21.)  
 Trefferlage 0.40 mm rechts, 0.38 mm tief  
 Streuwert 1.75, horizontal: 2.23, vertikal: 1.08

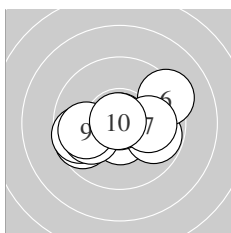
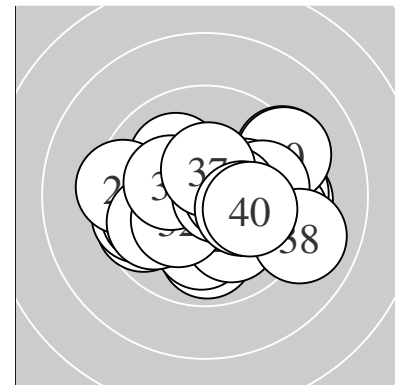

Serie 1:  
 10.5 \*                      9.8 ↘                      9.7 ←                      10.9 \*                      9.6 ←  
 9.3 ↗                      10.0 →                      10.0 ←                      9.9 ←                      10.9 \*  
 beste Teiler 14.0 (4.) 21.2 (10.) 105.2 (1.)  
 Trefferlage 0.23 mm links, 0.36 mm tief  
 Streuwert 1.90, horizontal: 2.49, vertikal: 0.99

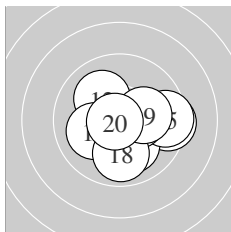

Serie 2:  
 9.4 →                      10.1 ↖                      10.4 \*                      10.1 ↘                      9.5 →  
 10.1 ←                      10.4 \*                      9.9 ↓                      10.2 \*                      10.8 \*  
 beste Teiler 39.8 (20.) 136.0 (17.) 141.6 (13.)  
 Trefferlage 0.67 mm rechts, 0.42 mm tief  
 Streuwert 1.67, horizontal: 2.03, vertikal: 1.21

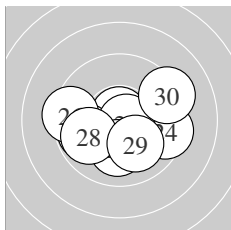

Serie 3:  
 10.8 \*                      10.3 \*                      9.8 ←                      9.5 →                      10.7 \*  
 9.4 ←                      10.1 ↓                      9.9 ←                      10.1 ↘                      9.3 ↗  
 beste Teiler 39.2 (21.) 56.3 (25.) 169.4 (22.)  
 Trefferlage 0.04 mm links, 0.61 mm tief  
 Streuwert 2.00, horizontal: 2.53, vertikal: 1.28

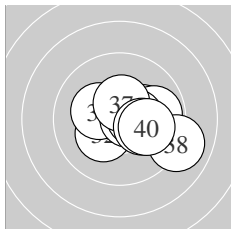

Serie 4:  
 10.2 \*                      10.3 \*                      9.9 →                      10.3 \*                      10.7 \*  
 10.5 \*                      10.5 \*                      9.0 ↘                      10.2 \*                      10.1 →  
 beste Teiler 68.0 (35.) 122.5 (36.) 125.8 (37.)  
 Trefferlage 1.20 mm rechts, 0.14 mm tief  
 Streuwert 1.46, horizontal: 1.83, vertikal: 0.93

Unterschrift des Schützen

Ergebnis: **374** (393.7)  
 Serien: 95 92 95 92  
 Zähler: 20 15 4 1 0 0 0 0 0 0  
 Innenzehner: 15  
 weiteste: 774 (31), 718 (25), 596 (37)  
 beste Teiler 15.2 (33.) 62.1 (26.) 83.3 (1.)  
 Trefferlage 0.91 mm links, 0.06 mm tief  
 Streuwert 2.26, horizontal: 2.23, vertikal: 2.28

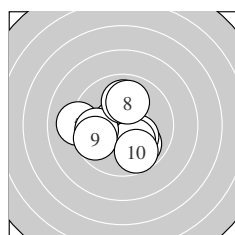
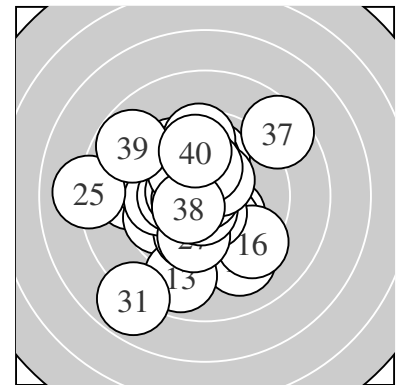

Serie 1:  
 10.6 \* 9.9 ↘ 10.2 \* 10.2 \* 9.1 ←  
 9.9 ← 10.0 ↑ 10.0 ↑ 9.7 ← 9.7 ↘  
 beste Teiler 83.3 (1.) 188.0 (3.) 193.2 (4.)  
 Trefferlage 0.44 mm links, 0.38 mm tief  
 Streuwert 1.98, horizontal: 2.20, vertikal: 1.72

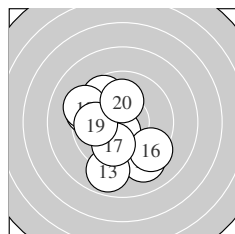

Serie 2:  
 9.5 ↖ 9.2 ↘ 8.9 ↓ 9.7 ↗ 10.5 \*  
 9.3 ↘ 10.0 ↓ 9.3 ↖ 9.8 ← 10.1 ↑  
 beste Teiler 103.6 (15.) 218.1 (20.) 246.6 (17.)  
 Trefferlage 1.00 mm links, 0.78 mm tief  
 Streuwert 2.45, horizontal: 2.25, vertikal: 2.64

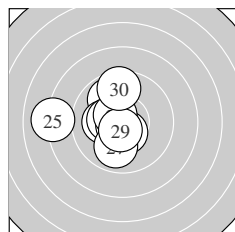

Serie 3:  
 9.9 ↗ 10.2 \* 10.5 \* 10.4 \* 8.1 ←  
 10.7 \* 9.9 ↓ 10.5 \* 10.6 \* 9.6 ↑  
 beste Teiler 62.1 (26.) 84.2 (29.) 106.7 (28.)  
 Trefferlage 1.42 mm links, 0.23 mm hoch  
 Streuwert 1.92, horizontal: 2.13, vertikal: 1.68

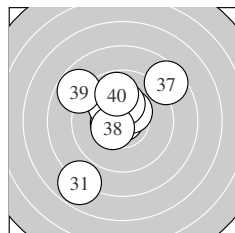

Serie 4:  
 7.9 ↙ 10.5 \* 10.9 \* 10.4 \* 10.1 ↗  
 10.2 \* 8.6 ↗ 10.5 \* 8.8 ↖ 9.8 ↑  
 beste Teiler 15.2 (33.) 109.2 (32.) 123.9 (38.)  
 Trefferlage 0.76 mm links, 0.69 mm hoch  
 Streuwert 2.73, horizontal: 2.56, vertikal: 2.89

Unterschrift des Schützen

Meyton Elektronik



Ergebnis: **381** (400.2)  
 Serien: 94 95 97 95  
 Zähler: 21 19 0 0 0 0 0 0 0 0  
 Innenzehner: 18  
 weiteste: 399 (17), 394 (9), 388 (1)  
 beste Teiler 14.7 (24.) 100.6 (26.) 105.7 (20.)  
 Trefferlage 0.03 mm rechts, 0.59 mm hoch  
 Streuwert 1.79, horizontal: 1.90, vertikal: 1.67

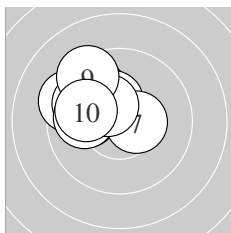
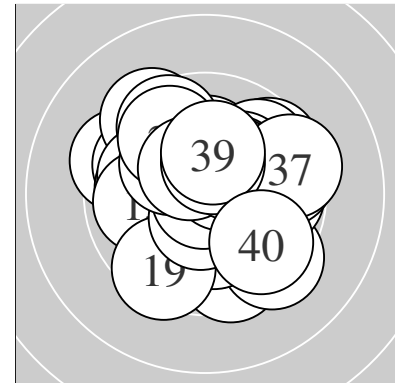

Serie 1:  
 9.4 ↖                      9.8 ↖                      9.9 ↖                      10.4 \*                      10.0 ←  
 9.9 ←                      10.5 \*                      10.4 \*                      9.4 ↖                      9.9 ←  
 beste Teiler 120.2 (7.) 143.4 (8.) 150.2 (4.)  
 Trefferlage 1.76 mm links, 1.19 mm hoch  
 Streuwert 1.19, horizontal: 1.37, vertikal: 0.96

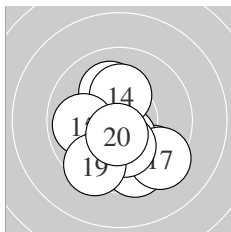

Serie 2:  
 9.5 ↘                      10.1 ↑                      10.4 \*                      10.2 \*                      9.9 ←  
 9.6 ↓                      9.4 ↘                      10.2 \*                      9.5 ↙                      10.5 \*  
 beste Teiler 105.7 (20.) 131.6 (13.) 180.1 (14.)  
 Trefferlage 0.19 mm rechts, 1.25 mm tief  
 Streuwert 1.81, horizontal: 1.69, vertikal: 1.92

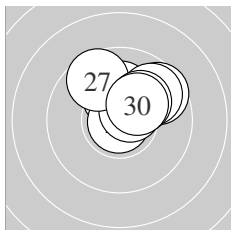

Serie 3:  
 10.2 \*                      10.2 \*                      10.1 ↑                      10.9 \*                      9.6 ↗  
 10.6 \*                      9.6 ↖                      9.8 ↗                      10.2 \*                      10.3 \*  
 beste Teiler 14.7 (24.) 100.6 (26.) 171.3 (30.)  
 Trefferlage 0.62 mm rechts, 1.53 mm hoch  
 Streuwert 1.11, horizontal: 1.33, vertikal: 0.83

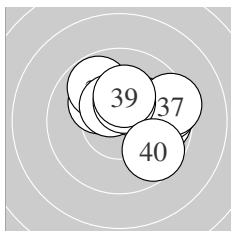

Serie 4:  
 9.8 →                      10.2 \*                      9.8 ↖                      10.4 \*                      10.3 \*  
 9.6 →                      9.4 →                      10.4 \*                      10.2 \*                      9.7 ↘  
 beste Teiler 129.1 (34.) 141.1 (38.) 165.3 (35.)  
 Trefferlage 1.06 mm rechts, 0.89 mm hoch  
 Streuwert 1.64, horizontal: 1.96, vertikal: 1.23

Unterschrift des Schützen

Meyton Elektronik

Ergebnis: **287** (299.9)  
 Serien: 98 99 90  
 Zähler: 26 3 0 0 0 0 0 0 0 0  
 Innenzehner: 23  
 weiteste: 429 (16), 383 (6), 280 (5)  
 beste Teiler 28.0 (10.) 53.1 (17.) 55.9 (18.)  
 Trefferlage 0.75 mm links, 0.06 mm hoch  
 Streuwert 1.16, horizontal: 1.29, vertikal: 1.01

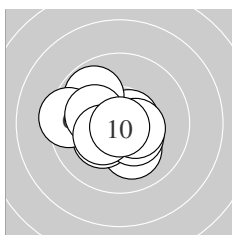
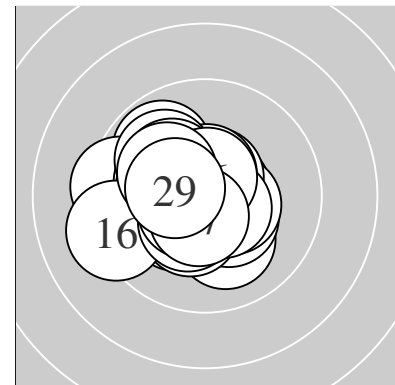

Serie 1:  
 10.7 \*                      10.1 ↘                      10.3 \*                      10.4 \*                      9.8 ↖  
 9.4 ←                      10.5 \*                      10.2 \*                      10.3 \*                      10.8 \*  
 beste Teiler 28.0 (10.) 74.6 (1.) 124.2 (7.)  
 Trefferlage 0.62 mm links, 0.22 mm tief  
 Streuwert 1.42, horizontal: 1.66, vertikal: 1.12

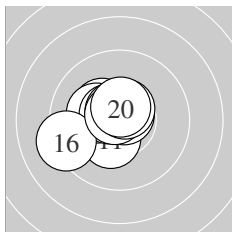

Serie 2:  
 10.3 \*                      10.3 \*                      10.2 \*                      10.6 \*                      10.7 \*  
 9.2 ←                      10.7 \*                      10.7 \*                      10.6 \*                      10.6 \*  
 beste Teiler 53.1 (17.) 55.9 (18.) 74.7 (15.)  
 Trefferlage 0.83 mm links, 0.22 mm hoch  
 Streuwert 1.13, horizontal: 1.30, vertikal: 0.91

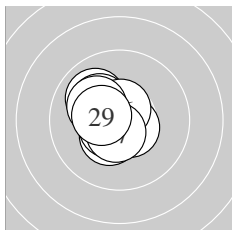

Serie 3:  
 10.0 ↘                      10.6 \*                      10.4 \*                      10.2 \*                      10.6 \*  
 10.6 \*                      10.6 \*                      10.1 ↖                      10.4 \*  
 beste Teiler 82.4 (26.) 93.0 (22.) 95.2 (27.)  
 Trefferlage 0.81 mm links, 0.21 mm hoch  
 Streuwert 0.95, horizontal: 0.87, vertikal: 1.03

Unterschrift des Schützen

Ergebnis: **332** (349.1)  
 Serien: 94 96 95 47  
 Zähler: 19 14 2 0 0 0 0 0 0 0  
 Innenzehner: 15  
 weiteste: 590 (7), 504 (18), 477 (12)  
 beste Teiler 36.1 (15.) 54.0 (29.) 63.0 (33.)  
 Trefferlage 0.56 mm rechts, 0.79 mm hoch  
 Streuwert 1.87, horizontal: 2.13, vertikal: 1.57

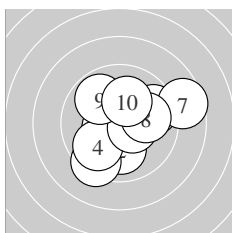
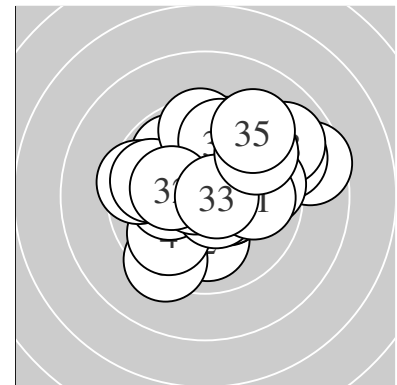

Serie 1:  
 10.5 \* 10.0 ↓ 9.3 ↙ 9.8 ↘ 9.7 →  
 10.5 \* 8.6 → 10.0 → 9.8 ↖ 10.1 ↑  
 beste Teiler 117.9 (1.) 122.4 (6.) 205.5 (10.)  
 Trefferlage 0.60 mm rechts, 0.09 mm tief  
 Streuwert 2.26, horizontal: 2.52, vertikal: 1.96

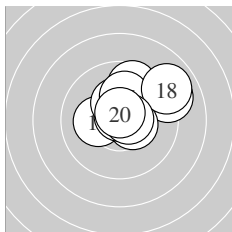

Serie 2:  
 10.2 \* 9.0 ↗ 10.5 \* 9.6 ↗ 10.8 \*  
 10.3 \* 10.1 ↑ 8.9 ↗ 10.6 \* 10.7 \*  
 beste Teiler 36.1 (15.) 66.0 (20.) 80.6 (19.)  
 Trefferlage 0.98 mm rechts, 1.21 mm hoch  
 Streuwert 1.63, horizontal: 1.94, vertikal: 1.26

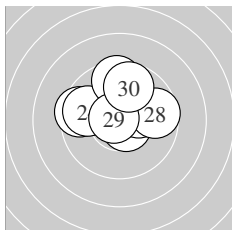

Serie 3:  
 9.5 ← 10.6 \* 10.3 \* 9.8 ← 10.6 \*  
 9.5 ↑ 10.2 \* 9.7 → 10.7 \* 9.7 ↑  
 beste Teiler 54.0 (29.) 81.3 (25.) 85.9 (22.)  
 Trefferlage 0.27 mm links, 1.06 mm hoch  
 Streuwert 1.67, horizontal: 2.01, vertikal: 1.23

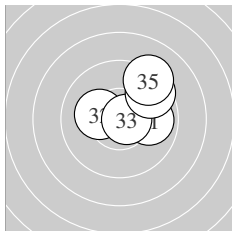

Serie 4:  
 9.9 → 10.2 \* 10.7 \* 9.5 ↗ 9.2 ↗  
 beste Teiler 63.0 (33.) 183.8 (32.) 261.1 (31.)  
 Trefferlage 1.35 mm rechts, 1.22 mm hoch  
 Streuwert 1.79, horizontal: 1.96, vertikal: 1.60

Unterschrift des Schützen

Ergebnis: **384** (402.5)  
 Serien: 96 99 93 96  
 Zähler: 25 14 1 0 0 0 0 0 0 0  
 Innenzehner: 18  
 weiteste: 503 (38), 453 (40), 388 (22)  
 beste Teiler 69.6 (31.) 78.7 (34.) 94.7 (1.)  
 Trefferlage 0.15 mm links, 0.07 mm hoch  
 Streuwert 1.75, horizontal: 1.83, vertikal: 1.67

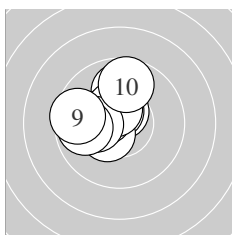
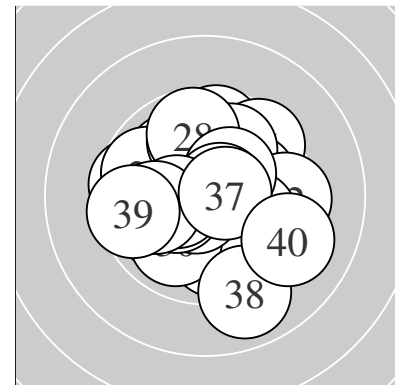

Serie 1:  
 10.6 \*                      10.5 \*                      9.9 ↑                      10.4 \*                      10.4 \*  
 10.5 \*                      10.2 \*                      9.8 ←                      9.6 ←                      9.7 ↑  
 beste Teiler 94.7 (1.) 102.2 (2.) 120.8 (6.)  
 Trefferlage 1.03 mm links, 0.85 mm hoch  
 Streuwert 1.26, horizontal: 1.30, vertikal: 1.23

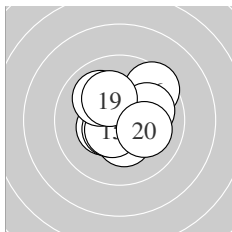

Serie 2:  
 10.3 \*                      10.3 \*                      10.4 \*                      10.5 \*                      10.6 \*  
 9.5 ↗                      10.0 ↘                      10.0 →                      10.2 \*                      10.1 →  
 beste Teiler 96.4 (15.) 106.8 (14.) 138.7 (13.)  
 Trefferlage 0.36 mm rechts, 0.29 mm hoch  
 Streuwert 1.47, horizontal: 1.57, vertikal: 1.35

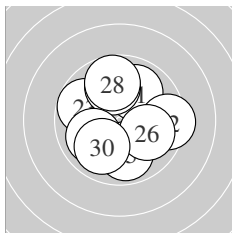

Serie 3:  
 9.9 ↗                      9.4 →                      9.8 ↖                      10.0 ↓                      9.9 ↓  
 10.0 ↘                      9.9 ↑                      9.7 ↑                      10.0 ←                      9.9 ↙  
 beste Teiler 241.4 (24.) 242.5 (26.) 247.5 (29.)  
 Trefferlage 0.08 mm rechts, 0.06 mm tief  
 Streuwert 2.09, horizontal: 2.02, vertikal: 2.16

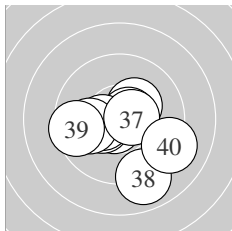

Serie 4:  
 10.7 \*                      10.4 \*                      10.3 \*                      10.6 \*                      10.4 \*  
 10.0 ←                      10.6 \*                      8.9 ↓                      9.5 ←                      9.1 ↘  
 beste Teiler 69.6 (31.) 78.7 (34.) 97.8 (37.)  
 Trefferlage 0.02 mm links, 0.78 mm tief  
 Streuwert 1.93, horizontal: 2.22, vertikal: 1.59

Unterschrift des Schützen

Meyton Elektronik

Ergebnis: **376** (396.8)  
 Serien: 96 93 94 93  
 Zähler: 19 18 3 0 0 0 0 0 0  
 Innenzehner: 15  
 weiteste: 653 (7), 642 (40), 562 (19)  
 beste Teiler 22.1 (36.) 38.0 (22.) 41.0 (30.)  
 Trefferlage 0.15 mm links, 0.43 mm tief  
 Streuwert 2.12, horizontal: 2.44, vertikal: 1.73

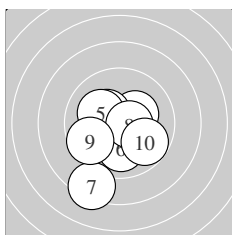
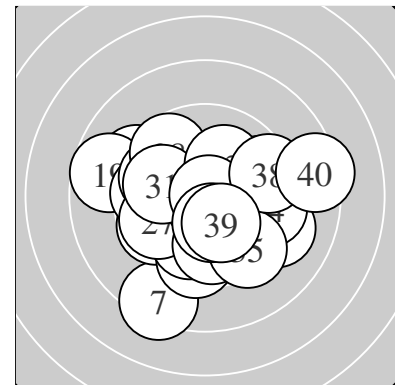

Serie 1:  
 10.3 \*                      10.5 \*                      10.3 \*                      10.3 \*                      10.1 ↖  
 10.0 ↓                      8.3 ↙                      10.6 \*                      9.6 ↖                      9.8 ↘  
 beste Teiler 93.7 (8.) 109.8 (2.) 151.0 (1.)  
 Trefferlage 0.61 mm links, 0.92 mm tief  
 Streuwert 1.96, horizontal: 1.76, vertikal: 2.14

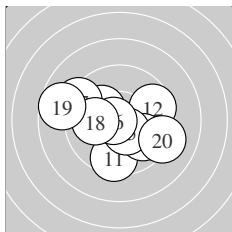

Serie 2:  
 9.5 ↓                      9.6 →                      10.2 \*                      9.9 ↘                      10.5 \*  
 10.7 \*                      9.2 ↖                      10.0 ←                      8.7 ↖                      9.2 ↘  
 beste Teiler 59.4 (16.) 125.1 (15.) 200.8 (13.)  
 Trefferlage 0.44 mm links, 0.29 mm tief  
 Streuwert 2.48, horizontal: 3.05, vertikal: 1.72

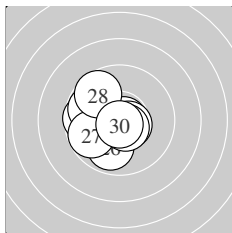

Serie 3:  
 9.7 ←                      10.8 \*                      10.6 \*                      9.9 ↖                      9.8 ↖  
 9.9 ↓                      9.8 ↖                      9.7 ↖                      10.6 \*                      10.8 \*  
 beste Teiler 38.0 (22.) 41.0 (30.) 91.0 (29.)  
 Trefferlage 1.20 mm links, 0.06 mm tief  
 Streuwert 1.48, horizontal: 1.56, vertikal: 1.39

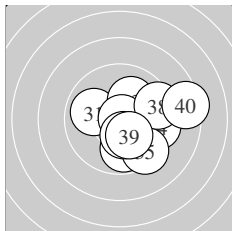

Serie 4:  
 9.9 ↖                      9.8 ↓                      10.1 ↗                      9.5 →                      9.4 ↘  
 10.9 \*                      10.3 \*                      9.4 →                      10.2 \*                      8.4 →  
 beste Teiler 22.1 (36.) 157.6 (37.) 178.8 (39.)  
 Trefferlage 1.64 mm rechts, 0.43 mm tief  
 Streuwert 2.11, horizontal: 2.42, vertikal: 1.74

Unterschrift des Schützen

Meyton Elektronik

Ergebnis: **382** (399.1)  
 Serien: 96 98 94 94  
 Zähler: 23 16 1 0 0 0 0 0 0 0  
 Innenzehner: 14  
 weiteste: 552 (1), 488 (39), 442 (18)  
 beste Teiler 32.5 (27.) 68.4 (2.) 72.6 (13.)  
 Trefferlage 0.54 mm rechts, 0.72 mm hoch  
 Streuwert 1.85, horizontal: 2.11, vertikal: 1.55

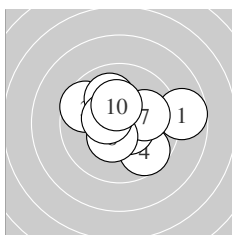
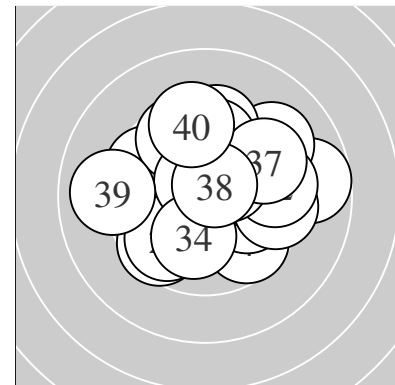

Serie 1:  
 8.7 → 10.7 \* 9.6 ↖ 9.7 ↘ 10.6 \*  
 10.0 ↖ 10.0 → 10.4 \* 10.5 \* 10.3 \*  
 beste Teiler 68.4 (2.) 94.0 (5.) 119.0 (9.)  
 Trefferlage 0.43 mm rechts, 0.36 mm hoch  
 Streuwert 1.92, horizontal: 2.36, vertikal: 1.36

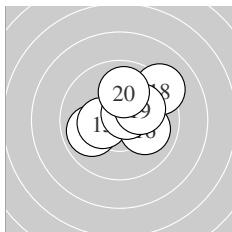

Serie 2:  
 10.1 ↗ 10.1 ↑ 10.7 \* 9.9 ↙ 10.3 \*  
 10.0 → 10.6 \* 9.2 ↗ 10.1 → 10.0 ↑  
 beste Teiler 72.6 (13.) 82.8 (17.) 151.0 (15.)  
 Trefferlage 0.64 mm rechts, 0.93 mm hoch  
 Streuwert 1.53, horizontal: 1.71, vertikal: 1.33

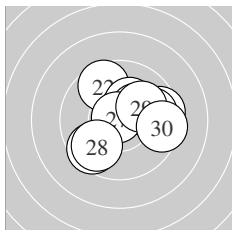

Serie 3:  
 9.6 ↙ 9.6 ↖ 9.5 → 10.3 \* 10.3 \*  
 9.8 → 10.8 \* 9.8 ↙ 10.1 → 9.4 →  
 beste Teiler 32.5 (27.) 173.9 (25.) 174.7 (24.)  
 Trefferlage 0.82 mm rechts, 0.29 mm hoch  
 Streuwert 1.99, horizontal: 2.25, vertikal: 1.68

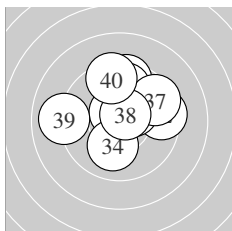

Serie 4:  
 10.6 \* 9.5 → 9.5 ↑ 10.1 ↓ 9.8 ↑  
 10.4 \* 9.5 ↗ 10.6 \* 9.0 ← 9.4 ↑  
 beste Teiler 77.3 (38.) 89.5 (31.) 145.0 (36.)  
 Trefferlage 0.28 mm rechts, 1.29 mm hoch  
 Streuwert 2.08, horizontal: 2.35, vertikal: 1.78

Unterschrift des Schützen

Meyton Elektronik

Ergebnis: **368** (385.7)  
 Serien: 92 92 90 94  
 Zähler: 15 19 5 1 0 0 0 0 0 0  
 Innenzehner: 11  
 weiteste: 856 (3), 699 (36), 599 (21)  
 beste Teiler 23.2 (38.) 49.4 (20.) 69.3 (29.)  
 Trefferlage 0.54 mm rechts, 0.10 mm hoch  
 Streuwert 2.66, horizontal: 3.20, vertikal: 1.97

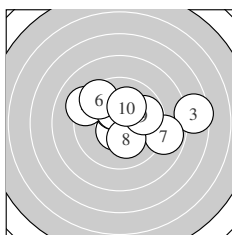
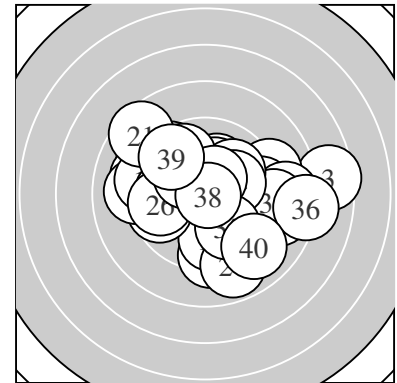

Serie 1:  
 10.6 \*                      10.3 \*                      7.5 →                      9.2 ↖                      10.3 \*  
 9.5 ↘                      8.9 →                      10.2 \*                      9.8 →                      10.1 ↗  
 beste Teiler 99.3 (1.) 153.3 (5.) 161.3 (2.)  
 Trefferlage 1.00 mm rechts, 0.76 mm hoch  
 Streuwert 2.78, horizontal: 3.63, vertikal: 1.53

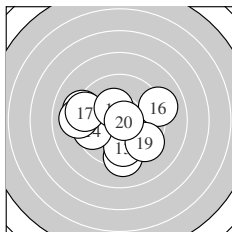

Serie 2:  
 9.2 ↖                      9.3 ↓                      9.7 ↓                      9.6 ↖                      9.1 ←  
 9.1 →                      9.3 ←                      10.3 \*                      9.4 ↘                      10.8 \*  
 beste Teiler 49.4 (20.) 155.2 (18.) 307.8 (13.)  
 Trefferlage 0.81 mm links, 0.56 mm tief  
 Streuwert 2.65, horizontal: 3.13, vertikal: 2.05

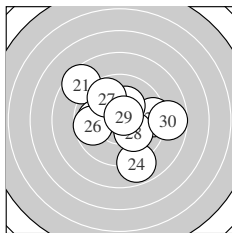

Serie 3:  
 8.6 ↘                      9.4 →                      10.2 \*                      8.9 ↘                      9.9 ←  
 9.7 ←                      9.8 ↘                      10.1 ↘                      10.7 \*                      8.7 →  
 beste Teiler 69.3 (29.) 177.1 (23.) 207.9 (28.)  
 Trefferlage 0.25 mm rechts, 0.24 mm hoch  
 Streuwert 2.80, horizontal: 3.14, vertikal: 2.40

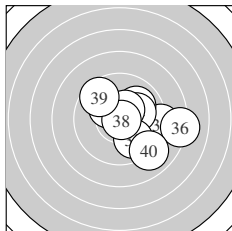

Serie 4:  
 9.1 →                      10.0 ↗                      10.2 \*                      10.1 →                      9.9 ↘  
 8.2 →                      10.5 \*                      10.9 \*                      9.6 ↘                      9.0 ↘  
 beste Teiler 23.2 (38.) 123.3 (37.) 179.6 (33.)  
 Trefferlage 1.76 mm rechts, 0.03 mm tief  
 Streuwert 2.35, horizontal: 2.75, vertikal: 1.86

Unterschrift des Schützen

Meyton Elektronik

Ergebnis: **342** (357.4)  
 Serien: 97 96 94 55  
 Zähler: 19 16 1 0 0 0 0 0 0  
 Innenzehner: 13  
 weiteste: 706 (36), 484 (33), 466 (9)  
 beste Teiler 49.7 (11.) 55.0 (15.) 83.4 (16.)  
 Trefferlage 0.50 mm links, 0.60 mm tief  
 Streuwert 2.02, horizontal: 2.42, vertikal: 1.51

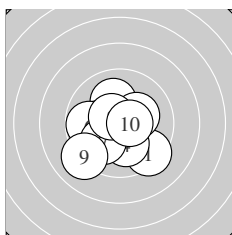
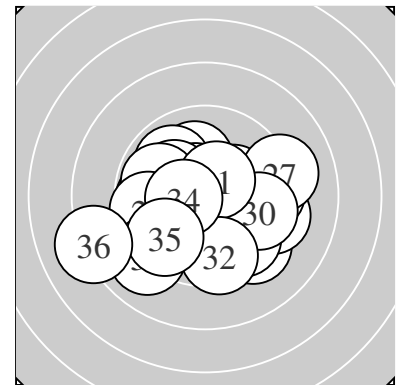

Serie 1:  
 9.4 ↘ 10.1 ↑ 10.2 \* 10.1 ↓ 10.2 \*  
 9.8 ← 10.0 ↙ 10.6 \* 9.1 ↗ 10.6 \*  
 beste Teiler 98.0 (10.) 98.8 (8.) 178.6 (5.)  
 Trefferlage 0.53 mm links, 0.65 mm tief  
 Streuwert 1.87, horizontal: 2.02, vertikal: 1.71

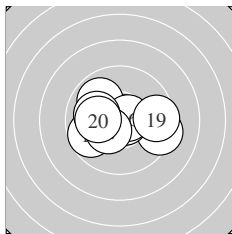

Serie 2:  
 10.8 \* 9.7 ↙ 9.3 → 9.9 ↘ 10.7 \*  
 10.6 \* 10.4 \* 10.0 ← 9.5 → 10.1 ←  
 beste Teiler 49.7 (11.) 55.0 (15.) 83.4 (16.)  
 Trefferlage 0.08 mm links, 0.06 mm tief  
 Streuwert 1.80, horizontal: 2.37, vertikal: 0.94

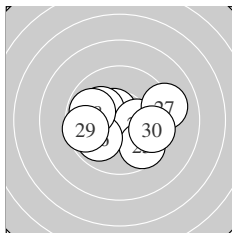

Serie 3:  
 10.4 \* 10.6 \* 10.1 ↘ 10.3 \* 9.6 ↘  
 9.9 ↙ 9.1 → 9.8 ← 9.6 ← 9.7 →  
 beste Teiler 99.2 (22.) 142.0 (21.) 170.2 (24.)  
 Trefferlage 0.00 mm , 0.30 mm tief  
 Streuwert 2.07, horizontal: 2.64, vertikal: 1.26

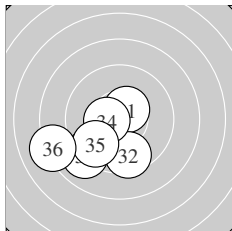

Serie 4:  
 10.5 \* 9.5 ↓ 9.0 ↙ 10.5 \* 9.6 ↙  
 8.1 ←  
 beste Teiler 113.2 (31.) 124.7 (34.) 335.1 (35.)  
 Trefferlage 1.98 mm links, 1.90 mm tief  
 Streuwert 2.34, horizontal: 2.74, vertikal: 1.85

Unterschrift des Schützen

Meyton Elektronik



Ergebnis: **395** (411.9)  
 Serien: 98 97 100 100  
 Zähler: 35 5 0 0 0 0 0 0 0 0  
 Innenzehner: 29  
 weiteste: 339 (20), 299 (13), 284 (9)  
 beste Teiler 5.0 (21.) 66.8 (7.) 78.5 (14.)  
 Trefferlage 0.30 mm links, 0.30 mm tief  
 Streuwert 1.23, horizontal: 1.25, vertikal: 1.21

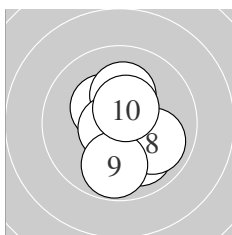
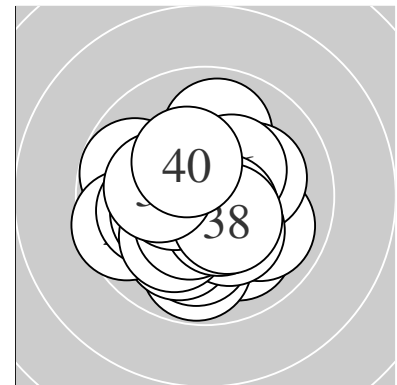

Serie 1:  
 10.0 ↘ 10.5 \* 10.3 \* 10.2 \* 10.3 \*  
 10.5 \* 10.7 \* 9.9 ↘ 9.8 ↓ 10.5 \*  
 beste Teiler 66.8 (7.) 108.4 (10.) 114.0 (2.)  
 Trefferlage 0.40 mm rechts, 0.36 mm tief  
 Streuwert 1.31, horizontal: 0.98, vertikal: 1.56

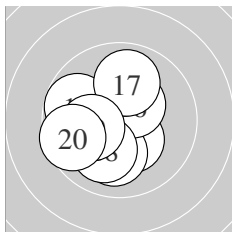

Serie 2:  
 10.5 \* 10.3 \* 9.8 ↖ 10.6 \* 10.1 ↓  
 10.4 \* 9.9 ↑ 10.1 ↓ 10.2 \* 9.6 ↖  
 beste Teiler 78.5 (14.) 115.3 (11.) 135.5 (16.)  
 Trefferlage 0.73 mm links, 0.43 mm tief  
 Streuwert 1.49, horizontal: 1.48, vertikal: 1.49

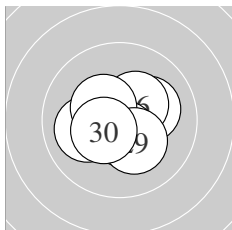

Serie 3:  
 10.9 \* 10.4 \* 10.1 → 10.5 \* 10.0 ←  
 10.4 \* 10.6 \* 10.4 \* 10.3 \* 10.4 \*  
 beste Teiler 5.0 (21.) 99.3 (27.) 110.0 (24.)  
 Trefferlage 0.23 mm links, 0.06 mm tief  
 Streuwert 1.09, horizontal: 1.29, vertikal: 0.84

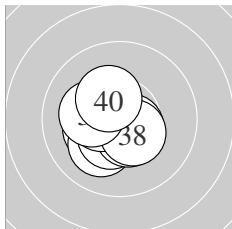

Serie 4:  
 10.3 \* 10.1 ↙ 10.4 \* 10.6 \* 10.4 \*  
 10.5 \* 10.5 \* 10.4 \* 10.2 \* 10.3 \*  
 beste Teiler 91.6 (34.) 115.1 (36.) 122.1 (37.)  
 Trefferlage 0.64 mm links, 0.37 mm tief  
 Streuwert 0.97, horizontal: 1.02, vertikal: 0.91

Unterschrift des Schützen

Ergebnis: **389** (410.5)  
 Serien: 95 98 97 99  
 Zähler: 29 11 0 0 0 0 0 0 0 0  
 Innenzehner: 27  
 weiteste: 382 (9), 328 (37), 326 (30)  
 beste Teiler 28.3 (25.) 37.7 (31.) 51.0 (35.)  
 Trefferlage 0.41 mm rechts, 0.36 mm hoch  
 Streuwert 1.34, horizontal: 1.41, vertikal: 1.26

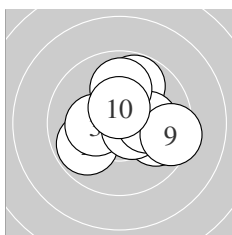
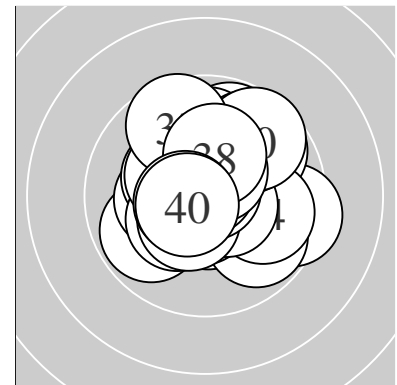

Serie 1:  
 9.9 ↘ 9.8 ↙ 10.3 \* 9.8 ↑ 9.8 ↘  
 10.6 \* 10.2 \* 10.0 ↑ 9.4 → 10.5 \*  
 beste Teiler 98.6 (6.) 113.0 (10.) 172.4 (3.)  
 Trefferlage 0.88 mm rechts, 0.19 mm hoch  
 Streuwert 1.71, horizontal: 1.94, vertikal: 1.45

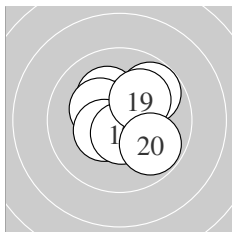

Serie 2:  
 10.2 \* 10.7 \* 10.4 \* 10.7 \* 10.3 \*  
 10.4 \* 10.6 \* 9.8 ↗ 10.1 ↗ 9.8 ↘  
 beste Teiler 68.0 (12.) 68.0 (14.) 95.8 (17.)  
 Trefferlage 0.40 mm rechts, 0.20 mm hoch  
 Streuwert 1.30, horizontal: 1.33, vertikal: 1.27

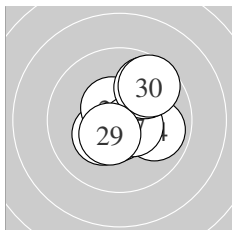

Serie 3:  
 10.3 \* 10.3 \* 10.6 \* 9.9 → 10.8 \*  
 10.5 \* 10.6 \* 9.8 ↗ 10.5 \* 9.6 ↗  
 beste Teiler 28.3 (25.) 77.8 (23.) 100.7 (27.)  
 Trefferlage 0.65 mm rechts, 0.16 mm hoch  
 Streuwert 1.32, horizontal: 1.32, vertikal: 1.31

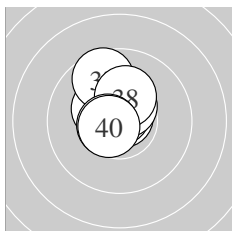

Serie 4:  
 10.8 \* 10.3 \* 10.5 \* 10.5 \* 10.7 \*  
 10.5 \* 9.6 ↘ 10.2 \* 10.6 \* 10.6 \*  
 beste Teiler 37.7 (31.) 51.0 (35.) 87.2 (40.)  
 Trefferlage 0.30 mm links, 0.91 mm hoch  
 Streuwert 0.85, horizontal: 0.67, vertikal: 1.01

Unterschrift des Schützen

Meyton Elektronik

Ergebnis: **372** (391.3)  
 Serien: 100 97 96 79  
 Zähler: 30 8 0 0 0 0 0 0 0 0  
 Innenzehner: 30  
 weiteste: 447 (12), 391 (22), 369 (14)  
 beste Teiler 34.0 (3.) 34.3 (11.) 41.7 (21.)  
 Trefferlage 0.60 mm rechts, 0.36 mm hoch  
 Streuwert 1.31, horizontal: 1.59, vertikal: 0.97

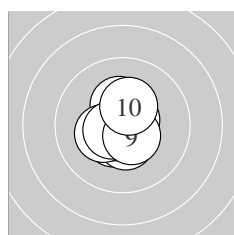
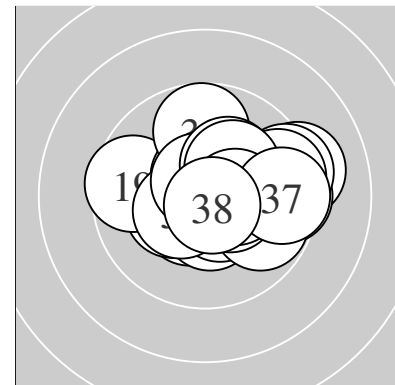

Serie 1:  
 10.6 \* 10.3 \* 10.8 \* 10.5 \* 10.5 \*  
 10.6 \* 10.3 \* 10.6 \* 10.5 \* 10.3 \*  
 beste Teiler 34.0 (3.) 76.0 (1.) 83.2 (6.)  
 Trefferlage 0.20 mm links, 0.14 mm tief  
 Streuwert 0.86, horizontal: 0.72, vertikal: 0.98

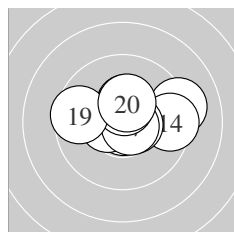

Serie 2:  
 10.8 \* 9.2 → 10.5 \* 9.5 → 10.4 \*  
 10.6 \* 10.7 \* 10.5 \* 9.6 ← 10.3 \*  
 beste Teiler 34.3 (11.) 66.6 (17.) 91.2 (16.)  
 Trefferlage 0.57 mm rechts, 0.49 mm hoch  
 Streuwert 1.64, horizontal: 2.18, vertikal: 0.77

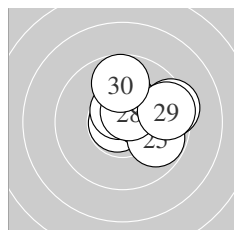

Serie 3:  
 10.8 \* 9.4 → 10.4 \* 10.4 \* 9.8 →  
 10.3 \* 10.6 \* 10.6 \* 9.6 → 9.7 ↑  
 beste Teiler 41.7 (21.) 94.5 (27.) 94.8 (28.)  
 Trefferlage 1.18 mm rechts, 0.85 mm hoch  
 Streuwert 1.34, horizontal: 1.54, vertikal: 1.09

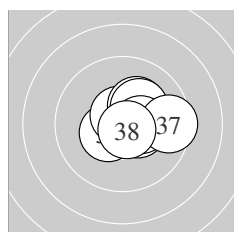

Serie 4:  
 10.4 \* 10.7 \* 10.2 \* 10.5 \* 10.2 \*  
 10.4 \* 9.5 → 10.7 \*  
 beste Teiler 55.0 (38.) 74.4 (32.) 123.0 (34.)  
 Trefferlage 0.92 mm rechts, 0.23 mm hoch  
 Streuwert 1.13, horizontal: 1.39, vertikal: 0.80

Unterschrift des Schützen

Ergebnis: **385** (403.5)  
 Serien: 97 95 98 95  
 Zähler: 27 11 2 0 0 0 0 0 0 0  
 Innenzehner: 22  
 weiteste: 645 (39), 551 (37), 475 (18)  
 beste Teiler 23.0 (23.) 50.2 (22.) 59.9 (10.)  
 Trefferlage 0.32 mm rechts, 0.19 mm hoch  
 Streuwert 1.83, horizontal: 2.24, vertikal: 1.28

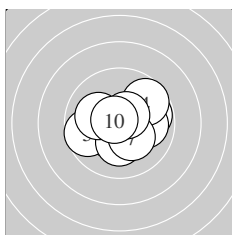
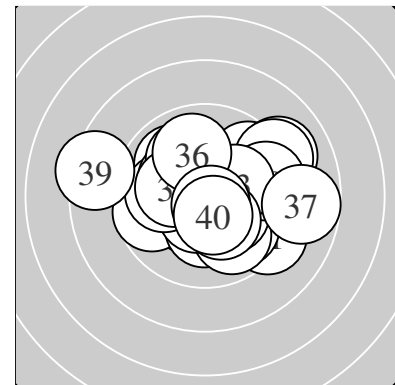

Serie 1:  
 10.4 \* 9.8 → 10.0 → 9.7 ↗ 9.7 ←  
 10.2 \* 10.3 \* 10.1 ← 10.6 \* 10.7 \*  
 beste Teiler 59.9 (10.) 97.3 (9.) 139.0 (1.)  
 Trefferlage 0.28 mm rechts, 0.07 mm tief  
 Streuwert 1.62, horizontal: 1.96, vertikal: 1.19

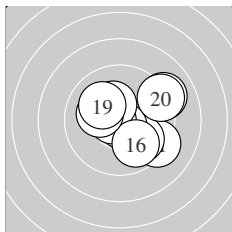

Serie 2:  
 9.3 ↘ 9.9 ↘ 10.7 \* 10.7 \* 10.3 \*  
 9.9 ↘ 10.2 \* 9.1 ↗ 10.1 ↖ 9.2 ↗  
 beste Teiler 67.0 (14.) 69.6 (13.) 159.5 (15.)  
 Trefferlage 1.07 mm rechts, 0.10 mm hoch  
 Streuwert 2.04, horizontal: 2.30, vertikal: 1.75

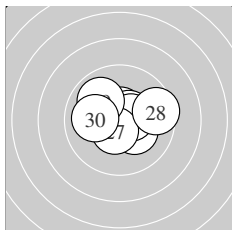

Serie 3:  
 10.3 \* 10.8 \* 10.9 \* 10.6 \* 10.5 \*  
 10.5 \* 10.5 \* 9.5 → 9.9 ↖ 10.0 ←  
 beste Teiler 23.0 (23.) 50.2 (22.) 90.4 (24.)  
 Trefferlage 0.21 mm rechts, 0.28 mm hoch  
 Streuwert 1.32, horizontal: 1.65, vertikal: 0.86

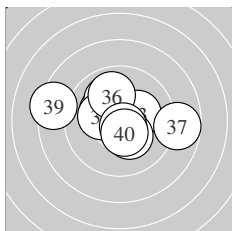

Serie 4:  
 10.2 \* 10.0 ↖ 10.2 \* 10.2 \* 10.3 \*  
 9.9 ↗ 8.7 → 10.7 \* 8.4 ← 10.5 \*  
 beste Teiler 61.5 (38.) 119.2 (40.) 167.2 (35.)  
 Trefferlage 0.25 mm links, 0.46 mm hoch  
 Streuwert 2.31, horizontal: 2.99, vertikal: 1.31

Unterschrift des Schützen

Meyton Elektronik

Ergebnis: **382** (400.3)  
 Serien: 96 94 96 96  
 Zähler: 24 14 2 0 0 0 0 0 0 0  
 Innenzehner: 20  
 weiteste: 629 (22), 626 (6), 466 (35)  
 beste Teiler 36.3 (38.) 59.6 (30.) 68.0 (20.)  
 Trefferlage 0.66 mm rechts, 0.48 mm hoch  
 Streuwert 1.88, horizontal: 2.20, vertikal: 1.49

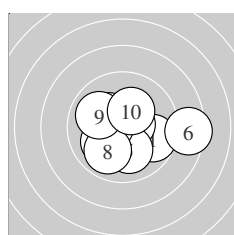
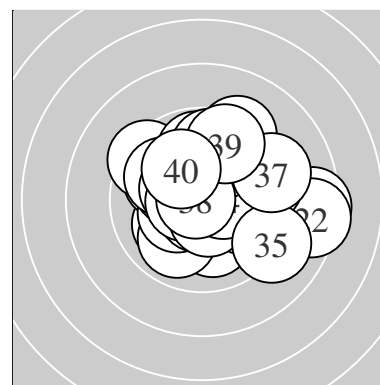

Serie 1:  
 9.7 → 10.3 \* 10.1 ↙ 10.6 \* 10.1 ↓  
 8.4 → 10.5 \* 9.9 ↙ 10.0 ↖ 10.3 \*  
 beste Teiler 88.6 (4.) 121.0 (7.) 163.6 (2.)  
 Trefferlage 0.35 mm rechts, 0.31 mm tief  
 Streuwert 2.07, horizontal: 2.60, vertikal: 1.34

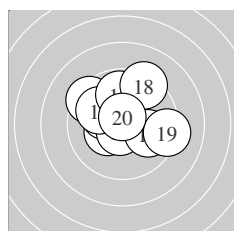

Serie 2:  
 9.4 ↖ 10.3 \* 10.2 \* 10.6 \* 9.9 ↖  
 9.8 ↑ 9.9 → 9.3 ↑ 9.2 → 10.7 \*  
 beste Teiler 68.0 (20.) 76.2 (14.) 159.2 (12.)  
 Trefferlage 0.03 mm links, 0.83 mm hoch  
 Streuwert 2.00, horizontal: 2.29, vertikal: 1.66

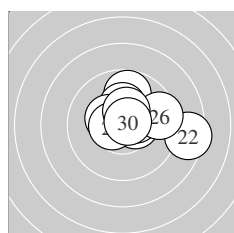

Serie 3:  
 10.5 \* 8.4 → 9.8 ↑ 10.4 \* 10.2 \*  
 9.5 → 10.4 \* 10.6 \* 10.4 \* 10.7 \*  
 beste Teiler 59.6 (30.) 98.5 (28.) 121.0 (21.)  
 Trefferlage 1.11 mm rechts, 0.73 mm hoch  
 Streuwert 1.76, horizontal: 2.23, vertikal: 1.10

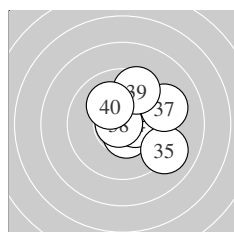

Serie 4:  
 10.2 \* 10.2 \* 10.5 \* 10.5 \* 9.1 ↖  
 9.9 ↑ 9.3 → 10.8 \* 9.6 ↑ 10.1 ↖  
 beste Teiler 36.3 (38.) 104.4 (33.) 120.0 (34.)  
 Trefferlage 1.21 mm rechts, 0.68 mm hoch  
 Streuwert 1.71, horizontal: 1.69, vertikal: 1.72

Unterschrift des Schützen

Meyton Elektronik

Ergebnis: **388** (405.1)  
 Serien: 97 96 96 99  
 Zähler: 28 12 0 0 0 0 0 0 0 0  
 Innenzehner: 23  
 weiteste: 454 (16), 410 (15), 408 (27)  
 beste Teiler 50.8 (40.) 77.5 (19.) 79.6 (29.)  
 Trefferlage 0.46 mm links, 0.31 mm tief  
 Streuwert 1.61, horizontal: 1.69, vertikal: 1.52

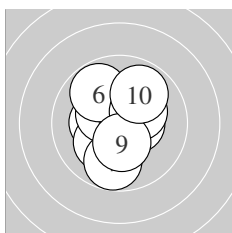
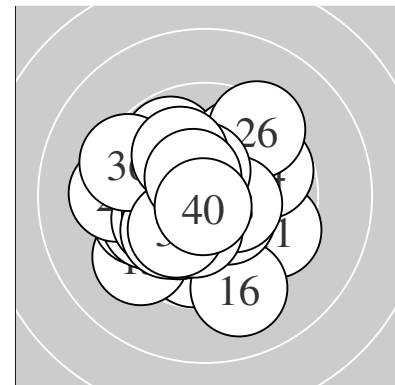

Serie 1:  
 10.3 \*                      10.5 \*                      10.5 \*                      10.2 \*                      10.4 \*  
 9.8 ↘                      9.8 ↓                      10.3 \*                      10.4 \*                      9.9 ↗  
 beste Teiler 112.1 (2.) 125.0 (3.) 137.0 (5.)  
 Trefferlage 0.19 mm links, 0.07 mm tief  
 Streuwert 1.50, horizontal: 1.26, vertikal: 1.70

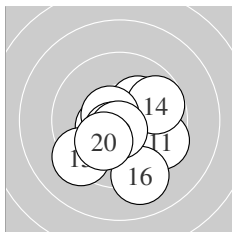

Serie 2:  
 9.5 ↘                      10.4 \*                      10.2 \*                      9.7 ↗                      9.3 ↖  
 9.1 ↓                      10.6 \*                      10.6 \*                      10.6 \*                      10.1 ↖  
 beste Teiler 77.5 (19.) 83.6 (17.) 100.7 (18.)  
 Trefferlage 0.21 mm rechts, 0.96 mm tief  
 Streuwert 1.84, horizontal: 1.95, vertikal: 1.71

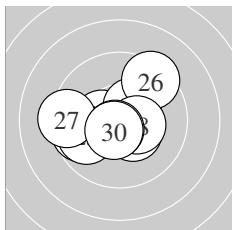

Serie 3:  
 10.4 \*                      10.4 \*                      10.4 \*                      9.7 ↖                      9.8 ↖  
 9.4 ↗                      9.3 ←                      10.4 \*                      10.6 \*                      10.6 \*  
 beste Teiler 79.6 (29.) 90.4 (30.) 138.0 (28.)  
 Trefferlage 0.60 mm links, 0.06 mm tief  
 Streuwert 1.75, horizontal: 2.11, vertikal: 1.29

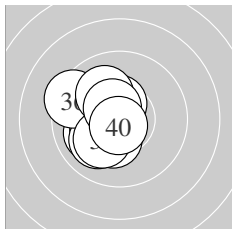

Serie 4:  
 10.3 \*                      10.5 \*                      10.0 ↖                      10.2 \*                      10.0 ↖  
 9.4 ↖                      10.1 ↖                      10.1 ↘                      10.5 \*                      10.8 \*  
 beste Teiler 50.8 (40.) 102.6 (39.) 118.8 (32.)  
 Trefferlage 1.27 mm links, 0.15 mm tief  
 Streuwert 1.23, horizontal: 1.06, vertikal: 1.38

Unterschrift des Schützen

Meyton Elektronik

Ergebnis: **312** (324.6)  
 Serien: 95 93 95 29  
 Zähler: 16 16 1 0 0 0 0 0 0 0  
 Innenzehner: 9  
 weiteste: 562 (11), 485 (19), 430 (12)  
 beste Teiler 66.9 (25.) 101.5 (8.) 104.8 (24.)  
 Trefferlage 0.91 mm rechts, 0.22 mm tief  
 Streuwert 2.06, horizontal: 2.32, vertikal: 1.76

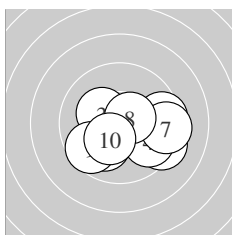
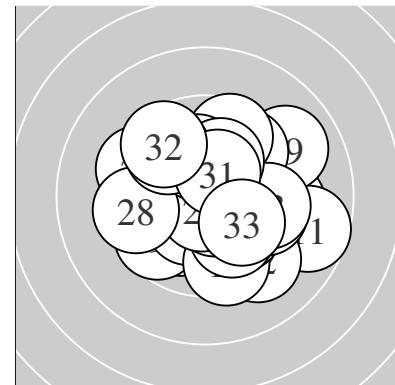

Serie 1:  
 9.3 ↘ 10.3 \* 10.3 \* 9.8 ↘ 9.5 →  
 10.0 ↙ 9.3 → 10.5 \* 9.6 ↖ 10.3 \*  
 beste Teiler 101.5 (8.) 160.3 (10.) 169.0 (2.)  
 Trefferlage 1.02 mm rechts, 0.79 mm tief  
 Streuwert 1.89, horizontal: 2.43, vertikal: 1.11

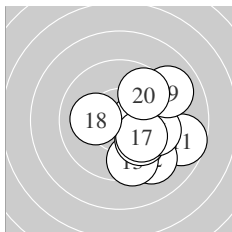

Serie 2:  
 8.7 → 9.2 ↘ 9.5 ↓ 10.0 ↘ 10.4 \*  
 9.7 → 10.0 ↘ 10.1 ← 9.0 ↗ 9.7 ↗  
 beste Teiler 147.0 (15.) 207.2 (18.) 236.2 (17.)  
 Trefferlage 2.17 mm rechts, 0.76 mm tief  
 Streuwert 2.00, horizontal: 1.98, vertikal: 2.03

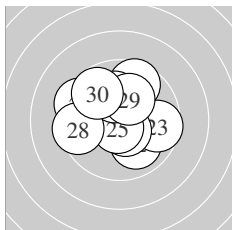

Serie 3:  
 9.5 ↖ 10.0 ↘ 9.6 → 10.5 \* 10.7 \*  
 9.6 ↗ 10.1 ↑ 9.5 ← 10.2 \* 9.7 ↖  
 beste Teiler 66.9 (25.) 104.8 (24.) 198.7 (29.)  
 Trefferlage 0.22 mm links, 0.58 mm hoch  
 Streuwert 1.98, horizontal: 2.20, vertikal: 1.73

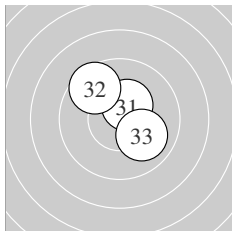

Serie 4:  
 10.4 \* 9.6 ↖ 10.0 ↘  
 beste Teiler 137.3 (31.) 237.0 (33.) 344.3 (32.)  
 Trefferlage 0.14 mm rechts, 0.83 mm hoch  
 Streuwert 2.07, horizontal: 2.08, vertikal: 2.07

Unterschrift des Schützen

Ergebnis: **368** (385.9)  
 Serien: 90 90 93 95  
 Zähler: 16 18 5 0 1 0 0 0 0 0  
 Innenzehner: 12  
 weiteste: 1052 (5), 744 (30), 680 (14)  
 beste Teiler 54.1 (35.) 72.6 (31.) 91.2 (3.)  
 Trefferlage 0.45 mm rechts, 0.45 mm hoch  
 Streuwert 2.73, horizontal: 3.00, vertikal: 2.43

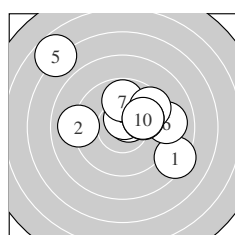
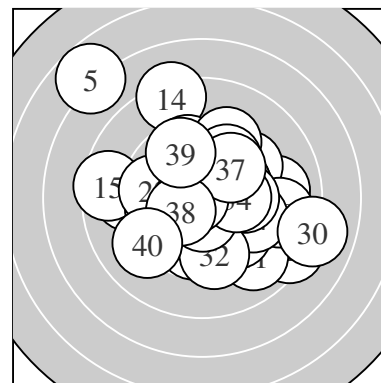

Serie 1:  
 8.4 ↘                      9.1 ←                      10.6 \*                      10.6 \*                      6.7 ↖  
 9.1 →                      9.8 ↑                      9.5 ↗                      10.0 →                      10.0 →  
 beste Teiler 91.2 (3.) 93.9 (4.) 238.6 (9.)  
 Trefferlage 0.66 mm rechts, 1.33 mm hoch  
 Streuwert 3.42, horizontal: 3.98, vertikal: 2.74

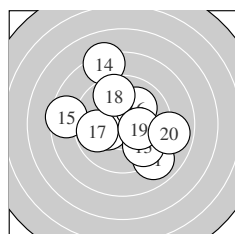

Serie 2:  
 9.0 ↘                      10.3 \*                      9.7 ↘                      8.2 ↑                      8.5 ←  
 10.0 ↗                      9.8 ←                      9.7 ↑                      10.2 \*                      8.9 →  
 beste Teiler 168.5 (12.) 182.4 (19.) 227.1 (16.)  
 Trefferlage 0.04 mm rechts, 0.34 mm hoch  
 Streuwert 3.10, horizontal: 3.29, vertikal: 2.90

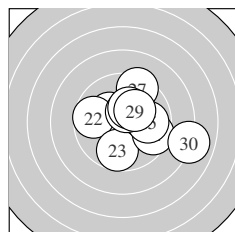

Serie 3:  
 10.3 \*                      9.7 ←                      9.7 ↓                      9.5 ↘                      9.9 →  
 10.5 \*                      9.4 ↑                      10.3 \*                      10.2 \*                      8.0 →  
 beste Teiler 118.9 (26.) 165.7 (28.) 171.1 (21.)  
 Trefferlage 1.19 mm rechts, 0.25 mm hoch  
 Streuwert 2.42, horizontal: 2.82, vertikal: 1.95

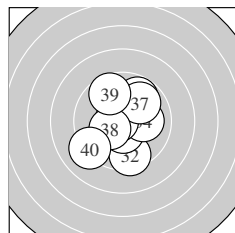

Serie 4:  
 10.7 \*                      9.5 ↓                      10.5 \*                      10.1 →                      10.7 \*  
 9.8 ↗                      9.9 ↗                      10.3 \*                      9.7 ↖                      9.1 ↙  
 beste Teiler 54.1 (35.) 72.6 (31.) 122.1 (33.)  
 Trefferlage 0.10 mm links, 0.11 mm tief  
 Streuwert 1.98, horizontal: 1.78, vertikal: 2.17

Unterschrift des Schützen

Meyton Elektronik



Ergebnis: **396** (416.2)  
 Serien: 98 99 99 100  
 Zähler: 36 4 0 0 0 0 0 0 0 0  
 Innenzehner: 32  
 weiteste: 343 (14), 327 (21), 272 (8)  
 beste Teiler 36.4 (36.) 37.1 (19.) 39.2 (4.)  
 Trefferlage 0.38 mm links, 0.25 mm hoch  
 Streuwert 1.08, horizontal: 1.20, vertikal: 0.94

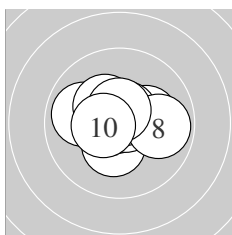
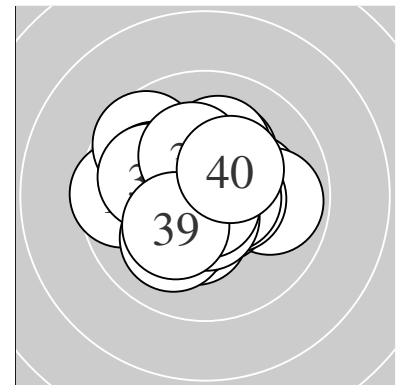

Serie 1:  
 10.3 \*                      10.2 \*                      9.9 ←                      10.8 \*                      10.8 \*  
 10.3 \*                      10.6 \*                      9.9 →                      10.6 \*                      10.5 \*  
 beste Teiler 39.2 (4.) 46.9 (5.) 79.7 (7.)  
 Trefferlage 0.01 mm links, 0.22 mm hoch  
 Streuwert 1.18, horizontal: 1.50, vertikal: 0.75

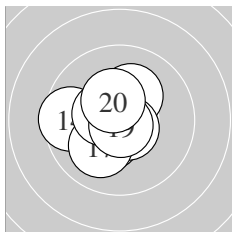

Serie 2:  
 10.2 \*                      10.4 \*                      10.6 \*                      9.6 ←                      10.6 \*  
 10.6 \*                      10.1 ↙                      10.5 \*                      10.8 \*                      10.4 \*  
 beste Teiler 37.1 (19.) 76.4 (13.) 92.6 (16.)  
 Trefferlage 0.71 mm links, 0.05 mm tief  
 Streuwert 1.13, horizontal: 1.17, vertikal: 1.09

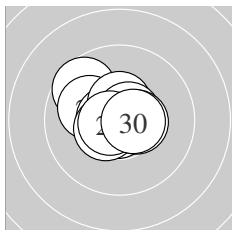

Serie 3:  
 9.6 ↘                      10.0 ↖                      10.6 \*                      10.5 \*                      10.8 \*  
 10.7 \*                      10.5 \*                      10.5 \*                      10.7 \*                      10.6 \*  
 beste Teiler 46.4 (25.) 70.2 (29.) 74.8 (26.)  
 Trefferlage 0.44 mm links, 0.32 mm hoch  
 Streuwert 1.04, horizontal: 1.21, vertikal: 0.85

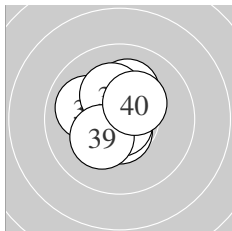

Serie 4:  
 10.4 \*                      10.6 \*                      10.6 \*                      10.7 \*                      10.0 ↖  
 10.8 \*                      10.1 ↑                      10.2 \*                      10.3 \*                      10.3 \*  
 beste Teiler 36.4 (36.) 68.0 (34.) 88.8 (33.)  
 Trefferlage 0.35 mm links, 0.51 mm hoch  
 Streuwert 1.01, horizontal: 0.94, vertikal: 1.08

Unterschrift des Schützen

Ergebnis:	<b>396</b>	(414.7)
Serien:	99 98 100 99	
Zähler:	36 4 0 0 0 0 0 0 0 0	
Innenzehner:	31	
weiteste:	357 (1), 287 (15), 273 (13)	
beste Teiler	36.6 (5.) 42.5 (21.) 53.0 (26.)	
Trefferlage	0.15 mm links, 0.21 mm hoch	
Streuwert	1.16, horizontal: 1.24, vertikal: 1.07	

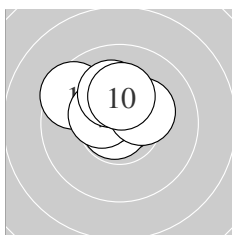
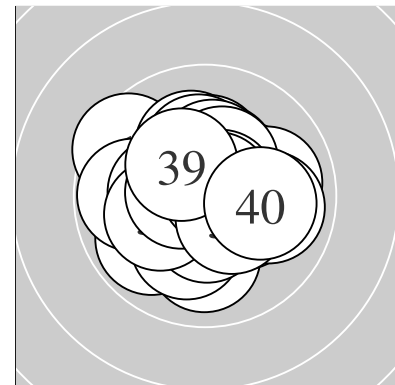

Serie 1:	9.5 ↘	10.7 *	10.6 *	10.6 *	10.8 *
	10.5 *	10.4 *	10.1 ↑	10.3 *	10.2 *
beste Teiler	36.6 (5.)	59.4 (2.)	78.6 (3.)		
Trefferlage	0.41 mm links, 0.93 mm hoch				
Streuwert	0.99, horizontal: 1.21, vertikal: 0.70				

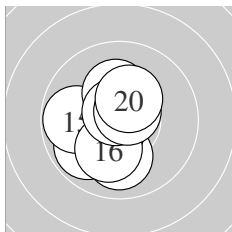

Serie 2:	10.3 *	10.0 ↓	9.9 ↙	10.6 *	9.8 ←
	10.1 ↓	10.2 *	10.7 *	10.6 *	10.3 *
beste Teiler	60.8 (18.)	77.8 (19.)	92.4 (14.)		
Trefferlage	0.64 mm links, 0.37 mm tief				
Streuwert	1.30, horizontal: 1.10, vertikal: 1.47				

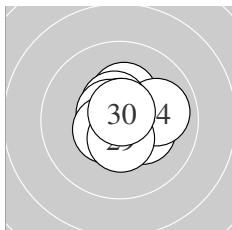

Serie 3:	10.8 *	10.3 *	10.3 *	10.0 →	10.5 *
	10.7 *	10.6 *	10.5 *	10.5 *	10.7 *
beste Teiler	42.5 (21.)	53.0 (26.)	54.5 (30.)		
Trefferlage	0.21 mm rechts, 0.19 mm hoch				
Streuwert	0.94, horizontal: 1.02, vertikal: 0.86				

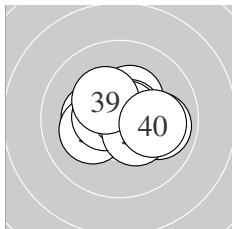

Serie 4:	10.4 *	10.3 *	10.2 *	10.6 *	10.7 *
	9.9 →	10.7 *	10.4 *	10.3 *	10.1 →
beste Teiler	54.6 (37.)	72.9 (35.)	96.0 (34.)		
Trefferlage	0.22 mm rechts, 0.12 mm hoch				
Streuwert	1.20, horizontal: 1.52, vertikal: 0.75				

Unterschrift des Schützen

Ergebnis:	<b>360</b>	(377.2)
Serien:	98 96 97 69	
Zähler:	27 10 0 0 0 0 0 0 0 0	
Innenzehner:	20	
weiteste:	443 (11), 395 (16), 353 (1)	
beste Teiler	15.0 (19.) 43.0 (10.) 49.4 (20.)	
Trefferlage	0.46 mm links, 0.36 mm hoch	
Streuwert	1.52, horizontal: 1.56, vertikal: 1.47	

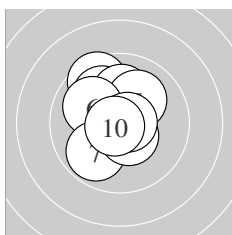
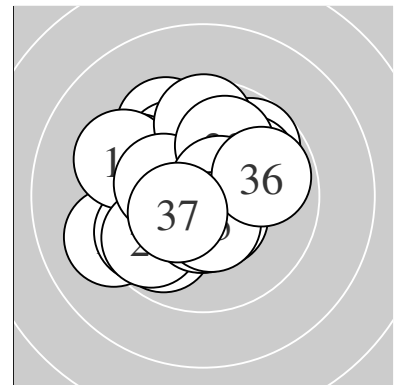

Serie 1:					
9.5 ↘	10.0 ↘	10.1 ↑	10.1 ↑	10.1 ↗	
10.0 ↖	9.9 ↙	10.5 *	10.7 *	10.8 *	
beste Teiler	43.0 (10.)	58.4 (9.)	116.6 (8.)		
Trefferlage	0.42 mm links, 0.92 mm hoch				
Streuwert	1.44, horizontal: 1.19, vertikal: 1.65				

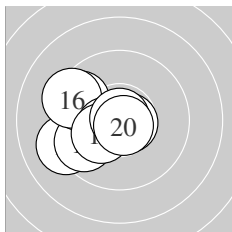

Serie 2:					
9.2 ↙	10.3 *	9.7 ↙	10.7 *	9.6 ↖	
9.4 ↖	10.5 *	10.3 *	10.9 *	10.8 *	
beste Teiler	15.0 (19.)	49.4 (20.)	66.4 (14.)		
Trefferlage	1.60 mm links, 0.31 mm tief				
Streuwert	1.43, horizontal: 1.65, vertikal: 1.16				

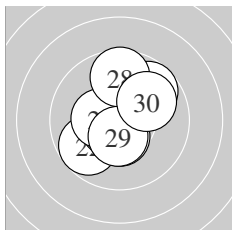

Serie 3:					
10.7 *	9.8 ↙	10.6 *	10.4 *	10.4 *	
10.5 *	9.7 ↗	9.7 ↑	10.5 *	10.0 ↗	
beste Teiler	74.6 (21.)	85.1 (23.)	122.0 (26.)		
Trefferlage	0.07 mm rechts, 0.38 mm hoch				
Streuwert	1.52, horizontal: 1.38, vertikal: 1.65				

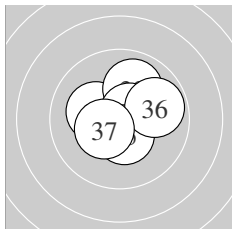

Serie 4:					
10.3 *	10.2 *	10.0 ↑	10.6 *	10.5 *	
9.8 →	10.4 *				
beste Teiler	87.9 (34.)	123.6 (35.)	137.2 (37.)		
Trefferlage	0.37 mm rechts, 0.51 mm hoch				
Streuwert	1.33, horizontal: 1.46, vertikal: 1.18				

Unterschrift des Schützen

Ergebnis: **384** (402.5)  
 Serien: 97 96 96 95  
 Zähler: 25 14 1 0 0 0 0 0 0 0  
 Innenzehner: 19  
 weiteste: 555 (28), 440 (18), 429 (36)  
 beste Teiler 57.2 (7.) 61.0 (38.) 72.0 (26.)  
 Trefferlage 0.76 mm rechts, 0.11 mm hoch  
 Streuwert 1.69, horizontal: 1.85, vertikal: 1.51

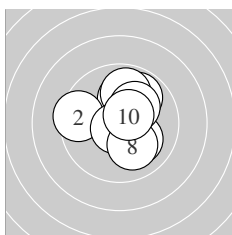
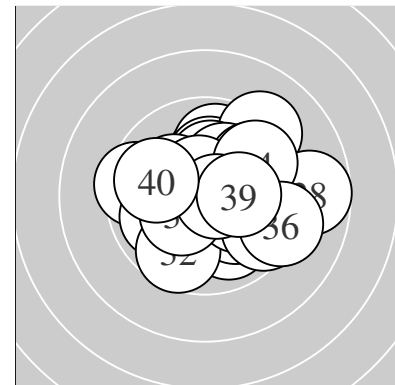

Serie 1:  
 10.1 ↑                      9.5 ←                      9.9 ↗                      10.1 ↘                      9.9 ↑  
 10.7 \*                      10.7 \*                      10.1 ↘                      10.2 \*                      10.5 \*  
 beste Teiler 57.2 (7.) 72.7 (6.) 107.5 (10.)  
 Trefferlage 0.34 mm rechts, 0.54 mm hoch  
 Streuwert 1.57, horizontal: 1.54, vertikal: 1.61

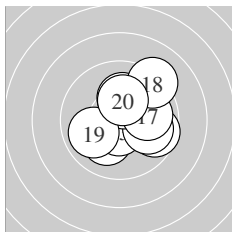

Serie 2:  
 10.1 ↙                      9.6 →                      10.6 \*                      9.9 →                      10.3 \*  
 10.2 \*                      10.0 →                      9.2 ↗                      9.9 ←                      10.2 \*  
 beste Teiler 92.1 (13.) 151.8 (15.) 178.3 (20.)  
 Trefferlage 0.84 mm rechts, 0.34 mm hoch  
 Streuwert 1.77, horizontal: 1.84, vertikal: 1.70

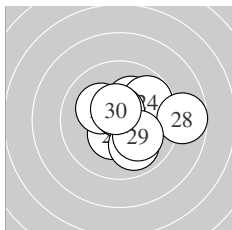

Serie 3:  
 10.4 \*                      10.2 \*                      10.4 \*                      9.8 ↗                      10.2 \*  
 10.7 \*                      9.9 ↘                      8.7 →                      10.1 ↘                      10.5 \*  
 beste Teiler 72.0 (26.) 102.4 (30.) 130.7 (21.)  
 Trefferlage 1.05 mm rechts, 0.17 mm hoch  
 Streuwert 1.70, horizontal: 1.99, vertikal: 1.34

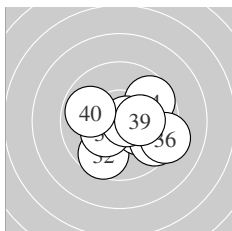

Serie 4:  
 10.5 \*                      9.7 ↙                      10.2 \*                      9.7 ↗                      9.5 ↘  
 9.2 →                      10.3 \*                      10.7 \*                      10.2 \*                      9.9 ←  
 beste Teiler 61.0 (38.) 106.7 (31.) 154.4 (37.)  
 Trefferlage 0.79 mm rechts, 0.59 mm tief  
 Streuwert 1.83, horizontal: 2.22, vertikal: 1.33

Unterschrift des Schützen

Meyton Elektronik

Ergebnis: **266** (279.9)  
 Serien: 95 95 76  
 Zähler: 17 9 1 1 0 0 0 0 0 0  
 Innenzehner: 14  
 weiteste: 802 (17), 609 (25), 464 (4)  
 beste Teiler 30.0 (5.) 37.0 (27.) 56.0 (21.)  
 Trefferlage 1.04 mm rechts, 0.07 mm tief  
 Streuwert 1.99, horizontal: 2.45, vertikal: 1.39

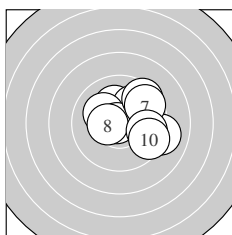
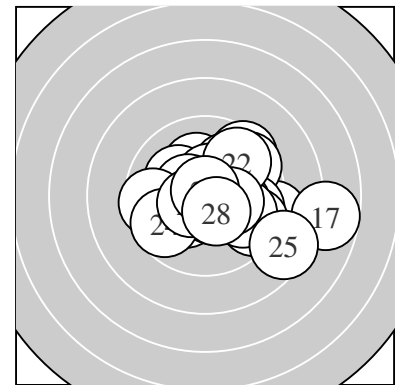

Serie 1:  
 10.2 \*                      10.0 ↗                      10.1 ↘                      9.1 →                      10.8 \*  
 9.5 ↗                      9.6 ↗                      10.4 \*                      9.7 →                      9.5 ↘  
 beste Teiler 30.0 (5.) 131.6 (8.) 198.3 (1.)  
 Trefferlage 1.34 mm rechts, 0.56 mm hoch  
 Streuwert 1.88, horizontal: 2.17, vertikal: 1.54

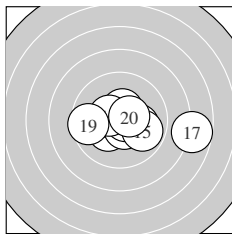

Serie 2:  
 10.3 \*                      10.5 \*                      10.1 →                      10.7 \*                      9.9 →  
 10.5 \*                      7.7 →                      10.5 \*                      9.6 ←                      10.5 \*  
 beste Teiler 63.7 (14.) 107.8 (12.) 112.7 (20.)  
 Trefferlage 0.91 mm rechts, 0.35 mm tief  
 Streuwert 2.21, horizontal: 3.01, vertikal: 0.84

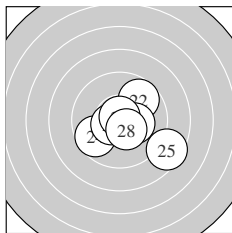

Serie 3:  
 10.7 \*                      9.7 ↗                      10.3 \*                      9.7 ←                      8.5 →  
 10.5 \*                      10.8 \*                      10.5 \*  
 beste Teiler 37.0 (27.) 56.0 (21.) 101.9 (26.)  
 Trefferlage 0.82 mm rechts, 0.54 mm tief  
 Streuwert 1.98, horizontal: 2.30, vertikal: 1.59

Unterschrift des Schützen

Ergebnis: **271** (284.7)  
 Serien: 94 94 83  
 Zähler: 12 15 2 0 0 0 0 0 0 0  
 Innenzehner: 10  
 weiteste: 526 (28), 505 (29), 472 (8)  
 beste Teiler 45.6 (15.) 66.0 (25.) 69.4 (26.)  
 Trefferlage 0.49 mm links, 1.29 mm hoch  
 Streuwert 2.05, horizontal: 2.15, vertikal: 1.94

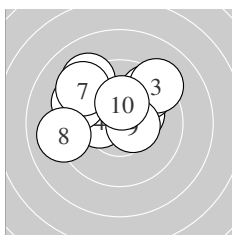
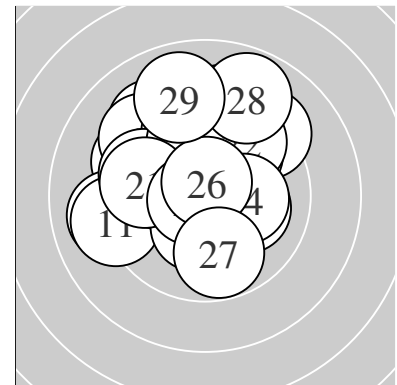

Serie 1:  
 10.3 \* 9.6 ↗ 9.2 ↗ 10.3 \* 9.4 ↘  
 9.2 ↘ 9.3 ↘ 9.1 ← 10.5 \* 10.3 \*  
 beste Teiler 112.4 (9.) 166.0 (4.) 166.3 (1.)  
 Trefferlage 0.72 mm links, 1.52 mm hoch  
 Streuwert 2.18, horizontal: 2.67, vertikal: 1.53

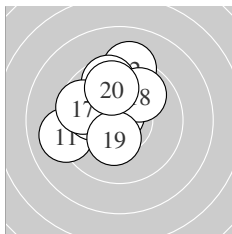

Serie 2:  
 9.1 ← 9.2 ↑ 10.3 \* 9.6 ↑ 10.8 \*  
 10.1 ← 9.7 ← 9.9 ↗ 10.3 \* 9.9 ↑  
 beste Teiler 45.6 (15.) 156.8 (19.) 163.3 (13.)  
 Trefferlage 1.08 mm links, 1.22 mm hoch  
 Streuwert 1.81, horizontal: 1.78, vertikal: 1.84

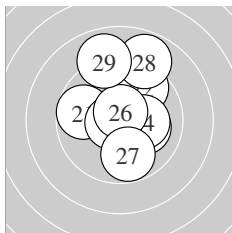

Serie 3:  
 9.7 ← 9.7 ↗ 10.1 → 10.2 \* 10.7 \*  
 10.7 \* 9.8 ↓ 8.8 ↑ 8.9 ↑  
 beste Teiler 66.0 (25.) 69.4 (26.) 192.5 (24.)  
 Trefferlage 0.40 mm rechts, 1.11 mm hoch  
 Streuwert 2.21, horizontal: 1.78, vertikal: 2.57

Unterschrift des Schützen

Ergebnis: **365** (382.5)  
 Serien: 91 90 93 91  
 Zähler: 12 21 7 0 0 0 0 0 0 0  
 Innenzehner: 4  
 weiteste: 686 (39), 592 (5), 550 (11)  
 beste Teiler 52.9 (35.) 89.3 (2.) 161.2 (40.)  
 Trefferlage 0.15 mm links, 0.02 mm tief  
 Streuwert 2.67, horizontal: 3.26, vertikal: 1.90

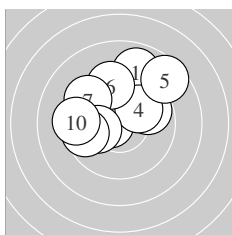
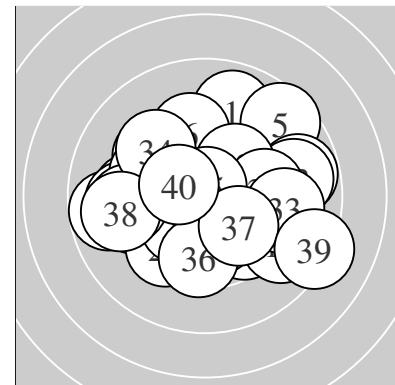

Serie 1:  
 8.9 ↗ 10.6 \* 9.8 ↘ 10.1 ↗ 8.6 ↗  
 9.5 ↑ 9.5 ↘ 10.1 ← 9.6 ← 9.3 ←  
 beste Teiler 89.3 (2.) 213.0 (8.) 225.2 (4.)  
 Trefferlage 0.38 mm links, 1.59 mm hoch  
 Streuwert 2.45, horizontal: 2.81, vertikal: 2.03

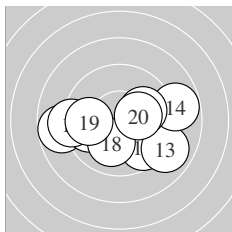

Serie 2:  
 8.8 ← 9.6 ↘ 8.9 ↘ 8.8 → 9.8 ←  
 9.1 ← 10.0 → 10.1 ↓ 9.8 ← 10.2 \*  
 beste Teiler 179.5 (20.) 224.9 (18.) 237.6 (17.)  
 Trefferlage 0.07 mm links, 0.67 mm tief  
 Streuwert 2.82, horizontal: 3.74, vertikal: 1.38

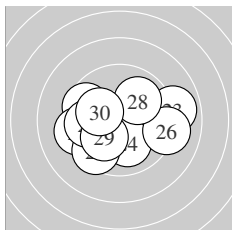

Serie 3:  
 9.6 ↘ 9.3 ← 8.9 → 10.0 ↓ 9.5 ↘  
 9.1 → 9.8 ← 10.0 ↗ 10.1 ↗ 10.1 ↘  
 beste Teiler 203.5 (30.) 214.5 (29.) 226.7 (24.)  
 Trefferlage 0.37 mm links, 0.41 mm tief  
 Streuwert 2.51, horizontal: 3.18, vertikal: 1.57

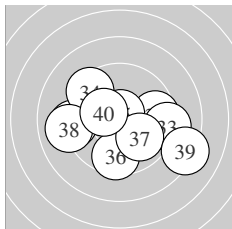

Serie 4:  
 9.2 ← 9.6 → 9.1 → 9.4 ↘ 10.7 \*  
 9.6 ↓ 9.9 ↘ 9.0 ← 8.2 ↘ 10.3 \*  
 beste Teiler 52.9 (35.) 161.2 (40.) 253.5 (37.)  
 Trefferlage 0.22 mm rechts, 0.60 mm tief  
 Streuwert 2.92, horizontal: 3.71, vertikal: 1.81

Unterschrift des Schützen

Meyton Elektronik

Ergebnis: **352** (367.9)  
 Serien: 88 88 89 87  
 Zähler: 12 13 10 5 0 0 0 0 0 0  
 Innenzehner: 7  
 weiteste: 986 (37), 965 (25), 915 (16)  
 beste Teiler 87.3 (18.) 102.4 (22.) 131.7 (11.)  
 Trefferlage 0.42 mm links, 0.63 mm tief  
 Streuwert 3.57, horizontal: 4.16, vertikal: 2.85

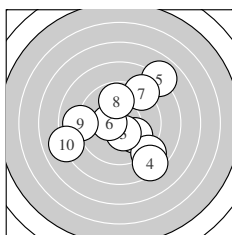
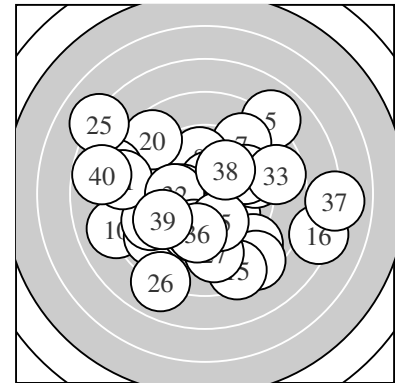

Serie 1:  
 10.0 ↘ 8.8 ↘ 10.4 \* 8.4 ↘ 7.9 ↗  
 10.4 \* 9.0 ↗ 9.8 ↑ 9.0 ← 8.1 ←  
 beste Teiler 132.1 (6.) 133.8 (3.) 248.3 (1.)  
 Trefferlage 0.42 mm rechts, 0.18 mm tief  
 Streuwert 3.65, horizontal: 3.87, vertikal: 3.41

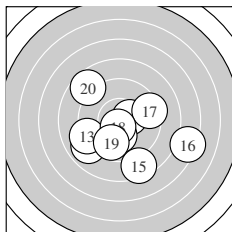

Serie 2:  
 10.4 \* 8.9 ↙ 9.1 ↙ 10.2 \* 8.5 ↘  
 7.3 → 9.4 → 10.6 \* 9.7 ↓ 8.7 ↘  
 beste Teiler 87.3 (18.) 131.7 (11.) 196.0 (14.)  
 Trefferlage 0.27 mm rechts, 1.40 mm tief  
 Streuwert 3.44, horizontal: 4.01, vertikal: 2.76

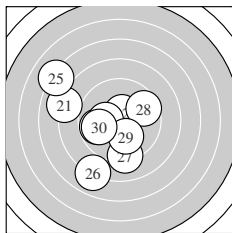

Serie 3:  
 8.1 ← 10.5 \* 9.8 ← 10.2 \* 7.1 ↘  
 8.0 ↓ 9.1 ↓ 9.6 ↗ 10.1 ↓ 9.9 ←  
 beste Teiler 102.4 (22.) 177.0 (24.) 219.6 (29.)  
 Trefferlage 2.07 mm links, 0.51 mm tief  
 Streuwert 3.44, horizontal: 3.50, vertikal: 3.38

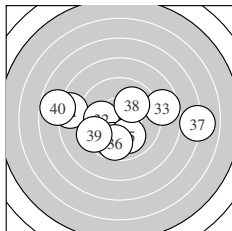

Serie 4:  
 8.4 ← 10.0 ← 8.7 → 9.8 ↓ 10.0 ↘  
 9.7 ↓ 7.0 → 10.0 ↗ 9.5 ↙ 7.8 ←  
 beste Teiler 231.0 (32.) 235.2 (35.) 239.0 (38.)  
 Trefferlage 0.32 mm links, 0.43 mm tief  
 Streuwert 3.93, horizontal: 5.23, vertikal: 1.86

Unterschrift des Schützen

Meyton Elektronik