

**LG Liga – Wertung – offene Klasse**

**StartNr: 1**

StandNr: 103

4. Maerz 2017 18:59

**Peer, Franziska #222**

Angerberg / Angerberg

Ergebnis: **398** (417.5)  
 Serien: 100 100 99 99  
 Zaehler: 38 2 0 0 0 0 0 0 0 0  
 Innenzehner: 30  
 weiteste: 272 (38), 270 (23), 247 (3)  
 beste Teiler 8.5 (29.) 34.8 (26.) 40.3 (35.)  
 Trefferlage 0.11 mm rechts, 0.07 mm hoch  
 Streuwert 1.06, horizontal: 1.10, vertikal: 1.03

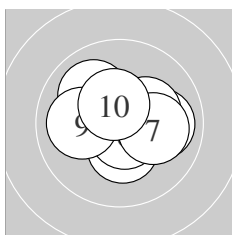
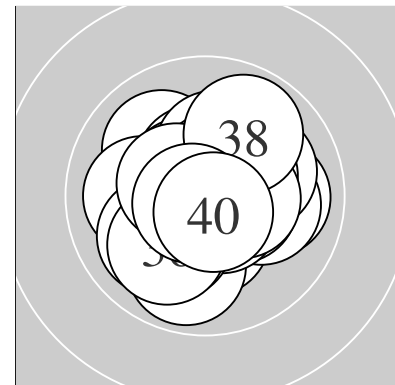

Serie 1:  
 10.6 \*                      10.3 \*                      10.0 →                      10.7 \*                      10.3 \*  
 10.7 \*                      10.1 →                      10.0 ↘                      10.0 ←                      10.5 \*  
 beste Teiler 71.0 (4.) 71.5 (6.) 99.8 (1.)  
 Trefferlage 0.16 mm rechts, 0.23 mm hoch  
 Streuwert 1.29, horizontal: 1.55, vertikal: 0.95

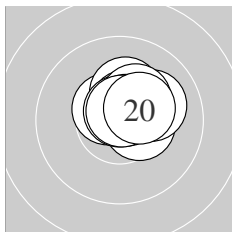

Serie 2:  
 10.4 \*                      10.1 ↗                      10.5 \*                      10.3 \*                      10.6 \*  
 10.7 \*                      10.3 \*                      10.7 \*                      10.7 \*                      10.4 \*  
 beste Teiler 57.0 (16.) 58.6 (19.) 74.3 (18.)  
 Trefferlage 0.59 mm rechts, 0.77 mm hoch  
 Streuwert 0.66, horizontal: 0.77, vertikal: 0.52

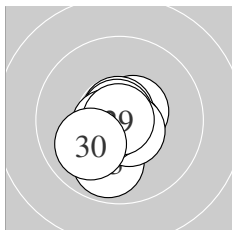

Serie 3:  
 10.6 \*                      10.6 \*                      9.9 ↓                      10.7 \*                      10.8 \*  
 10.8 \*                      10.6 \*                      10.6 \*                      10.9 \*                      10.0 ↙  
 beste Teiler 8.5 (29.) 34.8 (26.) 50.2 (25.)  
 Trefferlage 0.18 mm links, 0.51 mm tief  
 Streuwert 0.89, horizontal: 0.77, vertikal: 0.99

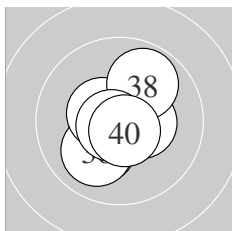

Serie 4:  
 10.5 \*                      10.1 ↙                      10.5 \*                      10.4 \*                      10.8 \*  
 10.0 ↙                      10.5 \*                      9.9 ↗                      10.7 \*                      10.7 \*  
 beste Teiler 40.3 (35.) 56.4 (39.) 68.4 (40.)  
 Trefferlage 0.11 mm links, 0.19 mm tief  
 Streuwert 1.13, horizontal: 1.09, vertikal: 1.17

Unterschrift des Schuetzen

Meyton Elektronik

Ergebnis: **393** (412.8)  
 Serien: 97 98 99 99  
 Zaehler: 33 7 0 0 0 0 0 0 0 0  
 Innenzehner: 29  
 weiteste: 376 (15), 332 (35), 318 (18)  
 beste Teiler 15.2 (36.) 50.7 (13.) 58.6 (22.)  
 Trefferlage 0.41 mm links, 0.09 mm tief  
 Streuwert 1.25, horizontal: 1.28, vertikal: 1.22

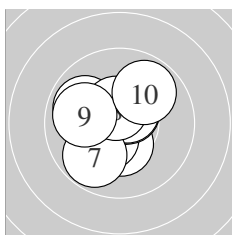
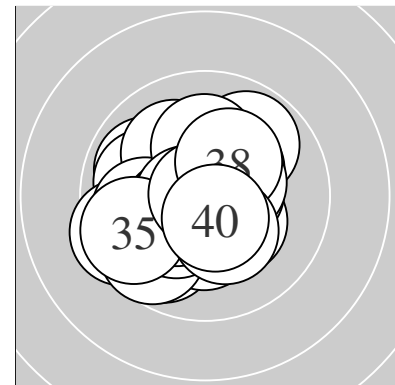

Serie 1:  
 10.4 \* 9.9 ↖ 10.4 \* 10.7 \* 10.6 \*  
 10.5 \* 9.8 ↙ 10.5 \* 10.0 ↖ 9.9 ↗  
 beste Teiler 73.4 (4.) 97.4 (5.) 101.5 (6.)  
 Trefferlage 0.47 mm links, 0.24 mm hoch  
 Streuwert 1.37, horizontal: 1.38, vertikal: 1.36

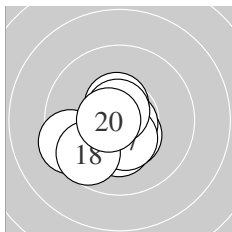

Serie 2:  
 10.1 ↙ 10.5 \* 10.8 \* 10.5 \* 9.4 ↖  
 10.3 \* 10.4 \* 9.7 ↙ 10.7 \* 10.6 \*  
 beste Teiler 50.7 (13.) 63.5 (19.) 77.0 (20.)  
 Trefferlage 0.70 mm links, 0.76 mm tief  
 Streuwert 1.23, horizontal: 1.35, vertikal: 1.09

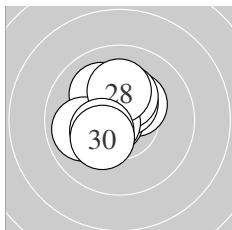

Serie 3:  
 10.3 \* 10.7 \* 10.5 \* 10.3 \* 10.6 \*  
 10.1 ↘ 9.9 ← 10.1 ↑ 10.4 \* 10.3 \*  
 beste Teiler 58.6 (22.) 81.0 (25.) 125.3 (23.)  
 Trefferlage 0.56 mm links, 0.48 mm hoch  
 Streuwert 1.13, horizontal: 1.07, vertikal: 1.18

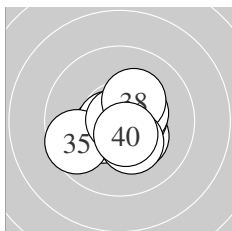

Serie 4:  
 10.3 \* 10.4 \* 10.7 \* 10.5 \* 9.6 ↖  
 10.9 \* 10.4 \* 10.3 \* 10.3 \* 10.5 \*  
 beste Teiler 15.2 (36.) 74.3 (33.) 102.4 (40.)  
 Trefferlage 0.07 mm rechts, 0.34 mm tief  
 Streuwert 1.17, horizontal: 1.36, vertikal: 0.94

Unterschrift des Schuetzen

Meyton Elektronik

Ergebnis: **396** (414.9)  
 Serien: 98 98 100 100  
 Zaehler: 37 2 1 0 0 0 0 0 0 0  
 Innenzehner: 33  
 weiteste: 541 (8), 366 (11), 281 (15)  
 beste Teiler 48.0 (33.) 50.2 (35.) 52.1 (1.)  
 Trefferlage 0.27 mm rechts, 0.35 mm hoch  
 Streuwert 1.19, horizontal: 1.49, vertikal: 0.78

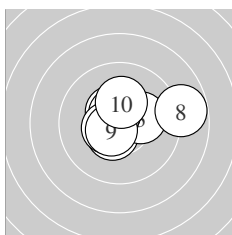
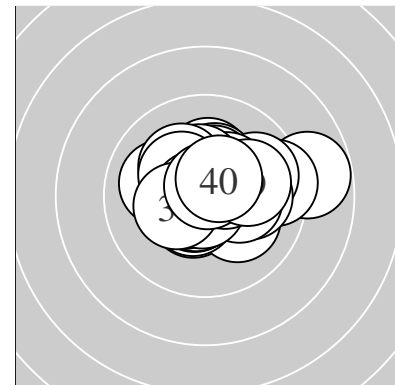

Serie 1:  
 10.7 \*                      10.5 \*                      10.2 \*                      10.6 \*                      10.5 \*  
 10.6 \*                      10.5 \*                      8.8 →                      10.6 \*                      10.2 \*  
 beste Teiler 52.1 (1.) 90.8 (4.) 92.1 (6.)  
 Trefferlage 0.30 mm rechts, 0.44 mm hoch  
 Streuwert 1.49, horizontal: 1.93, vertikal: 0.85

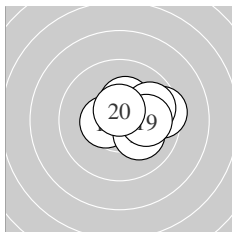

Serie 2:  
 9.5 →                      10.3 \*                      10.7 \*                      10.7 \*                      9.8 →  
 10.5 \*                      10.5 \*                      10.1 ↘                      10.0 →                      10.6 \*  
 beste Teiler 55.7 (13.) 56.0 (14.) 86.0 (20.)  
 Trefferlage 1.10 mm rechts, 0.31 mm hoch  
 Streuwert 1.16, horizontal: 1.44, vertikal: 0.78

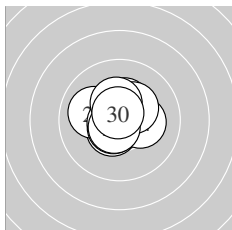

Serie 3:  
 10.5 \*                      10.0 ←                      10.4 \*                      10.2 \*                      10.6 \*  
 10.3 \*                      10.7 \*                      10.6 \*                      10.4 \*                      10.7 \*  
 beste Teiler 60.4 (27.) 64.7 (30.) 77.8 (28.)  
 Trefferlage 0.15 mm links, 0.27 mm hoch  
 Streuwert 0.99, horizontal: 1.09, vertikal: 0.88

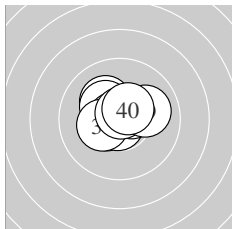

Serie 4:  
 10.2 \*                      10.3 \*                      10.8 \*                      10.5 \*                      10.8 \*  
 10.5 \*                      10.3 \*                      10.7 \*                      10.0 →                      10.5 \*  
 beste Teiler 48.0 (33.) 50.2 (35.) 53.3 (38.)  
 Trefferlage 0.15 mm links, 0.38 mm hoch  
 Streuwert 0.98, horizontal: 1.19, vertikal: 0.71

Unterschrift des Schuetzen

Meyton Elektronik

Ergebnis: **386** (405.7)  
 Serien: 96 96 98 96  
 Zaehler: 27 12 1 0 0 0 0 0 0 0  
 Innenzehner: 23  
 weiteste: 598 (9), 431 (13), 337 (33)  
 beste Teiler 16.2 (16.) 32.3 (6.) 46.8 (5.)  
 Trefferlage 0.22 mm links, 0.20 mm tief  
 Streuwert 1.66, horizontal: 1.89, vertikal: 1.41

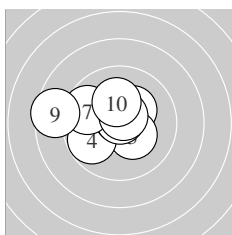
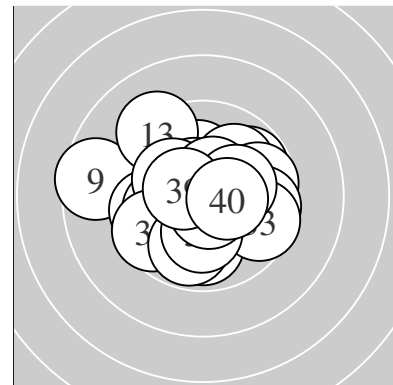

Serie 1:  
 10.3 \* 10.3 \* 10.3 \* 9.8 ↙ 10.8 \*  
 10.8 \* 9.7 ↖ 10.7 \* 8.6 ↖ 10.2 \*  
 beste Teiler 32.3 (6.) 46.8 (5.) 74.7 (8.)  
 Trefferlage 0.91 mm links, 0.57 mm hoch  
 Streuwert 1.76, horizontal: 2.23, vertikal: 1.09

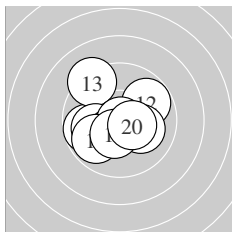

Serie 2:  
 9.7 ↙ 9.8 ↗ 9.2 ↘ 10.0 ↙ 10.4 \*  
 10.9 \* 9.9 ↙ 10.1 ↘ 10.4 \* 10.5 \*  
 beste Teiler 16.2 (16.) 123.8 (20.) 133.4 (15.)  
 Trefferlage 0.53 mm links, 0.19 mm tief  
 Streuwert 1.76, horizontal: 1.92, vertikal: 1.57

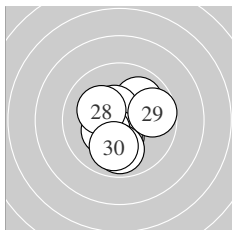

Serie 3:  
 10.3 \* 10.0 ↗ 10.8 \* 10.5 \* 10.4 \*  
 10.3 \* 9.9 ↓ 10.2 \* 9.7 → 10.0 ↓  
 beste Teiler 50.0 (23.) 106.4 (24.) 141.0 (25.)  
 Trefferlage 0.01 mm rechts, 0.46 mm tief  
 Streuwert 1.46, horizontal: 1.38, vertikal: 1.53

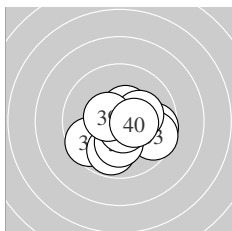

Serie 4:  
 10.5 \* 9.7 → 9.6 ↘ 9.6 ↙ 9.8 ↓  
 10.2 \* 10.7 \* 10.2 \* 10.5 \* 10.4 \*  
 beste Teiler 74.6 (37.) 113.8 (39.) 114.9 (31.)  
 Trefferlage 0.55 mm rechts, 0.73 mm tief  
 Streuwert 1.58, horizontal: 1.86, vertikal: 1.23

Unterschrift des Schuetzen

**LG Liga – Wertung – offene Klasse**

**StartNr: 5**

StandNr: 107

4. Maerz 2017 19:07

**Unterpertinger, Felix #79**

Angerberg / Angerberg

Ergebnis: **386** (403.6)  
 Serien: 96 98 97 95  
 Zaehler: 26 14 0 0 0 0 0 0 0 0  
 Innenzehner: 20  
 weiteste: 437 (27), 421 (31), 410 (24)  
 beste Teiler 20.1 (20.) 29.0 (18.) 41.3 (5.)  
 Trefferlage 0.55 mm links, 0.23 mm hoch  
 Streuwert 1.69, horizontal: 1.72, vertikal: 1.65

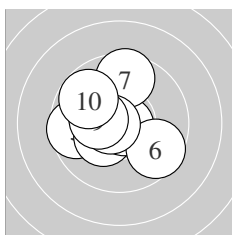
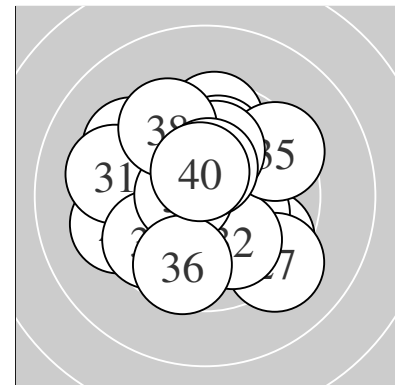

Serie 1:  
 10.6 \* 10.5 \* 9.6 ← 10.3 \* 10.8 \*  
 9.6 ↘ 9.6 ↑ 10.7 \* 10.3 \* 9.8 ↖  
 beste Teiler 41.3 (5.) 68.5 (8.) 81.0 (1.)  
 Trefferlage 0.75 mm links, 0.12 mm hoch  
 Streuwert 1.58, horizontal: 1.66, vertikal: 1.50

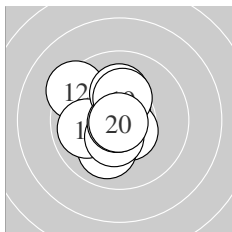

Serie 2:  
 10.6 \* 9.3 ↖ 10.5 \* 10.0 ↓ 9.9 ←  
 10.4 \* 10.1 ↑ 10.8 \* 10.3 \* 10.9 \*  
 beste Teiler 20.1 (20.) 29.0 (18.) 98.4 (11.)  
 Trefferlage 0.65 mm links, 0.16 mm hoch  
 Streuwert 1.39, horizontal: 1.27, vertikal: 1.50

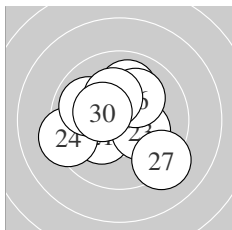

Serie 3:  
 10.3 \* 10.3 \* 10.2 \* 9.3 ← 10.0 ↑  
 10.1 ↗ 9.2 ↘ 9.9 ↖ 10.2 \* 10.4 \*  
 beste Teiler 144.0 (30.) 167.0 (22.) 173.5 (21.)  
 Trefferlage 0.28 mm links, 0.28 mm hoch  
 Streuwert 1.91, horizontal: 2.06, vertikal: 1.74

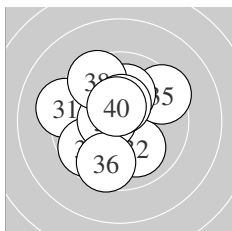

Serie 4:  
 9.3 ↖ 10.0 ↘ 9.7 ↙ 10.6 \* 9.4 ↗  
 9.6 ↓ 10.1 ↑ 9.5 ↘ 10.4 \* 10.5 \*  
 beste Teiler 97.1 (34.) 112.3 (40.) 129.8 (39.)  
 Trefferlage 0.54 mm links, 0.35 mm hoch  
 Streuwert 2.04, horizontal: 2.02, vertikal: 2.06

Unterschrift des Schuetzen

Meyton Elektronik

Ergebnis: **369** (387.1)  
 Serien: 93 93 94 89  
 Zaehler: 16 18 5 1 0 0 0 0 0 0  
 Innenzehner: 9  
 weiteste: 769 (37), 639 (22), 557 (15)  
 beste Teiler 21.9 (7.) 88.3 (9.) 104.2 (13.)  
 Trefferlage 0.43 mm links, 0.53 mm hoch  
 Streuwert 2.51, horizontal: 2.52, vertikal: 2.50

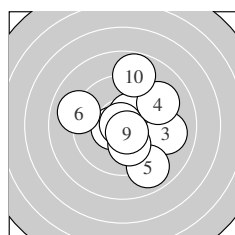
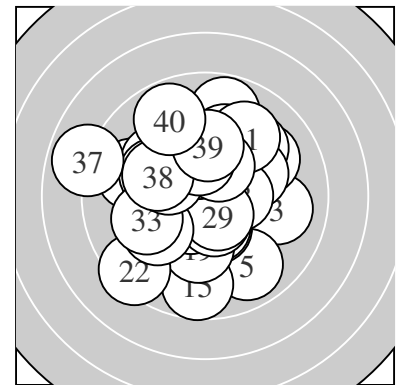

Serie 1:  
 10.4 \*                      10.5 \*                      9.1 →                      9.2 ↗                      8.9 ↘  
 9.0 ←                      10.9 \*                      10.1 ↓                      10.6 \*                      8.8 ↑  
 beste Teiler 21.9 (7.) 88.3 (9.) 111.0 (2.)  
 Trefferlage 0.81 mm rechts, 0.19 mm hoch  
 Streuwert 2.57, horizontal: 2.57, vertikal: 2.56

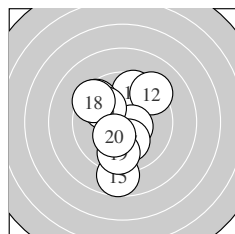

Serie 2:  
 9.6 ↑                      9.3 ↗                      10.5 \*                      9.5 ↘                      8.7 ↓  
 10.0 ↘                      10.1 ↓                      9.5 ↘                      9.7 ↓                      10.3 \*  
 beste Teiler 104.2 (13.) 165.3 (20.) 201.7 (17.)  
 Trefferlage 0.37 mm links, 0.04 mm tief  
 Streuwert 2.47, horizontal: 1.87, vertikal: 2.95

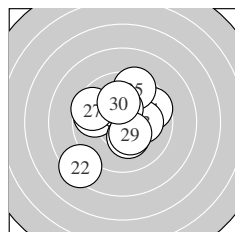

Serie 3:  
 9.6 →                      8.4 ↘                      10.1 →                      9.8 ←                      9.5 ↑  
 10.4 \*                      9.6 ←                      10.3 \*                      10.4 \*                      10.1 ↑  
 beste Teiler 137.3 (26.) 142.5 (29.) 165.4 (28.)  
 Trefferlage 0.33 mm links, 0.30 mm hoch  
 Streuwert 2.35, horizontal: 2.42, vertikal: 2.28

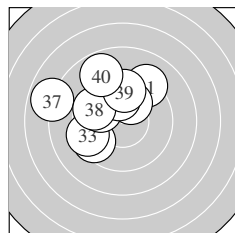

Serie 4:  
 9.2 ↗                      9.5 ↘                      9.4 ←                      9.9 ↘                      10.1 ↑  
 10.0 ↑                      7.9 ←                      9.7 ↘                      9.7 ↑                      8.8 ↘  
 beste Teiler 208.0 (35.) 230.9 (36.) 252.7 (34.)  
 Trefferlage 1.83 mm links, 1.68 mm hoch  
 Streuwert 2.47, horizontal: 2.77, vertikal: 2.14

Unterschrift des Schuetzen

Meyton Elektronik

Ergebnis: **374** (392.1)  
 Serien: 93 92 95 94  
 Zaehler: 18 18 4 0 0 0 0 0 0 0  
 Innenzehner: 15  
 weiteste: 592 (27), 582 (21), 576 (31)  
 beste Teiler 57.3 (34.) 67.0 (14.) 104.1 (13.)  
 Trefferlage 0.01 mm rechts, 0.55 mm tief  
 Streuwert 2.27, horizontal: 2.39, vertikal: 2.15

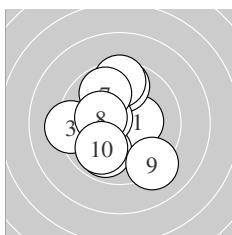
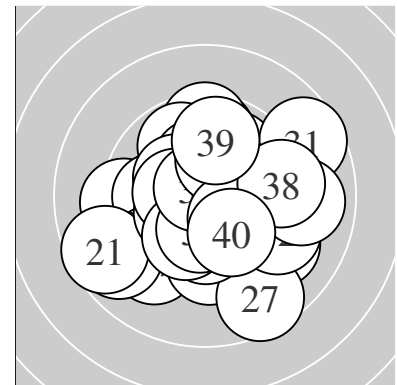

Serie 1:  
 10.3 \* 9.7 ↑ 9.3 ← 9.9 ↙ 10.5 \*  
 9.5 ↑ 9.8 ↘ 10.3 \* 9.2 ↘ 9.9 ↙  
 beste Teiler 121.4 (5.) 152.8 (1.) 167.3 (8.)  
 Trefferlage 0.62 mm links, 0.21 mm hoch  
 Streuwert 2.17, horizontal: 1.91, vertikal: 2.39

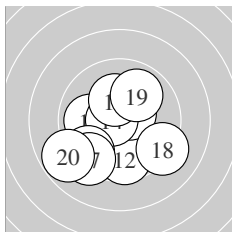

Serie 2:  
 9.9 ← 9.6 ↓ 10.5 \* 10.7 \* 9.4 ↙  
 10.2 \* 9.3 ↙ 9.2 ↘ 9.9 ↗ 8.8 ↙  
 beste Teiler 67.0 (14.) 104.1 (13.) 176.8 (16.)  
 Trefferlage 0.68 mm links, 1.04 mm tief  
 Streuwert 2.28, horizontal: 2.41, vertikal: 2.14

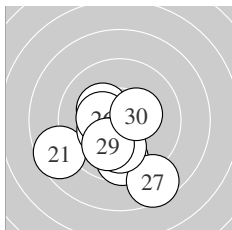

Serie 3:  
 8.6 ↙ 10.5 \* 9.6 ↓ 10.3 \* 10.3 \*  
 10.4 \* 8.6 ↘ 10.0 ↓ 10.0 ↙ 10.4 \*  
 beste Teiler 125.7 (22.) 149.0 (26.) 150.5 (30.)  
 Trefferlage 0.70 mm links, 1.54 mm tief  
 Streuwert 2.02, horizontal: 2.11, vertikal: 1.93

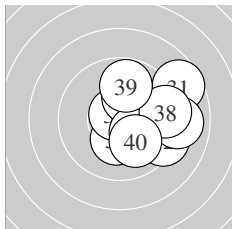

Serie 4:  
 8.6 ↗ 9.3 ↘ 10.3 \* 10.7 \* 10.2 \*  
 10.2 \* 9.0 → 9.4 → 9.8 ↑ 10.0 ↘  
 beste Teiler 57.3 (34.) 170.9 (33.) 176.0 (36.)  
 Trefferlage 2.09 mm rechts, 0.17 mm hoch  
 Streuwert 1.98, horizontal: 2.10, vertikal: 1.84

Unterschrift des Schuetzen

Ergebnis: **373** (390.8)  
 Serien: 98 90 93 92  
 Zaehler: 19 15 6 0 0 0 0 0 0 0  
 Innenzehner: 17  
 weiteste: 741 (15), 678 (25), 574 (17)  
 beste Teiler 30.0 (3.) 49.7 (9.) 79.0 (21.)  
 Trefferlage 0.64 mm links, 0.03 mm hoch  
 Streuwert 2.42, horizontal: 2.75, vertikal: 2.04

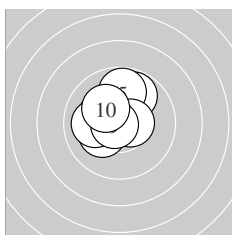
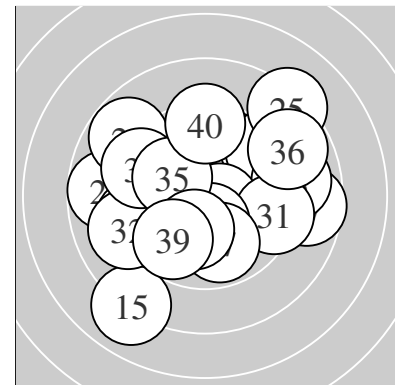

Serie 1:  
 10.2 \*                      10.2 \*                      10.8 \*                      9.8 ↗                      9.8 ↑  
 10.5 \*                      10.3 \*                      10.0 ←                      10.8 \*                      10.2 \*  
 beste Teiler 30.0 (3.) 49.7 (9.) 102.0 (6.)  
 Trefferlage 0.68 mm links, 0.65 mm hoch  
 Streuwert 1.25, horizontal: 1.24, vertikal: 1.25

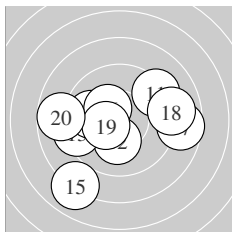

Serie 2:  
 9.3 ↗                      10.2 \*                      9.3 ←                      9.9 ←                      8.0 ↘  
 10.3 \*                      8.7 →                      9.0 →                      10.4 \*                      8.8 ←  
 beste Teiler 138.3 (19.) 156.2 (16.) 192.2 (12.)  
 Trefferlage 0.49 mm links, 0.48 mm tief  
 Streuwert 3.24, horizontal: 3.93, vertikal: 2.35

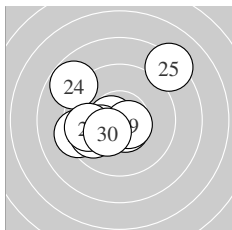

Serie 3:  
 10.6 \*                      9.3 ←                      10.2 \*                      8.8 ↘                      8.2 ↗  
 9.8 ←                      9.8 ←                      10.6 \*                      10.6 \*                      10.3 \*  
 beste Teiler 79.0 (21.) 92.1 (29.) 94.0 (28.)  
 Trefferlage 1.13 mm links, 0.18 mm hoch  
 Streuwert 2.41, horizontal: 2.65, vertikal: 2.15

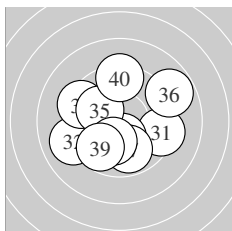

Serie 4:  
 9.3 →                      9.1 ←                      10.3 \*                      9.4 ↘                      10.1 ↘  
 8.8 ↗                      9.9 ↓                      10.2 \*                      9.7 ↗                      9.3 ↑  
 beste Teiler 154.3 (33.) 198.6 (38.) 212.7 (35.)  
 Trefferlage 0.25 mm links, 0.20 mm tief  
 Streuwert 2.64, horizontal: 2.90, vertikal: 2.35

Unterschrift des Schuetzen

Meyton Elektronik



**LG Liga – Wertung – offene Klasse**

**StartNr: 9**

StandNr: 111

4. Maerz 2017 18:55

**Auer, Marie–Theres #70804318**

Roppen / Roppen

Ergebnis: **397** (415.2)  
 Serien: 99 99 100 99  
 Zaehler: 37 3 0 0 0 0 0 0 0 0  
 Innenzehner: 33  
 weiteste: 443 (11), 310 (4), 286 (36)  
 beste Teiler 43.0 (9.) 51.3 (25.) 55.0 (28.)  
 Trefferlage 0.01 mm rechts, 0.08 mm hoch  
 Streuwert 1.18, horizontal: 1.29, vertikal: 1.06

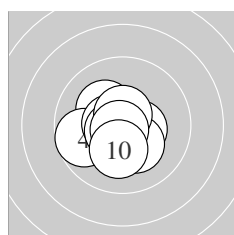
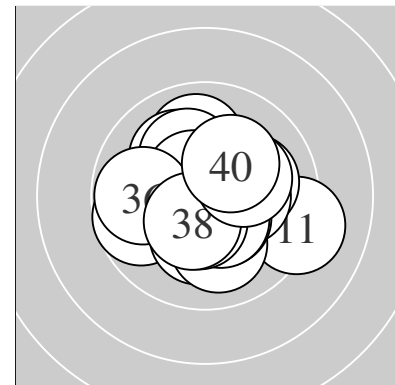

Serie 1:  
 10.5 \*                      10.5 \*                      10.2 \*                      9.7 ←                      10.6 \*  
 10.3 \*                      10.6 \*                      10.6 \*                      10.8 \*                      10.2 \*  
 beste Teiler 43.0 (9.) 81.0 (8.) 81.3 (7.)  
 Trefferlage 0.54 mm links, 0.28 mm tief  
 Streuwert 1.08, horizontal: 1.19, vertikal: 0.96

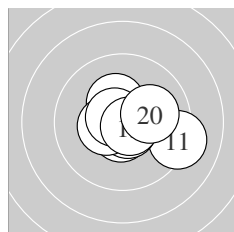

Serie 2:  
 9.2 →                      10.5 \*                      10.6 \*                      10.3 \*                      10.6 \*  
 10.7 \*                      10.4 \*                      10.7 \*                      10.7 \*                      10.1 →  
 beste Teiler 62.2 (19.) 66.6 (16.) 71.8 (18.)  
 Trefferlage 0.49 mm rechts, 0.06 mm tief  
 Streuwert 1.30, horizontal: 1.64, vertikal: 0.81

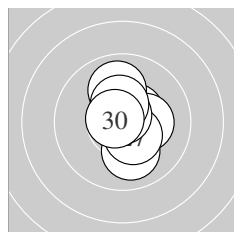

Serie 3:  
 10.6 \*                      10.5 \*                      10.3 \*                      10.0 ↑                      10.7 \*  
 10.0 ↓                      10.4 \*                      10.7 \*                      10.4 \*                      10.7 \*  
 beste Teiler 51.3 (25.) 55.0 (28.) 65.3 (30.)  
 Trefferlage 0.31 mm rechts, 0.34 mm hoch  
 Streuwert 1.03, horizontal: 0.71, vertikal: 1.27

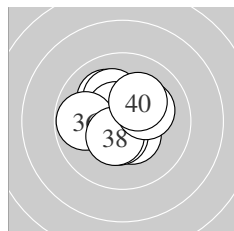

Serie 4:  
 10.7 \*                      10.4 \*                      10.1 ↖                      10.2 \*                      10.6 \*  
 9.8 ←                      10.5 \*                      10.4 \*                      10.2 \*                      10.2 \*  
 beste Teiler 68.4 (31.) 94.3 (35.) 117.3 (37.)  
 Trefferlage 0.20 mm links, 0.35 mm hoch  
 Streuwert 1.26, horizontal: 1.34, vertikal: 1.17

Unterschrift des Schuetzen

Meyton Elektronik

Ergebnis: **398** (415.2)  
 Serien: 100 100 99 99  
 Zaehler: 38 2 0 0 0 0 0 0 0 0  
 Innenzehner: 35  
 weiteste: 290 (38), 254 (30), 247 (32)  
 beste Teiler 51.0 (2.) 52.5 (17.) 66.7 (12.)  
 Trefferlage 0.38 mm rechts, 0.27 mm tief  
 Streuwert 1.05, horizontal: 1.06, vertikal: 1.05

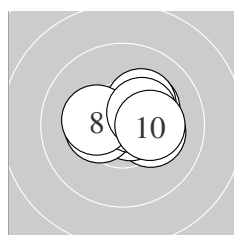
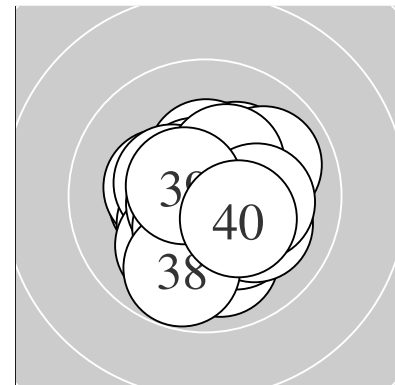

Serie 1:  
 10.2 \*                      10.7 \*                      10.4 \*                      10.5 \*                      10.2 \*  
 10.6 \*                      10.2 \*                      10.3 \*                      10.4 \*                      10.3 \*  
 beste Teiler 51.0 (2.) 83.4 (6.) 115.7 (4.)  
 Trefferlage 0.63 mm rechts, 0.41 mm hoch  
 Streuwert 0.96, horizontal: 1.23, vertikal: 0.59

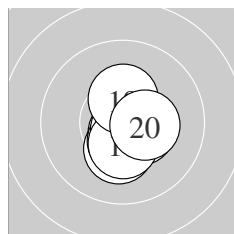

Serie 2:  
 10.3 \*                      10.7 \*                      10.7 \*                      10.5 \*                      10.6 \*  
 10.5 \*                      10.7 \*                      10.4 \*                      10.4 \*                      10.4 \*  
 beste Teiler 52.5 (17.) 66.7 (12.) 67.1 (13.)  
 Trefferlage 0.36 mm rechts, 0.57 mm tief  
 Streuwert 0.73, horizontal: 0.57, vertikal: 0.87

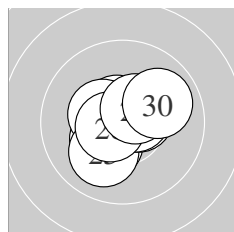

Serie 3:  
 10.3 \*                      10.3 \*                      10.6 \*                      10.4 \*                      10.1 ↙  
 10.5 \*                      10.6 \*                      10.6 \*                      10.5 \*                      9.9 ↘  
 beste Teiler 84.5 (23.) 84.5 (28.) 86.5 (27.)  
 Trefferlage 0.08 mm links, 0.07 mm tief  
 Streuwert 1.14, horizontal: 1.22, vertikal: 1.05

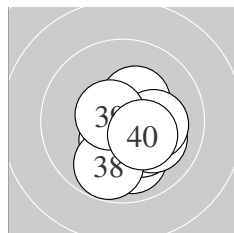

Serie 4:  
 10.5 \*                      10.0 ↓                      10.2 \*                      10.3 \*                      10.1 ↘  
 10.4 \*                      10.2 \*                      9.8 ↓                      10.6 \*                      10.3 \*  
 beste Teiler 89.0 (39.) 111.7 (31.) 134.7 (36.)  
 Trefferlage 0.64 mm rechts, 0.88 mm tief  
 Streuwert 1.13, horizontal: 1.06, vertikal: 1.20

Unterschrift des Schuetzen

Meyton Elektronik

Ergebnis: **387** (408.6)  
 Serien: 99 98 94 96  
 Zaehler: 29 9 2 0 0 0 0 0 0 0  
 Innenzehner: 28  
 weiteste: 568 (25), 510 (40), 455 (21)  
 beste Teiler 8.9 (38.) 13.9 (13.) 59.0 (8.)  
 Trefferlage 0.17 mm rechts, 0.18 mm hoch  
 Streuwert 1.62, horizontal: 1.95, vertikal: 1.19

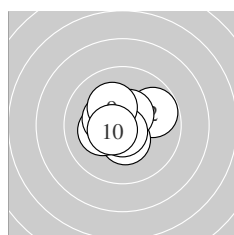
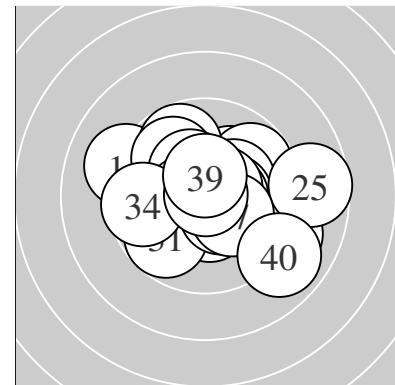

Serie 1:  
 10.7 \*                      9.8 ↗                      10.4 \*                      10.5 \*                      10.4 \*  
 10.2 \*                      10.4 \*                      10.7 \*                      10.2 \*                      10.6 \*  
 beste Teiler 59.0 (8.) 61.0 (1.) 100.7 (10.)  
 Trefferlage 0.27 mm links, 0.25 mm hoch  
 Streuwert 1.12, horizontal: 1.30, vertikal: 0.91

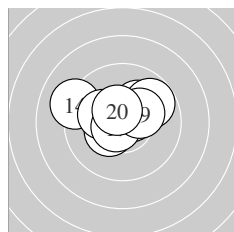

Serie 2:  
 10.4 \*                      10.1 ↗                      10.9 \*                      9.1 ↖                      10.6 \*  
 10.2 \*                      10.7 \*                      9.8 ↗                      10.3 \*                      10.5 \*  
 beste Teiler 13.9 (13.) 71.8 (17.) 89.0 (15.)  
 Trefferlage 0.23 mm links, 0.67 mm hoch  
 Streuwert 1.49, horizontal: 1.93, vertikal: 0.85

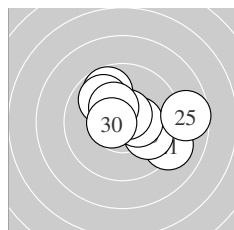

Serie 3:  
 9.1 ↘                      10.7 \*                      9.9 ↘                      10.4 \*                      8.7 →  
 9.7 ↘                      10.6 \*                      9.9 ↘                      10.3 \*                      10.6 \*  
 beste Teiler 63.5 (22.) 78.8 (27.) 98.2 (30.)  
 Trefferlage 0.83 mm rechts, 0.42 mm hoch  
 Streuwert 2.02, horizontal: 2.49, vertikal: 1.39

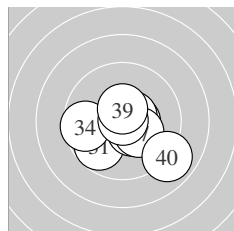

Serie 4:  
 9.8 ↙                      10.5 \*                      10.7 \*                      9.6 ←                      10.5 \*  
 10.6 \*                      10.2 \*                      10.9 \*                      10.5 \*                      8.9 ↘  
 beste Teiler 8.9 (38.) 69.2 (33.) 94.3 (36.)  
 Trefferlage 0.35 mm rechts, 0.62 mm tief  
 Streuwert 1.66, horizontal: 1.99, vertikal: 1.26

Unterschrift des Schuetzen

Meyton Elektronik

Ergebnis: **388** (407.3)  
 Serien: 96 98 98 96  
 Zaehler: 29 10 1 0 0 0 0 0 0 0  
 Innenzehner: 22  
 weiteste: 597 (3), 402 (20), 332 (23)  
 beste Teiler 30.3 (33.) 35.7 (22.) 48.9 (40.)  
 Trefferlage 0.51 mm rechts, 0.05 mm hoch  
 Streuwert 1.54, horizontal: 1.67, vertikal: 1.39

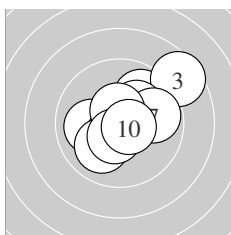
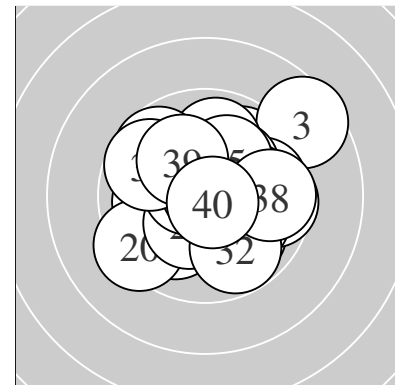

Serie 1:  
 10.0 ← 9.9 ↗ 8.6 ↗ 10.5 \* 10.2 \*  
 10.0 ↘ 9.8 → 10.5 \* 10.5 \* 10.6 \*  
 beste Teiler 81.1 (10.) 105.5 (8.) 114.5 (9.)  
 Trefferlage 0.64 mm rechts, 0.41 mm hoch  
 Streuwert 1.89, horizontal: 2.10, vertikal: 1.66

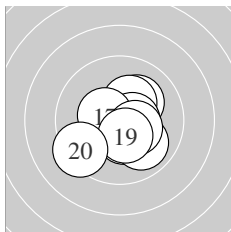

Serie 2:  
 10.1 ↗ 10.3 \* 10.4 \* 10.5 \* 9.9 ↘  
 10.5 \* 10.4 \* 10.4 \* 10.4 \* 9.3 ↙  
 beste Teiler 104.0 (16.) 105.3 (14.) 126.4 (17.)  
 Trefferlage 0.36 mm rechts, 0.43 mm tief  
 Streuwert 1.41, horizontal: 1.50, vertikal: 1.31

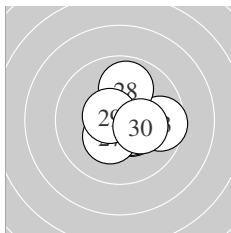

Serie 3:  
 10.5 \* 10.8 \* 9.6 → 10.6 \* 10.6 \*  
 10.5 \* 10.3 \* 9.9 ↑ 10.6 \* 10.2 \*  
 beste Teiler 35.7 (22.) 86.9 (29.) 90.6 (25.)  
 Trefferlage 0.62 mm rechts, 0.15 mm tief  
 Streuwert 1.17, horizontal: 1.25, vertikal: 1.08

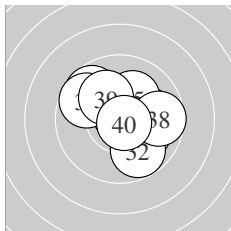

Serie 4:  
 10.1 ↘ 9.8 ↘ 10.8 \* 10.1 → 10.1 ↗  
 9.7 ↘ 9.7 ↘ 9.7 → 10.1 ↘ 10.8 \*  
 beste Teiler 30.3 (33.) 48.9 (40.) 201.1 (35.)  
 Trefferlage 0.42 mm rechts, 0.37 mm hoch  
 Streuwert 1.72, horizontal: 1.95, vertikal: 1.47

Unterschrift des Schuetzen

Meyton Elektronik

Ergebnis: **384** (404.5)  
 Serien: 95 97 97 95  
 Zaehler: 27 10 3 0 0 0 0 0 0 0  
 Innenzehner: 23  
 weiteste: 622 (12), 521 (34), 520 (6)  
 beste Teiler 25.4 (27.) 33.2 (9.) 46.5 (3.)  
 Trefferlage 0.52 mm rechts, 0.12 mm tief  
 Streuwert 1.79, horizontal: 2.20, vertikal: 1.24

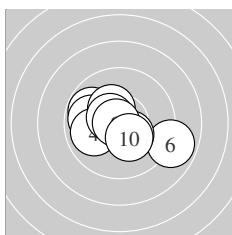
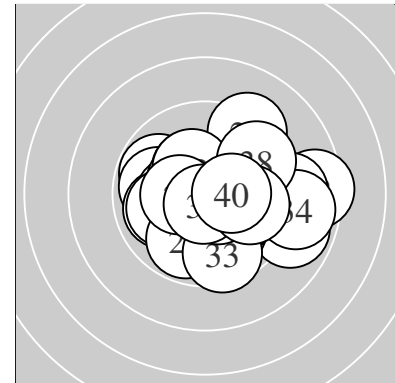

Serie 1:  
 9.8 ↖                      9.9 ←                      10.8 \*                      9.9 ↙                      10.3 \*  
 8.9 ↗                      10.5 \*                      10.4 \*                      10.8 \*                      10.3 \*  
 beste Teiler 33.2 (9.) 46.5 (3.) 106.0 (7.)  
 Trefferlage 0.34 mm links, 0.17 mm tief  
 Streuwert 1.77, horizontal: 2.24, vertikal: 1.10

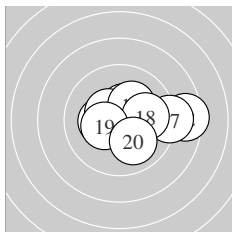

Serie 2:  
 10.7 \*                      8.5 →                      10.4 \*                      10.3 \*                      10.4 \*  
 10.2 \*                      9.1 →                      10.0 →                      10.3 \*                      10.0 ↘  
 beste Teiler 65.1 (11.) 126.1 (13.) 128.1 (15.)  
 Trefferlage 1.13 mm rechts, 0.16 mm hoch  
 Streuwert 2.00, horizontal: 2.66, vertikal: 0.95

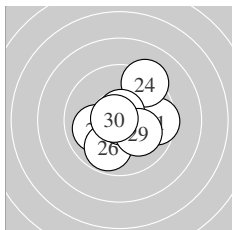

Serie 3:  
 9.6 →                      10.3 \*                      10.7 \*                      9.3 ↗                      10.0 ←  
 9.8 ↘                      10.9 \*                      10.7 \*                      10.1 ↘                      10.7 \*  
 beste Teiler 25.4 (27.) 52.2 (30.) 62.2 (23.)  
 Trefferlage 0.25 mm rechts, 0.20 mm tief  
 Streuwert 1.67, horizontal: 1.77, vertikal: 1.57

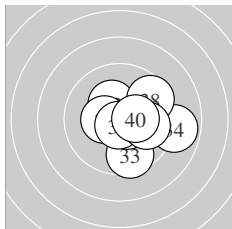

Serie 4:  
 10.5 \*                      10.3 \*                      9.6 ↓                      8.9 →                      10.6 \*  
 10.4 \*                      10.7 \*                      9.6 ↗                      9.9 →                      10.4 \*  
 beste Teiler 58.8 (37.) 95.1 (35.) 105.2 (31.)  
 Trefferlage 1.04 mm rechts, 0.28 mm tief  
 Streuwert 1.76, horizontal: 2.05, vertikal: 1.41

Unterschrift des Schuetzen

Meyton Elektronik

Ergebnis: **377** (396.6)  
 Serien: 93 95 94 95  
 Zaehler: 20 17 3 0 0 0 0 0 0 0  
 Innenzehner: 15  
 weiteste: 595 (2), 542 (32), 508 (18)  
 beste Teiler 14.7 (15.) 43.0 (20.) 46.5 (40.)  
 Trefferlage 0.17 mm links, 0.32 mm hoch  
 Streuwert 2.10, horizontal: 2.69, vertikal: 1.26

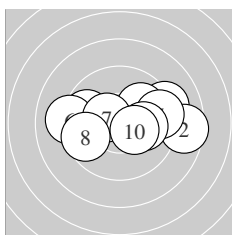
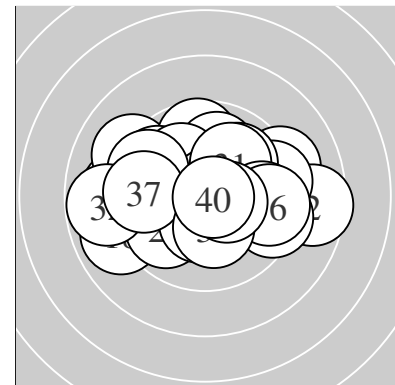

Serie 1:  
 9.2 ↗ 8.6 → 9.7 ↖ 10.0 ↗ 9.4 →  
 9.1 ← 10.4 \* 9.6 ← 10.1 → 10.4 \*  
 beste Teiler 128.0 (7.) 150.3 (10.) 221.7 (9.)  
 Trefferlage 0.73 mm rechts, 0.28 mm hoch  
 Streuwert 2.58, horizontal: 3.53, vertikal: 0.93

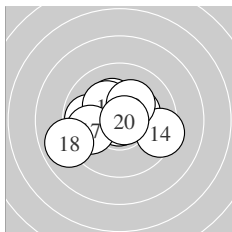

Serie 2:  
 10.3 \* 10.3 \* 9.8 ← 9.4 → 10.9 \*  
 10.2 \* 9.8 ← 8.9 ← 10.2 \* 10.8 \*  
 beste Teiler 14.7 (15.) 43.0 (20.) 164.6 (12.)  
 Trefferlage 0.53 mm links, 0.09 mm hoch  
 Streuwert 1.92, horizontal: 2.42, vertikal: 1.22

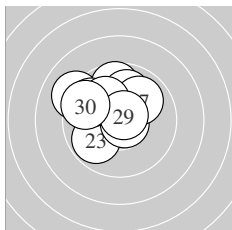

Serie 3:  
 9.1 ↖ 9.7 ↑ 9.8 ↙ 9.7 ↖ 10.7 \*  
 10.0 ↑ 9.9 ↗ 10.1 ↘ 10.7 \* 9.6 ↖  
 beste Teiler 55.7 (25.) 58.8 (29.) 220.2 (28.)  
 Trefferlage 1.04 mm links, 1.27 mm hoch  
 Streuwert 1.68, horizontal: 1.90, vertikal: 1.44

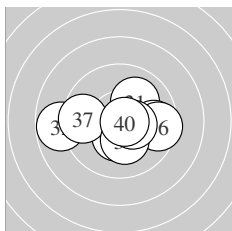

Serie 4:  
 10.0 ↗ 8.8 ← 9.7 → 10.4 \* 10.7 \*  
 9.5 → 9.6 ← 10.2 \* 10.5 \* 10.8 \*  
 beste Teiler 46.5 (40.) 65.5 (35.) 124.4 (39.)  
 Trefferlage 0.14 mm rechts, 0.34 mm tief  
 Streuwert 2.04, horizontal: 2.72, vertikal: 0.95

Unterschrift des Schuetzen

Ergebnis:	<b>380</b>	(397.3)
Serien:	94 94 99 93	
Zaehler:	23 14 3 0 0 0 0 0 0 0	
Innenzehner:	15	
weiteste:	573 (6), 516 (32), 502 (19)	
beste Teiler	60.8 (31.) 72.9 (1.) 94.5 (12.)	
Trefferlage	0.40 mm rechts, 0.43 mm hoch	
Streuwert	2.00, horizontal: 2.22, vertikal: 1.75	

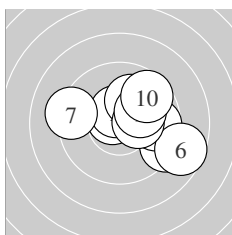
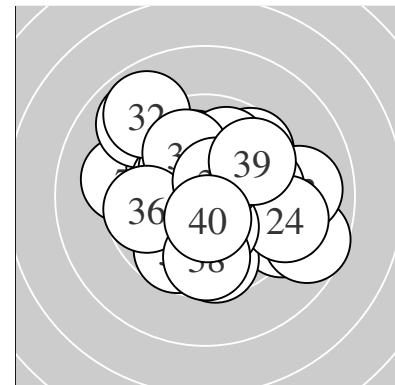

Serie 1:					
	10.7 *	10.5 *	10.1 ↗	9.2 ↘	9.7 →
	8.7 ↘	9.3 ←	10.3 *	10.1 ↗	9.6 ↗
beste Teiler	72.9 (1.)	105.3 (2.)	159.1 (8.)		
Trefferlage	1.39 mm rechts, 0.32 mm hoch				
Streuwert	2.16, horizontal: 2.66, vertikal: 1.49				

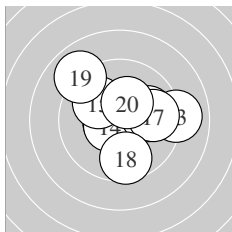

Serie 2:					
	9.9 →	10.6 *	9.0 →	10.6 *	10.0 ↘
	10.0 →	9.8 →	9.6 ↓	8.9 ↘	10.3 *
beste Teiler	94.5 (12.)	98.4 (14.)	164.3 (20.)		
Trefferlage	0.67 mm rechts, 0.46 mm hoch				
Streuwert	2.16, horizontal: 2.49, vertikal: 1.77				

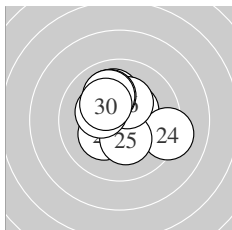

Serie 3:					
	10.1 ↗	10.4 *	10.2 *	9.2 ↘	10.3 *
	10.3 *	10.0 ↘	10.3 *	10.0 ↘	10.2 *
beste Teiler	140.8 (22.)	163.8 (26.)	168.5 (25.)		
Trefferlage	0.00 mm , 0.67 mm hoch				
Streuwert	1.60, horizontal: 1.72, vertikal: 1.47				

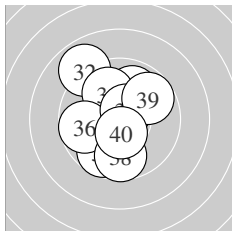

Serie 4:					
	10.7 *	8.9 ↘	9.9 ↗	9.7 ↘	10.0 ↘
	9.7 ←	10.6 *	9.7 ↓	9.7 ↗	10.5 *
beste Teiler	60.8 (31.)	95.8 (37.)	118.8 (40.)		
Trefferlage	0.42 mm links, 0.29 mm hoch				
Streuwert	2.08, horizontal: 1.73, vertikal: 2.38				

Unterschrift des Schuetzen

Ergebnis: **388** (406.4)  
 Serien: 95 99 95 99  
 Zaehler: 29 10 1 0 0 0 0 0 0 0  
 Innenzehner: 23  
 weiteste: 582 (9), 428 (29), 397 (26)  
 beste Teiler 22.0 (13.) 49.8 (16.) 50.0 (21.)  
 Trefferlage 0.48 mm rechts, 0.16 mm hoch  
 Streuwert 1.61, horizontal: 1.83, vertikal: 1.34

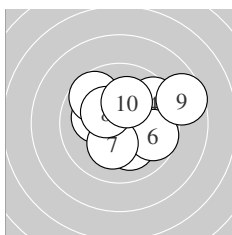
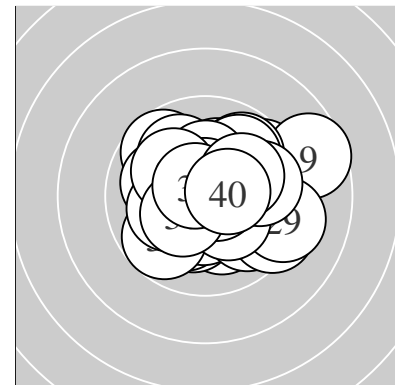

Serie 1:  
 10.4 \*                      10.1 ←                      9.7 ↘                      9.6 ↗                      10.1 ↓  
 9.7 →                      10.2 \*                      10.3 \*                      8.6 →                      10.2 \*  
 beste Teiler 135.7 (1.) 152.7 (8.) 187.5 (7.)  
 Trefferlage 0.67 mm rechts, 0.61 mm hoch  
 Streuwert 2.07, horizontal: 2.45, vertikal: 1.61

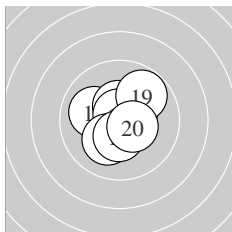

Serie 2:  
 10.5 \*                      10.0 ←                      10.9 \*                      10.4 \*                      10.5 \*  
 10.8 \*                      10.2 \*                      10.4 \*                      9.8 ↗                      10.4 \*  
 beste Teiler 22.0 (13.) 49.8 (16.) 123.6 (15.)  
 Trefferlage 0.01 mm links, 0.10 mm hoch  
 Streuwert 1.21, horizontal: 1.20, vertikal: 1.21

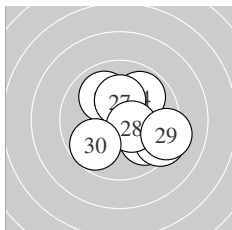

Serie 3:  
 10.8 \*                      9.8 ↘                      10.6 \*                      9.9 ↗                      10.0 ↓  
 9.4 →                      10.3 \*                      10.5 \*                      9.2 →                      9.7 ↗  
 beste Teiler 50.0 (21.) 98.4 (23.) 120.3 (28.)  
 Trefferlage 1.04 mm rechts, 0.22 mm tief  
 Streuwert 1.80, horizontal: 1.97, vertikal: 1.61

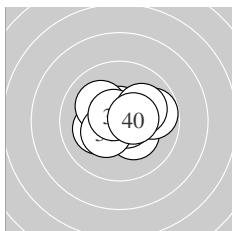

Serie 4:  
 10.3 \*                      10.6 \*                      9.8 →                      10.7 \*                      10.2 \*  
 10.1 ↘                      10.4 \*                      10.7 \*                      10.1 →                      10.5 \*  
 beste Teiler 61.1 (34.) 74.2 (38.) 80.0 (32.)  
 Trefferlage 0.25 mm rechts, 0.17 mm hoch  
 Streuwert 1.27, horizontal: 1.58, vertikal: 0.86

Unterschrift des Schuetzen

Meyton Elektronik



Ergebnis:	<b>382</b>	(399.7)
Serien:	94 95 97 96	
Zaehler:	23 16 1 0 0 0 0 0 0 0	
Innenzehner:	18	
weiteste:	563 (19), 456 (40), 444 (25)	
beste Teiler	45.0 (33.) 46.0 (23.) 78.0 (35.)	
Trefferlage	0.17 mm rechts, 0.52 mm tief	
Streuwert	1.91, horizontal: 2.20, vertikal: 1.55	

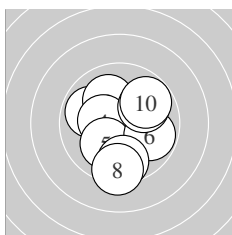
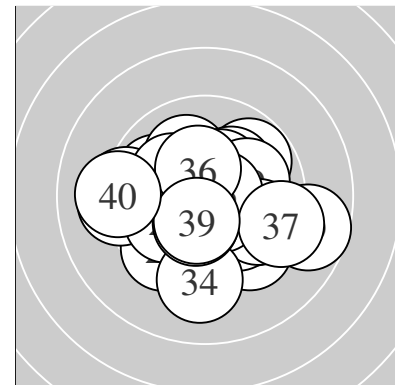

Serie 1:	9.9 ↖	10.6 *	10.1 ↗	10.4 *	10.1 ↘
	9.8 ↗	9.6 ↓	9.3 ↓	9.9 ↖	9.8 ↗
beste Teiler	80.5 (2.) 143.8 (4.) 213.8 (5.)				
Trefferlage	0.02 mm rechts, 0.33 mm tief				
Streuwert	1.95, horizontal: 1.76, vertikal: 2.12				

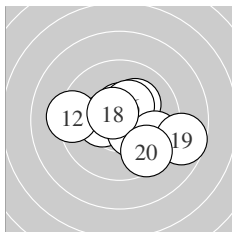

Serie 2:	10.4 *	9.3 ←	10.2 *	10.3 *	10.5 *
	10.4 *	9.6 ↗	10.6 *	8.7 ↗	9.5 ↘
beste Teiler	85.5 (18.) 101.0 (15.) 147.0 (16.)				
Trefferlage	0.79 mm rechts, 0.23 mm tief				
Streuwert	2.09, horizontal: 2.61, vertikal: 1.39				

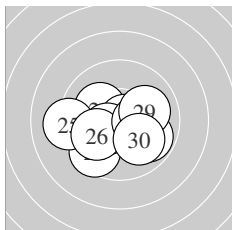

Serie 3:	10.2 *	9.6 ↘	10.8 *	10.4 *	9.2 ←
	10.0 ↖	9.8 ↗	10.3 *	10.0 ↗	10.0 ↘
beste Teiler	46.0 (23.) 130.4 (24.) 157.4 (28.)				
Trefferlage	0.30 mm links, 0.64 mm tief				
Streuwert	1.82, horizontal: 2.30, vertikal: 1.15				

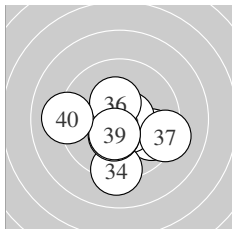

Serie 4:	9.7 ↗	10.5 *	10.8 *	9.2 ↓	10.6 *
	10.4 *	9.3 ↗	10.4 *	10.4 *	9.1 ←
beste Teiler	45.0 (33.) 78.0 (35.) 104.6 (32.)				
Trefferlage	0.17 mm rechts, 0.90 mm tief				
Streuwert	1.94, horizontal: 2.26, vertikal: 1.54				

Unterschrift des Schuetzen

Ergebnis:	<b>391</b>	(409.9)
Serien:	99 98 96 98	
Zaehler:	31 9 0 0 0 0 0 0 0 0	
Innenzehner:	25	
weiteste:	471 (35), 431 (30), 405 (29)	
beste Teiler	37.3 (39.) 42.0 (27.) 42.9 (14.)	
Trefferlage	0.36 mm links, 0.02 mm hoch	
Streuwert	1.48, horizontal: 1.45, vertikal: 1.50	

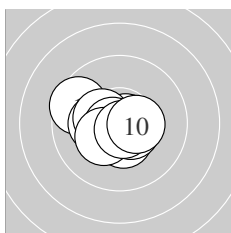
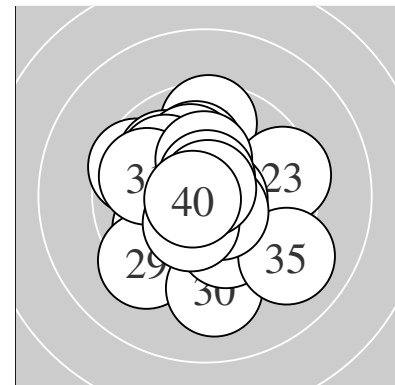

Serie 1:	9.6 ↘	10.3 *	10.8 *	10.4 *	10.7 *
	10.4 *	10.5 *	10.3 *	10.7 *	10.4 *
beste Teiler	46.0 (3.)	55.5 (9.)	59.0 (5.)		
Trefferlage	0.48 mm links, 0.18 mm tief				
Streuwert	1.11, horizontal: 1.38, vertikal: 0.73				

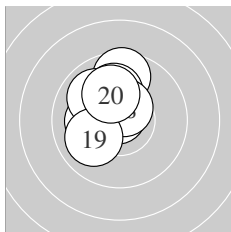

Serie 2:	10.4 *	10.1 ←	10.6 *	10.8 *	9.6 ↑
	10.1 ↑	9.9 ↘	10.5 *	10.0 ↙	10.1 ↖
beste Teiler	42.9 (14.)	77.7 (13.)	102.7 (18.)		
Trefferlage	0.71 mm links, 1.10 mm hoch				
Streuwert	1.14, horizontal: 0.91, vertikal: 1.32				

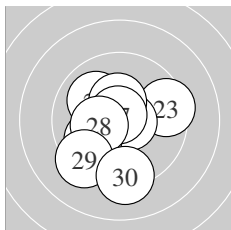

Serie 3:	10.0 ↘	10.7 *	9.5 →	10.7 *	10.4 *
	9.9 ↙	10.8 *	10.3 *	9.3 ↘	9.2 ↓
beste Teiler	42.0 (27.)	67.2 (24.)	75.2 (22.)		
Trefferlage	0.37 mm links, 0.42 mm tief				
Streuwert	1.88, horizontal: 1.82, vertikal: 1.94				

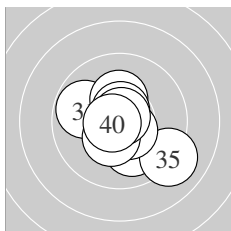

Serie 4:	9.8 ↘	10.6 *	10.3 *	10.1 ↘	9.1 ↘
	10.5 *	10.6 *	10.4 *	10.8 *	10.7 *
beste Teiler	37.3 (39.)	59.9 (40.)	81.3 (37.)		
Trefferlage	0.12 mm rechts, 0.39 mm tief				
Streuwert	1.52, horizontal: 1.63, vertikal: 1.40				

Unterschrift des Schuetzen

Ergebnis:	<b>375</b>	(395.1)
Serien:	94 94 95 92	
Zaehler:	19 18 2 1 0 0 0 0 0 0	
Innenzehner:	15	
weiteste:	789 (40), 537 (35), 516 (18)	
beste Teiler	64.3 (9.) 68.4 (13.) 77.1 (33.)	
Trefferlage	0.62 mm rechts, 0.60 mm hoch	
Streuwert	2.10, horizontal: 2.34, vertikal: 1.82	

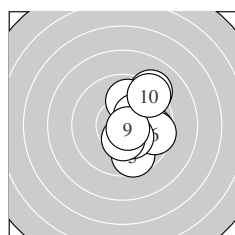
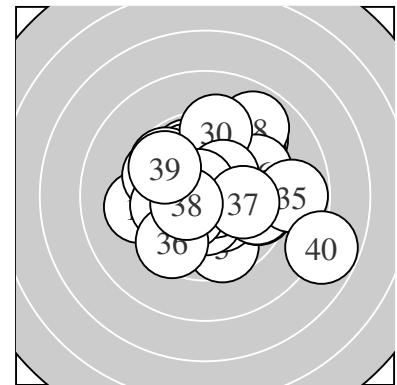

Serie 1:					
	9.7 →	9.2 ↗	9.9 ↑	10.3 *	9.6 ↓
	9.6 →	10.3 *	10.4 *	10.7 *	9.3 ↗
beste Teiler	64.3 (9.)	143.1 (8.)	155.8 (7.)		
Trefferlage	1.63 mm rechts, 0.27 mm hoch				
Streuwert	1.75, horizontal: 1.21, vertikal: 2.16				

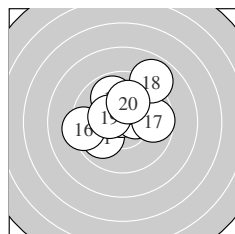

Serie 2:					
	9.9 ↙	10.3 *	10.7 *	10.4 *	9.9 ↘
	9.3 ←	9.7 →	8.9 ↗	10.4 *	10.1 ↑
beste Teiler	68.4 (13.)	143.7 (14.)	146.1 (19.)		
Trefferlage	0.05 mm links, 1.01 mm hoch				
Streuwert	1.95, horizontal: 2.22, vertikal: 1.65				

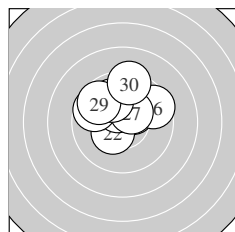

Serie 3:					
	10.4 *	10.4 *	10.5 *	9.8 ↑	9.7 ↖
	9.5 ↗	10.4 *	10.0 ↘	9.7 ↖	9.3 ↑
beste Teiler	125.3 (23.)	136.6 (27.)	145.1 (21.)		
Trefferlage	0.15 mm links, 1.58 mm hoch				
Streuwert	1.59, horizontal: 1.81, vertikal: 1.33				

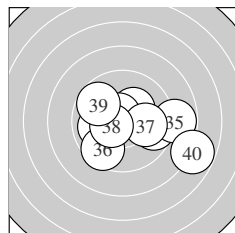

Serie 4:					
	10.3 *	10.0 ←	10.6 *	9.6 →	8.8 →
	9.5 ↙	10.0 →	10.5 *	9.7 ↖	7.8 →
beste Teiler	77.1 (33.)	124.6 (38.)	165.6 (31.)		
Trefferlage	1.07 mm rechts, 0.46 mm tief				
Streuwert	2.65, horizontal: 3.40, vertikal: 1.59				

Unterschrift des Schuetzen

Meyton Elektronik

Ergebnis:	<b>394</b>	(410.9)
Serien:	99	100 98 97
Zaehler:	34 6 0 0 0 0 0 0 0 0	
Innenzehner:	27	
weiteste:	432 (2), 328 (24), 316 (33)	
beste Teiler	21.5 (14.) 31.0 (11.) 47.8 (7.)	
Trefferlage	0.20 mm rechts, 0.20 mm hoch	
Streuwert	1.34, horizontal: 1.43, vertikal: 1.24	

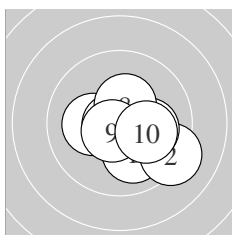
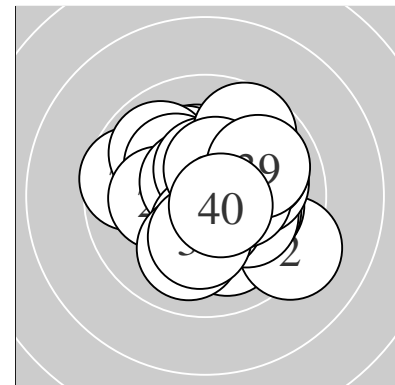

Serie 1:	10.0 ↘	9.2 ↘	10.1 →	10.7 *	10.7 *
	10.2 *	10.8 *	10.4 *	10.6 *	10.1 →
beste Teiler	47.8 (7.)	60.2 (5.)	64.4 (4.)		
Trefferlage	0.68 mm rechts, 0.37 mm tief				
Streuwert	1.36, horizontal: 1.58, vertikal: 1.11				

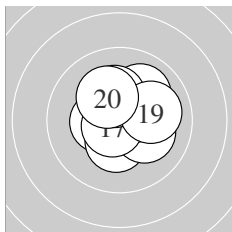

Serie 2:	10.8 *	10.0 ↗	10.4 *	10.9 *	10.3 *
	10.2 *	10.7 *	10.3 *	10.0 →	10.2 *
beste Teiler	21.5 (14.)	31.0 (11.)	66.2 (17.)		
Trefferlage	0.16 mm rechts, 0.29 mm hoch				
Streuwert	1.18, horizontal: 1.22, vertikal: 1.14				

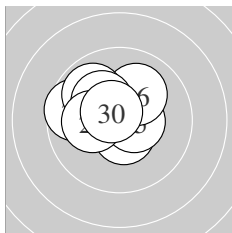

Serie 3:	10.5 *	10.4 *	10.4 *	9.6 ←	10.5 *
	10.1 ↗	9.9 ↘	10.2 *	10.2 *	10.6 *
beste Teiler	84.8 (30.)	101.8 (21.)	105.4 (25.)		
Trefferlage	0.80 mm links, 0.74 mm hoch				
Streuwert	1.17, horizontal: 1.39, vertikal: 0.91				

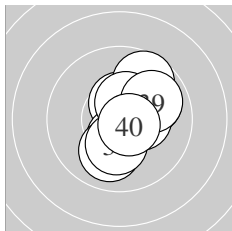

Serie 4:	10.5 *	9.9 ↗	9.7 ↗	10.4 *	10.0 ↓
	10.2 *	10.3 *	10.4 *	9.9 →	10.6 *
beste Teiler	79.4 (40.)	116.0 (31.)	126.2 (38.)		
Trefferlage	0.78 mm rechts, 0.16 mm hoch				
Streuwert	1.36, horizontal: 1.09, vertikal: 1.59				

Unterschrift des Schuetzen

Meyton Elektronik

Ergebnis: **374** (393.1)  
 Serien: 97 93 94 90  
 Zaehler: 18 18 4 0 0 0 0 0 0 0  
 Innenzehner: 14  
 weiteste: 620 (36), 598 (22), 548 (26)  
 beste Teiler 24.0 (5.) 68.1 (9.) 77.0 (28.)  
 Trefferlage 0.15 mm rechts, 0.03 mm tief  
 Streuwert 2.28, horizontal: 2.81, vertikal: 1.58

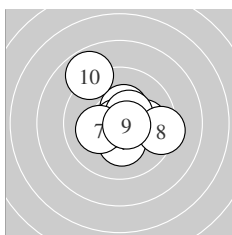
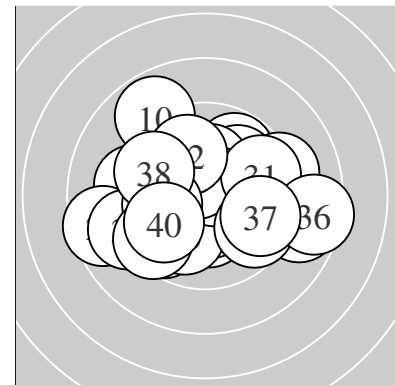

Serie 1:  
 10.4 \*                      10.0 →                      10.5 \*                      10.2 \*                      10.9 \*  
 10.5 \*                      10.2 \*                      9.4 →                      10.7 \*                      8.8 ↘  
 beste Teiler 24.0 (5.) 68.1 (9.) 104.2 (3.)  
 Trefferlage 0.40 mm rechts, 0.26 mm hoch  
 Streuwert 1.80, horizontal: 1.89, vertikal: 1.71

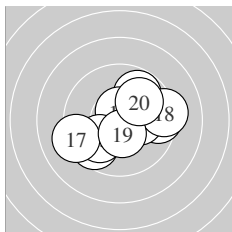

Serie 2:  
 9.8 ↗                      10.6 \*                      9.5 →                      9.6 ↙                      9.9 ↗  
 10.2 \*                      9.2 ↖                      9.3 →                      10.4 \*                      9.9 ↗  
 beste Teiler 86.0 (12.) 128.4 (19.) 185.2 (16.)  
 Trefferlage 0.50 mm rechts, 0.14 mm tief  
 Streuwert 2.19, horizontal: 2.65, vertikal: 1.60

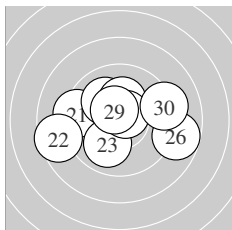

Serie 3:  
 9.3 ←                      8.6 ←                      10.0 ↙                      10.1 ↘                      10.5 \*  
 8.8 →                      10.2 \*                      10.6 \*                      10.5 \*                      9.2 →  
 beste Teiler 77.0 (28.) 106.8 (29.) 113.6 (25.)  
 Trefferlage 0.21 mm links, 0.27 mm hoch  
 Streuwert 2.55, horizontal: 3.29, vertikal: 1.49

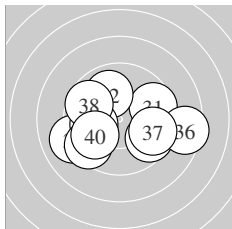

Serie 4:  
 9.6 →                      9.9 ↘                      9.1 ←                      9.6 ↘                      10.0 ←  
 8.5 →                      9.6 ↘                      9.7 ↘                      9.4 ↙                      9.9 ↙  
 beste Teiler 245.9 (35.) 251.7 (32.) 274.8 (40.)  
 Trefferlage 0.06 mm links, 0.54 mm tief  
 Streuwert 2.74, horizontal: 3.53, vertikal: 1.60

Unterschrift des Schuetzen

Meyton Elektronik

Ergebnis: **386** (404.0)  
 Serien: 93 98 97 98  
 Zaehler: 26 14 0 0 0 0 0 0 0 0  
 Innenzehner: 22  
 weiteste: 440 (20), 440 (28), 407 (29)  
 beste Teiler 22.0 (24.) 41.8 (4.) 99.8 (31.)  
 Trefferlage 0.32 mm links, 0.68 mm hoch  
 Streuwert 1.62, horizontal: 1.78, vertikal: 1.45

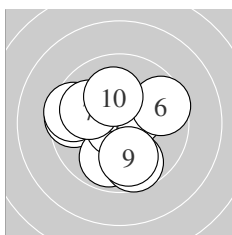
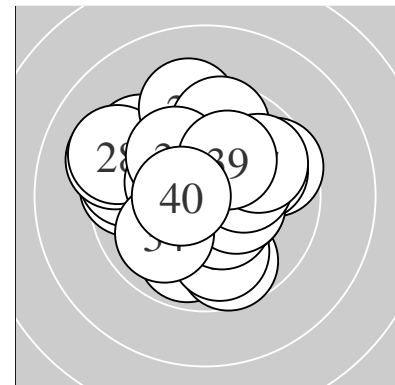

Serie 1:  
 9.6 ←                      9.9 ↓                      10.5 \*                      10.8 \*                      9.5 ←  
 9.6 →                      9.9 ↖                      9.7 ↓                      9.9 ↓                      10.1 ↑  
 beste Teiler 41.8 (4.) 123.9 (3.) 206.6 (10.)  
 Trefferlage 0.49 mm links, 0.21 mm tief  
 Streuwert 1.97, horizontal: 2.12, vertikal: 1.81

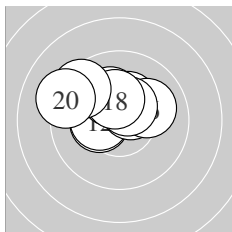

Serie 2:  
 10.3 \*                      10.3 \*                      10.3 \*                      10.5 \*                      10.2 \*  
 10.1 →                      10.5 \*                      10.3 \*                      9.5 ↘                      9.2 ↖  
 beste Teiler 113.2 (14.) 121.4 (17.) 151.0 (12.)  
 Trefferlage 0.69 mm links, 1.13 mm hoch  
 Streuwert 1.44, horizontal: 1.86, vertikal: 0.80

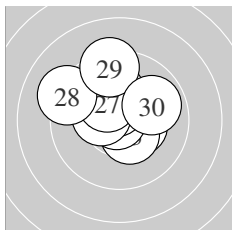

Serie 3:  
 10.2 \*                      10.4 \*                      10.4 \*                      10.9 \*                      10.5 \*  
 10.4 \*                      10.3 \*                      9.2 ↖                      9.3 ↑                      9.9 →  
 beste Teiler 22.0 (24.) 102.8 (25.) 133.4 (23.)  
 Trefferlage 0.32 mm links, 1.01 mm hoch  
 Streuwert 1.59, horizontal: 1.72, vertikal: 1.44

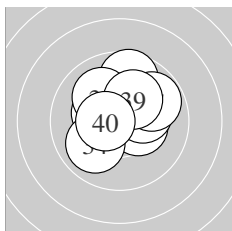

Serie 4:  
 10.6 \*                      10.3 \*                      10.4 \*                      10.0 ↙                      10.2 \*  
 9.7 ↑                      9.8 →                      10.1 ↘                      10.2 \*                      10.5 \*  
 beste Teiler 99.8 (31.) 108.0 (40.) 146.9 (33.)  
 Trefferlage 0.21 mm rechts, 0.80 mm hoch  
 Streuwert 1.43, horizontal: 1.52, vertikal: 1.34

Unterschrift des Schuetzen

Meyton Elektronik

Ergebnis:	<b>376</b>	(394.6)
Serien:	94 94 92 96	
Zaehler:	21 14 5 0 0 0 0 0 0 0	
Innenzehner:	15	
weiteste:	611 (12), 580 (4), 564 (29)	
beste Teiler	3.0 (22.) 88.5 (18.) 99.2 (38.)	
Trefferlage	1.04 mm rechts, 0.62 mm hoch	
Streuwert	2.04, horizontal: 2.29, vertikal: 1.74	

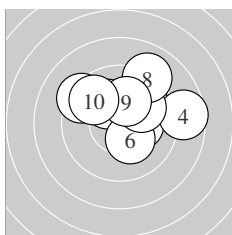
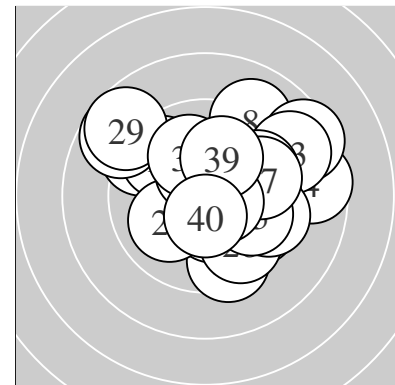

Serie 1:

9.3 ↘	9.8 ↗	10.3 *	8.6 →	10.1 ↖
10.3 *	10.0 ↗	9.0 ↗	10.1 ↑	9.7 ↘
beste Teiler	172.2 (6.)	175.7 (3.)	204.4 (5.)	
Trefferlage	0.86 mm rechts, 1.49 mm hoch			
Streuwert	2.15, horizontal: 2.64, vertikal: 1.50			

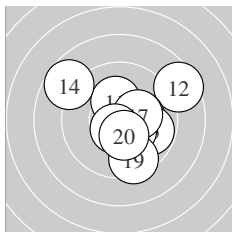

Serie 2:

10.3 *	8.5 ↗	10.2 *	8.7 ↘	9.8 →
10.4 *	10.3 *	10.6 *	9.5 ↓	10.4 *
beste Teiler	88.5 (18.)	142.4 (20.)	144.0 (16.)	
Trefferlage	0.89 mm rechts, 0.12 mm hoch			
Streuwert	2.32, horizontal: 2.54, vertikal: 2.08			

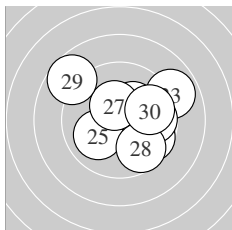

Serie 3:

9.7 ↘	10.9 *	8.9 ↗	10.3 *	10.0 ↖
9.8 →	10.4 *	9.7 ↘	8.7 ↘	9.8 →
beste Teiler	3.0 (22.)	140.1 (27.)	172.5 (24.)	
Trefferlage	0.94 mm rechts, 0.42 mm hoch			
Streuwert	2.30, horizontal: 2.66, vertikal: 1.87			

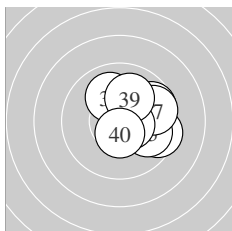

Serie 4:

10.4 *	10.2 *	9.7 ↗	9.5 →	9.9 →
10.0 ↖	9.7 →	10.6 *	10.0 ↑	10.5 *
beste Teiler	99.2 (38.)	109.0 (40.)	139.0 (31.)	
Trefferlage	1.46 mm rechts, 0.46 mm hoch			
Streuwert	1.39, horizontal: 1.44, vertikal: 1.35			

Unterschrift des Schuetzen

Meyton Elektronik

Ergebnis: **378** (394.1)  
 Serien: 94 97 96 91  
 Zaehler: 22 15 2 1 0 0 0 0 0 0  
 Innenzehner: 16  
 weiteste: 751 (33), 594 (10), 593 (31)  
 beste Teiler 17.8 (8.) 51.4 (11.) 88.2 (7.)  
 Trefferlage 0.28 mm rechts, 0.69 mm hoch  
 Streuwert 2.22, horizontal: 2.55, vertikal: 1.83

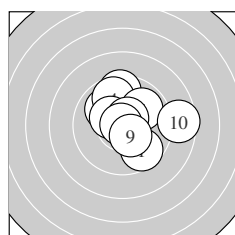
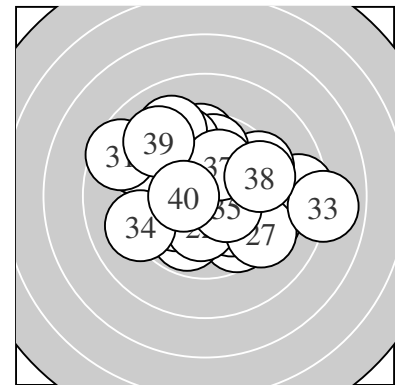

Serie 1:  
 9.6 ↘ 9.5 ↑ 10.0 ↘ 9.7 ↑ 9.9 ↗  
 10.4 \* 10.6 \* 10.9 \* 10.4 \* 8.6 →  
 beste Teiler 17.8 (8.) 88.2 (7.) 138.4 (9.)  
 Trefferlage 0.68 mm rechts, 0.81 mm hoch  
 Streuwert 2.04, horizontal: 2.24, vertikal: 1.81

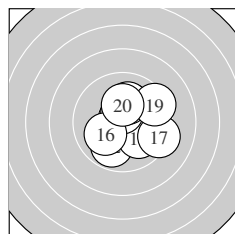

Serie 2:  
 10.7 \* 9.9 ↙ 10.2 \* 10.0 ↘ 10.6 \*  
 10.1 ↙ 9.3 ↘ 10.1 ↑ 9.4 ↗ 10.2 \*  
 beste Teiler 51.4 (11.) 100.1 (15.) 182.0 (20.)  
 Trefferlage 0.69 mm rechts, 0.20 mm hoch  
 Streuwert 1.79, horizontal: 1.82, vertikal: 1.75

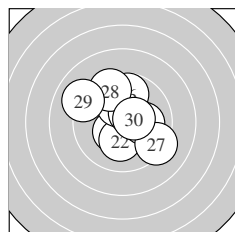

Serie 3:  
 10.4 \* 10.2 \* 10.1 → 10.2 \* 10.5 \*  
 9.8 ↑ 9.3 ↘ 9.5 ↘ 9.0 ↘ 10.5 \*  
 beste Teiler 122.0 (25.) 125.2 (30.) 135.8 (21.)  
 Trefferlage 0.10 mm rechts, 0.63 mm hoch  
 Streuwert 2.04, horizontal: 2.11, vertikal: 1.98

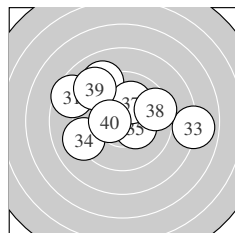

Serie 4:  
 8.6 ↘ 10.4 \* 7.9 → 9.1 ↙ 10.3 \*  
 9.1 ↘ 10.1 ↑ 9.5 → 9.1 ↘ 10.4 \*  
 beste Teiler 136.0 (40.) 142.5 (32.) 152.0 (35.)  
 Trefferlage 0.34 mm links, 1.13 mm hoch  
 Streuwert 3.02, horizontal: 3.81, vertikal: 1.94

Unterschrift des Schuetzen



Ergebnis: **396** (413.9)  
 Serien: 98 99 99 100  
 Zaehler: 36 4 0 0 0 0 0 0 0 0  
 Innenzehner: 32  
 weiteste: 377 (10), 279 (2), 269 (16)  
 beste Teiler 35.6 (32.) 56.3 (17.) 70.4 (37.)  
 Trefferlage 0.11 mm rechts, 0.06 mm hoch  
 Streuwert 1.18, horizontal: 1.20, vertikal: 1.17

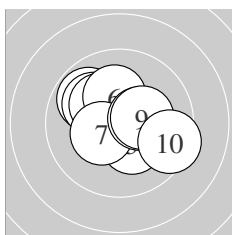
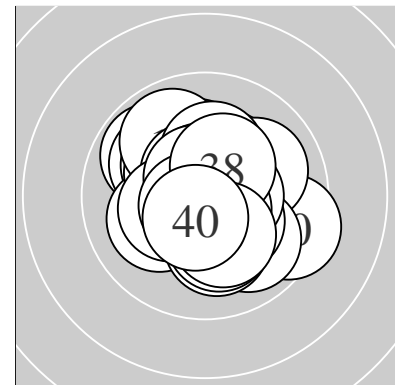

Serie 1:  
 10.5 \*                      9.8 ↖                      10.0 ↖                      10.2 \*                      10.3 \*  
 10.2 \*                      10.4 \*                      10.4 \*                      10.3 \*                      9.4 ↗  
 beste Teiler 116.7 (1.) 143.8 (8.) 145.1 (7.)  
 Trefferlage 0.00 mm , 0.46 mm hoch  
 Streuwert 1.55, horizontal: 1.82, vertikal: 1.22

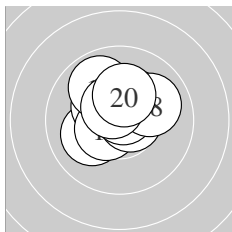

Serie 2:  
 10.1 ↙                      10.3 \*                      10.3 \*                      10.5 \*                      10.6 \*  
 9.9 ↘                      10.7 \*                      10.0 ↗                      10.5 \*                      10.2 \*  
 beste Teiler 56.3 (17.) 76.0 (15.) 106.0 (19.)  
 Trefferlage 0.16 mm links, 0.73 mm hoch  
 Streuwert 1.15, horizontal: 1.25, vertikal: 1.03

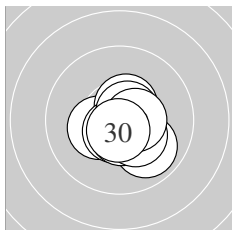

Serie 3:  
 10.3 \*                      10.5 \*                      10.6 \*                      10.5 \*                      10.7 \*  
 9.9 ↘                      10.6 \*                      10.3 \*                      10.5 \*                      10.7 \*  
 beste Teiler 73.6 (30.) 75.6 (25.) 87.2 (23.)  
 Trefferlage 0.42 mm rechts, 0.49 mm tief  
 Streuwert 0.88, horizontal: 0.94, vertikal: 0.82

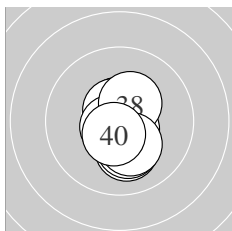

Serie 4:  
 10.6 \*                      10.8 \*                      10.1 ↓                      10.6 \*                      10.2 \*  
 10.6 \*                      10.7 \*                      10.4 \*                      10.2 \*                      10.5 \*  
 beste Teiler 35.6 (32.) 70.4 (37.) 82.0 (36.)  
 Trefferlage 0.20 mm rechts, 0.44 mm tief  
 Streuwert 0.91, horizontal: 0.52, vertikal: 1.17

Unterschrift des Schuetzen

Ergebnis: **392** (408.7)  
 Serien: 98 99 98 97  
 Zaehler: 32 8 0 0 0 0 0 0 0 0  
 Innenzehner: 26  
 weiteste: 432 (38), 326 (9), 304 (25)  
 beste Teiler 14.0 (31.) 57.4 (13.) 64.3 (14.)  
 Trefferlage 0.27 mm links, 0.09 mm hoch  
 Streuwert 1.40, horizontal: 1.43, vertikal: 1.38

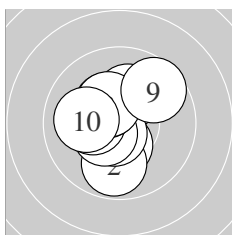
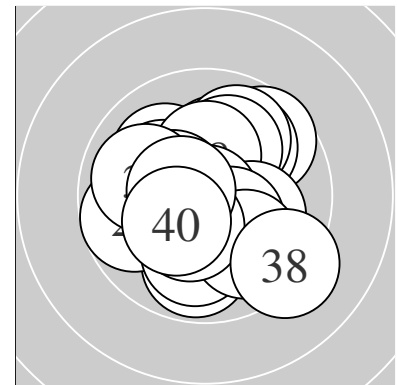

Serie 1:  
 10.4 \* 9.8 ↓ 10.2 \* 10.6 \* 10.5 \*  
 10.2 \* 10.3 \* 10.3 \* 9.6 ↗ 10.0 ←  
 beste Teiler 79.6 (4.) 123.7 (5.) 149.0 (1.)  
 Trefferlage 0.46 mm links, 0.12 mm hoch  
 Streuwert 1.44, horizontal: 1.29, vertikal: 1.58

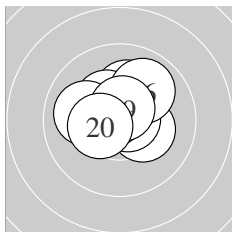

Serie 2:  
 10.3 \* 10.2 \* 10.7 \* 10.7 \* 10.4 \*  
 9.9 ↗ 10.5 \* 10.0 ← 10.6 \* 10.4 \*  
 beste Teiler 57.4 (13.) 64.3 (14.) 82.0 (19.)  
 Trefferlage 0.17 mm links, 0.59 mm hoch  
 Streuwert 1.10, horizontal: 1.28, vertikal: 0.89

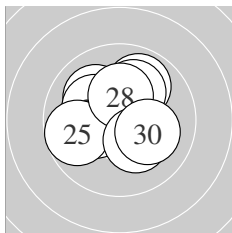

Serie 3:  
 10.3 \* 10.4 \* 10.0 ↘ 10.2 \* 9.7 ←  
 9.9 ↗ 10.1 ↗ 10.3 \* 10.2 \* 10.1 →  
 beste Teiler 130.8 (22.) 167.1 (28.) 170.2 (21.)  
 Trefferlage 0.35 mm links, 0.58 mm hoch  
 Streuwert 1.49, horizontal: 1.63, vertikal: 1.33

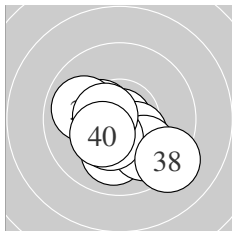

Serie 4:  
 10.9 \* 10.4 \* 10.4 \* 10.0 ↓ 9.9 ↘  
 9.9 ← 10.4 \* 9.2 ↘ 10.5 \* 10.3 \*  
 beste Teiler 14.0 (31.) 101.4 (39.) 141.0 (33.)  
 Trefferlage 0.09 mm links, 0.91 mm tief  
 Streuwert 1.46, horizontal: 1.68, vertikal: 1.21

Unterschrift des Schuetzen

Meyton Elektronik

Ergebnis: **382** (399.5)  
 Serien: 93 92 98 99  
 Zaehler: 23 16 1 0 0 0 0 0 0 0  
 Innenzehner: 18  
 weiteste: 511 (17), 476 (8), 451 (2)  
 beste Teiler 34.9 (39.) 61.8 (16.) 71.1 (12.)  
 Trefferlage 0.15 mm rechts, 0.62 mm hoch  
 Streuwert 1.87, horizontal: 2.39, vertikal: 1.13

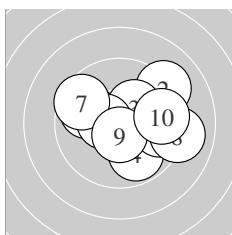
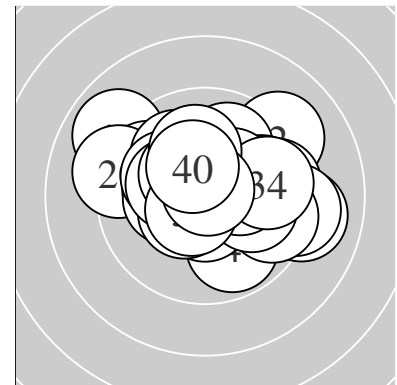

Serie 1:  
 9.8 ↖ 9.1 ↗ 10.3 \* 9.9 ↘ 10.5 \*  
 9.6 → 9.6 ↖ 9.0 → 10.6 \* 9.6 →  
 beste Teiler 94.0 (9.) 123.6 (5.) 174.0 (3.)  
 Trefferlage 1.04 mm rechts, 0.26 mm hoch  
 Streuwert 2.20, horizontal: 2.71, vertikal: 1.52

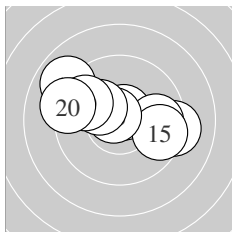

Serie 2:  
 9.2 → 10.7 \* 9.4 ↖ 9.8 → 9.6 →  
 10.7 \* 8.9 ↖ 10.2 \* 9.7 ↖ 9.2 ←  
 beste Teiler 61.8 (16.) 71.1 (12.) 192.5 (18.)  
 Trefferlage 0.58 mm links, 0.74 mm hoch  
 Streuwert 2.41, horizontal: 3.20, vertikal: 1.17

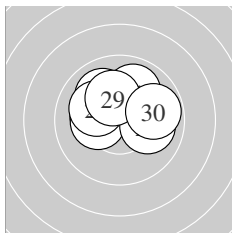

Serie 3:  
 9.9 ↗ 10.2 \* 10.0 → 10.4 \* 10.0 ↖  
 10.3 \* 10.1 ↖ 10.0 → 10.2 \* 9.8 →  
 beste Teiler 138.2 (24.) 174.4 (26.) 180.0 (22.)  
 Trefferlage 0.06 mm rechts, 0.88 mm hoch  
 Streuwert 1.48, horizontal: 1.88, vertikal: 0.92

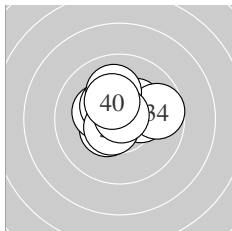

Serie 4:  
 10.3 \* 10.4 \* 10.3 \* 9.7 → 10.3 \*  
 10.4 \* 10.6 \* 10.1 ↑ 10.8 \* 10.3 \*  
 beste Teiler 34.9 (39.) 93.3 (37.) 128.2 (32.)  
 Trefferlage 0.07 mm rechts, 0.61 mm hoch  
 Streuwert 1.21, horizontal: 1.46, vertikal: 0.90

Unterschrift des Schuetzen

Meyton Elektronik

Ergebnis: **391** (407.3)  
 Serien: 97 98 97 99  
 Zaehler: 31 9 0 0 0 0 0 0 0 0  
 Innenzehner: 26  
 weiteste: 484 (6), 448 (1), 400 (24)  
 beste Teiler 32.8 (29.) 48.8 (18.) 60.1 (16.)  
 Trefferlage 0.88 mm links, 0.04 mm hoch  
 Streuwert 1.45, horizontal: 1.64, vertikal: 1.23

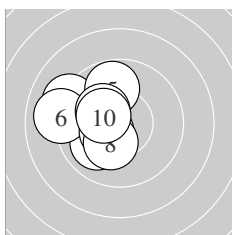
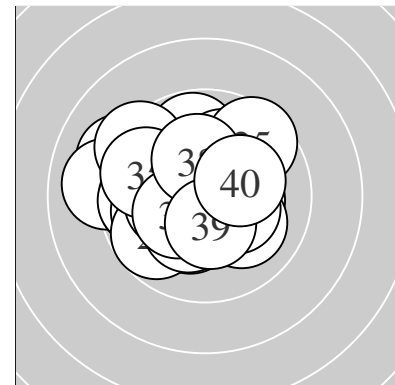

Serie 1:  
 9.2 ↘ 10.3 \* 10.0 ↙ 10.4 \* 9.8 ↑  
 9.0 ← 10.4 \* 10.3 \* 10.3 \* 10.4 \*  
 beste Teiler 127.8 (7.) 140.5 (4.) 145.4 (10.)  
 Trefferlage 1.83 mm links, 0.18 mm hoch  
 Streuwert 1.46, horizontal: 1.44, vertikal: 1.48

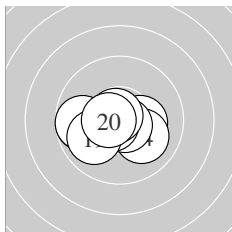

Serie 2:  
 10.2 \* 10.3 \* 9.7 ← 10.1 ↘ 9.7 ←  
 10.7 \* 10.7 \* 10.8 \* 10.0 ↙ 10.6 \*  
 beste Teiler 48.8 (18.) 60.1 (16.) 73.7 (17.)  
 Trefferlage 0.78 mm links, 0.42 mm tief  
 Streuwert 1.29, horizontal: 1.74, vertikal: 0.54

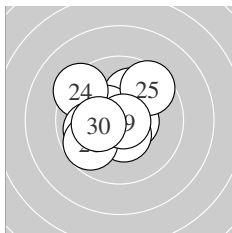

Serie 3:  
 10.6 \* 10.1 ↑ 10.5 \* 9.4 ↘ 9.6 ↗  
 10.5 \* 10.0 ← 9.7 ↙ 10.8 \* 10.3 \*  
 beste Teiler 32.8 (29.) 100.4 (21.) 124.3 (26.)  
 Trefferlage 0.59 mm links, 0.33 mm hoch  
 Streuwert 1.69, horizontal: 1.81, vertikal: 1.55

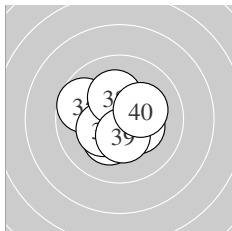

Serie 4:  
 10.3 \* 10.7 \* 10.3 \* 10.5 \* 9.7 ↘  
 10.3 \* 10.3 \* 10.2 \* 10.4 \* 10.2 \*  
 beste Teiler 61.0 (32.) 119.0 (34.) 137.6 (39.)  
 Trefferlage 0.34 mm links, 0.07 mm hoch  
 Streuwert 1.28, horizontal: 1.38, vertikal: 1.16

Unterschrift des Schuetzen

Meyton Elektronik

Ergebnis: **383** (402.1)  
 Serien: 95 98 95 95  
 Zaehler: 24 15 1 0 0 0 0 0 0 0  
 Innenzehner: 17  
 weiteste: 610 (3), 415 (21), 407 (28)  
 beste Teiler 10.4 (18.) 38.0 (23.) 63.0 (20.)  
 Trefferlage 0.14 mm links, 0.89 mm tief  
 Streuwert 1.71, horizontal: 1.97, vertikal: 1.42

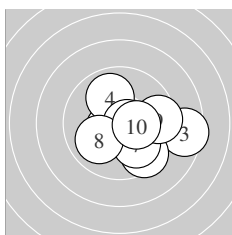
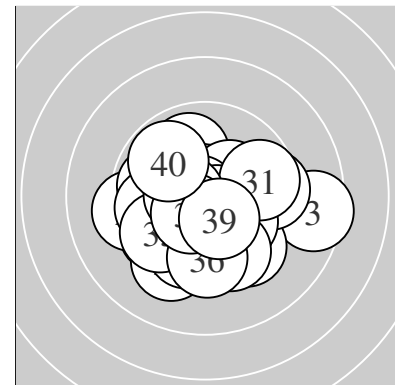

Serie 1:  
 10.1 ↘ 10.6 \* 8.5 → 9.9 ↑ 9.5 ↘  
 10.7 \* 10.0 ↘ 10.0 ↙ 9.5 → 10.3 \*  
 beste Teiler 69.1 (6.) 96.1 (2.) 156.8 (10.)  
 Trefferlage 1.38 mm rechts, 0.62 mm tief  
 Streuwert 1.94, horizontal: 2.34, vertikal: 1.43

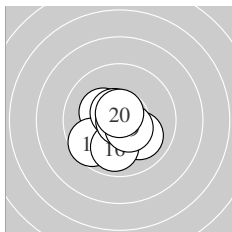

Serie 2:  
 10.0 ↓ 10.3 \* 10.4 \* 10.0 ↘ 9.6 ↙  
 9.9 ↓ 10.6 \* 10.9 \* 10.5 \* 10.7 \*  
 beste Teiler 10.4 (18.) 63.0 (20.) 85.2 (17.)  
 Trefferlage 0.40 mm links, 0.80 mm tief  
 Streuwert 1.23, horizontal: 1.21, vertikal: 1.25

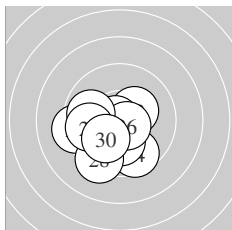

Serie 3:  
 9.3 ← 10.3 \* 10.8 \* 9.6 ↘ 10.2 \*  
 10.6 \* 9.9 ← 9.3 ↓ 9.8 ← 10.1 ↙  
 beste Teiler 38.0 (23.) 84.6 (26.) 163.1 (22.)  
 Trefferlage 0.94 mm links, 1.09 mm tief  
 Streuwert 1.70, horizontal: 1.89, vertikal: 1.49

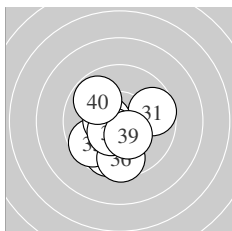

Serie 4:  
 9.7 → 10.0 ↙ 9.7 ↓ 10.3 \* 9.7 ↙  
 9.6 ↓ 10.5 \* 10.5 \* 10.4 \* 9.8 ↘  
 beste Teiler 118.1 (37.) 124.4 (38.) 150.4 (39.)  
 Trefferlage 0.61 mm links, 1.06 mm tief  
 Streuwert 1.63, horizontal: 1.61, vertikal: 1.65

Unterschrift des Schuetzen

Meyton Elektronik

Ergebnis:	<b>384</b>	(401.5)							
Serien:	97	93	96	98					
Zaehler:	24	16	0	0	0	0	0	0	0
Innenzehner:	18								
weiteste:	492 (5), 484 (4), 380 (11)								
beste Teiler	44.1 (38.)	50.9 (14.)	57.3 (33.)						
Trefferlage	0.67 mm rechts, 0.36 mm tief								
Streuwert	1.74, horizontal: 1.66, vertikal: 1.83								

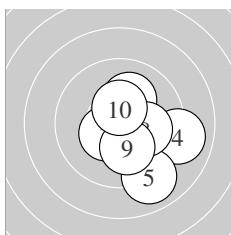
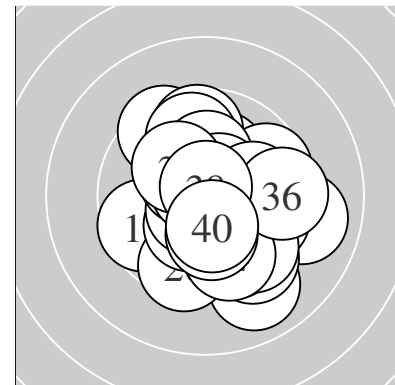

Serie 1:	10.5 *	10.4 *	9.6 ↘	9.0 →	9.0 ↓
	10.1 ↗	10.4 *	10.1 →	10.1 ↓	10.5 *
beste Teiler	120.4 (1.)	125.0 (10.)	135.4 (7.)		
Trefferlage	1.34 mm rechts, 0.70 mm tief				
Streuwert	1.76, horizontal: 1.66, vertikal: 1.85				

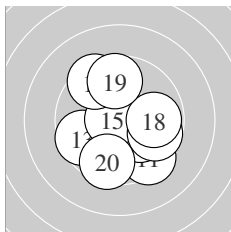

Serie 2:	9.4 ↘	10.1 ↘	9.6 ↙	10.8 *	10.7 *
	9.7 →	9.5 ↘	9.8 →	9.7 ↑	9.5 ↓
beste Teiler	50.9 (14.)	60.4 (15.)	204.2 (12.)		
Trefferlage	0.29 mm rechts, 0.40 mm tief				
Streuwert	2.13, horizontal: 2.05, vertikal: 2.20				

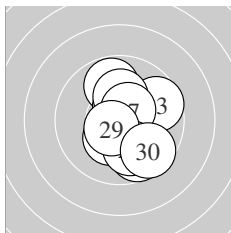

Serie 3:	9.8 ↑	10.3 *	9.7 ↗	10.5 *	9.7 ↓
	10.2 *	10.5 *	10.0 ↓	10.6 *	9.6 ↘
beste Teiler	92.6 (29.)	106.4 (27.)	113.1 (24.)		
Trefferlage	0.63 mm rechts, 0.16 mm tief				
Streuwert	1.68, horizontal: 1.29, vertikal: 2.00				

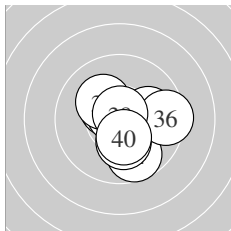

Serie 4:	10.4 *	10.4 *	10.7 *	9.7 ↓	10.0 →
	9.4 →	10.2 *	10.8 *	10.2 *	10.3 *
beste Teiler	44.1 (38.)	57.3 (33.)	126.1 (32.)		
Trefferlage	0.42 mm rechts, 0.16 mm tief				
Streuwert	1.51, horizontal: 1.61, vertikal: 1.40				

Unterschrift des Schuetzen

Meyton Elektronik

Ergebnis: **376** (395.4)  
 Serien: 97 91 94 94  
 Zaehler: 18 20 2 0 0 0 0 0 0 0  
 Innenzehner: 13  
 weiteste: 619 (20), 503 (36), 488 (30)  
 beste Teiler 15.2 (38.) 16.7 (5.) 45.1 (9.)  
 Trefferlage 1.22 mm links, 1.14 mm hoch  
 Streuwert 1.78, horizontal: 1.79, vertikal: 1.78

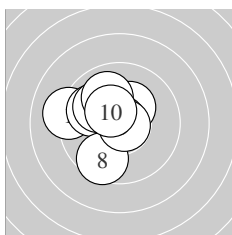
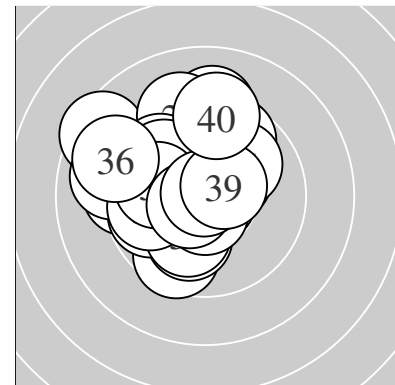

Serie 1:  
 9.2 ← 10.4 \* 10.3 \* 9.9 ↖ 10.9 \*  
 10.0 ↘ 10.0 ↘ 9.6 ↙ 10.8 \* 10.4 \*  
 beste Teiler 16.7 (5.) 45.1 (9.) 128.8 (2.)  
 Trefferlage 1.17 mm links, 0.55 mm hoch  
 Streuwert 1.48, horizontal: 1.52, vertikal: 1.44

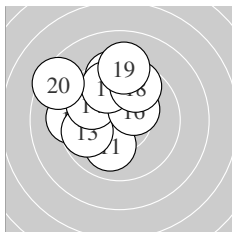

Serie 2:  
 10.0 ↙ 9.3 ← 9.8 ← 9.8 ↖ 9.4 ↑  
 10.3 \* 9.7 ↘ 9.7 ↑ 9.1 ↑ 8.5 ↘  
 beste Teiler 154.2 (16.) 231.0 (11.) 281.2 (14.)  
 Trefferlage 1.43 mm links, 1.66 mm hoch  
 Streuwert 2.19, horizontal: 2.22, vertikal: 2.16

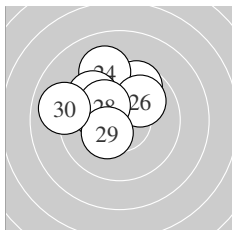

Serie 3:  
 9.6 ↘ 9.9 ↑ 9.7 ↗ 9.2 ↑ 9.7 ↘  
 10.0 ↗ 10.2 \* 10.2 \* 10.3 \* 9.0 ←  
 beste Teiler 153.4 (29.) 181.1 (28.) 186.6 (27.)  
 Trefferlage 1.07 mm links, 1.84 mm hoch  
 Streuwert 1.69, horizontal: 1.86, vertikal: 1.51

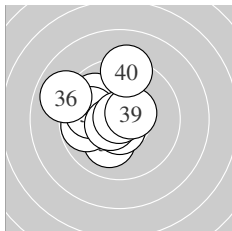

Serie 4:  
 10.1 ↙ 9.9 ↘ 10.6 \* 9.8 ← 9.9 ←  
 8.9 ↘ 10.6 \* 10.9 \* 10.5 \* 9.3 ↑  
 beste Teiler 15.2 (38.) 82.0 (33.) 91.9 (37.)  
 Trefferlage 1.22 mm links, 0.52 mm hoch  
 Streuwert 1.75, horizontal: 1.76, vertikal: 1.73

Unterschrift des Schuetzen

Meyton Elektronik

Ergebnis: **379** (397.6)  
 Serien: 97 93 95 94  
 Zaehler: 21 17 2 0 0 0 0 0 0 0  
 Innenzehner: 17  
 weiteste: 593 (20), 552 (15), 467 (31)  
 beste Teiler 40.4 (2.) 54.4 (1.) 55.0 (21.)  
 Trefferlage 1.06 mm rechts, 0.04 mm tief  
 Streuwert 1.93, horizontal: 2.07, vertikal: 1.77

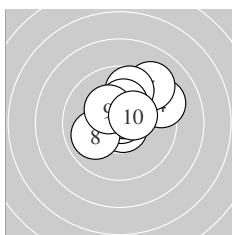
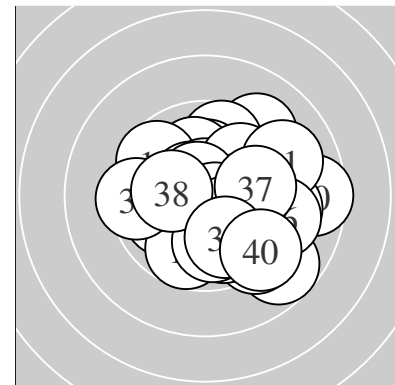

Serie 1:  
 10.7 \* 10.8 \* 10.6 \* 9.3 ↗ 9.2 ↗  
 9.7 ↑ 10.2 \* 10.0 ↖ 10.3 \* 10.4 \*  
 beste Teiler 40.4 (2.) 54.4 (1.) 89.9 (3.)  
 Trefferlage 0.67 mm rechts, 1.17 mm hoch  
 Streuwert 1.58, horizontal: 1.73, vertikal: 1.41

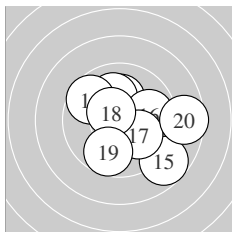

Serie 2:  
 10.5 \* 10.2 \* 10.1 ↑ 9.6 ↘ 8.7 ↘  
 9.8 → 10.1 ↘ 10.5 \* 9.7 ↓ 8.6 →  
 beste Teiler 105.3 (11.) 108.2 (18.) 198.1 (12.)  
 Trefferlage 0.99 mm rechts, 0.02 mm hoch  
 Streuwert 2.35, horizontal: 2.61, vertikal: 2.05

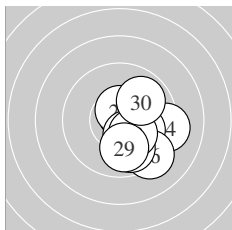

Serie 3:  
 10.7 \* 10.6 \* 10.3 \* 9.2 → 10.1 ↘  
 9.3 ↘ 9.9 ↓ 10.3 \* 9.9 ↓ 9.9 ↗  
 beste Teiler 55.0 (21.) 93.0 (22.) 151.2 (23.)  
 Trefferlage 1.46 mm rechts, 0.92 mm tief  
 Streuwert 1.46, horizontal: 1.30, vertikal: 1.60

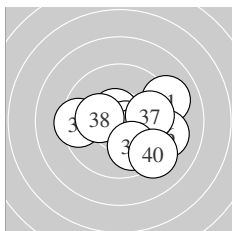

Serie 4:  
 9.1 ↗ 10.6 \* 10.7 \* 10.3 \* 9.4 ←  
 9.2 → 9.8 → 10.2 \* 9.9 ↓ 9.2 ↘  
 beste Teiler 68.0 (33.) 85.0 (32.) 173.2 (34.)  
 Trefferlage 1.12 mm rechts, 0.46 mm tief  
 Streuwert 2.12, horizontal: 2.61, vertikal: 1.47

Unterschrift des Schuetzen



Ergebnis:	<b>398</b>	(416.1)
Serien:	99	100 99 100
Zaehler:	38	2 0 0 0 0 0 0 0 0
Innenzehner:	30	
weiteste:	323	(27), 286 (5), 247 (23)
beste Teiler	5.8	(8.) 8.0 (1.) 31.0 (17.)
Trefferlage	0.09	mm rechts, 0.56 mm hoch
Streuwert	1.05,	horizontal: 1.09, vertikal: 1.02

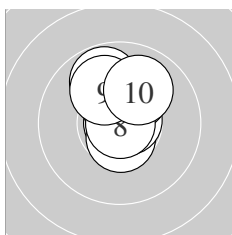
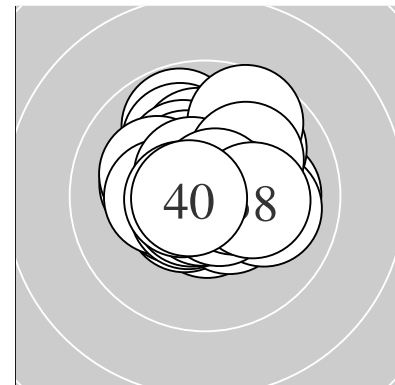

Serie 1:

10.9 *	10.6 *	10.1 ↑	10.6 *	9.8 ↗
10.7 *	10.2 *	10.9 *	10.0 ↘	10.0 ↗
beste Teiler	5.8 (8.)	8.0 (1.)	53.4 (6.)	
Trefferlage	0.08 mm rechts, 1.09 mm hoch			
Streuwert	0.99, horizontal: 0.70, vertikal: 1.22			

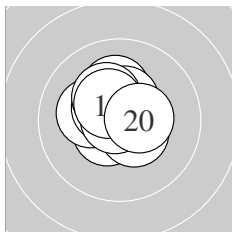

Serie 2:

10.5 *	10.2 *	10.5 *	10.2 *	10.5 *
10.4 *	10.8 *	10.3 *	10.4 *	10.4 *
beste Teiler	31.0 (17.)	106.2 (11.)	117.5 (15.)	
Trefferlage	0.31 mm links, 0.57 mm hoch			
Streuwert	0.92, horizontal: 0.93, vertikal: 0.90			

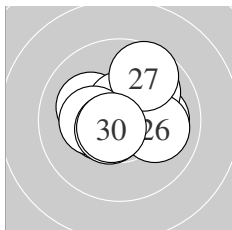

Serie 3:

10.0 →	10.5 *	10.0 ↗	10.1 ↖	10.6 *
10.0 →	9.7 ↗	10.3 *	10.6 *	10.7 *
beste Teiler	72.1 (30.)	88.5 (29.)	92.9 (25.)	
Trefferlage	0.20 mm rechts, 0.44 mm hoch			
Streuwert	1.40, horizontal: 1.61, vertikal: 1.15			

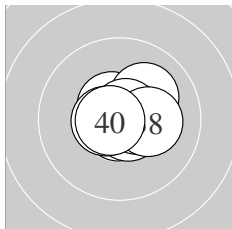

Serie 4:

10.8 *	10.6 *	10.7 *	10.7 *	10.1 ↗
10.5 *	10.7 *	10.2 *	10.6 *	10.7 *
beste Teiler	46.8 (31.)	53.7 (37.)	62.6 (40.)	
Trefferlage	0.39 mm rechts, 0.16 mm hoch			
Streuwert	0.78, horizontal: 0.93, vertikal: 0.59			

Unterschrift des Schuetzen

Meyton Elektronik

Ergebnis: **387** (402.8)  
 Serien: 98 96 98 95  
 Zaehler: 28 11 1 0 0 0 0 0 0 0  
 Innenzehner: 20  
 weiteste: 536 (15), 466 (37), 422 (36)  
 beste Teiler 44.5 (24.) 49.0 (17.) 58.5 (29.)  
 Trefferlage 0.41 mm links, 0.21 mm tief  
 Streuwert 1.77, horizontal: 1.96, vertikal: 1.55

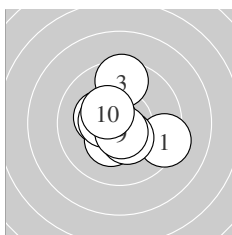
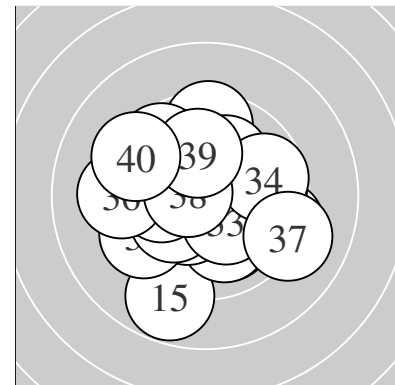

Serie 1:  
 9.3 ↘ 10.6 \* 9.5 ↑ 10.3 \* 10.5 \*  
 10.3 \* 10.4 \* 10.4 \* 10.6 \* 10.4 \*  
 beste Teiler 76.4 (9.) 78.8 (2.) 107.2 (5.)  
 Trefferlage 0.07 mm links, 0.05 mm tief  
 Streuwert 1.53, horizontal: 1.53, vertikal: 1.53

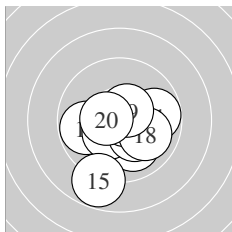

Serie 2:  
 9.8 → 9.8 ← 10.0 ↘ 10.4 \* 8.8 ↙  
 10.2 \* 10.8 \* 10.0 ↘ 10.5 \* 10.5 \*  
 beste Teiler 49.0 (17.) 101.4 (19.) 111.7 (20.)  
 Trefferlage 0.19 mm rechts, 0.98 mm tief  
 Streuwert 1.75, horizontal: 1.81, vertikal: 1.68

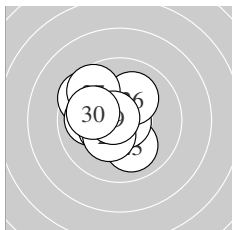

Serie 3:  
 9.6 ↘ 10.0 ← 10.0 ↘ 10.8 \* 10.4 \*  
 10.1 ↗ 9.6 ↘ 10.3 \* 10.7 \* 10.0 ←  
 beste Teiler 44.5 (24.) 58.5 (29.) 140.8 (25.)  
 Trefferlage 1.01 mm links, 0.29 mm hoch  
 Streuwert 1.45, horizontal: 1.47, vertikal: 1.44

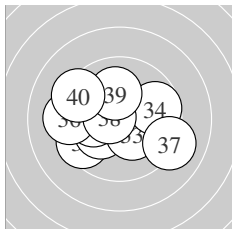

Serie 4:  
 9.5 ← 10.2 \* 10.3 \* 9.7 → 10.1 ←  
 9.3 ← 9.1 ↘ 10.6 \* 10.1 ↑ 9.3 ↘  
 beste Teiler 87.6 (38.) 161.6 (33.) 194.4 (32.)  
 Trefferlage 0.76 mm links, 0.10 mm tief  
 Streuwert 2.23, horizontal: 2.78, vertikal: 1.49

Unterschrift des Schuetzen

Meyton Elektronik

Ergebnis: **387** (406.1)  
 Serien: 97 97 96 97  
 Zaehler: 28 11 1 0 0 0 0 0 0 0  
 Innenzehner: 25  
 weiteste: 545 (20), 457 (26), 437 (35)  
 beste Teiler 56.0 (31.) 61.0 (28.) 62.9 (13.)  
 Trefferlage 0.41 mm links, 0.15 mm hoch  
 Streuwert 1.66, horizontal: 1.64, vertikal: 1.68

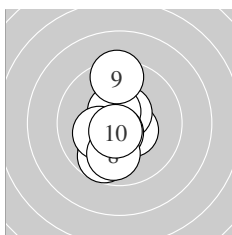
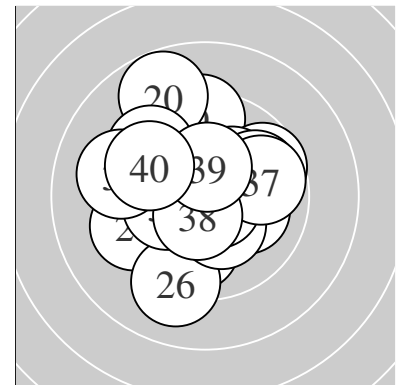

Serie 1:  
 10.5 \* 10.6 \* 10.5 \* 10.6 \* 10.0 ↘  
 9.7 ↘ 10.2 \* 9.9 ↓ 9.4 ↑ 10.6 \*  
 beste Teiler 76.4 (10.) 83.5 (4.) 99.3 (2.)  
 Trefferlage 0.45 mm links, 0.45 mm tief  
 Streuwert 1.51, horizontal: 0.82, vertikal: 1.98

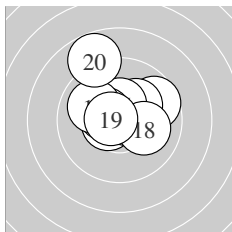

Serie 2:  
 9.7 → 10.6 \* 10.7 \* 10.2 \* 10.4 \*  
 10.4 \* 10.0 ↖ 10.1 → 10.7 \* 8.8 ↖  
 beste Teiler 62.9 (13.) 73.8 (19.) 100.8 (12.)  
 Trefferlage 0.02 mm links, 0.99 mm hoch  
 Streuwert 1.66, horizontal: 1.72, vertikal: 1.60

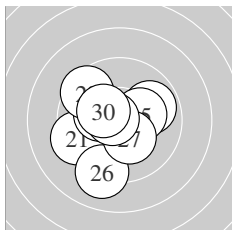

Serie 3:  
 9.4 ← 9.9 → 10.3 \* 10.4 \* 10.2 \*  
 9.1 ↓ 10.3 \* 10.7 \* 9.5 ↖ 10.3 \*  
 beste Teiler 61.0 (28.) 129.6 (24.) 156.2 (30.)  
 Trefferlage 0.54 mm links, 0.30 mm tief  
 Streuwert 1.91, horizontal: 1.97, vertikal: 1.84

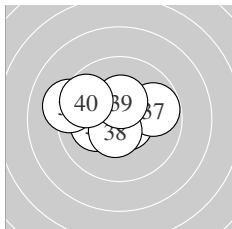

Serie 4:  
 10.7 \* 10.5 \* 10.2 \* 10.7 \* 9.2 ↖  
 10.7 \* 9.8 → 10.5 \* 10.4 \* 9.7 ↖  
 beste Teiler 56.0 (31.) 64.8 (34.) 69.8 (36.)  
 Trefferlage 0.62 mm links, 0.38 mm hoch  
 Streuwert 1.53, horizontal: 1.96, vertikal: 0.90

Unterschrift des Schuetzen

Meyton Elektronik

Ergebnis: **382** (397.1)  
 Serien: 94 97 96 95  
 Zaehler: 24 14 2 0 0 0 0 0 0 0  
 Innenzehner: 17  
 weiteste: 749 (34), 541 (6), 492 (25)  
 beste Teiler 66.7 (35.) 97.4 (18.) 116.1 (39.)  
 Trefferlage 0.01 mm links, 0.61 mm tief  
 Streuwert 2.07, horizontal: 2.41, vertikal: 1.65

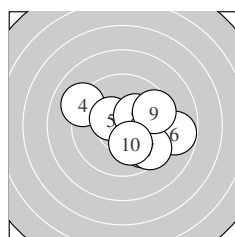
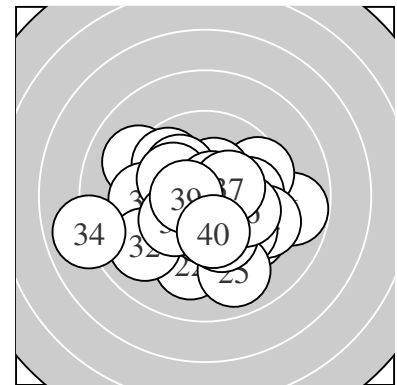

Serie 1:  
 10.2 \*                      10.2 \*                      9.8 ↘                      9.1 ↖                      10.4 \*  
 8.8 →                      9.5 ↘                      10.3 \*                      9.5 →                      10.1 ↓  
 beste Teiler 134.8 (5.) 163.6 (8.) 178.3 (1.)  
 Trefferlage 1.30 mm rechts, 0.26 mm tief  
 Streuwert 2.15, horizontal: 2.55, vertikal: 1.64

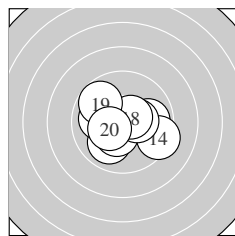

Serie 2:  
 10.0 ↙                      9.9 →                      10.5 \*                      9.4 ↘                      10.4 \*  
 10.4 \*                      10.0 ←                      10.6 \*                      9.8 ↖                      10.4 \*  
 beste Teiler 97.4 (18.) 123.1 (13.) 141.3 (15.)  
 Trefferlage 0.05 mm links, 0.25 mm tief  
 Streuwert 1.69, horizontal: 2.09, vertikal: 1.18

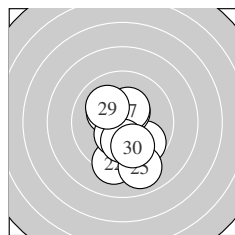

Serie 3:  
 9.7 ↘                      9.3 ↓                      10.2 \*                      10.4 \*                      9.0 ↓  
 10.5 \*                      10.4 \*                      10.2 \*                      10.1 ↖                      9.9 ↓  
 beste Teiler 119.0 (26.) 141.9 (24.) 144.8 (27.)  
 Trefferlage 0.15 mm rechts, 1.15 mm tief  
 Streuwert 1.86, horizontal: 1.31, vertikal: 2.28

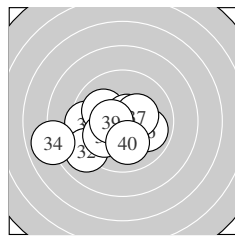

Serie 4:  
 9.5 ←                      9.0 ↙                      10.1 ↖                      8.0 ←                      10.7 \*  
 9.9 →                      10.3 \*                      10.0 ↙                      10.5 \*                      10.1 ↓  
 beste Teiler 66.7 (35.) 116.1 (39.) 156.0 (37.)  
 Trefferlage 1.47 mm links, 0.79 mm tief  
 Streuwert 2.25, horizontal: 2.87, vertikal: 1.38

Unterschrift des Schuetzen

Meyton Elektronik

Ergebnis: **383** (400.1)  
 Serien: 93 97 96 97  
 Zaehler: 24 15 1 0 0 0 0 0 0 0  
 Innenzehner: 17  
 weiteste: 540 (4), 428 (27), 392 (36)  
 beste Teiler 50.0 (22.) 80.3 (2.) 98.6 (11.)  
 Trefferlage 0.25 mm links, 0.12 mm tief  
 Streuwert 1.84, horizontal: 1.81, vertikal: 1.88

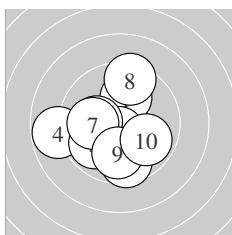
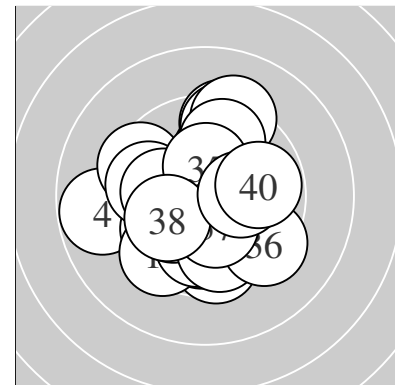

Serie 1:  
 10.0 ↑ 10.6 \* 9.6 ↓ 8.8 ← 9.8 ↙  
 10.2 \* 10.0 ← 9.4 ↑ 9.9 ↓ 9.9 ↘  
 beste Teiler 80.3 (2.) 200.3 (6.) 229.6 (1.)  
 Trefferlage 0.77 mm links, 0.45 mm tief  
 Streuwert 2.17, horizontal: 2.20, vertikal: 2.15

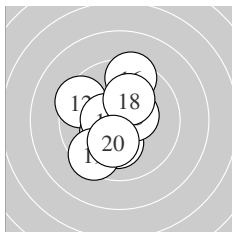

Serie 2:  
 10.6 \* 9.5 ↖ 10.3 \* 10.2 \* 10.5 \*  
 9.4 ↑ 10.5 \* 10.2 \* 9.5 ↗ 10.2 \*  
 beste Teiler 98.6 (11.) 117.1 (17.) 124.5 (15.)  
 Trefferlage 0.58 mm links, 0.12 mm tief  
 Streuwert 1.76, horizontal: 1.45, vertikal: 2.03

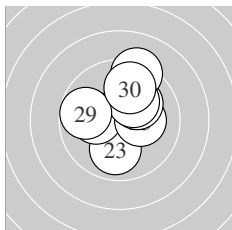

Serie 3:  
 10.5 \* 10.8 \* 9.9 ↓ 10.1 ← 10.2 \*  
 10.1 ↗ 9.2 ↑ 10.2 \* 9.8 ← 9.8 ↑  
 beste Teiler 50.0 (22.) 105.4 (21.) 181.0 (25.)  
 Trefferlage 0.16 mm rechts, 0.73 mm hoch  
 Streuwert 1.73, horizontal: 1.60, vertikal: 1.85

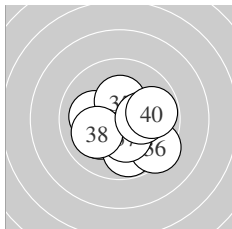

Serie 4:  
 10.1 ↙ 9.8 ↓ 10.4 \* 10.1 ← 10.3 \*  
 9.4 ↘ 10.3 \* 10.0 ↙ 10.2 \* 9.8 →  
 beste Teiler 144.8 (33.) 155.0 (35.) 158.8 (37.)  
 Trefferlage 0.19 mm rechts, 0.64 mm tief  
 Streuwert 1.69, horizontal: 1.96, vertikal: 1.39

Unterschrift des Schuetzen

Meyton Elektronik

Ergebnis: **375** (394.1)  
 Serien: 94 93 93 95  
 Zaehler: 21 15 2 2 0 0 0 0 0 0  
 Innenzehner: 14  
 weiteste: 944 (23), 835 (11), 528 (27)  
 beste Teiler 26.9 (32.) 71.2 (28.) 76.0 (24.)  
 Trefferlage 0.36 mm links, 0.25 mm hoch  
 Streuwert 2.36, horizontal: 2.91, vertikal: 1.64

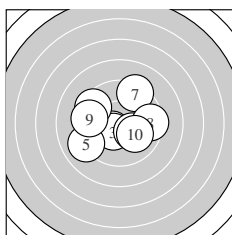
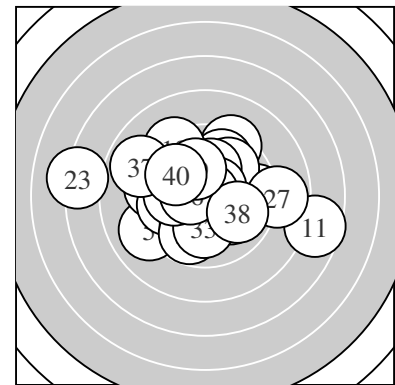

Serie 1:  
 9.5 ← 10.5 \* 10.4 \* 10.2 \* 9.0 ↙  
 9.4 ↘ 9.3 ↗ 9.5 → 9.5 ← 10.0 ↘  
 beste Teiler 118.4 (2.) 128.8 (3.) 181.1 (4.)  
 Trefferlage 0.72 mm links, 0.02 mm hoch  
 Streuwert 2.38, horizontal: 2.85, vertikal: 1.78

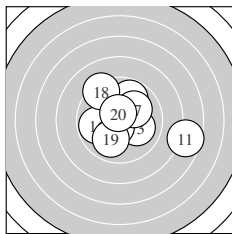

Serie 2:  
 7.6 → 10.1 ↖ 10.0 ↘ 10.6 \* 9.8 ↗  
 9.8 ← 10.1 ↗ 9.3 ↖ 9.9 ↘ 10.6 \*  
 beste Teiler 87.8 (20.) 96.1 (14.) 217.6 (12.)  
 Trefferlage 0.53 mm rechts, 0.33 mm hoch  
 Streuwert 2.61, horizontal: 3.09, vertikal: 2.01

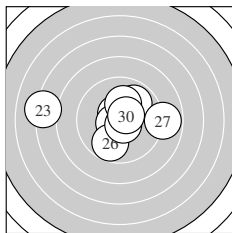

Serie 3:  
 10.6 \* 10.3 \* 7.2 ← 10.6 \* 9.9 ↗  
 9.8 ↘ 8.8 → 10.7 \* 10.2 \* 10.6 \*  
 beste Teiler 71.2 (28.) 76.0 (24.) 91.3 (21.)  
 Trefferlage 0.19 mm links, 0.42 mm hoch  
 Streuwert 2.79, horizontal: 3.68, vertikal: 1.44

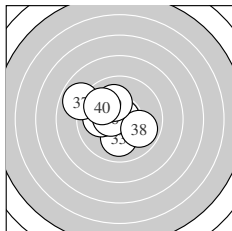

Serie 4:  
 10.4 \* 10.8 \* 10.0 ↓ 9.8 ↘ 10.0 ←  
 10.5 \* 8.9 ↘ 9.9 ↘ 10.1 ↗ 9.9 ↘  
 beste Teiler 26.9 (32.) 109.0 (36.) 138.2 (31.)  
 Trefferlage 1.09 mm links, 0.25 mm hoch  
 Streuwert 1.73, horizontal: 1.93, vertikal: 1.52

Unterschrift des Schuetzen

Meyton Elektronik

Ergebnis:	<b>383</b>	(399.1)
Serien:	93 94 97 99	
Zaehler:	26 12 1 1 0 0 0 0 0 0	
Innenzehner:	19	
weiteste:	773 (20), 676 (8), 438 (35)	
beste Teiler	57.0 (31.) 61.7 (6.) 67.6 (37.)	
Trefferlage	0.32 mm rechts, 0.91 mm hoch	
Streuwert	1.92, horizontal: 2.36, vertikal: 1.36	

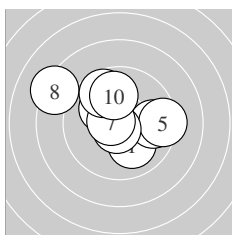
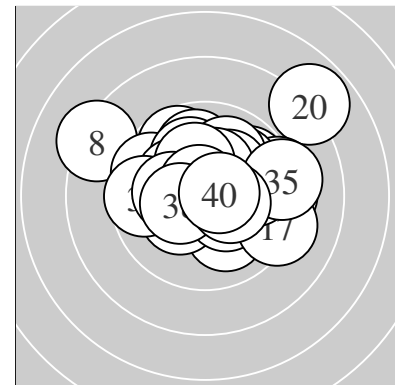

Serie 1:	10.0 ↘	9.8 ↖	10.1 ↖	9.7 →	9.3 →
	10.7 *	10.6 *	8.2 ↖	9.7 ↖	9.9 ↗
beste Teiler	61.7 (6.) 82.0 (7.) 205.4 (3.)				
Trefferlage	0.37 mm links, 0.98 mm hoch				
Streuwert	2.30, horizontal: 2.78, vertikal: 1.70				

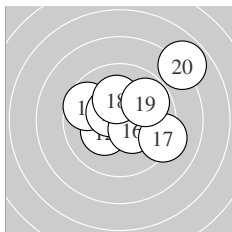

Serie 2:	10.2 *	10.3 *	9.6 ↖	10.5 *	10.1 ↗
	10.4 *	9.2 ↘	10.2 *	9.8 ↗	7.9 ↗
beste Teiler	113.0 (14.) 144.0 (16.) 172.4 (12.)				
Trefferlage	0.76 mm rechts, 0.93 mm hoch				
Streuwert	2.37, horizontal: 2.75, vertikal: 1.91				

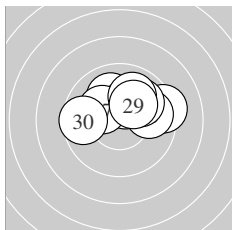

Serie 3:	10.0 ↖	10.1 ↗	10.3 *	9.3 →	9.8 →
	10.0 ↗	10.2 *	10.0 ↗	10.2 *	9.6 ←
beste Teiler	152.1 (23.) 187.9 (27.) 193.4 (29.)				
Trefferlage	0.75 mm rechts, 1.28 mm hoch				
Streuwert	1.61, horizontal: 2.18, vertikal: 0.68				

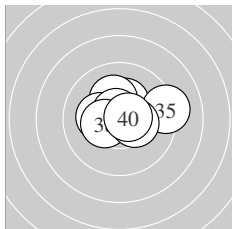

Serie 4:	10.7 *	10.3 *	10.2 *	10.7 *	9.2 →
	10.2 *	10.7 *	10.4 *	10.4 *	10.6 *
beste Teiler	57.0 (31.) 67.6 (37.) 75.3 (34.)				
Trefferlage	0.15 mm rechts, 0.43 mm hoch				
Streuwert	1.35, horizontal: 1.75, vertikal: 0.77				

Unterschrift des Schuetzen

Meyton Elektronik