

Ergebnis: **380** (396.6)
 Serien: 96 94 95 95
 Zähler: 23 14 3 0 0 0 0 0 0 0
 Innenzehner: 18
 weiteste: 746 (19), 694 (30), 509 (25)
 beste Teiler 45.1 (40.) 56.5 (10.) 72.8 (13.)
 Trefferlage 0.44 mm links, 0.92 mm hoch
 Streuwert 2.03, horizontal: 2.40, vertikal: 1.56

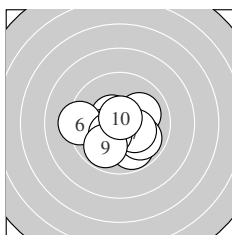

Serie 1:
 10.5 * 10.3 * 9.8 ↘ 10.1 ↗ 9.9 ↘
 9.3 ← 10.3 * 10.4 * 9.8 ↙ 10.7 *
 beste Teiler 56.5 (10.) 102.8 (1.) 146.6 (8.)
 Trefferlage 0.17 mm links, 0.69 mm tief
 Streuwert 1.64, horizontal: 1.98, vertikal: 1.23

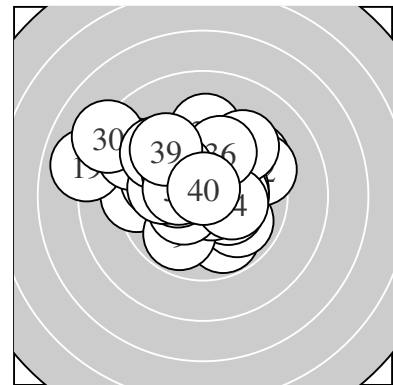
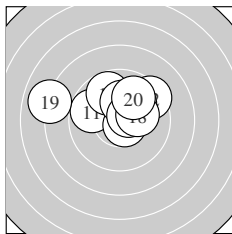

Serie 2:
 9.7 ↖ 9.4 ↗ 10.7 * 9.7 ↗ 10.2 *
 10.0 ↗ 10.5 * 10.2 * 8.0 ← 9.9 ↗
 beste Teiler 72.8 (13.) 103.3 (17.) 188.2 (15.)
 Trefferlage 0.16 mm links, 1.42 mm hoch
 Streuwert 2.24, horizontal: 2.99, vertikal: 1.03

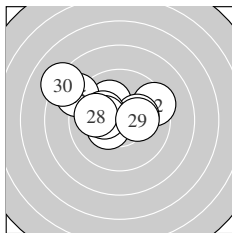

Serie 3:
 10.1 ↖ 9.4 ↗ 10.2 * 10.4 * 8.9 ↖
 10.2 * 10.3 * 10.0 ← 10.2 * 8.2 ↖
 beste Teiler 140.9 (24.) 159.6 (27.) 184.0 (29.)
 Trefferlage 1.10 mm links, 1.10 mm hoch
 Streuwert 2.25, horizontal: 2.89, vertikal: 1.33

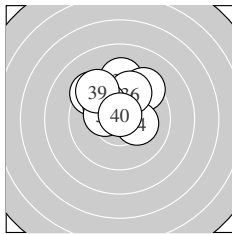

Serie 4:
 9.4 ↖ 9.3 ↑ 9.4 ↗ 10.2 * 10.5 *
 9.8 ↗ 10.1 ↖ 10.3 * 9.5 ↖ 10.8 *
 beste Teiler 45.1 (40.) 113.5 (35.) 156.8 (38.)
 Trefferlage 0.32 mm links, 1.84 mm hoch
 Streuwert 1.62, horizontal: 1.77, vertikal: 1.45

Unterschrift des Schützen

Meyton Elektronik

Ergebnis: **394** (408.2)
 Serien: 98 99 98 99
 Zähler: 34 6 0 0 0 0 0 0 0 0
 Innenzehner: 21
 weiteste: 346 (39), 305 (16), 280 (4)
 beste Teiler 20.8 (1.) 59.9 (12.) 76.2 (32.)
 Trefferlage 0.32 mm links, 0.26 mm hoch
 Streuwert 1.40, horizontal: 1.62, vertikal: 1.14

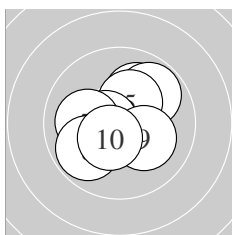
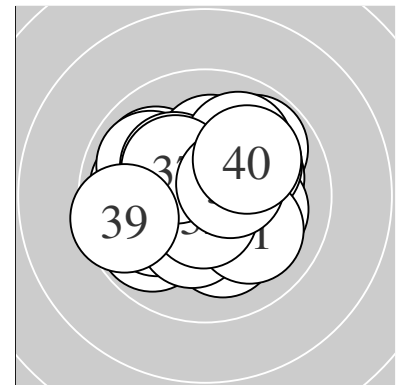

Serie 1:
 10.9 * 10.3 * 10.0 ↗ 9.8 ↗ 10.3 *
 10.6 * 10.1 ← 9.8 ↙ 10.2 * 10.5 *
 beste Teiler 20.8 (1.) 96.0 (6.) 121.2 (10.)
 Trefferlage 0.19 mm links, 0.15 mm hoch
 Streuwert 1.43, horizontal: 1.58, vertikal: 1.27

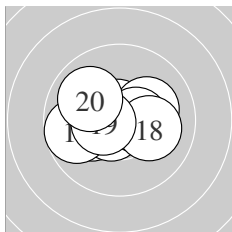

Serie 2:
 10.2 * 10.7 * 10.2 * 10.6 * 10.1 →
 9.7 ← 10.5 * 10.1 → 10.5 * 10.0 ↘
 beste Teiler 59.9 (12.) 82.0 (14.) 113.0 (17.)
 Trefferlage 0.54 mm links, 0.10 mm hoch
 Streuwert 1.34, horizontal: 1.73, vertikal: 0.77

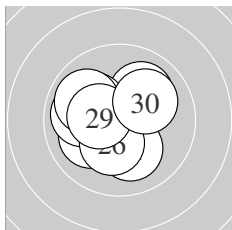

Serie 3:
 10.1 ↘ 10.0 ↗ 10.6 * 10.1 ↙ 9.9 ←
 10.3 * 10.1 ↘ 9.9 ↘ 10.4 * 10.1 →
 beste Teiler 90.8 (23.) 142.3 (29.) 165.7 (26.)
 Trefferlage 0.73 mm links, 0.16 mm hoch
 Streuwert 1.43, horizontal: 1.56, vertikal: 1.29

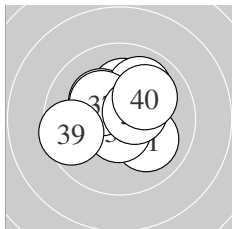

Serie 4:
 10.0 ↘ 10.6 * 10.2 * 10.2 * 10.2 *
 10.0 ↗ 10.3 * 10.5 * 9.6 ← 10.0 →
 beste Teiler 76.2 (32.) 116.2 (38.) 165.0 (37.)
 Trefferlage 0.17 mm rechts, 0.65 mm hoch
 Streuwert 1.48, horizontal: 1.68, vertikal: 1.25

Unterschrift des Schützen

Meyton Elektronik

Ergebnis: **385** (404.0)
 Serien: 97 95 97 96
 Zähler: 25 15 0 0 0 0 0 0 0 0
 Innenzehner: 20
 weiteste: 435 (19), 404 (16), 370 (30)
 beste Teiler 49.8 (26.) 70.5 (13.) 80.6 (3.)
 Trefferlage 0.58 mm rechts, 0.43 mm hoch
 Streuwert 1.61, horizontal: 1.74, vertikal: 1.48

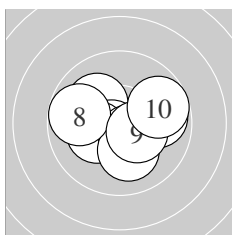
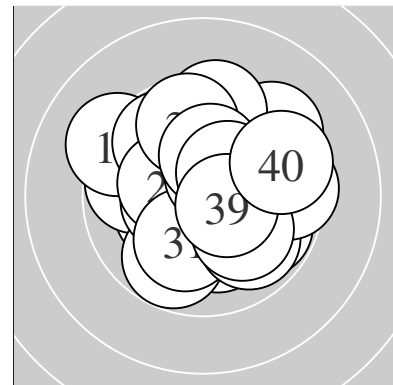

Serie 1:
 10.4 * 10.1 ↘ 10.6 * 10.3 * 10.5 *
 9.9 → 10.1 ↓ 9.8 ← 10.4 * 9.7 →
 beste Teiler 80.6 (3.) 114.2 (5.) 127.2 (1.)
 Trefferlage 0.17 mm rechts, 0.23 mm tief
 Streuwert 1.53, horizontal: 1.87, vertikal: 1.08

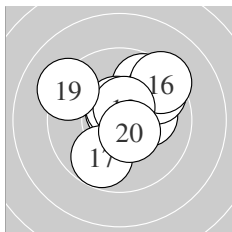

Serie 2:
 10.2 * 9.7 ↗ 10.7 * 10.6 * 9.7 ↗
 9.3 ↗ 9.8 ↓ 10.6 * 9.2 ↘ 10.5 *
 beste Teiler 70.5 (13.) 96.7 (14.) 98.3 (18.)
 Trefferlage 0.47 mm rechts, 0.88 mm hoch
 Streuwert 1.85, horizontal: 2.02, vertikal: 1.67

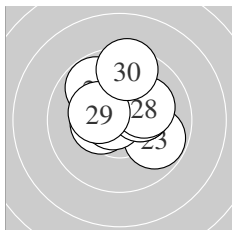

Serie 3:
 10.2 * 10.4 * 9.8 ↘ 9.8 ↘ 10.3 *
 10.8 * 10.3 * 10.1 ↗ 10.3 * 9.5 ↑
 beste Teiler 49.8 (26.) 136.7 (22.) 158.8 (29.)
 Trefferlage 0.45 mm rechts, 0.80 mm hoch
 Streuwert 1.48, horizontal: 1.58, vertikal: 1.36

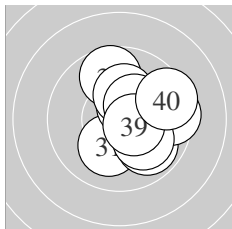

Serie 4:
 10.1 ↓ 9.9 ↘ 10.5 * 9.5 → 9.7 ↑
 10.1 ↘ 10.2 * 10.4 * 10.5 * 9.5 →
 beste Teiler 110.2 (33.) 112.1 (39.) 147.8 (38.)
 Trefferlage 1.23 mm rechts, 0.30 mm hoch
 Streuwert 1.59, horizontal: 1.51, vertikal: 1.67

Unterschrift des Schützen

Meyton Elektronik

Ergebnis: **394** (411.0)
 Serien: 99 98 98 99
 Zähler: 35 4 1 0 0 0 0 0 0 0
 Innenzehner: 30
 weiteste: 568 (22), 330 (8), 324 (13)
 beste Teiler 18.6 (38.) 36.2 (35.) 49.2 (18.)
 Trefferlage 0.11 mm rechts, 0.49 mm hoch
 Streuwert 1.36, horizontal: 1.56, vertikal: 1.13

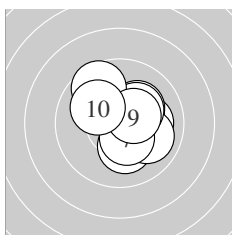
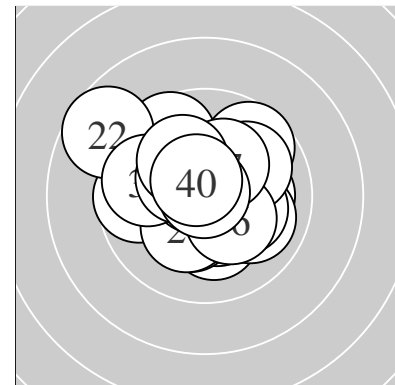

Serie 1:
 10.1 → 10.3 * 10.2 * 10.2 * 10.0 ↘
 10.3 * 10.4 * 9.6 ↖ 10.4 * 10.1 ↖
 beste Teiler 128.3 (9.) 133.2 (7.) 154.8 (2.)
 Trefferlage 0.72 mm rechts, 0.35 mm hoch
 Streuwert 1.41, horizontal: 1.42, vertikal: 1.41

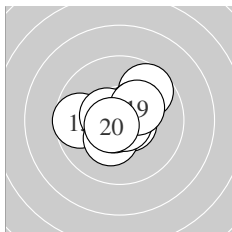

Serie 2:
 10.6 * 9.7 ↗ 9.7 ← 10.3 * 10.3 *
 10.5 * 10.7 * 10.8 * 10.3 * 10.6 *
 beste Teiler 49.2 (18.) 59.3 (17.) 76.8 (20.)
 Trefferlage 0.00 mm , 0.17 mm hoch
 Streuwert 1.33, horizontal: 1.55, vertikal: 1.06

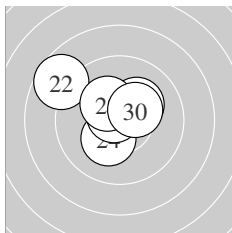

Serie 3:
 10.6 * 8.7 ↖ 10.4 * 10.3 * 10.6 *
 10.5 * 10.7 * 10.2 * 10.3 * 10.3 *
 beste Teiler 60.9 (27.) 77.6 (21.) 93.6 (25.)
 Trefferlage 0.32 mm links, 0.88 mm hoch
 Streuwert 1.48, horizontal: 1.78, vertikal: 1.12

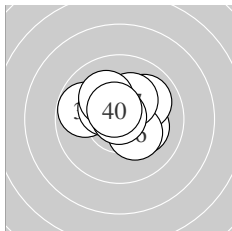

Serie 4:
 10.2 * 10.0 ↗ 9.8 ← 10.4 * 10.8 *
 10.3 * 10.2 * 10.9 * 10.1 ↖ 10.6 *
 beste Teiler 18.6 (38.) 36.2 (35.) 88.1 (40.)
 Trefferlage 0.07 mm rechts, 0.56 mm hoch
 Streuwert 1.25, horizontal: 1.51, vertikal: 0.92

Unterschrift des Schützen

Meyton Elektronik

Ergebnis: **383** (396.2)
 Serien: 94 97 96 96
 Zähler: 24 15 1 0 0 0 0 0 0 0
 Innenzehner: 13
 weiteste: 511 (4), 489 (39), 471 (22)
 beste Teiler 54.0 (21.) 60.8 (35.) 120.0 (36.)
 Trefferlage 0.31 mm links, 0.11 mm tief
 Streuwert 2.05, horizontal: 2.08, vertikal: 2.02

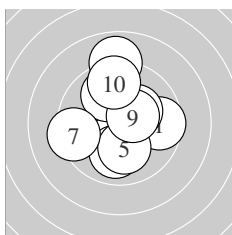
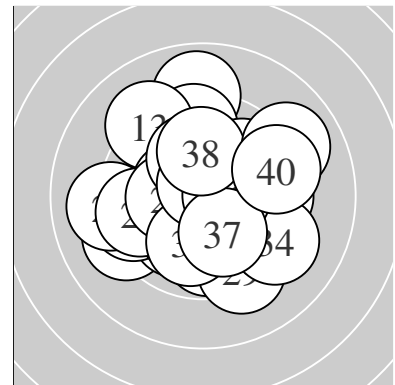

Serie 1:
 9.6 → 10.4 * 10.0 ↓ 8.9 ↑ 10.1 ↓
 9.9 ↘ 9.4 ← 10.3 * 10.4 * 9.6 ↑
 beste Teiler 127.5 (9.) 131.2 (2.) 173.8 (8.)
 Trefferlage 0.00 mm , 0.58 mm hoch
 Streuwert 2.18, horizontal: 1.87, vertikal: 2.45

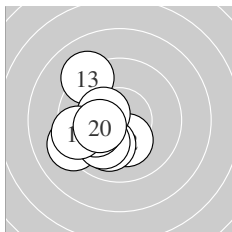

Serie 2:
 10.3 * 10.2 * 9.2 ↘ 10.1 ↓ 9.2 ←
 10.0 ↙ 10.1 ← 10.4 * 9.5 ← 10.3 *
 beste Teiler 146.3 (18.) 152.3 (11.) 175.2 (20.)
 Trefferlage 1.82 mm links, 0.66 mm tief
 Streuwert 1.52, horizontal: 1.31, vertikal: 1.70

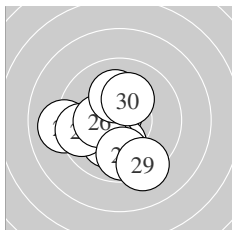

Serie 3:
 10.7 * 9.1 ← 10.2 * 10.1 ↓ 9.6 ←
 10.3 * 10.1 ↑ 9.8 ↓ 9.3 ↓ 10.2 *
 beste Teiler 54.0 (21.) 169.1 (26.) 189.9 (30.)
 Trefferlage 0.83 mm links, 0.75 mm tief
 Streuwert 1.91, horizontal: 1.94, vertikal: 1.88

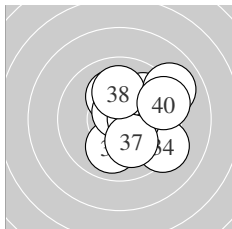

Serie 4:
 9.9 ↗ 10.1 ↖ 10.0 ↓ 9.2 ↘ 10.7 *
 10.5 * 10.1 ↓ 10.0 ↑ 9.0 ↗ 9.4 →
 beste Teiler 60.8 (35.) 120.0 (36.) 201.1 (32.)
 Trefferlage 1.42 mm rechts, 0.39 mm hoch
 Streuwert 1.89, horizontal: 1.88, vertikal: 1.90

Unterschrift des Schützen

Ergebnis: **385** (402.2)
 Serien: 100 95 97 93
 Zähler: 26 13 1 0 0 0 0 0 0 0
 Innenzehner: 18
 weiteste: 621 (24), 469 (19), 423 (25)
 beste Teiler 55.3 (23.) 80.2 (26.) 82.3 (3.)
 Trefferlage 0.38 mm rechts, 0.61 mm tief
 Streuwert 1.72, horizontal: 2.11, vertikal: 1.21

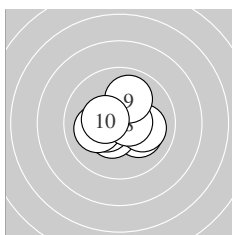
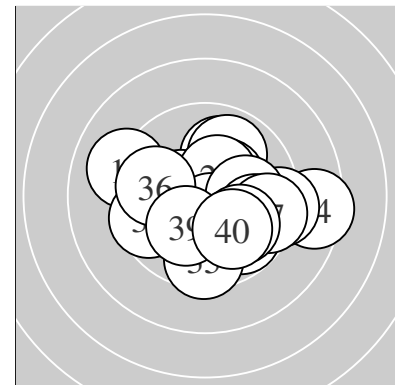

Serie 1:
 10.4 * 10.1 ↘ 10.6 * 10.4 * 10.4 *
 10.1 ← 10.1 → 10.6 * 10.0 ↑ 10.4 *
 beste Teiler 82.3 (3.) 86.4 (8.) 126.1 (4.)
 Trefferlage 0.08 mm links, 0.03 mm tief
 Streuwert 1.24, horizontal: 1.44, vertikal: 0.99

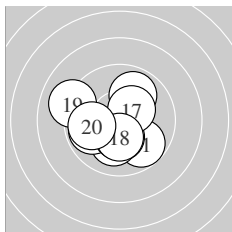

Serie 2:
 9.8 ↘ 9.9 ↗ 10.3 * 10.1 ↓ 9.9 ←
 10.4 * 10.4 * 10.3 * 9.1 ↖ 9.9 ←
 beste Teiler 147.9 (16.) 149.4 (17.) 157.2 (13.)
 Trefferlage 0.58 mm links, 0.55 mm tief
 Streuwert 1.82, horizontal: 2.02, vertikal: 1.60

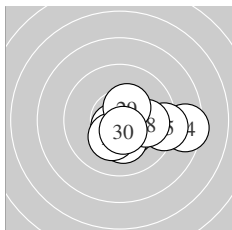

Serie 3:
 10.4 * 10.2 * 10.7 * 8.5 → 9.3 →
 10.6 * 10.3 * 10.0 → 10.4 * 10.5 *
 beste Teiler 55.3 (23.) 80.2 (26.) 101.5 (30.)
 Trefferlage 1.46 mm rechts, 0.64 mm tief
 Streuwert 1.66, horizontal: 2.19, vertikal: 0.84

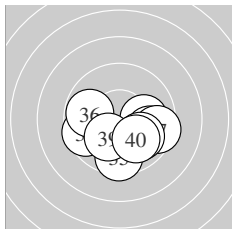

Serie 4:
 9.9 → 9.6 ← 10.0 → 9.7 → 9.5 ↓
 9.8 ← 9.5 → 9.9 ↘ 10.2 * 10.0 ↘
 beste Teiler 200.5 (39.) 228.0 (33.) 242.2 (40.)
 Trefferlage 0.74 mm rechts, 1.21 mm tief
 Streuwert 1.87, horizontal: 2.39, vertikal: 1.12

Unterschrift des Schützen

Meyton Elektronik

Ergebnis:	376	(393.2)
Serien:	96 93 96 91	
Zähler:	19 18 3 0 0 0 0 0 0 0	
Innenzehner:	15	
weiteste:	653 (15), 616 (34), 562 (39)	
beste Teiler	27.1 (7.) 27.8 (18.) 49.7 (40.)	
Trefferlage	0.44 mm links, 0.58 mm hoch	
Streuwert	2.24, horizontal: 2.52, vertikal: 1.91	

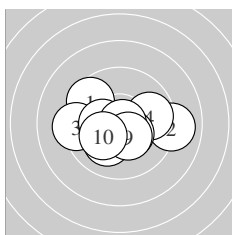
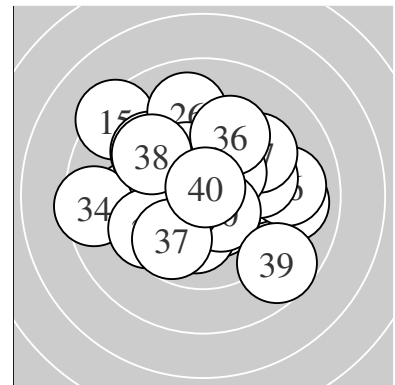

Serie 1:

9.6 ↘	9.0 →	9.3 ←	9.8 →	10.3 *
10.4 *	10.8 *	10.1 ↙	10.4 *	10.2 *
beste Teiler	27.1 (7.) 139.3 (6.) 145.0 (9.)			
Trefferlage	0.14 mm links, 0.31 mm tief			
Streuwert	2.03, horizontal: 2.65, vertikal: 1.10			

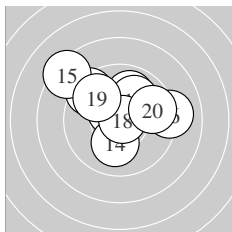

Serie 2:

9.4 ↘	9.9 ↗	10.5 *	10.1 ↓	8.3 ↖
9.1 →	10.0 ↗	10.8 *	9.8 ↘	9.7 →
beste Teiler	27.8 (18.) 111.0 (13.) 215.1 (14.)			
Trefferlage	0.07 mm links, 1.37 mm hoch			
Streuwert	2.34, horizontal: 2.83, vertikal: 1.73			

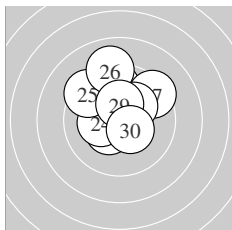

Serie 3:

9.7 ↑	10.3 *	10.4 *	10.3 *	9.4 ↖
9.0 ↑	9.4 ↗	10.2 *	10.4 *	10.4 *
beste Teiler	133.8 (30.) 140.7 (23.) 150.0 (29.)			
Trefferlage	0.17 mm links, 1.50 mm hoch			
Streuwert	1.75, horizontal: 1.69, vertikal: 1.81			

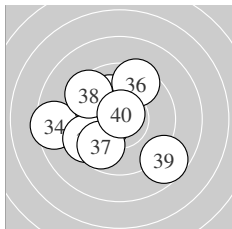

Serie 4:

9.4 ←	10.4 *	10.1 ↖	8.5 ←	9.5 ↙
9.5 ↗	9.8 ↙	9.5 ↘	8.7 ↘	10.8 *
beste Teiler	49.7 (40.) 146.9 (32.) 211.5 (33.)			
Trefferlage	1.40 mm links, 0.21 mm tief			
Streuwert	2.59, horizontal: 2.88, vertikal: 2.25			

Unterschrift des Schützen

Meyton Elektronik

Ergebnis: **370** (388.5)
 Serien: 92 91 91 96
 Zähler: 16 18 6 0 0 0 0 0 0 0
 Innenzehner: 12
 weiteste: 630 (13), 618 (12), 585 (27)
 beste Teiler 53.3 (30.) 62.0 (33.) 63.1 (19.)
 Trefferlage 1.14 mm rechts, 0.80 mm hoch
 Streuwert 2.30, horizontal: 2.81, vertikal: 1.62

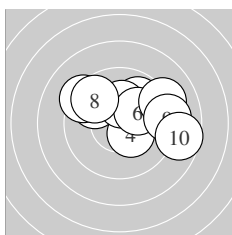
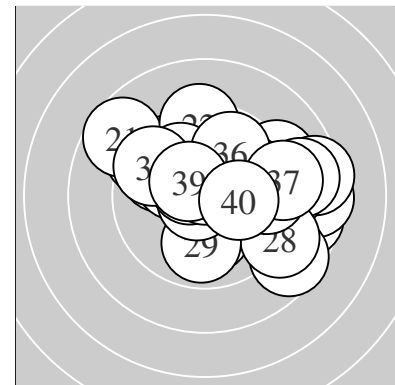

Serie 1:
 9.9 ↗ 9.8 ↘ 9.3 ↘ 10.4 * 10.2 *
 10.1 ↗ 9.1 ↗ 9.6 ↘ 9.1 → 8.7 →
 beste Teiler 143.6 (4.) 180.1 (5.) 204.1 (6.)
 Trefferlage 1.07 mm rechts, 1.16 mm hoch
 Streuwert 2.38, horizontal: 3.10, vertikal: 1.32

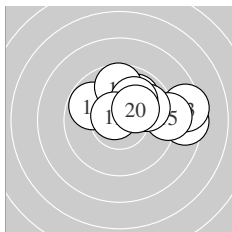

Serie 2:
 9.8 ↘ 8.5 → 8.4 → 9.9 ↗ 9.1 →
 9.8 ↗ 9.7 ↑ 10.0 ↗ 10.7 * 10.2 *
 beste Teiler 63.1 (19.) 183.6 (20.) 229.6 (18.)
 Trefferlage 2.06 mm rechts, 1.24 mm hoch
 Streuwert 2.14, horizontal: 2.87, vertikal: 0.95

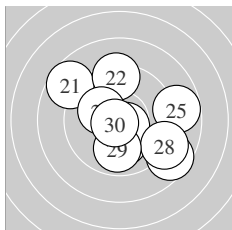

Serie 3:
 8.7 ↘ 9.3 ↑ 10.1 ↓ 10.6 * 8.8 →
 10.2 * 8.6 ↘ 9.0 ↘ 9.9 ↓ 10.7 *
 beste Teiler 53.3 (30.) 81.3 (24.) 192.7 (26.)
 Trefferlage 0.78 mm rechts, 0.20 mm tief
 Streuwert 2.86, horizontal: 3.14, vertikal: 2.55

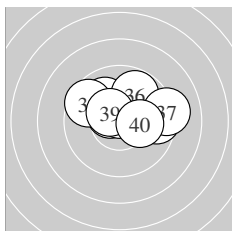

Serie 4:
 10.0 ↘ 10.5 * 10.7 * 10.2 * 9.6 →
 9.8 ↗ 9.2 → 9.6 ↘ 10.5 * 10.2 *
 beste Teiler 62.0 (33.) 107.4 (32.) 122.4 (39.)
 Trefferlage 0.66 mm rechts, 1.01 mm hoch
 Streuwert 1.73, horizontal: 2.29, vertikal: 0.84

Unterschrift des Schützen

Meyton Elektronik

Ergebnis: **393** (410.2)
 Serien: 97 97 99 100
 Zähler: 33 7 0 0 0 0 0 0 0 0
 Innenzehner: 25
 weiteste: 461 (7), 331 (15), 329 (8)
 beste Teiler 42.8 (11.) 54.1 (31.) 68.0 (16.)
 Trefferlage 0.12 mm links, 0.06 mm hoch
 Streuwert 1.40, horizontal: 1.50, vertikal: 1.29

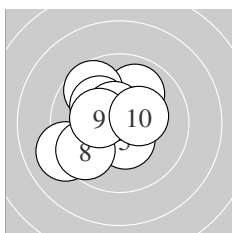
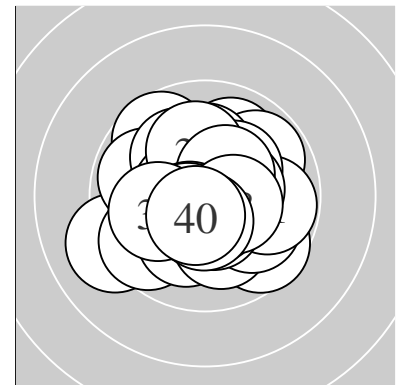

Serie 1:
 10.4 * 10.0 ↗ 9.7 ↘ 10.1 ↘ 10.4 *
 10.6 * 9.1 ↙ 9.6 ↖ 10.3 * 10.3 *
 beste Teiler 99.8 (6.) 130.6 (5.) 147.1 (1.)
 Trefferlage 0.80 mm links, 0.35 mm hoch
 Streuwert 1.74, horizontal: 1.84, vertikal: 1.64

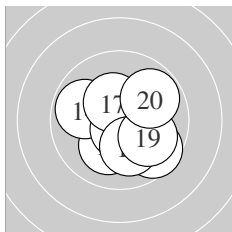

Serie 2:
 10.8 * 10.5 * 10.1 ↘ 9.8 ↖ 9.6 ↘
 10.7 * 10.4 * 10.1 ↘ 10.0 ↘ 9.8 ↗
 beste Teiler 42.8 (11.) 68.0 (16.) 118.0 (12.)
 Trefferlage 0.30 mm rechts, 0.37 mm tief
 Streuwert 1.55, horizontal: 1.65, vertikal: 1.43

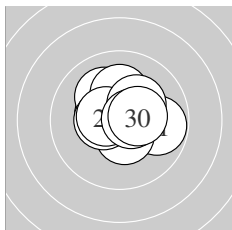

Serie 3:
 9.8 → 10.5 * 10.1 ↘ 10.2 * 10.5 *
 10.5 * 10.5 * 10.3 * 10.6 * 10.4 *
 beste Teiler 87.4 (29.) 106.7 (27.) 118.2 (25.)
 Trefferlage 0.21 mm rechts, 0.45 mm hoch
 Streuwert 1.19, horizontal: 1.38, vertikal: 0.95

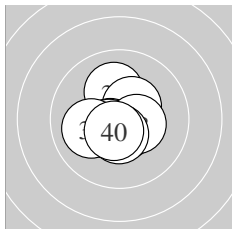

Serie 4:
 10.7 * 10.1 ↗ 10.4 * 10.6 * 10.6 *
 10.5 * 10.1 ↙ 10.4 * 10.5 * 10.6 *
 beste Teiler 54.1 (31.) 90.0 (34.) 98.2 (35.)
 Trefferlage 0.18 mm links, 0.18 mm tief
 Streuwert 1.00, horizontal: 0.96, vertikal: 1.03

Unterschrift des Schützen

Ergebnis: **394** (414.9)
 Serien: 99 99 99 97
 Zähler: 34 6 0 0 0 0 0 0 0 0
 Innenzehner: 28
 weiteste: 334 (28), 324 (31), 297 (39)
 beste Teiler 22.1 (29.) 24.2 (9.) 26.0 (11.)
 Trefferlage 0.32 mm rechts, 0.10 mm hoch
 Streuwert 1.21, horizontal: 1.40, vertikal: 0.98

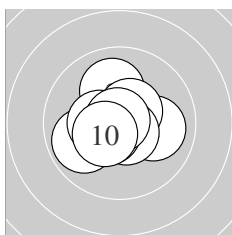
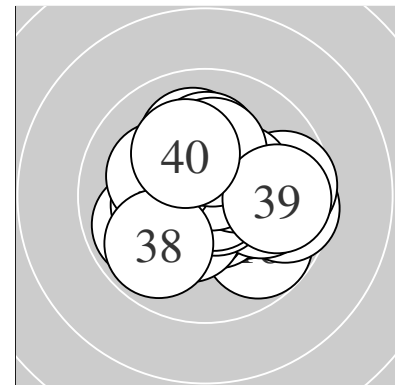

Serie 1:
 10.7 * 10.0 → 10.0 ↑ 10.5 * 9.9 ←
 10.6 * 10.4 * 10.6 * 10.9 * 10.5 *
 beste Teiler 24.2 (9.) 73.3 (1.) 78.6 (6.)
 Trefferlage 0.29 mm links, 0.04 mm hoch
 Streuwert 1.15, horizontal: 1.29, vertikal: 1.00

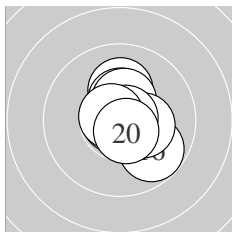

Serie 2:
 10.8 * 10.1 ↑ 10.4 * 10.4 * 10.8 *
 9.8 ↘ 10.3 * 10.8 * 10.7 * 10.6 *
 beste Teiler 26.0 (11.) 35.0 (15.) 43.0 (18.)
 Trefferlage 0.40 mm rechts, 0.22 mm hoch
 Streuwert 1.01, horizontal: 0.85, vertikal: 1.16

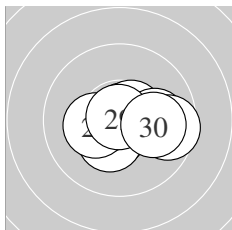

Serie 3:
 10.8 * 10.6 * 10.6 * 10.5 * 10.4 *
 10.0 → 10.3 * 9.6 → 10.9 * 10.0 →
 beste Teiler 22.1 (29.) 41.2 (21.) 93.4 (23.)
 Trefferlage 0.73 mm rechts, 0.26 mm tief
 Streuwert 1.17, horizontal: 1.56, vertikal: 0.57

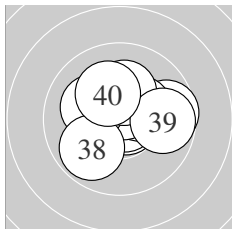

Serie 4:
 9.7 → 10.8 * 10.8 * 10.3 * 10.6 *
 10.1 ↖ 10.2 * 9.9 ↙ 9.8 → 10.2 *
 beste Teiler 37.0 (33.) 49.1 (32.) 86.3 (35.)
 Trefferlage 0.43 mm rechts, 0.40 mm hoch
 Streuwert 1.45, horizontal: 1.74, vertikal: 1.09

Unterschrift des Schützen

Meyton Elektronik

Ergebnis: **387** (407.1)
 Serien: 97 93 98 99
 Zähler: 28 11 1 0 0 0 0 0 0
 Innenzehner: 24
 weiteste: 513 (14), 471 (40), 379 (5)
 beste Teiler 11.0 (9.) 42.5 (36.) 62.1 (33.)
 Trefferlage 0.00 mm , 0.61 mm hoch
 Streuwert 1.53, horizontal: 1.63, vertikal: 1.43

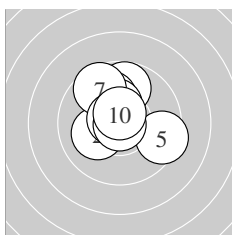
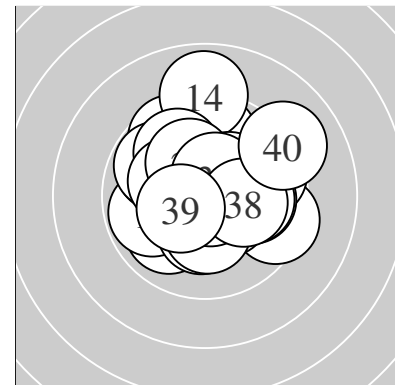

Serie 1:
 10.3 * 10.1 ← 9.8 ↑ 10.0 ↗ 9.4 →
 10.3 * 9.6 ↘ 10.7 * 10.9 * 10.6 *
 beste Teiler 11.0 (9.) 65.4 (8.) 83.0 (10.)
 Trefferlage 0.16 mm links, 1.02 mm hoch
 Streuwert 1.49, horizontal: 1.50, vertikal: 1.48

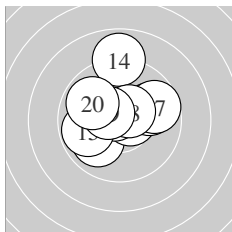

Serie 2:
 9.9 ↙ 10.6 * 10.7 * 8.9 ↑ 9.8 ←
 9.9 → 9.7 → 10.5 * 10.5 * 9.9 ↘
 beste Teiler 63.0 (13.) 91.1 (12.) 109.6 (18.)
 Trefferlage 0.11 mm links, 0.79 mm hoch
 Streuwert 1.86, horizontal: 1.93, vertikal: 1.80

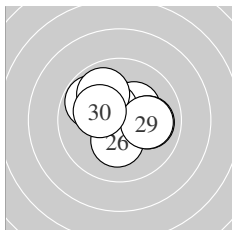

Serie 3:
 10.4 * 9.8 ↘ 10.4 * 10.3 * 10.5 *
 10.3 * 10.0 → 9.9 ↘ 10.0 → 10.2 *
 beste Teiler 118.6 (25.) 127.9 (21.) 128.3 (23.)
 Trefferlage 0.20 mm links, 0.61 mm hoch
 Streuwert 1.41, horizontal: 1.66, vertikal: 1.10

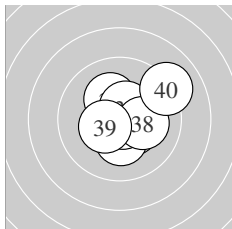

Serie 4:
 10.4 * 10.6 * 10.7 * 10.3 * 10.2 *
 10.8 * 10.5 * 10.2 * 10.4 * 9.1 →
 beste Teiler 42.5 (36.) 62.1 (33.) 94.6 (32.)
 Trefferlage 0.47 mm rechts, 0.03 mm hoch
 Streuwert 1.43, horizontal: 1.55, vertikal: 1.30

Unterschrift des Schützen

Meyton Elektronik

Ergebnis: **390** (409.3)
 Serien: 98 97 97 98
 Zähler: 31 8 1 0 0 0 0 0 0
 Innenzehner: 26
 weiteste: 648 (26), 430 (22), 349 (39)
 beste Teiler 11.6 (32.) 40.4 (25.) 45.1 (24.)
 Trefferlage 0.00 mm , 0.08 mm hoch
 Streuwert 1.55, horizontal: 1.68, vertikal: 1.40

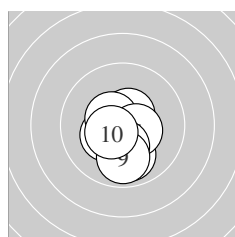
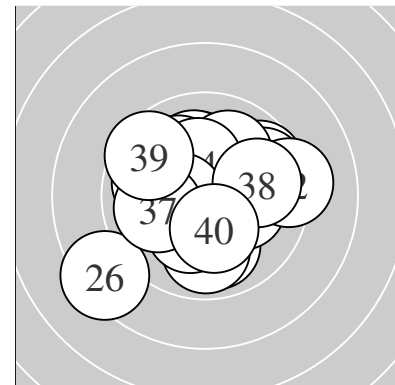

Serie 1:
 10.3 * 10.7 * 10.6 * 10.5 * 9.9 ↓
 10.5 * 10.5 * 10.2 * 9.9 ↓ 10.5 *
 beste Teiler 67.5 (2.) 99.8 (3.) 109.9 (4.)
 Trefferlage 0.09 mm links, 0.79 mm tief
 Streuwert 1.05, horizontal: 0.79, vertikal: 1.26

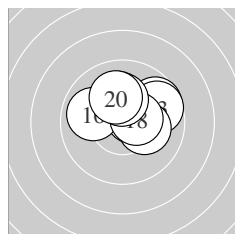

Serie 2:
 10.5 * 9.7 ↗ 9.7 ↗ 10.6 * 10.1 ↑
 9.9 ↖ 10.2 * 10.5 * 10.2 * 10.1 ↑
 beste Teiler 93.0 (14.) 110.0 (11.) 120.5 (18.)
 Trefferlage 0.69 mm rechts, 1.02 mm hoch
 Streuwert 1.31, horizontal: 1.64, vertikal: 0.87

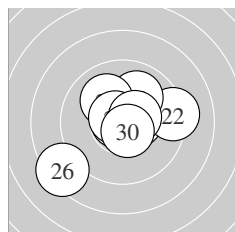

Serie 3:
 10.5 * 9.2 → 10.0 ↗ 10.8 * 10.8 *
 8.4 ↙ 10.0 ↘ 10.7 * 10.5 * 10.6 *
 beste Teiler 40.4 (25.) 45.1 (24.) 74.0 (28.)
 Trefferlage 0.03 mm rechts, 0.11 mm hoch
 Streuwert 2.05, horizontal: 2.36, vertikal: 1.68

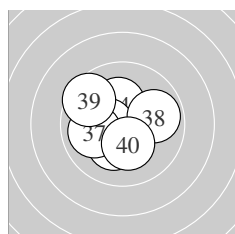

Serie 4:
 10.7 * 10.9 * 10.4 * 10.3 * 10.2 *
 10.4 * 10.0 ← 9.9 → 9.6 ↖ 10.3 *
 beste Teiler 11.6 (32.) 53.0 (31.) 128.1 (36.)
 Trefferlage 0.62 mm links, 0.01 mm tief
 Streuwert 1.39, horizontal: 1.54, vertikal: 1.23

Unterschrift des Schützen

Meyton Elektronik

Ergebnis: **383** (399.8)
 Serien: 96 97 95 95
 Zähler: 24 15 1 0 0 0 0 0 0 0
 Innenzehner: 17
 weiteste: 545 (20), 439 (2), 433 (3)
 beste Teiler 49.3 (38.) 83.4 (32.) 115.2 (8.)
 Trefferlage 0.03 mm links, 0.05 mm tief
 Streuwert 1.90, horizontal: 2.13, vertikal: 1.63

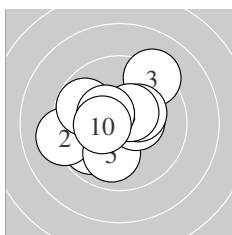
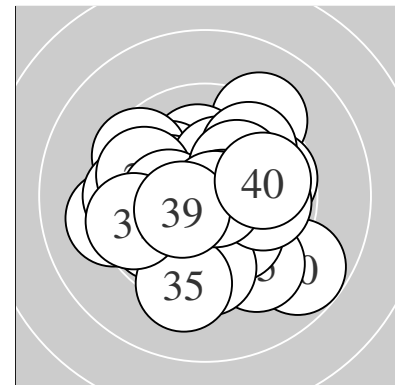

Serie 1:
 9.8 ↙ 9.2 ← 9.2 ↗ 9.8 ↘ 10.0 ↓
 10.4 * 10.3 * 10.5 * 10.4 * 10.4 *
 beste Teiler 115.2 (8.) 128.5 (6.) 130.6 (9.)
 Trefferlage 0.61 mm links, 0.19 mm hoch
 Streuwert 1.91, horizontal: 2.13, vertikal: 1.67

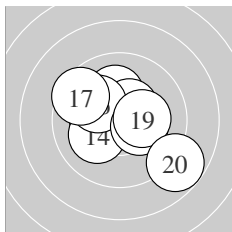

Serie 2:
 10.1 ↑ 10.3 * 10.1 ↘ 10.1 ↖ 10.5 *
 10.1 ↘ 9.5 ↘ 10.3 * 10.3 * 8.8 ↘
 beste Teiler 123.2 (15.) 161.6 (18.) 167.2 (12.)
 Trefferlage 0.18 mm links, 0.25 mm hoch
 Streuwert 1.96, horizontal: 2.25, vertikal: 1.61

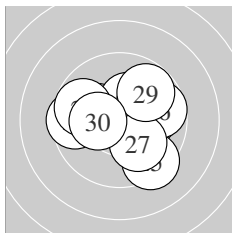

Serie 3:
 10.2 * 10.0 → 10.3 * 9.6 ← 9.4 ↘
 9.7 → 10.1 ↘ 9.8 ↖ 9.8 ↗ 10.3 *
 beste Teiler 160.7 (23.) 169.1 (30.) 181.2 (21.)
 Trefferlage 0.21 mm rechts, 0.13 mm hoch
 Streuwert 2.03, horizontal: 2.41, vertikal: 1.56

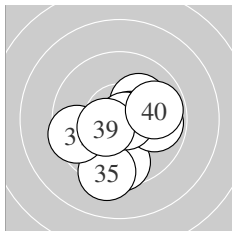

Serie 4:
 10.2 * 10.6 * 10.3 * 9.6 ↓ 9.3 ↓
 9.9 → 9.5 ← 10.8 * 10.5 * 9.8 →
 beste Teiler 49.3 (38.) 83.4 (32.) 124.6 (39.)
 Trefferlage 0.46 mm rechts, 0.78 mm tief
 Streuwert 1.79, horizontal: 1.88, vertikal: 1.69

Unterschrift des Schützen

Meyton Elektronik

Ergebnis: **386** (406.7)
 Serien: 95 97 96 98
 Zähler: 26 14 0 0 0 0 0 0 0 0
 Innenzehner: 23
 weiteste: 456 (38), 436 (6), 436 (35)
 beste Teiler 10.0 (20.) 25.9 (12.) 48.0 (14.)
 Trefferlage 0.17 mm rechts, 0.14 mm tief
 Streuwert 1.63, horizontal: 2.01, vertikal: 1.13

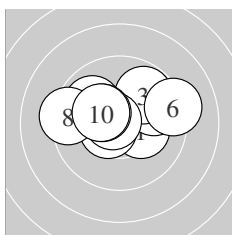
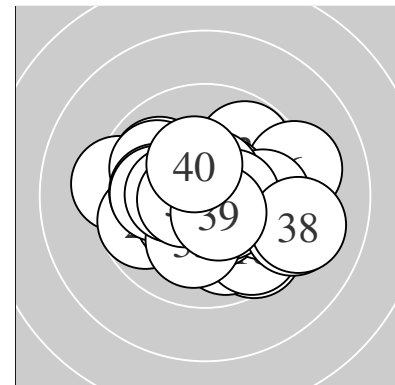

Serie 1:
 10.3 * 9.8 ↗ 9.8 ↗ 10.5 * 10.7 *
 9.2 → 9.9 ↘ 9.3 ← 10.3 * 10.3 *
 beste Teiler 56.6 (5.) 102.5 (4.) 157.4 (9.)
 Trefferlage 0.00 mm , 0.75 mm hoch
 Streuwert 1.88, horizontal: 2.51, vertikal: 0.86

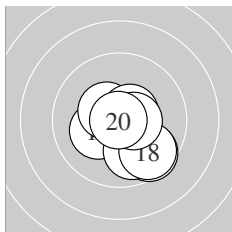

Serie 2:
 10.2 * 10.9 * 10.5 * 10.8 * 10.6 *
 9.6 ↘ 9.9 ↘ 9.7 ↘ 10.5 * 10.9 *
 beste Teiler 10.0 (20.) 25.9 (12.) 48.0 (14.)
 Trefferlage 0.52 mm rechts, 0.67 mm tief
 Streuwert 1.27, horizontal: 1.25, vertikal: 1.28

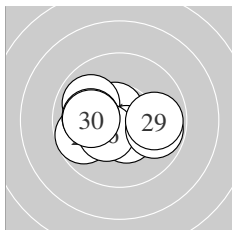

Serie 3:
 10.6 * 10.5 * 10.3 * 9.9 ↘ 9.7 ←
 10.4 * 9.8 → 10.1 ← 9.9 → 10.1 ←
 beste Teiler 80.0 (21.) 123.4 (22.) 140.7 (26.)
 Trefferlage 0.66 mm links, 0.21 mm tief
 Streuwert 1.56, horizontal: 2.04, vertikal: 0.82

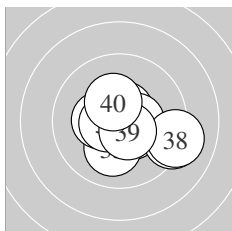

Serie 4:
 10.6 * 10.5 * 10.1 ↓ 10.3 * 9.2 →
 10.6 * 10.4 * 9.1 → 10.6 * 10.3 *
 beste Teiler 91.2 (31.) 95.3 (36.) 100.2 (39.)
 Trefferlage 0.81 mm rechts, 0.43 mm tief
 Streuwert 1.61, horizontal: 2.00, vertikal: 1.08

Unterschrift des Schützen

Meyton Elektronik

Ergebnis: **367** (385.4)
 Serien: 90 91 95 91
 Zähler: 17 15 6 2 0 0 0 0 0 0
 Innenzehner: 14
 weiteste: 903 (12), 828 (2), 677 (40)
 beste Teiler 22.4 (23.) 52.9 (38.) 54.0 (20.)
 Trefferlage 0.49 mm rechts, 0.74 mm tief
 Streuwert 2.73, horizontal: 3.21, vertikal: 2.15

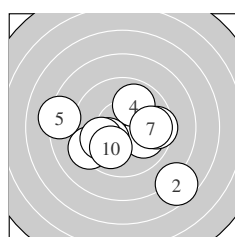
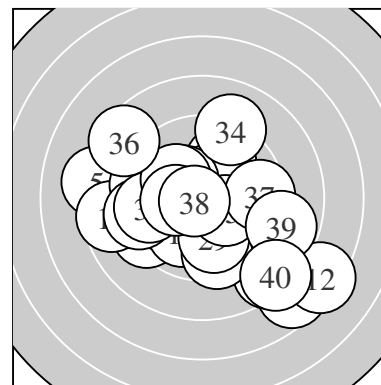

Serie 1:
 9.3 ↙ 7.6 ↘ 10.0 ↘ 9.9 ↗ 8.3 ←
 9.5 → 9.7 → 10.2 * 9.9 ↙ 10.0 ↘
 beste Teiler 199.1 (8.) 244.3 (3.) 246.9 (10.)
 Trefferlage 0.04 mm rechts, 1.05 mm tief
 Streuwert 3.09, horizontal: 3.75, vertikal: 2.23

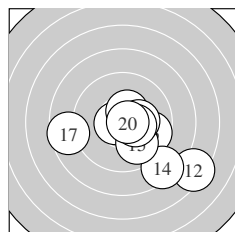

Serie 2:
 10.6 * 7.3 ↘ 9.7 ↘ 8.4 ↘ 9.9 ↘
 10.5 * 8.6 ← 10.3 * 10.4 * 10.7 *
 beste Teiler 54.0 (20.) 79.0 (11.) 124.2 (16.)
 Trefferlage 1.37 mm rechts, 1.35 mm tief
 Streuwert 2.83, horizontal: 3.41, vertikal: 2.08

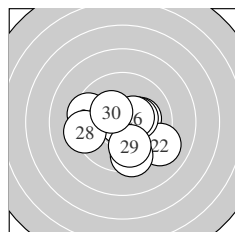

Serie 3:
 10.2 * 9.1 ↘ 10.9 * 9.5 ↓ 10.3 *
 10.5 * 9.5 ← 9.3 ← 9.9 ↓ 10.3 *
 beste Teiler 22.4 (23.) 122.1 (26.) 157.4 (25.)
 Trefferlage 0.11 mm rechts, 0.63 mm tief
 Streuwert 2.08, horizontal: 2.45, vertikal: 1.63

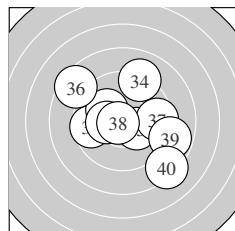

Serie 4:
 9.6 ← 10.1 ↘ 10.3 * 9.1 ↗ 10.3 *
 8.5 ↘ 9.5 → 10.7 * 8.8 → 8.2 ↘
 beste Teiler 52.9 (38.) 167.6 (33.) 169.1 (35.)
 Trefferlage 0.45 mm rechts, 0.08 mm hoch
 Streuwert 3.04, horizontal: 3.42, vertikal: 2.61

Unterschrift des Schützen

Meyton Elektronik

Ergebnis: **381** (399.9)
 Serien: 96 92 96 97
 Zähler: 24 14 1 1 0 0 0 0 0 0
 Innenzehner: 19
 weiteste: 884 (13), 512 (19), 474 (31)
 beste Teiler 9.8 (39.) 23.8 (8.) 44.2 (15.)
 Trefferlage 0.36 mm links, 0.58 mm hoch
 Streuwert 2.00, horizontal: 2.20, vertikal: 1.76

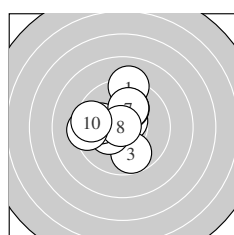
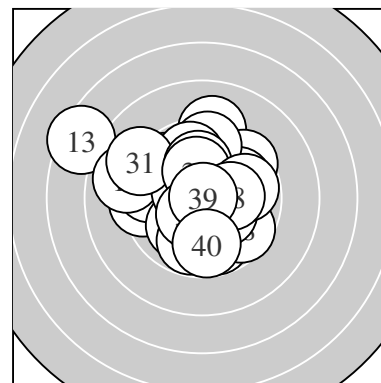

Serie 1:
 9.1 ↑ 10.6 * 9.8 ↓ 10.1 ↑ 10.3 *
 10.0 ← 10.1 ↑ 10.9 * 9.4 ← 9.6 ←
 beste Teiler 23.8 (8.) 85.8 (2.) 165.4 (5.)
 Trefferlage 0.80 mm links, 0.66 mm hoch
 Streuwert 1.90, horizontal: 1.86, vertikal: 1.94

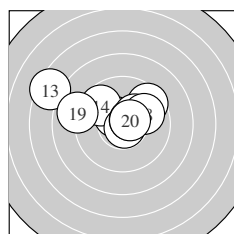

Serie 2:
 10.5 * 9.5 ↗ 7.4 ↖ 9.7 ↖ 10.8 *
 10.6 * 10.3 * 9.9 ↗ 8.9 ← 10.6 *
 beste Teiler 44.2 (15.) 90.5 (16.) 91.2 (20.)
 Trefferlage 0.79 mm links, 1.28 mm hoch
 Streuwert 2.55, horizontal: 3.41, vertikal: 1.18

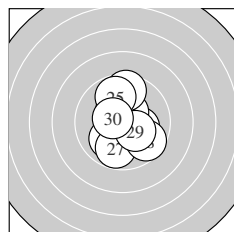

Serie 3:
 10.3 * 10.2 * 10.5 * 9.6 ↑ 9.8 ↑
 10.0 ↘ 9.8 ↓ 9.6 ↘ 10.3 * 10.5 *
 beste Teiler 115.8 (30.) 123.6 (23.) 159.6 (21.)
 Trefferlage 0.20 mm rechts, 0.09 mm hoch
 Streuwert 1.77, horizontal: 1.37, vertikal: 2.09

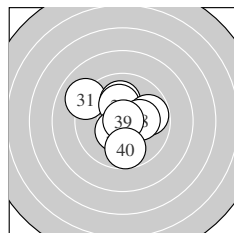

Serie 4:
 9.1 ↖ 10.1 ↑ 10.3 * 10.5 * 10.2 *
 10.4 * 9.8 → 10.2 * 10.9 * 9.7 ↓
 beste Teiler 9.8 (39.) 105.0 (34.) 133.0 (36.)
 Trefferlage 0.07 mm links, 0.27 mm hoch
 Streuwert 1.77, horizontal: 1.80, vertikal: 1.73

Unterschrift des Schützen

Meyton Elektronik

Ergebnis: **395** (413.0)
 Serien: 99 98 99 99
 Zähler: 35 5 0 0 0 0 0 0 0 0
 Innenzehner: 28
 weiteste: 344 (31), 309 (2), 272 (11)
 beste Teiler 33.9 (29.) 43.1 (14.) 56.5 (15.)
 Trefferlage 0.37 mm links, 0.29 mm hoch
 Streuwert 1.21, horizontal: 1.32, vertikal: 1.09

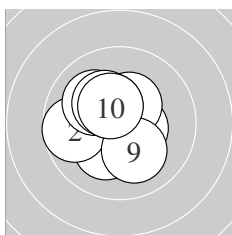
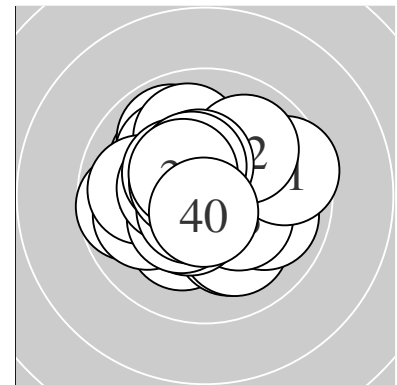

Serie 1:
 10.2 * 9.7 ← 10.1 ↖ 10.5 * 10.5 *
 10.4 * 10.4 * 10.3 * 10.1 ↘ 10.4 *
 beste Teiler 108.8 (5.) 114.4 (4.) 133.7 (10.)
 Trefferlage 0.49 mm links, 0.31 mm hoch
 Streuwert 1.29, horizontal: 1.31, vertikal: 1.28

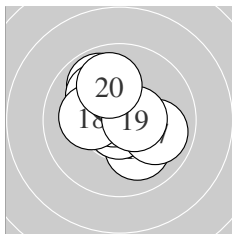

Serie 2:
 9.9 ↖ 10.1 ↖ 10.1 ↘ 10.8 * 10.7 *
 10.6 * 9.9 → 10.2 * 10.5 * 10.0 ↖
 beste Teiler 43.1 (14.) 56.5 (15.) 93.8 (16.)
 Trefferlage 0.17 mm links, 0.47 mm hoch
 Streuwert 1.37, horizontal: 1.37, vertikal: 1.37

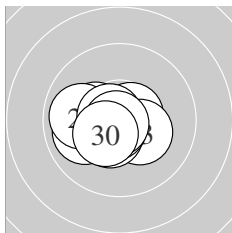

Serie 3:
 10.0 ← 10.6 * 10.3 * 10.5 * 10.3 *
 10.7 * 9.9 ← 10.7 * 10.8 * 10.4 *
 beste Teiler 33.9 (29.) 64.4 (26.) 72.1 (28.)
 Trefferlage 0.73 mm links, 0.31 mm tief
 Streuwert 0.97, horizontal: 1.25, vertikal: 0.57

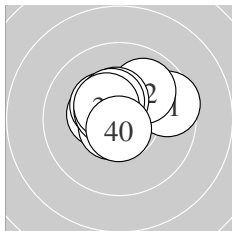

Serie 4:
 9.6 → 10.0 ↗ 10.4 * 10.4 * 10.6 *
 10.5 * 10.4 * 10.4 * 10.4 * 10.7 *
 beste Teiler 67.2 (40.) 79.2 (35.) 103.7 (36.)
 Trefferlage 0.08 mm links, 0.70 mm hoch
 Streuwert 1.17, horizontal: 1.45, vertikal: 0.81

Unterschrift des Schützen

Meyton Elektronik

Ergebnis: **384** (400.3)
 Serien: 97 97 95 95
 Zähler: 25 14 1 0 0 0 0 0 0 0
 Innenzehner: 19
 weiteste: 562 (38), 475 (7), 443 (40)
 beste Teiler 64.0 (1.) 87.5 (37.) 88.2 (32.)
 Trefferlage 0.12 mm links, 1.03 mm hoch
 Streuwert 1.77, horizontal: 1.95, vertikal: 1.57

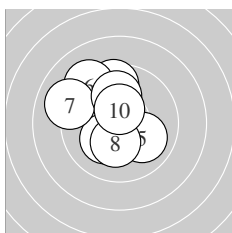
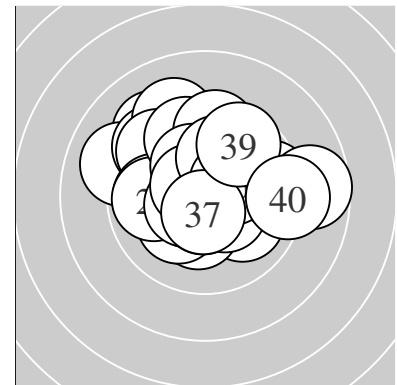

Serie 1:
 10.7 * 10.6 * 9.6 ↑ 10.2 * 10.0 ↘
 9.2 ↘ 9.1 ↖ 10.3 * 10.0 ↑ 10.5 *
 beste Teiler 64.0 (1.) 95.6 (2.) 124.0 (10.)
 Trefferlage 0.84 mm links, 0.78 mm hoch
 Streuwert 1.85, horizontal: 1.72, vertikal: 1.96

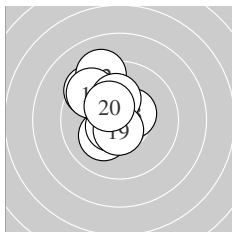

Serie 2:
 9.4 ↘ 9.2 ↑ 10.5 * 10.1 ↘ 9.6 ↘
 10.2 * 10.6 * 10.2 * 10.6 * 10.3 *
 beste Teiler 88.6 (19.) 96.5 (17.) 120.4 (13.)
 Trefferlage 1.04 mm links, 1.18 mm hoch
 Streuwert 1.46, horizontal: 1.12, vertikal: 1.73

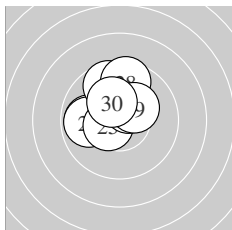

Serie 3:
 10.0 ↑ 9.9 ← 9.7 ↑ 9.9 ← 10.5 *
 9.7 ↑ 10.4 * 9.6 ↑ 10.3 * 10.3 *
 beste Teiler 111.8 (25.) 133.0 (27.) 170.2 (29.)
 Trefferlage 0.54 mm links, 1.50 mm hoch
 Streuwert 1.41, horizontal: 1.37, vertikal: 1.44

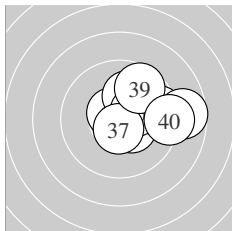

Serie 4:
 10.4 * 10.6 * 10.1 ↗ 10.1 ↑ 9.5 →
 10.3 * 10.6 * 8.7 → 9.6 ↗ 9.2 →
 beste Teiler 87.5 (37.) 88.2 (32.) 131.0 (31.)
 Trefferlage 1.92 mm rechts, 0.68 mm hoch
 Streuwert 1.63, horizontal: 1.99, vertikal: 1.14

Unterschrift des Schützen

Meyton Elektronik

Ergebnis: **380** (399.7)
 Serien: 97 94 93 96
 Zähler: 21 18 1 0 0 0 0 0 0 0
 Innenzehner: 18
 weiteste: 653 (15), 492 (18), 473 (30)
 beste Teiler 40.4 (33.) 62.9 (32.) 75.8 (20.)
 Trefferlage 0.62 mm rechts, 0.03 mm tief
 Streuwert 1.92, horizontal: 2.27, vertikal: 1.49

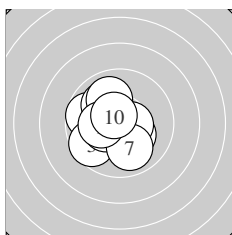
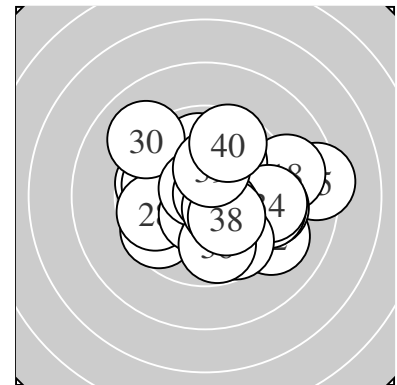

Serie 1:
 10.3 * 9.7 ← 9.6 ↙ 10.5 * 10.0 ↘
 10.4 * 9.9 ↓ 10.0 ↘ 10.2 * 10.6 *
 beste Teiler 93.0 (10.) 104.2 (4.) 143.1 (6.)
 Trefferlage 0.85 mm links, 0.07 mm tief
 Streuwert 1.51, horizontal: 1.52, vertikal: 1.49

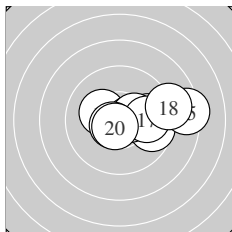

Serie 2:
 9.7 → 10.2 * 9.9 → 10.6 * 8.3 →
 10.4 * 9.9 → 9.0 → 10.6 * 10.7 *
 beste Teiler 75.8 (20.) 84.6 (19.) 99.4 (14.)
 Trefferlage 1.92 mm rechts, 0.18 mm hoch
 Streuwert 1.86, horizontal: 2.54, vertikal: 0.68

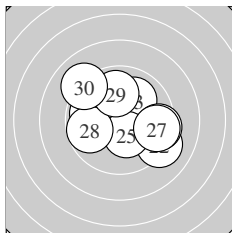

Serie 3:
 10.5 * 9.2 ↘ 10.0 ↗ 9.9 ← 10.3 *
 9.4 → 9.5 → 9.7 ← 9.9 ↑ 9.1 ↘
 beste Teiler 120.9 (21.) 154.7 (25.) 235.2 (23.)
 Trefferlage 0.46 mm rechts, 0.12 mm hoch
 Streuwert 2.37, horizontal: 2.78, vertikal: 1.87

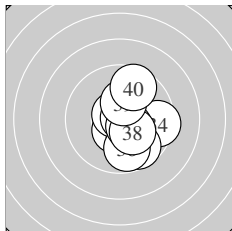

Serie 4:
 10.5 * 10.7 * 10.8 * 9.5 → 9.7 ↓
 9.8 ↓ 10.5 * 10.3 * 10.3 * 9.6 ↑
 beste Teiler 40.4 (33.) 62.9 (32.) 113.4 (37.)
 Trefferlage 0.94 mm rechts, 0.36 mm tief
 Streuwert 1.52, horizontal: 1.20, vertikal: 1.79

Unterschrift des Schützen

Meyton Elektronik

Ergebnis: **385** (400.9)
 Serien: 96 94 99 96
 Zähler: 25 15 0 0 0 0 0 0 0 0
 Innenzehner: 16
 weiteste: 499 (18), 497 (37), 444 (34)
 beste Teiler 5.8 (16.) 39.5 (25.) 42.6 (40.)
 Trefferlage 0.05 mm rechts, 0.61 mm tief
 Streuwert 1.85, horizontal: 2.24, vertikal: 1.35

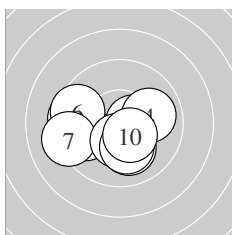
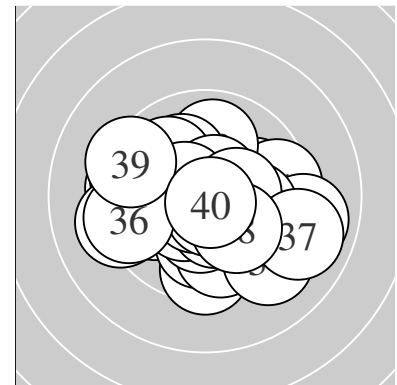

Serie 1:
 10.5 * 9.5 ← 10.1 ↓ 10.0 → 9.8 ←
 9.5 ← 9.2 ← 10.4 * 10.1 ↓ 10.4 *
 beste Teiler 110.2 (1.) 131.1 (10.) 145.2 (8.)
 Trefferlage 0.86 mm links, 0.65 mm tief
 Streuwert 1.87, horizontal: 2.41, vertikal: 1.09

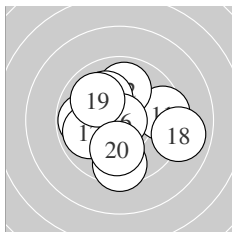

Serie 2:
 9.5 → 9.9 ↑ 10.1 ↖ 9.5 ↓ 9.8 ←
 10.9 * 9.9 ← 9.0 → 10.0 ↖ 10.0 ↓
 beste Teiler 5.8 (16.) 214.4 (13.) 235.0 (20.)
 Trefferlage 0.03 mm rechts, 0.15 mm tief
 Streuwert 2.22, horizontal: 2.48, vertikal: 1.93

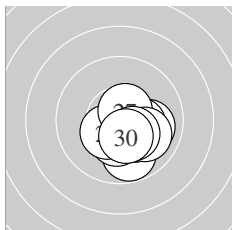

Serie 3:
 10.0 → 9.8 ↓ 10.3 * 10.3 * 10.8 *
 10.4 * 10.6 * 10.0 ↘ 10.3 * 10.4 *
 beste Teiler 39.5 (25.) 89.6 (27.) 141.4 (26.)
 Trefferlage 0.79 mm rechts, 0.92 mm tief
 Streuwert 0.98, horizontal: 1.02, vertikal: 0.95

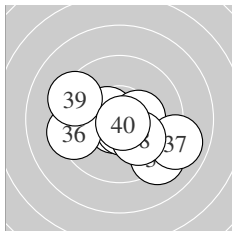

Serie 4:
 10.7 * 10.5 * 10.3 * 9.2 ↘ 10.6 *
 9.4 ← 9.0 ↘ 10.1 ↘ 9.3 ↖ 10.8 *
 beste Teiler 42.6 (40.) 74.0 (31.) 79.7 (35.)
 Trefferlage 0.24 mm rechts, 0.71 mm tief
 Streuwert 2.11, horizontal: 2.67, vertikal: 1.34

Unterschrift des Schützen

Meyton Elektronik

Ergebnis: **375** (392.8)
 Serien: 92 94 95 94
 Zähler: 18 19 3 0 0 0 0 0 0
 Innenzehner: 11
 weiteste: 603 (2), 538 (6), 535 (13)
 beste Teiler 46.5 (18.) 57.4 (5.) 90.1 (11.)
 Trefferlage 1.07 mm rechts, 0.61 mm hoch
 Streuwert 2.08, horizontal: 2.26, vertikal: 1.87

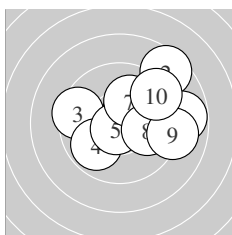
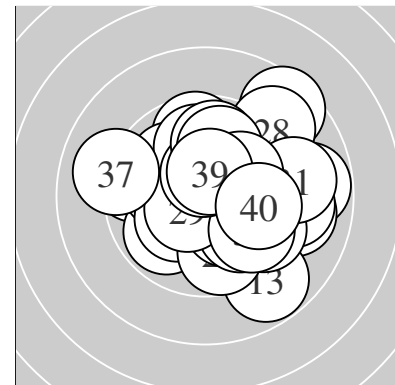

Serie 1:
 10.4 * 8.5 ↗ 9.5 ← 9.9 ↘ 10.7 *
 8.8 → 10.1 ↗ 10.0 → 9.1 → 9.3 ↗
 beste Teiler 57.4 (5.) 127.8 (1.) 211.7 (7.)
 Trefferlage 1.52 mm rechts, 0.75 mm hoch
 Streuwert 2.46, horizontal: 2.93, vertikal: 1.87

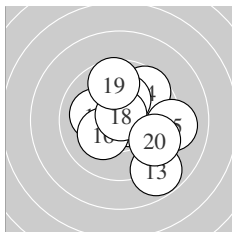

Serie 2:
 10.6 * 10.1 ← 8.8 ↘ 9.6 ↗ 9.1 →
 10.2 * 10.2 * 10.8 * 9.7 ↑ 9.6 ↘
 beste Teiler 46.5 (18.) 90.1 (11.) 183.1 (17.)
 Trefferlage 1.03 mm rechts, 0.06 mm hoch
 Streuwert 2.17, horizontal: 2.15, vertikal: 2.19

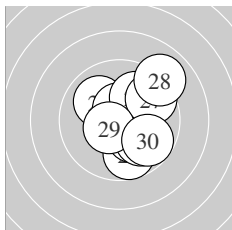

Serie 3:
 9.7 ↓ 10.2 * 10.0 ↘ 9.9 ↘ 10.6 *
 10.0 ↗ 9.6 ↗ 9.0 ↗ 10.5 * 9.8 ↘
 beste Teiler 99.6 (25.) 113.8 (29.) 183.2 (22.)
 Trefferlage 1.10 mm rechts, 0.13 mm hoch
 Streuwert 1.90, horizontal: 1.66, vertikal: 2.11

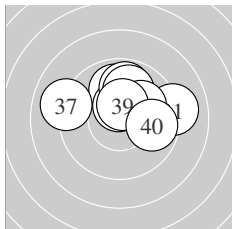

Serie 4:
 9.1 → 9.9 ↑ 10.0 ↑ 10.5 * 9.8 ↑
 9.9 ↑ 9.0 ← 10.1 ↗ 10.4 * 9.8 →
 beste Teiler 115.3 (34.) 128.4 (39.) 214.8 (38.)
 Trefferlage 0.64 mm rechts, 1.49 mm hoch
 Streuwert 1.84, horizontal: 2.40, vertikal: 0.99

Unterschrift des Schützen

Meyton Elektronik

Ergebnis: **379** (396.7)
 Serien: 97 94 93 95
 Zähler: 22 16 1 1 0 0 0 0 0 0
 Innenzehner: 18
 weiteste: 989 (15), 644 (35), 444 (34)
 beste Teiler 30.6 (24.) 39.0 (32.) 74.4 (7.)
 Trefferlage 0.00 mm , 0.43 mm hoch
 Streuwert 2.20, horizontal: 2.74, vertikal: 1.48

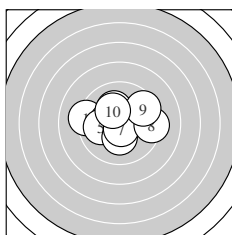
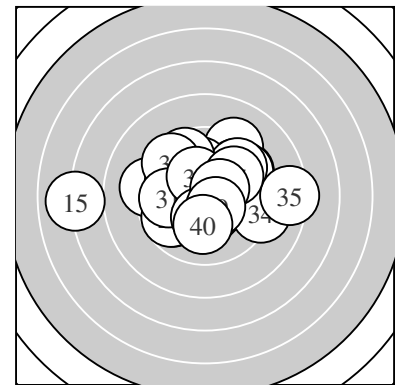

Serie 1:
 9.2 ← 10.0 ↗ 10.2 * 10.3 * 10.0 ←
 10.2 * 10.7 * 9.3 → 9.5 ↗ 10.2 *
 beste Teiler 74.4 (7.) 155.5 (4.) 179.0 (6.)
 Trefferlage 0.02 mm links, 0.42 mm hoch
 Streuwert 1.99, horizontal: 2.53, vertikal: 1.23

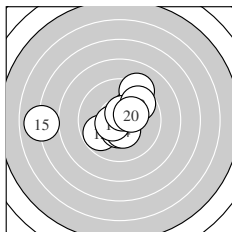

Serie 2:
 10.2 * 9.8 ↖ 10.4 * 10.4 * 7.0 ←
 9.2 ↗ 10.6 * 10.6 * 9.7 ↗ 10.3 *
 beste Teiler 94.5 (18.) 97.1 (17.) 128.1 (13.)
 Trefferlage 0.52 mm links, 0.38 mm hoch
 Streuwert 2.81, horizontal: 3.59, vertikal: 1.71

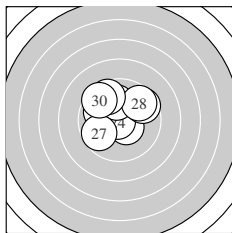

Serie 3:
 9.9 ↘ 9.9 ↘ 10.5 * 10.8 * 10.0 ↑
 9.6 ↗ 9.7 ↖ 9.6 ↗ 9.6 ↘ 9.5 ↘
 beste Teiler 30.6 (24.) 122.3 (23.) 226.0 (25.)
 Trefferlage 0.55 mm links, 1.15 mm hoch
 Streuwert 1.83, horizontal: 2.07, vertikal: 1.55

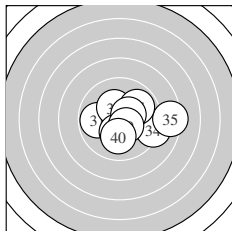

Serie 4:
 9.8 ← 10.8 * 10.3 * 9.2 → 8.4 →
 10.3 * 9.9 ↗ 10.5 * 10.5 * 10.1 ↓
 beste Teiler 39.0 (32.) 114.5 (39.) 125.2 (38.)
 Trefferlage 1.09 mm rechts, 0.21 mm tief
 Streuwert 2.07, horizontal: 2.64, vertikal: 1.26

Unterschrift des Schützen

Meyton Elektronik

Ergebnis: **377** (397.5)
 Serien: 92 97 92 96
 Zähler: 19 19 2 0 0 0 0 0 0 0
 Innenzehner: 18
 weiteste: 549 (6), 534 (32), 498 (28)
 beste Teiler 37.3 (22.) 62.1 (34.) 69.7 (2.)
 Trefferlage 0.11 mm links, 0.04 mm tief
 Streuwert 2.03, horizontal: 2.25, vertikal: 1.79

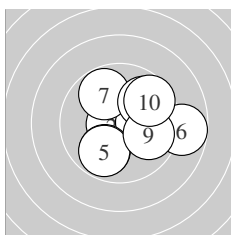
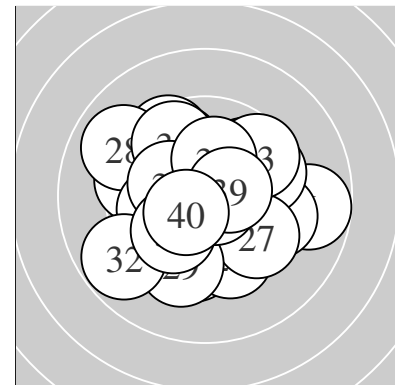

Serie 1:
 10.5 * 10.7 * 10.2 * 9.9 ↙ 9.8 ↙
 8.8 → 9.8 ↘ 9.8 ↗ 9.9 → 9.6 ↗
 beste Teiler 69.7 (2.) 121.1 (1.) 189.1 (3.)
 Trefferlage 0.95 mm rechts, 0.11 mm hoch
 Streuwert 2.05, horizontal: 2.31, vertikal: 1.76

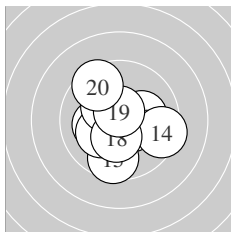

Serie 2:
 10.5 * 10.2 * 10.2 * 9.4 → 9.6 ↓
 10.2 * 10.3 * 10.4 * 10.6 * 9.5 ↘
 beste Teiler 77.1 (19.) 120.3 (11.) 147.8 (18.)
 Trefferlage 0.08 mm links, 0.24 mm tief
 Streuwert 1.78, horizontal: 1.83, vertikal: 1.72

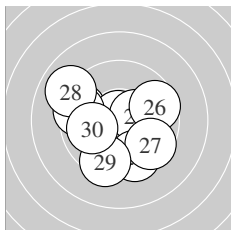

Serie 3:
 9.5 ↖ 10.8 * 9.5 ↖ 10.4 * 9.6 ↓
 9.6 → 9.6 ↘ 9.0 ↖ 9.4 ↓ 9.9 ←
 beste Teiler 37.3 (22.) 141.6 (24.) 251.2 (30.)
 Trefferlage 0.66 mm links, 0.31 mm tief
 Streuwert 2.40, horizontal: 2.72, vertikal: 2.02

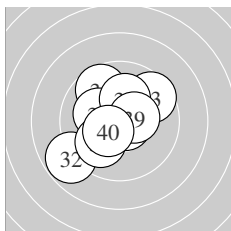

Serie 4:
 10.3 * 8.8 ↙ 9.6 ↗ 10.7 * 9.7 ↘
 10.2 * 10.2 * 10.0 ↙ 10.4 * 10.4 *
 beste Teiler 62.1 (34.) 131.7 (39.) 132.5 (40.)
 Trefferlage 0.67 mm links, 0.24 mm hoch
 Streuwert 1.91, horizontal: 1.97, vertikal: 1.86

Unterschrift des Schützen

Ergebnis: **380** (397.3)
 Serien: 94 96 95 95
 Zähler: 22 16 2 0 0 0 0 0 0 0
 Innenzehner: 12
 weiteste: 587 (32), 510 (30), 495 (27)
 beste Teiler 11.3 (5.) 67.1 (31.) 71.5 (15.)
 Trefferlage 0.38 mm rechts, 0.06 mm hoch
 Streuwert 2.01, horizontal: 2.34, vertikal: 1.61

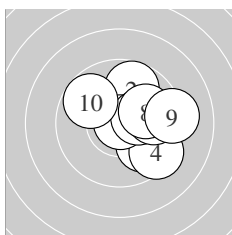
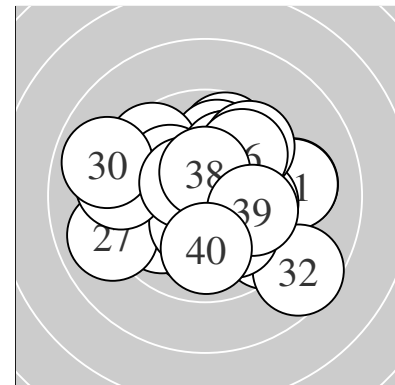

Serie 1:
 10.5 * 9.7 ↑ 9.9 ↘ 9.4 ↘ 10.9 *
 10.3 * 9.8 → 10.0 → 9.2 → 9.8 ↖
 beste Teiler 11.3 (5.) 102.5 (1.) 158.5 (6.)
 Trefferlage 1.51 mm rechts, 0.38 mm hoch
 Streuwert 1.69, horizontal: 1.84, vertikal: 1.53

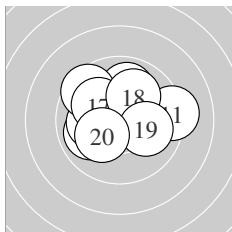

Serie 2:
 9.2 → 9.9 ← 9.9 ↑ 10.1 ← 10.7 *
 9.6 ↖ 10.1 ↖ 10.0 ↑ 10.0 → 10.2 *
 beste Teiler 71.5 (15.) 190.1 (20.) 214.0 (17.)
 Trefferlage 0.28 mm links, 0.55 mm hoch
 Streuwert 1.89, horizontal: 2.27, vertikal: 1.40

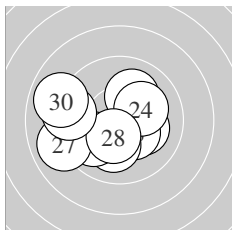

Serie 3:
 10.2 * 10.1 ↑ 10.3 * 10.2 * 10.1 ↓
 9.9 ↖ 9.0 ← 10.4 * 9.3 ← 8.9 ←
 beste Teiler 141.5 (28.) 151.4 (23.) 197.3 (21.)
 Trefferlage 1.09 mm links, 0.34 mm tief
 Streuwert 2.15, horizontal: 2.65, vertikal: 1.50

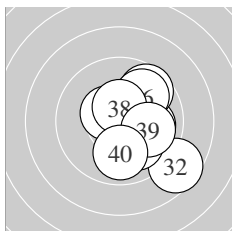

Serie 4:
 10.7 * 8.6 ↘ 10.5 * 10.0 → 9.6 ↗
 9.9 ↗ 10.0 ↘ 10.5 * 10.0 → 9.9 ↓
 beste Teiler 67.1 (31.) 117.0 (38.) 119.2 (33.)
 Trefferlage 1.40 mm rechts, 0.34 mm tief
 Streuwert 1.80, horizontal: 1.62, vertikal: 1.97

Unterschrift des Schützen

Meyton Elektronik

Ergebnis: **392** (411.1)
 Serien: 97 97 100 98
 Zähler: 32 8 0 0 0 0 0 0 0 0
 Innenzehner: 29
 weiteste: 370 (32), 368 (6), 320 (2)
 beste Teiler 8.0 (38.) 45.2 (16.) 45.2 (17.)
 Trefferlage 0.24 mm links, 0.26 mm hoch
 Streuwert 1.36, horizontal: 1.48, vertikal: 1.24

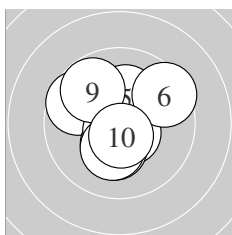
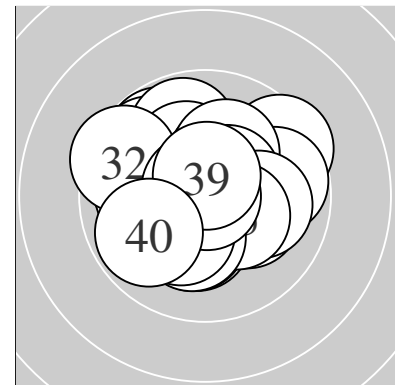

Serie 1:
 10.6 * 9.7 ↖ 10.4 * 10.7 * 10.2 *
 9.5 ↗ 10.3 * 10.2 * 9.8 ↘ 10.6 *
 beste Teiler 59.6 (4.) 87.5 (10.) 91.9 (1.)
 Trefferlage 0.21 mm links, 0.05 mm hoch
 Streuwert 1.60, horizontal: 1.57, vertikal: 1.62

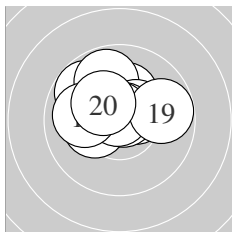

Serie 2:
 10.3 * 10.2 * 9.8 ↘ 9.8 ↗ 10.4 *
 10.8 * 10.8 * 10.0 ← 9.8 → 10.3 *
 beste Teiler 45.2 (16.) 45.2 (17.) 126.5 (15.)
 Trefferlage 0.38 mm links, 0.94 mm hoch
 Streuwert 1.33, horizontal: 1.65, vertikal: 0.92

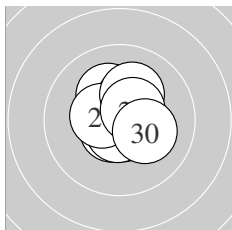

Serie 3:
 10.7 * 10.6 * 10.6 * 10.2 * 10.3 *
 10.7 * 10.5 * 10.2 * 10.5 * 10.2 *
 beste Teiler 69.8 (21.) 71.1 (26.) 85.4 (23.)
 Trefferlage 0.25 mm rechts, 0.35 mm hoch
 Streuwert 0.97, horizontal: 0.91, vertikal: 1.03

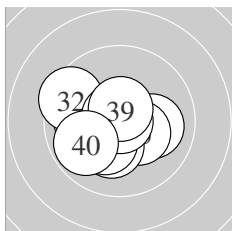

Serie 4:
 10.0 ← 9.5 ↖ 10.1 → 10.8 * 10.3 *
 10.2 * 10.2 * 10.9 * 10.6 * 9.8 ↙
 beste Teiler 8.0 (38.) 50.0 (34.) 84.2 (39.)
 Trefferlage 0.63 mm links, 0.31 mm tief
 Streuwert 1.43, horizontal: 1.72, vertikal: 1.08

Unterschrift des Schützen

Meyton Elektronik

Ergebnis: **390** (410.1)
 Serien: 98 97 97 98
 Zähler: 30 10 0 0 0 0 0 0 0 0
 Innenzehner: 25
 weiteste: 396 (14), 332 (3), 295 (30)
 beste Teiler 50.2 (27.) 56.3 (19.) 58.5 (5.)
 Trefferlage 0.32 mm rechts, 0.39 mm tief
 Streuwert 1.34, horizontal: 1.48, vertikal: 1.18

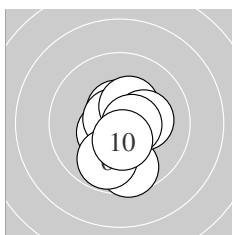
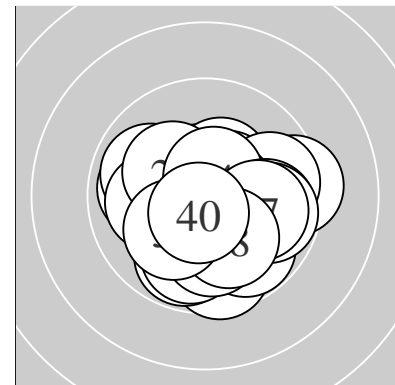

Serie 1:
 10.6 * 10.4 * 9.6 ↓ 10.5 * 10.7 *
 9.8 ↓ 10.4 * 10.2 * 10.6 * 10.4 *
 beste Teiler 58.5 (5.) 90.6 (9.) 98.7 (1.)
 Trefferlage 0.28 mm rechts, 0.47 mm tief
 Streuwert 1.25, horizontal: 0.92, vertikal: 1.50

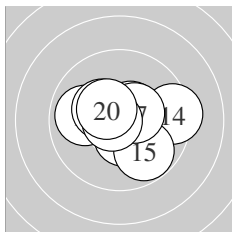

Serie 2:
 10.2 * 10.5 * 10.5 * 9.4 → 9.8 ↓
 9.9 ← 10.5 * 10.3 * 10.7 * 10.4 *
 beste Teiler 56.3 (19.) 103.8 (13.) 122.0 (12.)
 Trefferlage 0.36 mm rechts, 0.13 mm tief
 Streuwert 1.51, horizontal: 1.83, vertikal: 1.10

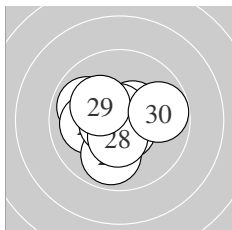

Serie 3:
 9.9 ↖ 10.5 * 10.6 * 10.1 ← 9.9 ↓
 10.6 * 10.8 * 10.5 * 10.2 * 9.8 →
 beste Teiler 50.2 (27.) 82.2 (26.) 82.3 (23.)
 Trefferlage 0.35 mm links, 0.11 mm tief
 Streuwert 1.37, horizontal: 1.57, vertikal: 1.14

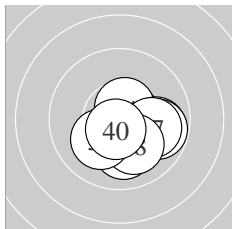

Serie 4:
 10.2 * 10.0 ↓ 10.6 * 10.6 * 9.8 →
 9.8 → 10.0 → 10.1 ↓ 10.1 ↙ 10.6 *
 beste Teiler 81.3 (40.) 92.1 (34.) 92.9 (33.)
 Trefferlage 1.01 mm rechts, 0.85 mm tief
 Streuwert 1.15, horizontal: 1.35, vertikal: 0.91

Unterschrift des Schützen

Meyton Elektronik

Ergebnis: **381** (401.1)
 Serien: 96 93 97 95
 Zähler: 22 17 1 0 0 0 0 0 0 0
 Innenzehner: 16
 weiteste: 517 (18), 489 (19), 478 (37)
 beste Teiler 34.8 (29.) 58.6 (17.) 66.0 (21.)
 Trefferlage 0.48 mm rechts, 0.24 mm hoch
 Streuwert 1.83, horizontal: 1.82, vertikal: 1.83

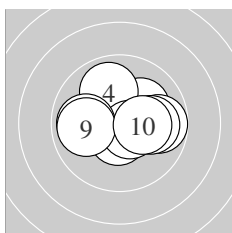
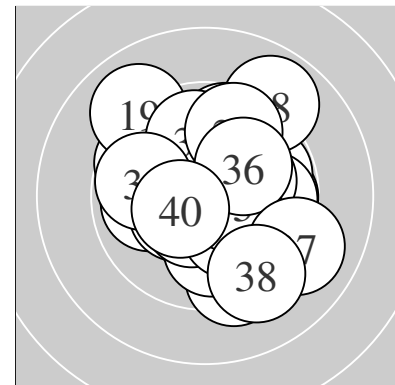

Serie 1:
 10.7 * 10.6 * 10.1 ↗ 9.9 ↑ 9.8 →
 10.0 → 10.6 * 9.9 ← 9.9 ← 10.2 *
 beste Teiler 70.7 (1.) 92.1 (7.) 99.8 (2.)
 Trefferlage 0.28 mm rechts, 0.20 mm hoch
 Streuwert 1.54, horizontal: 1.95, vertikal: 0.97

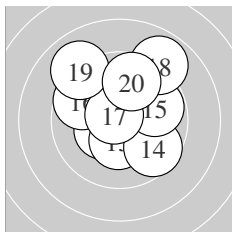

Serie 2:
 10.1 ↗ 10.4 * 10.3 * 9.6 ↘ 9.8 →
 9.7 ↖ 10.7 * 8.9 ↗ 9.0 ↘ 9.7 ↑
 beste Teiler 58.6 (17.) 147.6 (12.) 155.3 (13.)
 Trefferlage 0.31 mm rechts, 1.07 mm hoch
 Streuwert 2.19, horizontal: 2.23, vertikal: 2.16

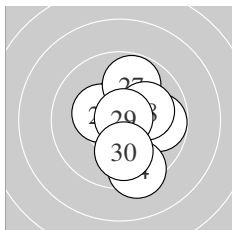

Serie 3:
 10.7 * 10.5 * 9.8 → 9.4 ↓ 10.6 *
 10.3 * 9.8 ↑ 10.1 → 10.8 * 10.0 ↓
 beste Teiler 34.8 (29.) 66.0 (21.) 79.3 (25.)
 Trefferlage 0.63 mm rechts, 0.10 mm tief
 Streuwert 1.55, horizontal: 1.23, vertikal: 1.82

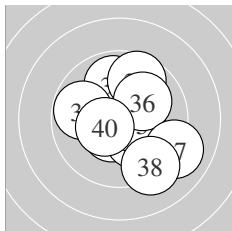

Serie 4:
 10.5 * 10.2 * 9.9 ↑ 9.7 ↑ 10.4 *
 10.1 ↗ 9.0 ↘ 9.2 ↓ 9.8 ← 10.4 *
 beste Teiler 120.5 (31.) 128.8 (40.) 132.9 (35.)
 Trefferlage 0.70 mm rechts, 0.18 mm tief
 Streuwert 2.05, horizontal: 2.00, vertikal: 2.10

Unterschrift des Schützen

Ergebnis: **390** (407.2)
 Serien: 97 97 99 97
 Zähler: 30 10 0 0 0 0 0 0 0 0
 Innenzehner: 25
 weiteste: 481 (17), 379 (39), 330 (1)
 beste Teiler 10.0 (20.) 31.9 (35.) 39.5 (5.)
 Trefferlage 0.61 mm rechts, 0.13 mm tief
 Streuwert 1.48, horizontal: 1.43, vertikal: 1.53

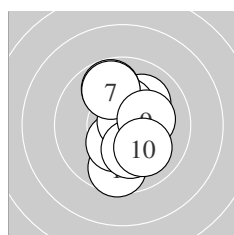
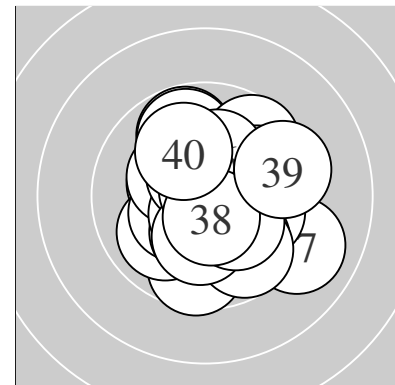

Serie 1:
 9.6 ↓ 10.1 ↗ 10.4 * 10.4 * 10.8 *
 9.8 ↗ 9.8 ↗ 10.2 * 10.2 * 10.0 ↘
 beste Teiler 39.5 (5.) 143.8 (4.) 146.0 (3.)
 Trefferlage 0.31 mm rechts, 0.11 mm hoch
 Streuwert 1.64, horizontal: 1.03, vertikal: 2.08

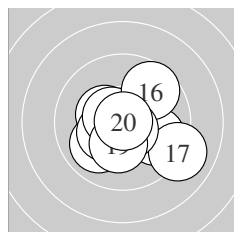

Serie 2:
 10.4 * 10.0 ↖ 10.3 * 10.6 * 9.8 ↘
 9.7 ↗ 9.0 ↘ 10.7 * 10.3 * 10.9 *
 beste Teiler 10.0 (20.) 75.8 (18.) 96.1 (14.)
 Trefferlage 0.37 mm rechts, 0.45 mm tief
 Streuwert 1.71, horizontal: 1.99, vertikal: 1.38

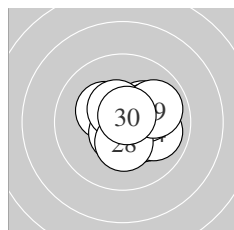

Serie 3:
 10.2 * 10.3 * 10.3 * 10.0 → 10.2 *
 10.6 * 10.5 * 10.3 * 9.9 → 10.7 *
 beste Teiler 60.7 (30.) 90.8 (26.) 112.2 (27.)
 Trefferlage 0.78 mm rechts, 0.11 mm hoch
 Streuwert 1.16, horizontal: 1.32, vertikal: 0.98

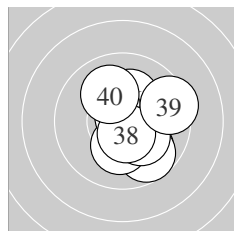

Serie 4:
 10.3 * 9.9 ↘ 9.7 ↘ 10.2 * 10.8 *
 10.2 * 10.2 * 10.5 * 9.4 → 10.0 ↗
 beste Teiler 31.9 (35.) 101.2 (38.) 169.0 (31.)
 Trefferlage 0.99 mm rechts, 0.31 mm tief
 Streuwert 1.48, horizontal: 1.31, vertikal: 1.63

Unterschrift des Schützen

Ergebnis: **373** (392.2)
 Serien: 94 92 96 91
 Zähler: 17 19 4 0 0 0 0 0 0 0
 Innenzehner: 9
 weiteste: 589 (32), 570 (5), 557 (7)
 beste Teiler 8.2 (8.) 48.6 (33.) 98.6 (1.)
 Trefferlage 0.54 mm links, 0.79 mm hoch
 Streuwert 2.17, horizontal: 2.44, vertikal: 1.86

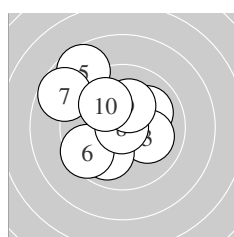
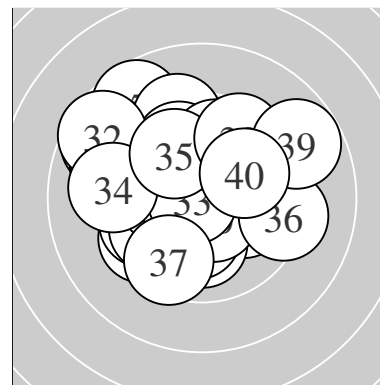

Serie 1:
 10.6 * 10.0 ↗ 10.1 → 9.9 ↙ 8.7 ↖
 9.5 ↙ 8.7 ↖ 10.9 * 10.2 * 10.0 ↖
 beste Teiler 8.2 (8.) 98.6 (1.) 186.6 (9.)
 Trefferlage 0.89 mm links, 0.83 mm hoch
 Streuwert 2.22, horizontal: 2.30, vertikal: 2.13

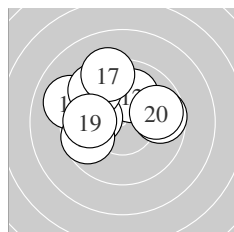

Serie 2:
 9.8 ↑ 10.0 ↑ 10.0 ← 9.7 → 9.1 ↖
 9.5 ↘ 9.3 ↑ 9.7 ← 9.9 ← 9.8 →
 beste Teiler 228.3 (13.) 234.0 (12.) 275.1 (19.)
 Trefferlage 0.99 mm links, 1.37 mm hoch
 Streuwert 2.08, horizontal: 2.51, vertikal: 1.55

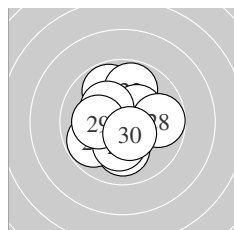

Serie 3:
 9.8 ↖ 10.0 ↓ 9.8 ↑ 10.4 * 9.8 ↙
 10.2 * 10.3 * 9.8 → 10.1 ← 10.5 *
 beste Teiler 112.6 (30.) 148.6 (24.) 175.5 (27.)
 Trefferlage 0.17 mm links, 0.09 mm hoch
 Streuwert 1.70, horizontal: 1.63, vertikal: 1.76

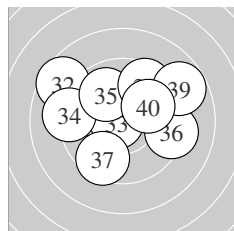

Serie 4:
 10.5 * 8.6 ↘ 10.8 * 9.2 ← 9.9 ↖
 9.3 → 9.5 ↙ 9.5 ↑ 8.8 ↗ 10.0 →
 beste Teiler 48.6 (33.) 107.6 (31.) 246.4 (40.)
 Trefferlage 0.12 mm links, 0.88 mm hoch
 Streuwert 2.72, horizontal: 3.30, vertikal: 1.99

Unterschrift des Schützen

Meyton Elektronik

Ergebnis: **384** (401.8)
 Serien: 97 93 96 98
 Zähler: 25 14 1 0 0 0 0 0 0 0
 Innenzehner: 19
 weiteste: 502 (12), 490 (15), 460 (16)
 beste Teiler 37.3 (29.) 67.9 (37.) 86.2 (8.)
 Trefferlage 0.32 mm links, 0.42 mm tief
 Streuwert 1.79, horizontal: 2.13, vertikal: 1.38

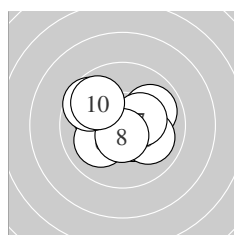
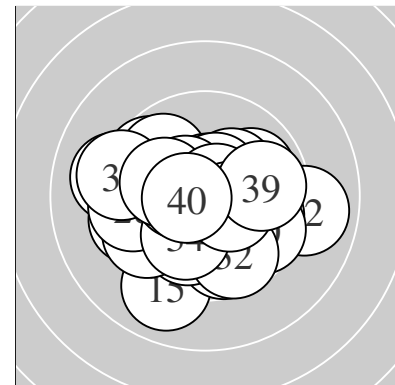

Serie 1:
 9.9 ↗ 10.5 * 10.1 ↖ 10.5 * 10.0 ↘
 10.1 ↙ 10.3 * 10.6 * 9.7 ↘ 9.8 ↖
 beste Teiler 86.2 (8.) 115.2 (2.) 117.5 (4.)
 Trefferlage 0.07 mm links, 0.23 mm hoch
 Streuwert 1.59, horizontal: 1.92, vertikal: 1.17

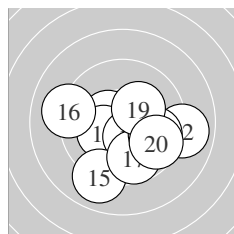

Serie 2:
 10.4 * 8.9 → 10.2 * 10.4 * 9.0 ↓
 9.1 ← 9.7 ↓ 9.8 → 10.3 * 9.6 ↘
 beste Teiler 128.7 (11.) 133.7 (14.) 174.4 (19.)
 Trefferlage 0.40 mm rechts, 1.03 mm tief
 Streuwert 2.31, horizontal: 2.78, vertikal: 1.73

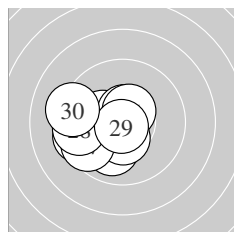

Serie 3:
 10.3 * 9.4 ← 10.0 ↓ 10.6 * 10.5 *
 10.4 * 9.6 ↙ 9.5 ← 10.8 * 9.2 ←
 beste Teiler 37.3 (29.) 88.9 (24.) 106.1 (25.)
 Trefferlage 1.62 mm links, 0.42 mm tief
 Streuwert 1.54, horizontal: 1.81, vertikal: 1.21

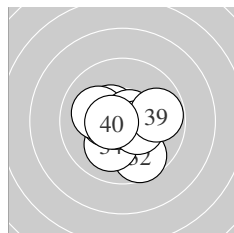

Serie 4:
 10.3 * 9.7 ↓ 10.5 * 10.1 ↓ 10.4 *
 10.1 ↖ 10.7 * 10.4 * 9.8 → 10.6 *
 beste Teiler 67.9 (37.) 92.5 (40.) 125.4 (33.)
 Trefferlage 0.00 mm , 0.45 mm tief
 Streuwert 1.39, horizontal: 1.51, vertikal: 1.25

Unterschrift des Schützen

Meyton Elektronik

Ergebnis: **384** (403.6)
 Serien: 93 97 98 96
 Zähler: 28 8 4 0 0 0 0 0 0 0
 Innenzehner: 25
 weiteste: 657 (35), 644 (5), 571 (37)
 beste Teiler 12.6 (29.) 46.0 (28.) 70.6 (40.)
 Trefferlage 0.76 mm links, 0.40 mm tief
 Streuwert 1.82, horizontal: 2.14, vertikal: 1.43

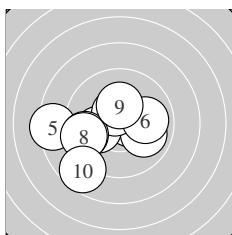
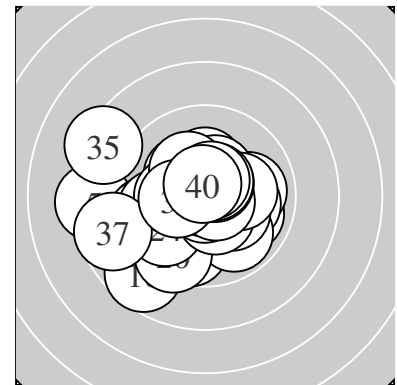

Serie 1:
 10.6 * 9.9 ↘ 10.1 ← 10.5 * 8.4 ←
 10.0 → 9.5 ← 9.5 ← 10.3 * 8.7 ↙
 beste Teiler 96.0 (1.) 110.5 (4.) 171.0 (9.)
 Trefferlage 1.35 mm links, 0.58 mm tief
 Streuwert 2.36, horizontal: 2.90, vertikal: 1.66

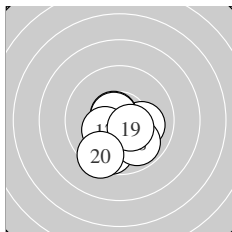

Serie 2:
 10.6 * 9.7 ↓ 10.1 → 10.6 * 10.3 *
 10.7 * 10.3 * 9.9 ↘ 10.4 * 9.4 ↙
 beste Teiler 71.2 (16.) 77.8 (14.) 78.5 (11.)
 Trefferlage 0.08 mm links, 1.19 mm tief
 Streuwert 1.31, horizontal: 1.31, vertikal: 1.31

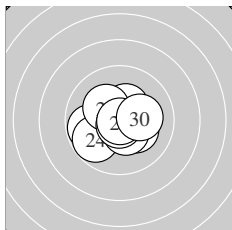

Serie 3:
 10.5 * 9.8 ← 10.2 * 9.8 ↙ 10.4 *
 10.4 * 10.2 * 10.8 * 10.9 * 10.2 *
 beste Teiler 12.6 (29.) 46.0 (28.) 123.9 (21.)
 Trefferlage 0.25 mm links, 0.33 mm tief
 Streuwert 1.30, horizontal: 1.55, vertikal: 1.00

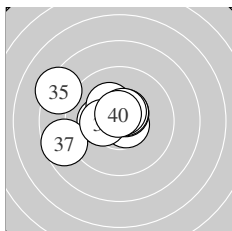

Serie 4:
 10.7 * 10.6 * 10.2 * 10.6 * 8.3 ↘
 10.2 * 8.7 ← 10.3 * 10.6 * 10.7 *
 beste Teiler 70.6 (40.) 71.1 (31.) 93.4 (32.)
 Trefferlage 1.37 mm links, 0.50 mm hoch
 Streuwert 1.94, horizontal: 2.41, vertikal: 1.30

Unterschrift des Schützen

Meyton Elektronik

Ergebnis:	391	(405.7)
Serien:	100	99 95 97
Zähler:	32	7 1 0 0 0 0 0 0 0
Innenzehner:	22	
weiteste:	569	(27), 390 (23), 352 (28)
beste Teiler	15.5	(32.) 59.2 (4.) 60.1 (17.)
Trefferlage	0.09	mm rechts, 0.17 mm hoch
Streuwert	1.63,	horizontal: 1.94, vertikal: 1.25

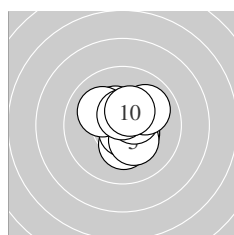
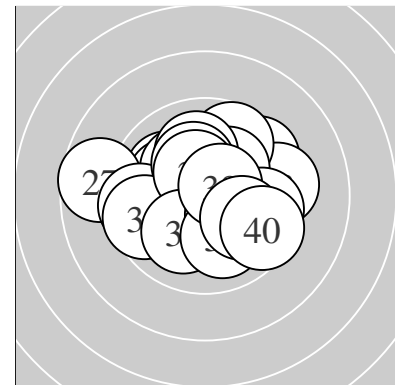

Serie 1:	10.4 *	10.3 *	10.4 *	10.7 *	10.3 *
	10.5 *	10.1 ↖	10.0 ↗	10.6 *	10.4 *
beste Teiler	59.2	(4.) 94.1 (9.)	117.2 (6.)		
Trefferlage	0.34	mm rechts, 0.22 mm hoch			
Streuwert	1.13,	horizontal: 1.06, vertikal: 1.19			

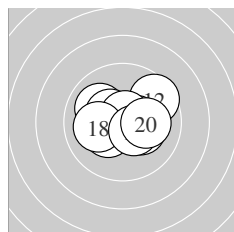

Serie 2:	10.0 ↖	9.6 ↗	10.5 *	10.4 *	10.3 *
	10.3 *	10.7 *	10.1 ←	10.5 *	10.1 →
beste Teiler	60.1	(17.) 120.8 (13.)	125.0 (19.)		
Trefferlage	0.23	mm rechts, 0.18 mm hoch			
Streuwert	1.43,	horizontal: 1.78, vertikal: 0.95			

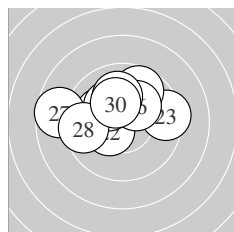

Serie 3:	10.1 ↖	10.4 *	9.4 →	9.7 ↗	10.2 *
	10.2 *	8.7 ←	9.5 ←	10.0 ↑	10.2 *
beste Teiler	138.6	(22.) 183.1 (30.)	190.3 (26.)		
Trefferlage	0.80	mm links, 1.07 mm hoch			
Streuwert	2.03,	horizontal: 2.65, vertikal: 1.12			

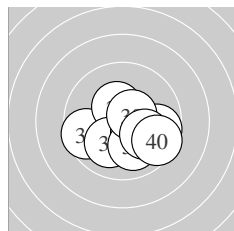

Serie 4:	9.6 ←	10.9 *	10.4 *	9.7 →	10.1 ↙
	10.3 *	10.0 ↓	10.6 *	10.0 ↘	9.5 ↘
beste Teiler	15.5	(32.) 98.7 (38.)	138.1 (33.)		
Trefferlage	0.60	mm rechts, 0.78 mm tief			
Streuwert	1.59,	horizontal: 1.94, vertikal: 1.12			

Unterschrift des Schützen

Ergebnis: **387** (409.5)
 Serien: 98 98 94 97
 Zähler: 27 13 0 0 0 0 0 0 0 0
 Innenzehner: 27
 weiteste: 396 (2), 364 (20), 358 (16)
 beste Teiler 17.0 (8.) 36.0 (14.) 45.5 (13.)
 Trefferlage 0.29 mm rechts, 0.43 mm hoch
 Streuwert 1.43, horizontal: 1.54, vertikal: 1.32

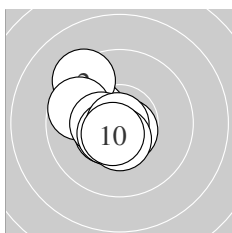
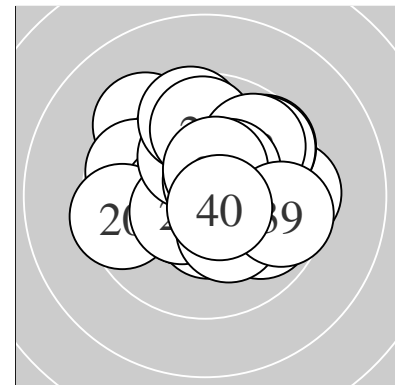

Serie 1:
 10.2 * 9.4 ↘ 10.7 * 9.7 ↖ 10.5 *
 10.4 * 10.5 * 10.9 * 10.5 * 10.6 *
 beste Teiler 17.0 (8.) 70.0 (3.) 91.2 (10.)
 Trefferlage 1.04 mm links, 0.09 mm hoch
 Streuwert 1.17, horizontal: 1.10, vertikal: 1.24

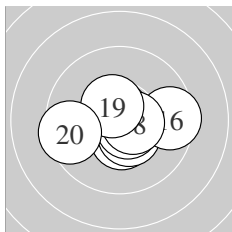

Serie 2:
 10.5 * 10.4 * 10.8 * 10.8 * 10.5 *
 9.5 → 10.6 * 10.6 * 10.5 * 9.5 ←
 beste Teiler 36.0 (14.) 45.5 (13.) 77.8 (17.)
 Trefferlage 0.15 mm rechts, 0.33 mm tief
 Streuwert 1.34, horizontal: 1.74, vertikal: 0.76

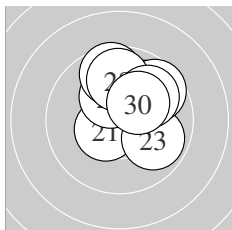

Serie 3:
 10.5 * 10.2 * 9.9 ↘ 9.9 ↗ 10.2 *
 9.7 ↗ 9.6 ↑ 9.8 ↑ 9.9 ↗ 10.2 *
 beste Teiler 118.7 (21.) 178.8 (25.) 178.9 (22.)
 Trefferlage 0.80 mm rechts, 1.45 mm hoch
 Streuwert 1.38, horizontal: 1.33, vertikal: 1.43

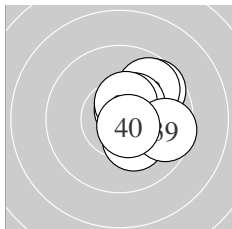

Serie 4:
 9.7 ↗ 9.8 ↗ 10.6 * 10.2 * 10.6 *
 10.5 * 10.4 * 10.5 * 9.6 → 10.6 *
 beste Teiler 76.0 (35.) 78.4 (33.) 79.6 (40.)
 Trefferlage 1.28 mm rechts, 0.51 mm hoch
 Streuwert 1.08, horizontal: 0.97, vertikal: 1.18

Unterschrift des Schützen

Meyton Elektronik

Ergebnis: **391** (409.1)
 Serien: 98 99 96 98
 Zähler: 32 7 1 0 0 0 0 0 0 0
 Innenzehner: 26
 weiteste: 565 (21), 412 (3), 397 (10)
 beste Teiler 32.0 (9.) 33.7 (6.) 68.5 (17.)
 Trefferlage 0.23 mm links, 0.25 mm hoch
 Streuwert 1.51, horizontal: 1.56, vertikal: 1.46

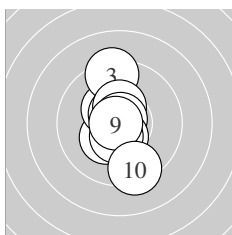
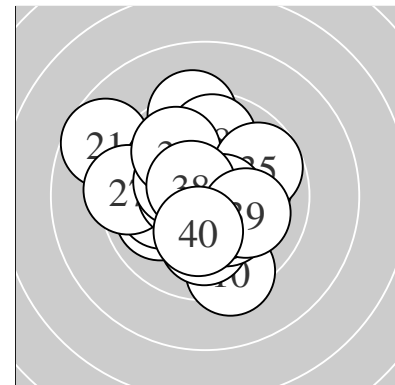

Serie 1:
 10.3 * 10.3 * 9.3 ↑ 10.6 * 10.4 *
 10.8 * 10.5 * 10.5 * 10.8 * 9.4 ↓
 beste Teiler 32.0 (9.) 33.7 (6.) 85.8 (4.)
 Trefferlage 0.22 mm links, 0.05 mm hoch
 Streuwert 1.54, horizontal: 0.68, vertikal: 2.07

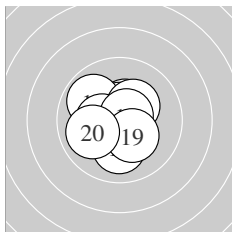

Serie 2:
 10.4 * 10.6 * 10.7 * 9.9 ↖ 10.4 *
 10.3 * 10.7 * 10.1 ↓ 10.3 * 10.0 ←
 beste Teiler 68.5 (17.) 73.3 (13.) 92.0 (12.)
 Trefferlage 0.21 mm links, 0.10 mm hoch
 Streuwert 1.27, horizontal: 1.28, vertikal: 1.25

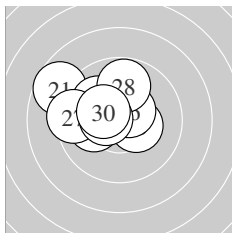

Serie 3:
 8.7 ↖ 10.1 ← 10.4 * 10.6 * 10.0 ↖
 10.5 * 9.4 ← 9.8 ↑ 10.5 * 10.3 *
 beste Teiler 83.6 (24.) 110.3 (26.) 114.6 (29.)
 Trefferlage 1.33 mm links, 0.86 mm hoch
 Streuwert 1.63, horizontal: 2.00, vertikal: 1.15

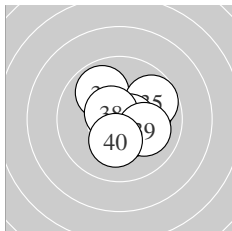

Serie 4:
 10.1 → 10.6 * 10.2 * 9.9 ↖ 9.7 ↗
 10.5 * 10.6 * 10.6 * 10.1 ↘ 10.2 *
 beste Teiler 83.1 (37.) 87.2 (38.) 91.2 (32.)
 Trefferlage 0.82 mm rechts, 0.01 mm tief
 Streuwert 1.28, horizontal: 1.35, vertikal: 1.20

Unterschrift des Schützen

Meyton Elektronik

Ergebnis:	396	(411.6)
Serien:	100 100 97 99	
Zähler:	36 4 0 0 0 0 0 0 0 0	
Innenzehner:	26	
weiteste:	369 (36), 323 (22), 295 (21)	
beste Teiler	40.1 (16.) 47.0 (17.) 59.6 (33.)	
Trefferlage	0.02 mm rechts, 0.54 mm hoch	
Streuwert	1.25, horizontal: 1.21, vertikal: 1.28	

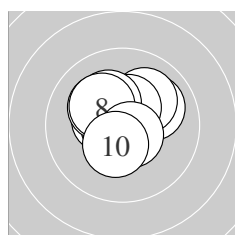
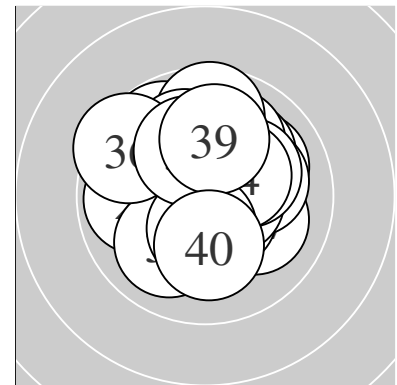

Serie 1:

10.0 ↗	10.1 ↗	10.4 *	10.4 *	10.7 *
10.2 *	10.2 *	10.2 *	10.6 *	10.4 *
beste Teiler	61.4 (5.) 84.5 (9.) 127.1 (3.)			
Trefferlage	0.17 mm links, 0.64 mm hoch			
Streuwert	1.13, horizontal: 1.23, vertikal: 1.01			

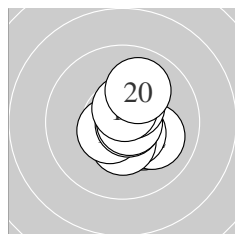

Serie 2:

10.3 *	10.1 ↘	10.5 *	10.4 *	10.5 *
10.8 *	10.8 *	10.4 *	10.6 *	10.0 ↗
beste Teiler	40.1 (16.) 47.0 (17.) 94.2 (19.)			
Trefferlage	0.59 mm rechts, 0.06 mm tief			
Streuwert	0.97, horizontal: 0.78, vertikal: 1.13			

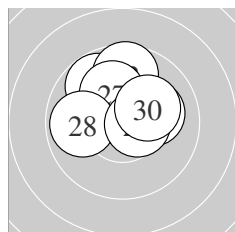

Serie 3:

9.8 ↖	9.7 ↑	10.7 *	10.1 →	10.6 *
10.6 *	10.1 ↖	9.9 ←	10.5 *	10.2 *
beste Teiler	61.8 (23.) 83.0 (25.) 86.8 (26.)			
Trefferlage	0.02 mm rechts, 1.11 mm hoch			
Streuwert	1.28, horizontal: 1.44, vertikal: 1.09			

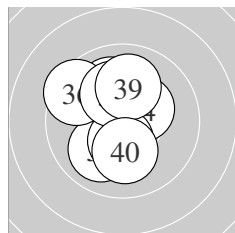

Serie 4:

10.6 *	10.0 ↖	10.7 *	10.3 *	10.0 ↗
9.5 ↖	10.4 *	10.2 *	10.0 ↑	10.1 ↓
beste Teiler	59.6 (33.) 91.5 (31.) 133.7 (37.)			
Trefferlage	0.32 mm links, 0.47 mm hoch			
Streuwert	1.49, horizontal: 1.28, vertikal: 1.68			

Unterschrift des Schützen

Meyton Elektronik

Ergebnis: **386** (406.1)
 Serien: 96 96 99 95
 Zähler: 26 14 0 0 0 0 0 0 0 0
 Innenzehner: 19
 weiteste: 348 (18), 344 (6), 340 (34)
 beste Teiler 4.2 (19.) 29.0 (22.) 30.8 (26.)
 Trefferlage 0.21 mm links, 0.33 mm tief
 Streuwert 1.54, horizontal: 1.52, vertikal: 1.57

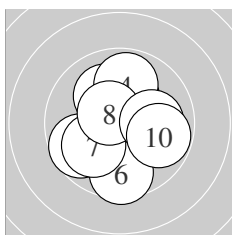
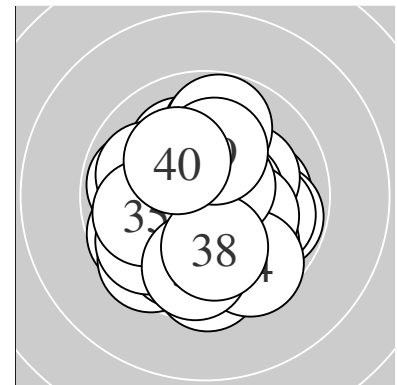

Serie 1:
 10.2 * 10.5 * 10.1 ↖ 9.9 ↑ 9.7 ↙
 9.6 ↓ 10.0 ↙ 10.5 * 10.1 → 9.8 →
 beste Teiler 101.1 (8.) 112.0 (2.) 181.1 (1.)
 Trefferlage 0.04 mm links, 0.07 mm hoch
 Streuwert 1.80, horizontal: 1.68, vertikal: 1.91

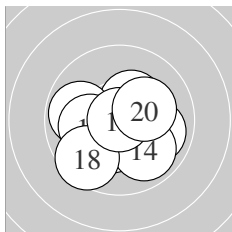

Serie 2:
 9.9 → 10.4 * 10.3 * 9.9 ↘ 10.4 *
 9.8 ← 10.1 ← 9.6 ↙ 10.9 * 10.2 *
 beste Teiler 4.2 (19.) 141.1 (15.) 149.4 (12.)
 Trefferlage 0.22 mm links, 0.51 mm tief
 Streuwert 1.57, horizontal: 1.85, vertikal: 1.23

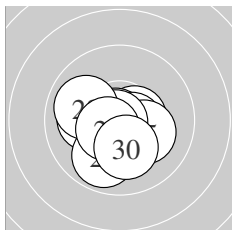

Serie 3:
 10.5 * 10.8 * 10.1 ← 10.6 * 10.2 *
 10.8 * 9.9 ↙ 10.0 ↖ 10.5 * 10.2 *
 beste Teiler 29.0 (22.) 30.8 (26.) 89.1 (24.)
 Trefferlage 0.29 mm links, 0.51 mm tief
 Streuwert 1.18, horizontal: 1.34, vertikal: 1.00

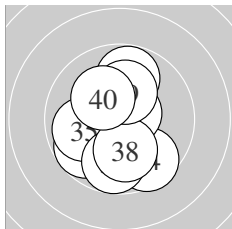

Serie 4:
 9.7 ↙ 9.8 ↑ 10.7 * 9.6 ↘ 9.9 ←
 9.8 ↓ 10.6 * 10.1 ↓ 10.2 * 10.2 *
 beste Teiler 60.8 (33.) 81.9 (37.) 188.6 (40.)
 Trefferlage 0.30 mm links, 0.40 mm tief
 Streuwert 1.75, horizontal: 1.39, vertikal: 2.05

Unterschrift des Schützen

Meyton Elektronik

Ergebnis: **378** (395.7)
 Serien: 96 97 91 94
 Zähler: 19 20 1 0 0 0 0 0 0
 Innenzehner: 14
 weiteste: 513 (25), 499 (28), 487 (30)
 beste Teiler 45.0 (4.) 74.0 (18.) 74.2 (26.)
 Trefferlage 0.36 mm rechts, 0.48 mm hoch
 Streuwert 2.09, horizontal: 2.33, vertikal: 1.82

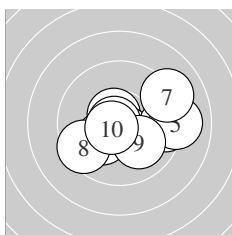
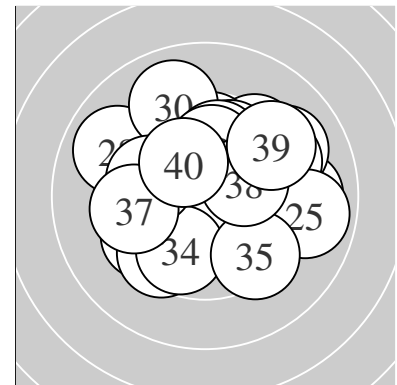

Serie 1:
 10.6 * 10.6 * 9.4 → 10.8 * 9.1 →
 10.2 * 9.1 ↗ 9.5 ↖ 10.0 ↘ 10.6 *
 beste Teiler 45.0 (4.) 77.8 (10.) 85.4 (1.)
 Trefferlage 0.85 mm rechts, 0.31 mm tief
 Streuwert 2.04, horizontal: 2.61, vertikal: 1.25

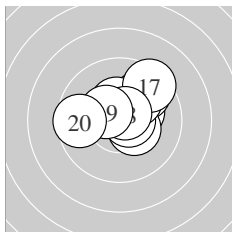

Serie 2:
 10.3 * 9.7 ↗ 10.4 * 10.6 * 10.1 ↗
 10.4 * 9.4 ↗ 10.7 * 10.4 * 9.6 ←
 beste Teiler 74.0 (18.) 78.0 (14.) 133.2 (19.)
 Trefferlage 0.51 mm rechts, 0.93 mm hoch
 Streuwert 1.46, horizontal: 1.74, vertikal: 1.12

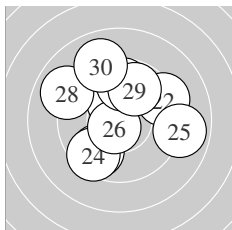

Serie 3:
 10.3 * 9.3 ↗ 9.7 ↙ 9.5 ↙ 8.9 →
 10.7 * 9.7 ↑ 9.0 ↖ 9.8 ↑ 9.0 ↑
 beste Teiler 74.2 (26.) 160.9 (21.) 288.9 (29.)
 Trefferlage 0.08 mm links, 0.88 mm hoch
 Streuwert 2.67, horizontal: 2.82, vertikal: 2.50

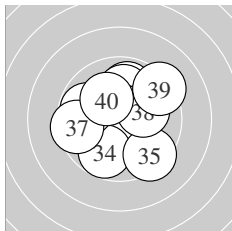

Serie 4:
 9.9 ↑ 10.0 ↑ 10.4 * 9.8 ↙ 9.4 ↘
 9.8 ← 9.5 ← 10.1 → 9.3 ↗ 10.1 ↘
 beste Teiler 135.3 (33.) 201.1 (40.) 210.6 (38.)
 Trefferlage 0.15 mm rechts, 0.44 mm hoch
 Streuwert 2.17, horizontal: 2.29, vertikal: 2.04

Unterschrift des Schützen

Meyton Elektronik

Ergebnis:	391	(407.1)
Serien:	98	99 96 98
Zähler:	32	7 1 0 0 0 0 0 0 0
Innenzehner:	25	
weiteste:	531	(27), 478 (23), 436 (24)
beste Teiler	46.2	(11.) 66.0 (36.) 71.7 (5.)
Trefferlage	0.02 mm	links, 0.01 mm hoch
Streuwert	1.59,	horizontal: 1.77, vertikal: 1.39

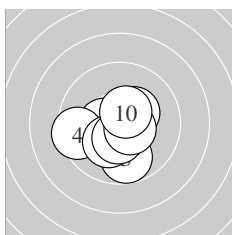
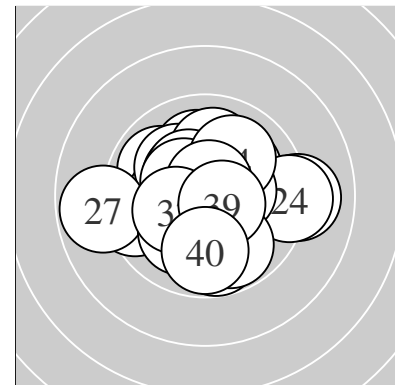

Serie 1:

10.3 *	10.4 *	9.8 ↓	9.5 ←	10.7 *
10.2 *	10.4 *	10.3 *	10.5 *	10.5 *
beste Teiler	71.7 (5.)	102.0 (9.)	109.6 (10.)	
Trefferlage	0.37 mm links, 0.58 mm tief			
Streuwert	1.35, horizontal: 1.51, vertikal: 1.17			

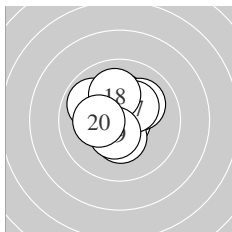

Serie 2:

10.8 *	10.2 *	9.9 ↖	10.1 ↗	10.4 *
10.6 *	10.3 *	10.1 ↑	10.5 *	10.2 *
beste Teiler	46.2 (11.)	94.5 (16.)	118.1 (19.)	
Trefferlage	0.21 mm links, 0.55 mm hoch			
Streuwert	1.23, horizontal: 1.22, vertikal: 1.23			

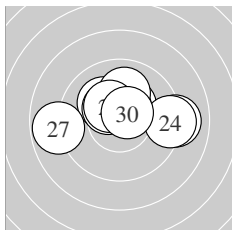

Serie 3:

10.3 *	10.1 ↖	9.0 →	9.2 →	10.4 *
10.5 *	8.8 ←	10.0 ↑	10.4 *	10.6 *
beste Teiler	91.9 (30.)	122.6 (26.)	141.4 (25.)	
Trefferlage	0.31 mm rechts, 0.81 mm hoch			
Streuwert	2.12, horizontal: 2.87, vertikal: 0.89			

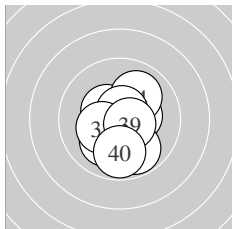

Serie 4:

10.1 ↗	10.4 *	10.4 *	10.0 ↗	10.0 ↓
10.7 *	10.3 *	9.8 ↓	10.6 *	9.8 ↓
beste Teiler	66.0 (36.)	96.6 (39.)	132.0 (32.)	
Trefferlage	0.19 mm rechts, 0.71 mm tief			
Streuwert	1.39, horizontal: 1.13, vertikal: 1.62			

Unterschrift des Schützen

Meyton Elektronik

Ergebnis: **384** (401.1)
 Serien: 95 95 98 96
 Zähler: 26 13 0 1 0 0 0 0 0 0
 Innenzehner: 20
 weiteste: 757 (19), 482 (38), 441 (3)
 beste Teiler 17.8 (12.) 33.0 (35.) 60.2 (18.)
 Trefferlage 0.02 mm links, 0.76 mm hoch
 Streuwert 1.86, horizontal: 2.37, vertikal: 1.15

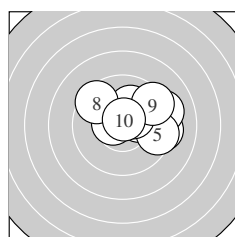
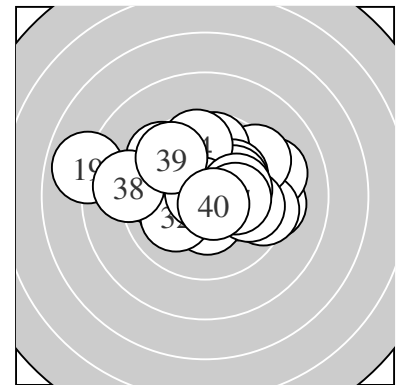

Serie 1:
 10.5 * 9.3 → 9.2 → 10.3 * 9.5 →
 10.4 * 10.1 ↑ 9.5 ↘ 9.4 ↗ 10.7 *
 beste Teiler 61.3 (10.) 101.2 (1.) 137.2 (6.)
 Trefferlage 1.51 mm rechts, 0.86 mm hoch
 Streuwert 1.81, horizontal: 2.31, vertikal: 1.12

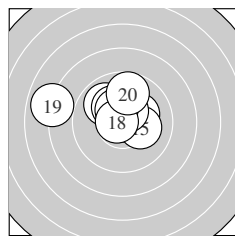

Serie 2:
 9.9 ↘ 10.9 * 10.2 * 10.2 * 10.2 *
 10.5 * 10.4 * 10.7 * 7.9 ← 9.7 ↑
 beste Teiler 17.8 (12.) 60.2 (18.) 124.7 (16.)
 Trefferlage 0.70 mm links, 1.11 mm hoch
 Streuwert 1.98, horizontal: 2.60, vertikal: 1.04

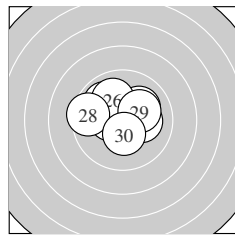

Serie 3:
 10.5 * 9.9 ↘ 10.4 * 10.2 * 10.1 ↗
 10.0 ↘ 10.2 * 9.5 ← 10.2 * 10.4 *
 beste Teiler 115.8 (21.) 127.1 (23.) 144.7 (30.)
 Trefferlage 0.46 mm links, 0.72 mm hoch
 Streuwert 1.48, horizontal: 1.82, vertikal: 1.05

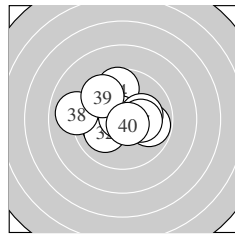

Serie 4:
 10.1 ← 10.1 ↙ 9.8 → 9.7 ↑ 10.8 *
 10.1 → 10.2 * 9.0 ← 9.7 ↘ 10.7 *
 beste Teiler 33.0 (35.) 73.5 (40.) 190.7 (37.)
 Trefferlage 0.43 mm links, 0.34 mm hoch
 Streuwert 1.92, horizontal: 2.32, vertikal: 1.41

Unterschrift des Schützen

Meyton Elektronik

Ergebnis: **378** (397.6)
 Serien: 95 92 95 96
 Zähler: 20 18 2 0 0 0 0 0 0 0
 Innenzehner: 17
 weiteste: 582 (30), 581 (20), 487 (32)
 beste Teiler 68.1 (34.) 71.5 (9.) 87.1 (2.)
 Trefferlage 0.54 mm links, 0.15 mm hoch
 Streuwert 1.97, horizontal: 1.84, vertikal: 2.10

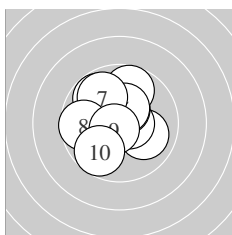
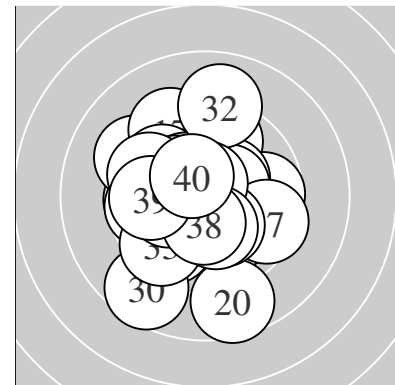

Serie 1:
 10.0 ↘ 10.6 * 10.4 * 9.7 ↑ 10.4 *
 9.8 ↘ 9.8 ↘ 9.7 ← 10.7 * 9.7 ↙
 beste Teiler 71.5 (9.) 87.1 (2.) 132.6 (3.)
 Trefferlage 0.41 mm links, 0.57 mm hoch
 Streuwert 1.68, horizontal: 1.65, vertikal: 1.71

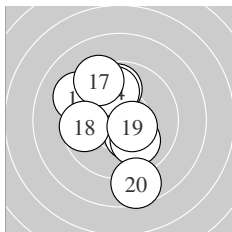

Serie 2:
 9.8 ↑ 9.7 ← 9.3 ↘ 9.9 ↑ 10.3 *
 10.0 ↘ 9.4 ↘ 9.7 ← 10.5 * 8.6 ↓
 beste Teiler 125.6 (19.) 159.7 (15.) 228.8 (16.)
 Trefferlage 0.74 mm links, 0.19 mm hoch
 Streuwert 2.42, horizontal: 2.01, vertikal: 2.77

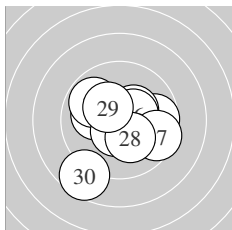

Serie 3:
 9.7 → 10.1 ← 9.8 ↘ 10.5 * 10.3 *
 10.4 * 9.5 ↘ 10.2 * 10.3 * 8.6 ↙
 beste Teiler 106.2 (24.) 132.0 (26.) 152.6 (25.)
 Trefferlage 0.08 mm rechts, 0.41 mm tief
 Streuwert 2.08, horizontal: 2.24, vertikal: 1.91

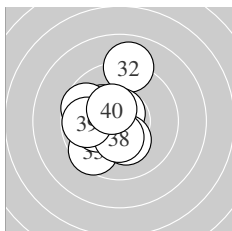

Serie 4:
 10.2 * 9.0 ↑ 9.6 ↙ 10.7 * 9.7 ↘
 10.2 * 10.2 * 10.4 * 9.8 ← 10.4 *
 beste Teiler 68.1 (34.) 127.5 (40.) 144.1 (38.)
 Trefferlage 1.11 mm links, 0.23 mm hoch
 Streuwert 1.77, horizontal: 1.42, vertikal: 2.06

Unterschrift des Schützen

Meyton Elektronik