

Ergebnis: **380** (395.1)
 Serien: 96 94 93 97
 Zähler: 24 13 2 1 0 0 0 0 0 0
 Innenzehner: 16
 weiteste: 904 (13), 720 (26), 511 (27)
 beste Teiler 39.9 (8.) 41.4 (9.) 60.2 (34.)
 Trefferlage 0.56 mm rechts, 1.12 mm hoch
 Streuwert 2.11, horizontal: 2.71, vertikal: 1.25

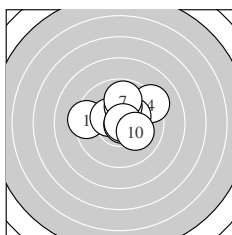

Serie 1:
 9.4 ← 10.4 * 9.9 ↗ 9.2 ↗ 10.3 *
 10.1 ↑ 9.8 ↑ 10.8 * 10.8 * 10.1 →
 beste Teiler 39.9 (8.) 41.4 (9.) 143.1 (2.)
 Trefferlage 0.54 mm rechts, 0.97 mm hoch
 Streuwert 1.68, horizontal: 2.05, vertikal: 1.20

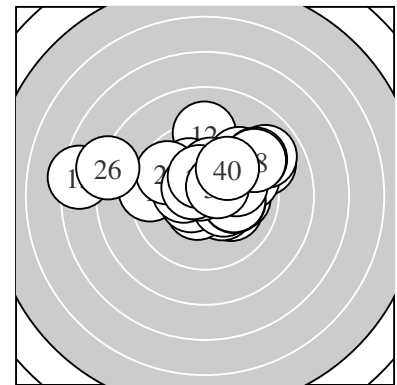
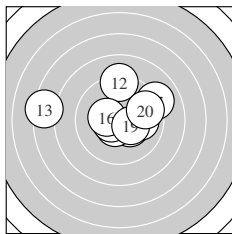

Serie 2:
 10.3 * 9.2 ↑ 7.3 ← 10.5 * 10.5 *
 10.3 * 9.0 ↗ 10.0 → 10.4 * 9.6 →
 beste Teiler 103.7 (14.) 103.7 (15.) 147.1 (19.)
 Trefferlage 0.01 mm rechts, 0.67 mm hoch
 Streuwert 2.85, horizontal: 3.65, vertikal: 1.71

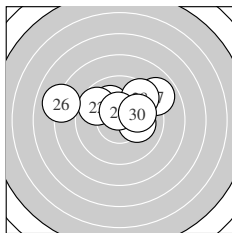

Serie 3:
 10.1 ↘ 9.7 ↘ 10.1 → 10.2 * 9.4 ↗
 8.1 ← 8.9 ↗ 9.5 ↗ 10.5 * 10.0 →
 beste Teiler 108.3 (29.) 197.4 (24.) 209.6 (23.)
 Trefferlage 0.43 mm rechts, 1.61 mm hoch
 Streuwert 2.43, horizontal: 3.30, vertikal: 0.98

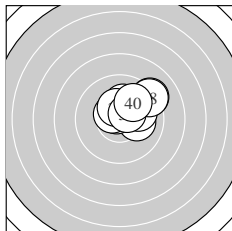

Serie 4:
 10.2 * 9.2 ↗ 10.1 → 10.7 * 10.0 →
 10.5 * 10.4 * 9.2 ↗ 10.5 * 9.9 ↗
 beste Teiler 60.2 (34.) 104.2 (36.) 110.8 (39.)
 Trefferlage 1.26 mm rechts, 1.25 mm hoch
 Streuwert 1.32, horizontal: 1.60, vertikal: 0.97

Unterschrift des Schützen

Meyton Elektronik

Ergebnis: **386** (403.9)
 Serien: 94 98 96 98
 Zähler: 29 8 3 0 0 0 0 0 0 0
 Innenzehner: 20
 weiteste: 581 (21), 564 (26), 507 (19)
 beste Teiler 12.8 (17.) 29.0 (25.) 29.6 (23.)
 Trefferlage 0.15 mm links, 0.02 mm tief
 Streuwert 1.81, horizontal: 1.82, vertikal: 1.81

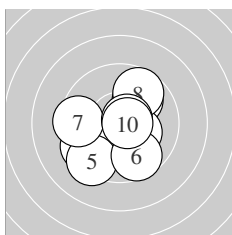
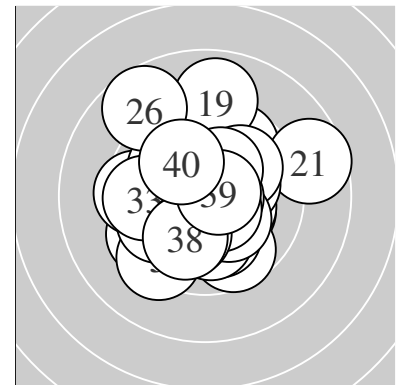

Serie 1:
 10.6 * 9.5 ↙ 9.9 ↗ 10.3 * 9.3 ↘
 9.7 ↘ 9.5 ← 9.7 ↗ 10.7 * 10.7 *
 beste Teiler 69.0 (10.) 72.4 (9.) 80.0 (1.)
 Trefferlage 0.15 mm links, 0.45 mm tief
 Streuwert 2.00, horizontal: 2.08, vertikal: 1.93

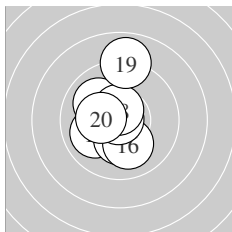

Serie 2:
 10.5 * 10.0 ↘ 10.6 * 10.0 ↙ 10.3 *
 10.1 ↘ 10.9 * 10.6 * 8.9 ↑ 10.3 *
 beste Teiler 12.8 (17.) 91.7 (18.) 98.0 (13.)
 Trefferlage 0.63 mm links, 0.37 mm hoch
 Streuwert 1.59, horizontal: 1.01, vertikal: 2.01

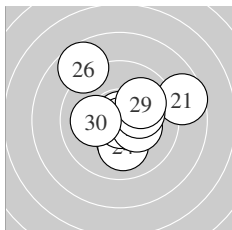

Serie 3:
 8.6 → 10.2 * 10.8 * 10.1 ↓ 10.8 *
 8.7 ↘ 10.3 * 10.2 * 10.0 ↗ 10.1 ←
 beste Teiler 29.0 (25.) 29.6 (23.) 163.2 (27.)
 Trefferlage 0.60 mm rechts, 0.40 mm hoch
 Streuwert 2.18, horizontal: 2.37, vertikal: 1.96

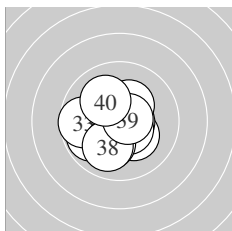

Serie 4:
 9.8 ↙ 10.2 * 9.7 ← 10.6 * 10.3 *
 10.5 * 10.1 ↘ 10.0 ↘ 10.7 * 10.1 ↘
 beste Teiler 73.4 (39.) 86.4 (34.) 103.2 (36.)
 Trefferlage 0.43 mm links, 0.42 mm tief
 Streuwert 1.45, horizontal: 1.55, vertikal: 1.33

Unterschrift des Schützen

Ergebnis: **387** (404.0)
 Serien: 95 97 97 98
 Zähler: 28 11 1 0 0 0 0 0 0 0
 Innenzehner: 19
 weiteste: 527 (10), 442 (15), 407 (5)
 beste Teiler 24.7 (18.) 42.1 (31.) 57.4 (17.)
 Trefferlage 0.63 mm links, 0.01 mm hoch
 Streuwert 1.68, horizontal: 1.66, vertikal: 1.69

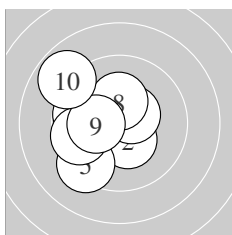
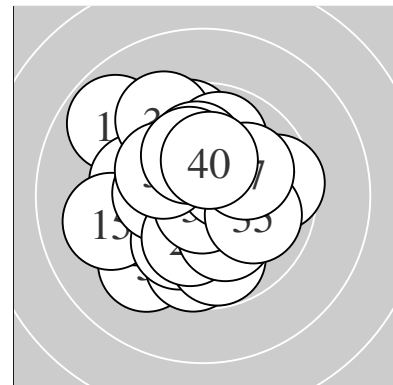

Serie 1:
 10.1 ↙ 10.4 * 9.8 ↖ 10.2 * 9.3 ↙
 10.5 * 9.7 ↖ 10.3 * 10.2 * 8.8 ↘
 beste Teiler 112.4 (6.) 142.2 (2.) 169.1 (8.)
 Trefferlage 1.67 mm links, 0.00 mm
 Streuwert 1.72, horizontal: 1.66, vertikal: 1.78

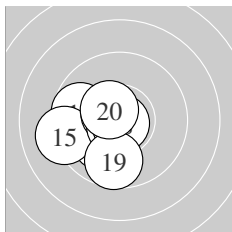

Serie 2:
 10.1 ↘ 10.7 * 10.1 ↘ 9.7 ↖ 9.2 ↖
 10.6 * 10.7 * 10.9 * 9.7 ↓ 10.5 *
 beste Teiler 24.7 (18.) 57.4 (17.) 61.9 (12.)
 Trefferlage 1.28 mm links, 0.62 mm tief
 Streuwert 1.30, horizontal: 1.35, vertikal: 1.25

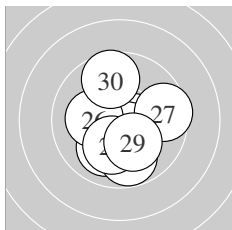

Serie 3:
 10.6 * 10.0 ↘ 10.5 * 10.6 * 9.8 ↓
 10.2 * 9.6 → 10.1 ↓ 10.2 * 9.7 ↑
 beste Teiler 96.0 (21.) 99.0 (24.) 103.7 (23.)
 Trefferlage 0.21 mm rechts, 0.66 mm tief
 Streuwert 1.60, horizontal: 1.48, vertikal: 1.72

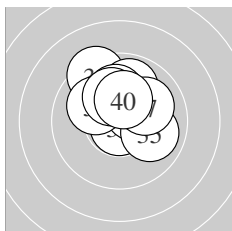

Serie 4:
 10.8 * 9.4 ↘ 10.4 * 9.9 ↑ 10.0 →
 10.1 ↑ 10.0 → 10.1 ↘ 10.2 * 10.3 *
 beste Teiler 42.1 (31.) 132.3 (33.) 167.5 (40.)
 Trefferlage 0.18 mm rechts, 1.35 mm hoch
 Streuwert 1.37, horizontal: 1.42, vertikal: 1.32

Unterschrift des Schützen

Ergebnis:	383	(400.4)
Serien:	94 97 97 95	
Zähler:	23 17 0 0 0 0 0 0 0 0	
Innenzehner:	16	
weiteste:	491 (7), 490 (9), 422 (33)	
beste Teiler	57.1 (13.) 83.0 (10.) 96.8 (11.)	
Trefferlage	0.73 mm rechts, 1.31 mm hoch	
Streuwert	1.52, horizontal: 1.77, vertikal: 1.23	

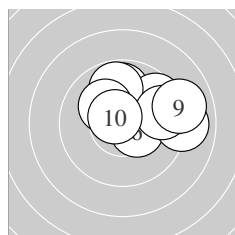
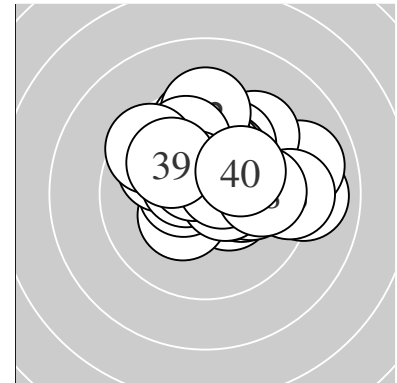

Serie 1:				
	10.3 *	9.9 ↑	9.6 ↗	9.8 ↑
	10.4 *	9.0 →	9.6 →	10.2 *
beste Teiler	83.0 (10.)	131.9 (6.)	172.7 (1.)	
Trefferlage	1.53 mm rechts, 1.22 mm hoch			
Streuwert	1.79, horizontal: 2.27, vertikal: 1.10			

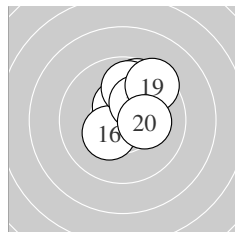

Serie 2:				
	10.6 *	9.7 ↗	10.7 *	10.5 *
	10.3 *	9.9 ↑	10.2 *	10.1 ↗
beste Teiler	57.1 (13.)	96.8 (11.)	114.9 (14.)	
Trefferlage	0.75 mm rechts, 1.25 mm hoch			
Streuwert	1.20, horizontal: 1.01, vertikal: 1.35			

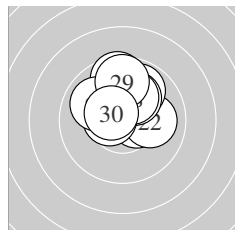

Serie 3:				
	10.5 *	10.0 →	9.6 ↑	9.9 ↗
	10.5 *	10.0 ↘	10.1 ↑	10.1 ↗
beste Teiler	107.5 (26.)	110.9 (30.)	118.2 (21.)	
Trefferlage	0.18 mm rechts, 1.46 mm hoch			
Streuwert	1.32, horizontal: 1.34, vertikal: 1.31			

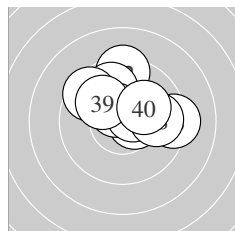

Serie 4:				
	10.6 *	9.3 ↑	9.3 →	9.8 ↑
	10.6 *	9.5 ↘	9.8 →	10.5 *
beste Teiler	100.4 (31.)	100.4 (36.)	104.4 (35.)	
Trefferlage	0.48 mm rechts, 1.30 mm hoch			
Streuwert	1.76, horizontal: 2.10, vertikal: 1.34			

Unterschrift des Schützen

Meyton Elektronik

Ergebnis:	373	(390.1)
Serien:	93	95 92 93
Zähler:	17	19 4 0 0 0 0 0 0 0
Innenzehner:	14	
weiteste:	738	(22), 612 (32), 570 (3)
beste Teiler	19.6	(13.) 66.9 (40.) 109.9 (6.)
Trefferlage	0.99 mm	links, 0.75 mm hoch
Streuwert	2.26,	horizontal: 2.33, vertikal: 2.20

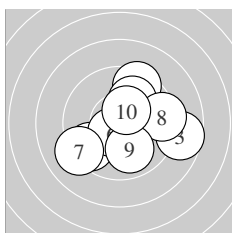
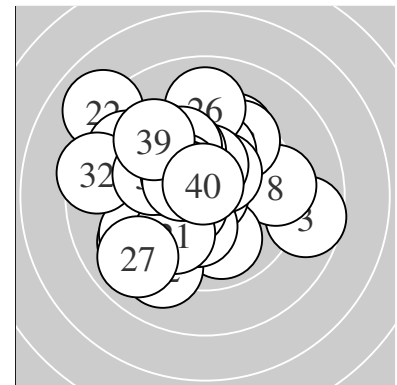

Serie 1:	9.4 ↗	10.4 *	8.7 →	9.6 ↙	10.0 ↗
	10.5 *	9.1 ↙	9.4 →	9.9 ↓	10.4 *
beste Teiler	109.9	(6.) 135.0	(10.) 148.3	(2.)	
Trefferlage	0.74 mm rechts, 0.05 mm tief				
Streuwert	2.44, horizontal: 2.77, vertikal: 2.07				

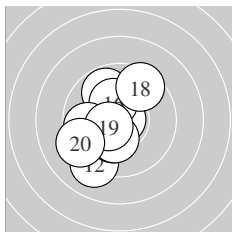

Serie 2:	9.8 ↖	9.1 ↙	10.9 *	10.2 *	10.3 *
	10.3 *	9.7 ←	9.5 ↗	10.5 *	9.3 ↙
beste Teiler	19.6	(13.) 116.4	(19.) 171.1	(16.)	
Trefferlage	1.07 mm links, 0.33 mm tief				
Streuwert	1.93, horizontal: 1.60, vertikal: 2.21				

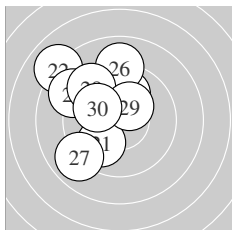

Serie 3:	9.9 ↙	8.0 ↖	9.0 ↖	10.2 *	10.0 ↗
	9.0 ↑	8.9 ↙	9.4 ↖	10.3 *	10.0 ↖
beste Teiler	157.0	(29.) 181.3	(24.) 235.0	(30.)	
Trefferlage	1.82 mm links, 1.63 mm hoch				
Streuwert	2.46, horizontal: 2.27, vertikal: 2.64				

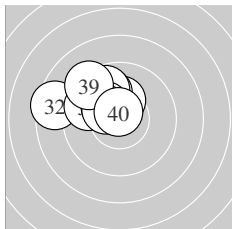

Serie 4:	10.3 *	8.5 ←	9.9 ↖	9.7 ↖	9.7 ↖
	9.7 ↖	10.2 *	10.4 *	9.3 ↖	10.7 *
beste Teiler	66.9	(40.) 150.9	(38.) 172.7	(31.)	
Trefferlage	1.84 mm links, 1.77 mm hoch				
Streuwert	1.38, horizontal: 1.76, vertikal: 0.87				

Unterschrift des Schützen

Meyton Elektronik

Ergebnis: **380** (396.0)
 Serien: 96 93 95 96
 Zähler: 22 16 2 0 0 0 0 0 0 0
 Innenzehner: 14
 weiteste: 535 (13), 525 (34), 459 (5)
 beste Teiler 63.1 (15.) 68.4 (28.) 73.2 (32.)
 Trefferlage 0.56 mm rechts, 0.28 mm hoch
 Streuwert 2.04, horizontal: 2.02, vertikal: 2.07

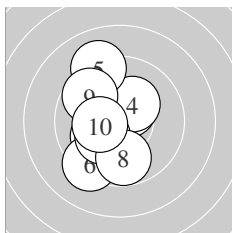
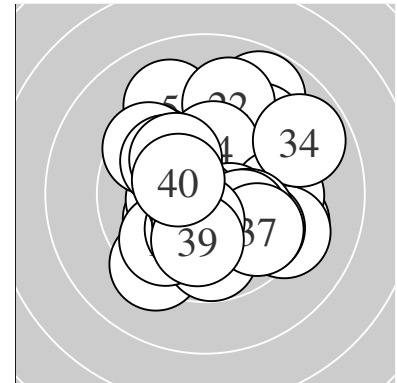

Serie 1:
 10.1 ↙ 10.4 * 10.5 * 10.3 * 9.1 ↗
 9.3 ↙ 10.2 * 9.8 ↓ 9.7 ↘ 10.3 *
 beste Teiler 117.8 (3.) 127.1 (2.) 162.2 (10.)
 Trefferlage 1.03 mm links, 0.08 mm tief
 Streuwert 1.87, horizontal: 1.26, vertikal: 2.33

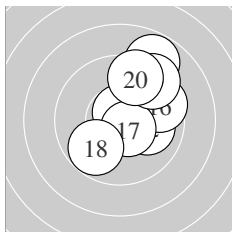

Serie 2:
 9.7 ↗ 10.0 → 8.8 ↗ 10.2 * 10.7 *
 9.6 → 10.6 * 9.8 ↙ 9.3 ↗ 9.5 ↗
 beste Teiler 63.1 (15.) 98.2 (17.) 186.2 (14.)
 Trefferlage 1.49 mm rechts, 1.26 mm hoch
 Streuwert 1.85, horizontal: 1.56, vertikal: 2.10

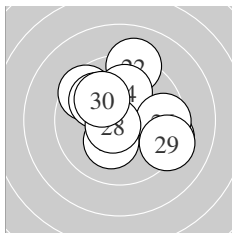

Serie 3:
 9.3 → 9.1 ↑ 9.6 ↘ 10.0 ↑ 10.0 ↘
 9.5 → 10.2 * 10.7 * 9.3 → 10.1 ↘
 beste Teiler 68.4 (28.) 182.1 (27.) 220.6 (30.)
 Trefferlage 0.54 mm rechts, 0.66 mm hoch
 Streuwert 2.26, horizontal: 2.45, vertikal: 2.06

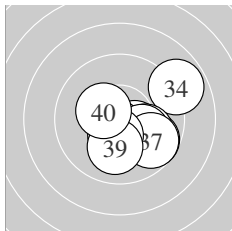

Serie 4:
 10.4 * 10.7 * 9.7 ↘ 8.9 ↗ 10.0 →
 10.1 → 9.7 ↘ 10.4 * 10.0 ↓ 10.4 *
 beste Teiler 73.2 (32.) 136.0 (38.) 142.3 (31.)
 Trefferlage 1.23 mm rechts, 0.71 mm tief
 Streuwert 1.63, horizontal: 1.82, vertikal: 1.40

Unterschrift des Schützen

Meyton Elektronik

Ergebnis: **385** (402.3)
 Serien: 96 96 97 96
 Zähler: 25 15 0 0 0 0 0 0 0 0
 Innenzehner: 20
 weiteste: 499 (31), 453 (30), 433 (16)
 beste Teiler 41.3 (35.) 50.9 (3.) 54.7 (22.)
 Trefferlage 0.01 mm links, 0.17 mm hoch
 Streuwert 1.81, horizontal: 2.14, vertikal: 1.42

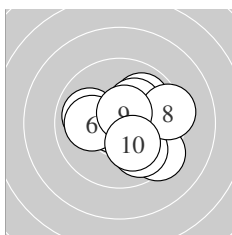
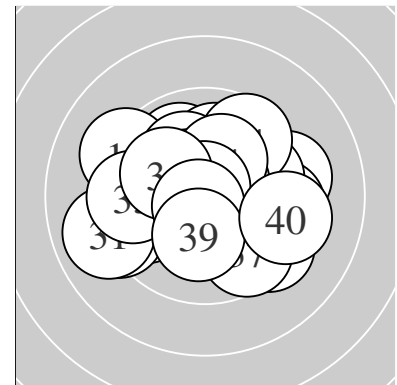

Serie 1:
 10.0 ↖ 9.9 ↗ 10.8 * 9.4 ↘ 9.9 ↘
 10.1 ← 10.2 * 9.3 → 10.6 * 10.2 *
 beste Teiler 50.9 (3.) 91.2 (9.) 183.7 (7.)
 Trefferlage 0.78 mm rechts, 0.07 mm tief
 Streuwert 1.80, horizontal: 2.06, vertikal: 1.49

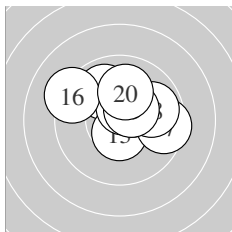

Serie 2:
 10.2 * 9.9 ↖ 10.5 * 10.5 * 10.4 *
 9.2 ↖ 9.5 → 9.9 → 10.4 * 10.0 ↑
 beste Teiler 103.0 (13.) 109.4 (14.) 128.1 (19.)
 Trefferlage 0.44 mm rechts, 1.06 mm hoch
 Streuwert 1.63, horizontal: 2.01, vertikal: 1.12

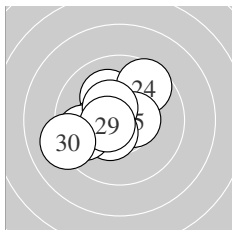

Serie 3:
 10.1 ↖ 10.7 * 10.3 * 9.6 ↗ 10.5 *
 10.4 * 9.7 ← 10.5 * 10.5 * 9.1 ←
 beste Teiler 54.7 (22.) 104.0 (29.) 108.0 (25.)
 Trefferlage 0.97 mm links, 0.11 mm hoch
 Streuwert 1.57, horizontal: 1.75, vertikal: 1.37

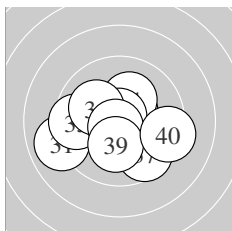

Serie 4:
 9.0 ← 10.5 * 9.6 ← 10.2 * 10.8 *
 10.1 ↖ 9.6 ↘ 10.7 * 10.2 * 9.3 →
 beste Teiler 41.3 (35.) 58.2 (38.) 110.0 (32.)
 Trefferlage 0.31 mm links, 0.40 mm tief
 Streuwert 2.05, horizontal: 2.53, vertikal: 1.42

Unterschrift des Schützen

Meyton Elektronik

Ergebnis: **349** (363.4)
 Serien: 85 90 84 90
 Zähler: 10 15 9 6 0 0 0 0 0 0
 Innenzehner: 6
 weiteste: 931 (17), 926 (32), 844 (31)
 beste Teiler 55.4 (15.) 61.2 (34.) 99.2 (25.)
 Trefferlage 1.49 mm rechts, 1.18 mm tief
 Streuwert 3.52, horizontal: 3.54, vertikal: 3.50

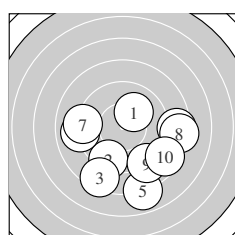
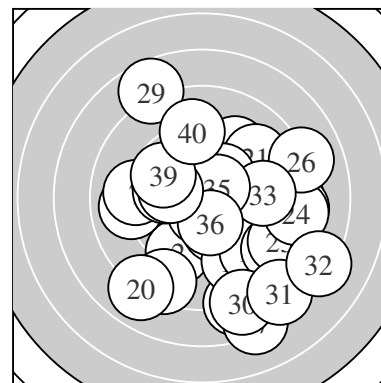

Serie 1:
 10.1 ↗ 9.3 ↘ 8.4 ↘ 8.5 → 7.9 ↘
 9.0 ← 9.1 ← 8.3 → 9.0 ↘ 8.6 ↘
 beste Teiler 216.0 (1.) 406.9 (2.) 459.4 (7.)
 Trefferlage 1.02 mm rechts, 2.35 mm tief
 Streuwert 3.66, horizontal: 4.27, vertikal: 2.93

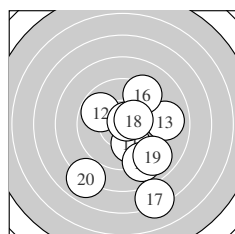

Serie 2:
 10.0 ↘ 9.8 ↖ 9.0 → 9.0 ↘ 10.7 *
 9.3 ↗ 7.2 ↘ 10.4 * 9.0 ↘ 8.0 ↘
 beste Teiler 55.4 (15.) 135.5 (18.) 238.0 (11.)
 Trefferlage 1.23 mm rechts, 1.89 mm tief
 Streuwert 3.31, horizontal: 2.81, vertikal: 3.75

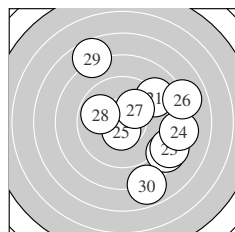

Serie 3:
 9.1 ↗ 8.5 ↘ 8.5 ↘ 8.3 → 10.6 *
 8.0 → 10.1 ↗ 9.9 ↖ 7.7 ↖ 7.9 ↘
 beste Teiler 99.2 (25.) 207.3 (27.) 272.3 (28.)
 Trefferlage 2.53 mm rechts, 0.04 mm tief
 Streuwert 3.87, horizontal: 3.67, vertikal: 4.05

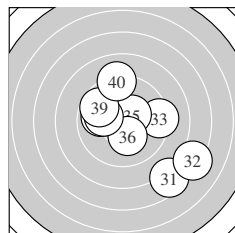

Serie 4:
 7.6 ↘ 7.2 ↘ 9.3 → 10.7 * 10.4 *
 10.2 * 9.9 ← 10.1 ← 9.7 ↖ 9.1 ↑
 beste Teiler 61.2 (34.) 129.8 (35.) 181.1 (36.)
 Trefferlage 1.17 mm rechts, 0.43 mm tief
 Streuwert 3.40, horizontal: 3.63, vertikal: 3.15

Unterschrift des Schützen

Meyton Elektronik

Ergebnis: **396** (414.0)
 Serien: 100 99 99 98
 Zähler: 36 4 0 0 0 0 0 0 0 0
 Innenzehner: 30
 weiteste: 369 (39), 311 (38), 267 (22)
 beste Teiler 39.1 (36.) 41.0 (1.) 42.0 (2.)
 Trefferlage 0.27 mm links, 0.34 mm hoch
 Streuwert 1.19, horizontal: 1.29, vertikal: 1.09

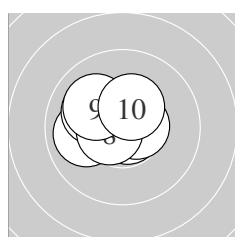
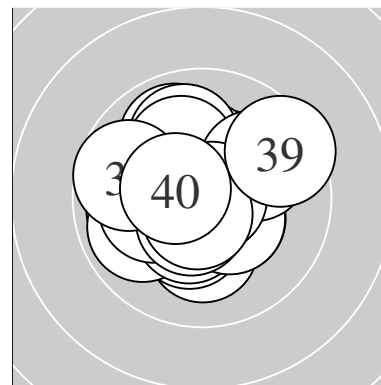

Serie 1:
 10.8 * 10.8 * 10.0 ← 10.2 * 10.6 *
 10.6 * 10.1 ↖ 10.6 * 10.1 ↖ 10.4 *
 beste Teiler 41.0 (1.) 42.0 (2.) 78.5 (5.)
 Trefferlage 0.74 mm links, 0.50 mm hoch
 Streuwert 0.97, horizontal: 1.17, vertikal: 0.71

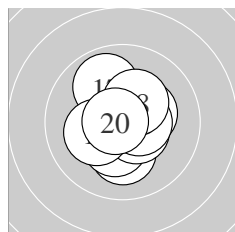

Serie 2:
 10.8 * 10.2 * 10.3 * 10.3 * 10.5 *
 10.5 * 9.9 ↗ 10.3 * 10.2 * 10.8 *
 beste Teiler 48.0 (11.) 50.3 (20.) 109.0 (15.)
 Trefferlage 0.02 mm rechts, 0.07 mm tief
 Streuwert 1.17, horizontal: 1.05, vertikal: 1.28

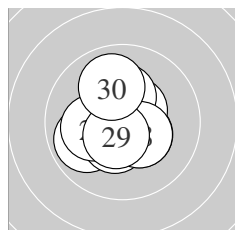

Serie 3:
 10.5 * 9.9 ← 10.4 * 10.4 * 10.5 *
 10.2 * 10.3 * 10.4 * 10.6 * 10.0 ↗
 beste Teiler 100.1 (29.) 109.1 (21.) 111.0 (25.)
 Trefferlage 0.34 mm links, 0.05 mm hoch
 Streuwert 1.25, horizontal: 1.19, vertikal: 1.30

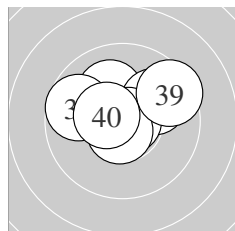

Serie 4:
 10.4 * 10.6 * 10.5 * 10.1 ↗ 10.0 ↗
 10.8 * 10.7 * 9.7 ← 9.5 ↗ 10.5 *
 beste Teiler 39.1 (36.) 68.0 (37.) 93.1 (32.)
 Trefferlage 0.04 mm links, 0.90 mm hoch
 Streuwert 1.33, horizontal: 1.70, vertikal: 0.80

Unterschrift des Schützen

Meyton Elektronik

Ergebnis: **392** (412.5)
 Serien: 98 99 98 97
 Zähler: 32 8 0 0 0 0 0 0 0 0
 Innenzehner: 28
 weiteste: 410 (23), 335 (28), 323 (40)
 beste Teiler 17.1 (16.) 30.0 (18.) 36.6 (2.)
 Trefferlage 0.28 mm links, 0.05 mm hoch
 Streuwert 1.32, horizontal: 1.65, vertikal: 0.88

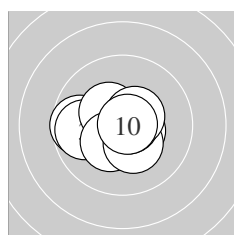
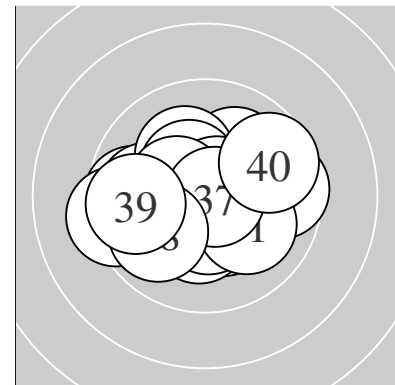

Serie 1:
 9.7 ← 10.8 * 9.8 ← 10.4 * 10.3 *
 10.5 * 10.3 * 10.8 * 10.5 * 10.8 *
 beste Teiler 36.6 (2.) 36.6 (10.) 48.2 (8.)
 Trefferlage 0.45 mm links, 0.19 mm tief
 Streuwert 1.20, horizontal: 1.52, vertikal: 0.73

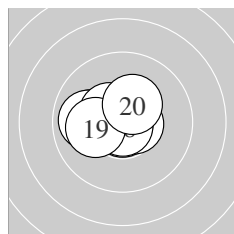

Serie 2:
 10.0 ← 10.8 * 9.9 ← 10.7 * 10.6 *
 10.9 * 10.5 * 10.8 * 10.1 ← 10.3 *
 beste Teiler 17.1 (16.) 30.0 (18.) 38.0 (12.)
 Trefferlage 0.58 mm links, 0.11 mm hoch
 Streuwert 1.00, horizontal: 1.31, vertikal: 0.54

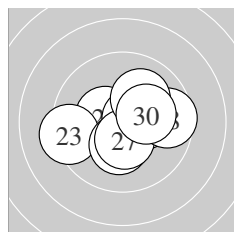

Serie 3:
 10.5 * 10.4 * 9.3 ← 10.7 * 10.3 *
 10.3 * 10.4 * 9.6 → 10.1 ↗ 10.2 *
 beste Teiler 75.0 (24.) 118.0 (21.) 128.8 (27.)
 Trefferlage 0.21 mm rechts, 0.03 mm tief
 Streuwert 1.61, horizontal: 2.05, vertikal: 1.01

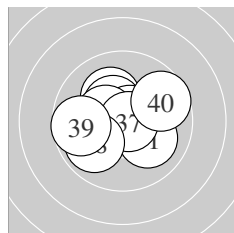

Serie 4:
 10.0 ↘ 10.4 * 10.2 * 10.4 * 10.7 *
 10.4 * 10.8 * 9.9 ↙ 9.7 ← 9.7 →
 beste Teiler 45.1 (37.) 68.2 (35.) 134.4 (36.)
 Trefferlage 0.30 mm links, 0.32 mm hoch
 Streuwert 1.51, horizontal: 1.79, vertikal: 1.15

Unterschrift des Schützen

Meyton Elektronik

Ergebnis:	393	(413.6)
Serien:	100	99 98 96
Zähler:	33	7 0 0 0 0 0 0 0 0
Innenzehner:	32	
weiteste:	360 (35), 359 (40), 340 (38)	
beste Teiler	42.0 (9.)	57.6 (37.) 57.9 (13.)
Trefferlage	0.06 mm rechts, 0.20 mm hoch	
Streuwert	1.25, horizontal: 1.41, vertikal: 1.06	

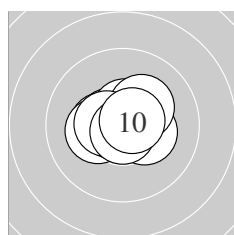
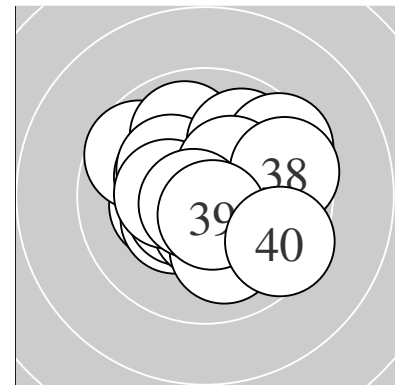

Serie 1:	10.6 *	10.4 *	10.3 *	10.3 *	10.7 *
	10.6 *	10.2 *	10.5 *	10.8 *	10.7 *
beste Teiler	42.0 (9.)	61.5 (5.)	72.0 (10.)		
Trefferlage	0.20 mm links, 0.14 mm hoch				
Streuwert	0.88, horizontal: 1.11, vertikal: 0.56				

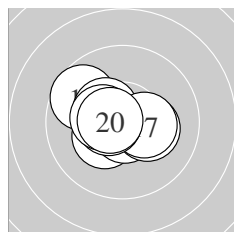

Serie 2:	10.6 *	10.3 *	10.7 *	9.7 ↘	10.4 *
	10.3 *	10.4 *	10.6 *	10.4 *	10.6 *
beste Teiler	57.9 (13.)	83.4 (11.)	86.8 (20.)		
Trefferlage	0.55 mm links, 0.01 mm hoch				
Streuwert	1.09, horizontal: 1.33, vertikal: 0.77				

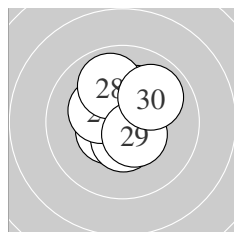

Serie 3:	10.7 *	10.6 *	10.5 *	10.6 *	10.2 *
	10.5 *	10.3 *	9.9 ↗	10.5 *	9.9 ↗
beste Teiler	58.4 (21.)	83.3 (24.)	94.5 (22.)		
Trefferlage	0.04 mm rechts, 0.42 mm hoch				
Streuwert	1.15, horizontal: 1.01, vertikal: 1.27				

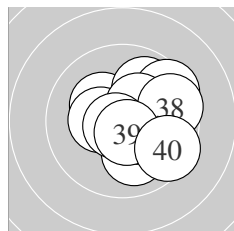

Serie 4:	10.2 *	10.0 ↘	9.9 ↗	10.4 *	9.5 ↗
	10.4 *	10.7 *	9.6 →	10.6 *	9.5 ↘
beste Teiler	57.6 (37.)	83.5 (39.)	148.4 (36.)		
Trefferlage	0.96 mm rechts, 0.21 mm hoch				
Streuwert	1.64, horizontal: 1.77, vertikal: 1.50				

Unterschrift des Schützen

Meyton Elektronik

Ergebnis: **395** (411.7)
 Serien: 99 99 98 99
 Zähler: 35 5 0 0 0 0 0 0 0 0
 Innenzehner: 29
 weiteste: 407 (22), 347 (33), 310 (14)
 beste Teiler 14.3 (4.) 37.2 (38.) 52.9 (36.)
 Trefferlage 0.06 mm rechts, 0.22 mm hoch
 Streuwert 1.32, horizontal: 1.40, vertikal: 1.23

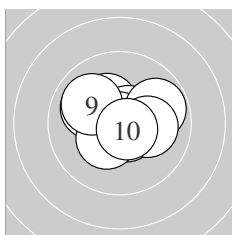
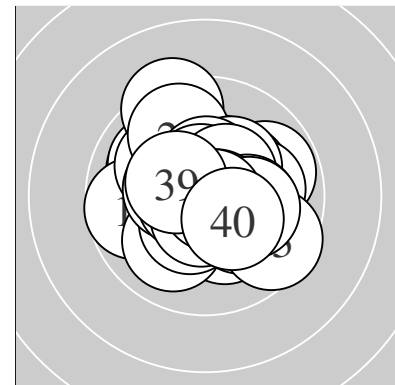

Serie 1:
 10.3 * 10.0 ↖ 10.6 * 10.9 * 10.6 *
 9.8 ↗ 10.1 → 10.4 * 10.0 ↖ 10.7 *
 beste Teiler 14.3 (4.) 69.6 (10.) 77.9 (5.)
 Trefferlage 0.02 mm rechts, 0.30 mm hoch
 Streuwert 1.28, horizontal: 1.58, vertikal: 0.90

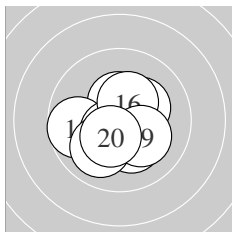

Serie 2:
 10.3 * 10.4 * 10.6 * 9.7 ← 10.5 *
 10.4 * 10.2 * 10.0 ↙ 10.2 * 10.4 *
 beste Teiler 80.8 (13.) 101.5 (15.) 130.5 (12.)
 Trefferlage 0.08 mm links, 0.43 mm tief
 Streuwert 1.31, horizontal: 1.42, vertikal: 1.20

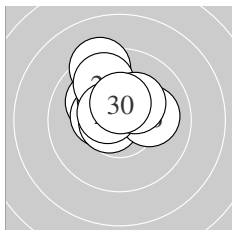

Serie 3:
 10.1 ↖ 9.3 ↗ 10.4 * 10.6 * 10.2 *
 10.1 → 9.8 ↖ 10.5 * 10.3 * 10.5 *
 beste Teiler 76.6 (24.) 101.8 (28.) 125.1 (30.)
 Trefferlage 0.48 mm links, 1.28 mm hoch
 Streuwert 1.23, horizontal: 1.25, vertikal: 1.20

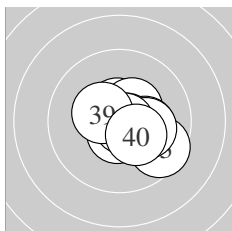

Serie 4:
 10.6 * 10.4 * 9.6 ↖ 10.6 * 10.2 *
 10.7 * 10.2 * 10.8 * 10.4 * 10.3 *
 beste Teiler 37.2 (38.) 52.9 (36.) 87.6 (34.)
 Trefferlage 0.80 mm rechts, 0.26 mm tief
 Streuwert 1.07, horizontal: 1.23, vertikal: 0.89

Unterschrift des Schützen

Meyton Elektronik

Ergebnis: **393** (411.1)
 Serien: 97 99 98 99
 Zähler: 33 7 0 0 0 0 0 0 0 0
 Innenzehner: 29
 weiteste: 400 (29), 358 (40), 326 (19)
 beste Teiler 12.8 (37.) 42.0 (14.) 52.4 (24.)
 Trefferlage 0.09 mm rechts, 0.11 mm hoch
 Streuwert 1.36, horizontal: 1.48, vertikal: 1.21

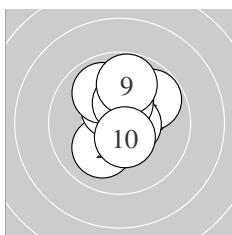
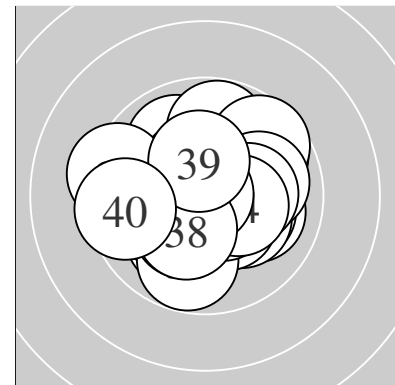

Serie 1:
 10.2 * 10.1 ↙ 10.5 * 9.8 ↗ 10.4 *
 9.9 ↘ 10.6 * 10.4 * 9.8 ↑ 10.5 *
 beste Teiler 83.4 (7.) 111.0 (10.) 125.1 (3.)
 Trefferlage 0.26 mm rechts, 0.89 mm hoch
 Streuwert 1.31, horizontal: 1.16, vertikal: 1.45

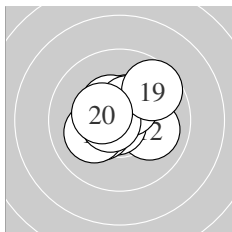

Serie 2:
 10.5 * 10.0 → 10.4 * 10.8 * 10.3 *
 10.5 * 10.1 ← 10.7 * 9.6 ↗ 10.4 *
 beste Teiler 42.0 (14.) 69.0 (18.) 121.2 (11.)
 Trefferlage 0.03 mm links, 0.31 mm hoch
 Streuwert 1.27, horizontal: 1.46, vertikal: 1.03

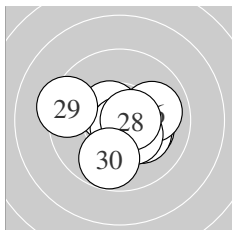

Serie 3:
 10.6 * 10.4 * 10.2 * 10.7 * 10.2 *
 10.0 → 10.4 * 10.6 * 9.4 ← 9.8 ↓
 beste Teiler 52.4 (24.) 81.0 (28.) 98.4 (21.)
 Trefferlage 0.34 mm rechts, 0.38 mm tief
 Streuwert 1.50, horizontal: 1.81, vertikal: 1.11

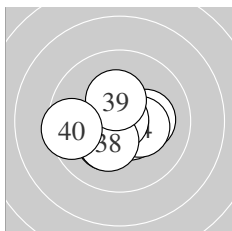

Serie 4:
 10.6 * 10.2 * 10.6 * 10.3 * 10.3 *
 10.3 * 10.9 * 10.3 * 10.3 * 9.5 ←
 beste Teiler 12.8 (37.) 100.2 (31.) 100.2 (33.)
 Trefferlage 0.19 mm links, 0.36 mm tief
 Streuwert 1.28, horizontal: 1.60, vertikal: 0.86

Unterschrift des Schützen

Meyton Elektronik

Ergebnis: **386** (405.7)
 Serien: 98 96 98 94
 Zähler: 26 14 0 0 0 0 0 0 0 0
 Innenzehner: 22
 weiteste: 485 (17), 461 (10), 377 (32)
 beste Teiler 44.4 (8.) 47.0 (37.) 49.3 (15.)
 Trefferlage 0.31 mm links, 0.10 mm hoch
 Streuwert 1.63, horizontal: 1.79, vertikal: 1.45

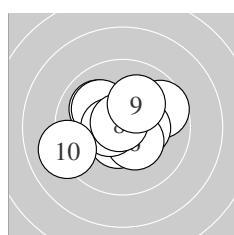
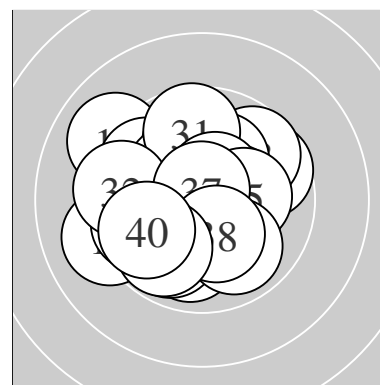

Serie 1:
 9.7 ↗ 10.0 ↘ 10.4 * 10.1 ↘ 10.6 *
 10.4 * 10.6 * 10.8 * 10.1 ↗ 9.1 ←
 beste Teiler 44.4 (8.) 100.0 (7.) 100.6 (5.)
 Trefferlage 0.31 mm links, 0.25 mm hoch
 Streuwert 1.69, horizontal: 2.05, vertikal: 1.23

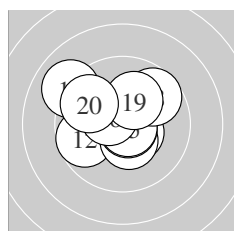

Serie 2:
 10.5 * 9.7 ← 10.4 * 10.7 * 10.8 *
 10.5 * 9.0 ↘ 9.7 ↗ 10.1 ↗ 9.7 ↘
 beste Teiler 49.3 (15.) 55.3 (14.) 114.8 (11.)
 Trefferlage 0.50 mm links, 0.52 mm hoch
 Streuwert 1.77, horizontal: 2.04, vertikal: 1.44

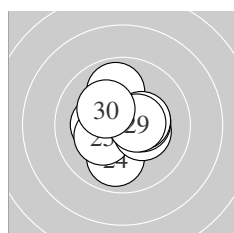

Serie 3:
 9.9 ↑ 10.4 * 10.2 * 9.9 ↓ 10.3 *
 10.3 * 10.4 * 10.4 * 10.5 * 10.2 *
 beste Teiler 111.1 (29.) 127.7 (22.) 149.0 (27.)
 Trefferlage 0.11 mm rechts, 0.08 mm hoch
 Streuwert 1.35, horizontal: 1.38, vertikal: 1.32

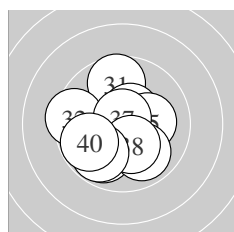

Serie 4:
 9.7 ↑ 9.4 ← 10.5 * 9.9 ↘ 10.2 *
 9.9 ↘ 10.8 * 10.3 * 9.8 ↘ 9.8 ←
 beste Teiler 47.0 (37.) 109.0 (33.) 171.6 (38.)
 Trefferlage 0.53 mm links, 0.44 mm tief
 Streuwert 1.81, horizontal: 1.83, vertikal: 1.79

Unterschrift des Schützen

Ergebnis: **382** (400.1)
 Serien: 96 93 98 95
 Zähler: 22 18 0 0 0 0 0 0 0 0
 Innenzehner: 16
 weiteste: 500 (14), 488 (30), 469 (39)
 beste Teiler 4.4 (34.) 97.6 (26.) 99.4 (40.)
 Trefferlage 0.20 mm rechts, 0.39 mm tief
 Streuwert 1.85, horizontal: 2.28, vertikal: 1.29

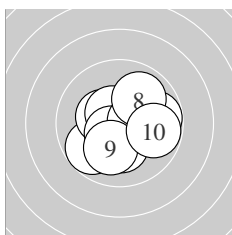
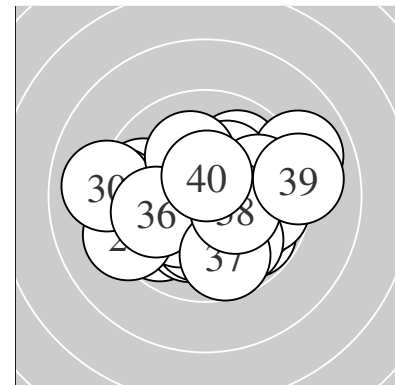

Serie 1:
 9.8 ↙ 10.4 * 9.8 → 10.5 * 10.2 *
 10.5 * 10.5 * 9.9 ↗ 10.1 ↓ 9.8 →
 beste Teiler 103.6 (4.) 106.6 (6.) 124.4 (7.)
 Trefferlage 0.30 mm rechts, 0.33 mm tief
 Streuwert 1.57, horizontal: 1.76, vertikal: 1.36

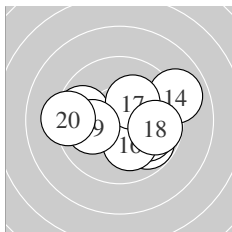

Serie 2:
 9.8 ↘ 9.9 ↘ 9.7 ← 9.0 → 9.7 ←
 10.1 ↓ 10.2 * 9.8 → 10.0 ← 9.3 ←
 beste Teiler 183.2 (17.) 209.5 (16.) 229.6 (19.)
 Trefferlage 0.14 mm rechts, 0.18 mm tief
 Streuwert 2.34, horizontal: 3.04, vertikal: 1.30

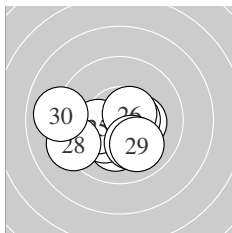

Serie 3:
 10.2 * 10.2 * 10.3 * 10.5 * 10.2 *
 10.6 * 10.1 ↓ 9.2 ↙ 10.0 ↓ 9.0 ←
 beste Teiler 97.6 (26.) 111.0 (24.) 165.9 (23.)
 Trefferlage 0.60 mm links, 0.87 mm tief
 Streuwert 1.78, horizontal: 2.28, vertikal: 1.05

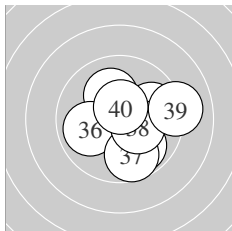

Serie 4:
 9.9 ↘ 10.4 * 10.1 ↖ 10.9 * 9.9 →
 9.9 ← 9.7 ↓ 10.3 * 9.1 → 10.6 *
 beste Teiler 4.4 (34.) 99.4 (40.) 137.4 (32.)
 Trefferlage 0.96 mm rechts, 0.20 mm tief
 Streuwert 1.72, horizontal: 1.91, vertikal: 1.49

Unterschrift des Schützen

Meyton Elektronik

Ergebnis: **384** (402.4)
 Serien: 94 95 98 97
 Zähler: 25 14 1 0 0 0 0 0 0 0
 Innenzehner: 21
 weiteste: 508 (19), 466 (8), 465 (15)
 beste Teiler 9.8 (26.) 63.2 (18.) 68.6 (32.)
 Trefferlage 0.96 mm rechts, 0.13 mm hoch
 Streuwert 1.69, horizontal: 1.99, vertikal: 1.32

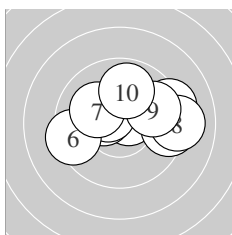
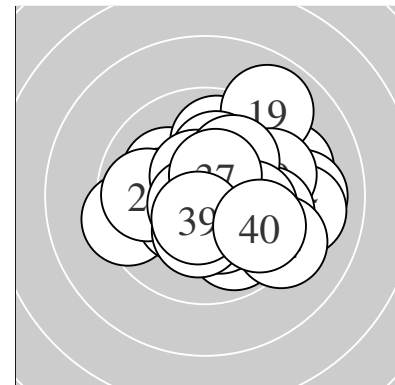

Serie 1:
 10.6 * 10.4 * 9.4 → 9.3 → 10.5 *
 9.4 ← 10.1 ↘ 9.1 → 9.8 → 9.9 ↑
 beste Teiler 85.5 (1.) 118.2 (5.) 134.7 (2.)
 Trefferlage 0.88 mm rechts, 0.61 mm hoch
 Streuwert 2.15, horizontal: 2.86, vertikal: 1.03

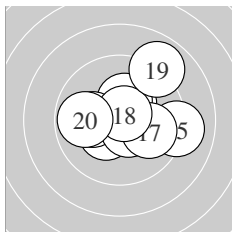

Serie 2:
 10.3 * 10.3 * 10.4 * 10.1 ← 9.1 →
 10.5 * 9.9 ↘ 10.7 * 8.9 ↗ 9.8 ←
 beste Teiler 63.2 (18.) 103.2 (16.) 147.2 (13.)
 Trefferlage 0.61 mm rechts, 0.43 mm hoch
 Streuwert 1.96, horizontal: 2.29, vertikal: 1.57

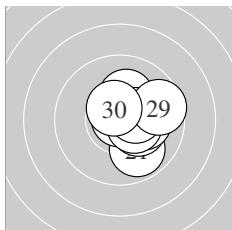

Serie 3:
 9.9 ↘ 10.5 * 10.3 * 10.2 * 10.2 *
 10.9 * 10.4 * 10.4 * 9.6 → 10.5 *
 beste Teiler 9.8 (26.) 105.0 (22.) 105.6 (30.)
 Trefferlage 1.05 mm rechts, 0.17 mm hoch
 Streuwert 1.13, horizontal: 1.08, vertikal: 1.17

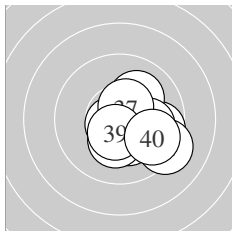

Serie 4:
 9.7 → 10.7 * 10.1 ↗ 9.2 ↘ 10.3 *
 10.0 → 10.5 * 10.3 * 10.5 * 9.7 ↘
 beste Teiler 68.6 (32.) 111.8 (37.) 112.5 (39.)
 Trefferlage 1.29 mm rechts, 0.70 mm tief
 Streuwert 1.39, horizontal: 1.54, vertikal: 1.22

Unterschrift des Schützen

Meyton Elektronik

Ergebnis: **389** (406.8)
 Serien: 98 96 96 99
 Zähler: 30 9 1 0 0 0 0 0 0 0
 Innenzehner: 23
 weiteste: 546 (27), 415 (16), 386 (18)
 beste Teiler 38.1 (23.) 44.9 (2.) 51.6 (32.)
 Trefferlage 0.36 mm rechts, 0.58 mm tief
 Streuwert 1.55, horizontal: 1.80, vertikal: 1.26

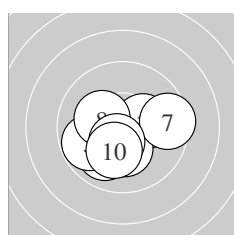
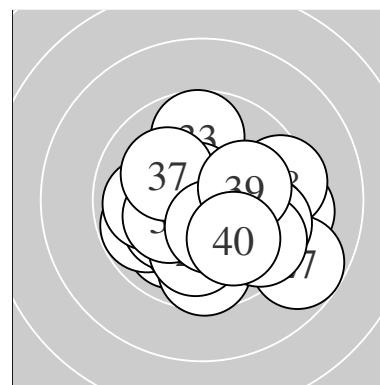

Serie 1:
 10.5 * 10.8 * 10.3 * 10.0 ✓ 9.8 ←
 10.3 * 9.5 → 10.2 * 10.4 * 10.2 *
 beste Teiler 44.9 (2.) 113.8 (1.) 126.0 (9.)
 Trefferlage 0.23 mm links, 0.76 mm tief
 Streuwert 1.44, horizontal: 1.77, vertikal: 1.01

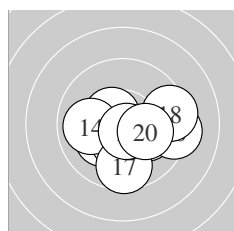

Serie 2:
 10.2 * 10.4 * 10.5 * 9.9 ← 10.1 →
 9.3 → 9.6 ↓ 9.4 → 10.7 * 10.2 *
 beste Teiler 65.7 (19.) 111.6 (13.) 138.5 (12.)
 Trefferlage 0.67 mm rechts, 0.68 mm tief
 Streuwert 1.76, horizontal: 2.20, vertikal: 1.16

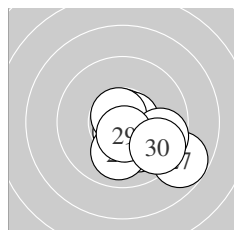

Serie 3:
 10.6 * 10.1 ✘ 10.8 * 10.7 * 10.7 *
 10.0 ↓ 8.8 ✘ 9.7 → 10.6 * 9.6 ✘
 beste Teiler 38.1 (23.) 58.8 (25.) 68.4 (24.)
 Trefferlage 1.17 mm rechts, 1.08 mm tief
 Streuwert 1.48, horizontal: 1.71, vertikal: 1.19

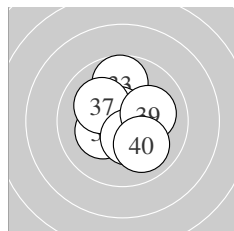

Serie 4:
 10.2 * 10.7 * 9.7 ↑ 10.7 * 10.7 *
 10.3 * 10.1 ✘ 10.4 * 10.1 → 10.0 ✘
 beste Teiler 51.6 (32.) 55.3 (34.) 60.5 (35.)
 Trefferlage 0.17 mm links, 0.19 mm hoch
 Streuwert 1.34, horizontal: 1.24, vertikal: 1.43

Unterschrift des Schützen

Meyton Elektronik

Ergebnis: **389** (409.9)
 Serien: 97 99 96 97
 Zähler: 29 11 0 0 0 0 0 0 0 0
 Innenzehner: 28
 weiteste: 406 (1), 380 (38), 333 (24)
 beste Teiler 30.4 (23.) 35.8 (5.) 47.4 (34.)
 Trefferlage 0.16 mm rechts, 0.10 mm tief
 Streuwert 1.45, horizontal: 1.57, vertikal: 1.33

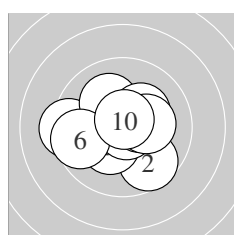
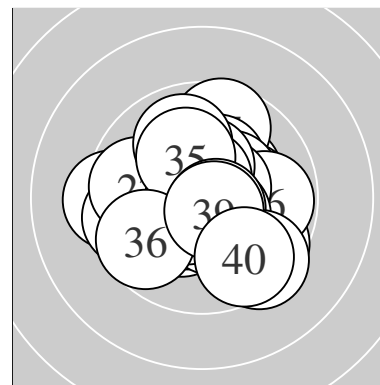

Serie 1:
 9.3 ← 9.7 ↘ 10.3 * 10.1 ↗ 10.8 *
 9.6 ← 10.4 * 10.3 * 10.2 * 10.7 *
 beste Teiler 35.8 (5.) 59.4 (10.) 135.3 (7.)
 Trefferlage 0.23 mm links, 0.10 mm tief
 Streuwert 1.71, horizontal: 2.07, vertikal: 1.25

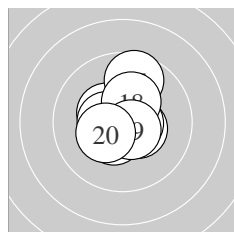

Serie 2:
 10.4 * 10.7 * 10.5 * 10.5 * 10.5 *
 10.6 * 9.6 ↑ 10.3 * 10.6 * 10.3 *
 beste Teiler 65.1 (12.) 84.4 (16.) 86.4 (19.)
 Trefferlage 0.02 mm rechts, 0.20 mm hoch
 Streuwert 1.15, horizontal: 0.99, vertikal: 1.28

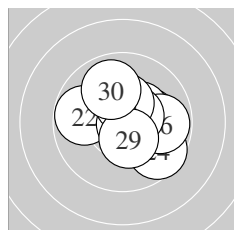

Serie 3:
 10.2 * 9.8 ← 10.8 * 9.6 ↘ 10.4 *
 9.8 → 10.6 * 10.4 * 10.4 * 9.9 ↗
 beste Teiler 30.4 (23.) 99.7 (27.) 131.3 (29.)
 Trefferlage 0.66 mm rechts, 0.24 mm hoch
 Streuwert 1.50, horizontal: 1.70, vertikal: 1.27

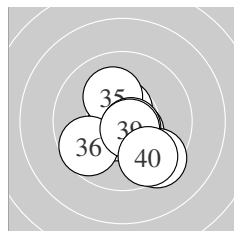

Serie 4:
 10.6 * 10.5 * 10.6 * 10.8 * 10.2 *
 9.7 ↙ 10.6 * 9.4 ↘ 10.6 * 9.6 ↘
 beste Teiler 47.4 (34.) 79.2 (37.) 79.9 (39.)
 Trefferlage 0.22 mm rechts, 0.75 mm tief
 Streuwert 1.45, horizontal: 1.45, vertikal: 1.44

Unterschrift des Schützen

Meyton Elektronik

Ergebnis:	379	(394.7)
Serien:	95 95 93 96	
Zähler:	22 15 3 0 0 0 0 0 0 0	
Innenzehner:	12	
weiteste:	738 (25), 517 (13), 506 (14)	
beste Teiler	28.0 (33.) 75.6 (32.) 89.8 (24.)	
Trefferlage	0.78 mm links, 1.00 mm hoch	
Streuwert	1.99, horizontal: 2.30, vertikal: 1.63	

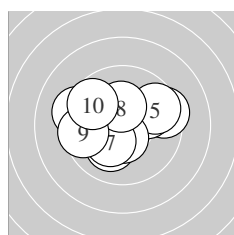
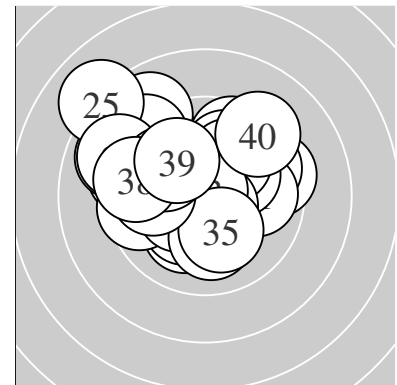

Serie 1:	10.1 ↘	9.3 ←	9.4 →	10.0 →	9.7 ↗
	10.5 *	10.2 *	10.3 *	9.5 ←	9.7 ↘
beste Teiler	111.0 (6.)	163.6 (8.)	176.2 (7.)		
Trefferlage	0.36 mm links, 0.33 mm hoch				
Streuwert	2.10, horizontal: 2.62, vertikal: 1.40				

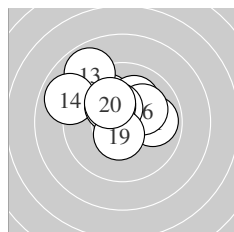

Serie 2:	9.9 →	10.0 ↖	8.9 ↖	8.9 ↖	10.1 ↗
	10.1 ↗	10.4 *	10.2 *	10.5 *	10.1 ↖
beste Teiler	113.6 (19.)	131.6 (17.)	178.8 (18.)		
Trefferlage	0.65 mm links, 1.46 mm hoch				
Streuwert	1.81, horizontal: 2.15, vertikal: 1.39				

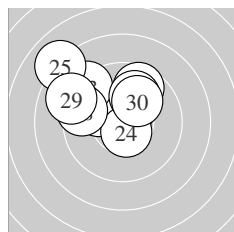

Serie 3:	10.0 ↖	10.5 *	9.2 ↖	10.6 *	8.0 ↖
	9.6 ↗	9.9 ↗	9.5 ←	9.0 ↖	10.1 ↗
beste Teiler	89.8 (24.)	115.4 (22.)	225.5 (30.)		
Trefferlage	1.41 mm links, 1.94 mm hoch				
Streuwert	2.17, horizontal: 2.64, vertikal: 1.57				

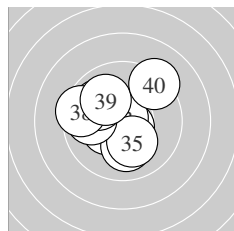

Serie 4:	10.3 *	10.7 *	10.8 *	10.1 ↓	10.2 *
	9.9 ←	9.9 ↖	9.4 ←	10.0 ↖	9.2 ↗
beste Teiler	28.0 (33.)	75.6 (32.)	153.8 (31.)		
Trefferlage	0.68 mm links, 0.26 mm hoch				
Streuwert	1.81, horizontal: 1.94, vertikal: 1.67				

Unterschrift des Schützen

Ergebnis: **380** (401.8)
 Serien: 96 94 94 96
 Zähler: 21 18 1 0 0 0 0 0 0 0
 Innenzehner: 15
 weiteste: 503 (22), 425 (20), 411 (34)
 beste Teiler 36.0 (32.) 67.0 (9.) 70.2 (10.)
 Trefferlage 0.19 mm rechts, 0.08 mm tief
 Streuwert 1.81, horizontal: 2.14, vertikal: 1.42

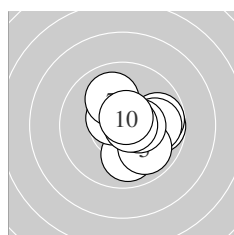
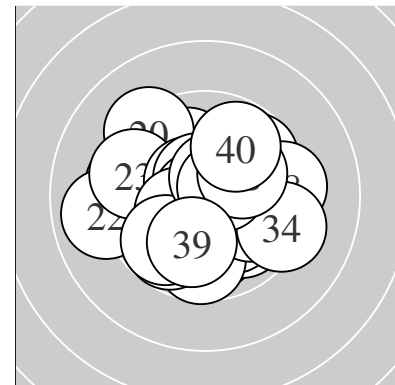

Serie 1:
 9.7 → 9.8 → 9.9 → 10.0 ↓ 9.9 ↘
 10.5 * 10.0 ↖ 10.4 * 10.7 * 10.7 *
 beste Teiler 67.0 (9.) 70.2 (10.) 101.6 (6.)
 Trefferlage 1.14 mm rechts, 0.05 mm tief
 Streuwert 1.37, horizontal: 1.45, vertikal: 1.29

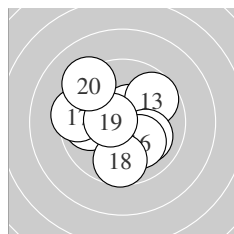

Serie 2:
 9.7 ↖ 10.5 * 9.7 ↗ 9.9 ← 10.0 ↘
 10.1 ↘ 9.4 ← 9.7 ↓ 10.5 * 9.3 ↖
 beste Teiler 102.5 (19.) 104.1 (12.) 213.4 (16.)
 Trefferlage 0.71 mm links, 0.18 mm hoch
 Streuwert 2.05, horizontal: 2.26, vertikal: 1.83

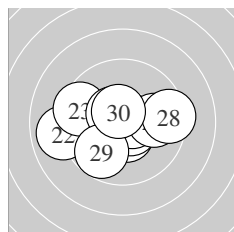

Serie 3:
 10.5 * 8.9 ← 9.5 ↖ 10.6 * 10.6 *
 9.9 → 10.5 * 9.4 → 9.8 ↙ 10.6 *
 beste Teiler 82.0 (25.) 87.3 (24.) 95.6 (30.)
 Trefferlage 0.31 mm links, 0.16 mm tief
 Streuwert 2.02, horizontal: 2.64, vertikal: 1.09

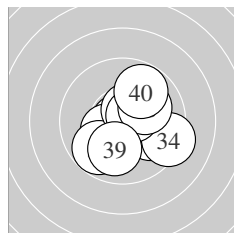

Serie 4:
 9.9 ↘ 10.8 * 10.3 * 9.3 ↘ 9.8 ↙
 10.5 * 10.6 * 10.1 ↗ 10.0 ↓ 9.8 ↗
 beste Teiler 36.0 (32.) 97.1 (37.) 104.2 (36.)
 Trefferlage 0.65 mm rechts, 0.29 mm tief
 Streuwert 1.67, horizontal: 1.78, vertikal: 1.56

Unterschrift des Schützen

Meyton Elektronik

Ergebnis: **377** (395.7)
 Serien: 92 93 97 95
 Zähler: 18 21 1 0 0 0 0 0 0 0
 Innenzehner: 11
 weiteste: 522 (6), 495 (11), 493 (15)
 beste Teiler 43.4 (16.) 80.8 (31.) 98.0 (35.)
 Trefferlage 0.53 mm rechts, 0.03 mm tief
 Streuwert 2.05, horizontal: 2.51, vertikal: 1.45

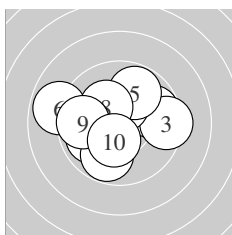
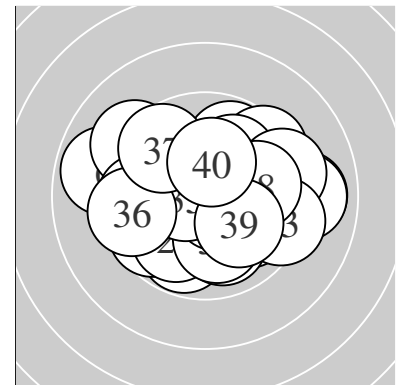

Serie 1:
 9.8 → 9.9 ↖ 9.4 → 10.4 * 9.8 ↗
 8.9 ← 9.8 ↓ 10.2 * 9.7 ← 10.3 *
 beste Teiler 150.7 (4.) 152.4 (10.) 178.3 (8.)
 Trefferlage 0.49 mm links, 0.24 mm hoch
 Streuwert 2.22, horizontal: 2.70, vertikal: 1.60

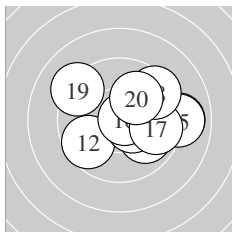

Serie 2:
 9.0 → 9.7 ↖ 9.9 ↘ 10.5 * 9.0 →
 10.8 * 9.7 → 9.5 ↗ 9.2 ↘ 10.0 ↗
 beste Teiler 43.4 (16.) 120.7 (14.) 234.2 (20.)
 Trefferlage 1.47 mm rechts, 0.25 mm hoch
 Streuwert 2.28, horizontal: 2.84, vertikal: 1.53

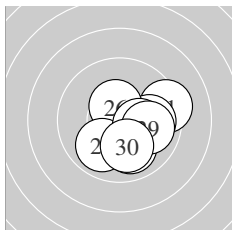

Serie 3:
 9.3 → 10.0 ↓ 10.1 ↓ 10.0 → 9.9 →
 10.5 * 9.9 ↖ 10.3 * 10.0 → 10.1 ↓
 beste Teiler 121.8 (26.) 170.2 (28.) 204.1 (23.)
 Trefferlage 1.29 mm rechts, 0.79 mm tief
 Streuwert 1.44, horizontal: 1.56, vertikal: 1.31

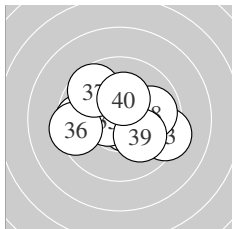

Serie 4:
 10.6 * 9.7 ← 9.3 → 10.5 * 10.6 *
 9.4 ← 9.7 ↘ 9.9 → 10.1 ↘ 10.3 *
 beste Teiler 80.8 (31.) 98.0 (35.) 124.0 (34.)
 Trefferlage 0.13 mm links, 0.17 mm hoch
 Streuwert 1.96, horizontal: 2.46, vertikal: 1.27

Unterschrift des Schützen

Meyton Elektronik

Ergebnis: **384** (402.1)
 Serien: 96 96 95 97
 Zähler: 24 16 0 0 0 0 0 0 0 0
 Innenzehner: 20
 weiteste: 461 (18), 454 (40), 441 (32)
 beste Teiler 16.0 (17.) 37.0 (19.) 44.2 (9.)
 Trefferlage 0.20 mm links, 0.38 mm hoch
 Streuwert 1.81, horizontal: 2.00, vertikal: 1.59

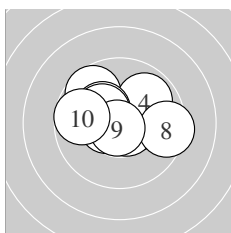
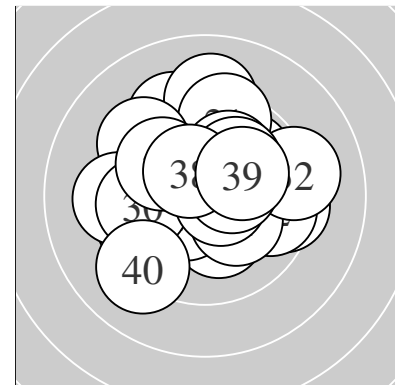

Serie 1:
 10.3 * 10.7 * 9.7 ↘ 9.9 ↗ 10.5 *
 10.3 * 10.3 * 9.4 → 10.8 * 9.7 ←
 beste Teiler 44.2 (9.) 69.6 (2.) 104.7 (5.)
 Trefferlage 0.11 mm links, 0.53 mm hoch
 Streuwert 1.65, horizontal: 2.11, vertikal: 0.99

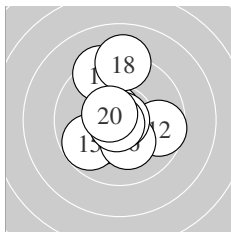

Serie 2:
 10.1 ↙ 9.7 → 10.6 * 9.3 ↖ 9.8 ↗
 10.2 * 10.9 * 9.1 ↑ 10.8 * 10.6 *
 beste Teiler 16.0 (17.) 37.0 (19.) 85.7 (13.)
 Trefferlage 0.27 mm links, 0.37 mm hoch
 Streuwert 1.88, horizontal: 1.53, vertikal: 2.18

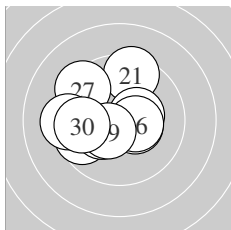

Serie 3:
 9.4 ↑ 9.6 ← 10.4 * 10.4 * 10.3 *
 10.4 * 9.4 ↘ 9.3 ← 10.4 * 9.7 ←
 beste Teiler 127.3 (29.) 131.4 (26.) 133.5 (24.)
 Trefferlage 1.06 mm links, 0.21 mm hoch
 Streuwert 1.90, horizontal: 2.15, vertikal: 1.60

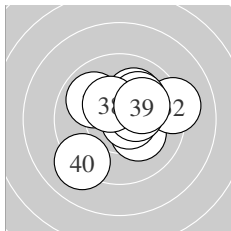

Serie 4:
 10.2 * 9.2 → 9.9 ↘ 10.1 ↗ 10.1 ↗
 10.6 * 10.4 * 10.4 * 10.1 → 9.1 ↙
 beste Teiler 77.6 (36.) 137.5 (37.) 140.1 (38.)
 Trefferlage 0.64 mm rechts, 0.40 mm hoch
 Streuwert 1.87, horizontal: 2.09, vertikal: 1.62

Unterschrift des Schützen

Meyton Elektronik

Ergebnis:	367	(386.6)
Serien:	91 91 91 94	
Zähler:	13 22 4 1 0 0 0 0 0 0	
Innenzehner:	10	
weiteste:	772 (15), 689 (14), 575 (22)	
beste Teiler	52.4 (12.) 75.8 (36.) 79.3 (16.)	
Trefferlage	0.87 mm links, 0.58 mm hoch	
Streuwert	2.49, horizontal: 3.10, vertikal: 1.66	

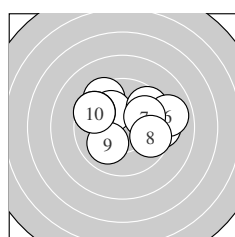
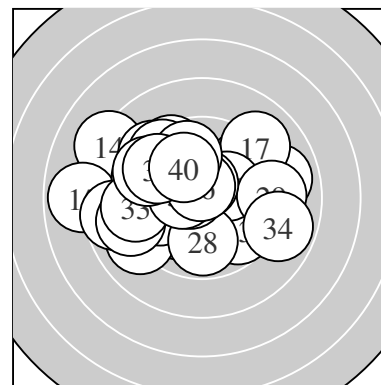

Serie 1:	9.3 →	9.5 ↘	10.1 ↘	9.6 ↘	9.6 ↗
	8.9 →	9.9 ↗	9.7 →	10.0 ↗	9.6 ↘
beste Teiler	210.4 (3.)	234.9 (9.)	262.9 (7.)		
Trefferlage	0.60 mm rechts, 0.97 mm hoch				
Streuwert	2.40, horizontal: 3.07, vertikal: 1.47				

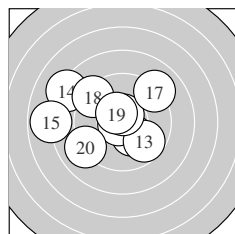

Serie 2:	10.3 *	10.7 *	9.7 ↘	8.2 ↘	7.9 ←
	10.6 *	9.0 ↗	9.3 ↘	10.5 *	9.0 ↗
beste Teiler	52.4 (12.)	79.3 (16.)	117.3 (19.)		
Trefferlage	1.51 mm links, 0.48 mm hoch				
Streuwert	2.99, horizontal: 3.62, vertikal: 2.18				

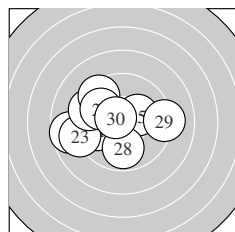

Serie 3:	9.8 ←	8.7 ←	9.0 ←	9.4 ↘	10.2 *
	9.4 ↘	9.9 ↘	9.8 ↓	9.2 →	10.6 *
beste Teiler	88.5 (30.)	177.6 (25.)	273.1 (27.)		
Trefferlage	1.60 mm links, 0.07 mm hoch				
Streuwert	2.44, horizontal: 3.04, vertikal: 1.64				

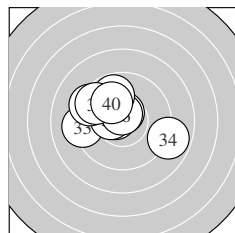

Serie 4:	10.6 *	10.6 *	9.2 ←	8.9 →	10.4 *
	10.7 *	9.8 ↘	9.4 ↘	9.6 ↘	10.0 ↘
beste Teiler	75.8 (36.)	80.0 (32.)	90.4 (31.)		
Trefferlage	0.99 mm links, 0.80 mm hoch				
Streuwert	2.04, horizontal: 2.54, vertikal: 1.36				

Unterschrift des Schützen

Meyton Elektronik

Ergebnis: **378** (397.3)
 Serien: 95 95 93 95
 Zähler: 22 15 2 1 0 0 0 0 0 0
 Innenzehner: 16
 weiteste: 796 (25), 604 (4), 508 (19)
 beste Teiler 13.0 (28.) 34.9 (6.) 49.6 (23.)
 Trefferlage 0.14 mm links, 0.68 mm hoch
 Streuwert 2.13, horizontal: 2.53, vertikal: 1.64

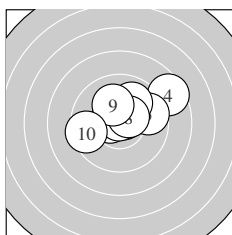
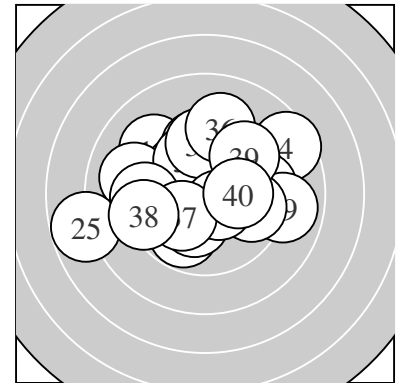

Serie 1:
 10.7 * 10.5 * 10.5 * 8.5 ↗ 9.7 →
 10.8 * 9.9 ↗ 10.5 * 10.1 ↑ 9.5 ←
 beste Teiler 34.9 (6.) 66.4 (1.) 102.4 (3.)
 Trefferlage 0.52 mm rechts, 0.99 mm hoch
 Streuwert 1.88, horizontal: 2.39, vertikal: 1.15

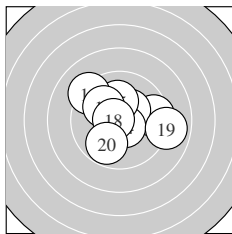

Serie 2:
 9.5 → 10.5 * 10.3 * 10.6 * 10.1 ↑
 9.2 ↘ 10.1 ↘ 10.7 * 8.9 → 9.8 ↘
 beste Teiler 66.3 (18.) 90.4 (14.) 101.5 (12.)
 Trefferlage 0.39 mm rechts, 0.43 mm hoch
 Streuwert 2.07, horizontal: 2.48, vertikal: 1.55

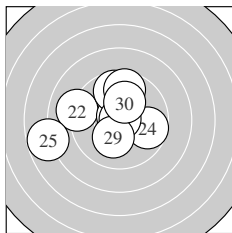

Serie 3:
 10.7 * 9.1 ← 10.8 * 9.7 → 7.8 ←
 9.7 ↑ 9.6 ↑ 10.9 * 10.2 * 10.2 *
 beste Teiler 13.0 (28.) 49.6 (23.) 64.0 (21.)
 Trefferlage 0.92 mm links, 0.46 mm hoch
 Streuwert 2.51, horizontal: 3.02, vertikal: 1.89

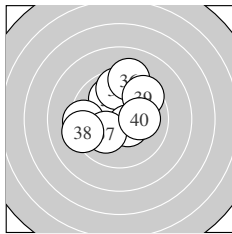

Serie 4:
 10.4 * 10.0 ↘ 9.6 ↑ 10.5 * 9.4 ←
 9.2 ↑ 10.1 ↙ 9.3 ← 9.6 ↗ 10.1 →
 beste Teiler 114.4 (34.) 140.0 (31.) 204.4 (37.)
 Trefferlage 0.55 mm links, 0.86 mm hoch
 Streuwert 2.14, horizontal: 2.26, vertikal: 2.01

Unterschrift des Schützen

Meyton Elektronik

Ergebnis: **390** (407.9)
 Serien: 96 97 99 98
 Zähler: 30 10 0 0 0 0 0 0 0 0
 Innenzehner: 23
 weiteste: 377 (10), 303 (39), 286 (14)
 beste Teiler 31.2 (36.) 59.5 (22.) 103.8 (20.)
 Trefferlage 0.19 mm links, 0.59 mm hoch
 Streuwert 1.36, horizontal: 1.46, vertikal: 1.24

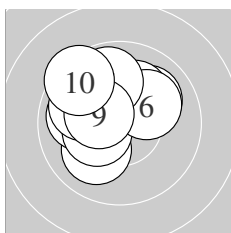
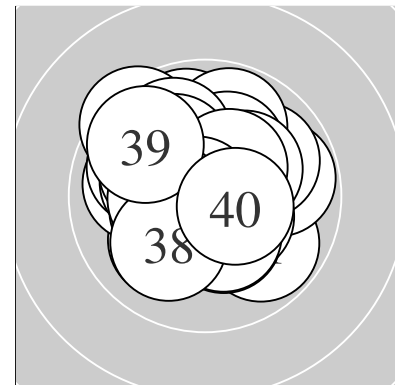

Serie 1:
 10.1 ↙ 9.9 ← 10.3 * 10.0 ↗ 10.1 ↗
 10.1 ↗ 9.9 ↑ 9.9 ↖ 10.4 * 9.4 ↘
 beste Teiler 145.4 (9.) 153.1 (3.) 203.1 (5.)
 Trefferlage 0.78 mm links, 0.98 mm hoch
 Streuwert 1.53, horizontal: 1.68, vertikal: 1.36

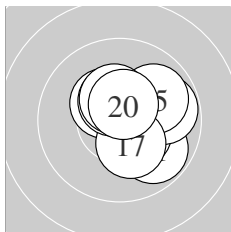

Serie 2:
 9.8 ↘ 10.4 * 10.4 * 9.8 → 9.9 ↗
 10.4 * 10.3 * 10.4 * 10.4 * 10.5 *
 beste Teiler 103.8 (20.) 129.3 (18.) 135.4 (13.)
 Trefferlage 0.66 mm rechts, 0.36 mm hoch
 Streuwert 1.30, horizontal: 1.35, vertikal: 1.24

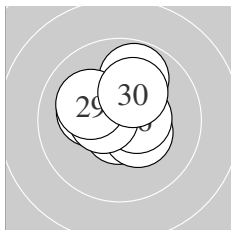

Serie 3:
 10.4 * 10.7 * 10.2 * 10.4 * 10.5 *
 10.5 * 10.5 * 9.8 ↑ 10.1 ↖ 10.2 *
 beste Teiler 59.5 (22.) 104.5 (27.) 111.5 (26.)
 Trefferlage 0.30 mm links, 0.58 mm hoch
 Streuwert 1.14, horizontal: 1.23, vertikal: 1.04

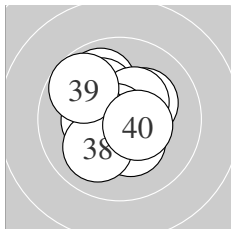

Serie 4:
 10.2 * 9.9 ↘ 10.1 ↘ 10.4 * 10.3 *
 10.8 * 10.3 * 10.0 ↙ 9.7 ↘ 10.5 *
 beste Teiler 31.2 (36.) 122.7 (40.) 144.0 (34.)
 Trefferlage 0.36 mm links, 0.44 mm hoch
 Streuwert 1.37, horizontal: 1.34, vertikal: 1.41

Unterschrift des Schützen

Ergebnis: **400** (420.0)
 Serien: 100 100 100 100
 Zähler: 40 0 0 0 0 0 0 0 0 0
 Innenzehner: 37
 weiteste: 246 (39), 239 (8), 208 (27)
 beste Teiler 36.0 (36.) 40.3 (22.) 40.4 (2.)
 Trefferlage 0.01 mm rechts, 0.03 mm hoch
 Streuwert 0.91, horizontal: 0.82, vertikal: 0.99

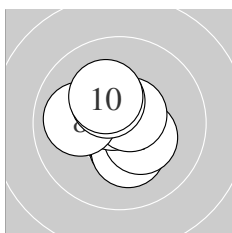
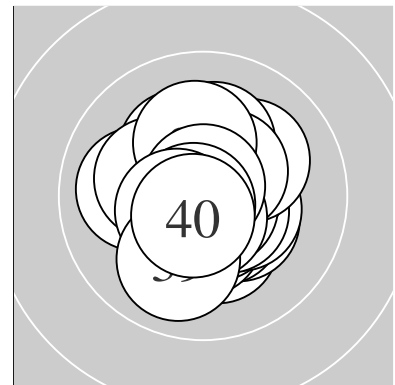

Serie 1:
 10.4 * 10.8 * 10.3 * 10.3 * 10.6 *
 10.7 * 10.6 * 10.0 ← 10.3 * 10.2 *
 beste Teiler 40.4 (2.) 72.6 (6.) 80.9 (7.)
 Trefferlage 0.22 mm links, 0.10 mm hoch
 Streuwert 1.05, horizontal: 1.01, vertikal: 1.09

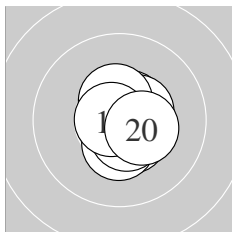

Serie 2:
 10.5 * 10.4 * 10.6 * 10.7 * 10.7 *
 10.5 * 10.6 * 10.5 * 10.8 * 10.4 *
 beste Teiler 50.1 (19.) 53.8 (15.) 69.8 (14.)
 Trefferlage 0.41 mm rechts, 0.13 mm tief
 Streuwert 0.71, horizontal: 0.57, vertikal: 0.83

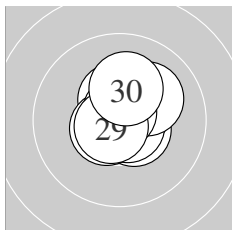

Serie 3:
 10.5 * 10.8 * 10.6 * 10.4 * 10.6 *
 10.7 * 10.1 ↗ 10.8 * 10.7 * 10.2 *
 beste Teiler 40.3 (22.) 48.0 (28.) 59.0 (26.)
 Trefferlage 0.30 mm rechts, 0.34 mm hoch
 Streuwert 0.81, horizontal: 0.73, vertikal: 0.88

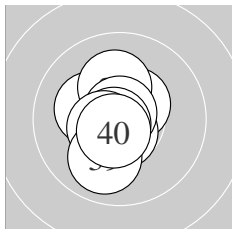

Serie 4:
 10.5 * 10.2 * 10.5 * 10.2 * 10.6 *
 10.8 * 10.8 * 10.5 * 10.0 ↓ 10.6 *
 beste Teiler 36.0 (36.) 47.4 (37.) 78.4 (35.)
 Trefferlage 0.42 mm links, 0.17 mm tief
 Streuwert 0.96, horizontal: 0.69, vertikal: 1.17

Unterschrift des Schützen

Meyton Elektronik

Ergebnis: **395** (411.9)
 Serien: 99 99 99 98
 Zähler: 35 5 0 0 0 0 0 0 0 0
 Innenzehner: 26
 weiteste: 381 (24), 323 (33), 316 (5)
 beste Teiler 2.0 (28.) 5.8 (15.) 35.6 (3.)
 Trefferlage 0.10 mm rechts, 0.29 mm hoch
 Streuwert 1.31, horizontal: 1.50, vertikal: 1.08

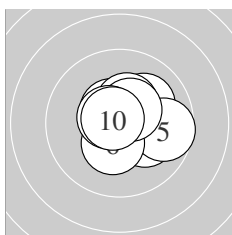
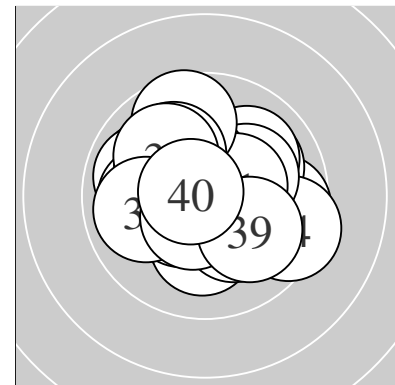

Serie 1:
 10.2 * 10.1 ↗ 10.8 * 10.5 * 9.7 →
 10.4 * 10.4 * 10.5 * 10.6 * 10.7 *
 beste Teiler 35.6 (3.) 59.9 (10.) 89.4 (9.)
 Trefferlage 0.54 mm rechts, 0.21 mm hoch
 Streuwert 1.14, horizontal: 1.30, vertikal: 0.95

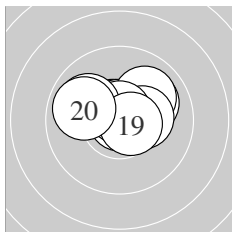

Serie 2:
 10.0 ↗ 10.6 * 10.7 * 10.0 ↗ 10.9 *
 10.3 * 10.7 * 10.0 ↖ 10.6 * 9.9 ↖
 beste Teiler 5.8 (15.) 54.0 (17.) 65.2 (13.)
 Trefferlage 0.09 mm rechts, 0.65 mm hoch
 Streuwert 1.17, horizontal: 1.55, vertikal: 0.56

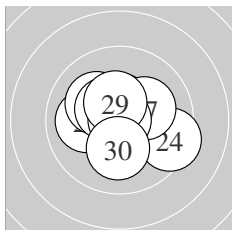

Serie 3:
 10.0 ← 10.2 * 10.1 ↖ 9.4 ↘ 10.5 *
 10.5 * 10.2 * 10.9 * 10.4 * 10.2 *
 beste Teiler 2.0 (28.) 106.4 (26.) 124.1 (25.)
 Trefferlage 0.19 mm rechts, 0.11 mm hoch
 Streuwert 1.48, horizontal: 1.76, vertikal: 1.13

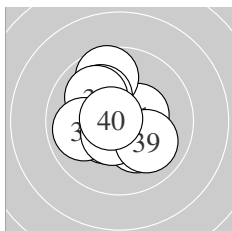

Serie 4:
 10.4 * 10.2 * 9.7 ↑ 10.1 ↖ 10.0 ↖
 10.4 * 9.9 ← 10.5 * 10.0 ↘ 10.7 *
 beste Teiler 63.6 (40.) 103.9 (38.) 127.4 (36.)
 Trefferlage 0.41 mm links, 0.20 mm hoch
 Streuwert 1.48, horizontal: 1.43, vertikal: 1.54

Unterschrift des Schützen

Ergebnis: **394** (414.4)
 Serien: 100 98 97 99
 Zähler: 34 6 0 0 0 0 0 0 0 0
 Innenzehner: 29
 weiteste: 497 (29), 260 (37), 259 (19)
 beste Teiler 33.2 (23.) 41.0 (12.) 43.1 (3.)
 Trefferlage 0.02 mm links, 0.04 mm hoch
 Streuwert 1.25, horizontal: 1.42, vertikal: 1.04

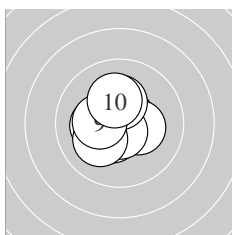
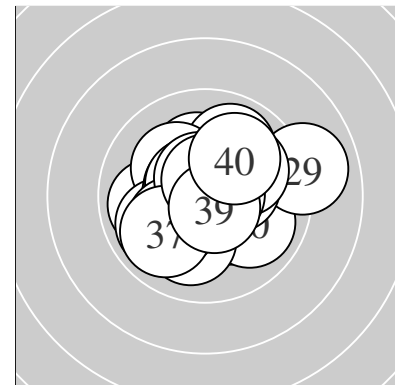

Serie 1:
 10.7 * 10.5 * 10.8 * 10.3 * 10.2 *
 10.7 * 10.3 * 10.1 ↙ 10.3 * 10.2 *
 beste Teiler 43.1 (3.) 70.1 (6.) 75.2 (1.)
 Trefferlage 0.34 mm links, 0.06 mm hoch
 Streuwert 1.07, horizontal: 1.09, vertikal: 1.05

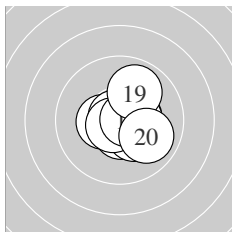

Serie 2:
 10.4 * 10.8 * 10.6 * 10.3 * 10.5 *
 10.5 * 10.7 * 10.7 * 9.9 ↗ 9.9 ↘
 beste Teiler 41.0 (12.) 63.3 (18.) 67.8 (17.)
 Trefferlage 0.55 mm rechts, 0.10 mm tief
 Streuwert 1.04, horizontal: 1.06, vertikal: 1.01

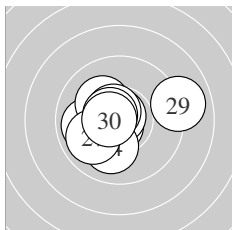

Serie 3:
 10.7 * 9.9 ← 10.8 * 10.1 ↓ 10.2 *
 10.6 * 9.9 ↙ 10.6 * 9.0 → 10.6 *
 beste Teiler 33.2 (23.) 56.0 (21.) 85.2 (30.)
 Trefferlage 0.45 mm links, 0.01 mm tief
 Streuwert 1.62, horizontal: 2.00, vertikal: 1.12

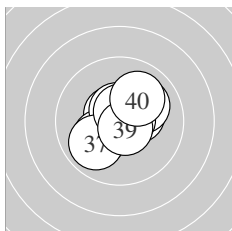

Serie 4:
 10.6 * 10.3 * 10.1 ↙ 10.1 ↗ 10.6 *
 10.7 * 9.9 ↙ 10.6 * 10.7 * 10.0 ↗
 beste Teiler 69.4 (36.) 72.4 (39.) 79.6 (38.)
 Trefferlage 0.15 mm rechts, 0.22 mm hoch
 Streuwert 1.21, horizontal: 1.29, vertikal: 1.13

Unterschrift des Schützen

Meyton Elektronik

Ergebnis: **392** (407.6)
 Serien: 99 98 96 99
 Zähler: 33 6 1 0 0 0 0 0 0 0
 Innenzehner: 21
 weiteste: 542 (30), 294 (3), 289 (20)
 beste Teiler 33.0 (8.) 50.7 (11.) 51.7 (2.)
 Trefferlage 0.27 mm rechts, 0.46 mm hoch
 Streuwert 1.46, horizontal: 1.55, vertikal: 1.36

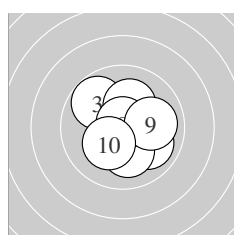
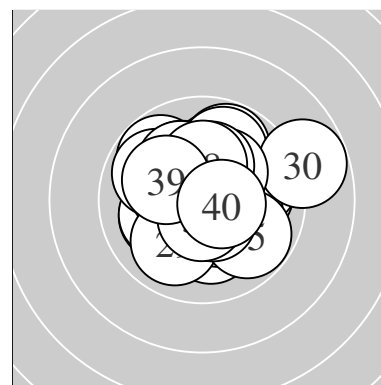

Serie 1:
 10.7 * 10.7 * 9.8 ↖ 10.2 * 10.2 *
 10.0 ↘ 10.1 ↓ 10.8 * 10.0 → 10.2 *
 beste Teiler 33.0 (8.) 51.7 (2.) 70.2 (1.)
 Trefferlage 0.36 mm rechts, 0.22 mm tief
 Streuwert 1.38, horizontal: 1.37, vertikal: 1.38

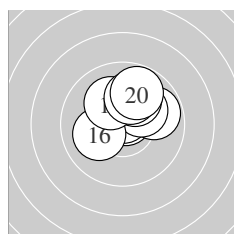

Serie 2:
 10.8 * 10.3 * 9.8 → 10.7 * 10.2 *
 10.1 ← 10.0 ↗ 10.1 ↘ 10.0 ↗ 9.8 ↗
 beste Teiler 50.7 (11.) 63.5 (14.) 160.3 (12.)
 Trefferlage 0.51 mm rechts, 1.24 mm hoch
 Streuwert 1.17, horizontal: 1.31, vertikal: 1.02

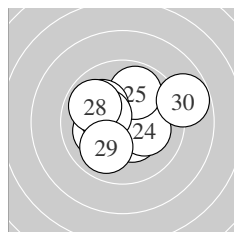

Serie 3:
 10.1 ← 10.4 * 10.7 * 10.2 * 9.9 ↗
 10.1 ↘ 10.3 * 9.9 ↖ 10.0 ↙ 8.8 →
 beste Teiler 73.3 (23.) 141.2 (22.) 157.3 (27.)
 Trefferlage 0.07 mm links, 0.33 mm hoch
 Streuwert 1.93, horizontal: 2.31, vertikal: 1.46

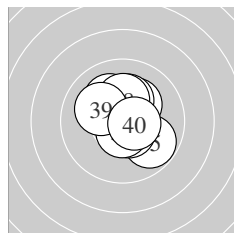

Serie 4:
 10.2 * 10.5 * 10.1 ↘ 10.2 * 9.8 ↘
 10.5 * 10.6 * 10.2 * 10.1 ↘ 10.5 *
 beste Teiler 86.0 (37.) 101.2 (40.) 102.3 (36.)
 Trefferlage 0.27 mm rechts, 0.50 mm hoch
 Streuwert 1.23, horizontal: 1.14, vertikal: 1.30

Unterschrift des Schützen

Meyton Elektronik

Ergebnis: **382** (401.7)
 Serien: 95 97 93 97
 Zähler: 23 16 1 0 0 0 0 0 0 0
 Innenzehner: 17
 weiteste: 519 (35), 402 (15), 364 (30)
 beste Teiler 38.3 (8.) 73.2 (24.) 79.0 (11.)
 Trefferlage 0.00 mm , 0.00 mm
 Streuwert 1.80, horizontal: 1.87, vertikal: 1.73

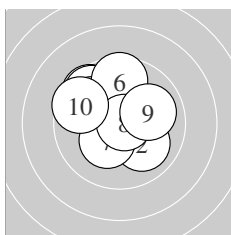
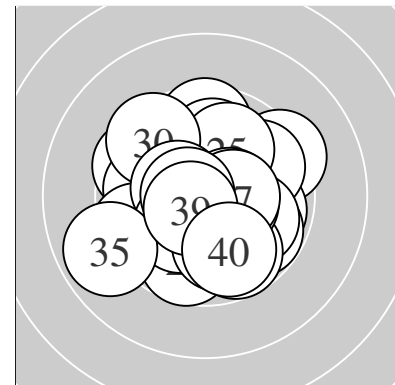

Serie 1:
 9.6 ↘ 10.0 ↘ 9.7 ↘ 10.6 * 9.9 ↘
 9.6 ↑ 10.3 * 10.8 * 10.0 → 9.6 ↘
 beste Teiler 38.3 (8.) 88.9 (4.) 166.8 (7.)
 Trefferlage 0.68 mm links, 0.98 mm hoch
 Streuwert 1.72, horizontal: 1.83, vertikal: 1.60

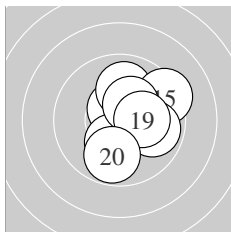

Serie 2:
 10.6 * 10.3 * 10.6 * 10.0 ↑ 9.3 →
 10.2 * 9.9 → 10.3 * 10.2 * 9.8 ↓
 beste Teiler 79.0 (11.) 96.2 (13.) 152.6 (18.)
 Trefferlage 0.90 mm rechts, 0.33 mm hoch
 Streuwert 1.51, horizontal: 1.38, vertikal: 1.63

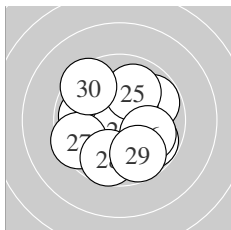

Serie 3:
 9.8 → 9.9 ← 9.8 ↘ 10.7 * 10.0 ↗
 10.0 ↘ 9.5 ← 9.7 ↓ 9.7 ↓ 9.5 ↘
 beste Teiler 73.2 (24.) 245.1 (25.) 250.4 (26.)
 Trefferlage 0.04 mm rechts, 0.41 mm tief
 Streuwert 2.11, horizontal: 2.24, vertikal: 1.99

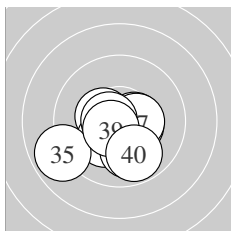

Serie 4:
 10.4 * 10.2 * 10.5 * 10.4 * 8.9 ←
 10.0 ↓ 10.4 * 10.6 * 10.6 * 9.8 ↓
 beste Teiler 84.2 (38.) 91.4 (39.) 115.1 (33.)
 Trefferlage 0.29 mm links, 0.93 mm tief
 Streuwert 1.54, horizontal: 1.84, vertikal: 1.17

Unterschrift des Schützen

Meyton Elektronik

Ergebnis: **390** (406.3)
 Serien: 96 98 97 99
 Zähler: 30 10 0 0 0 0 0 0 0 0
 Innenzehner: 22
 weiteste: 482 (28), 446 (8), 379 (9)
 beste Teiler 67.1 (10.) 70.0 (23.) 79.2 (29.)
 Trefferlage 0.59 mm links, 0.02 mm hoch
 Streuwert 1.55, horizontal: 1.82, vertikal: 1.22

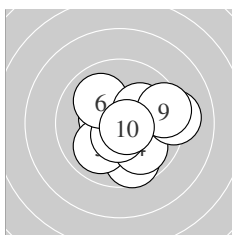
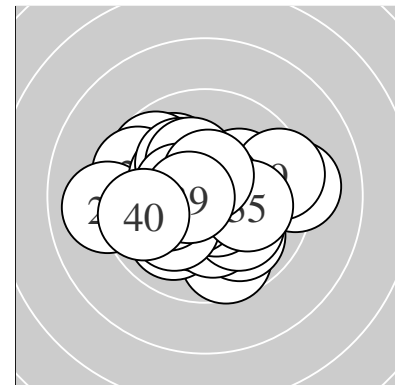

Serie 1:
 9.7 ↘ 10.5 * 10.0 ↙ 9.9 ↘ 10.6 *
 10.0 ↖ 10.2 * 9.2 → 9.4 → 10.7 *
 beste Teiler 67.1 (10.) 96.8 (5.) 116.6 (2.)
 Trefferlage 0.87 mm rechts, 0.33 mm tief
 Streuwert 1.84, horizontal: 2.07, vertikal: 1.58

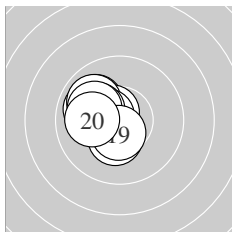

Serie 2:
 10.0 ↖ 9.9 ↖ 10.6 * 10.3 * 9.9 ↖
 10.5 * 10.2 * 10.1 ↖ 10.5 * 10.1 ←
 beste Teiler 89.8 (13.) 104.4 (19.) 109.1 (16.)
 Trefferlage 1.46 mm links, 0.41 mm hoch
 Streuwert 0.92, horizontal: 0.85, vertikal: 0.99

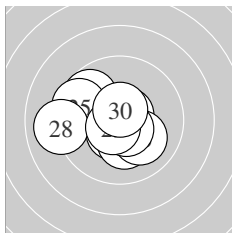

Serie 3:
 10.5 * 9.7 ↖ 10.7 * 10.2 * 9.6 ↖
 10.1 ↘ 10.6 * 9.0 ← 10.6 * 10.6 *
 beste Teiler 70.0 (23.) 79.2 (29.) 85.1 (30.)
 Trefferlage 0.83 mm links, 0.17 mm tief
 Streuwert 1.66, horizontal: 2.02, vertikal: 1.20

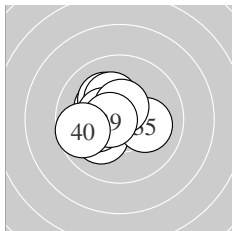

Serie 4:
 10.1 ↙ 10.3 * 10.2 * 10.2 * 10.1 →
 10.3 * 10.4 * 10.5 * 10.6 * 9.7 ←
 beste Teiler 79.3 (39.) 102.1 (38.) 130.2 (37.)
 Trefferlage 0.96 mm links, 0.21 mm hoch
 Streuwert 1.21, horizontal: 1.35, vertikal: 1.05

Unterschrift des Schützen

Ergebnis: **386** (403.1)
 Serien: 95 97 96 98
 Zähler: 26 14 0 0 0 0 0 0 0 0
 Innenzehner: 17
 weiteste: 483 (1), 466 (27), 404 (5)
 beste Teiler 28.6 (37.) 35.9 (17.) 46.2 (9.)
 Trefferlage 0.04 mm rechts, 0.16 mm hoch
 Streuwert 1.74, horizontal: 1.95, vertikal: 1.51

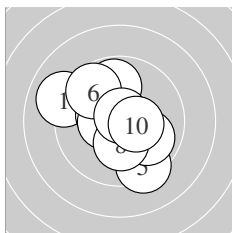
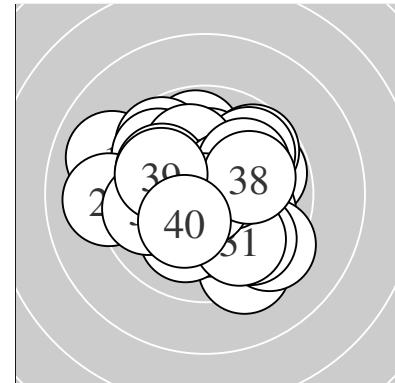

Serie 1:
 9.0 ↖ 9.8 ↑ 10.4 * 10.5 * 9.3 ↘
 9.7 ↖ 9.9 ↘ 10.2 * 10.8 * 10.4 *
 beste Teiler 46.2 (9.) 116.1 (4.) 135.1 (10.)
 Trefferlage 0.37 mm links, 0.09 mm hoch
 Streuwert 1.99, horizontal: 2.02, vertikal: 1.96

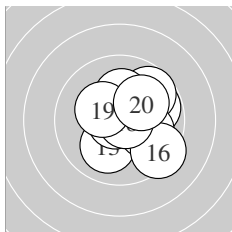

Serie 2:
 9.8 ↗ 9.7 ↗ 10.1 ↘ 10.0 ↘ 10.2 *
 9.4 ↘ 10.8 * 10.8 * 10.3 * 10.1 ↗
 beste Teiler 35.9 (17.) 50.2 (18.) 161.7 (19.)
 Trefferlage 1.00 mm rechts, 0.18 mm hoch
 Streuwert 1.59, horizontal: 1.60, vertikal: 1.57

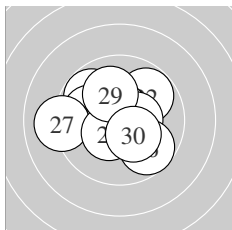

Serie 3:
 9.8 ↖ 9.8 ↗ 10.6 * 10.5 * 10.0 ↖
 9.7 ↘ 9.1 ← 10.4 * 10.1 ↑ 10.3 *
 beste Teiler 77.3 (23.) 125.0 (24.) 132.7 (28.)
 Trefferlage 0.41 mm links, 0.27 mm hoch
 Streuwert 1.87, horizontal: 2.21, vertikal: 1.46

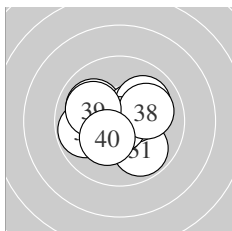

Serie 4:
 9.8 ↘ 10.5 * 10.0 ↖ 10.4 * 10.0 ↗
 9.8 ← 10.8 * 10.0 → 10.0 ↖ 10.3 *
 beste Teiler 28.6 (37.) 124.8 (32.) 126.0 (34.)
 Trefferlage 0.01 mm links, 0.10 mm hoch
 Streuwert 1.55, horizontal: 1.84, vertikal: 1.19

Unterschrift des Schützen

Meyton Elektronik

Ergebnis: **393** (412.4)
 Serien: 96 100 98 99
 Zähler: 33 7 0 0 0 0 0 0 0 0
 Innenzehner: 28
 weiteste: 309 (4), 308 (29), 299 (3)
 beste Teiler 10.0 (34.) 25.4 (22.) 38.0 (8.)
 Trefferlage 0.18 mm rechts, 0.13 mm hoch
 Streuwert 1.28, horizontal: 1.27, vertikal: 1.29

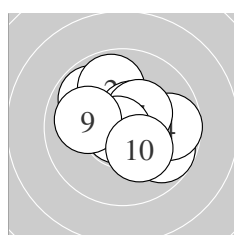
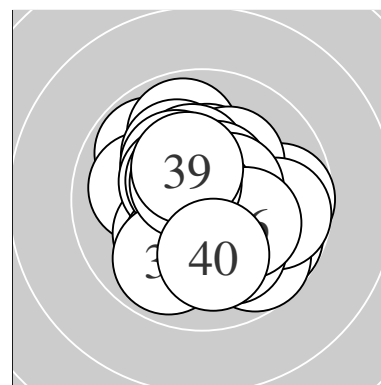

Serie 1:
 9.8 ↘ 9.9 ↗ 9.8 ↘ 9.7 → 10.7 *
 10.5 * 10.4 * 10.8 * 10.0 ← 10.2 *
 beste Teiler 38.0 (8.) 51.8 (5.) 102.0 (6.)
 Trefferlage 0.34 mm rechts, 0.39 mm hoch
 Streuwert 1.55, horizontal: 1.78, vertikal: 1.29

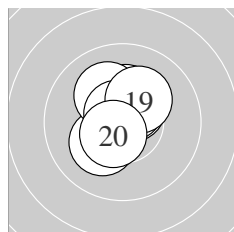

Serie 2:
 10.2 * 10.4 * 10.5 * 10.5 * 10.3 *
 10.5 * 10.1 ↘ 10.7 * 10.2 * 10.5 *
 beste Teiler 66.0 (18.) 101.0 (20.) 106.9 (13.)
 Trefferlage 0.10 mm links, 0.75 mm hoch
 Streuwert 0.91, horizontal: 0.76, vertikal: 1.03

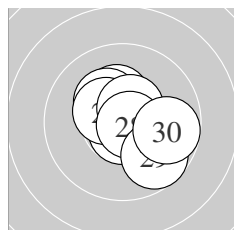

Serie 3:
 10.3 * 10.9 * 10.2 * 10.7 * 10.3 *
 10.4 * 10.5 * 10.7 * 9.7 ↘ 9.8 →
 beste Teiler 25.4 (22.) 52.5 (28.) 58.2 (24.)
 Trefferlage 0.49 mm rechts, 0.00 mm
 Streuwert 1.26, horizontal: 1.35, vertikal: 1.17

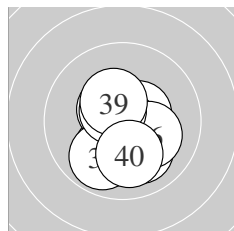

Serie 4:
 10.1 ↙ 10.5 * 10.5 * 10.9 * 10.0 ↘
 10.2 * 9.9 ↙ 10.6 * 10.4 * 10.1 ↓
 beste Teiler 10.0 (34.) 95.4 (38.) 113.3 (33.)
 Trefferlage 0.00 mm , 0.61 mm tief
 Streuwert 1.24, horizontal: 1.05, vertikal: 1.40

Unterschrift des Schützen

Meyton Elektronik

Ergebnis: **389** (406.9)
 Serien: 98 99 97 95
 Zähler: 30 9 1 0 0 0 0 0 0 0
 Innenzehner: 23
 weiteste: 528 (38), 469 (34), 445 (3)
 beste Teiler 11.0 (16.) 14.4 (1.) 25.0 (23.)
 Trefferlage 0.18 mm rechts, 0.03 mm tief
 Streuwert 1.65, horizontal: 1.95, vertikal: 1.27

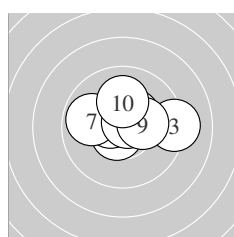
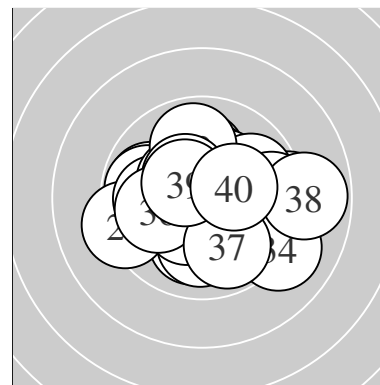

Serie 1:
 10.9 * 10.4 * 9.2 → 10.6 * 10.6 *
 10.5 * 9.9 ← 10.7 * 10.2 * 10.1 ↑
 beste Teiler 14.4 (1.) 59.3 (8.) 78.2 (5.)
 Trefferlage 0.32 mm rechts, 0.56 mm hoch
 Streuwert 1.42, horizontal: 1.86, vertikal: 0.74

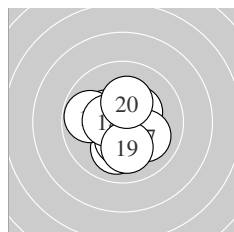

Serie 2:
 10.0 ↓ 10.4 * 10.4 * 9.8 ← 10.4 *
 10.9 * 10.1 ↘ 10.5 * 10.1 ↓ 10.3 *
 beste Teiler 11.0 (16.) 124.6 (18.) 146.3 (12.)
 Trefferlage 0.23 mm links, 0.33 mm tief
 Streuwert 1.35, horizontal: 1.35, vertikal: 1.35

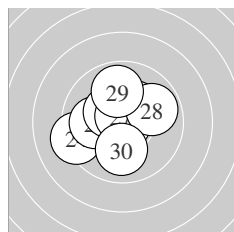

Serie 3:
 10.5 * 10.3 * 10.9 * 9.3 ← 10.0 ←
 10.4 * 10.7 * 9.9 → 9.9 ↑ 10.0 ↓
 beste Teiler 25.0 (23.) 55.0 (27.) 122.3 (21.)
 Trefferlage 0.55 mm links, 0.20 mm hoch
 Streuwert 1.61, horizontal: 1.78, vertikal: 1.43

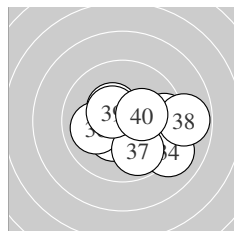

Serie 4:
 9.5 → 10.4 * 10.2 * 9.1 ↘ 10.4 *
 10.0 ← 9.8 ↘ 8.8 → 10.5 * 10.3 *
 beste Teiler 118.3 (39.) 137.1 (32.) 144.2 (35.)
 Trefferlage 1.20 mm rechts, 0.55 mm tief
 Streuwert 1.97, horizontal: 2.46, vertikal: 1.30

Unterschrift des Schützen

Meyton Elektronik

Ergebnis: **389** (404.7)
 Serien: 98 97 97 97
 Zähler: 30 9 1 0 0 0 0 0 0 0
 Innenzehner: 21
 weiteste: 568 (36), 443 (11), 417 (23)
 beste Teiler 9.4 (37.) 19.9 (8.) 80.6 (40.)
 Trefferlage 1.12 mm links, 0.19 mm tief
 Streuwert 1.51, horizontal: 1.51, vertikal: 1.50

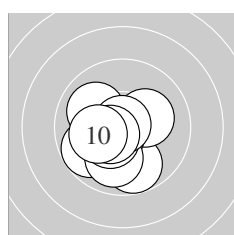
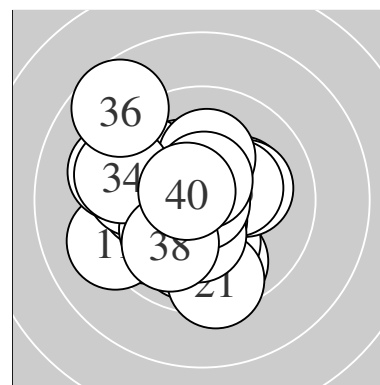

Serie 1:
 10.0 ↘ 9.8 ↓ 10.2 * 10.6 * 9.8 ↙
 10.0 ↓ 10.4 * 10.9 * 10.5 * 10.2 *
 beste Teiler 19.9 (8.) 90.4 (4.) 109.4 (9.)
 Trefferlage 0.70 mm links, 0.74 mm tief
 Streuwert 1.29, horizontal: 1.30, vertikal: 1.28

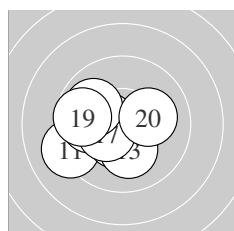

Serie 2:
 9.2 ↙ 10.4 * 10.2 * 10.1 ← 10.5 *
 10.0 ← 10.4 * 9.9 ↘ 9.7 ← 10.1 →
 beste Teiler 118.0 (15.) 128.1 (12.) 139.0 (17.)
 Trefferlage 1.44 mm links, 0.29 mm tief
 Streuwert 1.46, horizontal: 1.76, vertikal: 1.08

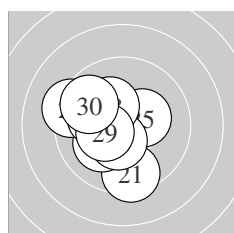

Serie 3:
 9.5 ↓ 10.1 ↙ 9.3 ↘ 10.0 ↘ 10.3 *
 10.5 * 10.1 ← 10.3 * 10.4 * 9.7 ↘
 beste Teiler 125.9 (26.) 146.3 (29.) 160.7 (25.)
 Trefferlage 1.28 mm links, 0.03 mm tief
 Streuwert 1.63, horizontal: 1.59, vertikal: 1.67

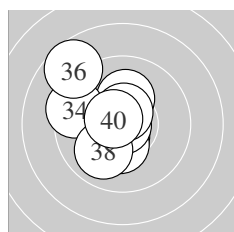

Serie 4:
 10.6 * 10.3 * 10.2 * 9.4 ↘ 10.3 *
 8.7 ↘ 10.9 * 10.0 ↙ 10.6 * 10.6 *
 beste Teiler 9.4 (37.) 80.6 (40.) 91.4 (31.)
 Trefferlage 1.08 mm links, 0.30 mm hoch
 Streuwert 1.70, horizontal: 1.50, vertikal: 1.87

Unterschrift des Schützen

Meyton Elektronik

Ergebnis: **377** (396.7)
 Serien: 93 95 94 95
 Zähler: 19 20 0 1 0 0 0 0 0 0
 Innenzehner: 17
 weiteste: 838 (26), 432 (14), 407 (17)
 beste Teiler 48.8 (22.) 81.3 (23.) 90.5 (10.)
 Trefferlage 0.48 mm rechts, 0.81 mm hoch
 Streuwert 2.00, horizontal: 2.29, vertikal: 1.66

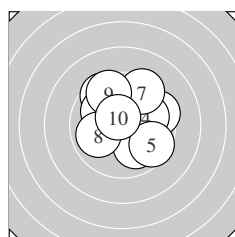
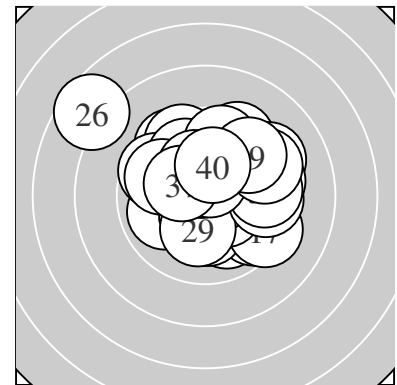

Serie 1:
 10.0 ↘ 9.5 ↖ 9.5 → 9.9 → 9.6 ↘
 10.0 ↖ 9.4 ↗ 9.9 ← 9.6 ↖ 10.6 *

beste Teiler 90.5 (10.) 236.4 (6.) 243.9 (1.)
 Trefferlage 0.38 mm rechts, 0.87 mm hoch
 Streuwert 2.12, horizontal: 2.24, vertikal: 1.99

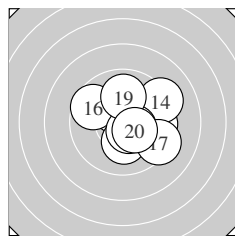

Serie 2:
 10.4 * 9.7 → 10.2 * 9.2 ↗ 10.5 *
 9.6 ↖ 9.3 ↘ 10.5 * 9.9 ↑ 10.4 *

beste Teiler 104.8 (18.) 122.5 (15.) 144.2 (20.)
 Trefferlage 0.99 mm rechts, 0.10 mm hoch
 Streuwert 1.88, horizontal: 2.10, vertikal: 1.62

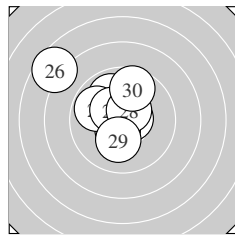

Serie 3:
 9.9 ↖ 10.8 * 10.6 * 10.5 * 9.8 ↘
 7.6 ↖ 10.4 * 10.5 * 10.2 * 9.6 ↑

beste Teiler 48.8 (22.) 81.3 (23.) 112.2 (24.)
 Trefferlage 0.99 mm links, 1.12 mm hoch
 Streuwert 2.14, horizontal: 2.28, vertikal: 1.99

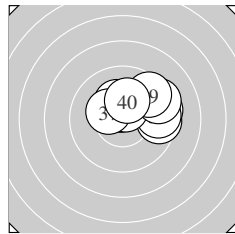

Serie 4:
 9.5 → 9.4 → 9.5 → 10.2 * 10.6 *
 10.5 * 10.3 * 9.4 ↗ 9.5 ↗ 10.2 *

beste Teiler 96.5 (35.) 101.2 (36.) 158.3 (37.)
 Trefferlage 1.55 mm rechts, 1.14 mm hoch
 Streuwert 1.54, horizontal: 2.03, vertikal: 0.78

Unterschrift des Schützen

Meyton Elektronik

Ergebnis: **391** (407.9)
 Serien: 100 97 97 97
 Zähler: 31 9 0 0 0 0 0 0 0 0
 Innenzehner: 24
 weiteste: 405 (38), 317 (32), 298 (25)
 beste Teiler 37.1 (23.) 70.7 (17.) 80.2 (2.)
 Trefferlage 0.39 mm rechts, 0.01 mm hoch
 Streuwert 1.43, horizontal: 1.61, vertikal: 1.22

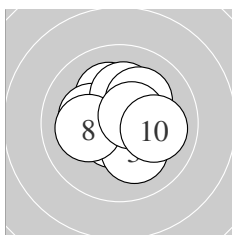
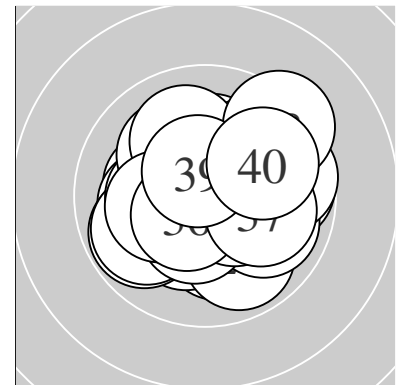

Serie 1:
 10.6 * 10.6 * 10.1 ↘ 10.2 * 10.2 *
 10.2 * 10.2 * 10.1 ← 10.6 * 10.0 →
 beste Teiler 80.2 (2.) 86.0 (1.) 96.2 (9.)
 Trefferlage 0.02 mm links, 0.32 mm hoch
 Streuwert 1.29, horizontal: 1.40, vertikal: 1.18

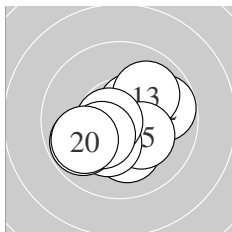

Serie 2:
 10.5 * 9.8 → 10.0 ↗ 10.2 * 10.2 *
 10.3 * 10.7 * 9.8 ↙ 10.3 * 9.9 ←
 beste Teiler 70.7 (17.) 118.9 (11.) 155.4 (19.)
 Trefferlage 0.00 mm , 0.49 mm tief
 Streuwert 1.53, horizontal: 1.77, vertikal: 1.24

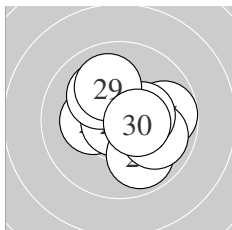

Serie 3:
 10.2 * 10.4 * 10.8 * 9.9 ↘ 9.8 →
 10.1 ↖ 9.9 ↘ 10.4 * 10.0 ↑ 10.5 *
 beste Teiler 37.1 (23.) 118.3 (30.) 126.1 (22.)
 Trefferlage 0.62 mm rechts, 0.02 mm hoch
 Streuwert 1.44, horizontal: 1.58, vertikal: 1.27

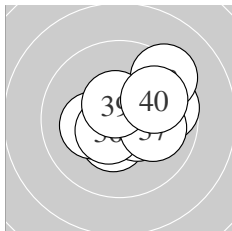

Serie 4:
 10.4 * 9.7 → 10.2 * 10.4 * 10.5 *
 10.5 * 10.0 → 9.3 ↗ 10.5 * 9.9 →
 beste Teiler 103.1 (39.) 105.0 (35.) 105.3 (36.)
 Trefferlage 0.96 mm rechts, 0.21 mm hoch
 Streuwert 1.48, horizontal: 1.69, vertikal: 1.22

Unterschrift des Schützen

Meyton Elektronik

Ergebnis: **378** (395.6)
 Serien: 96 94 97 91
 Zähler: 18 22 0 0 0 0 0 0 0 0
 Innenzehner: 12
 weiteste: 495 (6), 465 (30), 456 (1)
 beste Teiler 62.6 (26.) 72.5 (25.) 89.8 (3.)
 Trefferlage 0.49 mm links, 0.02 mm hoch
 Streuwert 2.05, horizontal: 2.22, vertikal: 1.86

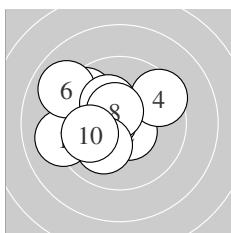
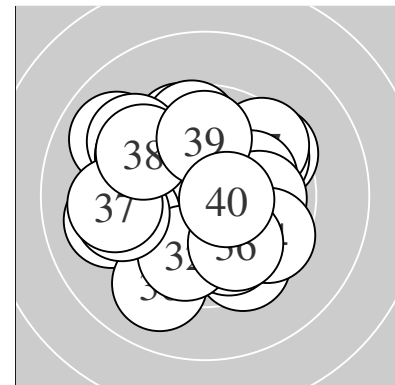

Serie 1:
 9.1 ← 10.6 * 10.6 * 9.5 ↗ 9.6 ↘
 9.0 ↖ 10.2 * 10.5 * 10.1 ↙ 10.0 ←
 beste Teiler 89.8 (3.) 97.6 (2.) 101.0 (8.)
 Trefferlage 1.32 mm links, 0.50 mm hoch
 Streuwert 1.93, horizontal: 2.25, vertikal: 1.56

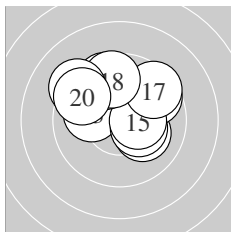

Serie 2:
 10.1 ↘ 9.7 ↗ 10.1 ← 10.3 * 10.4 *
 9.6 ↖ 9.5 ↗ 9.6 ↑ 9.3 ↘ 9.6 ↘
 beste Teiler 144.0 (15.) 164.5 (14.) 206.4 (11.)
 Trefferlage 0.01 mm links, 1.37 mm hoch
 Streuwert 1.97, horizontal: 2.31, vertikal: 1.55

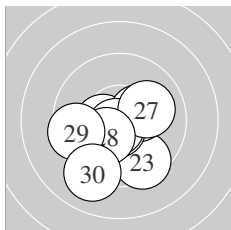

Serie 3:
 10.4 * 10.1 ↓ 9.5 ↘ 10.3 * 10.7 *
 10.7 * 10.0 → 10.3 * 9.5 ← 9.1 ↙
 beste Teiler 62.6 (26.) 72.5 (25.) 131.8 (21.)
 Trefferlage 0.32 mm links, 1.17 mm tief
 Streuwert 1.67, horizontal: 1.76, vertikal: 1.57

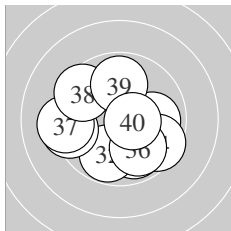

Serie 4:
 9.9 ↘ 9.8 ↓ 9.9 → 9.6 ↘ 9.4 ←
 9.9 ↘ 9.2 ← 9.5 ↖ 9.9 ↑ 10.5 *
 beste Teiler 103.4 (40.) 255.2 (33.) 265.4 (36.)
 Trefferlage 0.29 mm links, 0.59 mm tief
 Streuwert 2.26, horizontal: 2.61, vertikal: 1.85

Unterschrift des Schützen

Meyton Elektronik

Ergebnis: **373** (391.0)
 Serien: 95 87 96 95
 Zähler: 22 17 0 0 0 0 0 0 0 0
 Innenzehner: 16
 weiteste: 6735 (15), 491 (2), 455 (32)
 beste Teiler 21.0 (13.) 22.3 (9.) 64.0 (27.)
 Trefferlage 1.63 mm links, 1.83 mm hoch
 Streuwert 7.65, horizontal: 5.05, vertikal: 9.56

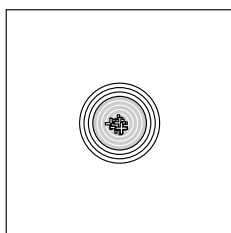
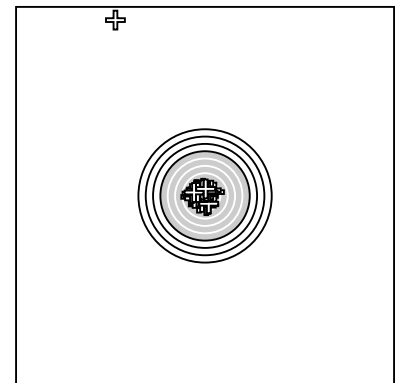

Serie 1:
 10.5 * 9.0 ← 9.6 ↓ 9.7 ↙ 9.7 ↓
 10.3 * 10.1 ← 10.3 * 10.9 * 9.7 ↓
 beste Teiler 22.3 (9.) 114.0 (1.) 169.1 (8.)
 Trefferlage 0.70 mm links, 1.18 mm tief
 Streuwert 1.78, horizontal: 1.93, vertikal: 1.61

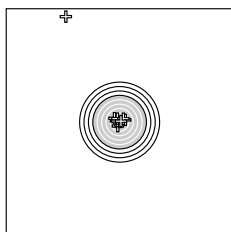

Serie 2:
 10.0 ↘ 10.1 ↖ 10.9 * 9.5 ↖ 0.0 ↖
 9.6 → 10.4 * 10.0 ↘ 9.8 ↗ 10.6 *
 beste Teiler 21.0 (13.) 93.0 (20.) 148.0 (17.)
 Trefferlage 3.29 mm links, 6.72 mm hoch
 Streuwert 14.96, horizontal: 9.77, vertikal: 18.77

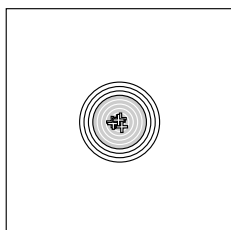

Serie 3:
 10.5 * 10.4 * 9.8 ← 9.3 ← 9.5 ←
 10.7 * 10.7 * 10.2 * 9.8 ↓ 10.4 *
 beste Teiler 64.0 (27.) 66.4 (26.) 124.8 (21.)
 Trefferlage 1.17 mm links, 0.20 mm hoch
 Streuwert 1.56, horizontal: 1.80, vertikal: 1.28

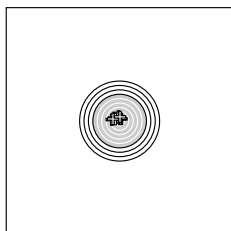

Serie 4:
 9.9 ↑ 9.1 ← 9.5 ↖ 10.3 * 10.1 ↖
 10.5 * 9.9 ↖ 10.3 * 9.4 ↖ 10.0 ↑
 beste Teiler 121.4 (36.) 161.0 (38.) 163.7 (34.)
 Trefferlage 1.35 mm links, 1.60 mm hoch
 Streuwert 1.44, horizontal: 1.96, vertikal: 0.59

Unterschrift des Schützen

Meyton Elektronik

Ergebnis:	375	(390.7)
Serien:	94	91 96 94
Zähler:	20	17 1 2 0 0 0 0 0 0
Innenzehner:	12	
weiteste:	912	(11), 775 (1), 589 (39)
beste Teiler	77.7	(2.) 97.6 (19.) 110.4 (9.)
Trefferlage	0.78 mm	rechts, 0.27 mm hoch
Streuwert	2.39,	horizontal: 2.16, vertikal: 2.59

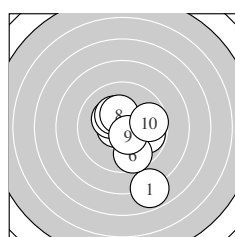
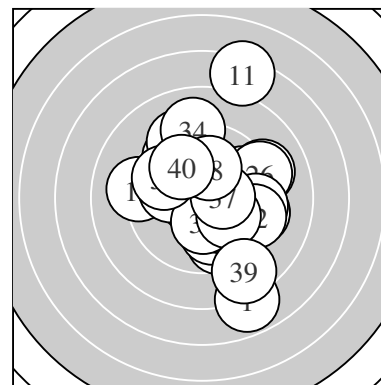

Serie 1:

7.9 ↘	10.6 *	10.1 ↘	9.8 →	10.3 *
9.6 ↘	10.3 *	10.3 *	10.5 *	9.7 →
beste Teiler	77.7 (2.)	110.4 (9.)	154.2 (8.)	
Trefferlage	0.90 mm rechts, 0.88 mm tief			
Streuwert	2.21, horizontal: 1.74, vertikal: 2.59			

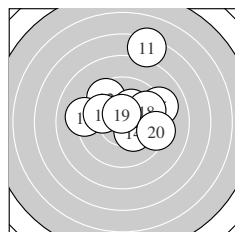

Serie 2:

7.3 ↑	9.6 ↖	9.2 ←	10.3 *	9.1 →
9.9 ↖	10.2 *	9.7 →	10.6 *	9.4 →
beste Teiler	97.6 (19.)	168.4 (14.)	187.5 (17.)	
Trefferlage	0.71 mm rechts, 1.66 mm hoch			
Streuwert	2.81, horizontal: 2.88, vertikal: 2.74			

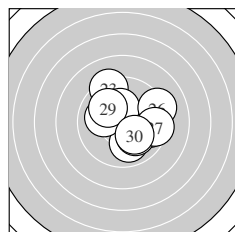

Serie 3:

9.7 →	10.0 ↓	9.3 ↖	10.1 ↘	10.3 *
9.2 →	9.4 →	10.1 ←	10.0 ↖	10.1 ↘
beste Teiler	169.1 (25.)	202.3 (30.)	222.3 (24.)	
Trefferlage	0.86 mm rechts, 0.26 mm hoch			
Streuwert	2.13, horizontal: 2.29, vertikal: 1.96			

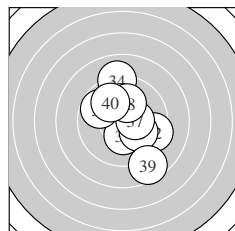

Serie 4:

10.5 *	9.4 →	10.3 *	9.0 ↑	10.1 ↘
9.8 ↖	10.4 *	10.1 ↑	8.6 ↓	9.9 ↖
beste Teiler	124.1 (31.)	145.2 (37.)	166.1 (33.)	
Trefferlage	0.66 mm rechts, 0.03 mm hoch			
Streuwert	2.35, horizontal: 1.93, vertikal: 2.71			

Unterschrift des Schützen

Meyton Elektronik