

Ergebnis: **391** (409.8)  
 Serien: 97 97 98 99  
 Zähler: 31 9 0 0 0 0 0 0 0 0  
 Innenzehner: 29  
 weiteste: 496 (16), 479 (37), 408 (7)  
 beste Teiler 17.2 (36.) 39.2 (28.) 61.5 (8.)  
 Trefferlage 0.21 mm links, 0.54 mm hoch  
 Streuwert 1.46, horizontal: 1.66, vertikal: 1.23

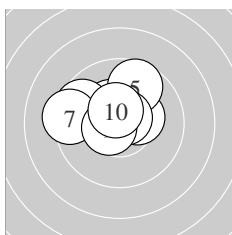

Serie 1:  
 10.5 \* 10.4 \* 10.3 \* 10.3 \* 9.7 ↗  
 9.6 ↖ 9.3 ← 10.7 \* 10.6 \* 10.5 \*  
 beste Teiler 61.5 (8.) 92.3 (9.) 107.7 (1.)  
 Trefferlage 0.59 mm links, 0.97 mm hoch  
 Streuwert 1.41, horizontal: 1.79, vertikal: 0.89

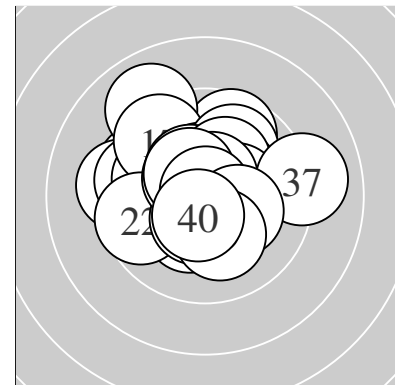
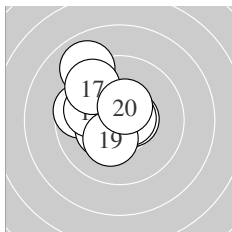

Serie 2:  
 10.6 \* 10.6 \* 9.7 ↖ 10.3 \* 10.0 ↖  
 9.0 ↘ 9.6 ↘ 10.7 \* 10.3 \* 10.5 \*  
 beste Teiler 74.5 (18.) 76.1 (11.) 97.3 (12.)  
 Trefferlage 0.95 mm links, 0.76 mm hoch  
 Streuwert 1.62, horizontal: 1.59, vertikal: 1.65

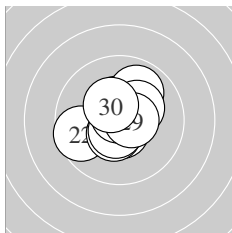

Serie 3:  
 10.4 \* 9.6 ↖ 10.6 \* 10.5 \* 9.9 ↗  
 10.6 \* 10.3 \* 10.8 \* 10.6 \* 10.4 \*  
 beste Teiler 39.2 (28.) 89.4 (23.) 91.4 (26.)  
 Trefferlage 0.10 mm links, 0.22 mm hoch  
 Streuwert 1.25, horizontal: 1.31, vertikal: 1.19

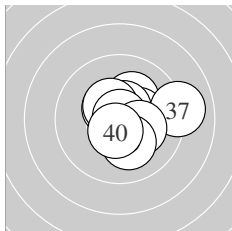

Serie 4:  
 10.5 \* 10.2 \* 10.3 \* 10.6 \* 10.4 \*  
 10.9 \* 9.0 → 10.3 \* 10.1 ↓ 10.6 \*  
 beste Teiler 17.2 (36.) 93.9 (34.) 100.9 (40.)  
 Trefferlage 0.79 mm rechts, 0.21 mm hoch  
 Streuwert 1.38, horizontal: 1.62, vertikal: 1.08

Unterschrift des Schützen

Meyton Elektronik

Ergebnis: **397** (412.4)  
 Serien: 99 100 98 100  
 Zähler: 37 3 0 0 0 0 0 0 0 0  
 Innenzehner: 27  
 weiteste: 310 (28), 278 (21), 264 (10)  
 beste Teiler 25.6 (8.) 26.6 (25.) 64.5 (16.)  
 Trefferlage 0.20 mm links, 0.10 mm hoch  
 Streuwert 1.25, horizontal: 1.36, vertikal: 1.13

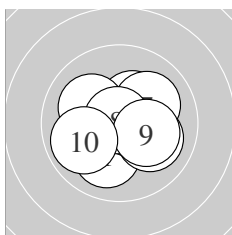
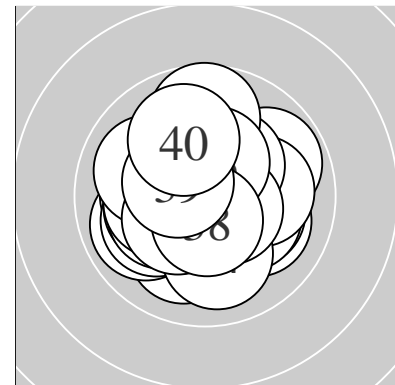

Serie 1:  
 10.1 ↘ 10.7 \* 10.3 \* 10.1 ↖ 10.0 ↗  
 10.6 \* 10.1 ↗ 10.9 \* 10.2 \* 9.9 ↖  
 beste Teiler 25.6 (8.) 69.0 (2.) 88.2 (6.)  
 Trefferlage 0.28 mm rechts, 0.09 mm tief  
 Streuwert 1.35, horizontal: 1.56, vertikal: 1.12

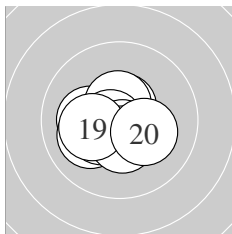

Serie 2:  
 10.2 \* 10.1 ↖ 10.6 \* 10.4 \* 10.5 \*  
 10.7 \* 10.6 \* 10.4 \* 10.2 \* 10.2 \*  
 beste Teiler 64.5 (16.) 90.0 (17.) 90.9 (13.)  
 Trefferlage 0.54 mm links, 0.34 mm tief  
 Streuwert 1.01, horizontal: 1.19, vertikal: 0.79

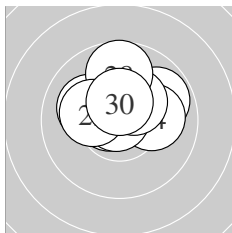

Serie 3:  
 9.8 ↗ 10.6 \* 10.7 \* 10.1 → 10.8 \*  
 10.3 \* 10.1 ↖ 9.7 ↑ 10.2 \* 10.5 \*  
 beste Teiler 26.6 (25.) 70.0 (23.) 81.4 (22.)  
 Trefferlage 0.15 mm rechts, 0.91 mm hoch  
 Streuwert 1.21, horizontal: 1.47, vertikal: 0.89

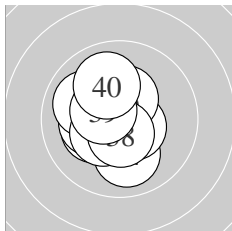

Serie 4:  
 10.2 \* 10.2 \* 10.0 ↖ 10.0 ↓ 10.5 \*  
 10.4 \* 10.4 \* 10.6 \* 10.5 \* 10.0 ↖  
 beste Teiler 98.3 (38.) 103.0 (35.) 123.0 (39.)  
 Trefferlage 0.70 mm links, 0.04 mm tief  
 Streuwert 1.22, horizontal: 1.08, vertikal: 1.34

Unterschrift des Schützen

Meyton Elektronik

Ergebnis: **386** (405.0)  
 Serien: 96 97 99 94  
 Zähler: 26 14 0 0 0 0 0 0 0 0  
 Innenzehner: 22  
 weiteste: 474 (14), 439 (40), 419 (39)  
 beste Teiler 15.6 (26.) 38.0 (27.) 51.7 (6.)  
 Trefferlage 0.69 mm links, 0.22 mm tief  
 Streuwert 1.62, horizontal: 1.67, vertikal: 1.56

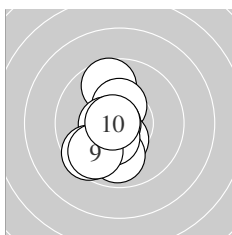
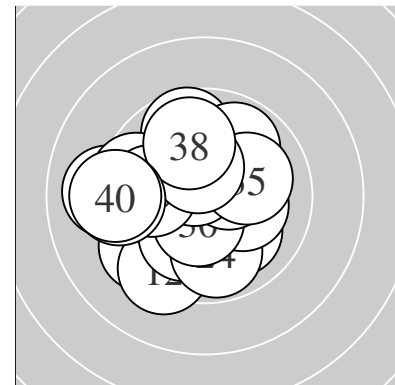

Serie 1:  
 9.7 ↑                      10.4 \*                      10.4 \*                      10.5 \*                      9.9 ↓  
 10.7 \*                      10.4 \*                      9.6 ↙                      9.7 ↙                      10.7 \*  
 beste Teiler 51.7 (6.) 58.3 (10.) 112.4 (4.)  
 Trefferlage 0.82 mm links, 0.55 mm tief  
 Streuwert 1.41, horizontal: 0.84, vertikal: 1.80

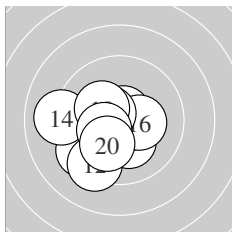

Serie 2:  
 9.4 ↙                      9.3 ↙                      10.2 \*                      9.1 ←                      10.7 \*  
 10.3 \*                      10.5 \*                      10.3 \*                      10.4 \*                      10.1 ↙  
 beste Teiler 62.6 (15.) 106.8 (17.) 149.7 (19.)  
 Trefferlage 1.16 mm links, 0.83 mm tief  
 Streuwert 1.68, horizontal: 1.83, vertikal: 1.51

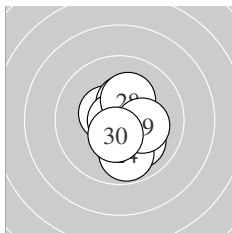

Serie 3:  
 10.1 ↓                      10.5 \*                      10.0 ↘                      9.8 ↓                      10.4 \*  
 10.9 \*                      10.8 \*                      10.2 \*                      10.2 \*                      10.5 \*  
 beste Teiler 15.6 (26.) 38.0 (27.) 122.9 (22.)  
 Trefferlage 0.36 mm rechts, 0.44 mm tief  
 Streuwert 1.21, horizontal: 0.88, vertikal: 1.47

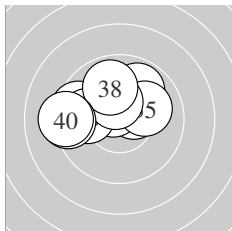

Serie 4:  
 9.9 ↗                      10.4 \*                      10.6 \*                      9.6 ←                      10.1 →  
 9.9 ←                      10.4 \*                      9.9 ↑                      9.3 ←                      9.2 ←  
 beste Teiler 93.1 (33.) 130.5 (32.) 144.0 (37.)  
 Trefferlage 1.15 mm links, 0.94 mm hoch  
 Streuwert 1.79, horizontal: 2.36, vertikal: 0.91

Unterschrift des Schützen

Meyton Elektronik

Ergebnis: **393** (411.8)  
 Serien: 97 99 100 97  
 Zähler: 33 7 0 0 0 0 0 0 0 0  
 Innenzehner: 29  
 weiteste: 366 (9), 305 (32), 296 (6)  
 beste Teiler 43.6 (31.) 61.8 (34.) 64.6 (20.)  
 Trefferlage 0.16 mm rechts, 0.22 mm tief  
 Streuwert 1.28, horizontal: 1.26, vertikal: 1.30

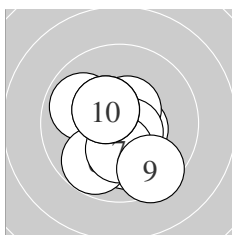
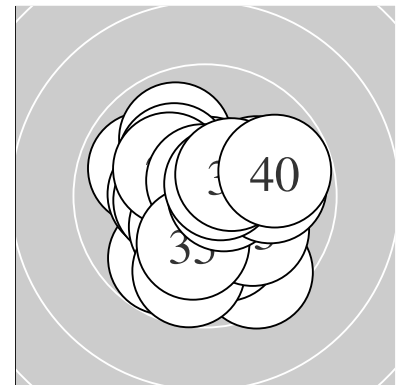

Serie 1:  
 9.9 ↘ 10.5 \* 10.5 \* 10.1 ↓ 10.6 \*  
 9.8 ↙ 10.3 \* 10.4 \* 9.5 ↓ 10.4 \*  
 beste Teiler 87.1 (5.) 103.0 (3.) 105.4 (2.)  
 Trefferlage 0.12 mm links, 0.65 mm tief  
 Streuwert 1.47, horizontal: 1.34, vertikal: 1.59

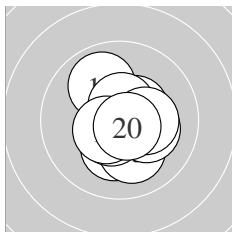

Serie 2:  
 9.9 ↖ 10.2 \* 10.1 ↓ 10.5 \* 10.6 \*  
 10.2 \* 10.6 \* 10.3 \* 10.5 \* 10.7 \*  
 beste Teiler 64.6 (20.) 91.9 (17.) 97.0 (15.)  
 Trefferlage 0.29 mm rechts, 0.23 mm tief  
 Streuwert 1.16, horizontal: 1.04, vertikal: 1.27

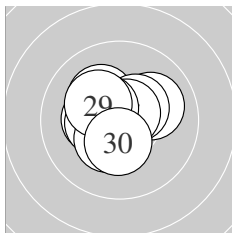

Serie 3:  
 10.2 \* 10.0 → 10.4 \* 10.3 \* 10.7 \*  
 10.4 \* 10.4 \* 10.4 \* 10.2 \* 10.4 \*  
 beste Teiler 67.1 (25.) 126.6 (27.) 132.6 (23.)  
 Trefferlage 0.40 mm links, 0.27 mm hoch  
 Streuwert 1.11, horizontal: 1.24, vertikal: 0.97

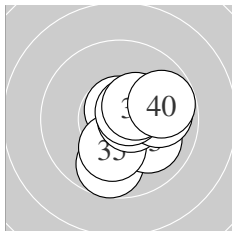

Serie 4:  
 10.8 \* 9.7 ↓ 10.0 ↘ 10.7 \* 10.2 \*  
 10.7 \* 9.9 → 10.6 \* 10.4 \* 9.8 →  
 beste Teiler 43.6 (31.) 61.8 (34.) 75.1 (36.)  
 Trefferlage 0.88 mm rechts, 0.27 mm tief  
 Streuwert 1.27, horizontal: 1.21, vertikal: 1.33

Unterschrift des Schützen

Ergebnis: **385** (403.0)  
 Serien: 97 94 98 96  
 Zähler: 26 13 1 0 0 0 0 0 0 0  
 Innenzehner: 24  
 weiteste: 651 (19), 439 (14), 397 (3)  
 beste Teiler 29.4 (1.) 47.2 (29.) 57.7 (23.)  
 Trefferlage 0.13 mm links, 0.69 mm hoch  
 Streuwert 1.77, horizontal: 1.86, vertikal: 1.67

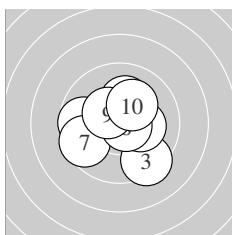
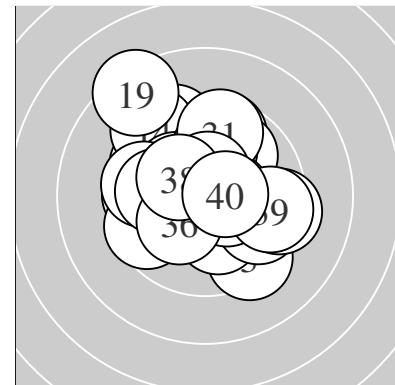

Serie 1:  
 10.8 \* 10.5 \* 9.4 ↘ 10.2 \* 10.2 \*  
 9.7 ← 9.6 ↙ 10.7 \* 10.4 \* 10.2 \*  
 beste Teiler 29.4 (1.) 62.0 (8.) 124.4 (2.)  
 Trefferlage 0.15 mm links, 0.01 mm hoch  
 Streuwert 1.70, horizontal: 1.87, vertikal: 1.51

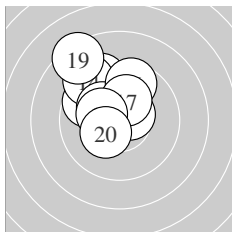

Serie 2:  
 9.7 ↖ 9.4 ↗ 10.6 \* 9.2 ↖ 10.2 \*  
 9.6 ↑ 10.2 \* 10.3 \* 8.3 ↖ 10.3 \*  
 beste Teiler 100.3 (13.) 161.5 (20.) 165.4 (18.)  
 Trefferlage 1.25 mm links, 2.00 mm hoch  
 Streuwert 1.76, horizontal: 1.61, vertikal: 1.90

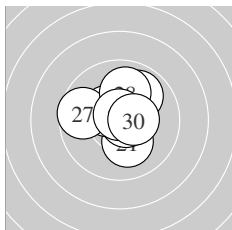

Serie 3:  
 10.2 \* 10.4 \* 10.7 \* 9.9 ↗ 10.4 \*  
 10.6 \* 9.7 ← 10.0 ↑ 10.8 \* 10.5 \*  
 beste Teiler 47.2 (29.) 57.7 (23.) 79.9 (26.)  
 Trefferlage 0.08 mm rechts, 0.65 mm hoch  
 Streuwert 1.28, horizontal: 1.36, vertikal: 1.20

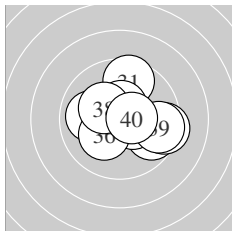

Serie 4:  
 9.6 ↑ 9.7 ↘ 9.4 → 10.0 ← 10.5 \*  
 10.2 \* 10.5 \* 10.3 \* 9.6 → 10.5 \*  
 beste Teiler 106.3 (40.) 112.8 (37.) 121.7 (35.)  
 Trefferlage 0.80 mm rechts, 0.11 mm hoch  
 Streuwert 1.81, horizontal: 2.13, vertikal: 1.42

Unterschrift des Schützen

Meyton Elektronik

Ergebnis: **378** (398.2)  
 Serien: 99 94 92 93  
 Zähler: 22 14 4 0 0 0 0 0 0 0  
 Innenzehner: 16  
 weiteste: 621 (21), 536 (26), 525 (19)  
 beste Teiler 52.0 (16.) 54.0 (5.) 73.7 (8.)  
 Trefferlage 0.69 mm links, 0.27 mm hoch  
 Streuwert 1.95, horizontal: 2.15, vertikal: 1.73

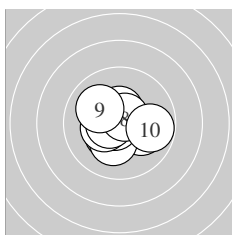
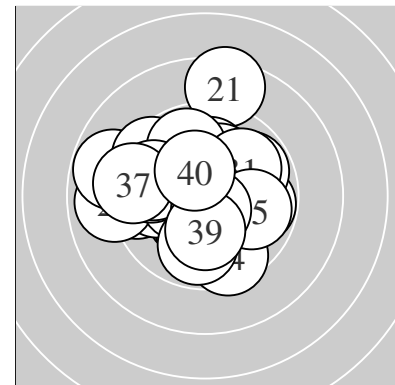

Serie 1:  
 10.4 \*                      10.1 ↘                      10.2 \*                      10.5 \*                      10.7 \*  
 10.4 \*                      10.6 \*                      10.7 \*                      10.0 ↖                      9.8 →  
 beste Teiler 54.0 (5.) 73.7 (8.) 94.5 (7.)  
 Trefferlage 0.09 mm links, 0.17 mm tief  
 Streuwert 1.26, horizontal: 1.50, vertikal: 0.97

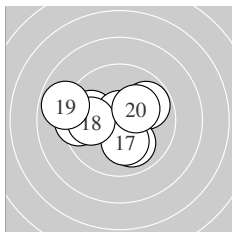

Serie 2:  
 10.1 ↘                      9.8 ↗                      9.9 ←                      9.4 ←                      10.0 ↘  
 10.7 \*                      10.1 ↓                      9.9 ←                      8.9 ←                      10.2 \*  
 beste Teiler 52.0 (16.) 185.3 (20.) 203.4 (17.)  
 Trefferlage 0.76 mm links, 0.14 mm tief  
 Streuwert 2.07, horizontal: 2.57, vertikal: 1.40

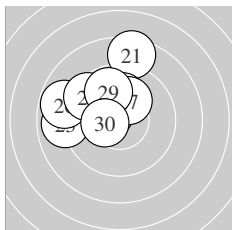

Serie 3:  
 8.5 ↑                      10.5 \*                      8.9 ←                      10.2 \*                      10.1 ↑  
 8.8 ↖                      10.2 \*                      9.5 ↖                      9.8 ↗                      10.4 \*  
 beste Teiler 112.2 (22.) 140.4 (30.) 194.9 (24.)  
 Trefferlage 1.46 mm links, 1.83 mm hoch  
 Streuwert 2.05, horizontal: 2.26, vertikal: 1.83

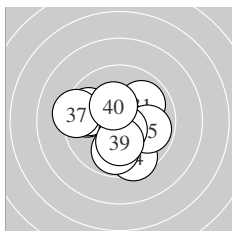

Serie 4:  
 9.9 ↗                      9.7 ←                      9.7 ←                      9.5 ↓                      9.9 →  
 9.8 ↓                      9.3 ←                      10.6 \*                      10.2 \*                      10.3 \*  
 beste Teiler 84.1 (38.) 153.3 (40.) 192.0 (39.)  
 Trefferlage 0.46 mm links, 0.42 mm tief  
 Streuwert 2.01, horizontal: 2.23, vertikal: 1.76

Unterschrift des Schützen

Meyton Elektronik

Ergebnis: **382** (399.8)  
 Serien: 95 95 95 97  
 Zähler: 22 18 0 0 0 0 0 0 0 0  
 Innenzehner: 14  
 weiteste: 445 (20), 444 (6), 425 (7)  
 beste Teiler 36.2 (35.) 79.5 (40.) 85.3 (19.)  
 Trefferlage 0.18 mm rechts, 0.11 mm hoch  
 Streuwert 1.86, horizontal: 1.82, vertikal: 1.91

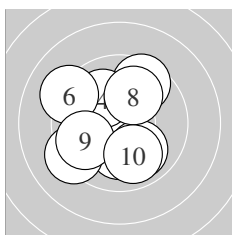
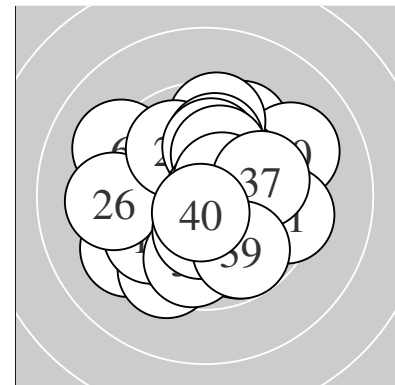

Serie 1:  
 10.5 \* 9.6 ↗ 10.1 ↓ 10.0 ↘ 10.0 ↘  
 9.2 ↖ 9.3 ↙ 10.0 ↗ 9.8 ↙ 9.9 ↘  
 beste Teiler 117.2 (1.) 207.0 (3.) 229.6 (4.)  
 Trefferlage 0.72 mm links, 0.04 mm tief  
 Streuwert 2.15, horizontal: 2.08, vertikal: 2.21

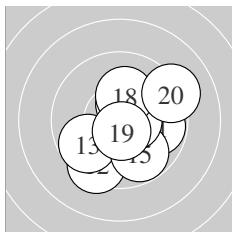

Serie 2:  
 9.8 → 9.4 ↙ 9.7 ↙ 10.5 \* 9.8 ↘  
 10.4 \* 10.5 \* 10.2 \* 10.6 \* 9.2 →  
 beste Teiler 85.3 (19.) 101.2 (17.) 106.9 (14.)  
 Trefferlage 0.69 mm rechts, 0.33 mm tief  
 Streuwert 1.86, horizontal: 1.90, vertikal: 1.83

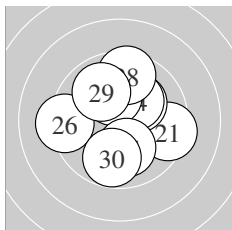

Serie 3:  
 9.4 → 10.1 ↗ 10.2 \* 10.2 \* 10.2 \*  
 9.3 ← 10.1 ↓ 9.6 ↑ 9.9 ↘ 9.8 ↓  
 beste Teiler 187.2 (24.) 189.9 (25.) 190.3 (23.)  
 Trefferlage 0.14 mm rechts, 0.59 mm hoch  
 Streuwert 2.05, horizontal: 2.06, vertikal: 2.03

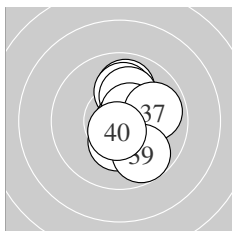

Serie 4:  
 10.6 \* 9.9 ↑ 10.0 ↑ 10.1 ↑ 10.8 \*  
 10.5 \* 9.9 → 10.3 \* 9.8 ↘ 10.6 \*  
 beste Teiler 36.2 (35.) 79.5 (40.) 94.0 (31.)  
 Trefferlage 0.64 mm rechts, 0.22 mm hoch  
 Streuwert 1.34, horizontal: 0.87, vertikal: 1.69

Unterschrift des Schützen

Ergebnis: **386** (405.6)  
 Serien: 100 96 95 95  
 Zähler: 28 10 2 0 0 0 0 0 0 0  
 Innenzehner: 26  
 weiteste: 709 (29), 620 (33), 478 (35)  
 beste Teiler 0.0 (1.) 15.2 (30.) 29.5 (17.)  
 Trefferlage 0.24 mm rechts, 0.05 mm tief  
 Streuwert 1.80, horizontal: 2.19, vertikal: 1.31

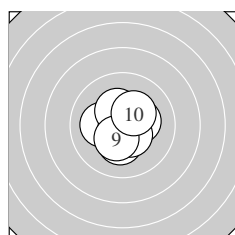
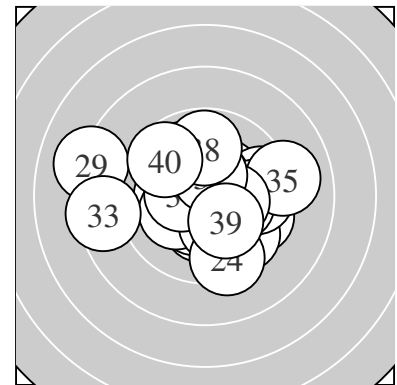

Serie 1:  
 10.9 \*                      10.1 ←                      10.3 \*                      10.3 \*                      10.6 \*  
 10.8 \*                      10.5 \*                      10.3 \*                      10.4 \*                      10.3 \*  
 beste Teiler 0.0 (1.) 49.7 (6.) 83.9 (5.)  
 Trefferlage 0.00 mm , 0.21 mm tief  
 Streuwert 1.02, horizontal: 1.01, vertikal: 1.03

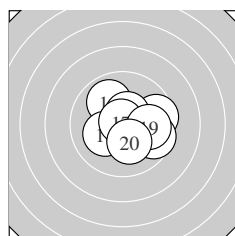

Serie 2:  
 9.9 ↖                      10.7 \*                      10.5 \*                      9.6 →                      10.5 \*  
 10.2 \*                      10.8 \*                      9.6 ↗                      9.9 →                      10.2 \*  
 beste Teiler 29.5 (17.) 54.7 (12.) 110.0 (15.)  
 Trefferlage 0.77 mm rechts, 0.13 mm tief  
 Streuwert 1.50, horizontal: 1.76, vertikal: 1.18

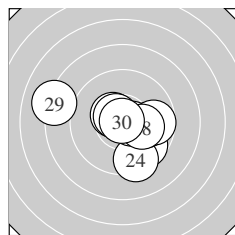

Serie 3:  
 9.7 ↘                      10.5 \*                      10.6 \*                      9.4 ↘                      10.0 →  
 10.6 \*                      9.7 →                      10.2 \*                      8.1 ←                      10.9 \*  
 beste Teiler 15.2 (30.) 90.0 (23.) 90.2 (26.)  
 Trefferlage 0.32 mm rechts, 0.36 mm tief  
 Streuwert 2.31, horizontal: 2.85, vertikal: 1.59

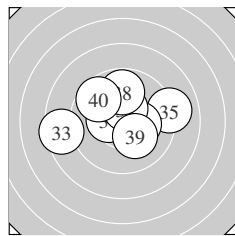

Serie 4:  
 10.6 \*                      10.6 \*                      8.5 ←                      10.4 \*                      9.0 →  
 10.3 \*                      10.4 \*                      9.8 ↑                      10.2 \*                      9.7 ↖  
 beste Teiler 76.9 (31.) 84.8 (32.) 126.1 (37.)  
 Trefferlage 0.11 mm links, 0.50 mm hoch  
 Streuwert 2.22, horizontal: 2.82, vertikal: 1.39

Unterschrift des Schützen

Meyton Elektronik



Ergebnis: **388** (407.1)  
 Serien: 96 98 97 97  
 Zähler: 28 12 0 0 0 0 0 0 0 0  
 Innenzehner: 23  
 weiteste: 458 (30), 401 (5), 374 (8)  
 beste Teiler 15.6 (14.) 58.6 (40.) 59.4 (38.)  
 Trefferlage 0.14 mm links, 0.06 mm hoch  
 Streuwert 1.55, horizontal: 1.35, vertikal: 1.73

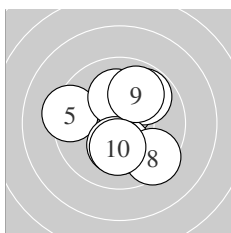
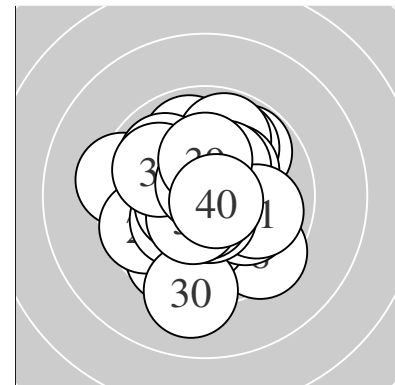

Serie 1:  
 10.2 \*                      10.5 \*                      9.8 ↗                      10.2 \*                      9.3 ←  
 10.1 ↑                      10.2 \*                      9.5 ↘                      9.9 ↗                      10.2 \*  
 beste Teiler 125.8 (2.) 176.9 (7.) 179.7 (4.)  
 Trefferlage 0.25 mm rechts, 0.21 mm hoch  
 Streuwert 1.89, horizontal: 1.77, vertikal: 1.99

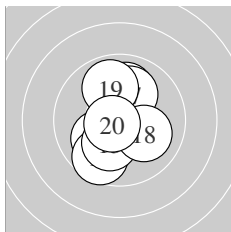

Serie 2:  
 10.1 ↙                      9.6 ↙                      10.2 \*                      10.9 \*                      10.3 \*  
 10.0 ↑                      10.1 ↑                      10.1 ↘                      9.9 ↑                      10.7 \*  
 beste Teiler 15.6 (14.) 66.6 (20.) 166.0 (15.)  
 Trefferlage 0.17 mm links, 0.09 mm hoch  
 Streuwert 1.58, horizontal: 1.12, vertikal: 1.93

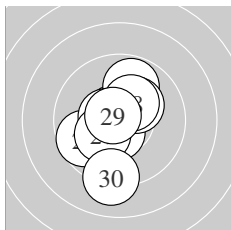

Serie 3:  
 10.7 \*                      9.8 ↑                      9.7 ↙                      10.5 \*                      10.2 \*  
 10.5 \*                      10.2 \*                      10.3 \*                      10.7 \*                      9.1 ↓  
 beste Teiler 64.0 (29.) 71.0 (21.) 101.4 (24.)  
 Trefferlage 0.39 mm links, 0.17 mm tief  
 Streuwert 1.65, horizontal: 1.23, vertikal: 1.98

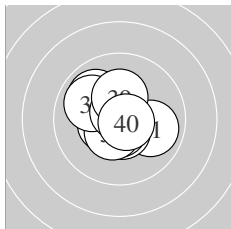

Serie 4:  
 9.9 →                      10.6 \*                      10.5 \*                      10.6 \*                      10.5 \*  
 9.9 ↘                      9.9 ↘                      10.7 \*                      10.3 \*                      10.7 \*  
 beste Teiler 58.6 (40.) 59.4 (38.) 80.1 (34.)  
 Trefferlage 0.27 mm links, 0.11 mm hoch  
 Streuwert 1.22, horizontal: 1.32, vertikal: 1.11

Unterschrift des Schützen

Meyton Elektronik

Ergebnis: **393** (410.3)  
 Serien: 99 97 100 97  
 Zähler: 33 7 0 0 0 0 0 0 0 0  
 Innenzehner: 27  
 weiteste: 385 (14), 353 (3), 351 (35)  
 beste Teiler 46.2 (7.) 46.3 (6.) 57.3 (16.)  
 Trefferlage 0.00 mm , 0.37 mm hoch  
 Streuwert 1.36, horizontal: 1.68, vertikal: 0.95

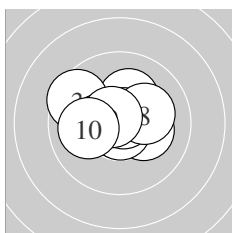
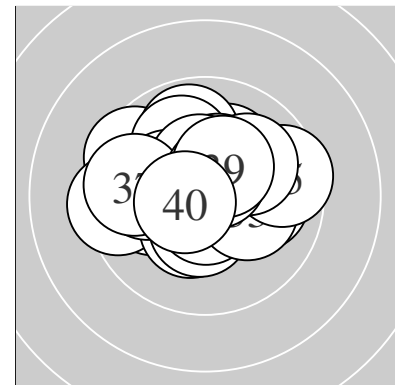

Serie 1:  
 10.2 \*                      10.2 \*                      9.5 ↖                      10.4 \*                      10.7 \*  
 10.8 \*                      10.8 \*                      10.2 \*                      10.7 \*                      10.0 ←  
 beste Teiler 46.2 (7.) 46.3 (6.) 64.0 (5.)  
 Trefferlage 0.21 mm links, 0.37 mm hoch  
 Streuwert 1.29, horizontal: 1.64, vertikal: 0.82

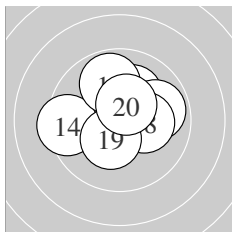

Serie 2:  
 10.1 ↗                      10.5 \*                      9.9 →                      9.4 ←                      9.8 ↗  
 10.7 \*                      10.5 \*                      10.2 \*                      10.3 \*                      10.5 \*  
 beste Teiler 57.3 (16.) 102.8 (17.) 104.6 (12.)  
 Trefferlage 0.13 mm rechts, 0.43 mm hoch  
 Streuwert 1.52, horizontal: 1.78, vertikal: 1.21

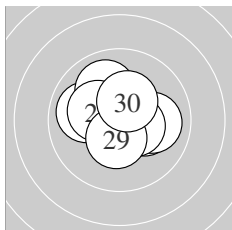

Serie 3:  
 10.0 ↖                      10.2 \*                      10.7 \*                      10.6 \*                      10.0 ↗  
 10.3 \*                      10.0 →                      10.5 \*                      10.4 \*                      10.4 \*  
 beste Teiler 75.0 (23.) 89.9 (24.) 119.0 (28.)  
 Trefferlage 0.06 mm links, 0.20 mm hoch  
 Streuwert 1.30, horizontal: 1.52, vertikal: 1.04

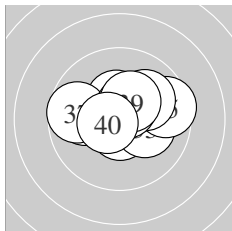

Serie 4:  
 9.9 ←                      10.6 \*                      10.2 \*                      10.4 \*                      9.5 →  
 10.0 ↗                      9.7 ←                      10.6 \*                      10.3 \*                      10.6 \*  
 beste Teiler 79.1 (32.) 93.3 (40.) 94.0 (38.)  
 Trefferlage 0.16 mm rechts, 0.48 mm hoch  
 Streuwert 1.52, horizontal: 2.00, vertikal: 0.81

Unterschrift des Schützen

Meyton Elektronik

Ergebnis: **385** (404.3)  
 Serien: 97 93 96 99  
 Zähler: 26 13 1 0 0 0 0 0 0 0  
 Innenzehner: 22  
 weiteste: 504 (14), 427 (15), 408 (17)  
 beste Teiler 44.6 (34.) 45.6 (2.) 48.0 (36.)  
 Trefferlage 0.04 mm rechts, 0.53 mm hoch  
 Streuwert 1.67, horizontal: 1.89, vertikal: 1.41

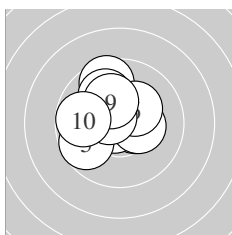
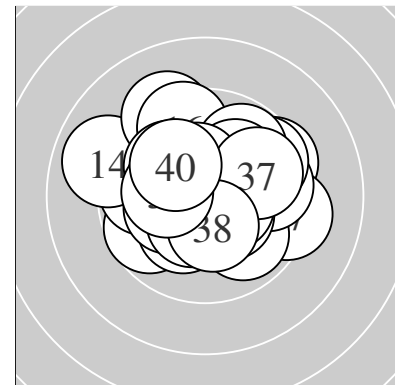

Serie 1:  
 10.4 \*                      10.8 \*                      9.6 ↗                      10.3 \*                      9.7 ↖  
 10.3 \*                      10.0 ↘                      10.6 \*                      10.2 \*                      9.8 ←  
 beste Teiler 45.6 (2.) 97.7 (8.) 127.0 (1.)  
 Trefferlage 0.58 mm links, 0.70 mm hoch  
 Streuwert 1.49, horizontal: 1.57, vertikal: 1.41

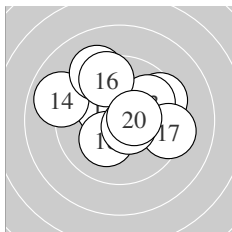

Serie 2:  
 9.5 →                      10.3 \*                      9.9 ↗                      8.9 ↖                      9.2 ↗  
 9.5 ↖                      9.3 →                      10.2 \*                      10.6 \*                      10.5 \*  
 beste Teiler 91.0 (19.) 120.2 (20.) 166.2 (12.)  
 Trefferlage 0.14 mm rechts, 1.01 mm hoch  
 Streuwert 2.25, horizontal: 2.66, vertikal: 1.75

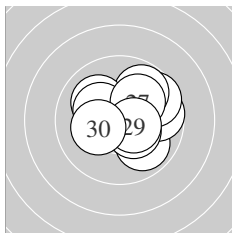

Serie 3:  
 9.9 ↘                      9.7 →                      9.6 ↗                      9.8 ↗                      10.1 ↘  
 10.2 \*                      10.1 ↗                      10.4 \*                      10.5 \*                      10.2 \*  
 beste Teiler 122.7 (29.) 144.6 (28.) 176.2 (26.)  
 Trefferlage 0.82 mm rechts, 0.44 mm hoch  
 Streuwert 1.61, horizontal: 1.83, vertikal: 1.34

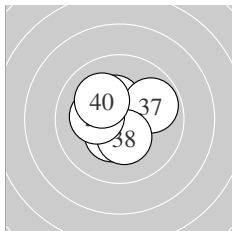

Serie 4:  
 10.6 \*                      10.4 \*                      10.4 \*                      10.8 \*                      10.7 \*  
 10.8 \*                      9.8 →                      10.4 \*                      10.2 \*                      10.1 ↘  
 beste Teiler 44.6 (34.) 48.0 (36.) 66.4 (35.)  
 Trefferlage 0.21 mm links, 0.01 mm tief  
 Streuwert 1.12, horizontal: 1.19, vertikal: 1.05

Unterschrift des Schützen

Meyton Elektronik

Ergebnis: **382** (399.7)  
 Serien: 96 96 96 94  
 Zähler: 24 14 2 0 0 0 0 0 0 0  
 Innenzehner: 15  
 weiteste: 583 (18), 519 (11), 474 (2)  
 beste Teiler 27.2 (17.) 51.4 (14.) 78.0 (38.)  
 Trefferlage 0.79 mm links, 0.02 mm hoch  
 Streuwert 1.86, horizontal: 2.07, vertikal: 1.61

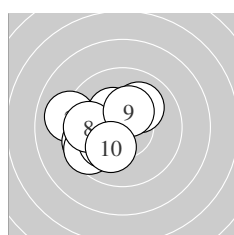
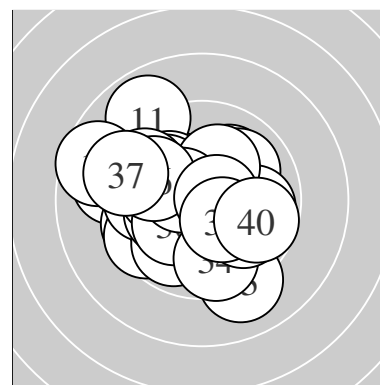

Serie 1:  
 10.1 ←                      9.1 ←                      10.1 ↗                      9.6 ←                      9.5 ↙  
 10.3 \*                      10.1 ↙                      9.8 ←                      10.4 \*                      10.1 ↙  
 beste Teiler 150.0 (9.) 153.1 (6.) 203.5 (10.)  
 Trefferlage 1.72 mm links, 0.14 mm tief  
 Streuwert 1.63, horizontal: 1.82, vertikal: 1.40

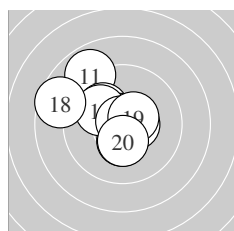

Serie 2:  
 8.9 ↘                      10.5 \*                      10.1 ↘                      10.7 \*                      10.4 \*  
 10.0 ↘                      10.8 \*                      8.6 ↙                      10.5 \*                      10.4 \*  
 beste Teiler 27.2 (17.) 51.4 (14.) 104.0 (12.)  
 Trefferlage 1.04 mm links, 0.72 mm hoch  
 Streuwert 1.86, horizontal: 2.02, vertikal: 1.69

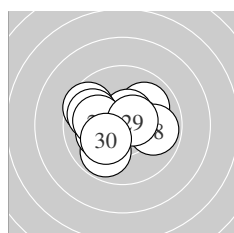

Serie 3:  
 9.8 ↙                      10.1 ←                      10.0 ↗                      10.5 \*                      9.6 ↘  
 9.8 ↙                      10.1 ←                      9.9 →                      10.6 \*                      10.2 \*  
 beste Teiler 96.6 (29.) 102.4 (24.) 190.3 (30.)  
 Trefferlage 0.67 mm links, 0.11 mm hoch  
 Streuwert 1.67, horizontal: 2.01, vertikal: 1.25

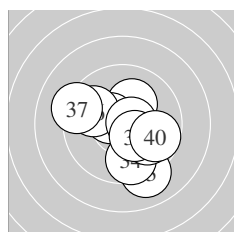

Serie 4:  
 10.2 \*                      10.5 \*                      9.1 ↓                      9.7 ↓                      9.9 ↘  
 9.8 ↙                      9.2 ↙                      10.6 \*                      10.4 \*                      9.7 →  
 beste Teiler 78.0 (38.) 119.8 (32.) 149.9 (39.)  
 Trefferlage 0.28 mm rechts, 0.58 mm tief  
 Streuwert 2.08, horizontal: 2.20, vertikal: 1.97

Unterschrift des Schützen

Meyton Elektronik

Ergebnis: **378** (397.3)  
 Serien: 94 91 96 97  
 Zähler: 22 14 4 0 0 0 0 0 0 0  
 Innenzehner: 19  
 weiteste: 657 (9), 547 (11), 543 (17)  
 beste Teiler 37.3 (8.) 38.0 (29.) 40.0 (30.)  
 Trefferlage 0.33 mm links, 0.04 mm tief  
 Streuwert 2.17, horizontal: 2.28, vertikal: 2.05

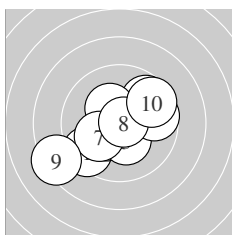
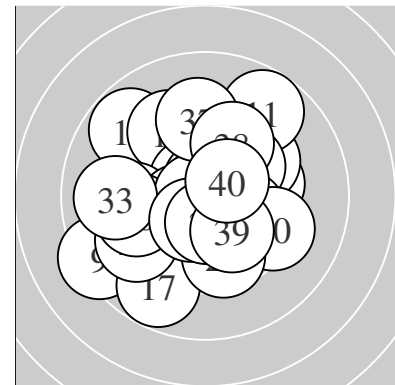

Serie 1:  
 9.4 ↙ 10.3 \* 10.3 \* 9.7 → 9.7 ↗  
 10.3 \* 10.1 ↙ 10.8 \* 8.3 ↙ 9.6 ↗  
 beste Teiler 37.3 (8.) 158.9 (6.) 161.1 (3.)  
 Trefferlage 0.31 mm links, 0.36 mm tief  
 Streuwert 2.36, horizontal: 2.77, vertikal: 1.86

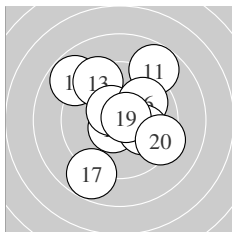

Serie 2:  
 8.8 ↗ 8.8 ↘ 9.4 ↘ 10.6 \* 10.5 \*  
 9.9 ↗ 8.8 ↙ 10.0 → 10.7 \* 9.3 ↘  
 beste Teiler 62.7 (19.) 90.0 (14.) 114.1 (15.)  
 Trefferlage 0.17 mm rechts, 0.60 mm hoch  
 Streuwert 2.70, horizontal: 2.56, vertikal: 2.83

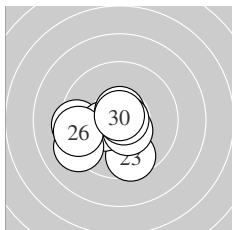

Serie 3:  
 10.6 \* 9.4 ← 9.6 ↓ 10.4 \* 9.2 ↙  
 9.4 ← 10.6 \* 10.5 \* 10.8 \* 10.8 \*  
 beste Teiler 38.0 (29.) 40.0 (30.) 77.0 (27.)  
 Trefferlage 1.13 mm links, 0.77 mm tief  
 Streuwert 1.61, horizontal: 1.93, vertikal: 1.22

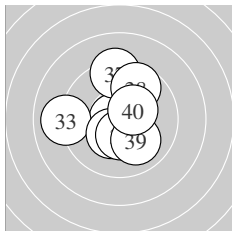

Serie 4:  
 10.3 \* 10.8 \* 9.0 ← 10.4 \* 10.4 \*  
 10.4 \* 9.3 ↑ 9.7 ↑ 10.0 ↓ 10.4 \*  
 beste Teiler 49.2 (32.) 136.8 (35.) 142.2 (36.)  
 Trefferlage 0.06 mm links, 0.34 mm hoch  
 Streuwert 1.92, horizontal: 1.86, vertikal: 1.98

Unterschrift des Schützen

Meyton Elektronik

Ergebnis: **392** (410.0)  
 Serien: 96 99 98 99  
 Zähler: 32 8 0 0 0 0 0 0 0 0  
 Innenzehner: 26  
 weiteste: 372 (29), 351 (22), 334 (4)  
 beste Teiler 37.5 (10.) 45.9 (3.) 51.8 (7.)  
 Trefferlage 0.35 mm links, 0.24 mm hoch  
 Streuwert 1.36, horizontal: 1.64, vertikal: 1.01

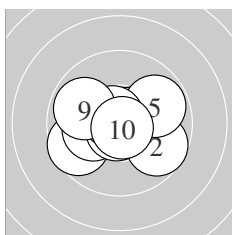
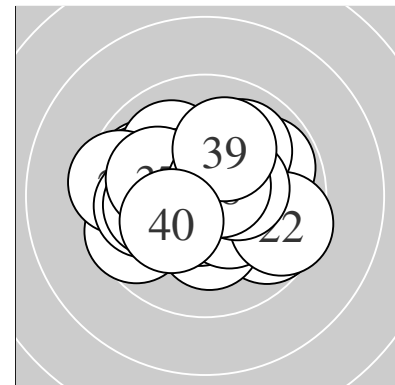

Serie 1:  
 10.5 \* 9.7 ↘ 10.8 \* 9.6 ↙ 9.8 ↗  
 10.2 \* 10.7 \* 10.7 \* 9.9 ↖ 10.8 \*  
 beste Teiler 37.5 (10.) 45.9 (3.) 51.8 (7.)  
 Trefferlage 0.13 mm links, 0.09 mm tief  
 Streuwert 1.53, horizontal: 1.94, vertikal: 0.96

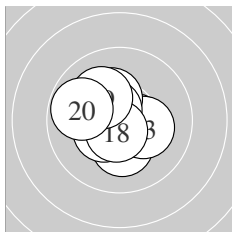

Serie 2:  
 10.2 \* 10.5 \* 10.2 \* 10.2 \* 10.3 \*  
 10.4 \* 10.6 \* 10.6 \* 10.1 ↘ 9.8 ↖  
 beste Teiler 81.3 (18.) 94.9 (17.) 117.0 (12.)  
 Trefferlage 0.50 mm links, 0.13 mm hoch  
 Streuwert 1.22, horizontal: 1.29, vertikal: 1.14

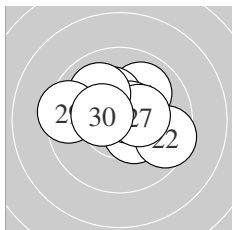

Serie 3:  
 10.4 \* 9.5 ↘ 10.5 \* 10.0 ↗ 10.3 \*  
 10.6 \* 10.4 \* 10.0 ↘ 9.5 ↖ 10.4 \*  
 beste Teiler 90.2 (26.) 124.4 (23.) 131.3 (30.)  
 Trefferlage 0.18 mm rechts, 0.61 mm hoch  
 Streuwert 1.58, horizontal: 1.97, vertikal: 1.06

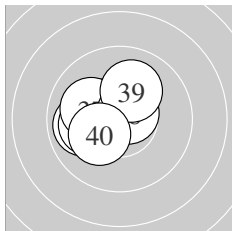

Serie 4:  
 10.2 \* 9.9 ↖ 10.1 ↖ 10.5 \* 10.6 \*  
 10.4 \* 10.1 ↖ 10.7 \* 10.1 ↗ 10.2 \*  
 beste Teiler 74.4 (38.) 78.1 (35.) 104.8 (34.)  
 Trefferlage 0.96 mm links, 0.34 mm hoch  
 Streuwert 1.09, horizontal: 1.25, vertikal: 0.89

Unterschrift des Schützen

Meyton Elektronik

Ergebnis:	<b>359</b>	(377.3)								
Serien:	86	89	91	93						
Zähler:	13	14	12	1	0	0	0	0	0	0
Innenzehner:	12									
weiteste:	984 (3), 724 (12), 722 (16)									
beste Teiler	31.3 (40.)	32.5 (38.)	54.1 (29.)							
Trefferlage	0.67 mm rechts, 0.87 mm tief									
Streuwert	3.07, horizontal: 3.68, vertikal: 2.30									

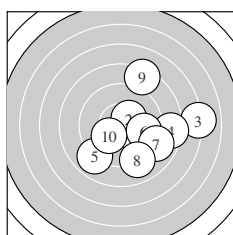
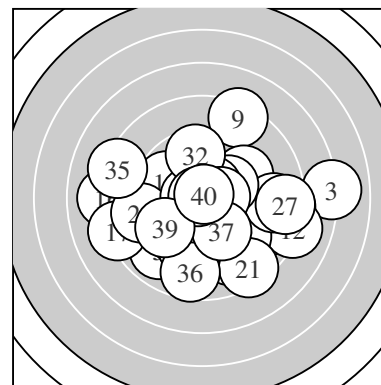

Serie 1:

9.8 ↘	10.4 *	7.0 →	8.4 →	8.9 ↙
9.7 →	8.9 ↘	9.0 ↓	8.3 ↑	10.2 *

beste Teiler 136.8 (2.) 198.2 (10.) 286.6 (1.)  
 Trefferlage 2.70 mm rechts, 0.74 mm tief  
 Streuwert 3.35, horizontal: 3.71, vertikal: 2.94

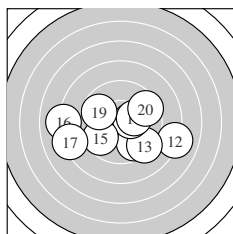

Serie 2:

9.7 ↓	8.1 →	9.3 ↘	10.4 *	9.7 ↙
8.1 ←	8.2 ←	10.2 *	9.7 ↘	9.5 →

beste Teiler 128.1 (14.) 178.7 (18.) 301.0 (19.)  
 Trefferlage 0.11 mm links, 0.85 mm tief  
 Streuwert 3.41, horizontal: 4.48, vertikal: 1.77

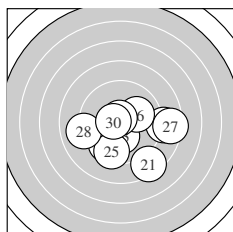

Serie 3:

8.4 ↓	8.8 →	10.2 *	9.6 ↙	9.4 ↓
10.1 →	8.4 →	9.0 ←	10.7 *	10.6 *

beste Teiler 54.1 (29.) 91.4 (30.) 177.7 (23.)  
 Trefferlage 0.87 mm rechts, 1.39 mm tief  
 Streuwert 2.80, horizontal: 3.42, vertikal: 2.00

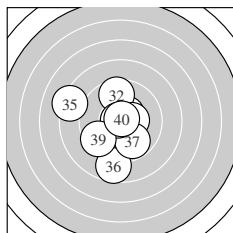

Serie 4:

10.5 *	9.6 ↑	10.4 *	10.3 *	8.2 ↘
8.7 ↓	9.8 ↓	10.8 *	9.5 ↙	10.8 *

beste Teiler 31.3 (40.) 32.5 (38.) 117.2 (31.)  
 Trefferlage 0.78 mm links, 0.50 mm tief  
 Streuwert 2.46, horizontal: 2.34, vertikal: 2.58

Unterschrift des Schützen

Meyton Elektronik

Ergebnis: **384** (403.5)  
 Serien: 93 97 97 97  
 Zähler: 26 13 0 1 0 0 0 0 0 0  
 Innenzehner: 21  
 weiteste: 788 (7), 415 (27), 385 (15)  
 beste Teiler 32.9 (30.) 36.3 (31.) 50.6 (10.)  
 Trefferlage 0.82 mm links, 0.73 mm hoch  
 Streuwert 1.67, horizontal: 1.93, vertikal: 1.36

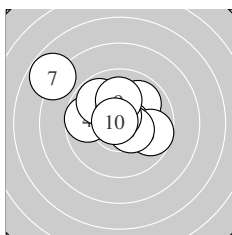
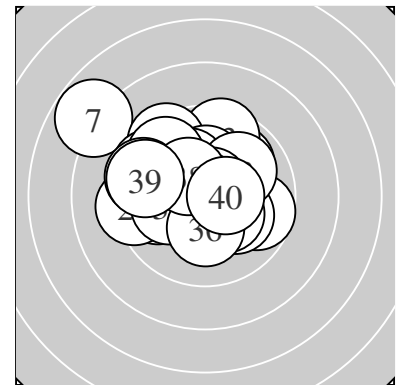

Serie 1:  
 9.9 ↗ 10.6 \* 9.7 → 9.7 ← 10.4 \*  
 10.7 \* 7.8 ↘ 9.8 ↘ 10.1 ↑ 10.8 \*  
 beste Teiler 50.6 (10.) 72.1 (6.) 76.6 (2.)  
 Trefferlage 0.55 mm links, 1.03 mm hoch  
 Streuwert 2.24, horizontal: 2.71, vertikal: 1.64

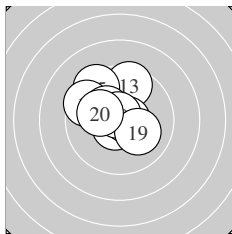

Serie 2:  
 10.6 \* 10.5 \* 9.5 ↑ 10.7 \* 9.4 ↘  
 9.5 ↘ 10.3 \* 10.7 \* 10.1 → 10.1 ←  
 beste Teiler 51.5 (18.) 71.1 (14.) 77.9 (11.)  
 Trefferlage 0.57 mm links, 0.97 mm hoch  
 Streuwert 1.51, horizontal: 1.55, vertikal: 1.46

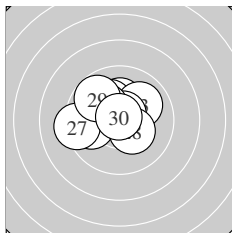

Serie 3:  
 10.2 \* 10.2 \* 10.0 ↗ 9.8 ← 10.7 \*  
 10.2 \* 9.3 ← 10.3 \* 9.8 ↘ 10.8 \*  
 beste Teiler 32.9 (30.) 65.8 (25.) 158.7 (28.)  
 Trefferlage 0.79 mm links, 0.70 mm hoch  
 Streuwert 1.54, horizontal: 1.85, vertikal: 1.14

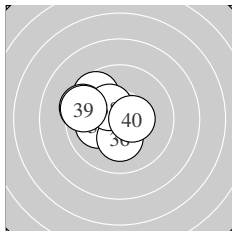

Serie 4:  
 10.8 \* 10.3 \* 10.4 \* 9.6 ↘ 10.1 ←  
 10.2 \* 9.5 ← 10.4 \* 9.5 ← 10.5 \*  
 beste Teiler 36.3 (31.) 119.0 (40.) 144.9 (33.)  
 Trefferlage 1.37 mm links, 0.21 mm hoch  
 Streuwert 1.40, horizontal: 1.58, vertikal: 1.20

Unterschrift des Schützen

Meyton Elektronik



Ergebnis: **382** (398.8)  
 Serien: 94 95 98 95  
 Zähler: 24 14 2 0 0 0 0 0 0 0  
 Innenzehner: 19  
 weiteste: 641 (40), 605 (5), 471 (18)  
 beste Teiler 59.2 (2.) 70.4 (32.) 102.5 (20.)  
 Trefferlage 0.04 mm rechts, 0.06 mm hoch  
 Streuwert 2.03, horizontal: 2.54, vertikal: 1.35

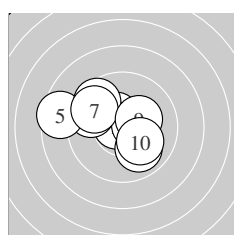
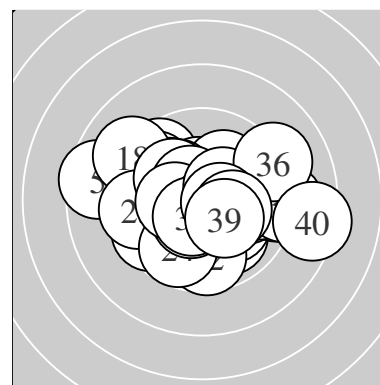

Serie 1:  
 10.5 \* 10.7 \* 9.6 ↖ 10.5 \* 8.5 ←  
 9.6 ↘ 9.7 ↘ 9.9 ↘ 10.3 \* 10.1 ↘  
 beste Teiler 59.2 (2.) 121.1 (4.) 125.8 (1.)  
 Trefferlage 0.93 mm links, 0.53 mm hoch  
 Streuwert 2.04, horizontal: 2.55, vertikal: 1.35

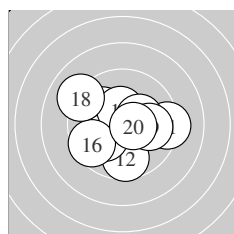

Serie 2:  
 9.3 → 9.7 ↓ 10.0 ↖ 10.1 ↙ 10.4 \*  
 9.6 ↙ 10.3 \* 9.1 ↖ 9.9 → 10.5 \*  
 beste Teiler 102.5 (20.) 136.6 (15.) 170.2 (17.)  
 Trefferlage 0.10 mm links, 0.11 mm tief  
 Streuwert 2.17, horizontal: 2.56, vertikal: 1.68

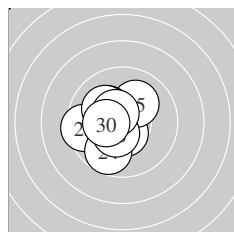

Serie 3:  
 10.2 \* 10.5 \* 9.5 ← 9.7 ↙ 10.1 ↗  
 10.2 \* 10.1 ↖ 10.5 \* 10.5 \* 10.3 \*  
 beste Teiler 105.9 (22.) 108.8 (29.) 125.0 (28.)  
 Trefferlage 1.14 mm links, 0.05 mm tief  
 Streuwert 1.33, horizontal: 1.30, vertikal: 1.37

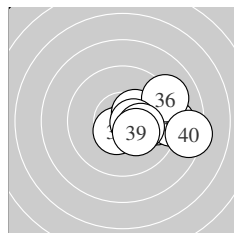

Serie 4:  
 9.7 → 10.7 \* 10.5 \* 9.1 → 10.4 \*  
 9.1 ↗ 10.5 \* 10.2 \* 10.3 \* 8.4 →  
 beste Teiler 70.4 (32.) 104.8 (37.) 109.9 (33.)  
 Trefferlage 2.36 mm rechts, 0.12 mm tief  
 Streuwert 1.66, horizontal: 2.12, vertikal: 1.00

Unterschrift des Schützen

Meyton Elektronik

Ergebnis: **397** (416.2)  
 Serien: 99 100 99 99  
 Zähler: 37 3 0 0 0 0 0 0 0 0  
 Innenzehner: 32  
 weiteste: 379 (33), 286 (7), 257 (28)  
 beste Teiler 12.1 (40.) 13.9 (11.) 32.1 (30.)  
 Trefferlage 0.35 mm links, 0.52 mm hoch  
 Streuwert 1.03, horizontal: 0.89, vertikal: 1.16

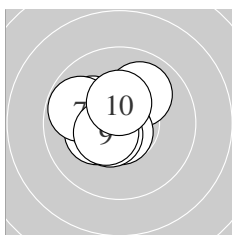
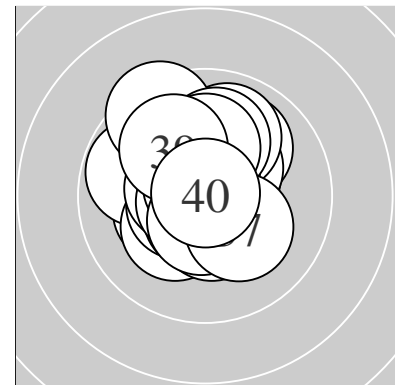

Serie 1:  
 10.0 ↗ 10.8 \* 10.3 \* 10.1 ↘ 10.4 \*  
 10.7 \* 9.8 ↙ 10.6 \* 10.5 \* 10.4 \*  
 beste Teiler 43.1 (2.) 61.2 (6.) 100.7 (8.)  
 Trefferlage 0.76 mm links, 0.23 mm hoch  
 Streuwert 1.09, horizontal: 1.16, vertikal: 1.01

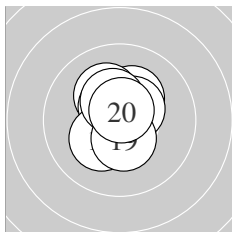

Serie 2:  
 10.9 \* 10.3 \* 10.6 \* 10.5 \* 10.2 \*  
 10.5 \* 10.2 \* 10.4 \* 10.4 \* 10.7 \*  
 beste Teiler 13.9 (11.) 69.2 (20.) 79.1 (13.)  
 Trefferlage 0.16 mm links, 0.50 mm hoch  
 Streuwert 0.89, horizontal: 0.70, vertikal: 1.05

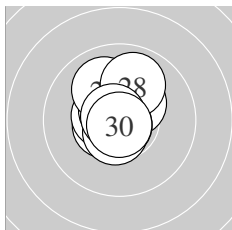

Serie 3:  
 10.5 \* 10.5 \* 10.3 \* 10.6 \* 10.8 \*  
 10.0 ↘ 10.6 \* 9.9 ↑ 10.8 \* 10.8 \*  
 beste Teiler 32.1 (30.) 34.0 (25.) 50.6 (29.)  
 Trefferlage 0.26 mm links, 0.50 mm hoch  
 Streuwert 0.94, horizontal: 0.75, vertikal: 1.09

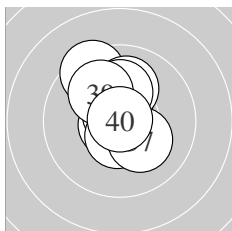

Serie 4:  
 10.7 \* 10.5 \* 9.4 ↘ 10.7 \* 10.5 \*  
 10.0 ↑ 10.2 \* 10.2 \* 10.0 ↘ 10.9 \*  
 beste Teiler 12.1 (40.) 56.0 (34.) 65.9 (31.)  
 Trefferlage 0.23 mm links, 0.85 mm hoch  
 Streuwert 1.24, horizontal: 0.90, vertikal: 1.51

Unterschrift des Schützen

Ergebnis: **377** (393.9)  
 Serien: 93 91 95 98  
 Zähler: 22 13 5 0 0 0 0 0 0 0  
 Innenzehner: 15  
 weiteste: 735 (10), 721 (6), 661 (14)  
 beste Teiler 13.4 (40.) 30.1 (15.) 57.4 (37.)  
 Trefferlage 0.00 mm , 0.50 mm hoch  
 Streuwert 2.36, horizontal: 2.94, vertikal: 1.58

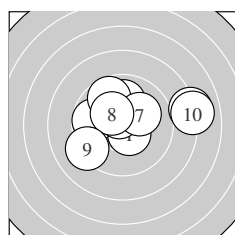
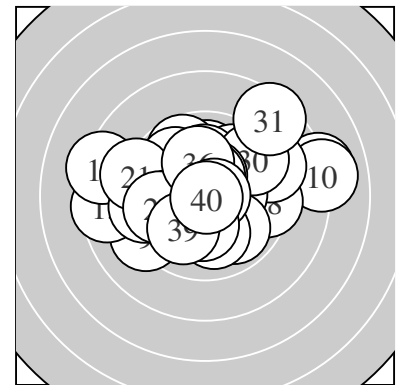

Serie 1:  
 10.5 \*                      10.0 ↑                      9.7 ←                      10.6 \*                      9.7 ↖  
 8.1 →                      10.1 ↗                      10.3 \*                      9.2 ↙                      8.0 →  
 beste Teiler 91.0 (4.) 112.0 (1.) 163.5 (8.)  
 Trefferlage 0.73 mm rechts, 0.85 mm hoch  
 Streuwert 2.86, horizontal: 3.74, vertikal: 1.54

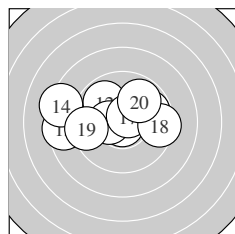

Serie 2:  
 9.8 →                      9.9 ↖                      8.5 ←                      8.3 ←                      10.8 \*  
 10.4 \*                      10.6 \*                      9.4 →                      9.4 ←                      9.8 ↗  
 beste Teiler 30.1 (15.) 84.9 (17.) 140.0 (16.)  
 Trefferlage 1.07 mm links, 0.57 mm hoch  
 Streuwert 2.60, horizontal: 3.51, vertikal: 1.12

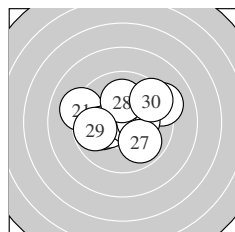

Serie 3:  
 9.2 ←                      10.1 ←                      10.3 \*                      9.2 →                      10.7 \*  
 10.3 \*                      9.9 ↘                      10.1 ↑                      9.8 ←                      9.5 ↗  
 beste Teiler 60.0 (25.) 157.2 (23.) 162.3 (26.)  
 Trefferlage 0.02 mm rechts, 0.40 mm hoch  
 Streuwert 2.15, horizontal: 2.67, vertikal: 1.43

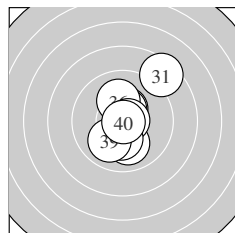

Serie 4:  
 8.5 ↗                      10.4 \*                      10.0 ↓                      10.5 \*                      10.4 \*  
 10.1 ↑                      10.7 \*                      10.2 \*                      10.0 ↙                      10.9 \*  
 beste Teiler 13.4 (40.) 57.4 (37.) 120.6 (34.)  
 Trefferlage 0.35 mm rechts, 0.18 mm hoch  
 Streuwert 1.85, horizontal: 1.41, vertikal: 2.21

Unterschrift des Schützen

Meyton Elektronik

Ergebnis: **382** (403.6)  
 Serien: 97 96 93 96  
 Zähler: 23 16 1 0 0 0 0 0 0 0  
 Innenzehner: 20  
 weiteste: 550 (24), 478 (33), 414 (30)  
 beste Teiler 14.8 (2.) 62.0 (34.) 68.8 (5.)  
 Trefferlage 0.18 mm links, 0.42 mm hoch  
 Streuwert 1.75, horizontal: 2.04, vertikal: 1.40

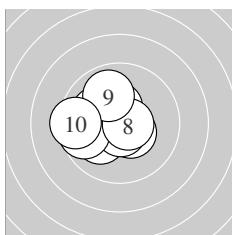
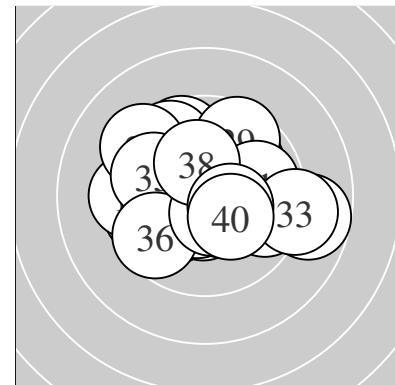

Serie 1:  
 10.4 \*                      10.9 \*                      10.4 \*                      10.1 ↖                      10.7 \*  
 10.1 ↖                      9.7 ←                      10.7 \*                      9.9 ↗                      9.4 ←  
 beste Teiler 14.8 (2.) 68.8 (5.) 74.6 (8.)  
 Trefferlage 1.00 mm links, 0.08 mm hoch  
 Streuwert 1.40, horizontal: 1.61, vertikal: 1.16

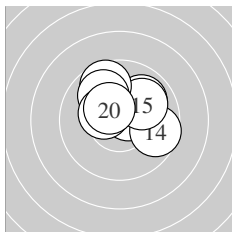

Serie 2:  
 10.4 \*                      9.9 ↗                      10.6 \*                      9.6 →                      10.0 ↗  
 10.4 \*                      9.7 ↘                      9.9 ↘                      10.4 \*                      10.4 \*  
 beste Teiler 86.9 (13.) 136.7 (20.) 140.7 (16.)  
 Trefferlage 0.08 mm rechts, 1.15 mm hoch  
 Streuwert 1.41, horizontal: 1.69, vertikal: 1.05

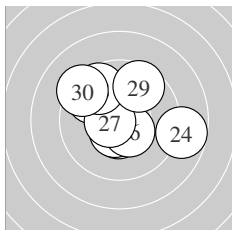

Serie 3:  
 9.8 ↘                      10.5 \*                      9.7 ↘                      8.8 →                      10.5 \*  
 10.4 \*                      10.6 \*                      9.6 ↘                      9.6 ↗                      9.3 ↘  
 beste Teiler 85.0 (27.) 108.6 (25.) 113.4 (22.)  
 Trefferlage 0.27 mm links, 0.79 mm hoch  
 Streuwert 2.17, horizontal: 2.49, vertikal: 1.80

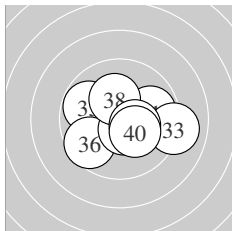

Serie 4:  
 9.9 →                      10.7 \*                      9.0 →                      10.7 \*                      9.8 ↖  
 9.6 ↖                      10.6 \*                      10.2 \*                      10.4 \*                      10.3 \*  
 beste Teiler 62.0 (34.) 70.8 (32.) 96.3 (37.)  
 Trefferlage 0.45 mm rechts, 0.31 mm tief  
 Streuwert 1.78, horizontal: 2.25, vertikal: 1.13

Unterschrift des Schützen

Meyton Elektronik

Ergebnis: **385** (400.5)  
 Serien: 99 93 99 94  
 Zähler: 29 8 2 1 0 0 0 0 0 0  
 Innenzehner: 23  
 weiteste: 868 (12), 658 (16), 632 (38)  
 beste Teiler 38.9 (25.) 49.3 (5.) 56.2 (39.)  
 Trefferlage 0.44 mm rechts, 0.21 mm tief  
 Streuwert 2.09, horizontal: 2.39, vertikal: 1.74

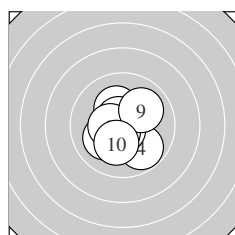
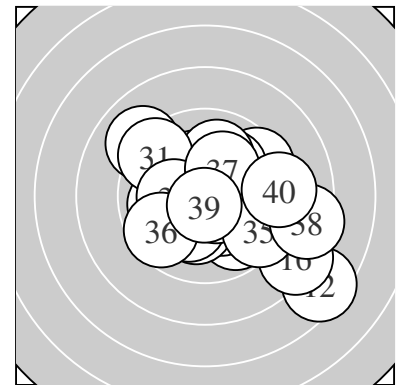

Serie 1:  
 10.3 \*                      10.1 ↙                      10.2 \*                      9.8 ↘                      10.8 \*  
 10.6 \*                      10.7 \*                      10.5 \*                      10.0 ↗                      10.2 \*  
 beste Teiler 49.3 (5.) 73.7 (7.) 87.6 (6.)  
 Trefferlage 0.19 mm links, 0.12 mm tief  
 Streuwert 1.30, horizontal: 1.18, vertikal: 1.41

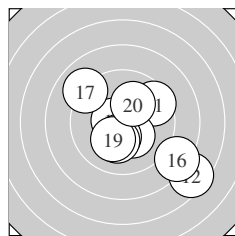

Serie 2:  
 9.5 ↗                      7.5 ↘                      10.3 \*                      10.6 \*                      10.4 \*  
 8.3 ↘                      9.0 ↖                      10.2 \*                      10.2 \*                      10.1 ↗  
 beste Teiler 93.5 (14.) 150.6 (15.) 168.0 (13.)  
 Trefferlage 1.09 mm rechts, 0.83 mm tief  
 Streuwert 2.93, horizontal: 3.21, vertikal: 2.63

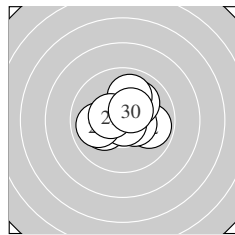

Serie 3:  
 10.2 \*                      9.9 →                      10.5 \*                      10.6 \*                      10.8 \*  
 10.0 ←                      10.0 ↗                      10.0 ↑                      10.5 \*                      10.4 \*  
 beste Teiler 38.9 (25.) 94.0 (24.) 124.9 (23.)  
 Trefferlage 0.15 mm rechts, 0.37 mm hoch  
 Streuwert 1.35, horizontal: 1.57, vertikal: 1.08

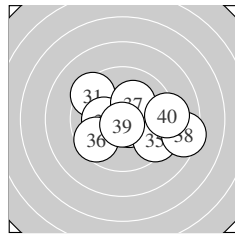

Serie 4:  
 9.4 ↘                      10.6 \*                      10.6 \*                      10.2 \*                      9.4 ↘  
 9.6 ↙                      10.2 \*                      8.4 →                      10.7 \*                      9.2 →  
 beste Teiler 56.2 (39.) 89.1 (33.) 95.2 (32.)  
 Trefferlage 0.71 mm rechts, 0.28 mm tief  
 Streuwert 2.40, horizontal: 3.07, vertikal: 1.47

Unterschrift des Schützen

Meyton Elektronik

Ergebnis: **397** (413.9)  
 Serien: 98 100 100 99  
 Zähler: 37 3 0 0 0 0 0 0 0 0  
 Innenzehner: 29  
 weiteste: 333 (37), 313 (1), 253 (8)  
 beste Teiler 36.7 (3.) 39.0 (31.) 40.7 (35.)  
 Trefferlage 0.08 mm rechts, 0.00 mm  
 Streuwert 1.21, horizontal: 1.18, vertikal: 1.24

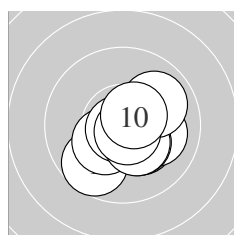
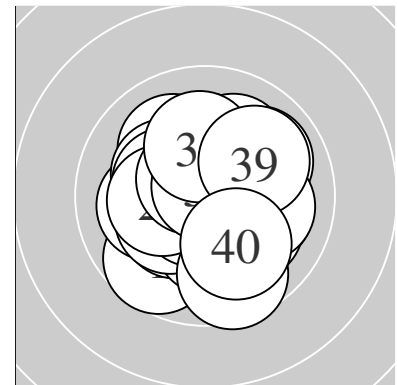

Serie 1:  
 9.7 ↙ 10.3 \* 10.8 \* 10.3 \* 10.1 →  
 10.3 \* 10.4 \* 9.9 ↗ 10.7 \* 10.6 \*  
 beste Teiler 36.7 (3.) 53.4 (9.) 100.6 (10.)  
 Trefferlage 0.52 mm rechts, 0.62 mm tief  
 Streuwert 1.20, horizontal: 1.31, vertikal: 1.08

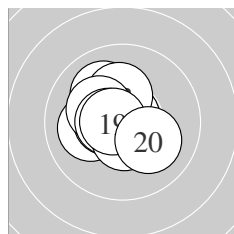

Serie 2:  
 10.0 ↖ 10.8 \* 10.2 \* 10.1 ← 10.5 \*  
 10.2 \* 10.6 \* 10.5 \* 10.7 \* 10.1 ↘  
 beste Teiler 44.6 (12.) 65.1 (19.) 97.0 (17.)  
 Trefferlage 0.58 mm links, 0.23 mm hoch  
 Streuwert 1.07, horizontal: 1.10, vertikal: 1.03

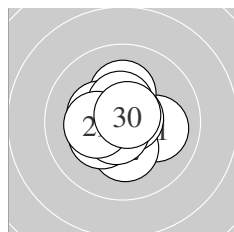

Serie 3:  
 10.1 → 10.2 \* 10.2 \* 10.7 \* 10.3 \*  
 10.3 \* 10.5 \* 10.7 \* 10.3 \* 10.7 \*  
 beste Teiler 56.7 (24.) 57.6 (30.) 75.2 (28.)  
 Trefferlage 0.20 mm links, 0.04 mm hoch  
 Streuwert 1.11, horizontal: 1.17, vertikal: 1.06

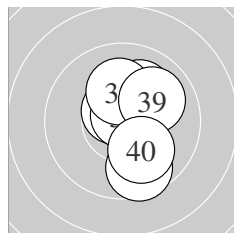

Serie 4:  
 10.8 \* 10.5 \* 10.5 \* 10.6 \* 10.8 \*  
 10.1 ↗ 9.6 ↘ 10.2 \* 10.0 ↗ 10.0 ↘  
 beste Teiler 39.0 (31.) 40.7 (35.) 87.6 (34.)  
 Trefferlage 0.58 mm rechts, 0.33 mm hoch  
 Streuwert 1.30, horizontal: 0.82, vertikal: 1.64

Unterschrift des Schützen

Meyton Elektronik

Ergebnis: **364** (382.3)  
 Serien: 90 90 92 92  
 Zähler: 10 24 6 0 0 0 0 0 0 0  
 Innenzehner: 7  
 weiteste: 735 (24), 716 (16), 685 (2)  
 beste Teiler 71.5 (36.) 96.1 (7.) 112.3 (25.)  
 Trefferlage 0.97 mm links, 0.24 mm hoch  
 Streuwert 2.68, horizontal: 3.03, vertikal: 2.28

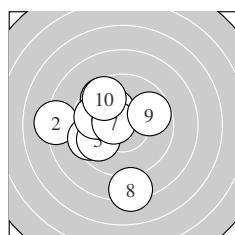
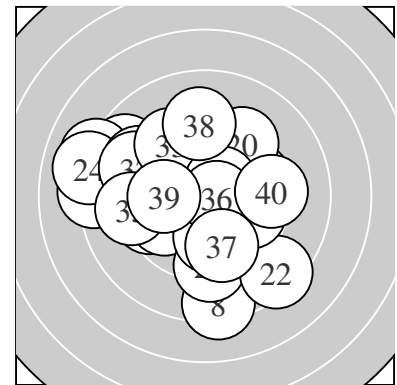

Serie 1:  
 9.6 ↘                      8.2 ←                      10.2 \*                      9.5 ←                      9.8 ←  
 9.8 ←                      10.6 \*                      8.3 ↓                      9.8 →                      9.6 ↘  
 beste Teiler 96.1 (7.) 177.7 (3.) 286.9 (6.)  
 Trefferlage 1.78 mm links, 0.00 mm  
 Streuwert 2.63, horizontal: 2.55, vertikal: 2.71

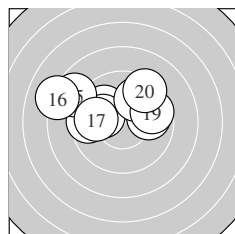

Serie 2:  
 10.0 ↘                      9.9 →                      9.5 ←                      10.1 ←                      8.7 ↘  
 8.1 ←                      9.9 ←                      9.9 ↑                      9.7 →                      9.4 ↑  
 beste Teiler 209.0 (14.) 243.6 (11.) 268.9 (18.)  
 Trefferlage 1.24 mm links, 1.48 mm hoch  
 Streuwert 2.54, horizontal: 3.41, vertikal: 1.15

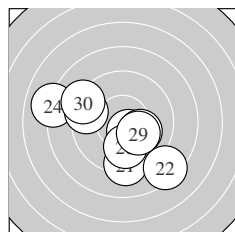

Serie 3:  
 9.2 ↓                      8.4 ↘                      10.3 \*                      8.0 ←                      10.5 \*  
 10.1 ↘                      9.4 ←                      9.9 ↓                      10.2 \*                      9.1 ↘  
 beste Teiler 112.3 (25.) 175.6 (23.) 196.6 (29.)  
 Trefferlage 0.46 mm links, 1.08 mm tief  
 Streuwert 2.93, horizontal: 3.44, vertikal: 2.30

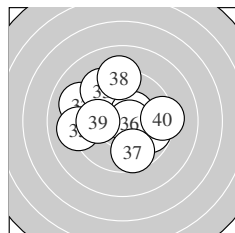

Serie 4:  
 9.8 →                      9.1 ↘                      9.4 ↘                      10.4 \*                      9.1 ←  
 10.7 \*                      9.7 ↓                      9.2 ↑                      9.9 ←                      9.3 →  
 beste Teiler 71.5 (36.) 127.0 (34.) 254.0 (39.)  
 Trefferlage 0.42 mm links, 0.54 mm hoch  
 Streuwert 2.55, horizontal: 2.89, vertikal: 2.15

Unterschrift des Schützen

Meyton Elektronik

Ergebnis: **386** (405.6)  
 Serien: 96 95 97 98  
 Zähler: 27 12 1 0 0 0 0 0 0 0  
 Innenzehner: 23  
 weiteste: 614 (5), 435 (15), 367 (8)  
 beste Teiler 20.6 (17.) 39.2 (38.) 48.3 (31.)  
 Trefferlage 0.01 mm links, 0.11 mm hoch  
 Streuwert 1.70, horizontal: 1.80, vertikal: 1.59

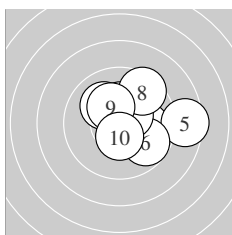
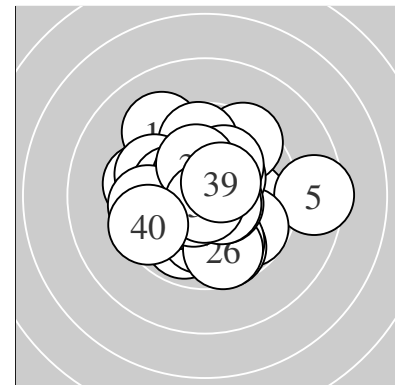

Serie 1:  
 10.3 \*                      10.5 \*                      10.1 ↘                      10.0 →                      8.5 →  
 9.7 ↘                      10.5 \*                      9.5 ↗                      10.3 \*                      10.5 \*  
 beste Teiler 119.2 (7.) 123.0 (10.) 124.8 (2.)  
 Trefferlage 1.23 mm rechts, 0.64 mm hoch  
 Streuwert 1.85, horizontal: 2.18, vertikal: 1.46

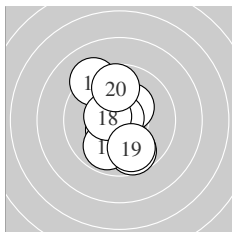

Serie 2:  
 10.4 \*                      10.6 \*                      10.3 \*                      9.7 ↓                      9.2 ↘  
 9.9 ↓                      10.9 \*                      10.5 \*                      9.8 ↓                      9.7 ↑  
 beste Teiler 20.6 (17.) 100.7 (12.) 117.3 (18.)  
 Trefferlage 0.26 mm links, 0.13 mm tief  
 Streuwert 1.81, horizontal: 1.18, vertikal: 2.27

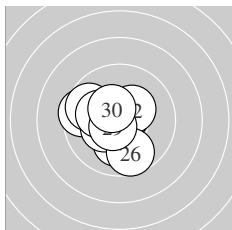

Serie 3:  
 10.7 \*                      10.3 \*                      10.1 ↓                      9.5 ←                      10.3 \*  
 9.7 ↓                      9.7 ←                      10.2 \*                      10.6 \*                      10.4 \*  
 beste Teiler 71.0 (21.) 88.4 (29.) 130.3 (30.)  
 Trefferlage 0.85 mm links, 0.14 mm tief  
 Streuwert 1.51, horizontal: 1.58, vertikal: 1.44

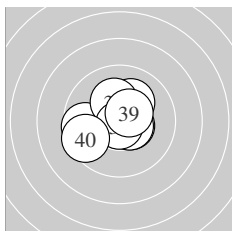

Serie 4:  
 10.8 \*                      10.7 \*                      10.1 ↗                      9.6 ←                      10.5 \*  
 10.5 \*                      10.2 \*                      10.8 \*                      10.5 \*                      9.5 ←  
 beste Teiler 39.2 (38.) 48.3 (31.) 73.3 (32.)  
 Trefferlage 0.19 mm links, 0.10 mm hoch  
 Streuwert 1.40, horizontal: 1.67, vertikal: 1.06

Unterschrift des Schützen

Meyton Elektronik



Ergebnis: **397** (420.5)  
 Serien: 99 99 99 100  
 Zähler: 37 3 0 0 0 0 0 0 0 0  
 Innenzehner: 37  
 weiteste: 275 (13), 270 (23), 269 (1)  
 beste Teiler 24.3 (11.) 31.7 (22.) 34.1 (31.)  
 Trefferlage 0.03 mm rechts, 0.15 mm hoch  
 Streuwert 0.90, horizontal: 0.95, vertikal: 0.85

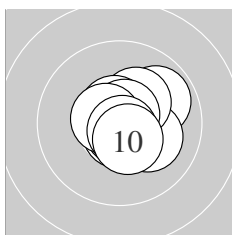
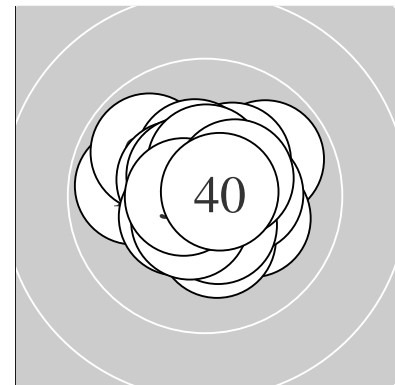

Serie 1:  
 9.9 ↗ 10.2 \* 10.3 \* 10.6 \* 10.7 \*  
 10.8 \* 10.7 \* 10.6 \* 10.8 \* 10.5 \*  
 beste Teiler 45.0 (6.) 50.9 (9.) 62.8 (5.)  
 Trefferlage 0.48 mm rechts, 0.09 mm hoch  
 Streuwert 0.94, horizontal: 0.97, vertikal: 0.90

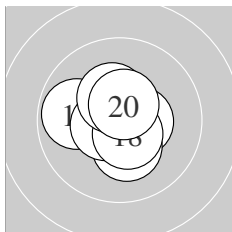

Serie 2:  
 10.9 \* 10.7 \* 9.9 ← 10.5 \* 10.3 \*  
 10.8 \* 10.6 \* 10.5 \* 10.4 \* 10.5 \*  
 beste Teiler 24.3 (11.) 36.0 (16.) 68.1 (12.)  
 Trefferlage 0.18 mm links, 0.06 mm tief  
 Streuwert 0.99, horizontal: 1.07, vertikal: 0.89

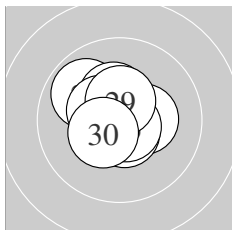

Serie 3:  
 10.7 \* 10.8 \* 9.9 ↖ 10.3 \* 10.6 \*  
 10.7 \* 10.4 \* 10.4 \* 10.5 \* 10.4 \*  
 beste Teiler 31.7 (22.) 57.9 (26.) 75.4 (21.)  
 Trefferlage 0.20 mm links, 0.39 mm hoch  
 Streuwert 0.96, horizontal: 1.02, vertikal: 0.89

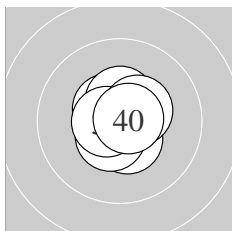

Serie 4:  
 10.8 \* 10.5 \* 10.5 \* 10.5 \* 10.6 \*  
 10.5 \* 10.5 \* 10.6 \* 10.4 \* 10.7 \*  
 beste Teiler 34.1 (31.) 58.2 (40.) 80.0 (35.)  
 Trefferlage 0.06 mm rechts, 0.18 mm hoch  
 Streuwert 0.73, horizontal: 0.67, vertikal: 0.79

Unterschrift des Schützen

Ergebnis: **393** (412.3)  
 Serien: 98 97 100 98  
 Zähler: 33 7 0 0 0 0 0 0 0 0  
 Innenzehner: 29  
 weiteste: 432 (34), 341 (12), 325 (19)  
 beste Teiler 18.4 (39.) 27.8 (27.) 51.6 (15.)  
 Trefferlage 0.25 mm links, 0.69 mm tief  
 Streuwert 1.24, horizontal: 1.37, vertikal: 1.09

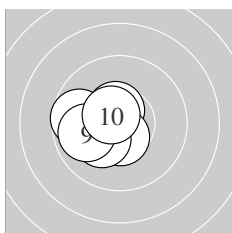
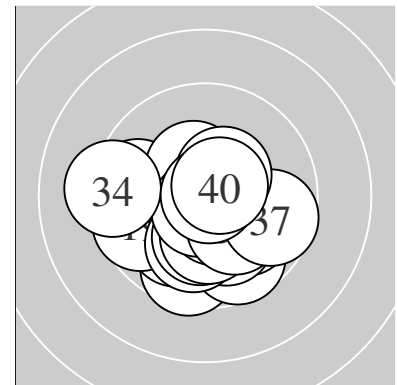

Serie 1:  
 10.7 \*                      10.5 \*                      10.7 \*                      10.5 \*                      10.5 \*  
 10.5 \*                      10.2 \*                      9.7 ←                      9.9 ←                      10.6 \*  
 beste Teiler 57.6 (3.) 68.7 (1.) 91.9 (10.)  
 Trefferlage 1.08 mm links, 0.13 mm tief  
 Streuwert 0.90, horizontal: 1.01, vertikal: 0.78

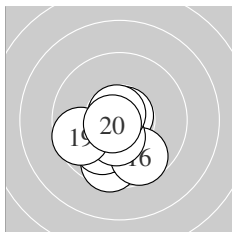

Serie 2:  
 10.4 \*                      9.6 ↓                      10.3 \*                      10.0 ↙                      10.7 \*  
 9.7 ↘                      10.4 \*                      10.7 \*                      9.7 ←                      10.7 \*  
 beste Teiler 51.6 (15.) 53.7 (18.) 63.0 (20.)  
 Trefferlage 0.56 mm links, 1.28 mm tief  
 Streuwert 1.20, horizontal: 1.16, vertikal: 1.24

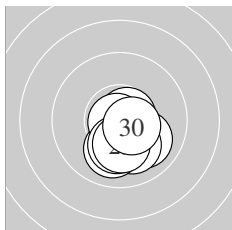

Serie 3:  
 10.2 \*                      10.0 ↘                      10.7 \*                      10.6 \*                      10.1 ↓  
 10.0 ↓                      10.8 \*                      10.2 \*                      10.2 \*                      10.5 \*  
 beste Teiler 27.8 (27.) 63.9 (23.) 93.1 (24.)  
 Trefferlage 0.34 mm rechts, 1.25 mm tief  
 Streuwert 0.81, horizontal: 0.74, vertikal: 0.88

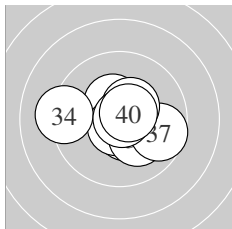

Serie 4:  
 10.5 \*                      10.4 \*                      10.7 \*                      9.2 ←                      10.4 \*  
 10.2 \*                      9.7 →                      10.4 \*                      10.9 \*                      10.6 \*  
 beste Teiler 18.4 (39.) 64.8 (33.) 83.2 (40.)  
 Trefferlage 0.27 mm rechts, 0.11 mm tief  
 Streuwert 1.48, horizontal: 1.90, vertikal: 0.89

Unterschrift des Schützen

Meyton Elektronik

Ergebnis:	<b>390</b>	(409.7)
Serien:	97 96 98 99	
Zähler:	31 8 1 0 0 0 0 0 0 0	
Innenzehner:	27	
weiteste:	544 (14), 370 (15), 325 (24)	
beste Teiler	50.6 (5.) 52.0 (39.) 67.7 (25.)	
Trefferlage	0.34 mm links, 0.05 mm hoch	
Streuwert	1.45, horizontal: 1.50, vertikal: 1.40	

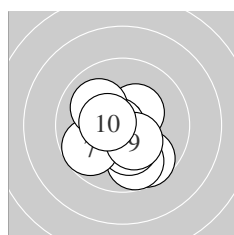
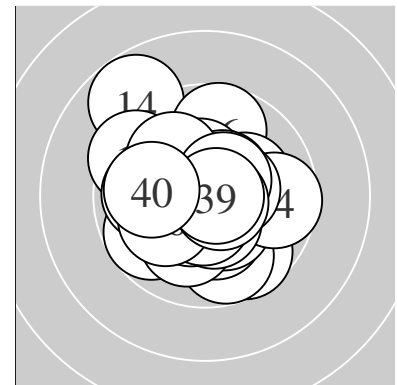

Serie 1:	9.7 ↘	10.4 *	10.6 *	9.8 ↘	10.8 *
	10.3 *	9.7 ↙	10.0 ↘	10.3 *	10.5 *
beste Teiler	50.6 (5.)	93.0 (3.)	120.2 (10.)		
Trefferlage	0.17 mm links, 0.74 mm tief				
Streuwert	1.45, horizontal: 1.43, vertikal: 1.47				

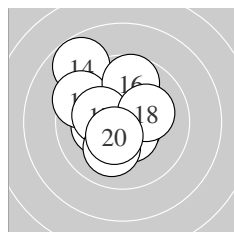

Serie 2:	10.2 *	10.6 *	10.5 *	8.8 ↘	9.5 ↘
	9.7 ↑	10.2 *	10.2 *	10.1 ↓	10.5 *
beste Teiler	89.1 (12.)	107.0 (13.)	124.3 (20.)		
Trefferlage	0.76 mm links, 0.58 mm hoch				
Streuwert	1.87, horizontal: 1.74, vertikal: 1.98				

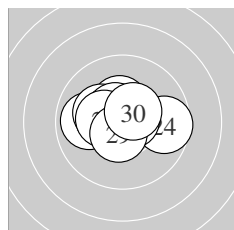

Serie 3:	9.9 ←	10.4 *	10.2 *	9.7 →	10.7 *
	10.5 *	10.5 *	10.4 *	10.6 *	10.5 *
beste Teiler	67.7 (25.)	94.5 (29.)	102.0 (27.)		
Trefferlage	0.30 mm links, 0.38 mm hoch				
Streuwert	1.23, horizontal: 1.62, vertikal: 0.64				

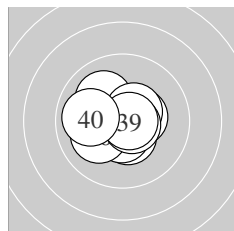

Serie 4:	10.6 *	10.5 *	10.4 *	10.1 ↘	10.5 *
	10.1 ↙	10.5 *	10.6 *	10.7 *	9.9 ←
beste Teiler	52.0 (39.)	78.9 (38.)	92.4 (31.)		
Trefferlage	0.13 mm links, 0.00 mm				
Streuwert	1.13, horizontal: 1.32, vertikal: 0.91				

Unterschrift des Schützen

Ergebnis: **382** (396.5)  
 Serien: 97 96 94 95  
 Zähler: 23 16 1 0 0 0 0 0 0 0  
 Innenzehner: 13  
 weiteste: 626 (25), 494 (16), 454 (7)  
 beste Teiler 58.6 (8.) 65.1 (17.) 91.8 (1.)  
 Trefferlage 0.38 mm links, 0.67 mm hoch  
 Streuwert 2.01, horizontal: 2.34, vertikal: 1.60

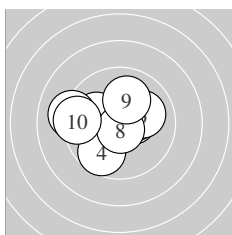
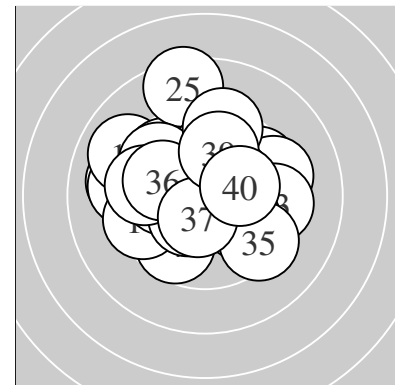

Serie 1:  
 10.6 \*                      10.0 ↖                      10.5 \*                      9.7 ↘                      10.4 \*  
 10.1 ↗                      9.1 ↖                      10.7 \*                      10.0 ↑                      9.4 ↖  
 beste Teiler 58.6 (8.) 91.8 (1.) 124.5 (3.)  
 Trefferlage 0.63 mm links, 0.30 mm hoch  
 Streuwert 1.85, horizontal: 2.30, vertikal: 1.25

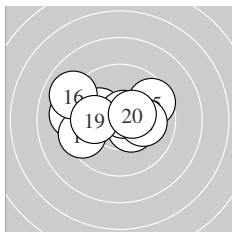

Serie 2:  
 9.2 ↖                      10.4 \*                      10.1 ↖                      9.5 ↖                      9.6 ↗  
 9.0 ↖                      10.7 \*                      10.1 →                      10.0 ←                      10.4 \*  
 beste Teiler 65.1 (17.) 131.0 (20.) 132.3 (12.)  
 Trefferlage 0.86 mm links, 0.42 mm hoch  
 Streuwert 2.09, horizontal: 2.76, vertikal: 1.07

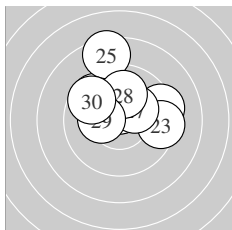

Serie 3:  
 9.3 →                      10.6 \*                      9.4 →                      9.7 ↘                      8.4 ↑  
 10.0 ↘                      10.3 \*                      10.0 ↑                      10.3 \*                      9.7 ↘  
 beste Teiler 93.0 (22.) 170.1 (29.) 174.8 (27.)  
 Trefferlage 0.02 mm links, 1.67 mm hoch  
 Streuwert 2.12, horizontal: 2.41, vertikal: 1.80

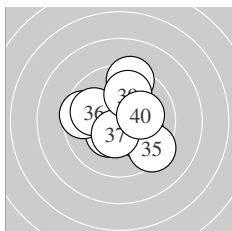

Serie 4:  
 10.4 \*                      9.6 ↖                      10.0 ↘                      10.2 \*                      9.4 ↘  
 9.9 ↖                      10.4 \*                      9.4 ↑                      9.9 ↑                      10.1 →  
 beste Teiler 126.8 (37.) 150.4 (31.) 189.9 (34.)  
 Trefferlage 0.01 mm links, 0.28 mm hoch  
 Streuwert 2.02, horizontal: 2.11, vertikal: 1.91

Unterschrift des Schützen

Meyton Elektronik

Ergebnis: **390** (407.4)  
 Serien: 99 97 97 97  
 Zähler: 30 10 0 0 0 0 0 0 0 0  
 Innenzehner: 24  
 weiteste: 460 (14), 427 (17), 408 (40)  
 beste Teiler 30.1 (18.) 48.1 (3.) 61.2 (23.)  
 Trefferlage 0.15 mm links, 0.00 mm  
 Streuwert 1.60, horizontal: 1.46, vertikal: 1.74

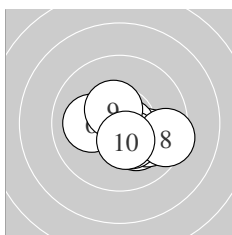
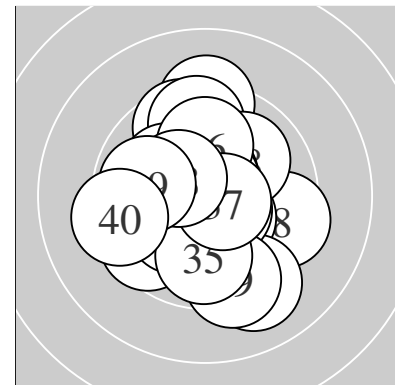

Serie 1:  
 10.6 \*                      10.2 \*                      10.8 \*                      10.0 ↘                      10.7 \*  
 10.1 ←                      10.3 \*                      9.5 →                      10.5 \*                      10.4 \*  
 beste Teiler 48.1 (3.) 64.6 (5.) 77.8 (1.)  
 Trefferlage 0.51 mm rechts, 0.50 mm tief  
 Streuwert 1.29, horizontal: 1.59, vertikal: 0.88

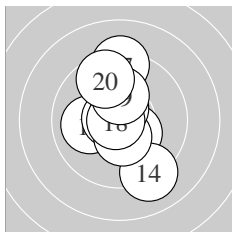

Serie 2:  
 10.4 \*                      10.0 ←                      10.7 \*                      9.1 ↘                      10.4 \*  
 10.6 \*                      9.2 ↑                      10.8 \*                      10.2 \*                      9.6 ↗  
 beste Teiler 30.1 (18.) 70.2 (13.) 89.0 (16.)  
 Trefferlage 0.07 mm links, 0.36 mm hoch  
 Streuwert 1.88, horizontal: 1.21, vertikal: 2.36

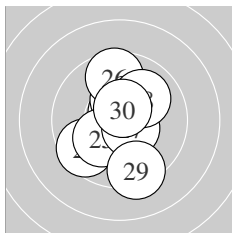

Serie 3:  
 10.7 \*                      9.6 ↙                      10.7 \*                      10.3 \*                      10.2 \*  
 9.6 ↑                      10.5 \*                      10.0 ↗                      9.3 ↓                      10.6 \*  
 beste Teiler 61.2 (23.) 66.7 (21.) 93.8 (30.)  
 Trefferlage 0.00 mm , 0.03 mm hoch  
 Streuwert 1.74, horizontal: 1.28, vertikal: 2.09

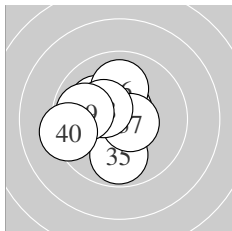

Serie 4:  
 10.5 \*                      10.1 ↘                      10.5 \*                      10.7 \*                      9.8 ↓  
 10.0 ↑                      10.6 \*                      10.4 \*                      9.9 ←                      9.3 ←  
 beste Teiler 75.0 (34.) 86.3 (37.) 104.6 (33.)  
 Trefferlage 1.04 mm links, 0.12 mm hoch  
 Streuwert 1.42, horizontal: 1.45, vertikal: 1.40

Unterschrift des Schützen

Meyton Elektronik

Ergebnis:	<b>374</b>	(393.9)
Serien:	93 93 93 95	
Zähler:	17 20 3 0 0 0 0 0 0 0	
Innenzehner:	11	
weiteste:	667 (31), 549 (8), 513 (23)	
beste Teiler	76.4 (24.) 91.6 (6.) 109.0 (11.)	
Trefferlage	0.82 mm rechts, 0.36 mm tief	
Streuwert	2.08, horizontal: 2.58, vertikal: 1.40	

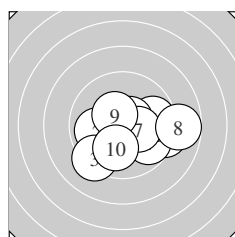
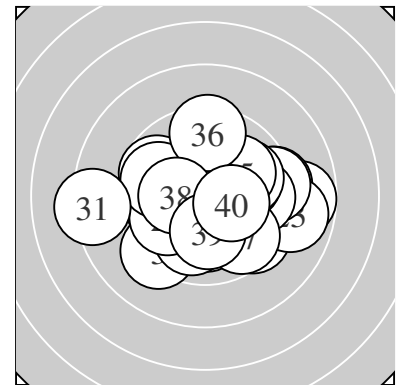

Serie 1:	9.3 →	9.9 ←	9.3 ↙	9.8 ↘	9.7 →
	10.6 *	10.3 *	8.8 →	10.4 *	10.0 ↓
beste Teiler	91.6 (6.)	130.2 (9.)	158.1 (7.)		
Trefferlage	1.06 mm rechts, 0.69 mm tief				
Streuwert	2.17, horizontal: 2.76, vertikal: 1.35				

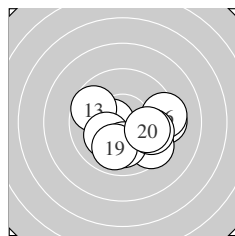

Serie 2:	10.5 *	9.3 →	9.7 ↖	10.1 ↗	9.5 ↘
	9.3 →	10.1 ↓	9.8 →	9.9 ↓	9.9 →
beste Teiler	109.0 (11.)	202.7 (14.)	222.2 (17.)		
Trefferlage	1.00 mm rechts, 0.78 mm tief				
Streuwert	2.01, horizontal: 2.52, vertikal: 1.30				

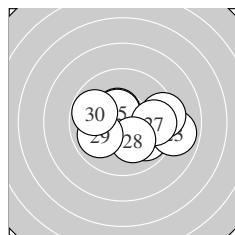

Serie 3:	10.5 *	9.9 ↘	8.9 →	10.6 *	10.5 *
	9.3 →	9.7 →	10.2 *	9.9 ↙	9.8 ↖
beste Teiler	76.4 (24.)	110.9 (25.)	119.0 (21.)		
Trefferlage	0.85 mm rechts, 0.21 mm tief				
Streuwert	2.02, horizontal: 2.63, vertikal: 1.11				

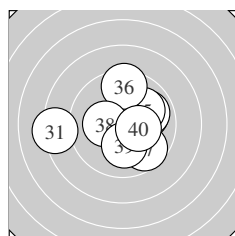

Serie 4:	8.3 ←	10.0 →	10.3 *	9.9 →	10.0 ↗
	9.5 ↑	9.7 ↘	10.3 *	10.1 ↓	10.3 *
beste Teiler	155.3 (33.)	160.8 (40.)	169.0 (38.)		
Trefferlage	0.36 mm rechts, 0.21 mm hoch				
Streuwert	2.32, horizontal: 2.77, vertikal: 1.76				

Unterschrift des Schützen

Meyton Elektronik

Ergebnis: **380** (399.9)  
 Serien: 95 98 93 94  
 Zähler: 21 18 1 0 0 0 0 0 0 0  
 Innenzehner: 18  
 weiteste: 577 (28), 437 (14), 433 (30)  
 beste Teiler 67.1 (37.) 67.6 (17.) 71.8 (40.)  
 Trefferlage 0.20 mm links, 0.31 mm hoch  
 Streuwert 1.90, horizontal: 2.33, vertikal: 1.33

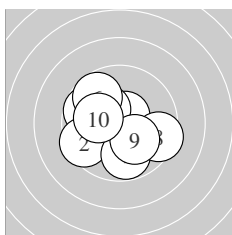
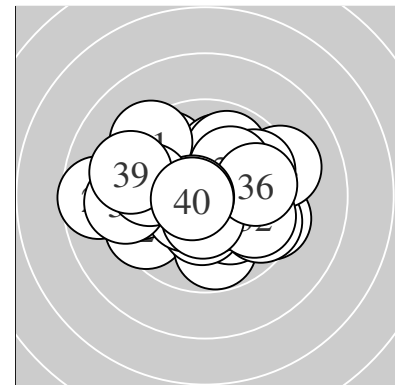

Serie 1:  
 9.7 ↖ 9.5 ↖ 10.4 \* 10.6 \* 10.2 \*  
 9.7 ↘ 9.8 ↓ 9.5 → 10.2 \* 10.2 \*  
 beste Teiler 81.2 (4.) 127.9 (3.) 176.0 (5.)  
 Trefferlage 0.43 mm links, 0.23 mm tief  
 Streuwert 1.90, horizontal: 2.15, vertikal: 1.63

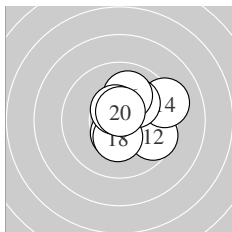

Serie 2:  
 10.2 \* 9.6 → 10.5 \* 9.2 → 10.1 ↗  
 10.0 ↑ 10.7 \* 10.3 \* 10.5 \* 10.6 \*  
 beste Teiler 67.6 (17.) 78.3 (20.) 103.0 (19.)  
 Trefferlage 0.98 mm rechts, 0.47 mm hoch  
 Streuwert 1.45, horizontal: 1.55, vertikal: 1.34

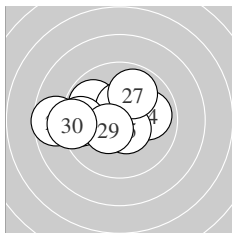

Serie 3:  
 9.8 ↖ 10.3 \* 10.5 \* 9.9 → 10.6 \*  
 9.5 ← 9.9 ↑ 8.6 ← 10.4 \* 9.2 ←  
 beste Teiler 100.6 (25.) 120.2 (23.) 127.6 (29.)  
 Trefferlage 1.16 mm links, 0.44 mm hoch  
 Streuwert 2.06, horizontal: 2.72, vertikal: 1.05

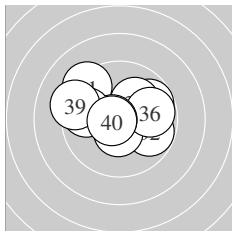

Serie 4:  
 9.3 ↖ 9.8 → 9.8 ↗ 10.1 ↗ 10.5 \*  
 9.8 → 10.7 \* 9.7 ← 9.3 ↖ 10.7 \*  
 beste Teiler 67.1 (37.) 71.8 (40.) 116.6 (35.)  
 Trefferlage 0.19 mm links, 0.58 mm hoch  
 Streuwert 2.01, horizontal: 2.55, vertikal: 1.26

Unterschrift des Schützen

Meyton Elektronik

Ergebnis: **375** (394.0)  
 Serien: 90 94 96 95  
 Zähler: 18 19 3 0 0 0 0 0 0 0  
 Innenzehner: 12  
 weiteste: 550 (32), 536 (16), 534 (4)  
 beste Teiler 72.2 (20.) 77.4 (12.) 111.1 (14.)  
 Trefferlage 0.25 mm rechts, 0.44 mm tief  
 Streuwert 2.13, horizontal: 2.40, vertikal: 1.84

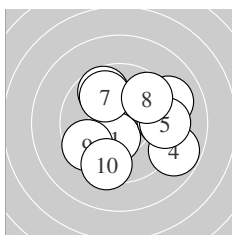
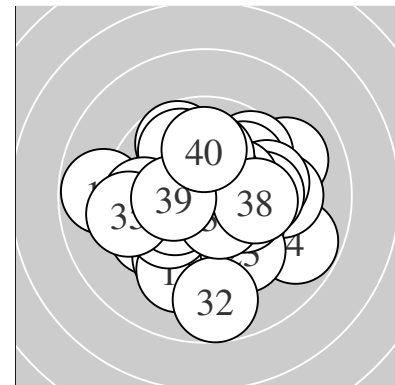

Serie 1:  
 10.4 \* 9.4 → 9.1 → 8.8 ↘ 9.4 →  
 9.7 ↘ 9.9 ↘ 9.6 ↗ 9.6 ↖ 9.4 ↓  
 beste Teiler 133.4 (1.) 268.9 (7.) 311.3 (6.)  
 Trefferlage 1.21 mm rechts, 0.03 mm hoch  
 Streuwert 2.60, horizontal: 2.90, vertikal: 2.26

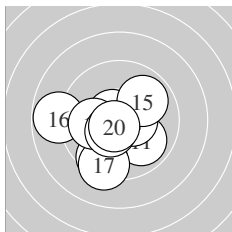

Serie 2:  
 9.9 ↘ 10.6 \* 9.5 ↓ 10.5 \* 9.9 ↗  
 8.8 ← 9.3 ↓ 10.0 ← 10.4 \* 10.7 \*  
 beste Teiler 72.2 (20.) 77.4 (12.) 111.1 (14.)  
 Trefferlage 0.74 mm links, 0.84 mm tief  
 Streuwert 1.96, horizontal: 2.18, vertikal: 1.70

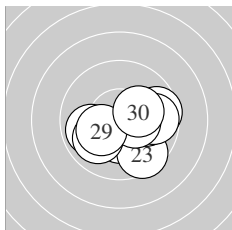

Serie 3:  
 9.9 ← 10.3 \* 9.6 ↘ 10.0 → 10.0 ↗  
 9.6 → 9.8 → 10.4 \* 10.2 \* 10.2 \*  
 beste Teiler 138.6 (28.) 155.0 (22.) 181.7 (29.)  
 Trefferlage 0.76 mm rechts, 0.64 mm tief  
 Streuwert 1.70, horizontal: 2.11, vertikal: 1.14

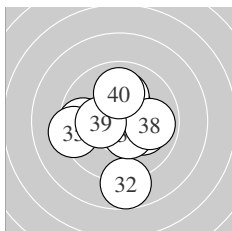

Serie 4:  
 10.1 ↘ 8.8 ↓ 9.7 ← 10.5 \* 9.3 ←  
 10.4 \* 10.1 ↑ 9.9 → 10.3 \* 10.0 ↑  
 beste Teiler 123.3 (34.) 131.8 (36.) 166.4 (39.)  
 Trefferlage 0.20 mm links, 0.32 mm tief  
 Streuwert 2.17, horizontal: 2.14, vertikal: 2.19

Unterschrift des Schützen

Meyton Elektronik



Ergebnis: **390** (408.7)  
 Serien: 99 96 97 98  
 Zähler: 30 10 0 0 0 0 0 0 0 0  
 Innenzehner: 27  
 weiteste: 474 (24), 404 (12), 403 (19)  
 beste Teiler 51.8 (2.) 53.0 (38.) 53.7 (17.)  
 Trefferlage 0.03 mm rechts, 0.52 mm hoch  
 Streuwert 1.46, horizontal: 1.34, vertikal: 1.58

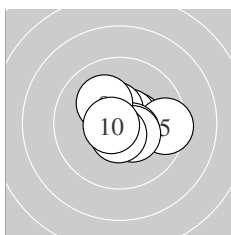
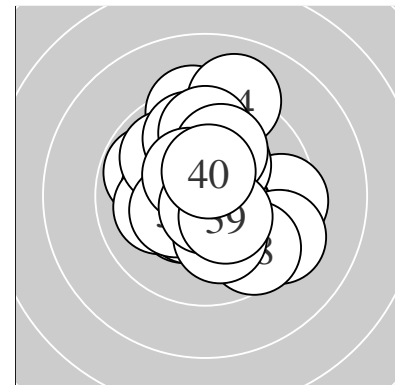

Serie 1:  
 10.5 \*                      10.7 \*                      10.6 \*                      10.5 \*                      9.5 →  
 10.5 \*                      10.4 \*                      10.2 \*                      10.6 \*                      10.7 \*  
 beste Teiler 51.8 (2.) 68.4 (10.) 84.6 (3.)  
 Trefferlage 0.56 mm rechts, 0.07 mm hoch  
 Streuwert 1.11, horizontal: 1.34, vertikal: 0.82

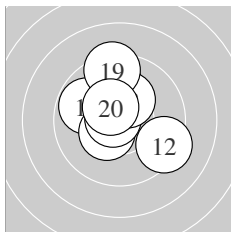

Serie 2:  
 9.9 ↑                      9.3 ↘                      10.3 \*                      9.8 ↖                      10.5 \*  
 10.4 \*                      10.7 \*                      10.3 \*                      9.3 ↑                      10.4 \*  
 beste Teiler 53.7 (17.) 122.3 (15.) 126.4 (20.)  
 Trefferlage 0.11 mm links, 1.04 mm hoch  
 Streuwert 1.64, horizontal: 1.57, vertikal: 1.70

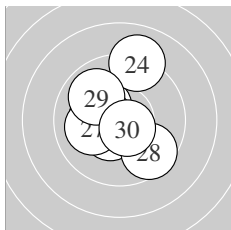

Serie 3:  
 10.6 \*                      10.2 \*                      10.3 \*                      9.1 ↑                      10.5 \*  
 10.5 \*                      10.1 ←                      9.6 ↘                      9.9 ↖                      10.6 \*  
 beste Teiler 88.4 (30.) 93.2 (21.) 103.0 (26.)  
 Trefferlage 0.39 mm links, 0.22 mm hoch  
 Streuwert 1.73, horizontal: 1.53, vertikal: 1.92

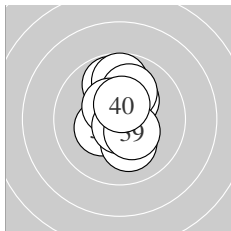

Serie 4:  
 10.3 \*                      9.8 ↑                      9.7 ↑                      10.0 ↑                      10.3 \*  
 10.1 ↓                      10.4 \*                      10.7 \*                      10.4 \*                      10.5 \*  
 beste Teiler 53.0 (38.) 118.2 (40.) 126.4 (37.)  
 Trefferlage 0.06 mm rechts, 0.74 mm hoch  
 Streuwert 1.33, horizontal: 0.81, vertikal: 1.69

Unterschrift des Schützen

Meyton Elektronik

Ergebnis: **392** (409.8)  
 Serien: 100 97 97 98  
 Zähler: 32 8 0 0 0 0 0 0 0 0  
 Innenzehner: 26  
 weiteste: 388 (28), 355 (20), 334 (27)  
 beste Teiler 19.6 (13.) 43.0 (37.) 54.5 (19.)  
 Trefferlage 0.16 mm rechts, 0.23 mm hoch  
 Streuwert 1.41, horizontal: 1.55, vertikal: 1.26

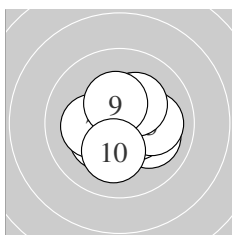
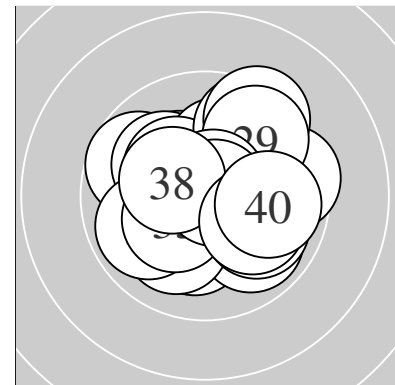

Serie 1:  
 10.3 \*                      10.3 \*                      10.1 ↘                      10.5 \*                      10.1 →  
 10.5 \*                      10.2 \*                      10.3 \*                      10.4 \*                      10.2 \*  
 beste Teiler 109.7 (6.) 113.5 (4.) 141.7 (9.)  
 Trefferlage 0.23 mm rechts, 0.04 mm tief  
 Streuwert 1.29, horizontal: 1.44, vertikal: 1.12

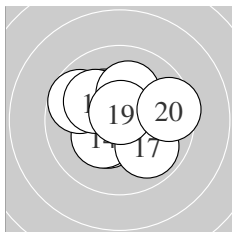

Serie 2:  
 10.4 \*                      10.3 \*                      10.9 \*                      10.3 \*                      9.7 ↖  
 10.1 ↖                      9.9 ↘                      10.2 \*                      10.7 \*                      9.5 →  
 beste Teiler 19.6 (13.) 54.5 (19.) 140.2 (11.)  
 Trefferlage 0.14 mm links, 0.32 mm hoch  
 Streuwert 1.57, horizontal: 1.82, vertikal: 1.27

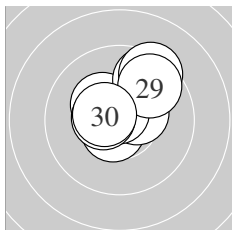

Serie 3:  
 10.6 \*                      10.5 \*                      10.4 \*                      10.7 \*                      10.3 \*  
 10.5 \*                      9.6 ↗                      9.4 ↗                      9.7 ↗                      10.5 \*  
 beste Teiler 57.9 (24.) 82.9 (21.) 110.8 (22.)  
 Trefferlage 0.39 mm rechts, 1.13 mm hoch  
 Streuwert 1.32, horizontal: 1.37, vertikal: 1.27

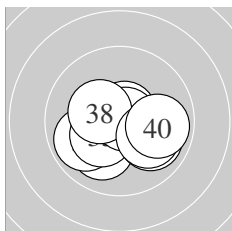

Serie 4:  
 10.1 ↙                      9.9 ↖                      10.7 \*                      10.0 ↘                      10.3 \*  
 10.7 \*                      10.8 \*                      10.3 \*                      10.0 ↘                      9.9 →  
 beste Teiler 43.0 (37.) 56.0 (33.) 64.6 (36.)  
 Trefferlage 0.16 mm rechts, 0.49 mm tief  
 Streuwert 1.37, horizontal: 1.72, vertikal: 0.91

Unterschrift des Schützen

Ergebnis:	<b>388</b>	(405.0)			
Serien:	96	98	96	98	
Zähler:	28	12	0	0	0 0 0 0 0 0
Innenzehner:	22				
weiteste:	401 (26), 397 (36), 392 (27)				
beste Teiler	34.6 (38.) 34.7 (12.) 44.2 (22.)				
Trefferlage	0.32 mm rechts, 0.25 mm hoch				
Streuwert	1.61, horizontal: 1.69, vertikal: 1.54				

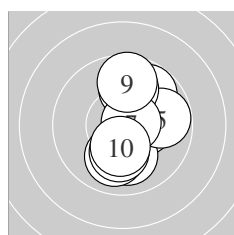
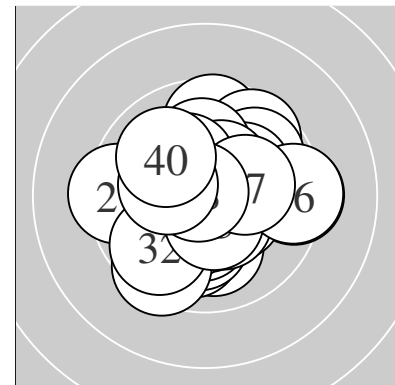

Serie 1:	9.8 ↗	10.3 *	10.0 ↓	10.0 ↓	9.8 →
	9.9 ↑	10.7 *	10.1 ↓	9.7 ↑	10.3 *
beste Teiler	67.3 (7.) 153.0 (2.) 160.0 (10.)				
Trefferlage	0.70 mm rechts, 0.07 mm hoch				
Streuwert	1.68, horizontal: 1.08, vertikal: 2.12				

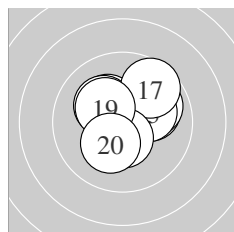

Serie 2:	10.1 →	10.8 *	10.3 *	9.9 ↗	10.2 *
	10.2 *	9.6 ↗	10.5 *	10.3 *	10.2 *
beste Teiler	34.7 (12.) 119.1 (18.) 170.4 (19.)				
Trefferlage	0.32 mm rechts, 0.61 mm hoch				
Streuwert	1.42, horizontal: 1.57, vertikal: 1.24				

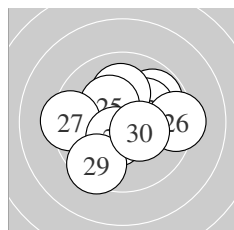

Serie 3:	9.8 ↗	10.8 *	10.2 *	10.1 ↑	10.3 *
	9.3 →	9.4 ←	10.5 *	9.5 ↘	10.4 *
beste Teiler	44.2 (22.) 121.2 (28.) 144.0 (30.)				
Trefferlage	0.18 mm rechts, 0.18 mm hoch				
Streuwert	1.93, horizontal: 2.25, vertikal: 1.55				

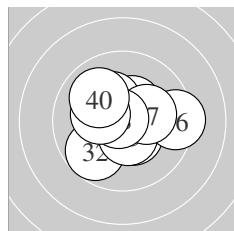

Serie 4:	10.4 *	9.7 ↘	10.3 *	10.4 *	10.5 *
	9.4 →	10.2 *	10.8 *	10.3 *	10.0 ↘
beste Teiler	34.6 (38.) 116.1 (35.) 132.4 (34.)				
Trefferlage	0.10 mm rechts, 0.13 mm hoch				
Streuwert	1.59, horizontal: 1.86, vertikal: 1.26				

Unterschrift des Schützen

Ergebnis: **392** (409.1)  
 Serien: 98 98 97 99  
 Zähler: 32 8 0 0 0 0 0 0 0 0  
 Innenzehner: 24  
 weiteste: 353 (28), 315 (21), 304 (34)  
 beste Teiler 8.0 (40.) 48.5 (24.) 51.0 (32.)  
 Trefferlage 0.43 mm links, 0.36 mm tief  
 Streuwert 1.36, horizontal: 1.21, vertikal: 1.49

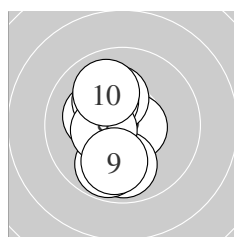
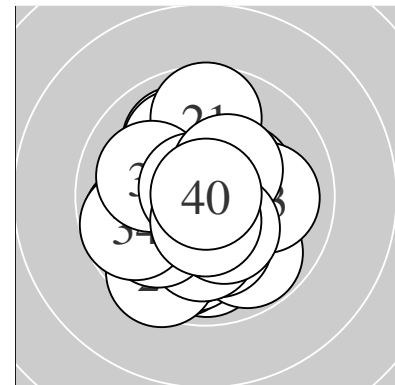

Serie 1:  
 10.2 \*                      10.6 \*                      10.2 \*                      9.9 ↓                      9.8 ↙  
 10.2 \*                      10.2 \*                      10.4 \*                      10.0 ↓                      10.0 ↖  
 beste Teiler 78.2 (2.) 131.2 (8.) 179.5 (1.)  
 Trefferlage 0.81 mm links, 0.13 mm tief  
 Streuwert 1.43, horizontal: 0.79, vertikal: 1.86

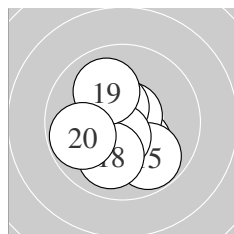

Serie 2:  
 10.7 \*                      10.5 \*                      10.3 \*                      10.7 \*                      9.8 ↘  
 10.5 \*                      10.5 \*                      10.0 ↓                      10.0 ↗                      9.8 ←  
 beste Teiler 61.5 (14.) 69.4 (11.) 102.4 (17.)  
 Trefferlage 0.38 mm links, 0.48 mm tief  
 Streuwert 1.31, horizontal: 1.23, vertikal: 1.38

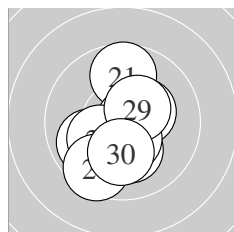

Serie 3:  
 9.7 ↑                      10.2 \*                      10.3 \*                      10.8 \*                      9.9 ↙  
 10.5 \*                      10.2 \*                      9.5 ↓                      10.4 \*                      10.1 ↓  
 beste Teiler 48.5 (24.) 118.3 (26.) 135.2 (29.)  
 Trefferlage 0.18 mm links, 0.56 mm tief  
 Streuwert 1.54, horizontal: 1.23, vertikal: 1.80

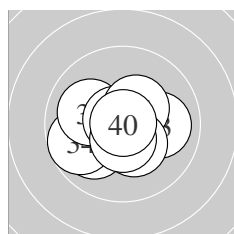

Serie 4:  
 10.0 ↙                      10.7 \*                      10.0 →                      9.7 ↙                      10.0 ↖  
 10.7 \*                      10.4 \*                      10.3 \*                      10.5 \*                      10.9 \*  
 beste Teiler 8.0 (40.) 51.0 (32.) 53.8 (36.)  
 Trefferlage 0.36 mm links, 0.28 mm tief  
 Streuwert 1.29, horizontal: 1.58, vertikal: 0.90

Unterschrift des Schützen

Meyton Elektronik

Ergebnis:	<b>386</b>	(405.0)
Serien:	97 96 97 96	
Zähler:	26 14 0 0 0 0 0 0 0 0	
Innenzehner:	22	
weiteste:	417 (8), 391 (37), 384 (26)	
beste Teiler	23.7 (35.) 52.0 (31.) 59.4 (16.)	
Trefferlage	0.11 mm links, 0.23 mm hoch	
Streuwert	1.66, horizontal: 1.86, vertikal: 1.44	

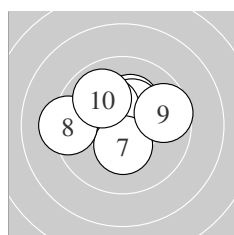
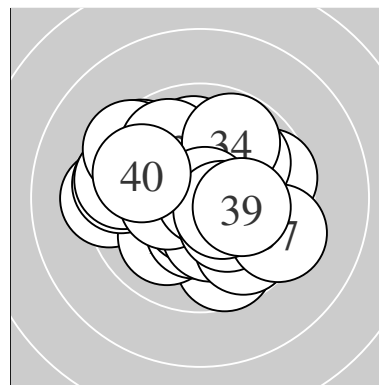

Serie 1:	10.5 *	10.3 *	10.1 ↘	10.5 *	10.4 *
	10.3 *	10.3 *	9.3 ←	9.6 →	9.9 ↘
beste Teiler	106.7 (4.)	115.6 (1.)	147.7 (5.)		
Trefferlage	0.49 mm links, 0.91 mm hoch				
Streuwert	1.52, horizontal: 1.90, vertikal: 1.01				

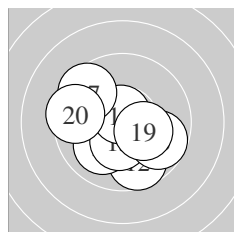

Serie 2:	10.6 *	9.7 ↓	10.6 *	10.0 ↗	10.4 *
	10.7 *	9.5 ↘	9.7 ↘	10.3 *	9.5 ←
beste Teiler	59.4 (16.)	92.6 (13.)	100.8 (11.)		
Trefferlage	0.28 mm links, 0.61 mm tief				
Streuwert	1.72, horizontal: 1.94, vertikal: 1.46				

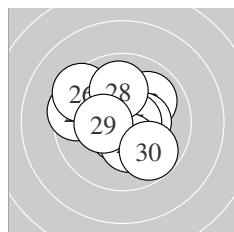

Serie 3:	9.5 ←	10.6 *	10.0 ↗	10.4 *	10.7 *
	9.4 ↘	10.3 *	10.0 ↑	10.4 *	9.8 ↓
beste Teiler	74.0 (25.)	83.7 (22.)	147.4 (29.)		
Trefferlage	0.21 mm links, 0.24 mm hoch				
Streuwert	1.77, horizontal: 1.96, vertikal: 1.55				

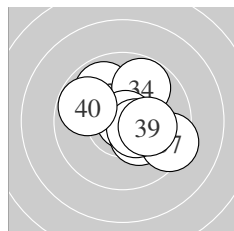

Serie 4:	10.7 *	10.2 *	9.9 ↘	9.8 ↗	10.9 *
	10.3 *	9.4 ↘	10.5 *	10.2 *	9.8 ←
beste Teiler	23.7 (35.)	52.0 (31.)	115.8 (38.)		
Trefferlage	0.52 mm rechts, 0.40 mm hoch				
Streuwert	1.61, horizontal: 1.77, vertikal: 1.44				

Unterschrift des Schützen

Ergebnis: **386** (404.2)  
 Serien: 96 100 95 95  
 Zähler: 27 12 1 0 0 0 0 0 0 0  
 Innenzehner: 24  
 weiteste: 679 (29), 388 (6), 387 (3)  
 beste Teiler 43.2 (8.) 56.0 (12.) 56.8 (17.)  
 Trefferlage 0.54 mm rechts, 0.33 mm hoch  
 Streuwert 1.75, horizontal: 2.04, vertikal: 1.40

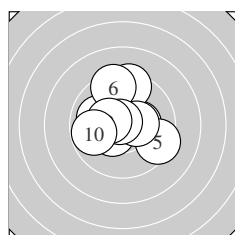
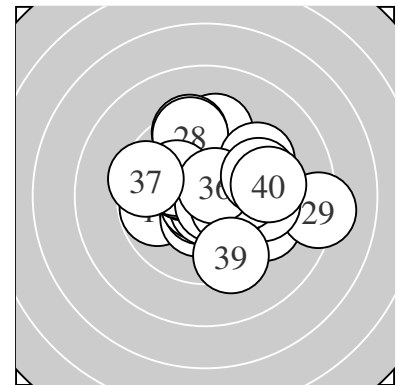

Serie 1:  
 10.0 ↖ 10.3 \* 9.4 ↑ 10.4 \* 9.4 ↘  
 9.4 ↑ 10.4 \* 10.8 \* 10.4 \* 9.8 ←  
 beste Teiler 43.2 (8.) 130.5 (4.) 138.7 (7.)  
 Trefferlage 0.16 mm links, 0.61 mm hoch  
 Streuwert 1.88, horizontal: 1.94, vertikal: 1.82

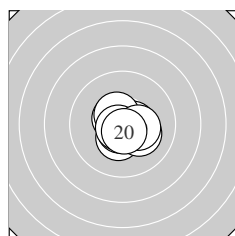

Serie 2:  
 10.6 \* 10.7 \* 10.4 \* 10.5 \* 10.7 \*  
 10.5 \* 10.7 \* 10.2 \* 10.3 \* 10.7 \*  
 beste Teiler 56.0 (12.) 56.8 (17.) 68.5 (15.)  
 Trefferlage 0.18 mm rechts, 0.33 mm tief  
 Streuwert 0.79, horizontal: 0.89, vertikal: 0.69

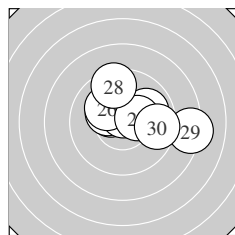

Serie 3:  
 10.4 \* 10.3 \* 10.3 \* 9.9 ↗ 10.7 \*  
 10.1 ↖ 10.3 \* 9.5 ↑ 8.2 → 9.6 →  
 beste Teiler 68.2 (25.) 138.6 (21.) 151.3 (27.)  
 Trefferlage 1.05 mm rechts, 0.81 mm hoch  
 Streuwert 2.05, horizontal: 2.64, vertikal: 1.20

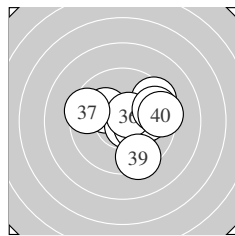

Serie 4:  
 10.2 \* 10.7 \* 10.4 \* 10.0 → 9.5 ↗  
 10.6 \* 9.5 ← 9.6 → 9.4 ↓ 9.4 →  
 beste Teiler 66.4 (32.) 84.1 (36.) 149.5 (33.)  
 Trefferlage 1.11 mm rechts, 0.22 mm hoch  
 Streuwert 1.95, horizontal: 2.28, vertikal: 1.55

Unterschrift des Schützen

Ergebnis: **375** (393.8)  
 Serien: 89 97 95 94  
 Zähler: 20 16 3 1 0 0 0 0 0 0  
 Innenzehner: 13  
 weiteste: 814 (7), 607 (10), 541 (32)  
 beste Teiler 89.7 (26.) 95.7 (5.) 97.0 (40.)  
 Trefferlage 0.02 mm links, 0.49 mm tief  
 Streuwert 2.24, horizontal: 2.43, vertikal: 2.03

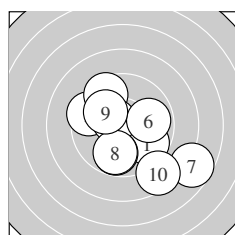
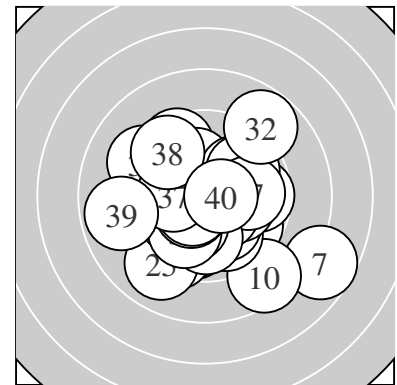

Serie 1:  
 9.7 ↘                      9.5 ←                      9.8 ↓                      9.5 ↖                      10.6 \*  
 9.9 →                      7.7 ↘                      9.8 ↓                      10.1 ↖                      8.5 ↘  
 beste Teiler 95.7 (5.) 220.2 (9.) 269.4 (6.)  
 Trefferlage 0.66 mm rechts, 0.98 mm tief  
 Streuwert 2.93, horizontal: 3.19, vertikal: 2.64

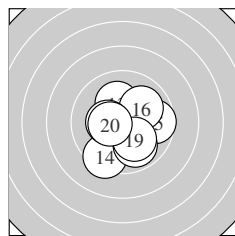

Serie 2:  
 10.0 ↗                      10.4 \*                      10.2 \*                      9.4 ↓                      9.7 →  
 10.0 ↗                      9.9 ↘                      10.3 \*                      10.1 ↘                      10.4 \*  
 beste Teiler 129.4 (20.) 137.1 (12.) 152.0 (18.)  
 Trefferlage 0.55 mm rechts, 0.32 mm tief  
 Streuwert 1.73, horizontal: 1.71, vertikal: 1.74

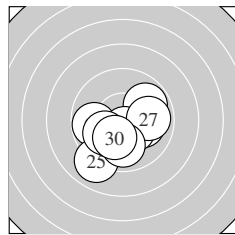

Serie 3:  
 10.1 →                      9.8 ←                      10.4 \*                      9.8 ↗                      9.0 ↓  
 10.6 \*                      9.9 →                      9.9 ↓                      10.1 ↖                      10.2 \*  
 beste Teiler 89.7 (26.) 147.8 (23.) 194.6 (30.)  
 Trefferlage 0.01 mm rechts, 1.09 mm tief  
 Streuwert 1.79, horizontal: 2.03, vertikal: 1.52

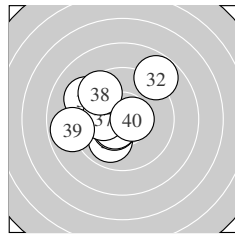

Serie 4:  
 10.0 ↓                      8.8 ↗                      10.2 \*                      10.5 \*                      9.2 ↖  
 10.5 \*                      10.2 \*                      9.6 ↖                      8.9 ←                      10.6 \*  
 beste Teiler 97.0 (40.) 111.0 (36.) 125.3 (34.)  
 Trefferlage 1.34 mm links, 0.42 mm hoch  
 Streuwert 2.17, horizontal: 2.36, vertikal: 1.96

Unterschrift des Schützen

Meyton Elektronik

Ergebnis: **385** (401.5)  
 Serien: 95 99 95 96  
 Zähler: 26 13 1 0 0 0 0 0 0 0  
 Innenzehner: 20  
 weiteste: 637 (7), 491 (5), 487 (4)  
 beste Teiler 5.0 (20.) 53.9 (35.) 64.1 (11.)  
 Trefferlage 0.71 mm links, 0.14 mm hoch  
 Streuwert 1.86, horizontal: 1.97, vertikal: 1.75

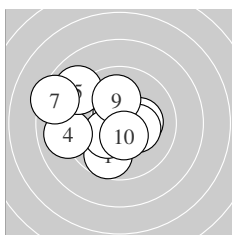
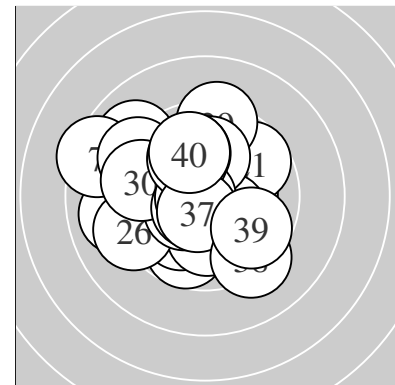

Serie 1:  
 9.7 ↙ 10.5 \* 10.4 \* 9.0 ← 9.0 ↘  
 10.2 \* 8.4 ↖ 10.3 \* 10.1 ↑ 10.5 \*  
 beste Teiler 107.0 (2.) 120.8 (10.) 149.4 (3.)  
 Trefferlage 1.35 mm links, 0.21 mm hoch  
 Streuwert 2.30, horizontal: 2.65, vertikal: 1.87

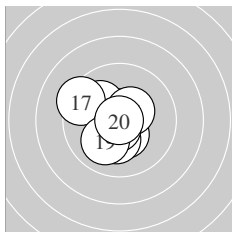

Serie 2:  
 10.7 \* 10.7 \* 10.4 \* 10.0 ↘ 10.4 \*  
 10.2 \* 9.4 ↖ 10.7 \* 10.0 ↙ 10.9 \*  
 beste Teiler 5.0 (20.) 64.1 (11.) 66.6 (12.)  
 Trefferlage 0.62 mm links, 0.05 mm tief  
 Streuwert 1.31, horizontal: 1.31, vertikal: 1.31

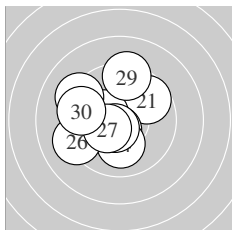

Serie 3:  
 9.7 ↗ 10.6 \* 10.3 \* 10.1 ↓ 10.6 \*  
 9.2 ← 10.4 \* 9.2 ↖ 9.3 ↑ 9.5 ←  
 beste Teiler 85.5 (25.) 93.3 (22.) 138.3 (27.)  
 Trefferlage 1.11 mm links, 0.30 mm hoch  
 Streuwert 2.04, horizontal: 2.11, vertikal: 1.98

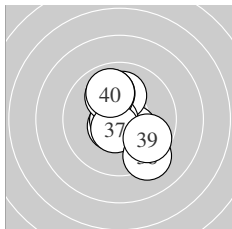

Serie 4:  
 10.3 \* 10.1 ↑ 9.9 ↗ 10.6 \* 10.7 \*  
 10.0 ↘ 10.6 \* 9.3 ↘ 9.7 ↘ 9.9 ↗  
 beste Teiler 53.9 (35.) 96.6 (37.) 98.4 (34.)  
 Trefferlage 0.22 mm rechts, 0.12 mm hoch  
 Streuwert 1.74, horizontal: 1.40, vertikal: 2.03

Unterschrift des Schützen

Meyton Elektronik