

Ergebnis: **389** (407.8)
 Serien: 95 98 98 98
 Zähler: 30 9 1 0 0 0 0 0 0 0
 Innenzehner: 27
 Weitester: 707 (6.), 472 (39.), 461 (25.)
 beste Teiler: 35.4 (24.), 35.5 (31.), 41.7 (2.)
 Trefferlage: 0.26 mm rechts, 0.28 mm tief
 Streuwert: 1.70, horizontal: 1.74, vertikal: 1.67

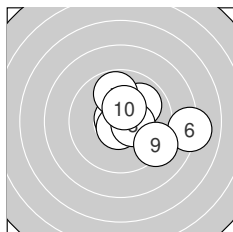
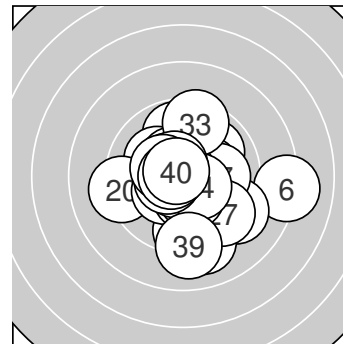

Serie 1: 95 (100.5)

10.5* →	10.8* ↑	10.7* ↘	9.9 ↗	10.7* ↓
8.1 →	9.8 ↑	10.4* →	9.2 ↘	10.4* ↑

beste Teiler: 41.7 (2.), 53.0 (3.), 66.1 (5.)
 Trefferlage: 1.41 mm rechts, 0.26 mm hoch
 Streuwert: 1.94, horizontal: 2.34, vertikal: 1.44

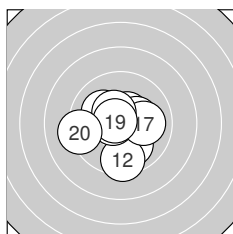

Serie 2: 98 (101.4)

10.0 ↓	9.5 ↓	10.1 ↘	10.6* ←	10.5* ↗
10.3* →	10.0 →	10.4* ↘	10.7* ↘	9.3 ←

beste Teiler: 61.8 (19.), 78.0 (14.), 115.6 (15.)
 Trefferlage: 0.20 mm links, 0.28 mm tief
 Streuwert: 1.71, horizontal: 1.85, vertikal: 1.55

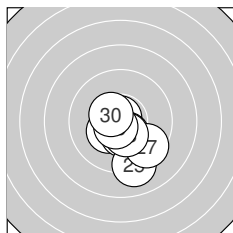

Serie 3: 98 (102.8)

10.7* ↘	10.3* ↗	10.4* ↓	10.8* ↑	9.1 ↓
10.4* ↓	9.5 ↘	10.4* ↓	10.7* ↗	10.5* ↘

beste Teiler: 35.4 (24.), 64.4 (21.), 75.1 (29.)
 Trefferlage: 0.20 mm rechts, 1.12 mm tief
 Streuwert: 1.35, horizontal: 1.17, vertikal: 1.52

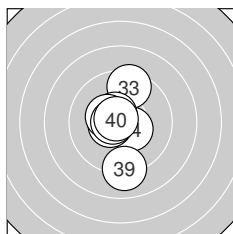

Serie 4: 98 (103.1)

10.8* ←	10.5* ↘	9.5 ↑	10.4* ↘	10.5* ←
10.6* ↘	10.4* ↘	10.6* ←	9.1 ↓	10.7* ↘

beste Teiler: 35.5 (31.), 57.2 (40.), 80.0 (38.)
 Trefferlage: 0.33 mm links, 0.00 mm
 Streuwert: 1.55, horizontal: 0.83, vertikal: 2.03



Ergebnis: 377 (395.2)
Serien: 92 96 94 95
Zähler: 20 17 3 0 0 0 0 0 0 0
Innenzehner: 16
Weiteste: 590 (25.), 580 (17.), 546 (40.)
beste Teiler: 56.5 (31.), 59.1 (12.), 108.6 (11.)
Trefferlage: 0.06 mm links, 0.16 mm hoch
Streuwert: 2.13, horizontal: 2.48, vertikal: 1.71

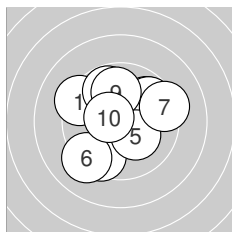
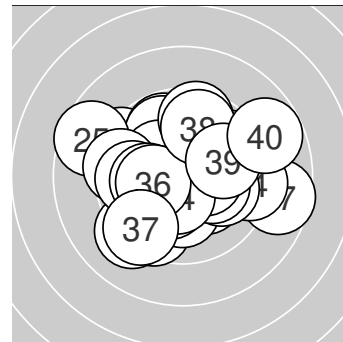

Serie 1: 92 (97.2)

9.3 ↖	9.5 ↙	9.8 ↗	9.7 ↗	10.2* ↘
9.2 ↙	9.3 →	9.8 ↘	9.9 ↑	10.5* ↖

beste Teiler: 110.6 (10.), 182.6 (5.), 264.2 (9.)
Trefferlage: 0.10 mm links, 0.47 mm hoch
Streuwert: 2.39, horizontal: 2.52, vertikal: 2.24

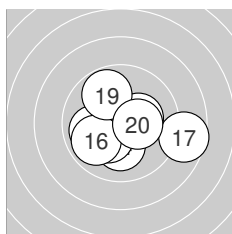

Serie 2: 96 (100.5)

10.5* ↘	10.7* ↓	10.0 ←	10.1 ↓	10.3* ↙
9.9 ↙	8.6 →	10.3* →	9.8 ↘	10.3* →

beste Teiler: 59.1 (12.), 108.6 (11.), 153.2 (20.)
Trefferlage: 0.16 mm rechts, 0.33 mm tief
Streuwert: 1.93, horizontal: 2.36, vertikal: 1.37

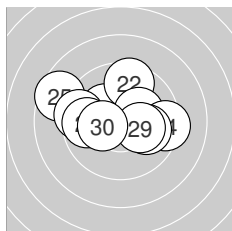

Serie 3: 94 (97.5)

10.2* ↘	9.6 ↑	10.2* ↗	9.3 →	8.6 ↖
9.4 ←	9.7 ←	10.0 →	10.2* →	10.3* ↖

beste Teiler: 167.3 (30.), 177.2 (21.), 180.7 (23.)
Trefferlage: 0.47 mm links, 0.58 mm hoch
Streuwert: 2.35, horizontal: 3.03, vertikal: 1.36

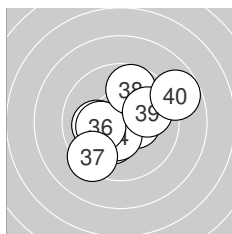

Serie 4: 95 (100.0)

10.7* ↙	10.3* ↙	10.4* →	10.5* ↓	10.1 ←
10.2* ←	9.4 ↙	9.7 ↑	9.9 →	8.8 ↗

beste Teiler: 56.5 (31.), 125.4 (34.), 133.5 (33.)
Trefferlage: 0.15 mm rechts, 0.07 mm tief
Streuwert: 2.05, horizontal: 2.29, vertikal: 1.79



Ergebnis: **388** (402.9)
 Serien: 97 96 97 98
 Zähler: 28 12 0 0 0 0 0 0 0 0
 Innenzehner: 20
 Weitester: 416 (29.), 412 (12.), 404 (39.)
 beste Teiler: 91.3 (37.), 102.5 (25.), 103.0 (11.)
 Trefferlage: 0.31 mm links, 0.06 mm tief
 Streuwert: 1.69, horizontal: 1.88, vertikal: 1.48

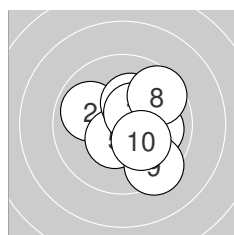
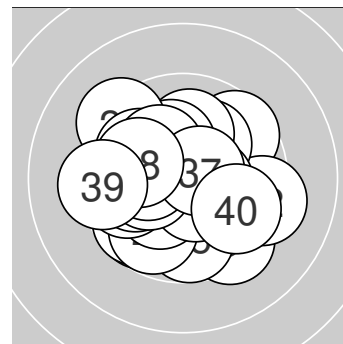

Serie 1: 97 (101.1)

10.3* →	9.9 ↖	10.0 →	10.4* ↗	10.5* ↘
10.3* ↑	10.5* ↗	9.6 ↗	9.4 ↘	10.2* ↘

beste Teiler: 120.2 (7.), 122.5 (5.), 132.2 (4.)
 Trefferlage: 0.92 mm rechts, 0.15 mm hoch
 Streuwert: 1.56, horizontal: 1.53, vertikal: 1.58

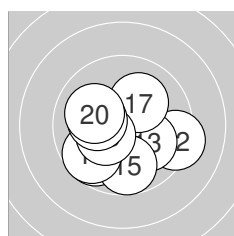

Serie 2: 96 (99.8)

10.5* →	9.3 →	10.1 ↘	9.7 ↘	9.8 ↓
9.7 ↘	10.1 ↗	10.4* ↖	10.2* ←	10.0 ↖

beste Teiler: 103.0 (11.), 148.5 (18.), 193.0 (19.)
 Trefferlage: 0.12 mm links, 0.78 mm tief
 Streuwert: 1.83, horizontal: 2.12, vertikal: 1.49

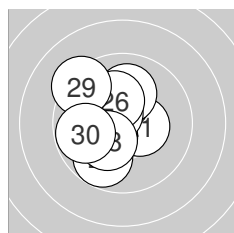

Serie 3: 97 (101.1)

10.4* →	10.4* ↘	10.3* ↑	10.1 ↑	10.5* ↖
10.2* ↖	9.8 ↘	10.3* ↘	9.3 ↘	9.8 ←

beste Teiler: 102.5 (25.), 132.1 (21.), 148.8 (22.)
 Trefferlage: 0.94 mm links, 0.33 mm hoch
 Streuwert: 1.56, horizontal: 1.33, vertikal: 1.76

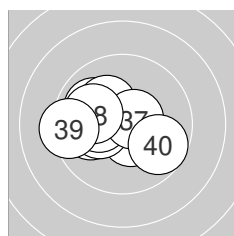

Serie 4: 98 (100.9)

10.5* ↘	10.0 ↖	10.0 ←	10.2* ↖	10.3* ←
10.3* ←	10.6* ↗	10.0 ↖	9.3 ←	9.7 ↘

beste Teiler: 91.3 (37.), 113.1 (31.), 175.4 (36.)
 Trefferlage: 1.13 mm links, 0.03 mm hoch
 Streuwert: 1.53, horizontal: 1.96, vertikal: 0.94



Ergebnis: **379** (398.8)
 Serien: 97 95 97 90
 Zähler: 24 13 2 0 1 0 0 0 0 0 0
 Innenzehner: 19
 Weitester: 1082 (38.), 560 (33.), 550 (3.)
 beste Teiler: 37.3 (18.), 48.7 (12.), 53.0 (10.)
 Trefferlage: 0.27 mm links, 0.77 mm hoch
 Streuwert: 2.13, horizontal: 1.98, vertikal: 2.27

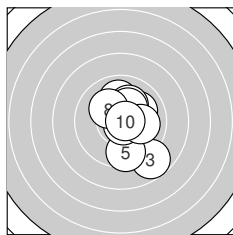
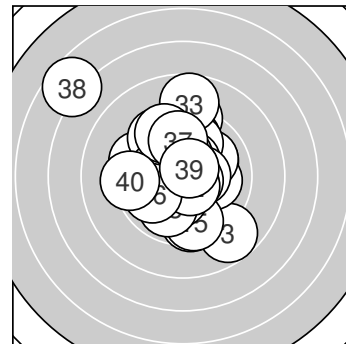

Serie 1: 97 (100.3)

10.0 ↗	10.0 ↑	8.8 ↘	10.1 ↗	9.5 ↓
10.3* ↗	10.7* ↘	10.2* ↘	10.0 →	10.7* →

beste Teiler: 53.0 (10.), 53.5 (7.), 175.8 (6.)
 Trefferlage: 0.91 mm rechts, 0.00 mm
 Streuwert: 1.87, horizontal: 1.35, vertikal: 2.27

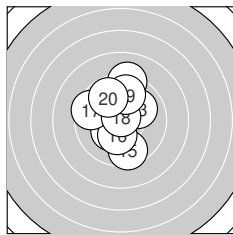

Serie 2: 95 (100.0)

9.2 ↑	10.8* ↙	10.0 ↗	10.3* ↙	9.5 ↓
10.3* ↓	9.5 ↖	10.8* ↑	9.8 ↑	9.8 ↖

beste Teiler: 37.3 (18.), 48.7 (12.), 169.1 (14.)
 Trefferlage: 0.25 mm links, 0.60 mm hoch
 Streuwert: 1.97, horizontal: 1.48, vertikal: 2.36

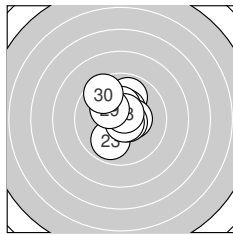

Serie 3: 97 (102.8)

9.9 ↑	10.4* ↗	9.9 ↓	10.4* →	10.6* ↘
10.4* ↑	10.7* ↘	10.6* ↗	10.3* ↘	9.6 ↖

beste Teiler: 57.6 (27.), 78.2 (28.), 87.8 (25.)
 Trefferlage: 0.01 mm rechts, 0.68 mm hoch
 Streuwert: 1.33, horizontal: 1.09, vertikal: 1.53

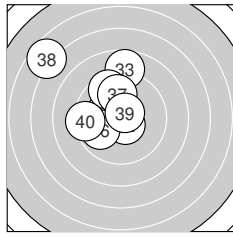

Serie 4: 90 (95.7)

10.2* ↖	10.6* ↘	8.7 ↑	10.4* ↘	9.5 ↖
9.9 ↙	9.9 ↑	6.6 ↖	10.6* ↗	9.3 ←

beste Teiler: 76.8 (39.), 93.0 (32.), 145.3 (34.)
 Trefferlage: 1.78 mm links, 1.80 mm hoch
 Streuwert: 2.74, horizontal: 2.76, vertikal: 2.72



Ergebnis: **374** (395.1)
 Serien: 93 91 92 98
 Zähler: 16 22 2 0 0 0 0 0 0 0
 Innenzehner: 10
 Weitestе: 613 (14.), 553 (20.), 495 (10.)
 beste Teiler: 37.1 (36.), 65.8 (31.), 78.8 (37.)
 Trefferlage: 0.27 mm rechts, 0.57 mm tief
 Streuwert: 2.08, horizontal: 2.26, vertikal: 1.88

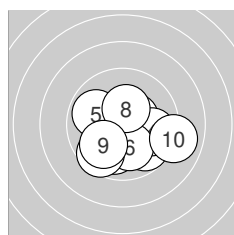
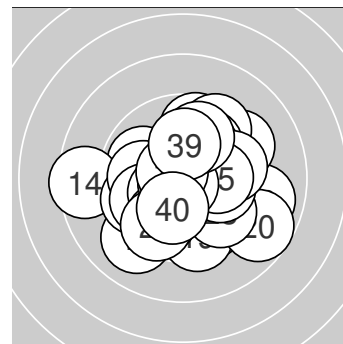

Serie 1: 93 (98.8)

9.9 ↙ 10.4* ↗ 9.8 ↘
 10.1 ↘ 9.6 ↙ 10.4* ↑
 beste Teiler: 127.6 (2.), 150.4 (8.), 220.4 (6.)
 Trefferlage: 0.45 mm rechts, 1.02 mm tief
 Streuwert: 1.97, horizontal: 2.32, vertikal: 1.53

9.8 → 9.9 ↖
 9.9 ↗ 9.0 →

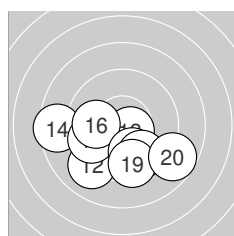

Serie 2: 91 (96.0)

10.3* ↖ 9.1 ↙ 10.6* ↘
 10.0 ← 9.9 ↘ 9.7 ↘
 beste Teiler: 88.8 (13.), 165.9 (11.), 248.1 (16.)
 Trefferlage: 0.69 mm links, 1.81 mm tief
 Streuwert: 2.40, horizontal: 3.08, vertikal: 1.43

8.5 ← 9.7 ↖
 9.5 ↘ 8.7 ↘

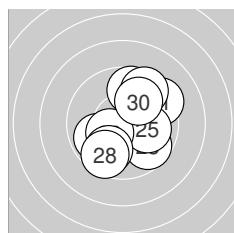

Serie 3: 92 (97.8)

9.3 ↗ 9.7 ↑ 9.7 ↘
 10.4* ↖ 9.8 ↙ 9.6 ↙
 beste Teiler: 150.8 (26.), 237.9 (25.), 254.8 (30.)
 Trefferlage: 0.59 mm rechts, 0.00 mm
 Streuwert: 2.20, horizontal: 2.05, vertikal: 2.33

9.9 ↖ 10.0 →
 9.5 ↗ 9.9 ↗

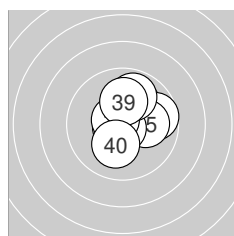

Serie 4: 98 (102.5)

10.7* ↖ 10.1 ↗ 9.7 →
 10.8* ↓ 10.6* ↖ 9.9 ↑
 beste Teiler: 37.1 (36.), 65.8 (31.), 78.8 (37.)
 Trefferlage: 0.73 mm rechts, 0.54 mm hoch
 Streuwert: 1.31, horizontal: 1.30, vertikal: 1.33

10.3* → 10.1 →
 10.1 ↑ 10.2* ↓



Ergebnis: 380 (396.6)
Serien: 97 97 93 93
Zähler: 22 16 2 0 0 0 0 0 0 0
Innenzehner: 12
Weiteste: 666 (26.), 657 (37.), 457 (25.)
beste Teiler: 26.1 (36.), 55.4 (34.), 83.6 (38.)
Trefferlage: 0.39 mm links, 0.02 mm tief
Streuwert: 2.06, horizontal: 2.53, vertikal: 1.46

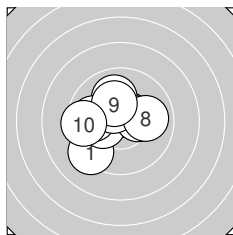
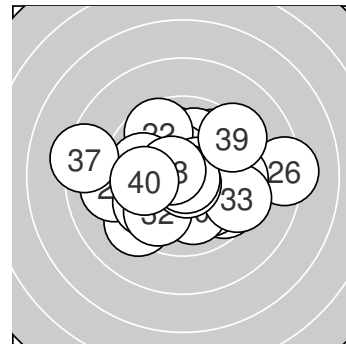

Serie 1: 97 (100.4)

9.3 ↙ 10.6* ↗ 10.2* ←
 10.3* → 10.4* ↘ 10.0 →
beste Teiler: 92.6 (2.), 127.0 (7.), 170.6 (6.)
Trefferlage: 0.81 mm links, 0.28 mm hoch
Streuwert: 1.74, horizontal: 2.00, vertikal: 1.43

10.0 ↑ 9.9 ←
 10.2* ↑ 9.5 ←

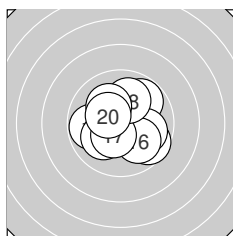

Serie 2: 97 (100.2)

9.8 ↗ 9.6 ↘ 10.0 →
 10.0 ↘ 10.4* ↗ 10.0 ↑
beste Teiler: 135.4 (17.), 145.6 (20.), 202.2 (19.)
Trefferlage: 0.18 mm rechts, 0.04 mm tief
Streuwert: 1.78, horizontal: 1.94, vertikal: 1.60

9.8 ← 10.1 ↗
 10.1 ↘ 10.4* ↘

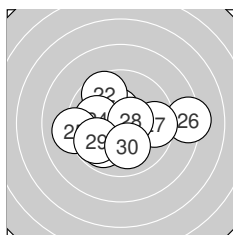

Serie 3: 93 (97.2)

10.4* ↑ 9.6 ↘ 9.9 ↗
 8.3 → 9.6 → 10.5* →
beste Teiler: 102.4 (28.), 126.2 (21.), 233.1 (30.)
Trefferlage: 0.11 mm links, 0.17 mm tief
Streuwert: 2.54, horizontal: 3.23, vertikal: 1.59

10.0 ← 9.1 ←
 9.8 ↗ 10.0 ↓

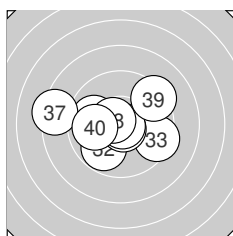

Serie 4: 93 (98.8)

10.1 ↗ 9.8 ↗ 9.4 →
 10.8* ↘ 8.3 ← 10.6* ↘
beste Teiler: 26.1 (36.), 55.4 (34.), 83.6 (38.)
Trefferlage: 0.83 mm links, 0.14 mm tief
Streuwert: 2.30, horizontal: 2.93, vertikal: 1.41

10.7* ↓ 9.9 ←
 9.3 ↗ 9.9 ←



Ergebnis: 385 (401.2)
Serien: 98 96 97 94
Zähler: 26 13 1 0 0 0 0 0 0 0
Innenzehner: 19
Weiteste: 513 (33.), 492 (27.), 484 (28.)
beste Teiler: 92.7 (9.), 93.7 (12.), 97.8 (8.)
Trefferlage: 0.65 mm rechts, 0.15 mm tief
Streuwert: 1.78, horizontal: 1.83, vertikal: 1.72

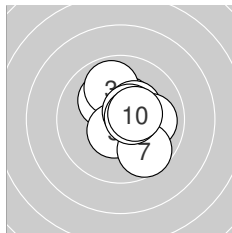
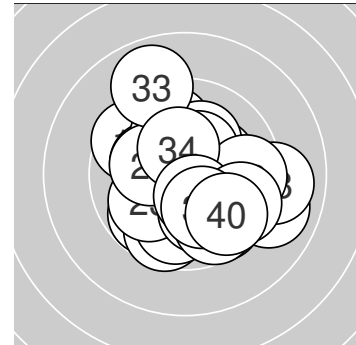

Serie 1: 98 (102.7)

10.4* ↗	10.2* ↘	9.9 ↗	10.4* ↗	10.5* ↘
10.0 →	9.7 ↘	10.6* ↗	10.6* →	10.4* →

beste Teiler: 92.7 (9.), 97.8 (8.), 107.4 (5.)
Trefferlage: 0.62 mm rechts, 0.40 mm hoch
Streuwert: 1.29, horizontal: 1.18, vertikal: 1.40

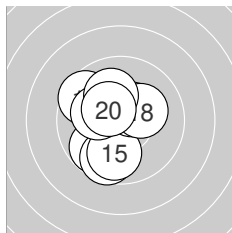

Serie 2: 96 (100.9)

9.8 ↘	10.6* ↗	9.6 ↘	9.6 ↘	9.9 ↓
10.5* ↗	10.2* ↖	10.2* →	10.1 ↖	10.4* ↖

beste Teiler: 93.7 (12.), 125.8 (16.), 134.4 (20.)
Trefferlage: 0.72 mm links, 0.00 mm
Streuwert: 1.66, horizontal: 1.38, vertikal: 1.89

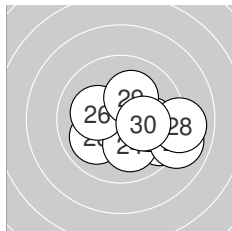

Serie 3: 97 (98.7)

9.5 ↘	10.5* ↘	10.0 ↘	10.1 ↓	10.0 →
10.2* ↖	9.0 ↘	9.0 →	10.2* ↗	10.2* →

beste Teiler: 113.2 (22.), 190.4 (30.), 195.8 (29.)
Trefferlage: 1.56 mm rechts, 0.63 mm tief
Streuwert: 1.84, horizontal: 2.33, vertikal: 1.16

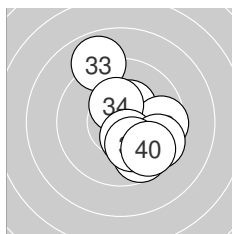

Serie 4: 94 (98.9)

10.4* ↗	9.6 →	8.9 ↖	10.4* ↗	9.7 ↘
10.1 ↘	10.4* ↘	9.6 ↘	10.1 ↘	9.7 ↘

beste Teiler: 131.1 (37.), 141.1 (31.), 146.4 (34.)
Trefferlage: 1.16 mm rechts, 0.39 mm tief
Streuwert: 1.96, horizontal: 1.55, vertikal: 2.30



Ergebnis: 349 (367.8)
Serien: 85 89 83 92
Zähler: 9 20 9 1 0 0 0 0 0 0 1
Innenzehner: 4
Weiteste: 797 (3.), 712 (38.), 653 (4.)
beste Teiler: 63.2 (37.), 145.6 (36.), 150.6 (6.)
Trefferlage: 0.73 mm rechts, 0.62 mm tief
Streuwert: 2.90, horizontal: 3.25, vertikal: 2.50

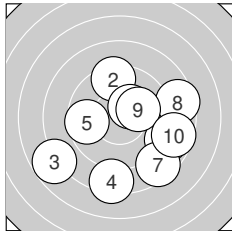
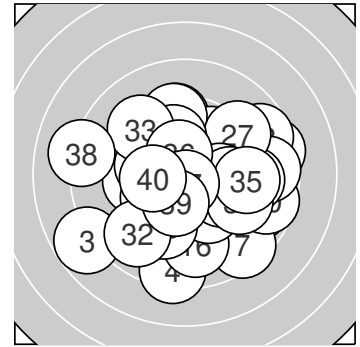

Serie 1: 85 (90.1)

8.8 ↘ 9.4 ↑ 7.8 ↙ 8.3 ↓ 9.6 ←
 10.4* ↗ 8.5 ↘ 8.5 → 10.1 → 8.7 ↘
beste Teiler: 150.6 (6.), 204.3 (9.), 334.3 (5.)
Trefferlage: 1.15 mm rechts, 1.29 mm tief
Streuwert: 3.69, horizontal: 4.07, vertikal: 3.26

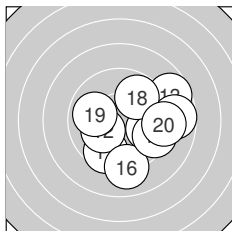

Serie 2: 89 (94.3)

9.6 ↓ 10.2* ↙ 8.7 → 8.7 → 9.8 ↘
 9.0 ↓ 9.4 ↘ 9.8 ↗ 9.9 ← 9.2 →
beste Teiler: 198.1 (12.), 258.0 (19.), 290.6 (18.)
Trefferlage: 1.83 mm rechts, 0.59 mm tief
Streuwert: 2.62, horizontal: 2.95, vertikal: 2.24

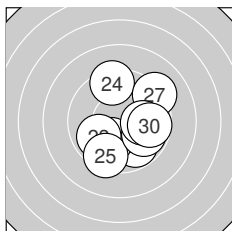

Serie 3: 83 (87.4)

9.8 ↘ 10.1 ↓ 9.9 ↙ 9.4 ↑ 9.5 ↓
 9.8 ↘ 9.2 ↗ 0.0F^{MIS} 10.0 → 9.7 →
beste Teiler: 204.7 (22.), 233.6 (29.), 262.4 (23.)
Trefferlage: 0.87 mm rechts, 0.51 mm tief
Streuwert: 2.27, horizontal: 2.14, vertikal: 2.39

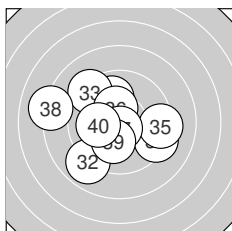

Serie 4: 92 (96.0)

9.9 ↑ 8.9 ↙ 9.2 ↘ 9.3 ↘ 9.3 →
 10.4* ↑ 10.7* ↓ 8.1 ← 10.1 ↓ 10.1 ←
beste Teiler: 63.2 (37.), 145.6 (36.), 203.9 (39.)
Trefferlage: 0.92 mm links, 0.07 mm tief
Streuwert: 2.78, horizontal: 3.27, vertikal: 2.19

MIS – Treffer wurde manuell eingefügt, da der Schütze die Scheibe verfehlt hat



Ergebnis: 390 (409.3)
Serien: 97 99 96 98
Zähler: 30 10 0 0 0 0 0 0 0 0
Innenzehner: 27
Weiteste: 380 (37.), 360 (4.), 330 (32.)
beste Teiler: 38.1 (16.), 38.6 (14.), 40.2 (25.)
Trefferlage: 0.00 mm , 0.41 mm tief
Streuwert: 1.40, horizontal: 1.53, vertikal: 1.26

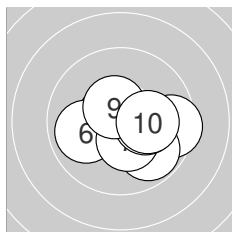
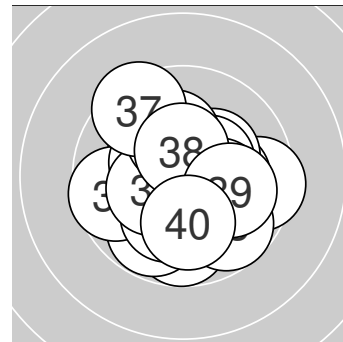

Serie 1: 97 (101.5)

10.6* ←	10.1 →	10.3* ↘	9.5 →	9.8 ↘
9.9 ←	10.4* ↓	10.2* →	10.5* ↖	10.2* →

beste Teiler: 91.4 (1.), 109.2 (9.), 141.1 (7.)
Trefferlage: 0.91 mm rechts, 0.51 mm tief
Streuwert: 1.38, horizontal: 1.76, vertikal: 0.86

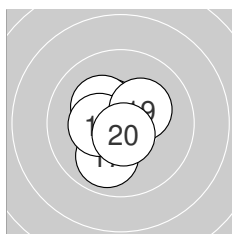

Serie 2: 99 (104.6)

10.7* ↓	10.5* ↖	10.2* ↖	10.8* ✓	10.4* ✓
10.8* →	9.9 ✓	10.4* ←	10.3* ↗	10.6* ↓

beste Teiler: 38.1 (16.), 38.6 (14.), 59.7 (11.)
Trefferlage: 0.33 mm links, 0.22 mm tief
Streuwert: 0.99, horizontal: 0.90, vertikal: 1.07

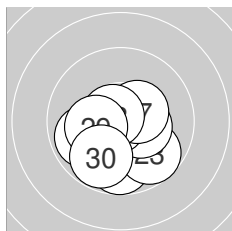

Serie 3: 96 (102.2)

9.8 ↓	10.5* ↘	9.7 ↘	10.4* →	10.8* ←
9.9 ←	10.4* ↗	10.7* ↖	10.2* ←	9.8 ✓

beste Teiler: 40.2 (25.), 67.1 (28.), 122.8 (22.)
Trefferlage: 0.09 mm links, 0.94 mm tief
Streuwert: 1.38, horizontal: 1.49, vertikal: 1.25

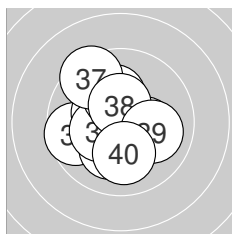

Serie 4: 98 (101.0)

10.3* →	9.6 ←	10.2* ↓	10.4* ↖	10.3* ←
10.2* ↖	9.4 ↖	10.5* ↑	10.0 →	10.1 ↓

beste Teiler: 122.1 (38.), 143.5 (34.), 152.8 (35.)
Trefferlage: 0.50 mm links, 0.03 mm hoch
Streuwert: 1.66, horizontal: 1.64, vertikal: 1.68



Ergebnis: 365 (380.6)
Serien: 91 90 91 93
Zähler: 10 25 5 0 0 0 0 0 0 0
Innenzehner: 5
Weiteste: 628 (3.), 573 (21.), 569 (39.)
beste Teiler: 101.5 (19.), 109.6 (34.), 112.2 (40.)
Trefferlage: 0.96 mm links, 0.82 mm tief
Streuwert: 2.60, horizontal: 2.80, vertikal: 2.40

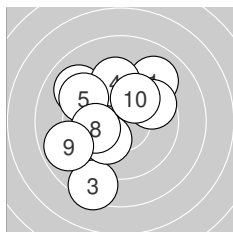
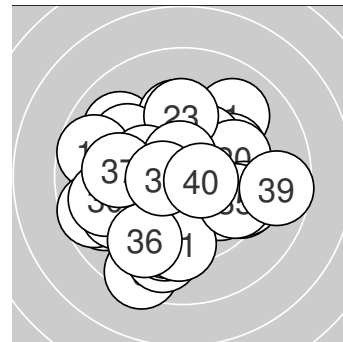

Serie 1: 91 (94.2)

9.1 ↗	9.1 ↘	8.4 ↓	9.5 ↑	9.4 ↘
10.1 ↓	9.7 ↗	10.0 ←	8.9 ←	10.0 ↗

beste Teiler: 205.0 (6.), 234.8 (8.), 246.3 (10.)
Trefferlage: 1.11 mm links, 0.55 mm hoch
Streuwert: 2.89, horizontal: 2.73, vertikal: 3.05

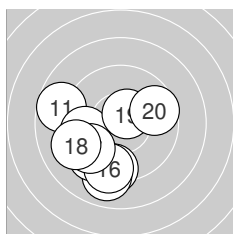

Serie 2: 90 (94.1)

8.7 ↖	9.6 ←	9.3 ↓	9.0 ↓	9.4 ↗
9.3 ↓	9.5 ↗	9.2 ←	10.5* ↗	9.6 ↗

beste Teiler: 101.5 (19.), 327.8 (20.), 330.1 (12.)
Trefferlage: 1.72 mm links, 1.74 mm tief
Streuwert: 2.37, horizontal: 2.42, vertikal: 2.32

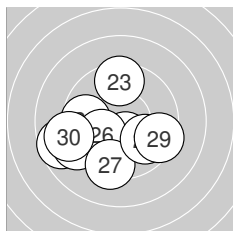

Serie 3: 91 (95.2)

8.7 ←	9.7 ←	9.5 ↑	10.4* ↓	9.2 ←
10.1 ←	9.3 ↓	9.9 ↘	9.4 ↘	9.0 ←

beste Teiler: 146.7 (24.), 207.7 (26.), 275.4 (28.)
Trefferlage: 1.37 mm links, 1.14 mm tief
Streuwert: 2.50, horizontal: 2.95, vertikal: 1.96

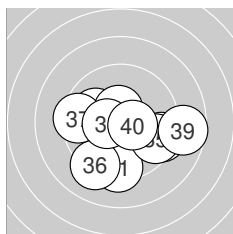

Serie 4: 93 (97.1)

9.3 ↓	9.4 ↘	10.0 ↖	10.5* ↑	9.6 ↘
9.2 ↓	9.4 ←	10.5* ←	8.7 →	10.5* →

beste Teiler: 109.6 (34.), 112.2 (40.), 123.7 (38.)
Trefferlage: 0.34 mm rechts, 0.96 mm tief
Streuwert: 2.49, horizontal: 3.03, vertikal: 1.80



Ergebnis: **389** (406.8)
 Serien: 95 97 99 98
 Zähler: 29 11 0 0 0 0 0 0 0 0
 Innenzehner: 25
 Weitestе: 473 (2.), 459 (10.), 432 (26.)
 beste Teiler: 39.6 (38.), 61.0 (22.), 66.2 (20.)
 Trefferlage: 0.22 mm links, 0.57 mm hoch
 Streuwert: 1.56, horizontal: 1.93, vertikal: 1.08

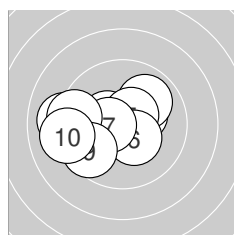
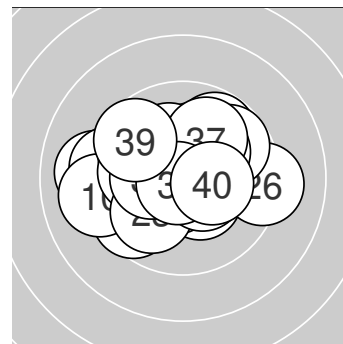

Serie 1: 95 (99.2)

10.3* ↗	9.1 ←	9.9 ↗	10.4* ↖	10.5* ↗
10.4* ↘	10.5* ←	9.4 ←	9.6 ↗	9.1 ←

beste Teiler: 101.9 (5.), 112.2 (7.), 133.5 (4.)
 Trefferlage: 1.33 mm links, 0.05 mm hoch
 Streuwert: 1.95, horizontal: 2.51, vertikal: 1.13

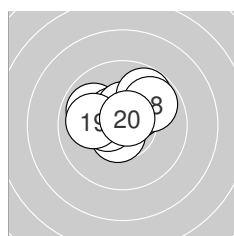

Serie 2: 97 (102.5)

10.3* ↗	10.6* ↘	9.9 ↖	10.5* ↖	10.5* ←
10.4* ↑	9.8 ↗	9.8 ↗	10.0 ←	10.7* ↗

beste Teiler: 66.2 (20.), 87.2 (12.), 112.6 (14.)
 Trefferlage: 0.15 mm links, 0.88 mm hoch
 Streuwert: 1.28, horizontal: 1.58, vertikal: 0.89

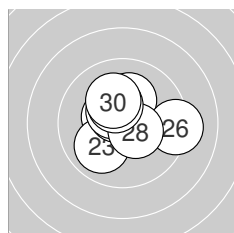

Serie 3: 99 (102.7)

10.5* ↖	10.7* →	10.0 ↘	10.6* ↖	10.2* ↑
9.2 →	10.5* ↖	10.5* ↘	10.3* ↖	10.2* ↖

beste Teiler: 61.0 (22.), 83.8 (24.), 122.0 (27.)
 Trefferlage: 0.11 mm rechts, 0.45 mm hoch
 Streuwert: 1.46, horizontal: 1.70, vertikal: 1.17

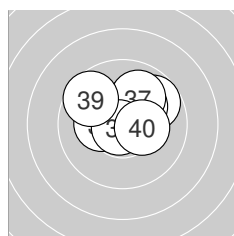

Serie 4: 98 (102.4)

10.1 ↗	9.8 ↗	10.6* →	10.7* ↗	10.3* ←
10.2* ↗	10.0 ↗	10.8* ↘	9.6 ↖	10.3* →

beste Teiler: 39.6 (38.), 66.4 (34.), 99.0 (33.)
 Trefferlage: 0.46 mm rechts, 0.92 mm hoch
 Streuwert: 1.32, horizontal: 1.56, vertikal: 1.02



Ergebnis: **350** (369.2)
 Serien: 89 91 84 86
 Zähler: 13 11 11 3 2 0 0 0 0 0 0
 Innenzehner: 10
 Weitester: 1044 (38.), 1041 (19.), 819 (26.)
 beste Teiler: 64.2 (36.), 82.0 (3.), 113.8 (29.)
 Trefferlage: 1.62 mm links, 0.33 mm tief
 Streuwert: 3.39, horizontal: 3.79, vertikal: 2.94

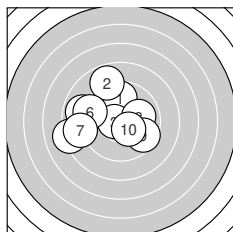
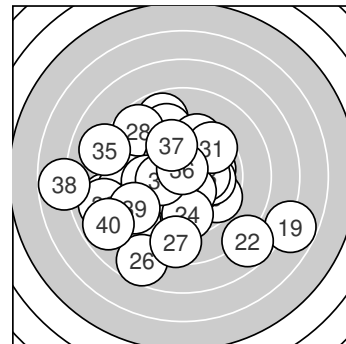

Serie 1: 89 (94.3)

9.7 ↑ 8.8 ↖ 10.6* ← 8.9 ← 8.2 ←
 9.3 ← 8.8 ← 10.0 → 9.6 ↘ 10.4* ↘

beste Teiler: 82.0 (3.), 147.7 (10.), 246.1 (8.)
 Trefferlage: 1.73 mm links, 0.51 mm hoch
 Streuwert: 2.87, horizontal: 3.39, vertikal: 2.24

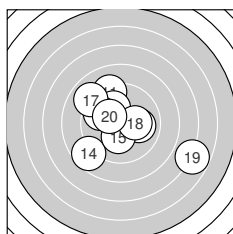

Serie 2: 91 (94.2)

9.2 ↖ 10.0 → 10.1 ↖ 8.6 ↙ 10.2* ↓
 9.8 ↖ 9.0 ↖ 10.2* → 6.8 ↘ 10.3* ↖

beste Teiler: 170.6 (20.), 177.5 (15.), 189.0 (18.)
 Trefferlage: 0.12 mm links, 0.09 mm hoch
 Streuwert: 3.45, horizontal: 3.99, vertikal: 2.82

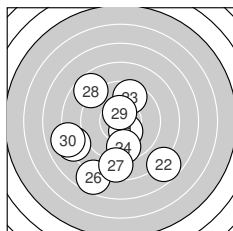

Serie 3: 84 (89.0)

10.4* ↘ 7.7 ↘ 9.6 ↑ 9.6 ↓ 8.2 ←
 7.7 ↙ 8.6 ↓ 8.7 ↖ 10.5* ↑ 8.0 ←

beste Teiler: 113.8 (29.), 148.9 (21.), 338.3 (24.)
 Trefferlage: 1.34 mm links, 2.06 mm tief
 Streuwert: 3.83, horizontal: 3.82, vertikal: 3.85

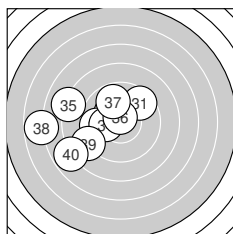

Serie 4: 86 (91.7)

9.5 ↗ 10.2* ↖ 9.7 ← 10.2* ← 8.1 ↖
 10.7* ↑ 9.8 ↑ 6.8 ← 8.9 ↙ 7.8 ↙

beste Teiler: 64.2 (36.), 176.7 (32.), 194.6 (34.)
 Trefferlage: 3.29 mm links, 0.09 mm hoch
 Streuwert: 3.14, horizontal: 3.81, vertikal: 2.29



Ergebnis: **390** (406.7)
 Serien: 98 98 96 98
 Zähler: 30 10 0 0 0 0 0 0 0 0
 Innenzehner: 24
 Weitester: 484 (40.), 450 (3.), 444 (22.)
 beste Teiler: 30.5 (38.), 54.0 (35.), 59.0 (10.)
 Trefferlage: 0.34 mm links, 0.04 mm hoch
 Streuwert: 1.61, horizontal: 1.85, vertikal: 1.32

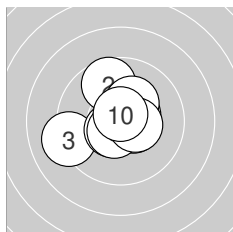
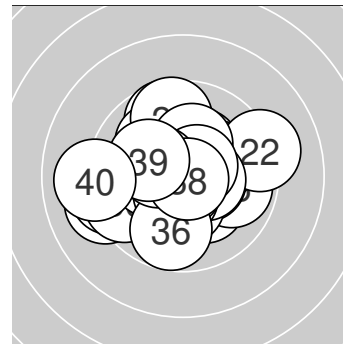

Serie 1: 98 (103.2)

10.7* →	9.7 ↑	9.2 ←	10.5* ←	10.5* →
10.5* →	10.3* ↗	10.6* ↘	10.5* →	10.7* ↑

beste Teiler: 59.0 (10.), 65.7 (1.), 95.4 (8.)
 Trefferlage: 0.16 mm links, 0.17 mm hoch
 Streuwert: 1.49, horizontal: 1.65, vertikal: 1.30

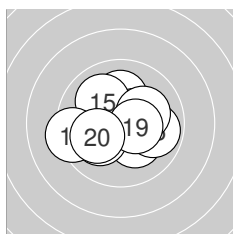

Serie 2: 98 (100.7)

10.1 ↑	10.2* ↘	10.1 ←	10.4* →	10.0 ↘
9.9 →	9.3 ←	10.1 →	10.5* →	10.1 ←

beste Teiler: 125.7 (19.), 126.6 (14.), 186.0 (12.)
 Trefferlage: 0.10 mm links, 0.02 mm tief
 Streuwert: 1.73, horizontal: 2.08, vertikal: 1.28

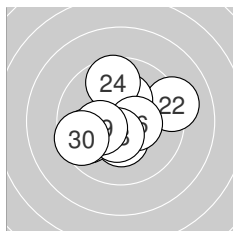

Serie 3: 96 (100.4)

10.4* ↗	9.2 →	10.2* ↑	9.7 ↑	10.3* ↓
10.5* →	9.8 ←	10.5* ↓	10.2* ←	9.6 ←

beste Teiler: 117.8 (28.), 121.6 (26.), 142.8 (21.)
 Trefferlage: 0.16 mm links, 0.12 mm hoch
 Streuwert: 1.89, horizontal: 2.14, vertikal: 1.61

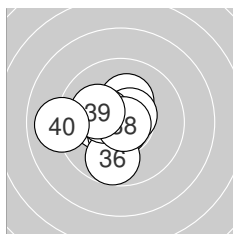

Serie 4: 98 (102.4)

10.2* ↑	10.3* ←	10.5* ↘	10.6* ↗	10.7* ↓
9.8 ↓	10.4* ↖	10.8* ↘	10.1 ↖	9.0 ←

beste Teiler: 30.5 (38.), 54.0 (35.), 95.0 (34.)
 Trefferlage: 0.94 mm links, 0.10 mm tief
 Streuwert: 1.46, horizontal: 1.65, vertikal: 1.25



Ergebnis: **367** (384.0)
 Serien: 92 94 92 89
 Zähler: 12 23 5 0 0 0 0 0 0 0
 Innenzehner: 5
 Weitester: 616 (30.), 581 (35.), 572 (18.)
 beste Teiler: 90.0 (28.), 93.4 (12.), 101.4 (26.)
 Trefferlage: 1.58 mm links, 0.13 mm tief
 Streuwert: 2.35, horizontal: 2.59, vertikal: 2.07

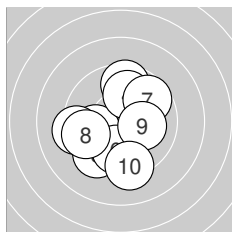
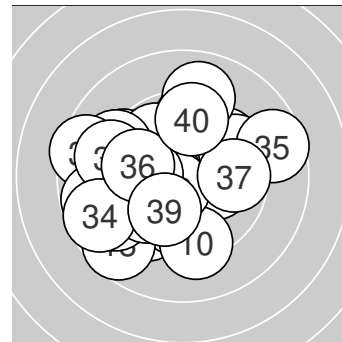

Serie 1: 92 (96.9)

9.6 ↑	10.0 ←	9.5 ↘	9.9 ↑	9.3 ←
9.9 ↓	9.7 ↗	9.6 ←	10.1 →	9.3 ↓

beste Teiler: 203.5 (9.), 242.2 (2.), 251.7 (4.)
 Trefferlage: 0.59 mm links, 0.50 mm tief
 Streuwert: 2.35, horizontal: 2.24, vertikal: 2.46

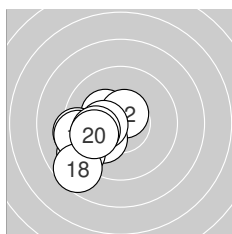

Serie 2: 94 (97.6)

10.3* ↘	10.6* ↑	9.3 ←	10.1 ↘	9.1 ↘
9.3 ←	10.3* ←	8.7 ↘	10.0 ←	9.9 ↘

beste Teiler: 93.4 (12.), 157.7 (17.), 166.2 (11.)
 Trefferlage: 2.45 mm links, 1.02 mm tief
 Streuwert: 1.48, horizontal: 1.44, vertikal: 1.53

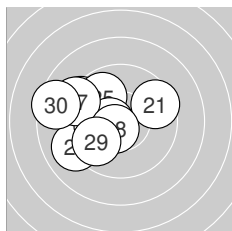

Serie 3: 92 (96.2)

9.5 ↗	9.0 ←	10.1 ←	9.3 ↘	9.8 ↘
10.5* ←	9.1 ↘	10.6* ↘	9.8 ↘	8.5 ←

beste Teiler: 90.0 (28.), 101.4 (26.), 209.6 (23.)
 Trefferlage: 2.22 mm links, 0.35 mm hoch
 Streuwert: 2.14, horizontal: 2.53, vertikal: 1.67

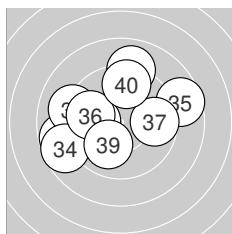

Serie 4: 89 (93.3)

8.8 ←	10.1 ←	9.1 ←	8.7 ↘	8.6 →
9.8 ←	9.7 →	9.0 ↑	10.0 ↘	9.5 ↑

beste Teiler: 224.2 (32.), 234.9 (39.), 284.5 (36.)
 Trefferlage: 1.08 mm links, 0.62 mm hoch
 Streuwert: 3.04, horizontal: 3.61, vertikal: 2.33



Ergebnis: 384 (399.7)
Serien: 95 97 96 96
Zähler: 25 14 1 0 0 0 0 0 0 0
Innenzehner: 20
Weiteste: 647 (5.), 475 (12.), 463 (20.)
beste Teiler: 29.0 (27.), 44.8 (18.), 56.4 (30.)
Trefferlage: 0.26 mm rechts, 0.39 mm tief
Streuwert: 1.96, horizontal: 2.48, vertikal: 1.23

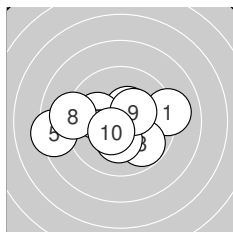
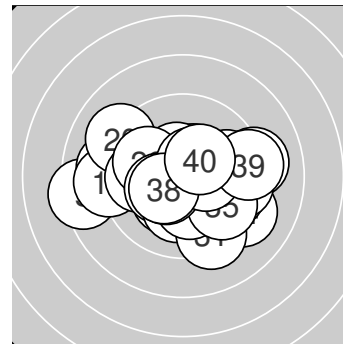

Serie 1: 95 (98.2)

9.1 →	10.4* ↓	9.8 ↘	10.3* ↓	8.4 ←
10.4* ↗	10.0 ←	9.1 ←	10.3* ↗	10.4* ↗

beste Teiler: 126.9 (6.), 131.5 (10.), 137.0 (2.)
Trefferlage: 0.53 mm links, 0.32 mm tief
Streuwert: 2.41, horizontal: 3.18, vertikal: 1.22

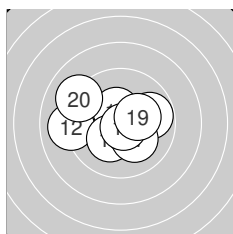

Serie 2: 97 (100.6)

10.1 →	9.1 ←	10.5* ↗	10.2* ↗	10.6* ↘
9.8 →	10.1 ↘	10.8* ↘	10.3* →	9.1 ↖

beste Teiler: 44.8 (18.), 89.1 (15.), 125.8 (13.)
Trefferlage: 0.14 mm links, 0.09 mm hoch
Streuwert: 1.96, horizontal: 2.50, vertikal: 1.20

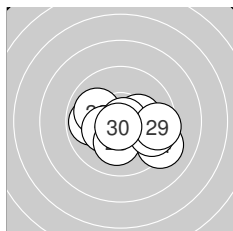

Serie 3: 96 (100.5)

9.9 ←	10.0 ↖	10.3* →	9.2 ↘	10.3* ↖
10.1 ↓	10.8* →	9.7 ↘	9.5 →	10.7* ↓

beste Teiler: 29.0 (27.), 56.4 (30.), 168.1 (25.)
Trefferlage: 0.52 mm rechts, 0.60 mm tief
Streuwert: 1.82, horizontal: 2.38, vertikal: 0.99

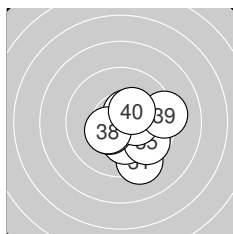

Serie 4: 96 (100.4)

9.3 ↓	10.5* ↗	9.9 ↘	10.2* ↓	9.7 ↘
10.4* ↖	10.4* →	10.4* ↖	9.3 →	10.3* ↗

beste Teiler: 101.5 (32.), 136.0 (36.), 144.5 (38.)
Trefferlage: 1.20 mm rechts, 0.76 mm tief
Streuwert: 1.57, horizontal: 1.64, vertikal: 1.49



Ergebnis: **366** (382.0)
Serien: 89 91 93 93
Zähler: 14 20 4 2 0 0 0 0 0 0
Innenzehner: 11
Weiteste: 992 (4.), 978 (12.), 703 (39.)
beste Teiler: 62.0 (36.), 80.0 (10.), 83.7 (26.)
Trefferlage: 0.26 mm links, 0.09 mm tief
Streuwert: 2.95, horizontal: 3.61, vertikal: 2.09

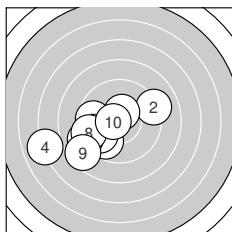
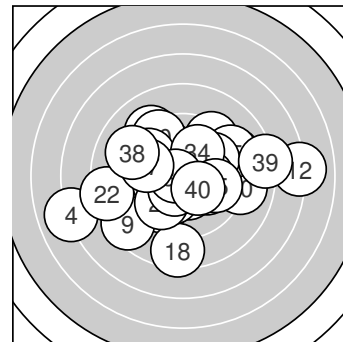

Serie 1: 89 (93.1)

9.7 ↙	9.1 →	10.5* ↑	7.0 ←	9.6 ←
9.8 ↙	9.0 ↙	9.3 ↙	8.5 ↙	10.6* ←

beste Teiler: 80.0 (10.), 117.3 (3.), 300.2 (6.)
Trefferlage: 2.59 mm links, 1.19 mm tief
Streuwert: 2.87, horizontal: 3.57, vertikal: 1.91

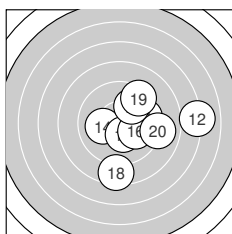

Serie 2: 91 (94.3)

9.7 →	7.0 →	10.2* ↘	10.1 ←	10.4* ↓
10.1 ↘	9.9 ↗	8.5 ↓	9.4 ↗	9.0 →

beste Teiler: 148.6 (15.), 177.1 (13.), 212.4 (14.)
Trefferlage: 2.30 mm rechts, 0.41 mm tief
Streuwert: 2.90, horizontal: 3.24, vertikal: 2.52

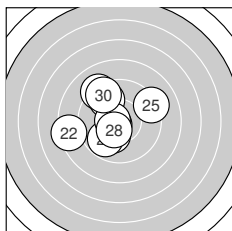

Serie 3: 93 (97.3)

9.7 ↘	8.3 ←	10.2* ↙	9.8 ↙	9.2 →
10.6* ↙	10.6* ←	10.4* ↙	9.1 ↘	9.4 ↘

beste Teiler: 83.7 (26.), 90.3 (27.), 129.8 (28.)
Trefferlage: 1.36 mm links, 0.47 mm hoch
Streuwert: 2.39, horizontal: 2.53, vertikal: 2.24

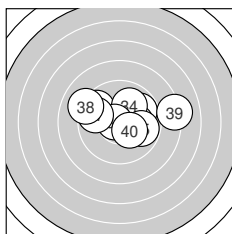

Serie 4: 93 (97.3)

9.8 ↗	9.6 ↘	10.2* →	10.0 ↗	9.8 →
10.7* ←	9.7 ↘	9.1 ↘	8.1 →	10.3* ↘

beste Teiler: 62.0 (36.), 162.1 (40.), 200.0 (33.)
Trefferlage: 0.58 mm rechts, 0.75 mm hoch
Streuwert: 2.50, horizontal: 3.35, vertikal: 1.14



Ergebnis: **391** (411.6)
 Serien: 97 97 98 99
 Zähler: 31 9 0 0 0 0 0 0 0 0
 Innenzehner: 29
 Weitestе: 337 (31.), 335 (16.), 334 (5.)
 beste Teiler: 14.8 (20.), 32.0 (24.), 49.7 (36.)
 Trefferlage: 0.24 mm rechts, 0.18 mm hoch
 Streuwert: 1.34, horizontal: 1.34, vertikal: 1.33

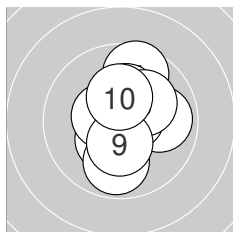
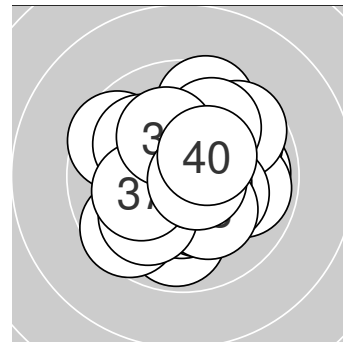

Serie 1: 97 (102.1)

10.4* ↙	10.5* ←	9.9 →	9.9 ↓	9.6 ↑
10.3* ↑	10.6* →	10.2* ↗	10.4* ↓	10.3* ↑

beste Teiler: 76.5 (7.), 115.4 (2.), 147.1 (9.)
 Trefferlage: 0.39 mm rechts, 0.30 mm hoch
 Streuwert: 1.47, horizontal: 1.13, vertikal: 1.75

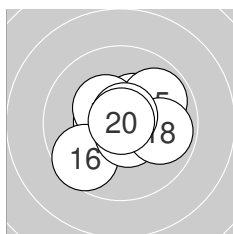

Serie 2: 97 (103.2)

10.4* ↗	10.6* ←	10.2* →	10.4* ↘	9.9 ↗
9.6 ↙	10.6* ↘	9.9 →	10.7* ↑	10.9* ↑

beste Teiler: 14.8 (20.), 55.4 (19.), 89.3 (17.)
 Trefferlage: 0.40 mm rechts, 0.04 mm hoch
 Streuwert: 1.37, horizontal: 1.59, vertikal: 1.12

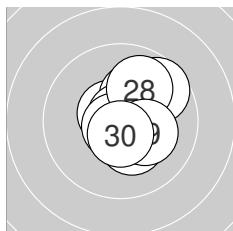

Serie 3: 98 (103.6)

10.6* ↘	10.6* ↘	10.2* ↑	10.8* ↑	9.7 ↗
10.3* ↘	10.7* ↙	9.9 ↑	10.2* →	10.6* ↓

beste Teiler: 32.0 (24.), 52.4 (27.), 87.0 (30.)
 Trefferlage: 0.65 mm rechts, 0.28 mm hoch
 Streuwert: 1.15, horizontal: 0.97, vertikal: 1.30

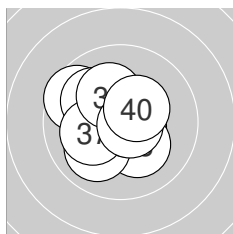

Serie 4: 99 (102.7)

9.6 ↘	10.6* →	10.2* ↘	10.0 ↙	10.0 ↘
10.8* →	10.2* ←	10.2* ↘	10.7* →	10.4* ↗

beste Teiler: 49.7 (36.), 66.4 (39.), 91.0 (32.)
 Trefferlage: 0.48 mm links, 0.11 mm hoch
 Streuwert: 1.39, horizontal: 1.50, vertikal: 1.27



Ergebnis: 378 (395.0)
Serien: 94 92 100 92
Zähler: 20 18 2 0 0 0 0 0 0 0
Innenzehner: 11
Weiteste: 571 (10.), 541 (12.), 436 (13.)
beste Teiler: 74.6 (2.), 76.3 (7.), 78.2 (16.)
Trefferlage: 0.00 mm , 0.62 mm hoch
Streuwert: 2.05, horizontal: 2.23, vertikal: 1.86

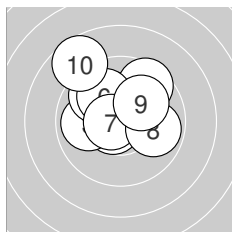
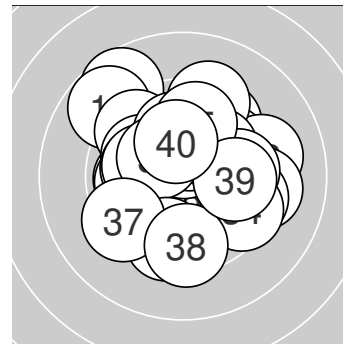

Serie 1: 94 (99.5)

10.2* ↑	10.7* ↙	9.9 ←	9.8 ↘	9.6 ↗
10.0 ↘	10.6* ←	9.9 →	10.1 ↗	8.7 ↘

beste Teiler: 74.6 (2.), 76.3 (7.), 176.0 (1.)
Trefferlage: 0.46 mm links, 1.35 mm hoch
Streuwert: 1.85, horizontal: 2.00, vertikal: 1.69

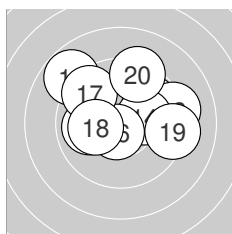

Serie 2: 92 (96.7)

9.8 ↗	8.8 ↘	9.2 →	10.2* →	9.9 ←
10.6* ↘	9.6 ↘	10.1 ←	9.2 →	9.3 ↑

beste Teiler: 78.2 (16.), 196.2 (14.), 204.6 (18.)
Trefferlage: 0.27 mm rechts, 1.12 mm hoch
Streuwert: 2.43, horizontal: 2.95, vertikal: 1.75

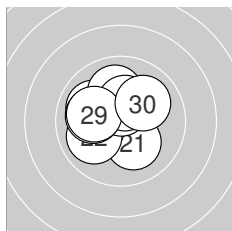

Serie 3: 100 (101.5)

10.2* ↘	10.0 ↙	10.0 ↘	10.3* ↑	10.0 ↑
10.5* ↑	10.0 ←	10.4* ↑	10.1 ←	10.0 ↗

beste Teiler: 104.1 (26.), 150.1 (28.), 161.3 (24.)
Trefferlage: 0.52 mm links, 0.69 mm hoch
Streuwert: 1.40, horizontal: 1.53, vertikal: 1.25

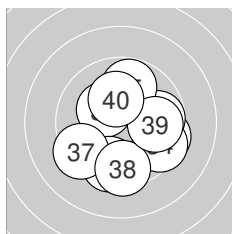

Serie 4: 92 (97.3)

9.5 →	10.3* ↘	9.8 →	9.5 ↘	9.8 ↑
9.5 ↓	9.4 ↙	9.5 ↓	9.8 →	10.2* ↑

beste Teiler: 167.0 (32.), 189.8 (40.), 280.5 (39.)
Trefferlage: 0.74 mm rechts, 0.66 mm tief
Streuwert: 2.24, horizontal: 2.27, vertikal: 2.21



Ergebnis: **384** (404.1)
Serien: 96 96 95 97
Zähler: 26 12 2 0 0 0 0 0 0 0
Innenzehner: 22
Weiteste: 610 (30.), 608 (25.), 441 (1.)
beste Teiler: 9.4 (11.), 23.3 (4.), 45.3 (39.)
Trefferlage: 0.24 mm links, 0.02 mm hoch
Streuwert: 1.84, horizontal: 2.27, vertikal: 1.26

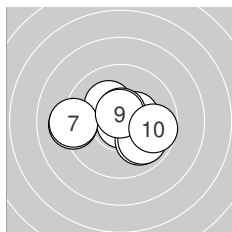
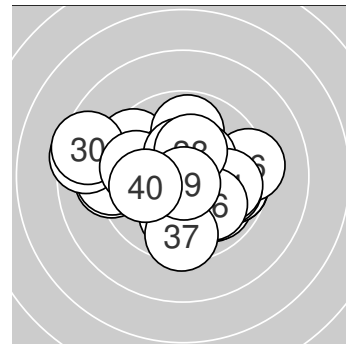

Serie 1: 96 (100.8)

9.2 ← 10.4* → 10.2* ↘ 10.9* ↓ 10.0 ↘
 9.9 ↘ 9.2 ← 10.6* ↑ 10.7* ↑ 9.7 →

beste Teiler: 23.3 (4.), 70.4 (9.), 82.2 (8.)
Trefferlage: 0.18 mm links, 0.13 mm tief
Streuwert: 1.93, horizontal: 2.51, vertikal: 1.07

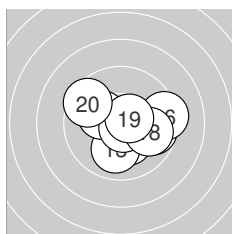

Serie 2: 96 (101.1)

10.9* ↗ 10.2* ↓ 10.0 ↓ 10.2* ↖ 9.7 →
 9.3 → 10.8* ↘ 9.9 → 10.6* ↗ 9.5 ↖

beste Teiler: 9.4 (11.), 50.1 (17.), 91.3 (19.)
Trefferlage: 0.61 mm rechts, 0.20 mm tief
Streuwert: 1.76, horizontal: 2.15, vertikal: 1.24

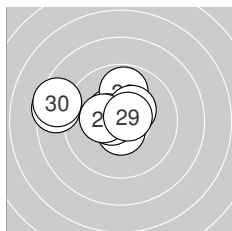

Serie 3: 95 (100.3)

10.5* ↖ 10.6* ↓ 9.8 ↑ 10.5* ← 8.5 ←
 10.4* ↗ 10.6* ← 10.3* ← 10.6* ↗ 8.5 ←

beste Teiler: 79.0 (29.), 83.0 (27.), 89.0 (22.)
Trefferlage: 1.42 mm links, 0.75 mm hoch
Streuwert: 1.91, horizontal: 2.50, vertikal: 1.00

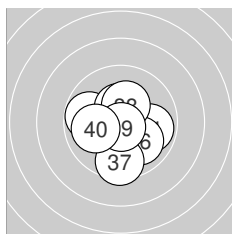

Serie 4: 97 (101.9)

9.8 ← 10.6* ↑ 10.6* ↘ 9.9 → 10.4* ↑
 10.0 ↘ 9.5 ↓ 10.3* ↑ 10.8* ↓ 10.0 ←

beste Teiler: 45.3 (39.), 78.0 (33.), 87.6 (32.)
Trefferlage: 0.00 mm , 0.32 mm tief
Streuwert: 1.59, horizontal: 1.64, vertikal: 1.54



Ergebnis: 375 (394.7)
Serien: 92 93 96 94
Zähler: 18 19 3 0 0 0 0 0 0 0
Innenzehner: 12
Weiteste: 673 (2.), 598 (9.), 538 (38.)
beste Teiler: 54.7 (35.), 58.0 (29.), 73.2 (30.)
Trefferlage: 0.24 mm rechts, 0.06 mm tief
Streuwert: 2.22, horizontal: 2.70, vertikal: 1.60

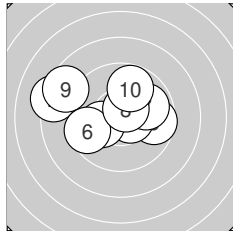
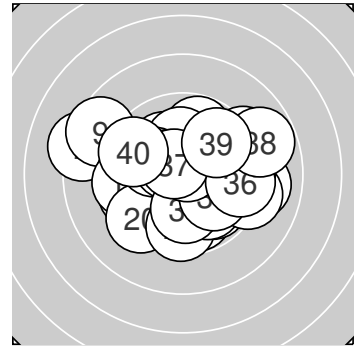

Serie 1: 92 (97.4)

10.2* ↗	8.3 ↖	9.6 →	10.6* →	10.2* ↖
9.6 ↖	9.9 ↗	10.6* ↗	8.6 ↖	9.8 ↗

beste Teiler: 96.5 (8.), 98.4 (4.), 192.5 (1.)
Trefferlage: 0.71 mm links, 0.76 mm hoch
Streuwert: 2.56, horizontal: 3.34, vertikal: 1.41

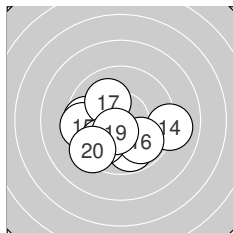

Serie 2: 93 (98.2)

9.6 ←	10.5* ↖	9.8 ↓	9.0 →	9.5 ←
9.9 ↘	10.1 ↖	9.9 ↖	10.5* ↖	9.4 ↖

beste Teiler: 120.3 (19.), 120.8 (12.), 216.3 (17.)
Trefferlage: 0.65 mm links, 1.08 mm tief
Streuwert: 2.08, horizontal: 2.58, vertikal: 1.40

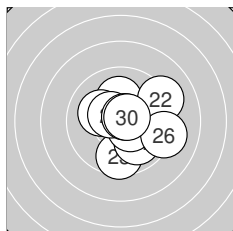

Serie 3: 96 (100.5)

10.1 ↑	9.2 ↗	9.6 ↓	9.9 ↘	10.5* ↘
9.2 →	10.1 ↖	10.5* ↖	10.7* ↗	10.7* ↗

beste Teiler: 58.0 (29.), 73.2 (30.), 113.4 (28.)
Trefferlage: 0.84 mm rechts, 0.09 mm tief
Streuwert: 1.85, horizontal: 1.94, vertikal: 1.75

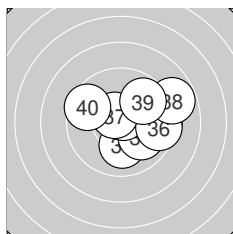

Serie 4: 94 (98.6)

10.1 ↘	9.5 →	10.1 ↓	10.0 ↘	10.7* ↗
9.5 →	10.6* ↖	8.8 ↗	9.8 ↗	9.5 ↖

beste Teiler: 54.7 (35.), 87.2 (37.), 204.3 (31.)
Trefferlage: 1.50 mm rechts, 0.17 mm hoch
Streuwert: 1.99, horizontal: 2.41, vertikal: 1.44



Ergebnis: 386 (401.2)
Serien: 95 96 98 97
Zähler: 26 14 0 0 0 0 0 0 0 0
Innenzehner: 20
Weiteste: 494 (20.), 488 (1.), 464 (12.)
beste Teiler: 30.0 (19.), 61.9 (35.), 81.4 (22.)
Trefferlage: 0.01 mm links, 0.14 mm tief
Streuwert: 1.86, horizontal: 2.28, vertikal: 1.32

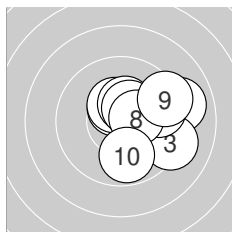
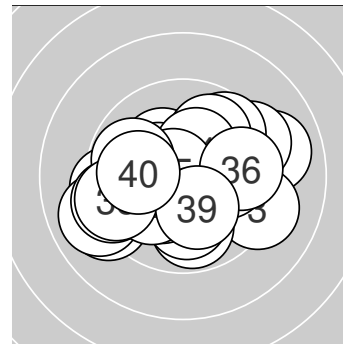

Serie 1: 95 (99.1)

9.0 →	10.5* ↖	9.2 →	10.4* ↖	10.4* ↑
10.4* ↑	9.7 →	10.4* →	9.3 →	9.8 ↓

beste Teiler: 114.6 (2.), 128.7 (6.), 132.0 (8.)
Trefferlage: 1.73 mm rechts, 0.47 mm hoch
Streuwert: 1.73, horizontal: 1.94, vertikal: 1.50

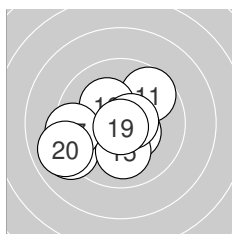

Serie 2: 96 (99.6)

9.7 ↗	9.1 ↙	10.4* ↓	10.4* ↘	10.0 ↓
10.2* ↖	9.4 ↙	10.6* →	10.8* ↓	9.0 ↙

beste Teiler: 30.0 (19.), 84.3 (18.), 126.4 (14.)
Trefferlage: 0.87 mm links, 0.56 mm tief
Streuwert: 2.02, horizontal: 2.41, vertikal: 1.55

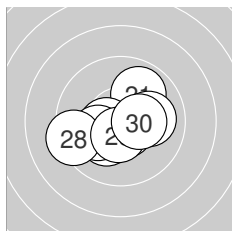

Serie 3: 98 (101.9)

9.9 ↗	10.6* ↓	10.2* ↙	10.4* ↙	10.5* ↙
10.1 ↙	10.0 →	9.3 ↙	10.5* ↓	10.4* →

beste Teiler: 81.4 (22.), 112.4 (29.), 119.9 (25.)
Trefferlage: 0.37 mm links, 0.43 mm tief
Streuwert: 1.50, horizontal: 1.84, vertikal: 1.06

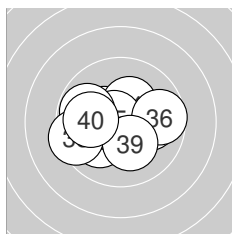

Serie 4: 97 (100.6)

10.0 →	10.1 ↙	10.4* ↘	10.3* ↑	10.7* ↖
9.7 →	9.8 ↖	9.4 ↙	10.2* ↓	10.0 ↙

beste Teiler: 61.9 (35.), 148.0 (33.), 161.4 (34.)
Trefferlage: 0.53 mm links, 0.05 mm tief
Streuwert: 1.75, horizontal: 2.23, vertikal: 1.06



Ergebnis: 375 (390.5)
Serien: 94 95 94 92
Zähler: 18 19 3 0 0 0 0 0 0 0
Innenzehner: 10
Weiteste: 709 (4.), 656 (25.), 544 (37.)
beste Teiler: 76.8 (16.), 79.1 (27.), 91.3 (20.)
Trefferlage: 0.58 mm links, 1.18 mm hoch
Streuwert: 2.18, horizontal: 2.40, vertikal: 1.93

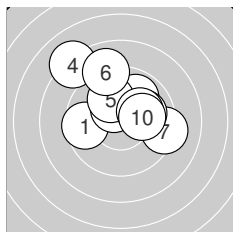
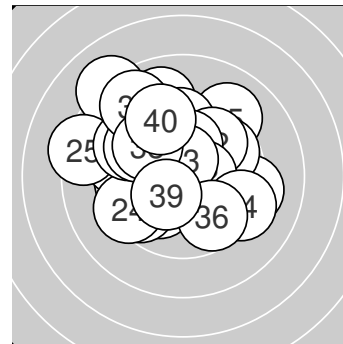

Serie 1: 94 (96.4)

9.6 ←	9.9 ↗	10.4* ↘	8.1 ↘	10.0 ↘
9.0 ↑	9.2 →	10.0 →	10.1 →	10.1 →

beste Teiler: 133.3 (3.), 207.9 (9.), 210.2 (10.)
Trefferlage: 0.07 mm rechts, 1.65 mm hoch
Streuwert: 2.42, horizontal: 2.74, vertikal: 2.05

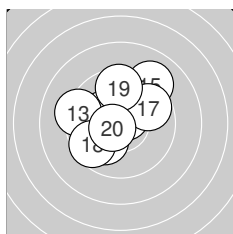

Serie 2: 95 (98.8)

10.2* ↘	10.1 ↑	9.3 ←	10.0 ↙	9.1 ↗
10.6* ↗	9.7 ↗	9.6 ↙	9.6 ↑	10.6* ↙

beste Teiler: 76.8 (16.), 91.3 (20.), 191.5 (11.)
Trefferlage: 0.43 mm links, 0.89 mm hoch
Streuwert: 2.06, horizontal: 2.20, vertikal: 1.91

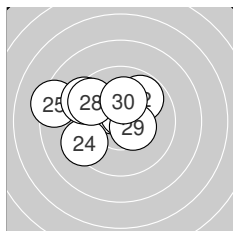

Serie 3: 94 (98.0)

10.0 ↘	9.8 ↗	10.5* ↘	9.3 ↙	8.3 ←
9.4 ↘	10.6* ↑	9.6 ↘	10.4* →	10.1 ↑

beste Teiler: 79.1 (27.), 117.6 (23.), 129.3 (29.)
Trefferlage: 1.53 mm links, 0.98 mm hoch
Streuwert: 2.04, horizontal: 2.56, vertikal: 1.33

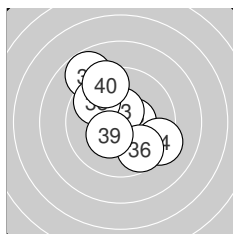

Serie 4: 92 (97.3)

9.6 ↘	10.5* →	10.5* ↑	9.3 →	9.4 ↘
9.7 ↘	8.8 ↘	9.8 ↘	10.3* ↙	9.4 ↑

beste Teiler: 107.0 (33.), 118.1 (32.), 158.6 (39.)
Trefferlage: 0.44 mm links, 1.19 mm hoch
Streuwert: 2.30, horizontal: 2.11, vertikal: 2.48



Ergebnis: **385** (401.6)
 Serien: 96 96 97 96
 Zähler: 26 13 1 0 0 0 0 0 0 0
 Innenzehner: 17
 Weitester: 527 (5.), 465 (32.), 412 (16.)
 beste Teiler: 33.2 (18.), 73.0 (20.), 81.9 (24.)
 Trefferlage: 0.12 mm rechts, 0.85 mm hoch
 Streuwert: 1.68, horizontal: 1.82, vertikal: 1.53

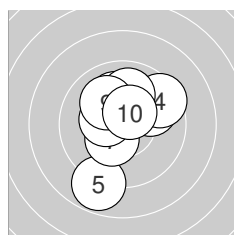
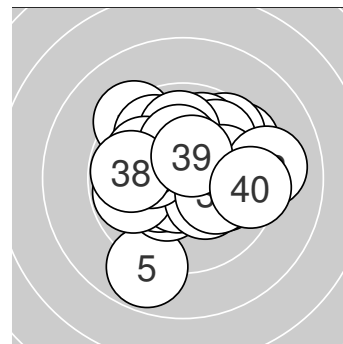

Serie 1: 96 (99.7)

9.9 ↗	10.1 ↑	10.0 ↑	9.5 ↗	8.8 ↓
10.0 ↑	10.4* ↓	10.4* ←	10.1 ↘	10.5* ↗

beste Teiler: 115.2 (10.), 142.7 (8.), 150.4 (7.)
 Trefferlage: 0.07 mm rechts, 0.71 mm hoch
 Streuwert: 1.97, horizontal: 1.64, vertikal: 2.25

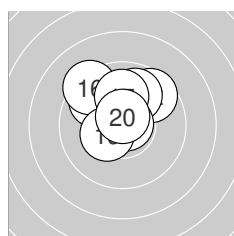

Serie 2: 96 (101.1)

10.2* ↑	9.6 ↗	10.5* ↑	9.9 ↑	9.7 ↘
9.3 ↘	10.0 ↑	10.8* →	10.4* ←	10.7* ↑

beste Teiler: 33.2 (18.), 73.0 (20.), 105.7 (13.)
 Trefferlage: 0.34 mm links, 1.54 mm hoch
 Streuwert: 1.35, horizontal: 1.47, vertikal: 1.22

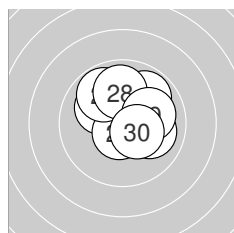

Serie 3: 97 (101.4)

10.3* ↗	10.4* ↗	10.1 ↘	10.6* ↓	9.9 ↗
10.0 →	9.8 ↘	9.9 ↑	10.0 →	10.4* ↘

beste Teiler: 81.9 (24.), 134.5 (22.), 138.5 (30.)
 Trefferlage: 0.56 mm rechts, 0.89 mm hoch
 Streuwert: 1.36, horizontal: 1.45, vertikal: 1.28

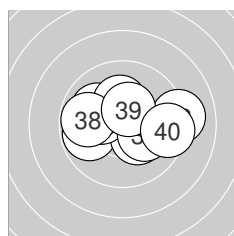

Serie 4: 96 (99.4)

9.8 ←	9.1 →	10.3* ↘	10.2* ←	10.2* ↘
10.0 ↘	10.2* ↑	9.8 ←	10.4* ↑	9.4 →

beste Teiler: 131.4 (39.), 166.3 (33.), 182.3 (37.)
 Trefferlage: 0.22 mm rechts, 0.25 mm hoch
 Streuwert: 2.00, horizontal: 2.64, vertikal: 1.01



Ergebnis: 379 (396.5)
Serien: 94 94 94 97
Zähler: 22 16 1 1 0 0 0 0 0 0
Innenzehner: 14
Weiteste: 816 (39.), 508 (21.), 477 (30.)
beste Teiler: 53.9 (33.), 66.2 (15.), 73.1 (31.)
Trefferlage: 0.43 mm rechts, 0.42 mm hoch
Streuwert: 2.08, horizontal: 2.44, vertikal: 1.65

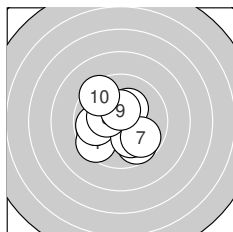
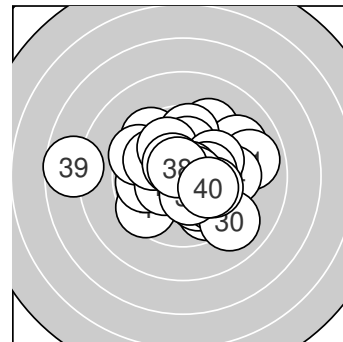

Serie 1: 94 (99.3)

9.8 ← 10.3* ↗ 9.7 ↘ 9.5 ↙ 9.8 ←
 10.1 ↘ 9.8 ↘ 10.3* ← 10.5* ↑ 9.5 ↘
beste Teiler: 125.0 (9.), 162.5 (8.), 165.4 (2.)
Trefferlage: 0.61 mm links, 0.37 mm tief
Streuwert: 1.92, horizontal: 2.02, vertikal: 1.81

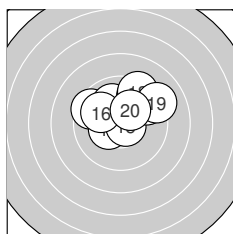

Serie 2: 94 (98.2)

9.5 ↘ 10.4* ↙ 10.0 ↘ 9.5 ↗ 10.7* ↘
 9.9 ↘ 9.5 ↗ 9.4 ↗ 9.1 ↗ 10.2* ↗
beste Teiler: 66.2 (15.), 149.3 (12.), 181.4 (20.)
Trefferlage: 0.45 mm rechts, 1.63 mm hoch
Streuwert: 1.90, horizontal: 2.34, vertikal: 1.32

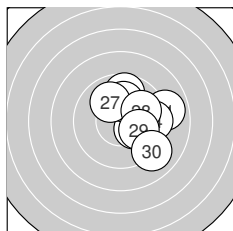

Serie 3: 94 (97.5)

8.9 → 10.0 → 10.3* ↘ 9.5 → 9.7 ↑
 10.1 ↑ 10.0 ↘ 9.9 ↗ 10.1 ↘ 9.0 ↘
beste Teiler: 172.4 (23.), 220.3 (26.), 225.0 (29.)
Trefferlage: 1.98 mm rechts, 0.46 mm hoch
Streuwert: 1.84, horizontal: 1.80, vertikal: 1.89

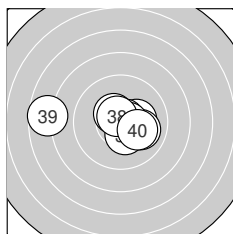

Serie 4: 97 (101.5)

10.7* → 10.2* → 10.7* ↗ 10.0 ↘ 10.6* →
 10.4* ↘ 10.5* ↘ 10.6* ↘ 7.7 ← 10.1 ↘
beste Teiler: 53.9 (33.), 73.1 (31.), 76.3 (38.)
Trefferlage: 0.09 mm links, 0.01 mm tief
Streuwert: 2.18, horizontal: 2.98, vertikal: 0.77



Ergebnis: 394 (410.1)
Serien: 99 98 98 99 9
Zähler: 34 7 0 0 0 0 0 0 0 0
Innenzehner: 25
Weiteste: 424 (20.), 341 (15.), 286 (10.)
beste Teiler: 36.6 (23.), 41.0 (29.), 45.7 (19.)
Trefferlage: 0.08 mm rechts, 0.16 mm tief
Streuwert: 1.39, horizontal: 1.43, vertikal: 1.34

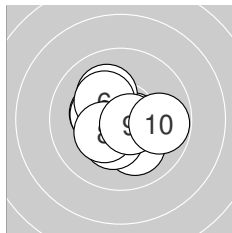
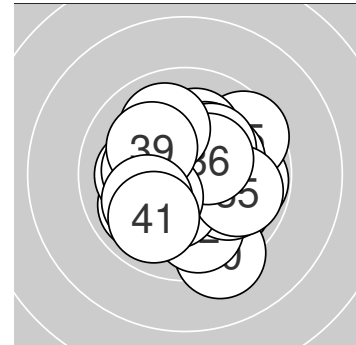

Serie 1: 99 (102.6)

10.6* →	10.3* ←	10.3* ←	10.1 ↓	10.1 ↖
10.2* ↖	10.3* ↓	10.3* ↗	10.6* →	9.8 →

beste Teiler: 78.2 (9.), 91.3 (1.), 153.0 (3.)
Trefferlage: 0.15 mm links, 0.13 mm tief
Streuwert: 1.32, horizontal: 1.45, vertikal: 1.16

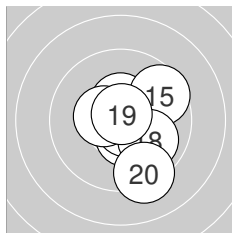

Serie 2: 98 (102.8)

10.5* ↓	10.5* →	10.5* ↑	10.5* →	9.6 ↗
10.7* ↘	10.4* ←	10.0 ↘	10.8* ↑	9.3 ↓

beste Teiler: 45.7 (19.), 60.2 (16.), 114.2 (12.)
Trefferlage: 0.85 mm rechts, 0.32 mm tief
Streuwert: 1.41, horizontal: 1.18, vertikal: 1.60

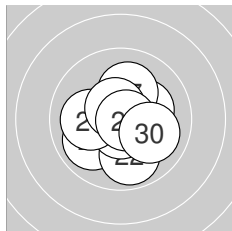

Serie 3: 98 (103.1)

9.9 ↖	9.9 ↓	10.8* ←	10.7* ↓	10.2* →
10.1 ←	10.1 ↑	10.6* ↖	10.8* →	10.0 ↘

beste Teiler: 36.6 (23.), 41.0 (29.), 69.0 (24.)
Trefferlage: 0.04 mm rechts, 0.22 mm tief
Streuwert: 1.35, horizontal: 1.40, vertikal: 1.30

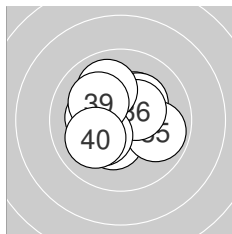

Serie 4: 99 (101.6)

10.3* ↗	10.2* ↗	10.2* ←	10.3* ↓	9.9 →
10.4* ↗	10.2* ↗	10.0 ↖	10.1 ↖	10.0 ↖

beste Teiler: 135.6 (36.), 151.9 (34.), 164.4 (31.)
Trefferlage: 0.22 mm links, 0.23 mm hoch
Streuwert: 1.46, horizontal: 1.59, vertikal: 1.32

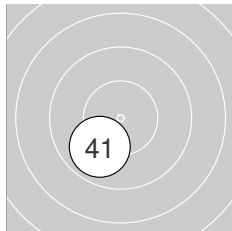

Serie 5: 9 (9.9)

9.9 ↖

beste Teiler:
Trefferlage: 1.54 mm links, 2.12 mm tief
Streuwert: 0.00, horizontal: 0.00, vertikal: 0.00



Ergebnis: 374 (394.3)
Serien: 93 94 94 93 9
Zähler: 16 23 2 0 0 0 0 0 0 0
Innenzehner: 11
Weiteste: 591 (37.), 521 (28.), 474 (21.)
beste Teiler: 57.7 (13.), 58.6 (32.), 85.8 (3.)
Trefferlage: 0.22 mm links, 0.54 mm hoch
Streuwert: 2.11, horizontal: 2.20, vertikal: 2.03

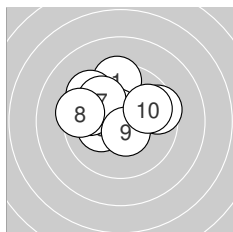
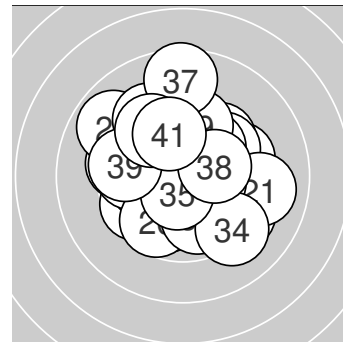

Serie 1: 93 (98.8)

9.5 ↑	9.5 ↘	10.6* ↘	9.5 →	10.2* ←
9.8 ←	9.9 ↘	9.4 ←	10.5* ↓	9.9 →

beste Teiler: 85.8 (3.), 106.4 (9.), 185.3 (5.)
Trefferlage: 0.71 mm links, 1.12 mm hoch
Streuwert: 1.90, horizontal: 2.32, vertikal: 1.35

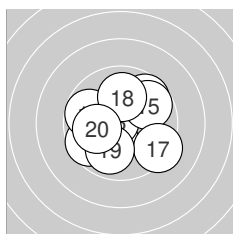

Serie 2: 94 (99.2)

9.7 ↗	10.3* ↓	10.7* ←	9.6 ←	9.8 ↗
9.8 ←	9.3 ↘	10.0 ↑	9.9 ↓	10.1 ←

beste Teiler: 57.7 (13.), 163.6 (12.), 223.1 (20.)
Trefferlage: 0.17 mm links, 0.10 mm tief
Streuwert: 2.06, horizontal: 2.24, vertikal: 1.85

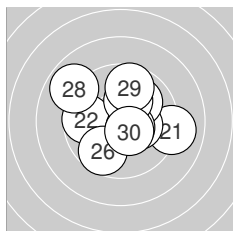

Serie 3: 94 (98.5)

9.1 →	9.7 ←	10.3* →	10.0 ↗	10.5* ↘
9.7 ↓	10.1 ↑	8.9 ↘	9.7 ↑	10.5* ↘

beste Teiler: 106.2 (25.), 119.7 (30.), 166.1 (23.)
Trefferlage: 0.20 mm rechts, 0.45 mm hoch
Streuwert: 2.27, horizontal: 2.58, vertikal: 1.90

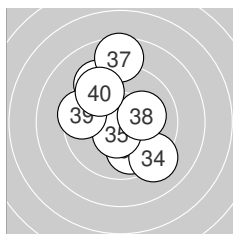

Serie 4: 93 (97.8)

10.4* ↓	10.7* ↘	9.9 ↓	9.2 ↘	10.5* ↓
9.3 ↘	8.6 ↑	10.1 →	9.5 ←	9.6 ↘

beste Teiler: 58.6 (32.), 109.7 (35.), 146.4 (31.)
Trefferlage: 0.13 mm links, 0.48 mm hoch
Streuwert: 2.44, horizontal: 1.95, vertikal: 2.85

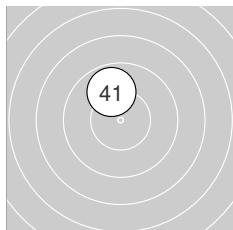

Serie 5: 9 (9.9)

9.9 ↑
beste Teiler:
Trefferlage: 0.84 mm links, 2.58 mm hoch
Streuwert: 0.00, horizontal: 0.00, vertikal: 0.00



Ergebnis: **375** (393.0)
 Serien: 93 95 92 95 9
 Zähler: 17 22 2 0 0 0 0 0 0 0
 Innenzehner: 12
 Weitestе: 535 (30.), 509 (8.), 470 (11.)
 beste Teiler: 34.0 (12.), 38.4 (2.), 84.8 (37.)
 Trefferlage: 0.31 mm rechts, 0.09 mm tief
 Streuwert: 2.25, horizontal: 2.56, vertikal: 1.90

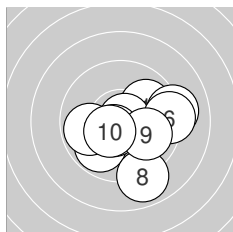
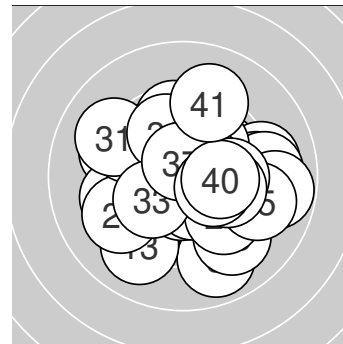

Serie 1: 93 (98.6)

9.9 ↗	10.8* ↗	9.1 →	9.8 ↙	10.6* ↙
9.3 →	9.8 ↖	8.9 ↘	10.0 ↘	10.4* ↘

beste Teiler: 38.4 (2.), 100.2 (5.), 127.4 (10.)
 Trefferlage: 0.94 mm rechts, 0.76 mm tief
 Streuwert: 2.12, horizontal: 2.45, vertikal: 1.73

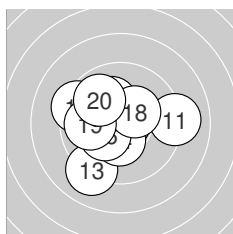

Serie 2: 95 (99.4)

9.1 →	10.8* →	9.1 ↙	10.4* ↓	9.4 ↖
10.3* ↙	10.2* ↖	10.3* ↗	9.9 ←	9.9 ↘

beste Teiler: 34.0 (12.), 145.2 (14.), 156.4 (18.)
 Trefferlage: 0.66 mm links, 0.00 mm
 Streuwert: 2.13, horizontal: 2.41, vertikal: 1.80

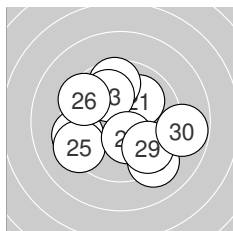

Serie 3: 92 (95.7)

10.0 ↗	9.6 ↑	10.0 ↘	9.4 ←	9.3 ↙
9.5 ↖	10.3* ↘	9.2 ↘	9.6 ↘	8.8 →

beste Teiler: 154.6 (27.), 235.1 (21.), 245.1 (23.)
 Trefferlage: 0.06 mm rechts, 0.22 mm tief
 Streuwert: 2.69, horizontal: 3.02, vertikal: 2.30

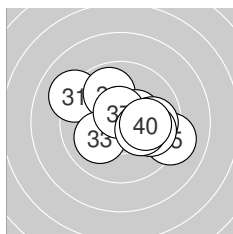

Serie 4: 95 (99.3)

9.1 ↖	9.9 ↖	10.1 ↙	10.4* →	9.1 →
9.9 →	10.6* ↑	9.9 →	10.2* →	10.1 →

beste Teiler: 84.8 (37.), 141.1 (34.), 186.6 (39.)
 Trefferlage: 0.79 mm rechts, 0.17 mm hoch
 Streuwert: 2.00, horizontal: 2.48, vertikal: 1.36

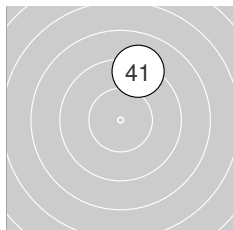

Serie 5: 9 (9.2)

9.2 ↑

beste Teiler:
 Trefferlage: 1.51 mm rechts, 4.22 mm hoch
 Streuwert: 0.00, horizontal: 0.00, vertikal: 0.00



Ergebnis: 380 (398.2)
Serien: 95 97 95 93 10
Zähler: 24 14 3 0 0 0 0 0 0 0
Innenzehner: 16
Weiteste: 527 (31.), 525 (29.), 504 (5.)
beste Teiler: 13.1 (18.), 55.0 (38.), 71.0 (9.)
Trefferlage: 0.64 mm links, 0.46 mm hoch
Streuwert: 1.92, horizontal: 1.96, vertikal: 1.88

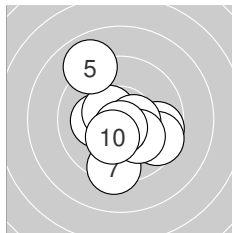
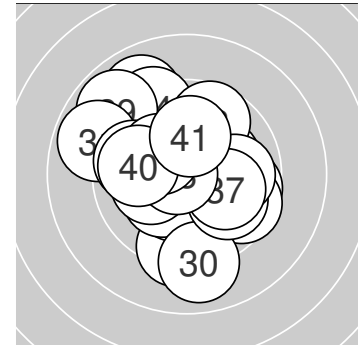

Serie 1: 95 (99.8)

9.7 →	10.2* ←	9.6 →	10.5* ↖	8.9 ↘
10.5* →	9.3 ↓	10.1 ↘	10.7* ↓	10.3* ↙

beste Teiler: 71.0 (9.), 111.8 (6.), 113.8 (4.)
Trefferlage: 0.19 mm rechts, 0.53 mm tief
Streuwert: 2.02, horizontal: 1.92, vertikal: 2.12

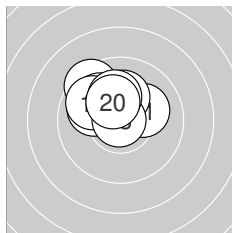

Serie 2: 97 (101.0)

10.1 →	9.9 ↘	9.5 ↘	10.0 ↘	10.2* ↑
10.0 ↖	9.9 ↖	10.9* ←	10.2* ↑	10.3* ↖

beste Teiler: 13.1 (18.), 165.8 (20.), 192.9 (15.)
Trefferlage: 0.99 mm links, 1.49 mm hoch
Streuwert: 1.12, horizontal: 1.39, vertikal: 0.77

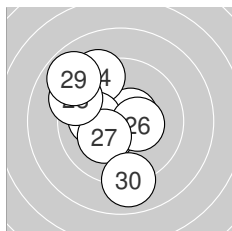

Serie 3: 95 (98.5)

10.4* ↖	10.3* ↙	10.6* ↗	9.3 ↘	10.1 ←
10.4* →	10.2* ↙	9.3 ↖	8.9 ↖	9.0 ↓

beste Teiler: 96.8 (23.), 143.1 (26.), 146.4 (21.)
Trefferlage: 1.24 mm links, 0.31 mm hoch
Streuwert: 2.18, horizontal: 1.81, vertikal: 2.50

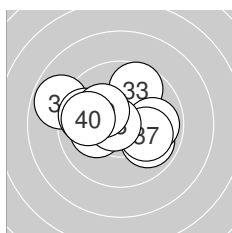

Serie 4: 93 (98.9)

8.8 ↖	9.7 ↖	9.7 ↑	9.9 →	10.1 ←
9.9 →	10.0 →	10.7* ←	10.2* ↖	9.9 ↖

beste Teiler: 55.0 (38.), 187.4 (39.), 206.1 (35.)
Trefferlage: 0.63 mm links, 0.42 mm hoch
Streuwert: 2.05, horizontal: 2.60, vertikal: 1.29

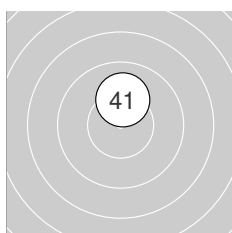

Serie 5: 10 (10.1)

10.1 ↑
beste Teiler:
Trefferlage: 0.18 mm rechts, 2.10 mm hoch
Streuwert: 0.00, horizontal: 0.00, vertikal: 0.00



Ergebnis: **374** (391.2)
 Serien: 96 96 90 92 9
 Zähler: 20 16 4 1 0 0 0 0 0 0
 Innenzehner: 11
 Weitester: 790 (29.), 671 (21.), 571 (27.)
 beste Teiler: 42.9 (40.), 48.0 (6.), 105.2 (37.)
 Trefferlage: 0.45 mm rechts, 0.68 mm tief
 Streuwert: 2.37, horizontal: 1.89, vertikal: 2.77

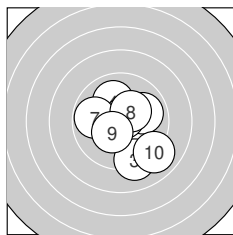
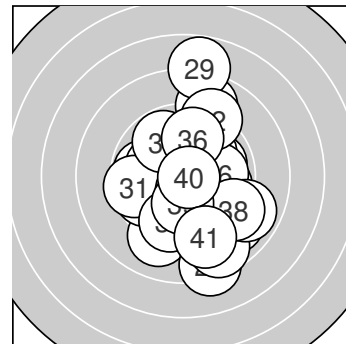

Serie 1: 96 (100.4)

10.5* ↖ 10.5* ↗ 9.2 ↓
 10.8* ↗ 9.8 ← 10.3* ↗
 beste Teiler: 48.0 (6.), 105.5 (2.), 117.6 (1.)
 Trefferlage: 0.50 mm rechts, 0.32 mm tief
 Streuwert: 1.94, horizontal: 1.83, vertikal: 2.04

10.0 ↖ 9.9 ↗
 10.4* ↗ 9.0 ↘

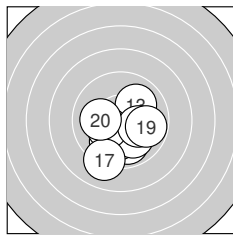

Serie 2: 96 (99.3)

9.9 ↓ 9.9 ↙ 10.0 ↗
 10.3* ↙ 9.1 ↙ 10.1 →
 beste Teiler: 164.8 (16.), 202.7 (18.), 211.9 (14.)
 Trefferlage: 0.16 mm rechts, 1.35 mm tief
 Streuwert: 1.69, horizontal: 1.75, vertikal: 1.64

10.1 ↓ 10.0 ↘
 9.8 → 10.1 ←

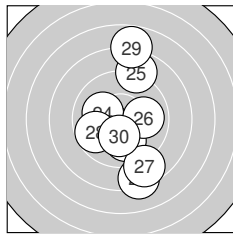

Serie 3: 90 (94.1)

8.3 ↓ 10.5* ↙ 10.0 ↓
 10.0 → 8.7 ↓ 9.7 ↙
 beste Teiler: 120.2 (22.), 182.7 (30.), 206.2 (24.)
 Trefferlage: 0.47 mm rechts, 0.40 mm tief
 Streuwert: 3.30, horizontal: 1.86, vertikal: 4.28

10.1 ↖ 8.8 ↑
 7.8 ↑ 10.2* ↓

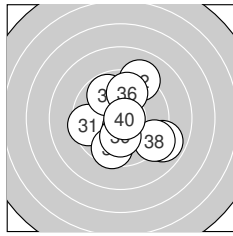

Serie 4: 92 (97.4)

9.5 ← 9.1 ↑ 9.6 ↓
 9.8 ↑ 10.5* ↓ 9.2 ↘
 beste Teiler: 42.9 (40.), 105.2 (37.), 197.0 (39.)
 Trefferlage: 0.57 mm rechts, 0.27 mm tief
 Streuwert: 2.46, horizontal: 2.38, vertikal: 2.53

9.8 ↖ 8.9 ↘
 10.2* ↓ 10.8* →

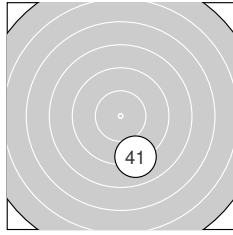

Serie 5: 9 (9.1)

9.1 ↓
 beste Teiler:
 Trefferlage: 1.62 mm rechts, 4.41 mm tief
 Streuwert: 0.00, horizontal: 0.00, vertikal: 0.00



Ergebnis: **372** (392.0)
 Serien: 93 95 94 90 9
 Zähler: 16 21 4 0 0 0 0 0 0 0
 Innenzehner: 12
 Weitester: 724 (31.), 644 (20.), 612 (35.)
 beste Teiler: 61.4 (34.), 64.3 (13.), 64.3 (18.)
 Trefferlage: 0.42 mm rechts, 0.17 mm tief
 Streuwert: 2.36, horizontal: 2.61, vertikal: 2.08

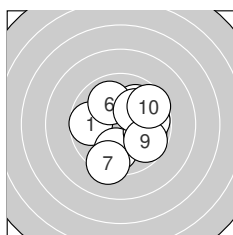
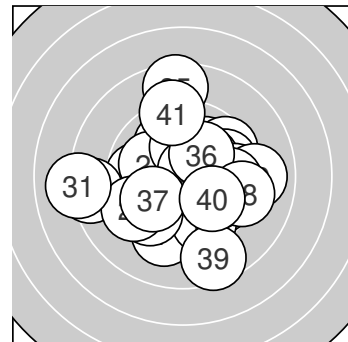

Serie 1: 93 (98.0)
 9.7 ← 9.9 ↓ 10.0 ↗
 10.0 ↘ 9.3 ↓ 10.1 ↗
 beste Teiler: 205.8 (8.), 239.4 (3.), 247.3 (6.)
 Trefferlage: 0.78 mm rechts, 0.12 mm tief
 Streuwert: 2.11, horizontal: 2.12, vertikal: 2.10

9.9 → 9.8 →
 9.7 → 9.6 →

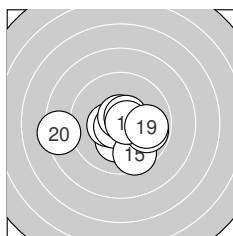

Serie 2: 95 (101.1)
 10.2* ↓ 10.5* ← 10.7* ↖
 9.8 → 10.6* ↗ 10.7* →
 beste Teiler: 64.3 (13.), 64.3 (18.), 69.0 (14.)
 Trefferlage: 0.06 mm links, 0.61 mm tief
 Streuwert: 1.99, horizontal: 2.58, vertikal: 1.14

10.7* ↑ 9.6 ↓
 9.9 → 8.4 ←

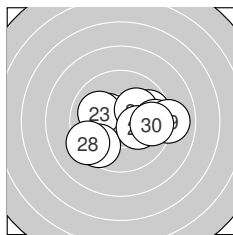

Serie 3: 94 (97.6)
 9.7 → 10.4* ↖ 10.0 ↖
 10.2* → 9.5 → 9.3 ↖
 beste Teiler: 144.9 (22.), 190.4 (26.), 198.8 (24.)
 Trefferlage: 0.88 mm rechts, 0.21 mm tief
 Streuwert: 2.25, horizontal: 2.91, vertikal: 1.29

10.2* ↗ 9.6 ↖
 9.0 → 9.7 →

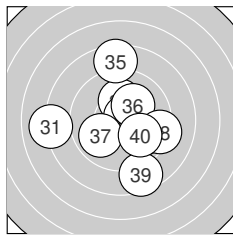

Serie 4: 90 (95.3)
 8.1 ← 9.9 ↘ 10.2* ↑
 10.2* ↗ 9.9 ↖ 9.3 →
 beste Teiler: 61.4 (34.), 198.7 (36.), 200.0 (33.)
 Trefferlage: 0.22 mm rechts, 0.20 mm tief
 Streuwert: 3.09, horizontal: 3.12, vertikal: 3.05

10.7* ↗ 8.5 ↑
 8.6 ↓ 9.9 ↘

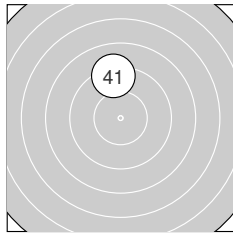

Serie 5: 9 (9.2)
 9.2 ↑
 beste Teiler:
 Trefferlage: 0.75 mm links, 4.36 mm hoch
 Streuwert: 0.00, horizontal: 0.00, vertikal: 0.00



Ergebnis: **350** (370.5)
 Serien: 85 90 92 83 8
 Zähler: 11 13 14 2 0 1 0 0 0 0 0
 Innenzehner: 9
 Weitester: 1300 (35.), 918 (5.), 817 (4.)
 beste Teiler: 21.2 (38.), 62.8 (6.), 83.8 (30.)
 Trefferlage: 1.22 mm links, 0.60 mm hoch
 Streuwert: 3.42, horizontal: 4.08, vertikal: 2.59

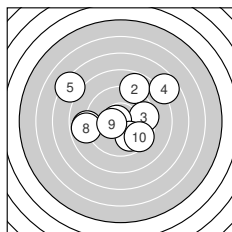
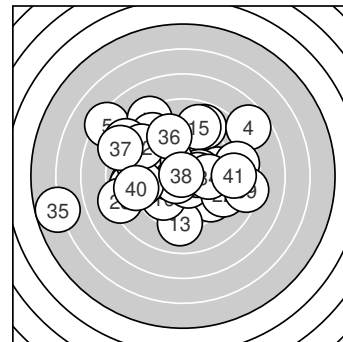

Serie 1: 85 (91.6)

8.9 ← 8.8 ↑ 9.5 → 7.7 ↗ 7.3 ↘
 10.7* ← 9.9 ↘ 8.9 ← 10.4* ← 9.5 ↘
 beste Teiler: 62.8 (6.), 138.0 (9.), 264.4 (7.)
 Trefferlage: 0.34 mm links, 0.91 mm hoch
 Streuwert: 3.79, horizontal: 4.48, vertikal: 2.96

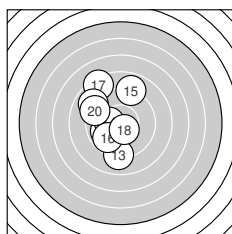

Serie 2: 90 (94.9)

10.0 ↙ 9.9 ← 9.1 ↓ 10.3* ← 8.9 ↑
 9.8 ↙ 8.3 ↘ 10.5* ↘ 8.9 ↘ 9.2 ↘
 beste Teiler: 109.2 (18.), 171.8 (14.), 248.9 (11.)
 Trefferlage: 1.71 mm links, 0.47 mm hoch
 Streuwert: 2.70, horizontal: 1.86, vertikal: 3.33

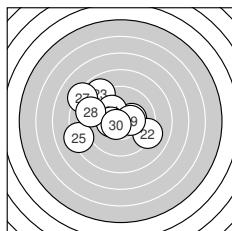

Serie 3: 92 (95.6)

10.3* → 9.2 ↘ 8.9 ↘ 10.1 ↘ 8.3 ←
 10.4* ← 8.3 ↘ 9.1 ← 10.4* → 10.6* ↗
 beste Teiler: 83.8 (30.), 144.5 (26.), 148.4 (29.)
 Trefferlage: 1.58 mm links, 0.62 mm hoch
 Streuwert: 2.81, horizontal: 3.38, vertikal: 2.10

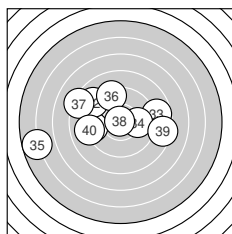

Serie 4: 83 (88.4)

9.3 ← 8.9 ↘ 8.7 → 9.9 → 5.8 ←
 9.3 ↘ 8.2 ↘ 10.9* ↘ 8.4 → 9.0 ←
 beste Teiler: 21.2 (38.), 257.0 (34.), 420.9 (36.)
 Trefferlage: 1.90 mm links, 0.44 mm hoch
 Streuwert: 4.37, horizontal: 5.73, vertikal: 2.30

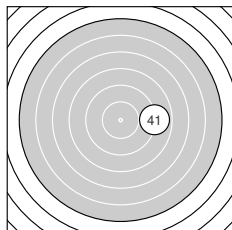

Serie 5: 8 (8.9)

8.9 →
 beste Teiler:
 Trefferlage: 5.10 mm rechts, 0.05 mm hoch
 Streuwert: 0.00, horizontal: 0.00, vertikal: 0.00



Ergebnis: 379 (396.1)
Serien: 95 94 95 95 9
Zähler: 22 16 3 0 0 0 0 0 0 0
Innenzehner: 15
Weiteste: 589 (30.), 532 (28.), 511 (16.)
beste Teiler: 70.6 (25.), 79.5 (20.), 82.2 (33.)
Trefferlage: 0.88 mm rechts, 0.38 mm hoch
Streuwert: 1.99, horizontal: 2.19, vertikal: 1.78

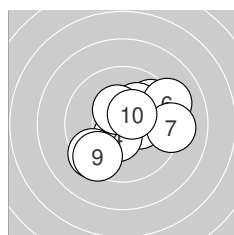
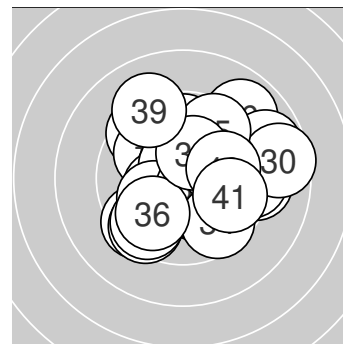

Serie 1: 95 (98.9)

9.7 ↗ 10.2* ↗ 10.3* → 10.5* ↓ 10.4* ↖
 9.2 ↗ 9.2 → 9.4 ↗ 9.5 ↗ 10.5* ↗

beste Teiler: 124.4 (10.), 124.6 (4.), 140.8 (5.)
Trefferlage: 0.87 mm rechts, 0.04 mm hoch
Streuwert: 2.12, horizontal: 2.41, vertikal: 1.79

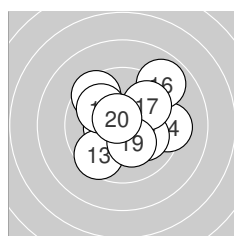

Serie 2: 94 (98.5)

9.5 ↘ 10.4* ← 9.6 ↗ 9.3 → 10.1 ↘
 8.9 ↗ 9.8 ↗ 10.0 ↘ 10.3* ↘ 10.6* ↘

beste Teiler: 79.5 (20.), 133.3 (12.), 175.3 (19.)
Trefferlage: 0.42 mm rechts, 0.47 mm hoch
Streuwert: 2.22, horizontal: 2.42, vertikal: 1.99

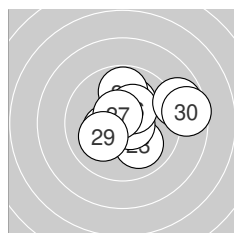

Serie 3: 95 (99.4)

10.1 ↗ 10.4* ← 10.0 ↘ 9.8 ↑ 10.7* →
 10.3* ↗ 10.6* ↘ 8.8 → 10.1 ↗ 8.6 →

beste Teiler: 70.6 (25.), 87.8 (27.), 149.4 (22.)
Trefferlage: 1.11 mm rechts, 0.59 mm hoch
Streuwert: 2.05, horizontal: 2.48, vertikal: 1.50

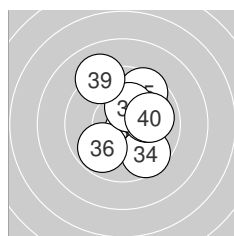

Serie 4: 95 (99.3)

10.0 → 10.4* → 10.6* ↘ 9.6 ↘ 9.6 ↗
 9.8 ↗ 10.0 → 10.3* ↗ 9.1 ↘ 9.9 →

beste Teiler: 82.2 (33.), 148.9 (32.), 164.7 (38.)
Trefferlage: 0.95 mm rechts, 0.57 mm hoch
Streuwert: 1.86, horizontal: 1.66, vertikal: 2.04

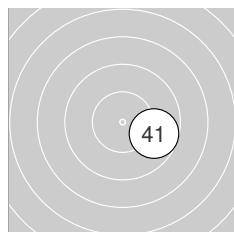

Serie 5: 9 (9.7)

9.7 ↘

beste Teiler:
Trefferlage: 2.85 mm rechts, 1.04 mm tief
Streuwert: 0.00, horizontal: 0.00, vertikal: 0.00

