

Ergebnis: **414.9** (397)
 Serien: 104.0 104.0 104.4 102.5
 Zaehler: 37 3 0 0 0 0 0 0 0 0
 Innenzehner: 30
 weiteste: 273 (32), 273 (37), 254 (20)
 beste Teiler 23.0 (12.) 47.4 (8.) 64.0 (6.)
 Trefferlage 0.17 mm links, 0.07 mm hoch
 Streuwert 1.14, horizontal: 1.16, vertikal: 1.11

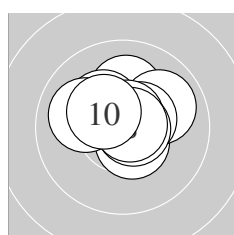

Serie 1:
 10.1 ↑ 10.5 * 10.0 ↗ 10.5 * 10.3 *
 10.7 * 10.7 * 10.8 * 10.0 ↖ 10.4 *
 beste Teiler 47.4 (8.) 64.0 (6.) 65.7 (7.)
 Trefferlage 0.08 mm rechts, 0.64 mm hoch
 Streuwert 1.07, horizontal: 1.27, vertikal: 0.81

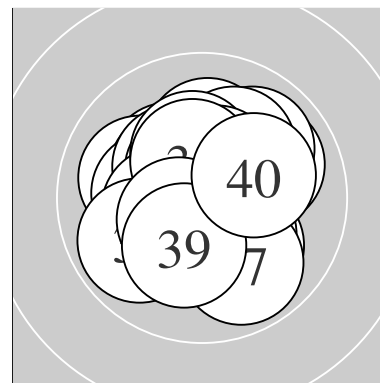
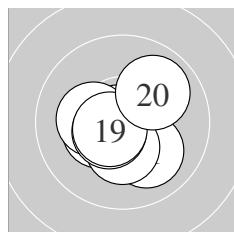

Serie 2:
 10.1 ↘ 10.9 * 10.4 * 10.6 * 10.4 *
 10.2 * 10.3 * 10.6 * 10.6 * 9.9 ↗
 beste Teiler 23.0 (12.) 88.1 (19.) 96.4 (14.)
 Trefferlage 0.37 mm links, 0.37 mm tief
 Streuwert 1.08, horizontal: 1.18, vertikal: 0.96

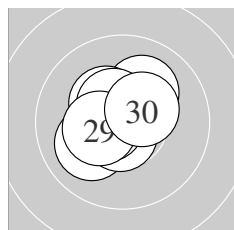

Serie 3:
 10.1 ↗ 10.4 * 10.6 * 10.1 ↖ 10.6 *
 10.7 * 10.6 * 10.5 * 10.4 * 10.4 *
 beste Teiler 74.5 (26.) 78.7 (25.) 94.9 (23.)
 Trefferlage 0.52 mm links, 0.21 mm hoch
 Streuwert 0.97, horizontal: 0.99, vertikal: 0.95

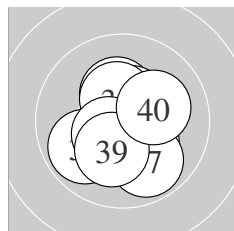

Serie 4:
 10.3 * 9.9 ↙ 10.2 * 10.5 * 10.5 *
 10.4 * 9.9 ↘ 10.5 * 10.2 * 10.1 ↗
 beste Teiler 104.7 (34.) 114.6 (38.) 121.2 (35.)
 Trefferlage 0.10 mm rechts, 0.19 mm tief
 Streuwert 1.37, horizontal: 1.24, vertikal: 1.49

Unterschrift des Schuetzen

Meyton Elektronik

Ergebnis: **409.7** (393)
 Serien: 102.2 101.2 104.1 102.2
 Zaehler: 33 7 0 0 0 0 0 0 0 0
 Innenzehner: 26
 weiteste: 403 (15), 381 (4), 304 (1)
 beste Teiler 53.4 (24.) 55.0 (35.) 64.4 (7.)
 Trefferlage 0.01 mm rechts, 0.14 mm tief
 Streuwert 1.40, horizontal: 1.52, vertikal: 1.26

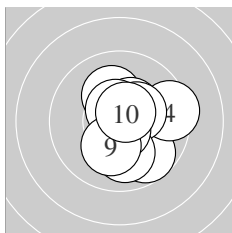
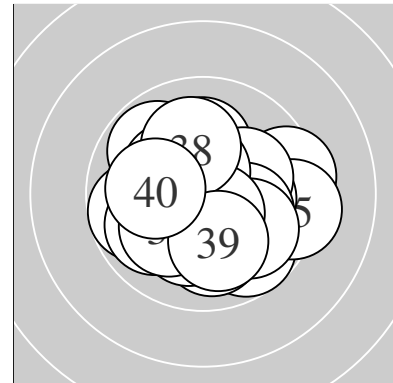

Serie 1:
 9.7 ↘ 10.2 * 10.4 * 9.4 → 10.4 *
 10.0 ↓ 10.7 * 10.6 * 10.2 * 10.6 *
 beste Teiler 64.4 (7.) 80.7 (10.) 93.3 (8.)
 Trefferlage 0.71 mm rechts, 0.12 mm tief
 Streuwert 1.45, horizontal: 1.34, vertikal: 1.55

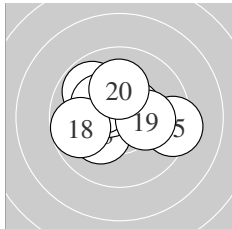

Serie 2:
 10.6 * 10.5 * 10.2 * 9.8 ↘ 9.3 →
 10.5 * 10.3 * 9.7 ← 10.2 * 10.1 ↑
 beste Teiler 89.2 (11.) 104.3 (12.) 111.1 (16.)
 Trefferlage 0.27 mm links, 0.35 mm hoch
 Streuwert 1.65, horizontal: 2.05, vertikal: 1.12

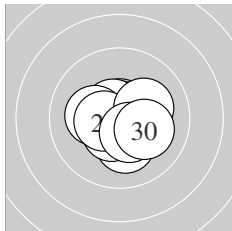

Serie 3:
 10.2 * 10.7 * 10.5 * 10.7 * 10.6 *
 10.2 * 10.5 * 10.2 * 10.4 * 10.1 ↘
 beste Teiler 53.4 (24.) 69.0 (22.) 83.6 (25.)
 Trefferlage 0.07 mm rechts, 0.21 mm tief
 Streuwert 1.06, horizontal: 1.19, vertikal: 0.92

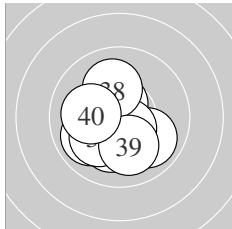

Serie 4:
 9.9 ↘ 9.9 ↙ 10.6 * 10.2 * 10.7 *
 10.5 * 10.1 ↙ 10.1 ↑ 10.1 ↓ 10.1 ←
 beste Teiler 55.0 (35.) 100.8 (33.) 101.3 (36.)
 Trefferlage 0.44 mm links, 0.59 mm tief
 Streuwert 1.35, horizontal: 1.32, vertikal: 1.38

Unterschrift des Schuetzen

Meyton Elektronik

Ergebnis: **408.4** (393)
 Serien: 100.0 101.6 103.7 103.1
 Zaehler: 34 5 1 0 0 0 0 0 0
 Innenzehner: 26
 weiteste: 608 (1), 278 (10), 277 (16)
 beste Teiler 57.1 (37.) 67.0 (23.) 85.0 (21.)
 Trefferlage 0.12 mm rechts, 0.73 mm hoch
 Streuwert 1.38, horizontal: 1.52, vertikal: 1.22

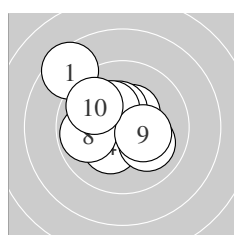
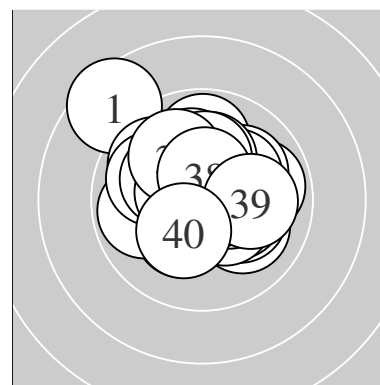

Serie 1:
 8.5 ↘ 10.4 * 10.4 * 10.3 * 10.1 ↘
 10.3 * 10.0 ↘ 9.9 ← 10.3 * 9.8 ↘
 beste Teiler 133.1 (2.) 141.9 (3.) 167.5 (6.)
 Trefferlage 0.88 mm links, 0.74 mm hoch
 Streuwert 1.84, horizontal: 1.94, vertikal: 1.75

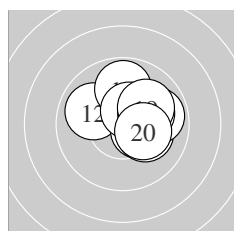

Serie 2:
 10.4 * 9.9 ↖ 10.4 * 10.2 * 9.9 →
 9.8 ↑ 10.5 * 10.1 ↗ 10.1 ↗ 10.3 *
 beste Teiler 118.1 (17.) 137.6 (13.) 147.1 (11.)
 Trefferlage 1.02 mm rechts, 0.69 mm hoch
 Streuwert 1.23, horizontal: 1.39, vertikal: 1.06

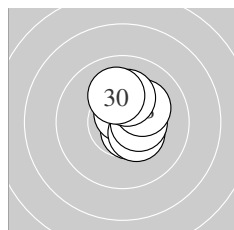

Serie 3:
 10.6 * 10.4 * 10.7 * 10.3 * 10.4 *
 10.4 * 10.4 * 10.2 * 10.2 * 10.1 ↑
 beste Teiler 67.0 (23.) 85.0 (21.) 126.7 (26.)
 Trefferlage 0.66 mm rechts, 0.75 mm hoch
 Streuwert 0.86, horizontal: 0.65, vertikal: 1.03

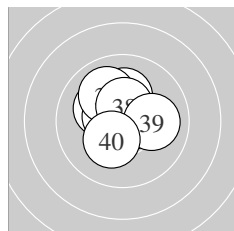

Serie 4:
 10.6 * 10.2 * 10.1 ↖ 10.5 * 10.2 *
 10.0 ↘ 10.7 * 10.5 * 10.0 → 10.3 *
 beste Teiler 57.1 (37.) 89.4 (31.) 101.9 (34.)
 Trefferlage 0.31 mm links, 0.74 mm hoch
 Streuwert 1.13, horizontal: 1.14, vertikal: 1.11

Unterschrift des Schuetzen

Meyton Elektronik

Ergebnis: **404.8** (389)
 Serien: 100.3 101.1 102.3 101.1
 Zaehler: 29 11 0 0 0 0 0 0 0 0
 Innenzehner: 23
 weiteste: 465 (3), 450 (12), 418 (37)
 beste Teiler 16.1 (15.) 21.1 (22.) 31.0 (19.)
 Trefferlage 0.11 mm links, 0.26 mm tief
 Streuwert 1.64, horizontal: 1.84, vertikal: 1.40

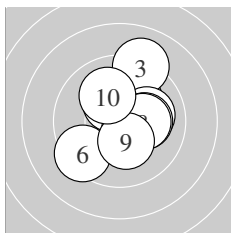
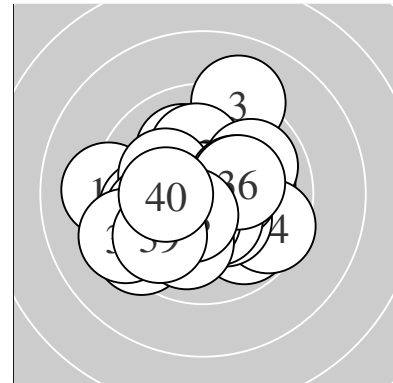

Serie 1:
 10.3 * 10.1 ↗ 9.1 ↑ 10.1 → 10.2 *
 9.4 ↙ 10.5 * 10.2 * 10.3 * 10.1 ↘
 beste Teiler 101.5 (7.) 155.2 (1.) 165.0 (9.)
 Trefferlage 0.55 mm rechts, 0.52 mm hoch
 Streuwert 1.80, horizontal: 1.63, vertikal: 1.96

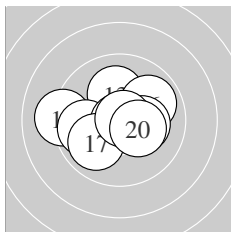

Serie 2:
 10.0 ↙ 9.2 ← 10.1 ↑ 9.8 ← 10.9 *
 9.9 ↗ 9.9 ↙ 10.2 * 10.8 * 10.3 *
 beste Teiler 16.1 (15.) 31.0 (19.) 160.2 (20.)
 Trefferlage 0.57 mm links, 0.08 mm tief
 Streuwert 1.73, horizontal: 2.17, vertikal: 1.11

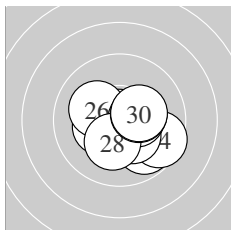

Serie 3:
 9.8 ↘ 10.9 * 10.3 * 9.6 ↘ 10.3 *
 10.2 * 10.4 * 10.2 * 10.3 * 10.3 *
 beste Teiler 21.1 (22.) 133.4 (27.) 158.7 (23.)
 Trefferlage 0.65 mm rechts, 0.48 mm tief
 Streuwert 1.35, horizontal: 1.58, vertikal: 1.07

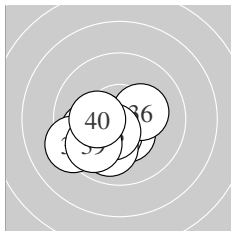

Serie 4:
 10.4 * 9.9 ↙ 10.3 * 10.4 * 10.0 ↙
 10.3 * 9.3 ↙ 10.5 * 9.8 ↙ 10.2 *
 beste Teiler 115.9 (38.) 130.9 (34.) 131.4 (31.)
 Trefferlage 1.10 mm links, 1.03 mm tief
 Streuwert 1.27, horizontal: 1.54, vertikal: 0.93

Unterschrift des Schuetzen

Meyton Elektronik

Ergebnis: **411.3** (394)
 Serien: 100.8 104.3 103.0 103.2
 Zaehler: 34 6 0 0 0 0 0 0 0 0
 Innenzehner: 25
 weiteste: 415 (9), 395 (28), 382 (3)
 beste Teiler 11.7 (24.) 30.0 (17.) 38.6 (11.)
 Trefferlage 0.29 mm rechts, 0.56 mm hoch
 Streuwert 1.32, horizontal: 1.62, vertikal: 0.95

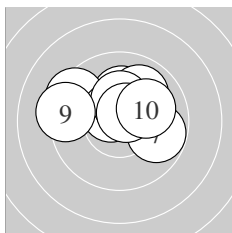
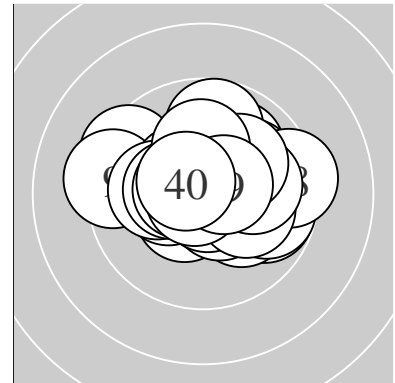

Serie 1:
 10.2 * 10.0 ↗ 9.4 ↘ 10.6 * 10.5 *
 10.3 * 9.8 → 10.6 * 9.3 ← 10.1 ↗
 beste Teiler 80.6 (8.) 92.6 (4.) 107.5 (5.)
 Trefferlage 0.08 mm links, 1.03 mm hoch
 Streuwert 1.66, horizontal: 2.18, vertikal: 0.87

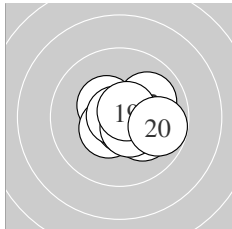

Serie 2:
 10.8 * 10.0 ↗ 10.4 * 10.5 * 10.1 ↘
 10.7 * 10.8 * 10.5 * 10.7 * 9.8 →
 beste Teiler 30.0 (17.) 38.6 (11.) 67.4 (16.)
 Trefferlage 0.59 mm rechts, 0.13 mm tief
 Streuwert 1.07, horizontal: 1.30, vertikal: 0.78

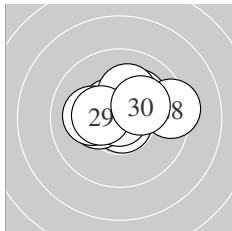

Serie 3:
 10.8 * 10.3 * 10.5 * 10.9 * 10.2 *
 10.1 ← 10.2 * 9.4 → 10.4 * 10.2 *
 beste Teiler 11.7 (24.) 45.1 (21.) 102.6 (23.)
 Trefferlage 0.18 mm rechts, 0.57 mm hoch
 Streuwert 1.36, horizontal: 1.79, vertikal: 0.71

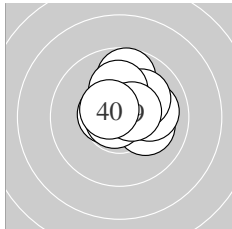

Serie 4:
 10.6 * 10.1 → 10.7 * 9.7 ↑ 10.0 →
 10.8 * 10.1 ↗ 10.1 ↑ 10.5 * 10.6 *
 beste Teiler 39.8 (36.) 58.1 (33.) 97.2 (40.)
 Trefferlage 0.46 mm rechts, 0.77 mm hoch
 Streuwert 1.13, horizontal: 1.17, vertikal: 1.08

Unterschrift des Schuetzen

Meyton Elektronik

Ergebnis: **393.5** (378)
 Serien: 95.7 99.8 101.6 96.4
 Zaehler: 28 7 3 0 1 1 0 0 0 0
 Innenzehner: 16
 weiteste: 1347 (7), 1223 (40), 608 (26)
 beste Teiler 58.1 (27.) 69.2 (13.) 70.2 (25.)
 Trefferlage 0.35 mm links, 0.33 mm tief
 Streuwert 2.71, horizontal: 3.43, vertikal: 1.71

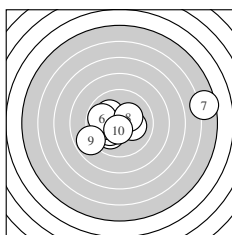
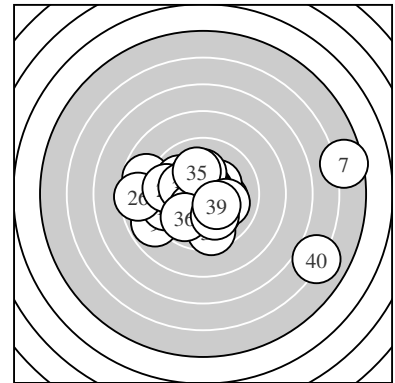

Serie 1:
 10.1 → 10.1 ↖ 10.0 ↙ 10.2 * 10.2 *
 9.8 ← 5.6 → 10.3 * 8.9 ↙ 10.5 *
 beste Teiler 102.6 (10.) 165.5 (8.) 194.7 (4.)
 Trefferlage 0.25 mm rechts, 0.14 mm tief
 Streuwert 3.66, horizontal: 4.91, vertikal: 1.64

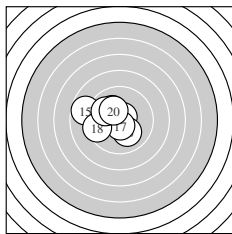

Serie 2:
 10.2 * 10.1 ↖ 10.7 * 9.8 ← 8.7 ←
 10.1 ↘ 10.6 * 9.5 ← 9.9 ↖ 10.2 *
 beste Teiler 69.2 (13.) 85.8 (17.) 176.1 (20.)
 Trefferlage 1.56 mm links, 0.36 mm hoch
 Streuwert 1.67, horizontal: 1.97, vertikal: 1.31

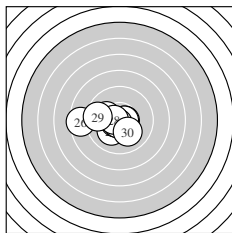

Serie 3:
 10.1 ↙ 10.6 * 10.6 * 10.1 ← 10.7 *
 8.5 ← 10.7 * 10.6 * 9.6 ← 10.1 ↘
 beste Teiler 58.1 (27.) 70.2 (25.) 77.8 (22.)
 Trefferlage 1.18 mm links, 0.35 mm tief
 Streuwert 1.67, horizontal: 2.22, vertikal: 0.81

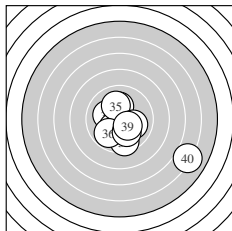

Serie 4:
 10.1 ↖ 9.5 ↓ 10.2 * 10.3 * 10.1 ↑
 9.8 ↙ 10.0 → 10.0 ↘ 10.3 * 6.1 →
 beste Teiler 160.2 (34.) 163.3 (39.) 196.0 (33.)
 Trefferlage 1.06 mm rechts, 1.22 mm tief
 Streuwert 3.10, horizontal: 3.61, vertikal: 2.48

Unterschrift des Schuetzen

Meyton Elektronik

Ergebnis: **411.6** (395)
 Serien: 102.9 101.5 104.9 102.3
 Zaehler: 35 5 0 0 0 0 0 0 0 0
 Innenzehner: 25
 weiteste: 327 (30), 294 (7), 287 (33)
 beste Teiler 14.7 (22.) 26.0 (39.) 42.9 (26.)
 Trefferlage 0.47 mm rechts, 0.79 mm tief
 Streuwert 1.11, horizontal: 1.17, vertikal: 1.06

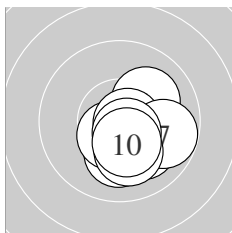
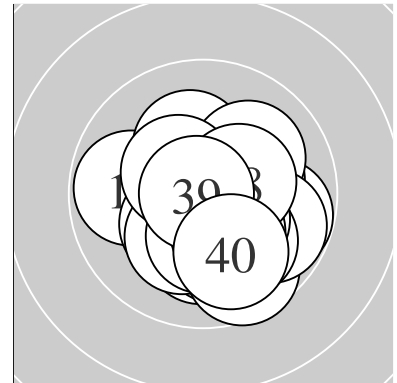

Serie 1:
 10.1 ↗ 10.1 ↘ 10.1 ↓ 10.5 * 10.5 *
 10.7 * 9.8 ↘ 10.6 * 10.1 ↓ 10.4 *
 beste Teiler 53.1 (6.) 87.9 (8.) 107.5 (5.)
 Trefferlage 0.82 mm rechts, 0.92 mm tief
 Streuwert 0.97, horizontal: 0.96, vertikal: 0.98

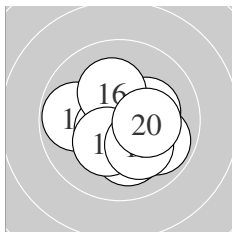

Serie 2:
 10.1 ↓ 10.2 * 10.1 ↓ 9.8 ← 10.6 *
 10.2 * 9.9 ↘ 10.3 * 10.1 ↓ 10.2 *
 beste Teiler 91.6 (15.) 162.2 (18.) 176.8 (20.)
 Trefferlage 0.35 mm rechts, 0.64 mm tief
 Streuwert 1.42, horizontal: 1.57, vertikal: 1.24

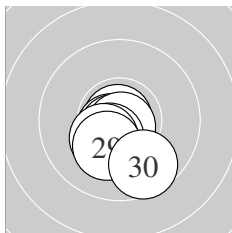

Serie 3:
 10.7 * 10.9 * 10.7 * 10.6 * 10.7 *
 10.8 * 10.4 * 10.3 * 10.2 * 9.6 ↓
 beste Teiler 14.7 (22.) 42.9 (26.) 58.5 (21.)
 Trefferlage 0.19 mm links, 0.95 mm tief
 Streuwert 0.78, horizontal: 0.72, vertikal: 0.83

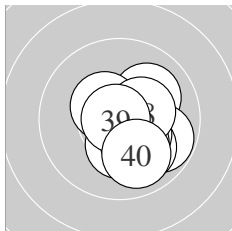

Serie 4:
 10.1 ↗ 10.3 * 9.8 ↘ 10.4 * 10.0 ↓
 10.3 * 10.2 * 10.4 * 10.8 * 10.0 ↓
 beste Teiler 26.0 (39.) 128.3 (34.) 148.3 (38.)
 Trefferlage 0.92 mm rechts, 0.66 mm tief
 Streuwert 1.16, horizontal: 1.05, vertikal: 1.26

Unterschrift des Schuetzen

Meyton Elektronik

Ergebnis: **410.9** (393)
 Serien: 103.5 102.6 103.3 101.5
 Zaehler: 33 7 0 0 0 0 0 0 0 0
 Innenzehner: 27
 weiteste: 409 (29), 350 (38), 328 (36)
 beste Teiler 15.2 (25.) 16.2 (23.) 32.5 (17.)
 Trefferlage 0.47 mm links, 0.29 mm hoch
 Streuwert 1.31, horizontal: 1.62, vertikal: 0.88

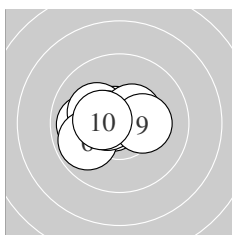
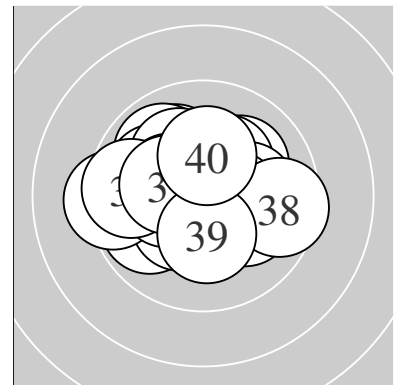

Serie 1:
 9.9 ← 10.7 * 10.7 * 10.3 * 10.2 *
 9.9 ↙ 10.6 * 10.5 * 10.3 * 10.4 *
 beste Teiler 56.2 (3.) 66.0 (2.) 91.9 (7.)
 Trefferlage 0.87 mm links, 0.18 mm hoch
 Streuwert 1.06, horizontal: 1.37, vertikal: 0.61

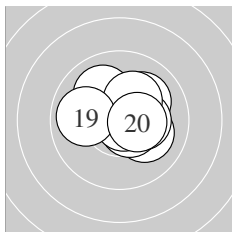

Serie 2:
 10.1 ↘ 10.1 ↗ 10.1 ↖ 10.6 * 10.3 *
 10.0 ↘ 10.8 * 10.3 * 9.9 ← 10.4 *
 beste Teiler 32.5 (17.) 95.8 (14.) 133.8 (20.)
 Trefferlage 0.36 mm rechts, 0.49 mm hoch
 Streuwert 1.29, horizontal: 1.51, vertikal: 1.03

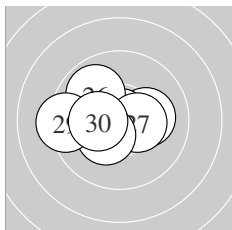

Serie 3:
 10.5 * 10.2 * 10.9 * 10.6 * 10.9 *
 9.9 ↘ 10.4 * 10.3 * 9.3 ← 10.3 *
 beste Teiler 15.2 (25.) 16.2 (23.) 78.5 (24.)
 Trefferlage 0.68 mm links, 0.00 mm
 Streuwert 1.33, horizontal: 1.70, vertikal: 0.79

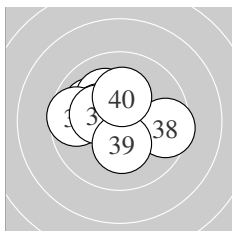

Serie 4:
 10.7 * 10.0 ↖ 10.4 * 10.1 ↘ 10.3 *
 9.6 ← 10.3 * 9.6 → 10.3 * 10.2 *
 beste Teiler 63.5 (31.) 148.2 (33.) 157.8 (35.)
 Trefferlage 0.72 mm links, 0.52 mm hoch
 Streuwert 1.48, horizontal: 1.80, vertikal: 1.06

Unterschrift des Schuetzen

Ergebnis: **400.7** (388)
 Serien: 100.7 99.8 100.2 100.0
 Zaehler: 28 12 0 0 0 0 0 0 0 0
 Innenzehner: 13
 weiteste: 424 (35), 388 (34), 387 (18)
 beste Teiler 89.8 (8.) 112.1 (39.) 120.9 (21.)
 Trefferlage 0.12 mm links, 0.11 mm hoch
 Streuwert 1.77, horizontal: 1.86, vertikal: 1.68

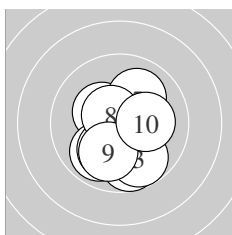
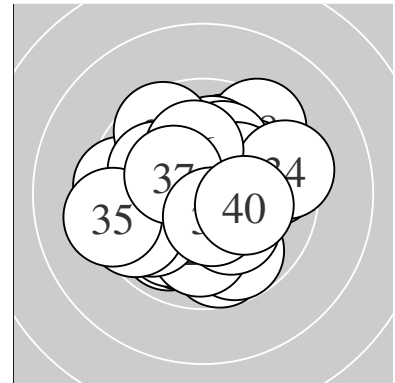

Serie 1:
 10.1 ↘ 9.7 ↘ 9.8 ↘ 10.3 * 10.0 ↗
 9.9 ↗ 10.1 ↗ 10.6 * 10.0 ↘ 10.2 *
 beste Teiler 89.8 (8.) 159.2 (4.) 198.2 (10.)
 Trefferlage 0.11 mm rechts, 1.01 mm tief
 Streuwert 1.52, horizontal: 1.31, vertikal: 1.71

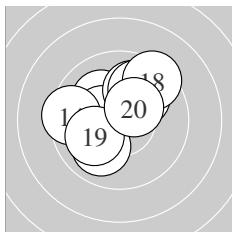

Serie 2:
 10.1 ↖ 10.0 ↗ 10.4 * 9.5 ← 10.0 ↗
 10.0 ↗ 9.9 ↗ 9.4 ↗ 10.1 ↗ 10.4 *
 beste Teiler 134.2 (13.) 146.5 (20.) 209.6 (11.)
 Trefferlage 0.21 mm links, 0.94 mm hoch
 Streuwert 1.79, horizontal: 1.97, vertikal: 1.59

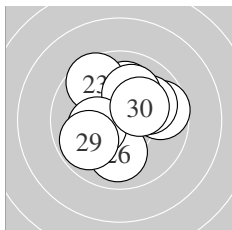

Serie 3:
 10.5 * 10.1 ↑ 9.6 ↖ 9.7 → 10.0 ↗
 10.0 ↓ 10.1 ↑ 10.2 * 9.8 ↗ 10.2 *
 beste Teiler 120.9 (21.) 176.9 (28.) 183.0 (30.)
 Trefferlage 0.09 mm rechts, 0.60 mm hoch
 Streuwert 1.75, horizontal: 1.83, vertikal: 1.67

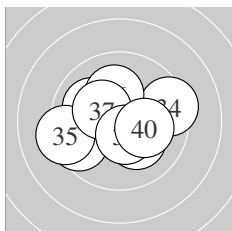

Serie 4:
 10.4 * 9.6 ↖ 10.0 ↖ 9.4 → 9.3 ←
 10.1 ↑ 10.3 * 10.2 * 10.5 * 10.2 *
 beste Teiler 112.1 (39.) 130.0 (31.) 159.2 (37.)
 Trefferlage 0.50 mm links, 0.05 mm tief
 Streuwert 1.90, horizontal: 2.38, vertikal: 1.25

Unterschrift des Schuetzen

Meyton Elektronik

Ergebnis: **412.1** (393)
 Serien: 101.6 103.7 103.8 103.0
 Zaehler: 33 7 0 0 0 0 0 0 0 0
 Innenzehner: 28
 weiteste: 336 (27), 324 (8), 321 (5)
 beste Teiler 64.6 (24.) 67.4 (19.) 68.8 (1.)
 Trefferlage 0.17 mm rechts, 0.63 mm tief
 Streuwert 1.21, horizontal: 1.35, vertikal: 1.04

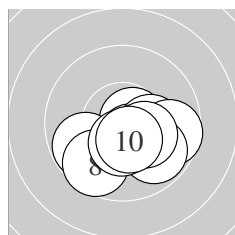
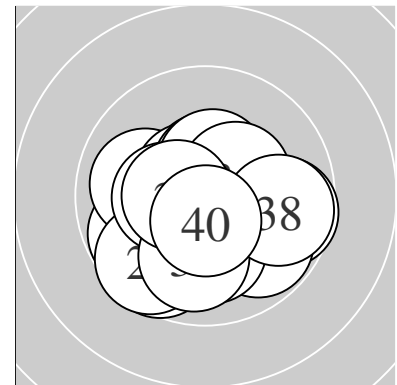

Serie 1:
 10.7 * 9.8 ↙ 10.5 * 10.2 * 9.7 →
 9.8 ↘ 10.3 * 9.7 ↘ 10.4 * 10.5 *
 beste Teiler 68.8 (1.) 110.6 (3.) 119.4 (10.)
 Trefferlage 0.59 mm rechts, 1.09 mm tief
 Streuwert 1.35, horizontal: 1.73, vertikal: 0.80

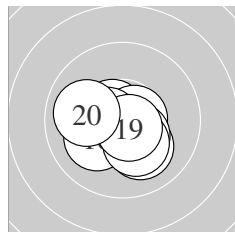

Serie 2:
 10.6 * 10.5 * 10.1 ↘ 10.6 * 10.5 *
 10.1 ↙ 10.4 * 10.2 * 10.7 * 10.0 ←
 beste Teiler 67.4 (19.) 78.6 (14.) 85.2 (11.)
 Trefferlage 0.13 mm links, 0.60 mm tief
 Streuwert 1.06, horizontal: 1.26, vertikal: 0.83

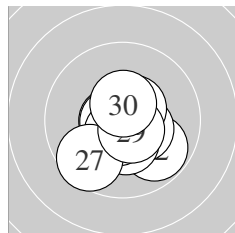

Serie 3:
 10.7 * 9.8 ↘ 10.4 * 10.7 * 10.4 *
 10.6 * 9.6 ↙ 10.5 * 10.6 * 10.5 *
 beste Teiler 64.6 (24.) 71.1 (21.) 87.1 (29.)
 Trefferlage 0.10 mm rechts, 0.61 mm tief
 Streuwert 1.16, horizontal: 1.19, vertikal: 1.13

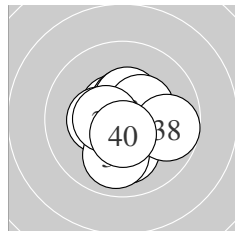

Serie 4:
 10.6 * 10.5 * 10.1 ↓ 10.3 * 10.4 *
 10.4 * 10.0 ↓ 9.7 → 10.5 * 10.5 *
 beste Teiler 95.0 (31.) 101.0 (40.) 113.0 (39.)
 Trefferlage 0.11 mm rechts, 0.23 mm tief
 Streuwert 1.28, horizontal: 1.27, vertikal: 1.30

Unterschrift des Schuetzen

Meyton Elektronik

Ergebnis: **403.1** (383)
 Serien: 99.9 100.1 101.8 101.3
 Zaehler: 25 14 0 1 0 0 0 0 0 0
 Innenzehner: 16
 weiteste: 770 (16), 402 (35), 392 (21)
 beste Teiler 19.9 (33.) 42.5 (38.) 51.4 (17.)
 Trefferlage 0.07 mm rechts, 0.61 mm hoch
 Streuwert 1.79, horizontal: 1.79, vertikal: 1.79

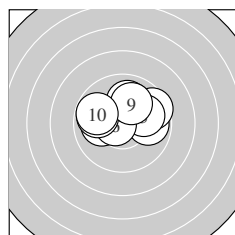
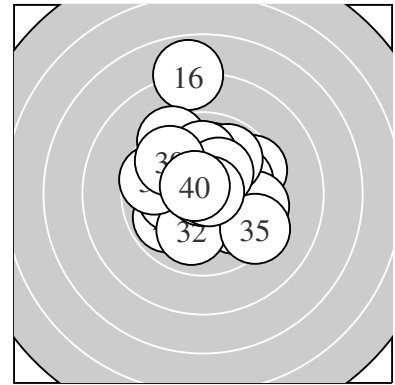

Serie 1:
 9.9 → 10.0 ↑ 9.6 ↗ 10.1 ← 10.0 →
 10.6 * 10.0 ↑ 9.9 ← 10.0 ↑ 9.8 ↖
 beste Teiler 79.8 (6.) 223.8 (4.) 228.4 (2.)
 Trefferlage 0.19 mm rechts, 1.01 mm hoch
 Streuwert 1.71, horizontal: 2.21, vertikal: 0.98

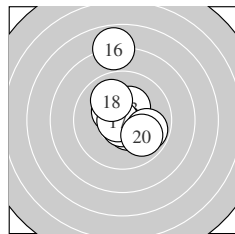

Serie 2:
 10.4 * 9.9 ↘ 10.3 * 10.5 * 10.7 *
 7.9 ↑ 10.7 * 10.0 ↘ 9.8 ↗ 9.9 ↘
 beste Teiler 51.4 (17.) 60.1 (15.) 115.4 (14.)
 Trefferlage 0.45 mm rechts, 0.66 mm hoch
 Streuwert 2.19, horizontal: 1.45, vertikal: 2.74

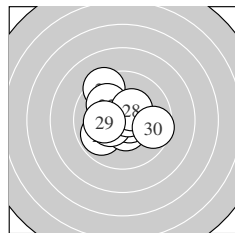

Serie 3:
 9.4 ↘ 10.0 ↘ 9.9 ↙ 10.5 * 10.7 *
 10.4 * 10.7 * 10.4 * 10.2 * 9.6 →
 beste Teiler 75.4 (25.) 75.6 (27.) 109.7 (24.)
 Trefferlage 0.32 mm links, 0.23 mm hoch
 Streuwert 1.64, horizontal: 1.79, vertikal: 1.47

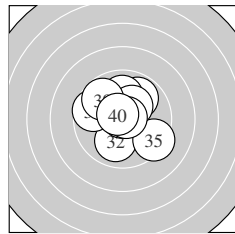

Serie 4:
 9.9 ↗ 10.0 ↓ 10.9 * 9.6 ← 9.3 ↘
 10.0 ↑ 10.3 * 10.8 * 9.8 ↘ 10.7 *
 beste Teiler 19.9 (33.) 42.5 (38.) 73.5 (40.)
 Trefferlage 0.03 mm links, 0.54 mm hoch
 Streuwert 1.76, horizontal: 1.83, vertikal: 1.70

Unterschrift des Schuetzen

Meyton Elektronik

Ergebnis: **407.3** (388)
 Serien: 102.1 102.4 101.4 101.4
 Zaehler: 28 12 0 0 0 0 0 0 0 0
 Innenzehner: 22
 weiteste: 485 (33), 313 (3), 310 (11)
 beste Teiler 49.0 (7.) 57.7 (18.) 60.7 (19.)
 Trefferlage 0.48 mm links, 0.11 mm hoch
 Streuwert 1.49, horizontal: 1.76, vertikal: 1.15

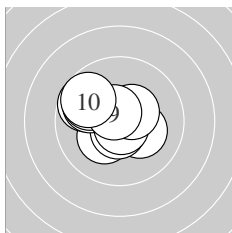
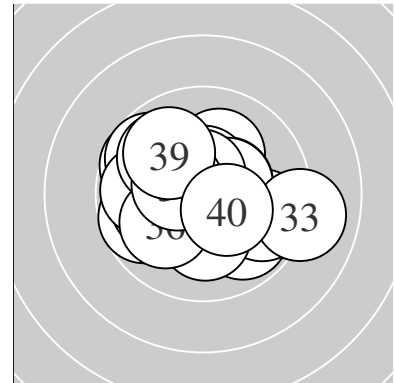

Serie 1:
 10.2 * 10.3 * 9.7 ↖ 10.6 * 9.9 ↖
 9.8 ↖ 10.8 * 10.5 * 10.6 * 9.7 ↖
 beste Teiler 49.0 (7.) 84.1 (4.) 84.9 (9.)
 Trefferlage 0.92 mm links, 0.41 mm hoch
 Streuwert 1.38, horizontal: 1.60, vertikal: 1.12

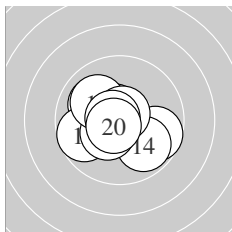

Serie 2:
 9.7 → 10.0 ↖ 9.7 ← 9.9 ↘ 10.4 *
 10.6 * 10.0 ↖ 10.7 * 10.7 * 10.7 *
 beste Teiler 57.7 (18.) 60.7 (19.) 67.2 (20.)
 Trefferlage 0.40 mm links, 0.15 mm tief
 Streuwert 1.48, horizontal: 1.75, vertikal: 1.15

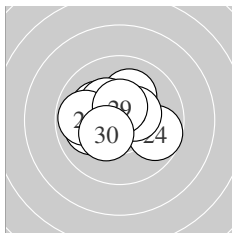

Serie 3:
 10.1 ↗ 10.1 ← 10.2 * 9.7 → 10.3 *
 10.4 * 10.0 ← 9.8 ← 10.5 * 10.3 *
 beste Teiler 109.0 (29.) 128.4 (26.) 152.7 (30.)
 Trefferlage 0.61 mm links, 0.26 mm hoch
 Streuwert 1.47, horizontal: 1.79, vertikal: 1.04

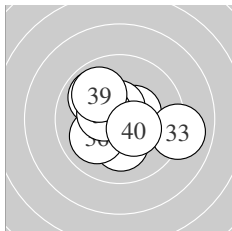

Serie 4:
 10.6 * 10.4 * 9.0 → 10.2 * 10.6 *
 10.0 ↙ 9.9 ↖ 10.4 * 9.9 ↖ 10.4 *
 beste Teiler 93.3 (35.) 98.0 (31.) 126.3 (32.)
 Trefferlage 0.01 mm rechts, 0.05 mm tief
 Streuwert 1.73, horizontal: 2.02, vertikal: 1.37

Unterschrift des Schuetzen

Meyton Elektronik

Ergebnis: **411.3** (393)
 Serien: 103.3 103.5 101.5 103.0
 Zaehler: 33 7 0 0 0 0 0 0 0 0
 Innenzehner: 25
 weiteste: 315 (1), 305 (39), 296 (30)
 beste Teiler 23.3 (14.) 41.1 (35.) 49.5 (10.)
 Trefferlage 0.08 mm links, 0.75 mm tief
 Streuwert 1.22, horizontal: 1.29, vertikal: 1.14

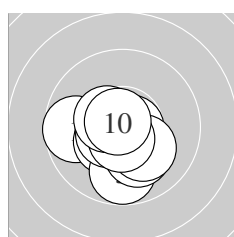
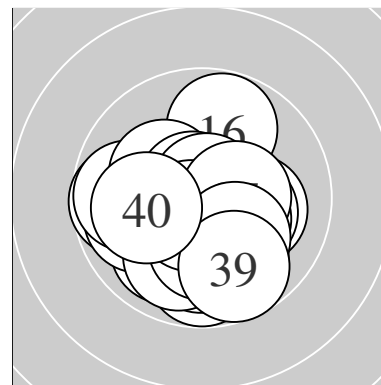

Serie 1:
 9.7 ← 10.4 * 9.8 ↓ 10.1 ↘ 10.7 *
 10.5 * 10.2 * 10.6 * 10.5 * 10.8 *
 beste Teiler 49.5 (10.) 55.5 (5.) 79.4 (8.)
 Trefferlage 0.36 mm links, 0.76 mm tief
 Streuwert 1.18, horizontal: 1.29, vertikal: 1.07

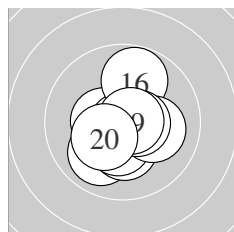

Serie 2:
 10.0 ↗ 10.4 * 10.3 * 10.9 * 10.4 *
 9.8 ↑ 10.1 → 10.6 * 10.7 * 10.3 *
 beste Teiler 23.3 (14.) 54.5 (19.) 98.2 (18.)
 Trefferlage 0.01 mm rechts, 0.39 mm tief
 Streuwert 1.24, horizontal: 1.12, vertikal: 1.35

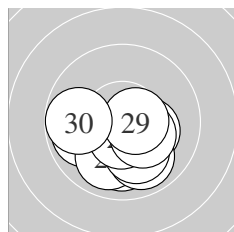

Serie 3:
 10.3 * 9.9 ← 10.0 ↓ 10.0 ↗ 9.9 ↘
 10.1 ↘ 10.6 * 10.3 * 10.6 * 9.8 ←
 beste Teiler 87.2 (29.) 92.4 (27.) 160.3 (28.)
 Trefferlage 0.05 mm links, 1.19 mm tief
 Streuwert 1.34, horizontal: 1.63, vertikal: 0.96

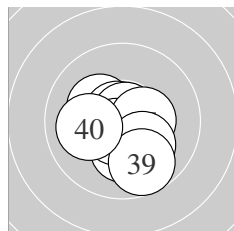

Serie 4:
 10.2 * 10.2 * 10.3 * 10.7 * 10.8 *
 10.6 * 10.4 * 10.1 ↘ 9.7 ↘ 10.0 ←
 beste Teiler 41.1 (35.) 58.1 (34.) 84.3 (36.)
 Trefferlage 0.04 mm rechts, 0.68 mm tief
 Streuwert 1.21, horizontal: 1.24, vertikal: 1.18

Unterschrift des Schuetzen

Meyton Elektronik

Ergebnis: **396.6** (380)
 Serien: 100.5 99.5 102.1 94.5
 Zaehler: 24 12 4 0 0 0 0 0 0 0
 Innenzehner: 17
 weiteste: 672 (38), 595 (33), 524 (37)
 beste Teiler 41.5 (23.) 43.0 (4.) 89.4 (6.)
 Trefferlage 0.44 mm links, 0.02 mm tief
 Streuwert 2.13, horizontal: 2.60, vertikal: 1.53

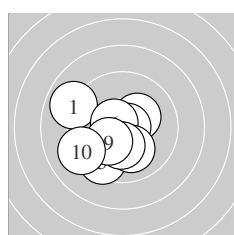
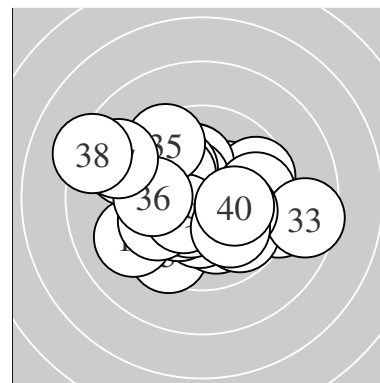

Serie 1:
 8.9 ↖ 10.3 * 10.6 * 10.8 * 9.5 ↘
 10.6 * 10.1 ↓ 10.3 * 10.2 * 9.2 ↙
 beste Teiler 43.0 (4.) 89.4 (6.) 94.8 (3.)
 Trefferlage 1.04 mm links, 0.78 mm tief
 Streuwert 1.80, horizontal: 1.96, vertikal: 1.63

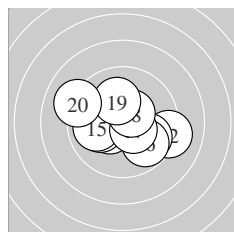

Serie 2:
 10.4 * 9.2 → 10.1 ← 9.8 ↘ 10.0 ←
 9.8 ↘ 10.5 * 10.5 * 10.1 ↑ 9.1 ↖
 beste Teiler 117.3 (18.) 124.2 (17.) 142.0 (11.)
 Trefferlage 0.02 mm rechts, 0.24 mm tief
 Streuwert 2.08, horizontal: 2.61, vertikal: 1.34

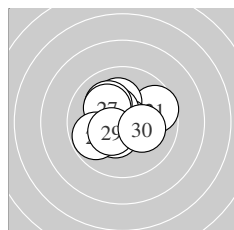

Serie 3:
 9.6 → 10.2 * 10.8 * 10.4 * 10.4 *
 10.1 ↖ 10.2 * 9.8 ↙ 10.4 * 10.2 *
 beste Teiler 41.5 (23.) 127.8 (24.) 132.2 (25.)
 Trefferlage 0.29 mm links, 0.32 mm hoch
 Streuwert 1.46, horizontal: 1.65, vertikal: 1.25

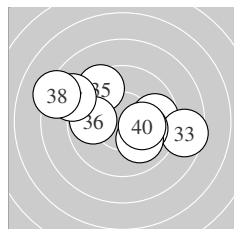

Serie 4:
 9.7 → 9.4 ↖ 8.6 → 10.1 → 9.5 ↖
 9.8 ← 8.9 ↖ 8.3 ↖ 10.0 ↘ 10.2 *
 beste Teiler 189.6 (40.) 216.6 (34.) 234.1 (39.)
 Trefferlage 0.48 mm links, 0.60 mm hoch
 Streuwert 3.00, horizontal: 3.89, vertikal: 1.68

Unterschrift des Schuetzen

Meyton Elektronik

Ergebnis: **416.1** (395)
 Serien: 105.4 104.3 102.5 103.9
 Zaehler: 35 5 0 0 0 0 0 0 0 0
 Innenzehner: 30
 weiteste: 323 (30), 288 (14), 274 (8)
 beste Teiler 30.0 (39.) 35.5 (18.) 39.8 (5.)
 Trefferlage 0.36 mm rechts, 0.17 mm hoch
 Streuwert 1.10, horizontal: 1.11, vertikal: 1.09

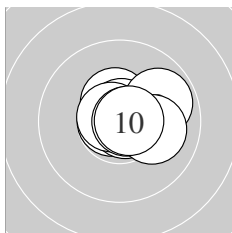
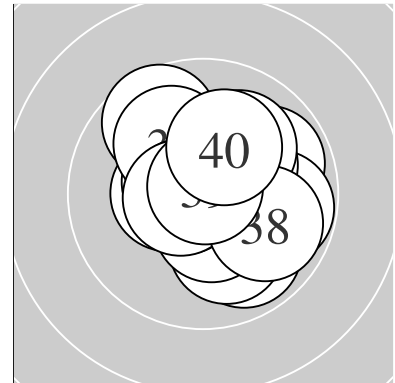

Serie 1:
 10.4 * 10.5 * 10.8 * 10.7 * 10.8 *
 10.7 * 10.8 * 9.9 ↗ 10.1 → 10.7 *
 beste Teiler 39.8 (5.) 45.0 (7.) 50.0 (3.)
 Trefferlage 0.60 mm rechts, 0.24 mm hoch
 Streuwert 0.84, horizontal: 1.04, vertikal: 0.57

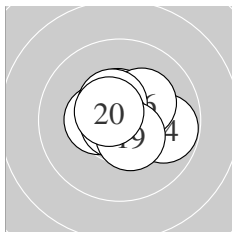

Serie 2:
 10.5 * 10.5 * 10.4 * 9.8 → 10.5 *
 10.2 * 10.5 * 10.8 * 10.5 * 10.6 *
 beste Teiler 35.5 (18.) 87.4 (20.) 101.2 (11.)
 Trefferlage 0.22 mm rechts, 0.23 mm hoch
 Streuwert 1.05, horizontal: 1.29, vertikal: 0.73

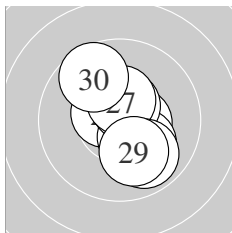

Serie 3:
 10.5 * 10.3 * 10.4 * 10.5 * 10.1 ↘
 10.6 * 10.4 * 9.9 ↘ 10.1 ↘ 9.7 ↘
 beste Teiler 99.9 (26.) 102.4 (21.) 116.4 (24.)
 Trefferlage 0.48 mm rechts, 0.27 mm tief
 Streuwert 1.36, horizontal: 1.05, vertikal: 1.61

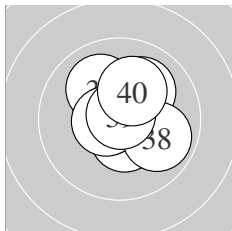

Serie 4:
 10.6 * 10.5 * 10.0 ↘ 10.5 * 10.7 *
 10.1 ↗ 10.6 * 9.9 ↘ 10.8 * 10.2 *
 beste Teiler 30.0 (39.) 73.5 (35.) 79.4 (31.)
 Trefferlage 0.13 mm rechts, 0.49 mm hoch
 Streuwert 1.15, horizontal: 1.14, vertikal: 1.16

Unterschrift des Schuetzen

Ergebnis: **407.1** (388)
 Serien: 102.3 100.1 102.3 102.4
 Zaehler: 28 12 0 0 0 0 0 0 0 0
 Innenzehner: 20
 weiteste: 412 (14), 380 (16), 346 (2)
 beste Teiler 14.7 (39.) 45.2 (32.) 61.0 (31.)
 Trefferlage 0.30 mm links, 0.02 mm tief
 Streuwert 1.53, horizontal: 1.81, vertikal: 1.18

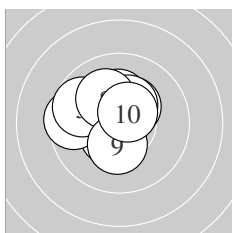
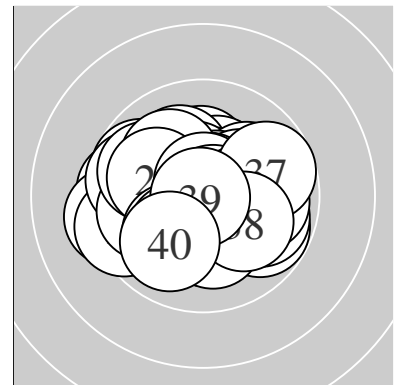

Serie 1:
 10.5 * 9.6 ← 9.7 ↖ 10.2 * 10.3 *
 10.7 * 10.4 * 10.1 ↘ 10.3 * 10.5 *
 beste Teiler 65.8 (6.) 102.4 (10.) 117.6 (1.)
 Trefferlage 0.60 mm links, 0.67 mm hoch
 Streuwert 1.31, horizontal: 1.47, vertikal: 1.14

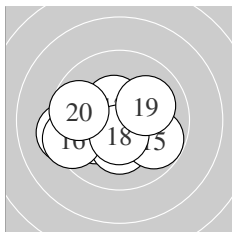

Serie 2:
 10.1 ↙ 10.2 * 10.5 * 9.3 ← 9.8 ↘
 9.4 ← 10.5 * 10.5 * 10.1 ↗ 9.7 ←
 beste Teiler 110.0 (18.) 111.8 (13.) 119.9 (17.)
 Trefferlage 0.76 mm links, 0.55 mm tief
 Streuwert 1.79, horizontal: 2.28, vertikal: 1.10

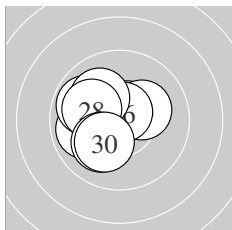

Serie 3:
 10.6 * 9.9 ← 10.2 * 9.9 ↖ 10.6 *
 10.7 * 10.1 ↘ 10.1 ← 10.1 ↙ 10.1 ↘
 beste Teiler 65.1 (26.) 90.2 (21.) 95.9 (25.)
 Trefferlage 0.94 mm links, 0.23 mm hoch
 Streuwert 1.28, horizontal: 1.39, vertikal: 1.15

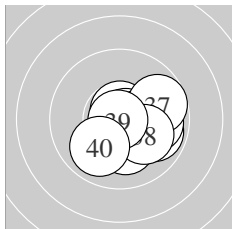

Serie 4:
 10.7 * 10.8 * 9.9 ↘ 10.2 * 10.3 *
 9.9 → 9.7 → 10.1 ↘ 10.9 * 9.9 ↙
 beste Teiler 14.7 (39.) 45.2 (32.) 61.0 (31.)
 Trefferlage 1.07 mm rechts, 0.46 mm tief
 Streuwert 1.25, horizontal: 1.43, vertikal: 1.04

Unterschrift des Schuetzen

Meyton Elektronik

Ergebnis: **411.6** (390)
 Serien: 104.4 102.3 103.0 101.9
 Zaehler: 30 10 0 0 0 0 0 0 0 0
 Innenzehner: 27
 weiteste: 364 (37), 340 (11), 320 (35)
 beste Teiler 1.4 (1.) 2.8 (22.) 10.7 (21.)
 Trefferlage 0.45 mm links, 0.18 mm hoch
 Streuwert 1.33, horizontal: 1.37, vertikal: 1.29

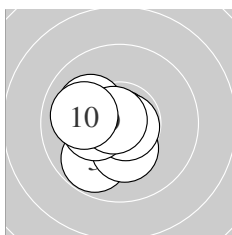
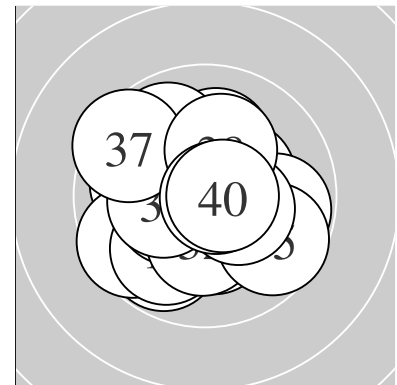

Serie 1:
 10.9 * 10.7 * 9.8 ↙ 10.7 * 10.3 *
 10.8 * 10.3 * 10.1 ↘ 10.8 * 10.0 ←
 beste Teiler 1.4 (1.) 45.6 (9.) 48.0 (6.)
 Trefferlage 0.81 mm links, 0.34 mm tief
 Streuwert 0.99, horizontal: 0.99, vertikal: 1.00

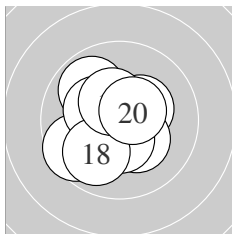

Serie 2:
 9.6 ↙ 9.9 ↘ 10.7 * 10.3 * 10.3 *
 10.3 * 10.4 * 9.9 ↙ 10.4 * 10.5 *
 beste Teiler 69.1 (13.) 107.4 (20.) 128.2 (17.)
 Trefferlage 0.41 mm links, 0.11 mm tief
 Streuwert 1.43, horizontal: 1.46, vertikal: 1.40

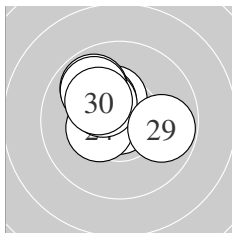

Serie 3:
 10.9 * 10.9 * 10.4 * 10.4 * 10.3 *
 9.9 ↘ 10.3 * 9.9 ↘ 9.8 → 10.2 *
 beste Teiler 2.8 (22.) 10.7 (21.) 142.8 (24.)
 Trefferlage 0.59 mm links, 0.81 mm hoch
 Streuwert 1.18, horizontal: 1.35, vertikal: 0.99

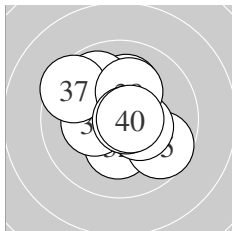

Serie 4:
 10.1 ↑ 10.3 * 9.9 ↘ 10.3 * 9.7 ↘
 10.4 * 9.5 ↘ 10.2 * 10.8 * 10.7 *
 beste Teiler 44.5 (39.) 70.0 (40.) 143.3 (36.)
 Trefferlage 0.00 mm , 0.39 mm hoch
 Streuwert 1.60, horizontal: 1.65, vertikal: 1.55

Unterschrift des Schuetzen

Meyton Elektronik

Ergebnis: **413.5** (394)
 Serien: 101.7 104.6 103.9 103.3
 Zaehler: 34 6 0 0 0 0 0 0 0 0
 Innenzehner: 28
 weiteste: 329 (40), 321 (6), 312 (16)
 beste Teiler 36.6 (20.) 45.0 (27.) 50.3 (32.)
 Trefferlage 0.03 mm rechts, 0.58 mm tief
 Streuwert 1.17, horizontal: 1.15, vertikal: 1.19

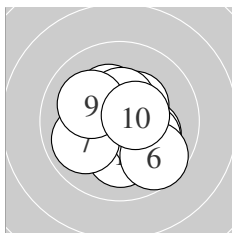
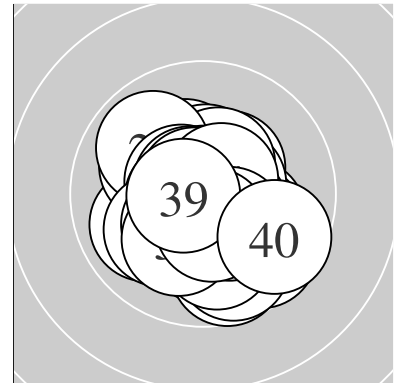

Serie 1:
 10.1 ↓ 10.2 * 10.1 ↘ 10.4 * 10.3 *
 9.7 ↘ 9.9 ↙ 10.4 * 10.1 ↖ 10.5 *
 beste Teiler 110.7 (10.) 129.4 (8.) 144.2 (4.)
 Trefferlage 0.32 mm rechts, 0.21 mm tief
 Streuwert 1.50, horizontal: 1.55, vertikal: 1.45

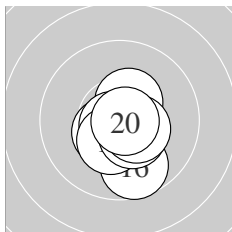

Serie 2:
 10.4 * 10.6 * 10.6 * 10.5 * 10.7 *
 9.7 ↓ 10.4 * 10.4 * 10.5 * 10.8 *
 beste Teiler 36.6 (20.) 55.4 (15.) 80.5 (13.)
 Trefferlage 0.21 mm rechts, 0.75 mm tief
 Streuwert 0.88, horizontal: 0.69, vertikal: 1.04

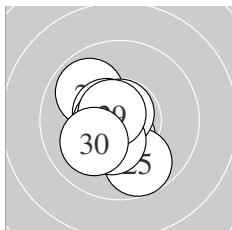

Serie 3:
 10.5 * 10.5 * 9.9 ↖ 10.6 * 9.8 ↓
 10.6 * 10.8 * 10.4 * 10.7 * 10.1 ↗
 beste Teiler 45.0 (27.) 66.0 (29.) 86.8 (26.)
 Trefferlage 0.60 mm links, 0.44 mm tief
 Streuwert 1.13, horizontal: 0.91, vertikal: 1.30

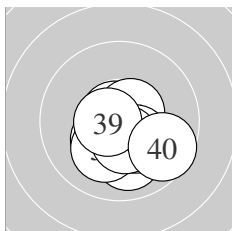

Serie 4:
 10.6 * 10.8 * 10.0 ↓ 10.6 * 10.3 *
 10.3 * 10.1 ↗ 10.4 * 10.6 * 9.6 ↘
 beste Teiler 50.3 (32.) 76.8 (31.) 78.3 (39.)
 Trefferlage 0.20 mm rechts, 0.91 mm tief
 Streuwert 1.07, horizontal: 1.17, vertikal: 0.95

Unterschrift des Schuetzen

Meyton Elektronik

Ergebnis: **410.3** (394)
 Serien: 101.5 102.0 101.7 105.1
 Zaehler: 34 6 0 0 0 0 0 0 0 0
 Innenzehner: 26
 weiteste: 413 (1), 353 (29), 334 (27)
 beste Teiler 9.8 (18.) 11.1 (40.) 42.5 (25.)
 Trefferlage 1.01 mm links, 0.14 mm hoch
 Streuwert 1.21, horizontal: 1.00, vertikal: 1.38

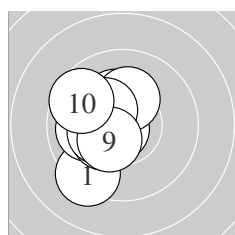
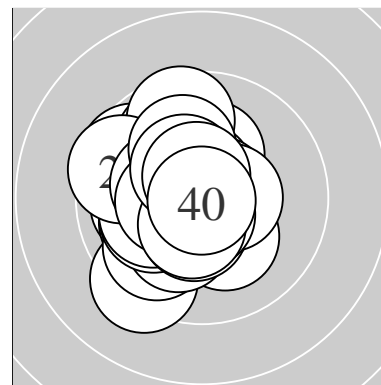

Serie 1:
 9.3 ↙ 10.0 ← 10.3 * 10.8 * 10.2 *
 10.3 * 10.3 * 10.3 * 10.4 * 9.6 ↘
 beste Teiler 46.3 (4.) 134.4 (9.) 156.9 (6.)
 Trefferlage 1.32 mm links, 0.00 mm
 Streuwert 1.34, horizontal: 1.01, vertikal: 1.61

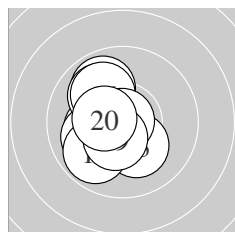

Serie 2:
 9.9 ↘ 10.2 * 10.2 * 10.0 ↙ 10.0 ↘
 10.0 ↘ 9.9 ↙ 10.9 * 10.5 * 10.4 *
 beste Teiler 9.8 (18.) 121.2 (19.) 128.4 (20.)
 Trefferlage 1.08 mm links, 0.03 mm hoch
 Streuwert 1.28, horizontal: 0.95, vertikal: 1.54

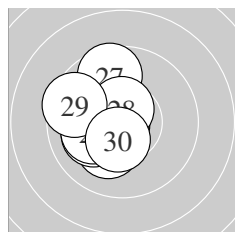

Serie 3:
 10.2 * 10.2 * 10.1 ↙ 10.1 ↙ 10.8 *
 10.1 ↘ 9.6 ↘ 10.6 * 9.5 ↙ 10.5 *
 beste Teiler 42.5 (25.) 91.2 (28.) 125.4 (30.)
 Trefferlage 1.28 mm links, 0.26 mm hoch
 Streuwert 1.30, horizontal: 1.01, vertikal: 1.54

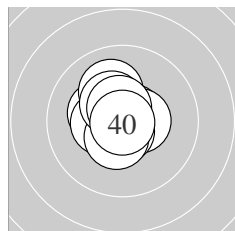

Serie 4:
 10.7 * 10.3 * 10.1 ↘ 10.5 * 10.7 *
 10.4 * 10.5 * 10.4 * 10.6 * 10.9 *
 beste Teiler 11.1 (40.) 69.7 (31.) 70.1 (35.)
 Trefferlage 0.34 mm links, 0.30 mm hoch
 Streuwert 0.88, horizontal: 0.83, vertikal: 0.92

Unterschrift des Schuetzen

Meyton Elektronik

Ergebnis: **412.8** (394)
 Serien: 101.3 104.0 103.1 104.4
 Zaehler: 34 6 0 0 0 0 0 0 0 0
 Innenzehner: 27
 weiteste: 387 (12), 298 (25), 290 (8)
 beste Teiler 17.0 (40.) 42.2 (22.) 48.3 (20.)
 Trefferlage 0.22 mm links, 0.20 mm hoch
 Streuwert 1.26, horizontal: 1.12, vertikal: 1.38

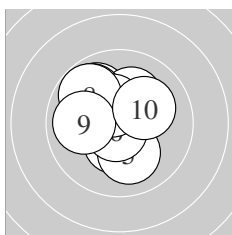
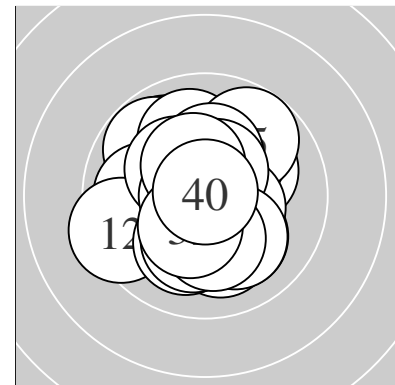

Serie 1:
 9.9 ↘ 10.4 * 10.2 * 9.8 ↘ 10.1 ↘
 10.7 * 10.4 * 9.8 ↘ 9.9 ← 10.1 ↗
 beste Teiler 55.4 (6.) 136.6 (7.) 139.9 (2.)
 Trefferlage 0.61 mm links, 0.62 mm hoch
 Streuwert 1.47, horizontal: 1.43, vertikal: 1.52

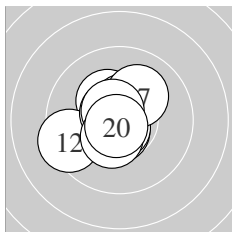

Serie 2:
 10.3 * 9.4 ← 10.6 * 10.7 * 10.6 *
 10.5 * 10.1 ↗ 10.6 * 10.4 * 10.8 *
 beste Teiler 48.3 (20.) 53.2 (14.) 79.5 (13.)
 Trefferlage 0.49 mm links, 0.09 mm hoch
 Streuwert 1.18, horizontal: 1.24, vertikal: 1.11

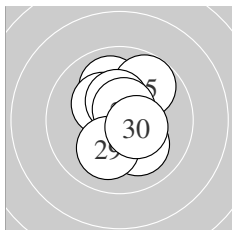

Serie 3:
 10.1 ↘ 10.8 * 10.0 ↑ 10.6 * 9.8 ↗
 10.3 * 10.4 * 10.6 * 10.1 ↓ 10.4 *
 beste Teiler 42.2 (22.) 83.5 (28.) 92.8 (24.)
 Trefferlage 0.24 mm rechts, 0.41 mm hoch
 Streuwert 1.29, horizontal: 0.99, vertikal: 1.53

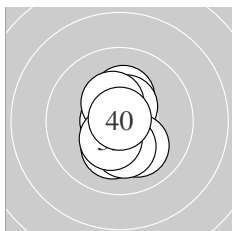

Serie 4:
 10.3 * 10.7 * 10.5 * 10.1 ↘ 10.7 *
 10.4 * 10.2 * 10.2 * 10.4 * 10.9 *
 beste Teiler 17.0 (40.) 59.0 (35.) 68.8 (32.)
 Trefferlage 0.02 mm links, 0.30 mm tief
 Streuwert 1.06, horizontal: 0.62, vertikal: 1.36

Unterschrift des Schuetzen

Meyton Elektronik