

Ergebnis: **407.8** (387)  
 Serien: 100.0 103.4 102.7 101.7  
 Zähler: 27 13 0 0 0 0 0 0 0 0  
 Innenzehner: 23  
 weiteste: 373 (14), 372 (9), 346 (8)  
 beste Teiler 35.9 (28.) 42.1 (11.) 48.1 (16.)  
 Trefferlage 0.05 mm rechts, 0.06 mm hoch  
 Streuwert 1.51, horizontal: 1.51, vertikal: 1.52

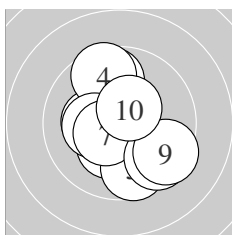

Serie 1:  
 10.2 \*                      10.3 \*                      9.8 ↑                      9.6 ↑                      9.7 ↓  
 10.3 \*                      10.5 \*                      9.6 ↘                      9.5 ↘                      10.5 \*  
 beste Teiler 115.4 (7.) 121.7 (10.) 170.4 (2.)  
 Trefferlage 0.05 mm rechts, 0.24 mm tief  
 Streuwert 1.95, horizontal: 1.72, vertikal: 2.14

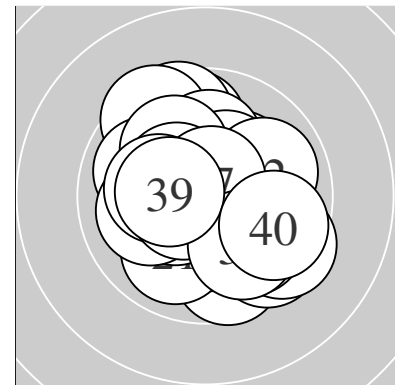
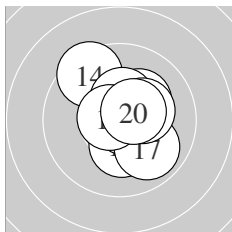

Serie 2:  
 10.8 \*                      10.2 \*                      10.3 \*                      9.5 ↖                      10.4 \*  
 10.8 \*                      9.9 ↘                      10.7 \*                      10.3 \*                      10.5 \*  
 beste Teiler 42.1 (11.) 48.1 (16.) 69.3 (18.)  
 Trefferlage 0.33 mm rechts, 0.36 mm hoch  
 Streuwert 1.32, horizontal: 1.18, vertikal: 1.45

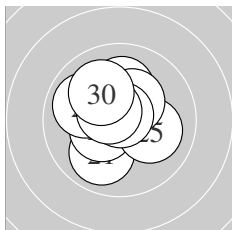

Serie 3:  
 9.9 ↙                      10.4 \*                      10.6 \*                      9.9 ↖                      10.1 →  
 10.1 ↑                      10.3 \*                      10.8 \*                      10.6 \*                      10.0 ↖  
 beste Teiler 35.9 (28.) 92.4 (23.) 94.3 (29.)  
 Trefferlage 0.28 mm links, 0.42 mm hoch  
 Streuwert 1.30, horizontal: 1.30, vertikal: 1.30

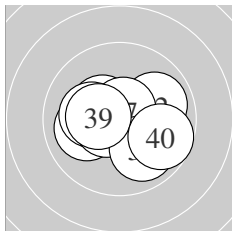

Serie 4:  
 10.4 \*                      9.9 →                      10.0 ←                      9.9 ↘                      10.2 \*  
 10.6 \*                      10.7 \*                      9.9 ↘                      10.4 \*                      9.7 ↘  
 beste Teiler 66.8 (37.) 95.4 (36.) 140.0 (31.)  
 Trefferlage 0.13 mm rechts, 0.29 mm tief  
 Streuwert 1.53, horizontal: 1.91, vertikal: 1.04

Unterschrift des Schützen

Meyton Elektronik

Ergebnis: **409.6** (391)  
 Serien: 102.3 104.4 101.1 101.8  
 Zähler: 31 9 0 0 0 0 0 0 0 0  
 Innenzehner: 26  
 weiteste: 373 (35), 359 (36), 343 (22)  
 beste Teiler 10.2 (7.) 22.3 (19.) 50.0 (8.)  
 Trefferlage 0.19 mm rechts, 0.38 mm tief  
 Streuwert 1.42, horizontal: 1.70, vertikal: 1.07

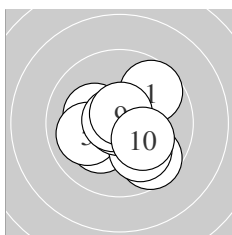
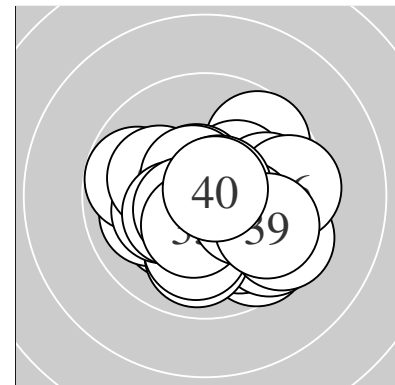

Serie 1:  
 9.7 ↗ 10.2 \* 9.6 ↘ 10.2 \* 10.0 ←  
 10.0 ↘ 10.9 \* 10.8 \* 10.7 \* 10.2 \*  
 beste Teiler 10.2 (7.) 50.0 (8.) 67.7 (9.)  
 Trefferlage 0.17 mm rechts, 0.39 mm tief  
 Streuwert 1.54, horizontal: 1.66, vertikal: 1.40

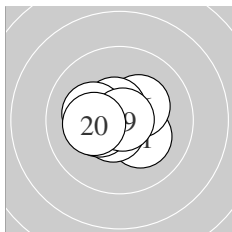

Serie 2:  
 10.2 \* 10.7 \* 10.6 \* 10.4 \* 10.3 \*  
 10.3 \* 10.6 \* 10.2 \* 10.9 \* 10.2 \*  
 beste Teiler 22.3 (19.) 58.0 (12.) 86.6 (13.)  
 Trefferlage 0.41 mm links, 0.02 mm hoch  
 Streuwert 1.01, horizontal: 1.26, vertikal: 0.68

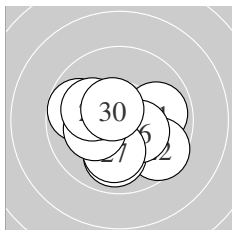

Serie 3:  
 9.9 → 9.6 ↘ 9.8 ← 10.6 \* 9.9 ↓  
 10.3 \* 10.1 ↓ 10.2 \* 10.1 ↖ 10.6 \*  
 beste Teiler 88.0 (24.) 92.9 (30.) 154.0 (26.)  
 Trefferlage 0.17 mm links, 0.62 mm tief  
 Streuwert 1.61, horizontal: 1.88, vertikal: 1.29

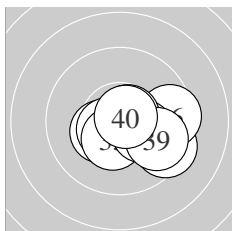

Serie 4:  
 10.4 \* 10.5 \* 10.4 \* 10.1 → 9.5 ↘  
 9.5 → 10.2 \* 10.7 \* 9.8 ↘ 10.7 \*  
 beste Teiler 53.2 (40.) 68.9 (38.) 101.2 (32.)  
 Trefferlage 1.17 mm rechts, 0.57 mm tief  
 Streuwert 1.34, horizontal: 1.75, vertikal: 0.75

Unterschrift des Schützen

Ergebnis: **413.1** (396)  
 Serien: 102.9 103.2 102.9 104.1  
 Zähler: 36 4 0 0 0 0 0 0 0 0  
 Innenzehner: 28  
 weiteste: 348 (10), 290 (30), 266 (17)  
 beste Teiler 7.0 (33.) 30.1 (9.) 33.2 (28.)  
 Trefferlage 0.14 mm rechts, 0.01 mm hoch  
 Streuwert 1.24, horizontal: 1.35, vertikal: 1.13

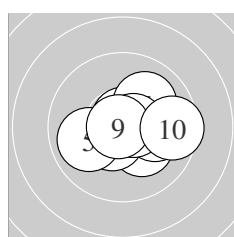
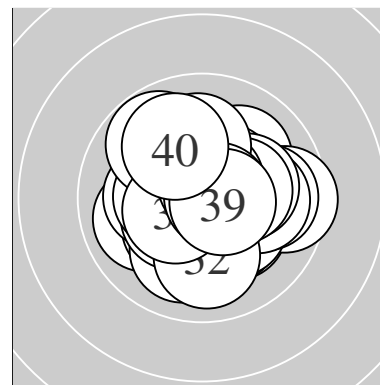

Serie 1:  
 10.5 \*                      10.2 \*                      10.7 \*                      10.5 \*                      9.9 ←  
 10.0 →                      10.0 ↗                      10.7 \*                      10.8 \*                      9.6 →  
 beste Teiler 30.1 (9.) 57.3 (3.) 75.9 (8.)  
 Trefferlage 0.70 mm rechts, 0.13 mm tief  
 Streuwert 1.30, horizontal: 1.64, vertikal: 0.83

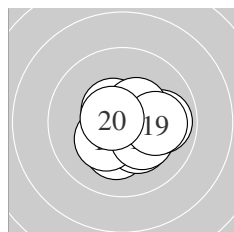

Serie 2:  
 10.7 \*                      10.2 \*                      10.3 \*                      10.3 \*                      10.3 \*  
 10.5 \*                      9.9 →                      10.4 \*                      10.0 →                      10.6 \*  
 beste Teiler 57.2 (11.) 78.7 (20.) 107.4 (16.)  
 Trefferlage 0.51 mm rechts, 0.40 mm tief  
 Streuwert 1.16, horizontal: 1.34, vertikal: 0.94

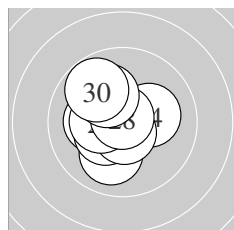

Serie 3:  
 10.0 ↓                      10.2 \*                      10.4 \*                      10.2 \*                      10.7 \*  
 10.4 \*                      10.3 \*                      10.8 \*                      10.1 ↖                      9.8 ↖  
 beste Teiler 33.2 (28.) 74.1 (25.) 142.8 (23.)  
 Trefferlage 0.76 mm links, 0.21 mm hoch  
 Streuwert 1.22, horizontal: 1.14, vertikal: 1.29

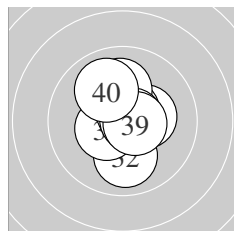

Serie 4:  
 10.3 \*                      10.0 ↓                      10.9 \*                      10.4 \*                      10.5 \*  
 10.6 \*                      10.1 ↑                      10.7 \*                      10.6 \*                      10.0 ↖  
 beste Teiler 7.0 (33.) 64.6 (38.) 76.5 (36.)  
 Trefferlage 0.11 mm rechts, 0.36 mm hoch  
 Streuwert 1.13, horizontal: 0.84, vertikal: 1.36

Unterschrift des Schützen

Meyton Elektronik

Ergebnis: **409.5** (392)  
 Serien: 103.0 102.5 100.5 103.5  
 Zähler: 32 8 0 0 0 0 0 0 0 0  
 Innenzehner: 24  
 weiteste: 471 (23), 393 (29), 386 (25)  
 beste Teiler 5.8 (28.) 39.5 (1.) 44.5 (21.)  
 Trefferlage 0.04 mm rechts, 0.48 mm hoch  
 Streuwert 1.46, horizontal: 1.58, vertikal: 1.33

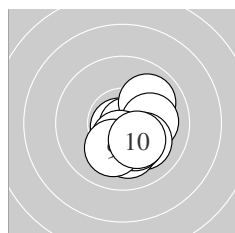
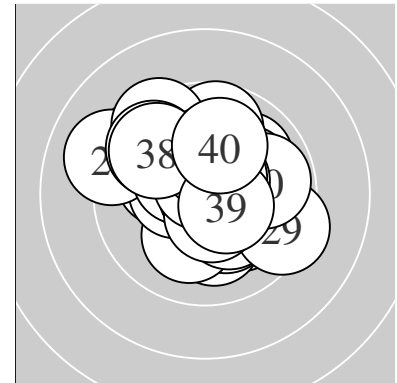

Serie 1:  
 10.8 \*                      10.8 \*                      10.0 ↗                      10.1 →                      10.5 \*  
 10.1 ↘                      10.1 ↓                      10.2 \*                      10.1 ↓                      10.3 \*  
 beste Teiler 39.5 (1.) 45.1 (2.) 125.9 (5.)  
 Trefferlage 0.73 mm rechts, 0.81 mm tief  
 Streuwert 1.06, horizontal: 0.98, vertikal: 1.13

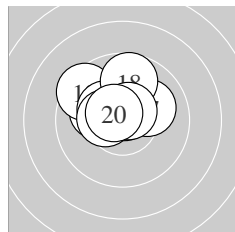

Serie 2:  
 10.1 ↖                      9.5 ↖                      10.3 \*                      10.4 \*                      10.7 \*  
 10.5 \*                      10.1 ↗                      9.7 ↑                      10.6 \*                      10.6 \*  
 beste Teiler 65.7 (15.) 84.0 (19.) 87.3 (20.)  
 Trefferlage 0.48 mm links, 1.09 mm hoch  
 Streuwert 1.19, horizontal: 1.43, vertikal: 0.87

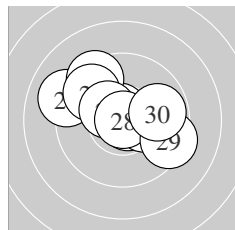

Serie 3:  
 10.8 \*                      10.3 \*                      9.1 ↖                      10.7 \*                      9.4 ↖  
 9.7 ↖                      10.4 \*                      10.9 \*                      9.4 ↘                      9.8 →  
 beste Teiler 5.8 (28.) 44.5 (21.) 71.6 (24.)  
 Trefferlage 0.19 mm links, 0.72 mm hoch  
 Streuwert 1.99, horizontal: 2.46, vertikal: 1.36

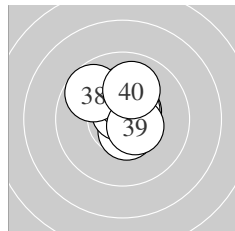

Serie 4:  
 10.6 \*                      10.6 \*                      10.5 \*                      10.4 \*                      10.7 \*  
 10.3 \*                      10.2 \*                      9.7 ↖                      10.5 \*                      10.0 ↑  
 beste Teiler 58.5 (35.) 99.0 (32.) 100.6 (31.)  
 Trefferlage 0.12 mm rechts, 0.94 mm hoch  
 Streuwert 1.01, horizontal: 0.93, vertikal: 1.09

Unterschrift des Schützen

Meyton Elektronik

Ergebnis: **404.8** (384)  
 Serien: 100.7 100.3 102.7 101.1  
 Zähler: 26 12 2 0 0 0 0 0 0 0  
 Innenzehner: 23  
 weiteste: 581 (1), 519 (18), 437 (16)  
 beste Teiler 31.9 (23.) 44.4 (38.) 65.1 (13.)  
 Trefferlage 0.95 mm links, 0.20 mm tief  
 Streuwert 1.63, horizontal: 2.06, vertikal: 1.03

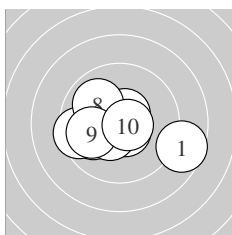
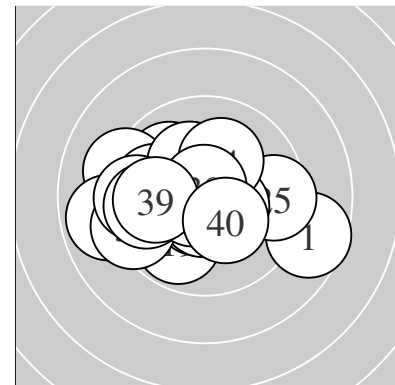

Serie 1:  
 8.6 ↗ 10.0 ← 10.6 \* 10.4 \* 9.5 ←  
 10.4 \* 10.6 \* 10.0 ↘ 9.9 ← 10.7 \*  
 beste Teiler 72.7 (10.) 85.8 (3.) 90.0 (7.)  
 Trefferlage 0.49 mm links, 0.31 mm tief  
 Streuwert 1.95, horizontal: 2.52, vertikal: 1.12

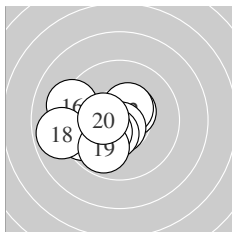

Serie 2:  
 10.5 \* 10.5 \* 10.7 \* 9.6 ← 10.4 \*  
 9.2 ← 10.3 \* 8.9 ← 9.8 ↙ 10.4 \*  
 beste Teiler 65.1 (13.) 121.2 (11.) 125.0 (12.)  
 Trefferlage 1.52 mm links, 0.44 mm tief  
 Streuwert 1.67, horizontal: 2.03, vertikal: 1.19

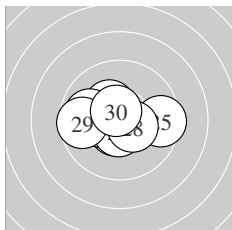

Serie 3:  
 10.3 \* 10.6 \* 10.8 \* 10.4 \* 9.5 →  
 9.9 ← 10.6 \* 10.4 \* 9.6 ← 10.6 \*  
 beste Teiler 31.9 (23.) 86.7 (30.) 97.4 (27.)  
 Trefferlage 0.45 mm links, 0.02 mm tief  
 Streuwert 1.45, horizontal: 1.91, vertikal: 0.72

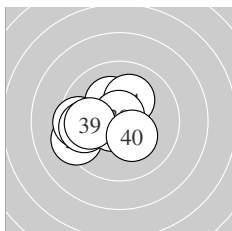

Serie 4:  
 9.3 ← 10.6 \* 10.2 \* 10.1 ↗ 9.5 ←  
 9.7 ← 10.7 \* 10.8 \* 9.9 ← 10.3 \*  
 beste Teiler 44.4 (38.) 75.1 (37.) 81.3 (32.)  
 Trefferlage 1.34 mm links, 0.03 mm tief  
 Streuwert 1.49, horizontal: 1.79, vertikal: 1.11

Unterschrift des Schützen

Meyton Elektronik

Ergebnis: **413.1** (392)  
 Serien: 102.3 103.9 102.0 104.9  
 Zähler: 32 8 0 0 0 0 0 0 0 0  
 Innenzehner: 28  
 weiteste: 403 (1), 350 (23), 316 (7)  
 beste Teiler 36.4 (35.) 47.0 (18.) 59.5 (8.)  
 Trefferlage 0.50 mm rechts, 0.38 mm tief  
 Streuwert 1.21, horizontal: 1.33, vertikal: 1.08

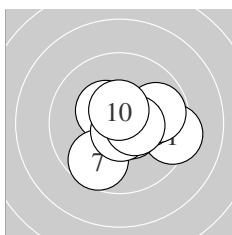
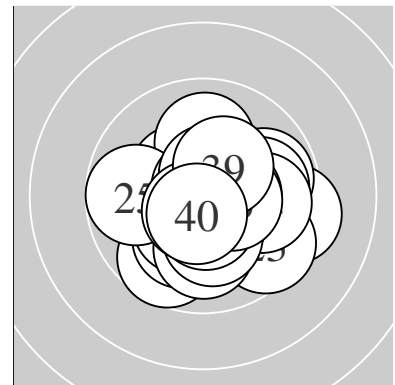

Serie 1:  
 9.3 → 10.6 \* 10.1 → 9.8 → 10.6 \*  
 10.4 \* 9.7 ↙ 10.7 \* 10.5 \* 10.6 \*  
 beste Teiler 59.5 (8.) 78.7 (5.) 90.3 (2.)  
 Trefferlage 0.76 mm rechts, 0.08 mm tief  
 Streuwert 1.46, horizontal: 1.72, vertikal: 1.14

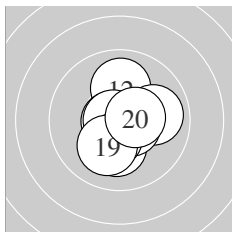

Serie 2:  
 10.7 \* 10.0 ↑ 10.2 \* 9.9 → 10.6 \*  
 10.7 \* 10.4 \* 10.8 \* 10.1 ↙ 10.5 \*  
 beste Teiler 47.0 (18.) 63.6 (16.) 68.6 (11.)  
 Trefferlage 0.23 mm rechts, 0.23 mm tief  
 Streuwert 1.17, horizontal: 1.05, vertikal: 1.28

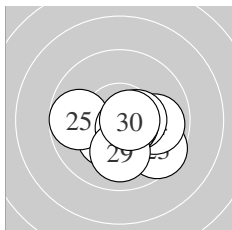

Serie 3:  
 10.3 \* 9.9 ↘ 9.6 ↘ 9.9 → 9.8 ←  
 10.4 \* 10.7 \* 10.7 \* 10.0 ↓ 10.7 \*  
 beste Teiler 71.5 (27.) 73.0 (28.) 75.0 (30.)  
 Trefferlage 0.69 mm rechts, 0.81 mm tief  
 Streuwert 1.39, horizontal: 1.76, vertikal: 0.89

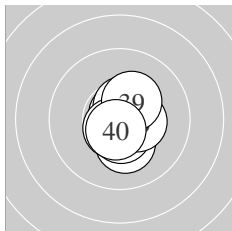

Serie 4:  
 10.5 \* 10.4 \* 10.2 \* 10.5 \* 10.8 \*  
 10.4 \* 10.6 \* 10.6 \* 10.3 \* 10.6 \*  
 beste Teiler 36.4 (35.) 83.0 (38.) 84.7 (40.)  
 Trefferlage 0.33 mm rechts, 0.42 mm tief  
 Streuwert 0.81, horizontal: 0.54, vertikal: 1.01

Unterschrift des Schützen

Meyton Elektronik

Ergebnis: **404.7** (386)  
 Serien: 101.2 98.6 101.3 103.6  
 Zähler: 28 10 2 0 0 0 0 0 0 0  
 Innenzehner: 21  
 weiteste: 523 (22), 512 (9), 378 (10)  
 beste Teiler 3.6 (25.) 66.4 (40.) 67.3 (28.)  
 Trefferlage 0.33 mm links, 0.09 mm tief  
 Streuwert 1.69, horizontal: 1.44, vertikal: 1.91

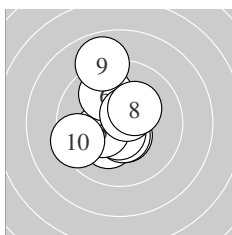
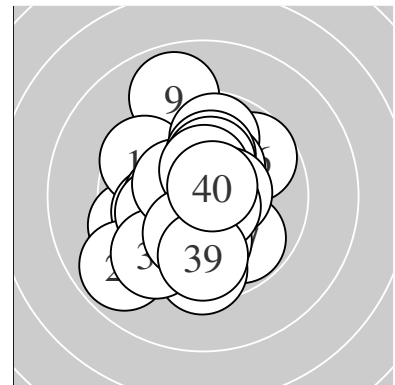

Serie 1:  
 10.2 \* 10.5 \* 10.5 \* 10.6 \* 10.3 \*  
 9.9 ↘ 10.6 \* 10.3 \* 8.9 ↑ 9.4 ←  
 beste Teiler 80.3 (4.) 94.6 (7.) 107.9 (3.)  
 Trefferlage 0.59 mm links, 0.28 mm hoch  
 Streuwert 1.76, horizontal: 1.38, vertikal: 2.08

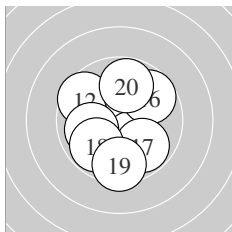

Serie 2:  
 10.1 ↑ 9.6 ↘ 10.1 ↑ 10.2 \* 10.0 ←  
 9.7 ↗ 9.8 ↘ 9.8 ↙ 9.5 ↓ 9.8 ↑  
 beste Teiler 179.4 (14.) 220.0 (13.) 225.0 (11.)  
 Trefferlage 0.05 mm rechts, 0.04 mm hoch  
 Streuwert 2.08, horizontal: 1.82, vertikal: 2.31

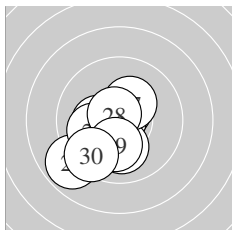

Serie 3:  
 10.6 \* 8.9 ↙ 10.2 \* 10.0 ← 10.9 \*  
 10.1 ↓ 10.3 \* 10.7 \* 10.1 ↓ 9.5 ↙  
 beste Teiler 3.6 (25.) 67.3 (28.) 80.9 (21.)  
 Trefferlage 0.96 mm links, 0.89 mm tief  
 Streuwert 1.58, horizontal: 1.51, vertikal: 1.65

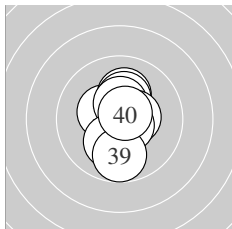

Serie 4:  
 10.6 \* 10.4 \* 10.1 ↑ 10.3 \* 10.4 \*  
 10.5 \* 10.6 \* 10.2 \* 9.8 ↓ 10.7 \*  
 beste Teiler 66.4 (40.) 81.0 (37.) 96.1 (31.)  
 Trefferlage 0.14 mm rechts, 0.17 mm hoch  
 Streuwert 1.22, horizontal: 0.71, vertikal: 1.57

Unterschrift des Schützen

Meyton Elektronik

Ergebnis: **412.1** (397)  
 Serien: 103.7 103.6 103.6 101.2  
 Zähler: 37 3 0 0 0 0 0 0 0 0  
 Innenzehner: 24  
 weiteste: 411 (38), 284 (34), 260 (37)  
 beste Teiler 19.2 (25.) 23.0 (39.) 31.9 (18.)  
 Trefferlage 0.14 mm rechts, 0.00 mm  
 Streuwert 1.30, horizontal: 1.47, vertikal: 1.10

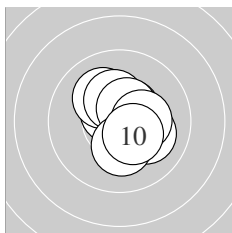
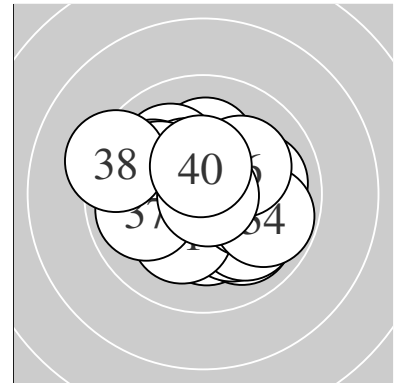

Serie 1:  
 10.5 \* 10.7 \* 10.1 ↘ 10.6 \* 10.1 ↖  
 10.3 \* 10.5 \* 10.3 \* 10.2 \* 10.4 \*  
 beste Teiler 67.0 (2.) 91.2 (4.) 108.7 (7.)  
 Trefferlage 0.36 mm rechts, 0.27 mm hoch  
 Streuwert 1.07, horizontal: 0.99, vertikal: 1.15

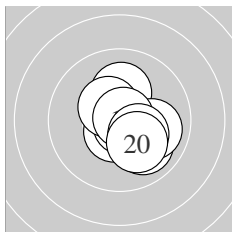

Serie 2:  
 10.1 ↑ 10.5 \* 10.6 \* 10.8 \* 10.0 ↘  
 10.4 \* 10.0 → 10.8 \* 10.3 \* 10.1 ↘  
 beste Teiler 31.9 (18.) 42.5 (14.) 93.0 (13.)  
 Trefferlage 0.68 mm rechts, 0.39 mm tief  
 Streuwert 1.08, horizontal: 0.99, vertikal: 1.17

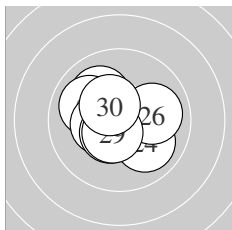

Serie 3:  
 10.1 ↖ 10.0 ↖ 10.8 \* 10.0 ↘ 10.9 \*  
 10.0 → 10.4 \* 10.5 \* 10.5 \* 10.4 \*  
 beste Teiler 19.2 (25.) 40.4 (23.) 105.3 (29.)  
 Trefferlage 0.33 mm links, 0.05 mm hoch  
 Streuwert 1.25, horizontal: 1.43, vertikal: 1.04

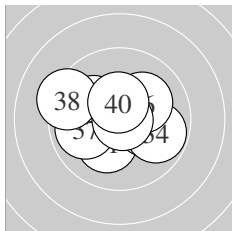

Serie 4:  
 10.2 \* 10.1 → 10.3 \* 9.8 → 10.1 ↖  
 10.1 ↗ 9.9 ← 9.3 ↖ 10.9 \* 10.5 \*  
 beste Teiler 23.0 (39.) 122.4 (40.) 155.6 (33.)  
 Trefferlage 0.12 mm links, 0.09 mm hoch  
 Streuwert 1.70, horizontal: 2.15, vertikal: 1.08

Unterschrift des Schützen



Ergebnis: **408.7** (391)  
 Serien: 100.6 102.7 104.0 101.4  
 Zähler: 31 9 0 0 0 0 0 0 0 0  
 Innenzehner: 20  
 weiteste: 371 (1), 308 (32), 298 (31)  
 beste Teiler 22.3 (28.) 27.5 (26.) 64.4 (14.)  
 Trefferlage 0.20 mm links, 0.27 mm tief  
 Streuwert 1.44, horizontal: 1.54, vertikal: 1.34

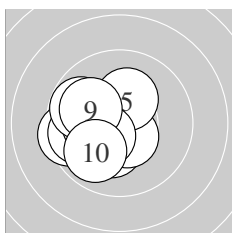
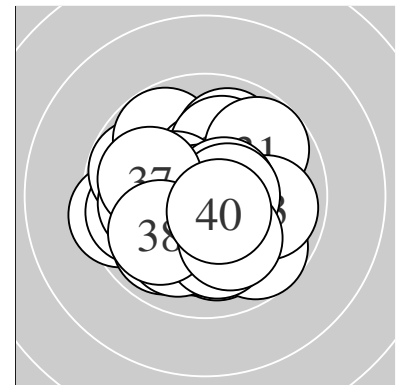

Serie 1:  
 9.5 ←                      10.3 \*                      9.8 ←                      10.5 \*                      10.2 \*  
 10.2 \*                      9.8 ↖                      10.4 \*                      10.0 ↖                      9.9 ↙  
 beste Teiler 109.7 (4.) 142.7 (8.) 175.1 (2.)  
 Trefferlage 1.55 mm links, 0.32 mm tief  
 Streuwert 1.32, horizontal: 1.41, vertikal: 1.23

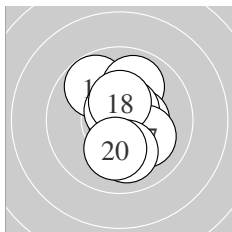

Serie 2:  
 9.8 ↘                      9.9 ↗                      10.4 \*                      10.7 \*                      10.7 \*  
 10.6 \*                      10.1 ↘                      10.4 \*                      10.0 ↓                      10.1 ↓  
 beste Teiler 64.4 (14.) 71.5 (15.) 92.9 (16.)  
 Trefferlage 0.29 mm rechts, 0.13 mm hoch  
 Streuwert 1.37, horizontal: 0.99, vertikal: 1.66

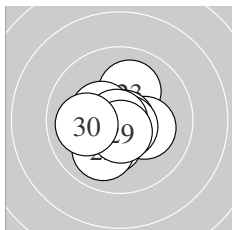

Serie 3:  
 10.3 \*                      10.0 ↙                      10.1 ↗                      10.4 \*                      10.2 \*  
 10.8 \*                      10.7 \*                      10.9 \*                      10.6 \*                      10.0 ←  
 beste Teiler 22.3 (28.) 27.5 (26.) 67.2 (27.)  
 Trefferlage 0.22 mm links, 0.33 mm tief  
 Streuwert 1.15, horizontal: 1.18, vertikal: 1.13

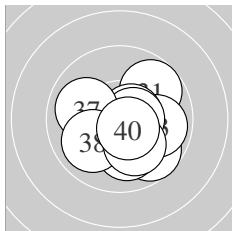

Serie 4:  
 9.8 ↗                      9.7 ↘                      9.9 →                      10.1 ↓                      10.6 \*  
 10.6 \*                      10.0 ←                      10.0 ↙                      10.1 ↓                      10.6 \*  
 beste Teiler 85.3 (35.) 89.9 (40.) 97.0 (36.)  
 Trefferlage 0.67 mm rechts, 0.59 mm tief  
 Streuwert 1.52, horizontal: 1.66, vertikal: 1.37

Unterschrift des Schützen

Meyton Elektronik

Ergebnis: **409.1** (394)  
 Serien: 102.4 103.7 102.1 100.9  
 Zähler: 34 6 0 0 0 0 0 0 0 0  
 Innenzehner: 26  
 weiteste: 479 (36), 380 (10), 363 (35)  
 beste Teiler 26.0 (2.) 41.0 (32.) 57.7 (16.)  
 Trefferlage 0.33 mm rechts, 0.32 mm hoch  
 Streuwert 1.42, horizontal: 1.56, vertikal: 1.27

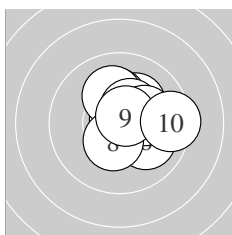
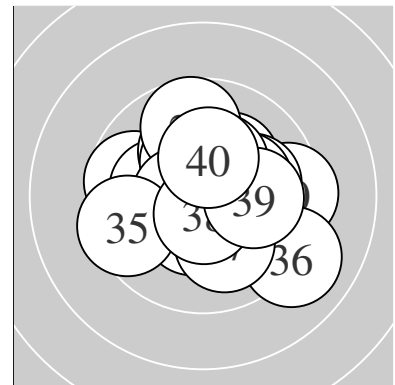

Serie 1:  
 10.2 \*                      10.8 \*                      10.2 \*                      10.1 ↑                      10.4 \*  
 10.0 ↘                      10.2 \*                      10.4 \*                      10.7 \*                      9.4 →  
 beste Teiler 26.0 (2.) 70.1 (9.) 133.2 (5.)  
 Trefferlage 0.87 mm rechts, 0.54 mm hoch  
 Streuwert 1.26, horizontal: 1.37, vertikal: 1.15

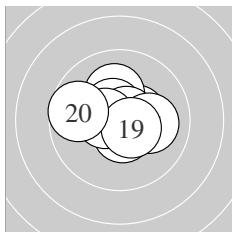

Serie 2:  
 10.4 \*                      10.4 \*                      10.2 \*                      10.6 \*                      10.6 \*  
 10.7 \*                      10.1 →                      10.5 \*                      10.5 \*                      9.7 ←  
 beste Teiler 57.7 (16.) 95.8 (15.) 99.9 (14.)  
 Trefferlage 0.04 mm links, 0.37 mm hoch  
 Streuwert 1.18, horizontal: 1.43, vertikal: 0.86

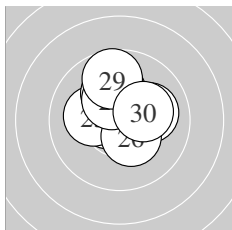

Serie 3:  
 10.6 \*                      10.4 \*                      10.2 \*                      10.1 ↑                      10.1 →  
 10.4 \*                      10.1 ↑                      10.3 \*                      9.7 ↑                      10.2 \*  
 beste Teiler 84.5 (21.) 136.1 (22.) 147.6 (26.)  
 Trefferlage 0.12 mm links, 0.95 mm hoch  
 Streuwert 1.26, horizontal: 1.31, vertikal: 1.21

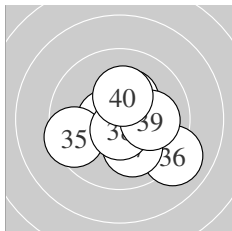

Serie 4:  
 10.3 \*                      10.8 \*                      10.6 \*                      9.8 ↘                      9.5 ←  
 9.0 ↘                      10.0 ↓                      10.6 \*                      10.0 →                      10.3 \*  
 beste Teiler 41.0 (32.) 80.0 (38.) 93.0 (33.)  
 Trefferlage 0.63 mm rechts, 0.59 mm tief  
 Streuwert 1.75, horizontal: 2.02, vertikal: 1.43

Unterschrift des Schützen

Meyton Elektronik

Ergebnis: **408.4** (392)  
 Serien: 103.2 101.7 102.2 101.3  
 Zähler: 32 8 0 0 0 0 0 0 0 0  
 Innenzehner: 24  
 weiteste: 481 (34), 385 (16), 363 (20)  
 beste Teiler 42.3 (8.) 54.5 (15.) 61.1 (32.)  
 Trefferlage 0.05 mm rechts, 0.14 mm tief  
 Streuwert 1.49, horizontal: 1.73, vertikal: 1.20

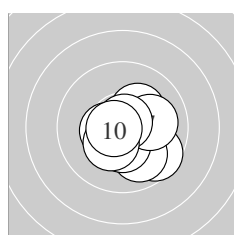
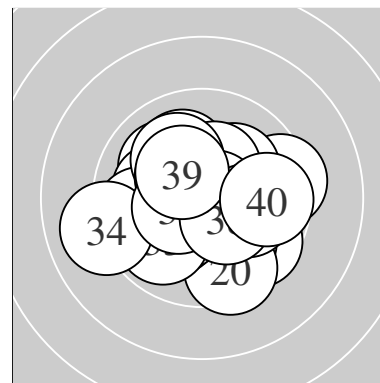

Serie 1:  
 9.6 ↘ 10.6 \* 9.9 ↘ 10.5 \* 10.4 \*  
 10.3 \* 10.1 → 10.8 \* 10.3 \* 10.7 \*  
 beste Teiler 42.3 (8.) 69.8 (10.) 94.8 (2.)  
 Trefferlage 0.51 mm rechts, 0.60 mm tief  
 Streuwert 1.21, horizontal: 1.30, vertikal: 1.13

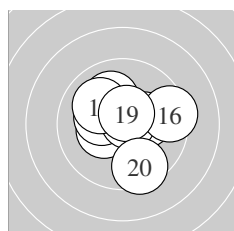

Serie 2:  
 10.3 \* 10.3 \* 10.6 \* 10.2 \* 10.7 \*  
 9.4 → 10.1 ↖ 10.0 ↘ 10.6 \* 9.5 ↘  
 beste Teiler 54.5 (15.) 89.6 (13.) 91.4 (19.)  
 Trefferlage 0.25 mm rechts, 0.28 mm hoch  
 Streuwert 1.63, horizontal: 1.78, vertikal: 1.45

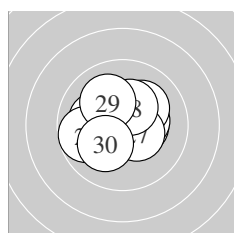

Serie 3:  
 10.4 \* 10.3 \* 10.1 ← 10.6 \* 10.1 ↗  
 9.8 ← 10.4 \* 10.3 \* 10.1 ↖ 10.1 ↗  
 beste Teiler 86.4 (24.) 129.8 (27.) 145.2 (21.)  
 Trefferlage 0.18 mm links, 0.17 mm hoch  
 Streuwert 1.40, horizontal: 1.65, vertikal: 1.10

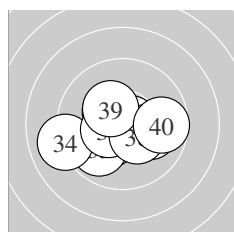

Serie 4:  
 10.3 \* 10.7 \* 9.9 ↙ 9.0 ← 10.4 \*  
 10.5 \* 10.1 → 10.4 \* 10.3 \* 9.7 →  
 beste Teiler 61.1 (32.) 121.2 (36.) 140.7 (35.)  
 Trefferlage 0.35 mm links, 0.44 mm tief  
 Streuwert 1.72, horizontal: 2.20, vertikal: 1.02

Unterschrift des Schützen

Meyton Elektronik

Ergebnis: **408.4** (389)  
 Serien: 100.7 102.1 103.7 101.9  
 Zähler: 29 11 0 0 0 0 0 0 0 0  
 Innenzehner: 23  
 weiteste: 403 (17), 372 (36), 338 (34)  
 beste Teiler 12.6 (12.) 31.8 (26.) 47.0 (39.)  
 Trefferlage 0.38 mm rechts, 0.25 mm tief  
 Streuwert 1.45, horizontal: 1.34, vertikal: 1.55

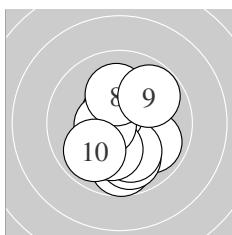
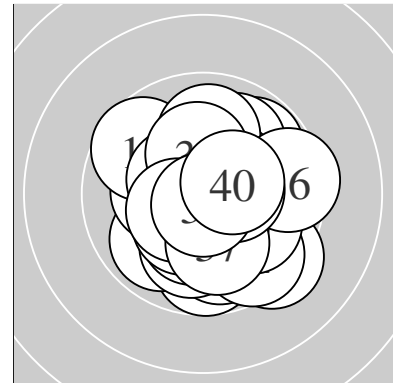

Serie 1:  
 9.9 ↘ 9.7 ↓ 9.9 ↓ 10.1 ↓ 10.6 \*  
 10.2 \* 10.5 \* 10.1 ↑ 9.8 ↗ 9.9 ↙  
 beste Teiler 85.8 (5.) 104.6 (7.) 197.1 (6.)  
 Trefferlage 0.18 mm rechts, 0.81 mm tief  
 Streuwert 1.60, horizontal: 1.31, vertikal: 1.85

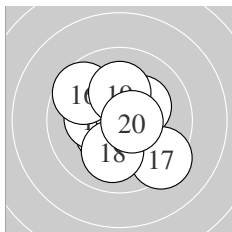

Serie 2:  
 10.4 \* 10.9 \* 10.2 \* 10.6 \* 10.2 \*  
 9.7 ↘ 9.3 ↘ 10.0 ↓ 10.2 \* 10.6 \*  
 beste Teiler 12.6 (12.) 89.8 (20.) 96.1 (14.)  
 Trefferlage 0.02 mm links, 0.01 mm hoch  
 Streuwert 1.60, horizontal: 1.60, vertikal: 1.59

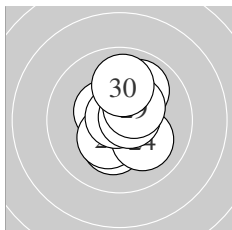

Serie 3:  
 10.3 \* 10.5 \* 10.4 \* 10.1 ↘ 10.7 \*  
 10.8 \* 10.7 \* 9.9 ↗ 10.4 \* 9.9 ↑  
 beste Teiler 31.8 (26.) 66.4 (25.) 74.0 (27.)  
 Trefferlage 0.27 mm rechts, 0.27 mm hoch  
 Streuwert 1.19, horizontal: 0.92, vertikal: 1.42

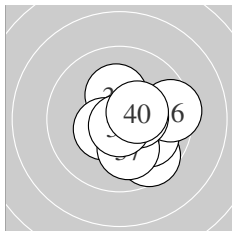

Serie 4:  
 10.3 \* 10.4 \* 10.4 \* 9.6 ↘ 10.0 ↘  
 9.5 → 10.1 ↓ 10.4 \* 10.8 \* 10.4 \*  
 beste Teiler 47.0 (39.) 128.8 (38.) 130.0 (32.)  
 Trefferlage 1.08 mm rechts, 0.49 mm tief  
 Streuwert 1.34, horizontal: 1.36, vertikal: 1.31

Unterschrift des Schützen

Meyton Elektronik

Ergebnis: **407.6** (391)  
 Serien: 101.9 101.6 103.5 100.6  
 Zähler: 32 7 1 0 0 0 0 0 0 0  
 Innenzehner: 26  
 weiteste: 517 (7), 437 (34), 366 (33)  
 beste Teiler 58.8 (24.) 59.2 (25.) 73.3 (9.)  
 Trefferlage 0.28 mm links, 0.08 mm tief  
 Streuwert 1.52, horizontal: 1.80, vertikal: 1.18

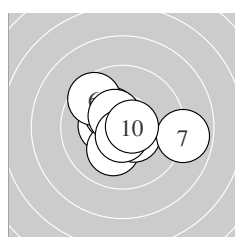
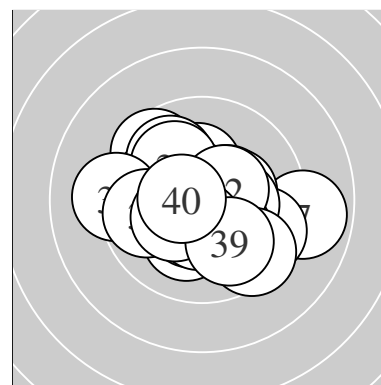

Serie 1:  
 10.4 \*                      10.3 \*                      10.3 \*                      10.1 ↙                      10.5 \*  
 9.6 ↘                      8.9 →                      10.5 \*                      10.7 \*                      10.6 \*  
 beste Teiler 73.3 (9.) 79.1 (10.) 117.6 (8.)  
 Trefferlage 0.07 mm links, 0.15 mm hoch  
 Streuwert 1.72, horizontal: 2.09, vertikal: 1.24

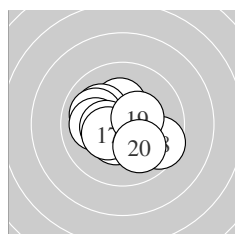

Serie 2:  
 10.3 \*                      10.4 \*                      10.1 ↘                      10.0 ↖                      10.0 ←  
 10.4 \*                      10.4 \*                      9.6 ↘                      10.4 \*                      10.0 ↘  
 beste Teiler 132.4 (12.) 137.0 (19.) 142.0 (16.)  
 Trefferlage 0.40 mm links, 0.14 mm tief  
 Streuwert 1.53, horizontal: 1.80, vertikal: 1.20

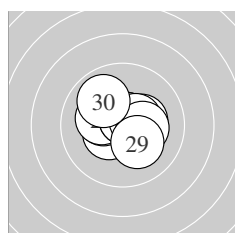

Serie 3:  
 10.4 \*                      10.3 \*                      10.2 \*                      10.7 \*                      10.7 \*  
 10.3 \*                      10.5 \*                      10.3 \*                      10.2 \*                      9.9 ↘  
 beste Teiler 58.8 (24.) 59.2 (25.) 117.1 (27.)  
 Trefferlage 0.01 mm links, 0.26 mm hoch  
 Streuwert 1.19, horizontal: 1.41, vertikal: 0.92

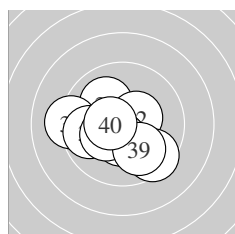

Serie 4:  
 10.1 ↘                      10.4 \*                      9.5 ↘                      9.2 ←                      10.5 \*  
 9.8 ←                      10.4 \*                      10.3 \*                      9.9 ↘                      10.5 \*  
 beste Teiler 104.1 (40.) 119.2 (35.) 127.0 (32.)  
 Trefferlage 0.64 mm links, 0.62 mm tief  
 Streuwert 1.71, horizontal: 2.05, vertikal: 1.30

Unterschrift des Schützen

Meyton Elektronik

Ergebnis: **404.4** (386)  
 Serien: 98.5 102.6 101.6 101.7  
 Zähler: 27 12 1 0 0 0 0 0 0 0  
 Innenzehner: 20  
 weiteste: 554 (10), 490 (1), 423 (5)  
 beste Teiler 33.2 (14.) 40.1 (37.) 71.6 (13.)  
 Trefferlage 0.33 mm links, 0.27 mm tief  
 Streuwert 1.71, horizontal: 2.17, vertikal: 1.06

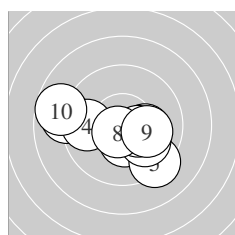
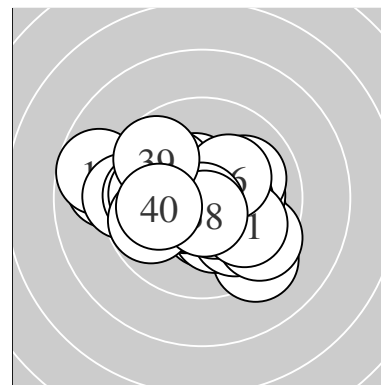

Serie 1:  
 9.0 ←                      10.2 \*                      10.4 \*                      9.7 ←                      9.3 ↘  
 10.0 ↘                      10.4 \*                      10.7 \*                      10.1 →                      8.7 ←  
 beste Teiler 73.0 (8.) 140.2 (3.) 144.1 (7.)  
 Trefferlage 0.34 mm links, 0.59 mm tief  
 Streuwert 2.32, horizontal: 3.04, vertikal: 1.23

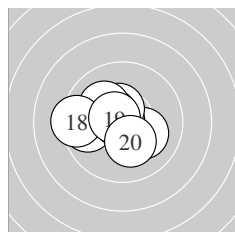

Serie 2:  
 10.2 \*                      9.7 ←                      10.7 \*                      10.8 \*                      10.5 \*  
 10.5 \*                      10.1 ↘                      9.3 ←                      10.6 \*                      10.2 \*  
 beste Teiler 33.2 (14.) 71.6 (13.) 81.0 (19.)  
 Trefferlage 0.90 mm links, 0.13 mm hoch  
 Streuwert 1.35, horizontal: 1.67, vertikal: 0.93

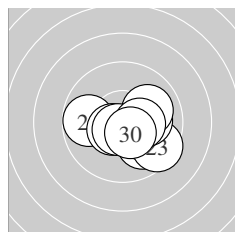

Serie 3:  
 9.9 ↘                      10.3 \*                      9.5 ↘                      10.1 →                      9.8 ←  
 10.0 →                      10.5 \*                      10.6 \*                      10.4 \*                      10.5 \*  
 beste Teiler 76.8 (28.) 108.0 (27.) 115.2 (30.)  
 Trefferlage 0.82 mm rechts, 0.59 mm tief  
 Streuwert 1.42, horizontal: 1.77, vertikal: 0.94

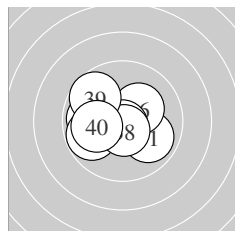

Serie 4:  
 9.9 ↘                      9.9 ←                      9.8 ←                      10.6 \*                      10.1 ↘  
 10.3 \*                      10.8 \*                      10.6 \*                      9.7 ↘                      10.0 ←  
 beste Teiler 40.1 (37.) 83.0 (38.) 90.6 (34.)  
 Trefferlage 0.90 mm links, 0.03 mm tief  
 Streuwert 1.46, horizontal: 1.77, vertikal: 1.07

Unterschrift des Schützen

Meyton Elektronik

Ergebnis: **389.8** (371)  
 Serien: 98.0 96.1 99.4 96.3  
 Zähler: 17 18 4 1 0 0 0 0 0 0  
 Innenzehner: 15  
 weiteste: 856 (12), 576 (5), 551 (39)  
 beste Teiler 38.0 (29.) 85.0 (19.) 96.2 (22.)  
 Trefferlage 0.31 mm links, 0.04 mm hoch  
 Streuwert 2.46, horizontal: 3.17, vertikal: 1.43

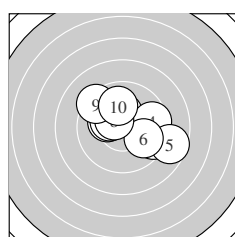
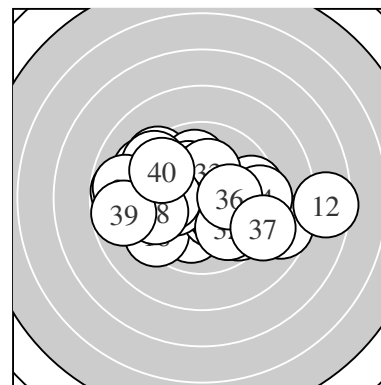

Serie 1:  
 10.2 \*                      9.4 ↘                      10.3 \*                      9.6 →                      8.6 ↘  
 9.9 ↘                      10.3 \*                      10.5 \*                      9.3 ↖                      9.9 ↑  
 beste Teiler 125.0 (8.) 164.2 (7.) 166.0 (3.)  
 Trefferlage 0.69 mm rechts, 0.48 mm hoch  
 Streuwert 2.28, horizontal: 2.80, vertikal: 1.60

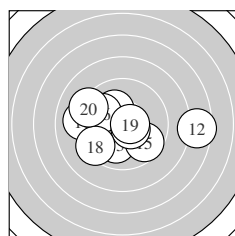

Serie 2:  
 9.1 ←                      7.5 →                      10.0 ↓                      10.2 \*                      9.7 ↘  
 9.9 ↖                      10.5 \*                      9.4 ↗                      10.6 \*                      9.2 ↖  
 beste Teiler 85.0 (19.) 109.2 (17.) 192.0 (14.)  
 Trefferlage 0.29 mm links, 0.25 mm tief  
 Streuwert 2.96, horizontal: 3.85, vertikal: 1.62

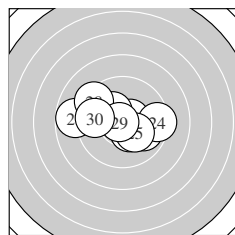

Serie 3:  
 9.9 ↘                      10.6 \*                      10.4 \*                      9.4 →                      10.2 \*  
 10.3 \*                      8.8 ←                      9.3 ↖                      10.8 \*                      9.7 ←  
 beste Teiler 38.0 (29.) 96.2 (22.) 141.7 (23.)  
 Trefferlage 0.40 mm links, 0.15 mm hoch  
 Streuwert 2.20, horizontal: 2.90, vertikal: 1.13

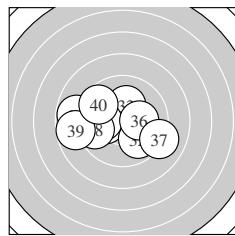

Serie 4:  
 10.2 \*                      9.9 ↘                      10.2 \*                      10.0 ←                      8.8 ←  
 10.2 \*                      9.1 ↘                      9.6 ←                      8.7 ←                      9.6 ↖  
 beste Teiler 187.7 (33.) 191.1 (36.) 198.4 (31.)  
 Trefferlage 1.26 mm links, 0.19 mm tief  
 Streuwert 2.48, horizontal: 3.22, vertikal: 1.40

Unterschrift des Schützen

Meyton Elektronik

Ergebnis: **415.3** (397)  
 Serien: 103.9 105.1 103.0 103.3  
 Zähler: 37 3 0 0 0 0 0 0 0 0  
 Innenzehner: 32  
 weiteste: 395 (34), 348 (30), 254 (40)  
 beste Teiler 7.2 (35.) 11.0 (20.) 34.9 (31.)  
 Trefferlage 0.46 mm links, 0.08 mm hoch  
 Streuwert 1.13, horizontal: 1.28, vertikal: 0.96

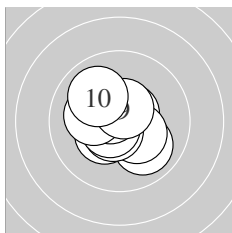
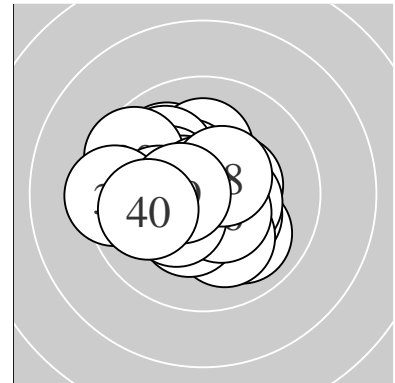

Serie 1:  
 10.0 ↘ 10.6 \* 10.3 \* 10.4 \* 10.6 \*  
 10.6 \* 10.6 \* 10.2 \* 10.6 \* 10.0 ↖  
 beste Teiler 84.3 (6.) 88.8 (7.) 89.0 (5.)  
 Trefferlage 0.24 mm links, 0.05 mm tief  
 Streuwert 1.16, horizontal: 1.22, vertikal: 1.09

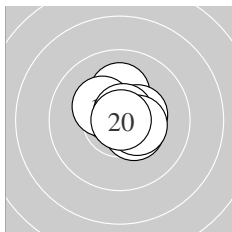

Serie 2:  
 10.4 \* 10.6 \* 10.5 \* 10.1 ↑ 10.8 \*  
 10.4 \* 10.3 \* 10.7 \* 10.4 \* 10.9 \*  
 beste Teiler 11.0 (20.) 40.5 (15.) 54.2 (18.)  
 Trefferlage 0.30 mm rechts, 0.45 mm hoch  
 Streuwert 0.80, horizontal: 0.81, vertikal: 0.79

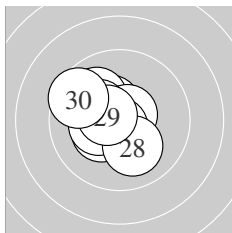

Serie 3:  
 10.4 \* 10.0 ↘ 10.7 \* 10.3 \* 10.3 \*  
 10.7 \* 10.3 \* 10.1 ↘ 10.6 \* 9.6 ↖  
 beste Teiler 54.8 (26.) 69.6 (23.) 99.7 (29.)  
 Trefferlage 0.94 mm links, 0.22 mm hoch  
 Streuwert 1.17, horizontal: 1.19, vertikal: 1.16

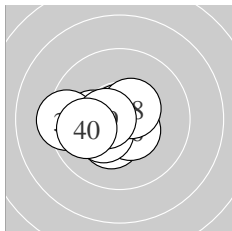

Serie 4:  
 10.8 \* 10.3 \* 10.2 \* 9.4 ← 10.9 \*  
 10.5 \* 10.3 \* 10.5 \* 10.5 \* 9.9 ←  
 beste Teiler 7.2 (35.) 34.9 (31.) 101.0 (39.)  
 Trefferlage 0.95 mm links, 0.30 mm tief  
 Streuwert 1.17, horizontal: 1.51, vertikal: 0.68

Unterschrift des Schützen



Ergebnis: **408.1** (391)  
 Serien: 102.6 102.8 102.2 100.5  
 Zähler: 31 9 0 0 0 0 0 0 0 0  
 Innenzehner: 23  
 weiteste: 477 (40), 343 (16), 335 (39)  
 beste Teiler 31.5 (24.) 46.2 (14.) 69.8 (2.)  
 Trefferlage 0.09 mm links, 0.21 mm tief  
 Streuwert 1.50, horizontal: 1.71, vertikal: 1.26

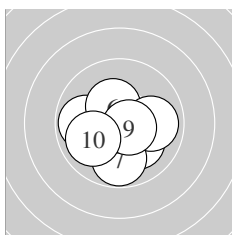
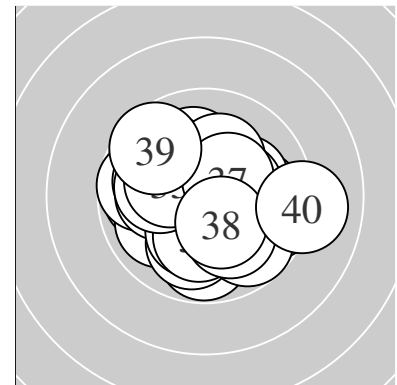

Serie 1:  
 9.9 ← 10.7 \* 10.6 \* 10.6 \* 10.1 ↘  
 10.4 \* 9.8 ↓ 9.9 → 10.6 \* 10.0 ↙  
 beste Teiler 69.8 (2.) 83.6 (9.) 84.8 (3.)  
 Trefferlage 0.22 mm links, 0.65 mm tief  
 Streuwert 1.35, horizontal: 1.56, vertikal: 1.11

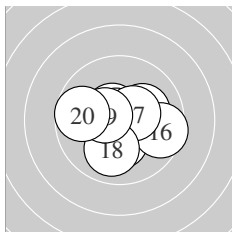

Serie 2:  
 10.2 \* 10.6 \* 10.6 \* 10.8 \* 10.3 \*  
 9.6 → 10.5 \* 10.0 ↓ 10.5 \* 9.7 ←  
 beste Teiler 46.2 (14.) 96.8 (12.) 96.8 (13.)  
 Trefferlage 0.07 mm rechts, 0.25 mm tief  
 Streuwert 1.46, horizontal: 1.74, vertikal: 1.12

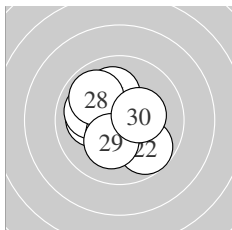

Serie 3:  
 10.5 \* 9.8 ↘ 10.1 ← 10.8 \* 10.0 ↘  
 10.1 ↑ 10.5 \* 9.9 ↙ 10.2 \* 10.3 \*  
 beste Teiler 31.5 (24.) 116.2 (27.) 125.5 (21.)  
 Trefferlage 0.55 mm links, 0.00 mm  
 Streuwert 1.43, horizontal: 1.47, vertikal: 1.40

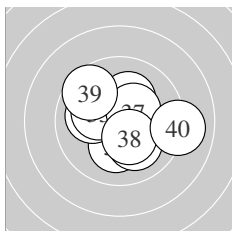

Serie 4:  
 10.2 \* 10.1 ← 10.2 \* 10.1 ↘ 10.2 \*  
 10.4 \* 10.4 \* 10.3 \* 9.6 ↘ 9.0 →  
 beste Teiler 135.0 (36.) 140.0 (37.) 152.1 (38.)  
 Trefferlage 0.33 mm rechts, 0.04 mm hoch  
 Streuwert 1.82, horizontal: 2.13, vertikal: 1.45

Unterschrift des Schützen

Meyton Elektronik

Ergebnis: **413.2** (398)  
 Serien: 102.2 104.7 103.4 102.9  
 Zähler: 38 2 0 0 0 0 0 0 0 0  
 Innenzehner: 26  
 weiteste: 367 (8), 316 (9), 249 (37)  
 beste Teiler 22.3 (4.) 74.5 (10.) 77.6 (7.)  
 Trefferlage 0.00 mm , 0.63 mm tief  
 Streuwert 1.15, horizontal: 1.15, vertikal: 1.15

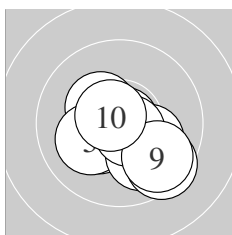
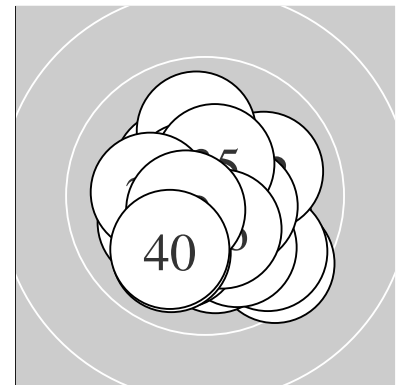

Serie 1:  
 10.1 ↘                      10.3 \*                      10.3 \*                      10.9 \*                      10.1 ↙  
 10.0 ↘                      10.6 \*                      9.5 ↘                      9.7 ↘                      10.7 \*  
 beste Teiler 22.3 (4.) 74.5 (10.) 77.6 (7.)  
 Trefferlage 0.41 mm rechts, 0.86 mm tief  
 Streuwert 1.39, horizontal: 1.60, vertikal: 1.15

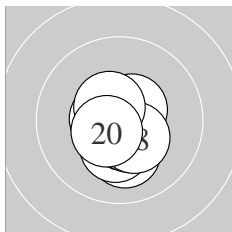

Serie 2:  
 10.6 \*                      10.1 ↓                      10.6 \*                      10.6 \*                      10.3 \*  
 10.6 \*                      10.5 \*                      10.4 \*                      10.5 \*                      10.5 \*  
 beste Teiler 91.2 (11.) 92.4 (14.) 96.5 (16.)  
 Trefferlage 0.03 mm links, 0.52 mm tief  
 Streuwert 0.87, horizontal: 0.70, vertikal: 1.02

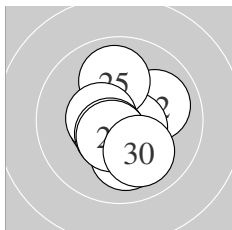

Serie 3:  
 10.6 \*                      10.0 →                      10.6 \*                      10.6 \*                      10.0 ↑  
 10.5 \*                      10.1 ↓                      10.5 \*                      10.5 \*                      10.0 ↘  
 beste Teiler 82.4 (21.) 89.6 (24.) 99.2 (23.)  
 Trefferlage 0.15 mm rechts, 0.38 mm tief  
 Streuwert 1.21, horizontal: 1.06, vertikal: 1.35

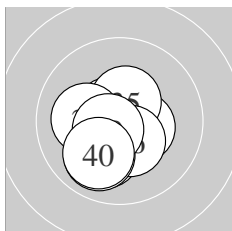

Serie 4:  
 10.4 \*                      10.6 \*                      10.1 ↙                      10.3 \*                      10.4 \*  
 10.4 \*                      10.0 ↙                      10.1 ←                      10.6 \*                      10.0 ↙  
 beste Teiler 79.3 (32.) 90.2 (39.) 127.4 (35.)  
 Trefferlage 0.54 mm links, 0.78 mm tief  
 Streuwert 1.09, horizontal: 1.01, vertikal: 1.17

Unterschrift des Schützen

Ergebnis: **400.7** (382)  
 Serien: 102.1 98.8 100.5 99.3  
 Zähler: 22 18 0 0 0 0 0 0 0 0  
 Innenzehner: 19  
 weiteste: 466 (36), 449 (7), 431 (19)  
 beste Teiler 24.0 (6.) 56.8 (9.) 68.5 (2.)  
 Trefferlage 0.84 mm links, 0.34 mm hoch  
 Streuwert 1.76, horizontal: 2.14, vertikal: 1.28

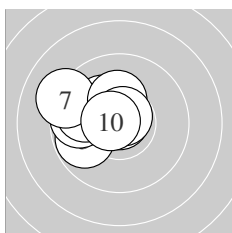
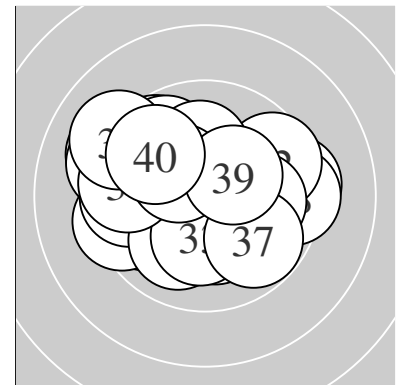

Serie 1:  
 10.2 \*                      10.7 \*                      9.8 ←                      9.7 ←                      9.9 ←  
 10.9 \*                      9.2 ↘                      10.3 \*                      10.7 \*                      10.7 \*  
 beste Teiler 24.0 (6.) 56.8 (9.) 68.5 (2.)  
 Trefferlage 1.41 mm links, 0.66 mm hoch  
 Streuwert 1.26, horizontal: 1.55, vertikal: 0.88

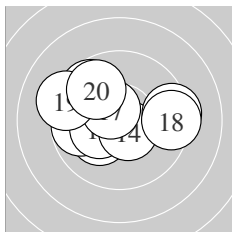

Serie 2:  
 10.2 \*                      9.8 ←                      10.3 \*                      10.5 \*                      9.7 ↘  
 9.4 →                      10.5 \*                      9.4 →                      9.2 ↘                      9.8 ↘  
 beste Teiler 103.2 (14.) 105.8 (17.) 166.6 (13.)  
 Trefferlage 0.62 mm links, 0.43 mm hoch  
 Streuwert 2.11, horizontal: 2.70, vertikal: 1.28

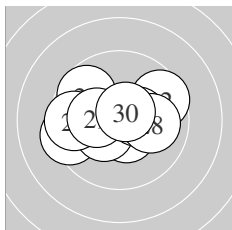

Serie 3:  
 9.4 ←                      9.6 →                      9.7 ↘                      10.5 \*                      10.4 \*  
 10.4 \*                      9.6 ←                      10.0 →                      10.3 \*                      10.6 \*  
 beste Teiler 76.6 (30.) 111.4 (24.) 135.7 (26.)  
 Trefferlage 0.48 mm links, 0.12 mm hoch  
 Streuwert 1.84, horizontal: 2.39, vertikal: 1.02

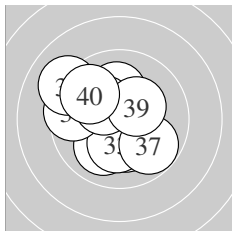

Serie 4:  
 10.0 ↙                      10.2 \*                      10.2 \*                      9.5 ←                      10.1 ↑  
 9.1 ↘                      9.8 ↘                      10.3 \*                      10.3 \*                      9.8 ↘  
 beste Teiler 158.0 (38.) 158.6 (39.) 182.8 (32.)  
 Trefferlage 0.86 mm links, 0.15 mm hoch  
 Streuwert 1.91, horizontal: 1.97, vertikal: 1.84

Unterschrift des Schützen

Meyton Elektronik

Ergebnis: **414.4** (396)  
 Serien: 104.7 103.9 104.1 101.7  
 Zähler: 36 4 0 0 0 0 0 0 0 0  
 Innenzehner: 28  
 weiteste: 305 (34), 291 (39), 272 (1)  
 beste Teiler 20.5 (19.) 38.3 (9.) 39.8 (8.)  
 Trefferlage 0.13 mm links, 0.14 mm tief  
 Streuwert 1.18, horizontal: 1.29, vertikal: 1.05

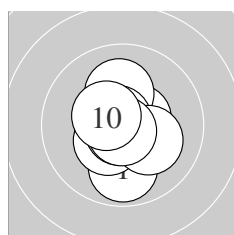
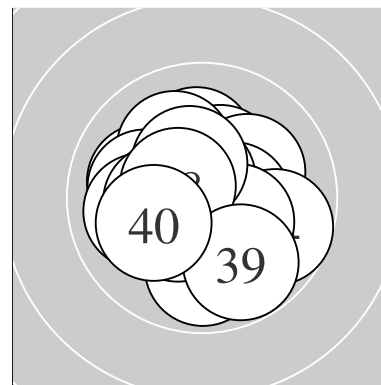

Serie 1:  
 9.9 ↓                      10.6 \*                      10.1 ↑                      10.6 \*                      10.4 \*  
 10.8 \*                      10.2 \*                      10.8 \*                      10.8 \*                      10.5 \*  
 beste Teiler 38.3 (9.) 39.8 (8.) 49.5 (6.)  
 Trefferlage 0.09 mm links, 0.24 mm tief  
 Streuwert 1.06, horizontal: 0.83, vertikal: 1.25

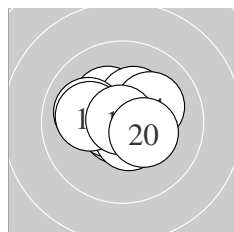

Serie 2:  
 10.3 \*                      10.3 \*                      10.0 ↖                      10.1 ↗                      10.7 \*  
 10.6 \*                      10.6 \*                      10.1 ↖                      10.9 \*                      10.3 \*  
 beste Teiler 20.5 (19.) 55.4 (15.) 83.0 (16.)  
 Trefferlage 0.23 mm links, 0.28 mm hoch  
 Streuwert 1.11, horizontal: 1.34, vertikal: 0.81

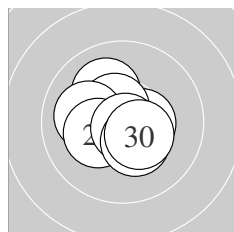

Serie 3:  
 10.5 \*                      10.5 \*                      10.5 \*                      10.1 ↖                      10.5 \*  
 10.1 ↖                      10.3 \*                      10.8 \*                      10.4 \*                      10.4 \*  
 beste Teiler 42.0 (28.) 104.3 (21.) 104.3 (25.)  
 Trefferlage 0.24 mm links, 0.12 mm tief  
 Streuwert 1.08, horizontal: 1.20, vertikal: 0.95

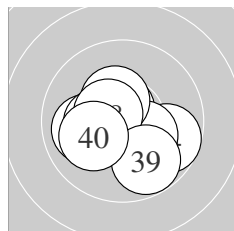

Serie 4:  
 9.9 ↘                      10.0 ←                      10.3 \*                      9.7 ↗                      10.7 \*  
 10.3 \*                      10.4 \*                      10.5 \*                      9.8 ↘                      10.1 ←  
 beste Teiler 75.9 (35.) 105.0 (38.) 140.8 (37.)  
 Trefferlage 0.03 mm rechts, 0.51 mm tief  
 Streuwert 1.51, horizontal: 1.81, vertikal: 1.14

Unterschrift des Schützen

Meyton Elektronik