

Ergebnis: **410.6** (393)
 Serien: 100.5 103.0 105.0 102.1
 Zähler: 33 7 0 0 0 0 0 0 0 0
 Innenzehner: 25
 weiteste: 410 (2), 380 (15), 360 (4)
 beste Teiler 12.3 (26.) 31.3 (39.) 42.1 (18.)
 Trefferlage 0.36 mm links, 0.01 mm hoch
 Streuwert 1.38, horizontal: 1.30, vertikal: 1.46

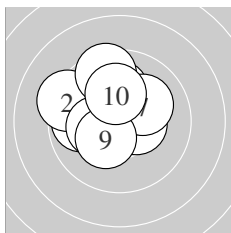

Serie 1:
 9.8 ← 9.3 ↖ 10.1 ↑ 9.5 ↑ 10.5 *
 10.5 * 10.1 ↗ 10.3 * 10.3 * 10.1 ↑
 beste Teiler 112.6 (5.) 125.7 (6.) 159.1 (9.)
 Trefferlage 0.68 mm links, 0.92 mm hoch
 Streuwert 1.60, horizontal: 1.76, vertikal: 1.43

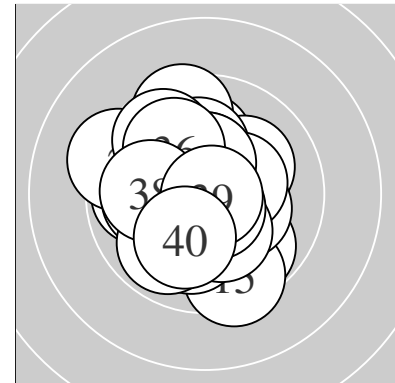
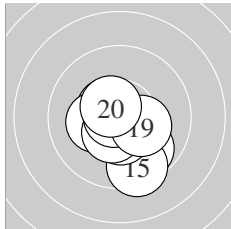

Serie 2:
 10.5 * 9.8 ↘ 10.3 * 10.5 * 9.4 ↓
 10.4 * 10.5 * 10.8 * 10.3 * 10.5 *
 beste Teiler 42.1 (18.) 101.5 (20.) 108.7 (11.)
 Trefferlage 0.08 mm rechts, 0.88 mm tief
 Streuwert 1.24, horizontal: 1.15, vertikal: 1.32

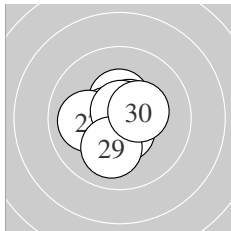

Serie 3:
 10.4 * 10.6 * 10.7 * 10.6 * 10.6 *
 10.9 * 10.0 ← 10.7 * 10.1 ↓ 10.4 *
 beste Teiler 12.3 (26.) 52.9 (28.) 64.6 (23.)
 Trefferlage 0.05 mm links, 0.04 mm tief
 Streuwert 0.99, horizontal: 1.02, vertikal: 0.96

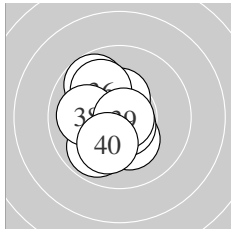

Serie 4:
 10.2 * 10.3 * 10.4 * 9.8 ↘ 10.6 *
 10.0 ↘ 9.9 ↙ 10.0 ← 10.8 * 10.1 ↙
 beste Teiler 31.3 (39.) 76.0 (35.) 135.0 (33.)
 Trefferlage 0.79 mm links, 0.05 mm hoch
 Streuwert 1.39, horizontal: 1.08, vertikal: 1.64

Unterschrift des Schützen

Meyton Elektronik

Ergebnis: **410.9** (394)
 Serien: 102.2 101.9 103.1 103.7
 Zähler: 34 6 0 0 0 0 0 0 0 0
 Innenzehner: 30
 weiteste: 342 (16), 313 (1), 297 (7)
 beste Teiler 78.1 (19.) 79.0 (31.) 90.8 (5.)
 Trefferlage 0.23 mm rechts, 0.02 mm hoch
 Streuwert 1.31, horizontal: 1.61, vertikal: 0.91

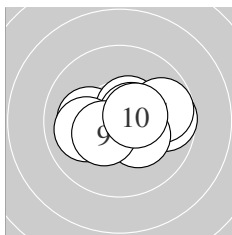
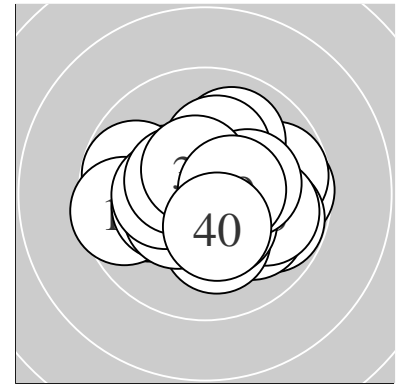

Serie 1:
 9.7 → 10.3 * 10.1 ← 10.5 * 10.6 *
 10.0 ← 9.8 → 10.3 * 10.4 * 10.5 *
 beste Teiler 90.8 (5.) 106.7 (4.) 114.8 (10.)
 Trefferlage 0.58 mm rechts, 0.07 mm hoch
 Streuwert 1.40, horizontal: 1.87, vertikal: 0.65

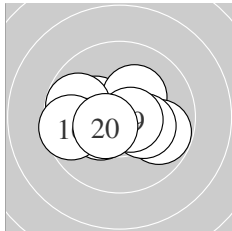

Serie 2:
 10.4 * 10.3 * 10.3 * 10.4 * 9.8 ←
 9.6 ← 9.8 → 10.2 * 10.6 * 10.5 *
 beste Teiler 78.1 (19.) 116.8 (20.) 139.0 (11.)
 Trefferlage 0.31 mm links, 0.00 mm
 Streuwert 1.55, horizontal: 2.01, vertikal: 0.88

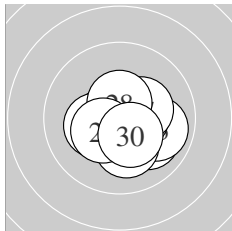

Serie 3:
 10.6 * 10.0 ↘ 9.9 → 10.3 * 10.5 *
 10.2 * 10.3 * 10.5 * 10.4 * 10.4 *
 beste Teiler 94.3 (21.) 106.0 (28.) 117.0 (25.)
 Trefferlage 0.46 mm rechts, 0.49 mm tief
 Streuwert 1.16, horizontal: 1.38, vertikal: 0.90

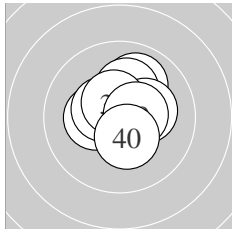

Serie 4:
 10.6 * 10.0 ↗ 10.3 * 10.5 * 10.5 *
 10.2 * 10.2 * 10.5 * 10.5 * 10.4 *
 beste Teiler 79.0 (31.) 109.0 (38.) 110.5 (34.)
 Trefferlage 0.20 mm rechts, 0.52 mm hoch
 Streuwert 1.07, horizontal: 1.12, vertikal: 1.00

Unterschrift des Schützen

Meyton Elektronik

Ergebnis: **407.4** (389)
 Serien: 102.2 101.0 101.4 102.8
 Zähler: 29 11 0 0 0 0 0 0 0 0
 Innenzehner: 22
 weiteste: 403 (17), 377 (27), 360 (29)
 beste Teiler 39.0 (14.) 54.1 (31.) 64.7 (1.)
 Trefferlage 0.57 mm rechts, 0.13 mm hoch
 Streuwert 1.46, horizontal: 1.45, vertikal: 1.47

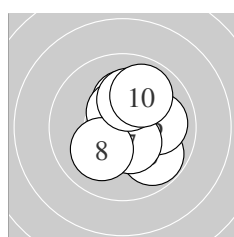
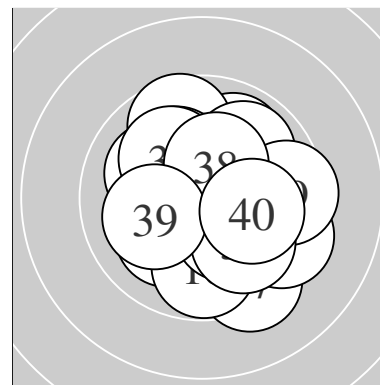

Serie 1:
 10.7 * 10.3 * 10.2 * 10.5 * 9.8 ↘
 10.0 → 10.5 * 10.1 ↗ 10.2 * 9.9 ↗
 beste Teiler 64.7 (1.) 111.6 (4.) 120.3 (7.)
 Trefferlage 0.69 mm rechts, 0.15 mm hoch
 Streuwert 1.37, horizontal: 1.16, vertikal: 1.56

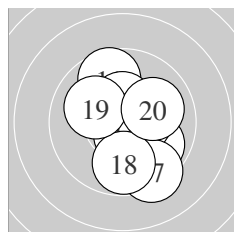

Serie 2:
 9.7 ↖ 10.4 * 9.9 ↘ 10.8 * 10.4 *
 10.6 * 9.3 ↘ 9.8 ↓ 10.1 ↖ 10.0 →
 beste Teiler 39.0 (14.) 90.6 (16.) 128.1 (15.)
 Trefferlage 0.51 mm rechts, 0.27 mm tief
 Streuwert 1.73, horizontal: 1.39, vertikal: 2.01

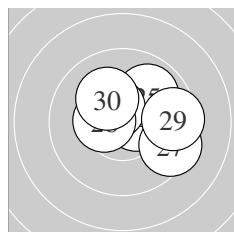

Serie 3:
 10.5 * 10.6 * 9.8 → 10.6 * 9.9 ↗
 10.5 * 9.4 ↘ 10.4 * 9.5 → 10.2 *
 beste Teiler 85.8 (22.) 98.4 (24.) 109.8 (21.)
 Trefferlage 0.89 mm rechts, 0.53 mm hoch
 Streuwert 1.53, horizontal: 1.92, vertikal: 1.00

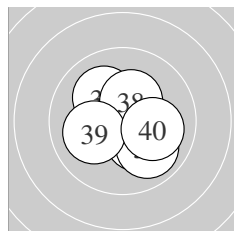

Serie 4:
 10.7 * 10.3 * 10.6 * 10.4 * 10.3 *
 9.9 ↘ 10.1 ↖ 10.3 * 10.1 ← 10.1 →
 beste Teiler 54.1 (31.) 89.1 (33.) 130.6 (34.)
 Trefferlage 0.18 mm rechts, 0.12 mm hoch
 Streuwert 1.31, horizontal: 1.37, vertikal: 1.26

Unterschrift des Schützen

Meyton Elektronik

Ergebnis: **409.5** (390)
 Serien: 101.5 103.5 102.5 102.0
 Zähler: 30 10 0 0 0 0 0 0 0 0
 Innenzehner: 26
 weiteste: 478 (21), 394 (40), 348 (2)
 beste Teiler 43.1 (29.) 48.5 (31.) 52.4 (14.)
 Trefferlage 0.32 mm links, 0.15 mm tief
 Streuwert 1.45, horizontal: 1.70, vertikal: 1.15

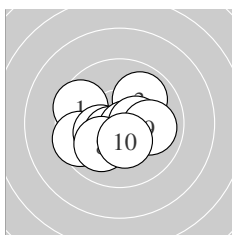
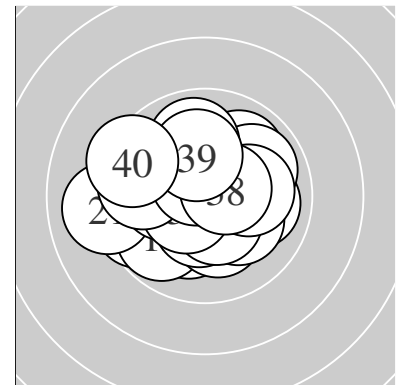

Serie 1:
 9.6 ↖ 9.6 ← 9.9 ↗ 10.3 * 10.5 *
 10.7 * 10.4 * 10.1 ↙ 10.0 → 10.4 *
 beste Teiler 67.0 (6.) 113.7 (5.) 132.0 (7.)
 Trefferlage 0.38 mm links, 0.36 mm tief
 Streuwert 1.62, horizontal: 1.97, vertikal: 1.17

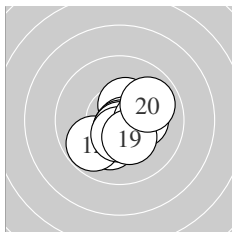

Serie 2:
 10.2 * 9.8 ↘ 10.4 * 10.7 * 10.7 *
 10.7 * 10.5 * 10.3 * 10.3 * 9.9 →
 beste Teiler 52.4 (14.) 61.3 (15.) 74.2 (16.)
 Trefferlage 0.28 mm rechts, 0.54 mm tief
 Streuwert 1.18, horizontal: 1.23, vertikal: 1.12

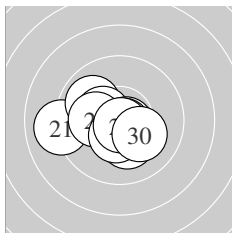

Serie 3:
 9.0 ← 9.9 ↖ 10.4 * 10.7 * 10.2 *
 10.7 * 10.2 * 10.4 * 10.8 * 10.2 *
 beste Teiler 43.1 (29.) 55.2 (26.) 62.6 (24.)
 Trefferlage 0.73 mm links, 0.39 mm tief
 Streuwert 1.46, horizontal: 1.86, vertikal: 0.90

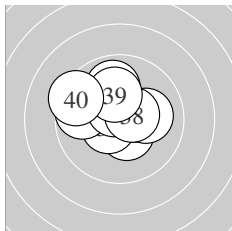

Serie 4:
 10.8 * 10.4 * 10.5 * 9.9 ↑ 9.7 ←
 10.6 * 10.1 → 10.5 * 10.1 ↑ 9.4 ↖
 beste Teiler 48.5 (31.) 90.8 (36.) 107.2 (38.)
 Trefferlage 0.47 mm links, 0.66 mm hoch
 Streuwert 1.47, horizontal: 1.74, vertikal: 1.14

Unterschrift des Schützen

Ergebnis: **387.0** (367)
 Serien: 99.3 97.0 99.6 91.1
 Zähler: 13 21 6 0 0 0 0 0 0 0
 Innenzehner: 8
 weiteste: 648 (34), 647 (20), 604 (35)
 beste Teiler 28.0 (25.) 72.0 (11.) 82.7 (29.)
 Trefferlage 0.74 mm links, 0.85 mm hoch
 Streuwert 2.43, horizontal: 2.92, vertikal: 1.80

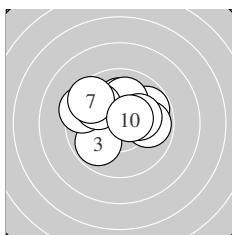
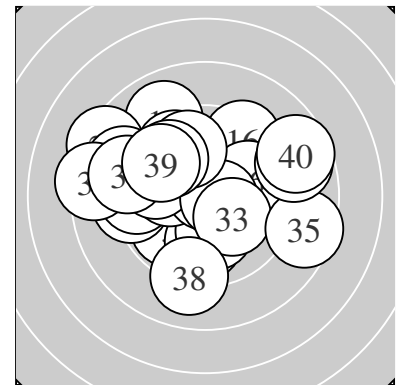

Serie 1:
 10.1 ↑ 9.8 ↗ 9.9 ↙ 10.1 ↑ 9.4 ↖
 9.9 ↘ 9.5 ↘ 9.9 → 10.2 * 10.5 *
 beste Teiler 110.4 (10.) 193.2 (9.) 213.0 (1.)
 Trefferlage 0.18 mm links, 0.99 mm hoch
 Streuwert 1.85, horizontal: 2.30, vertikal: 1.27

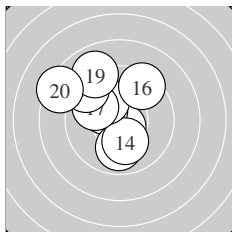

Serie 2:
 10.7 * 10.3 * 9.9 ↓ 10.1 ↓ 10.1 ↖
 9.4 ↗ 9.9 ↘ 9.2 ↘ 9.0 ↘ 8.4 ↖
 beste Teiler 72.0 (11.) 171.8 (12.) 210.0 (14.)
 Trefferlage 1.35 mm links, 1.22 mm hoch
 Streuwert 2.30, horizontal: 2.24, vertikal: 2.35

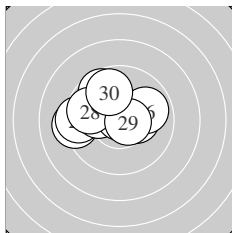

Serie 3:
 9.2 ← 10.3 * 9.4 ← 10.1 ← 10.8 *
 9.9 → 9.7 ↘ 9.8 ← 10.6 * 9.8 ↖
 beste Teiler 28.0 (25.) 82.7 (29.) 160.0 (22.)
 Trefferlage 1.09 mm links, 0.74 mm hoch
 Streuwert 1.81, horizontal: 2.30, vertikal: 1.12

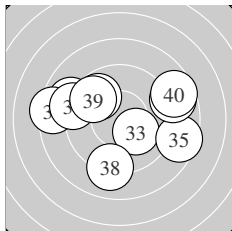

Serie 4:
 8.9 ↖ 9.8 ↘ 10.2 * 8.4 ← 8.5 →
 9.1 ← 8.8 → 9.1 ↓ 9.7 ↘ 8.6 →
 beste Teiler 198.2 (33.) 297.0 (32.) 318.6 (39.)
 Trefferlage 0.34 mm links, 0.45 mm hoch
 Streuwert 3.58, horizontal: 4.51, vertikal: 2.30

Unterschrift des Schützen

Meyton Elektronik

Ergebnis: **407.3** (392)
 Serien: 103.3 99.9 102.5 101.6
 Zähler: 32 8 0 0 0 0 0 0 0 0
 Innenzehner: 26
 weiteste: 472 (13), 364 (40), 328 (12)
 beste Teiler 11.1 (4.) 48.8 (1.) 70.4 (14.)
 Trefferlage 0.23 mm links, 0.22 mm tief
 Streuwert 1.50, horizontal: 1.80, vertikal: 1.12

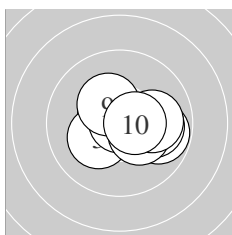
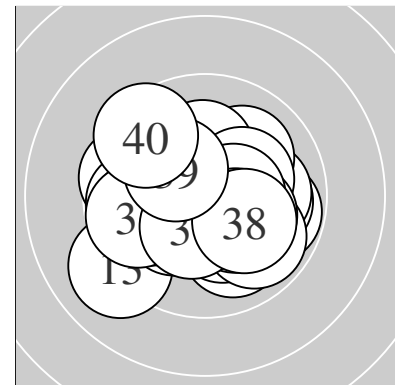

Serie 1:
 10.8 * 10.5 * 10.2 * 10.9 * 9.8 →
 10.0 → 10.3 * 10.0 → 10.3 * 10.5 *
 beste Teiler 11.1 (4.) 48.8 (1.) 110.0 (10.)
 Trefferlage 0.65 mm rechts, 0.05 mm tief
 Streuwert 1.21, horizontal: 1.55, vertikal: 0.72

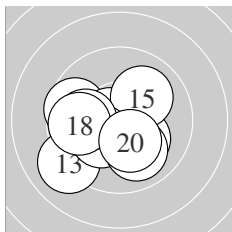

Serie 2:
 10.2 * 9.6 ← 9.1 ↙ 10.7 * 10.0 ↗
 10.2 * 10.0 ← 9.8 ← 10.0 ↘ 10.3 *
 beste Teiler 70.4 (14.) 167.2 (20.) 176.3 (16.)
 Trefferlage 0.92 mm links, 0.69 mm tief
 Streuwert 1.76, horizontal: 2.05, vertikal: 1.40

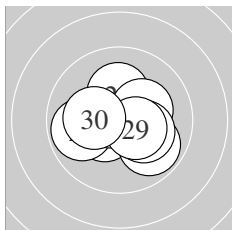

Serie 3:
 10.4 * 10.4 * 9.8 ← 10.7 * 10.2 *
 10.3 * 9.9 ↘ 10.2 * 10.4 * 10.2 *
 beste Teiler 73.3 (24.) 128.7 (29.) 129.2 (22.)
 Trefferlage 0.14 mm rechts, 0.09 mm tief
 Streuwert 1.37, horizontal: 1.65, vertikal: 1.02

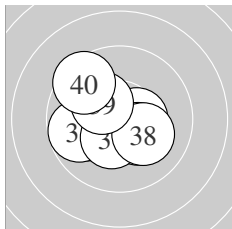

Serie 4:
 10.0 ← 10.4 * 10.2 * 10.5 * 9.8 ←
 10.3 * 10.4 * 10.2 * 10.3 * 9.5 ↘
 beste Teiler 122.0 (34.) 128.2 (32.) 143.7 (37.)
 Trefferlage 0.81 mm links, 0.03 mm tief
 Streuwert 1.49, horizontal: 1.68, vertikal: 1.26

Unterschrift des Schützen

Meyton Elektronik

Ergebnis: **407.7** (390)
 Serien: 101.0 102.3 101.5 102.9
 Zähler: 30 10 0 0 0 0 0 0 0 0
 Innenzehner: 27
 weiteste: 473 (24), 442 (27), 345 (10)
 beste Teiler 13.4 (38.) 39.4 (31.) 64.7 (30.)
 Trefferlage 0.24 mm links, 0.21 mm hoch
 Streuwert 1.52, horizontal: 1.80, vertikal: 1.18

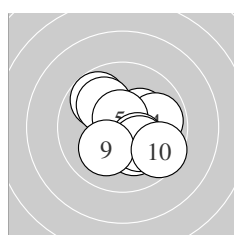
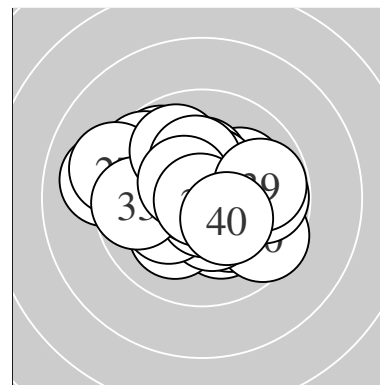

Serie 1:
 9.8 ↘ 10.0 ↘ 10.3 * 9.9 → 10.6 *
 10.3 * 10.2 * 10.2 * 10.1 ↙ 9.6 ↘
 beste Teiler 78.5 (5.) 161.4 (6.) 165.8 (3.)
 Trefferlage 0.54 mm rechts, 0.13 mm tief
 Streuwert 1.63, horizontal: 1.72, vertikal: 1.54

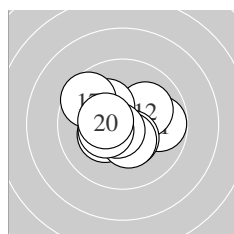

Serie 2:
 9.8 → 10.1 ↗ 10.2 * 10.3 * 10.4 *
 10.4 * 9.6 ↘ 10.7 * 10.4 * 10.4 *
 beste Teiler 66.6 (18.) 131.5 (15.) 137.9 (16.)
 Trefferlage 0.26 mm links, 0.05 mm hoch
 Streuwert 1.46, horizontal: 1.73, vertikal: 1.12

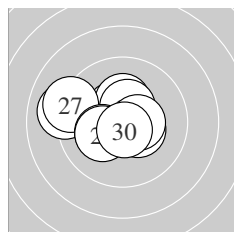

Serie 3:
 10.4 * 10.5 * 10.3 * 9.1 ← 10.4 *
 10.5 * 9.2 ← 10.2 * 10.2 * 10.7 *
 beste Teiler 64.7 (30.) 121.0 (26.) 123.7 (22.)
 Trefferlage 0.97 mm links, 0.31 mm hoch
 Streuwert 1.63, horizontal: 2.07, vertikal: 1.02

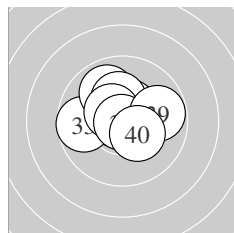

Serie 4:
 10.8 * 10.3 * 9.7 ← 10.5 * 9.9 ↘
 10.2 * 10.5 * 10.9 * 9.8 → 10.3 *
 beste Teiler 13.4 (38.) 39.4 (31.) 115.5 (37.)
 Trefferlage 0.28 mm links, 0.61 mm hoch
 Streuwert 1.32, horizontal: 1.59, vertikal: 0.98

Unterschrift des Schützen

Meyton Elektronik

Ergebnis: **409.0** (392)
 Serien: 101.1 101.1 102.0 104.8
 Zähler: 32 8 0 0 0 0 0 0 0 0
 Innenzehner: 25
 weiteste: 398 (17), 385 (5), 331 (19)
 beste Teiler 49.3 (35.) 58.3 (39.) 61.1 (13.)
 Trefferlage 0.07 mm links, 0.11 mm tief
 Streuwert 1.45, horizontal: 1.51, vertikal: 1.38

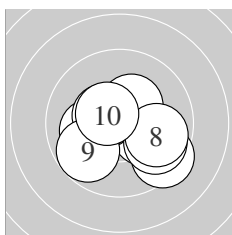
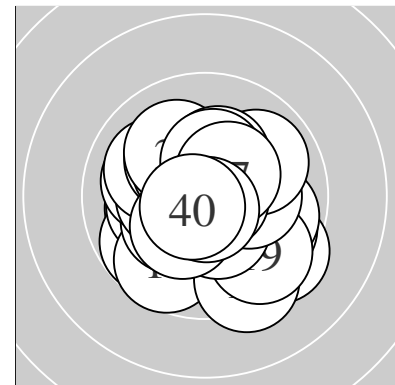

Serie 1:
 10.1 ← 10.2 * 10.5 * 10.4 * 9.4 ↘
 9.8 ↘ 10.5 * 9.9 → 9.8 ✓ 10.5 *
 beste Teiler 111.4 (10.) 111.8 (3.) 125.2 (7.)
 Trefferlage 0.34 mm rechts, 0.48 mm tief
 Streuwert 1.67, horizontal: 2.04, vertikal: 1.20

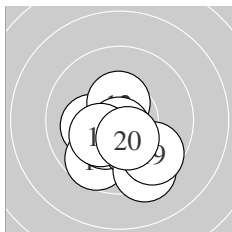

Serie 2:
 10.1 ← 10.5 * 10.7 * 9.7 ✓ 10.3 *
 10.1 ↘ 9.4 ↘ 10.3 * 9.6 ↘ 10.4 *
 beste Teiler 61.1 (13.) 123.2 (12.) 140.6 (20.)
 Trefferlage 0.03 mm links, 1.38 mm tief
 Streuwert 1.41, horizontal: 1.47, vertikal: 1.34

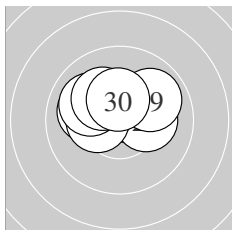

Serie 3:
 10.6 * 10.0 ↖ 10.0 ↖ 10.2 * 10.4 *
 10.3 * 10.0 ↖ 10.2 * 9.9 ↗ 10.4 *
 beste Teiler 100.2 (21.) 133.2 (25.) 146.4 (30.)
 Trefferlage 0.51 mm links, 0.88 mm hoch
 Streuwert 1.22, horizontal: 1.63, vertikal: 0.58

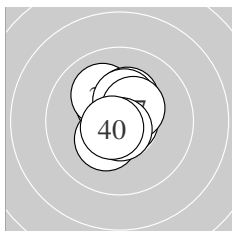

Serie 4:
 10.4 * 10.7 * 10.1 ↘ 10.3 * 10.8 *
 10.4 * 10.4 * 10.3 * 10.7 * 10.7 *
 beste Teiler 49.3 (35.) 58.3 (39.) 62.1 (32.)
 Trefferlage 0.11 mm links, 0.52 mm hoch
 Streuwert 0.92, horizontal: 0.74, vertikal: 1.07

Unterschrift des Schützen

Meyton Elektronik

Ergebnis: **401.9** (382)
 Serien: 101.1 103.8 99.2 97.8
 Zähler: 23 16 1 0 0 0 0 0 0 0
 Innenzehner: 16
 weiteste: 561 (31), 448 (26), 431 (34)
 beste Teiler 26.9 (37.) 36.1 (19.) 51.6 (12.)
 Trefferlage 0.28 mm links, 0.15 mm tief
 Streuwert 1.85, horizontal: 1.93, vertikal: 1.77

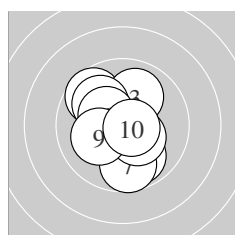
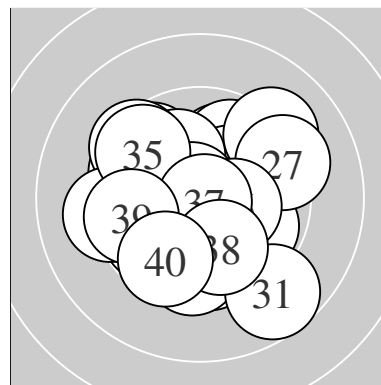

Serie 1:
 9.7 ↘ 9.9 ↘ 10.0 ↗ 10.0 ↘ 10.3 *
 10.4 * 9.7 ↓ 10.3 * 10.1 ← 10.7 *
 beste Teiler 73.0 (10.) 150.0 (6.) 151.4 (8.)
 Trefferlage 0.18 mm links, 0.18 mm tief
 Streuwert 1.67, horizontal: 1.41, vertikal: 1.89

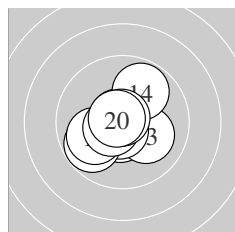

Serie 2:
 10.6 * 10.7 * 10.1 ↘ 9.8 ↗ 10.7 *
 9.8 ← 10.0 ← 10.6 * 10.8 * 10.7 *
 beste Teiler 36.1 (19.) 51.6 (12.) 53.8 (20.)
 Trefferlage 0.34 mm links, 0.24 mm tief
 Streuwert 1.25, horizontal: 1.33, vertikal: 1.16

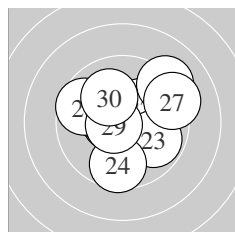

Serie 3:
 10.6 * 10.2 * 9.8 ↘ 9.6 ↓ 10.1 ↘
 9.2 ↗ 9.3 ↗ 9.6 ↘ 10.7 * 10.1 ↘
 beste Teiler 72.1 (29.) 94.0 (21.) 183.0 (22.)
 Trefferlage 0.30 mm rechts, 0.51 mm hoch
 Streuwert 2.09, horizontal: 2.33, vertikal: 1.81

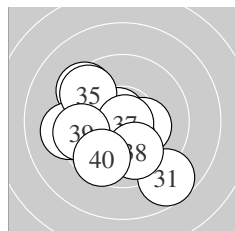

Serie 4:
 8.7 ↘ 10.7 * 9.4 ↘ 9.2 ← 9.6 ↘
 10.3 * 10.8 * 9.9 ↓ 9.6 ← 9.6 ↙
 beste Teiler 26.9 (37.) 55.8 (32.) 165.6 (36.)
 Trefferlage 0.90 mm links, 0.69 mm tief
 Streuwert 2.31, horizontal: 2.47, vertikal: 2.13

Unterschrift des Schützen

Ergebnis: **413.1** (397)
 Serien: 104.0 101.7 103.8 103.6
 Zähler: 37 3 0 0 0 0 0 0 0 0
 Innenzehner: 29
 weiteste: 304 (17), 277 (27), 265 (14)
 beste Teiler 38.8 (15.) 49.7 (36.) 50.0 (40.)
 Trefferlage 0.14 mm rechts, 0.07 mm hoch
 Streuwert 1.20, horizontal: 1.20, vertikal: 1.21

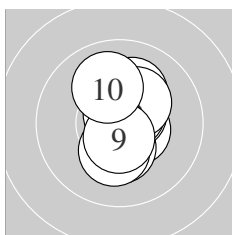
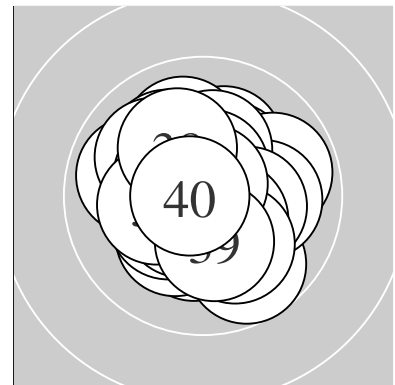

Serie 1:
 10.1 ↗ 10.5 * 10.3 * 10.3 * 10.6 *
 10.6 * 10.7 * 10.3 * 10.6 * 10.0 ↖
 beste Teiler 56.1 (7.) 90.0 (9.) 92.6 (6.)
 Trefferlage 0.29 mm rechts, 0.27 mm hoch
 Streuwert 1.06, horizontal: 0.61, vertikal: 1.37

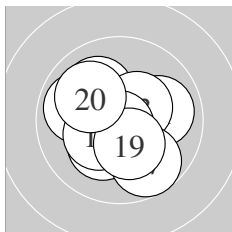

Serie 2:
 10.0 → 10.1 ↖ 10.4 * 9.9 ↖ 10.8 *
 10.2 * 9.7 ↘ 10.3 * 10.3 * 10.0 ↖
 beste Teiler 38.8 (15.) 135.0 (13.) 158.9 (18.)
 Trefferlage 0.24 mm links, 0.15 mm tief
 Streuwert 1.54, horizontal: 1.64, vertikal: 1.44

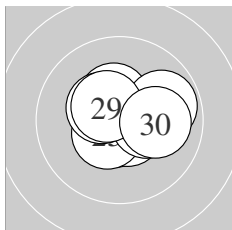

Serie 3:
 10.6 * 10.6 * 10.6 * 10.4 * 10.5 *
 10.3 * 9.8 → 10.4 * 10.5 * 10.1 →
 beste Teiler 79.2 (23.) 79.7 (21.) 82.8 (22.)
 Trefferlage 0.33 mm rechts, 0.20 mm hoch
 Streuwert 1.12, horizontal: 1.37, vertikal: 0.80

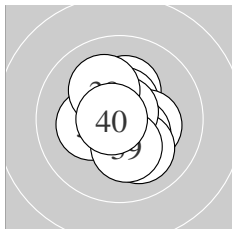

Serie 4:
 10.2 * 10.5 * 10.3 * 10.4 * 10.1 ↘
 10.8 * 10.2 * 10.1 ↖ 10.2 * 10.8 *
 beste Teiler 49.7 (36.) 50.0 (40.) 103.5 (32.)
 Trefferlage 0.18 mm rechts, 0.01 mm tief
 Streuwert 1.16, horizontal: 1.03, vertikal: 1.29

Unterschrift des Schützen

Ergebnis: **405.8** (387)
 Serien: 99.3 102.9 103.3 100.3
 Zähler: 27 13 0 0 0 0 0 0 0 0
 Innenzehner: 23
 weiteste: 417 (33), 393 (40), 370 (1)
 beste Teiler 26.9 (20.) 44.7 (36.) 66.2 (19.)
 Trefferlage 0.18 mm links, 0.12 mm hoch
 Streuwert 1.59, horizontal: 1.90, vertikal: 1.21

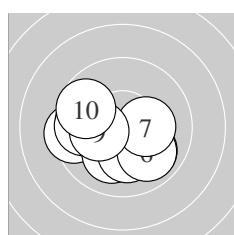
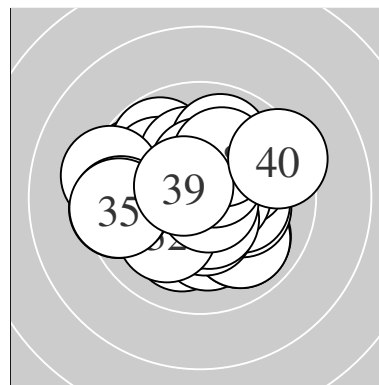

Serie 1:
 9.5 ← 9.9 ↘ 10.1 ↓ 9.8 ← 10.2 *
 9.9 ↘ 10.2 * 9.8 ← 10.2 * 9.7 ↖
 beste Teiler 176.0 (7.) 179.5 (9.) 197.1 (5.)
 Trefferlage 0.89 mm links, 0.62 mm tief
 Streuwert 1.76, horizontal: 2.19, vertikal: 1.19

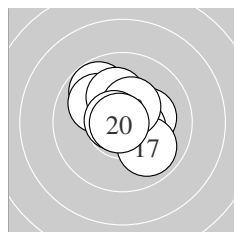

Serie 2:
 9.8 ↖ 10.0 ↖ 10.4 * 10.2 * 10.2 *
 10.5 * 9.9 ↘ 10.4 * 10.7 * 10.8 *
 beste Teiler 26.9 (20.) 66.2 (19.) 111.4 (16.)
 Trefferlage 0.14 mm rechts, 0.52 mm hoch
 Streuwert 1.30, horizontal: 1.38, vertikal: 1.21

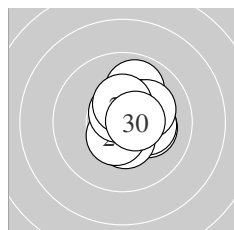

Serie 3:
 10.2 * 10.2 * 9.9 ↑ 10.3 * 10.4 *
 10.2 * 10.5 * 10.6 * 10.4 * 10.6 *
 beste Teiler 77.8 (28.) 96.3 (30.) 113.5 (27.)
 Trefferlage 0.78 mm rechts, 0.35 mm hoch
 Streuwert 1.03, horizontal: 0.90, vertikal: 1.15

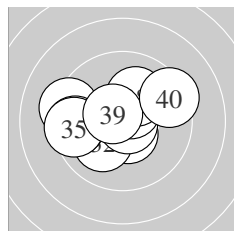

Serie 4:
 10.5 * 10.1 ↙ 9.3 ← 9.5 ← 9.5 ←
 10.8 * 10.5 * 10.1 ↑ 10.6 * 9.4 →
 beste Teiler 44.7 (36.) 91.6 (39.) 104.7 (31.)
 Trefferlage 0.75 mm links, 0.25 mm hoch
 Streuwert 1.91, horizontal: 2.44, vertikal: 1.15

Unterschrift des Schützen

Meyton Elektronik

Ergebnis: **407.9** (392)
 Serien: 100.7 101.9 103.6 101.7
 Zähler: 32 8 0 0 0 0 0 0 0 0
 Innenzehner: 27
 weiteste: 439 (4), 388 (8), 382 (14)
 beste Teiler 37.6 (16.) 44.3 (29.) 45.2 (1.)
 Trefferlage 0.30 mm links, 0.52 mm tief
 Streuwert 1.45, horizontal: 1.40, vertikal: 1.49

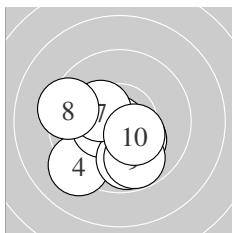
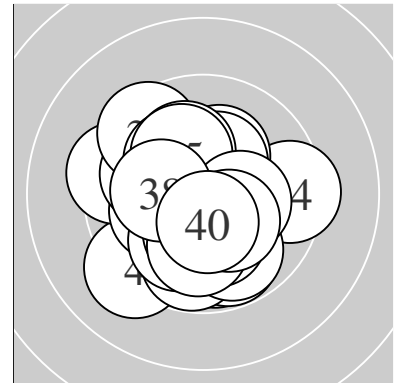

Serie 1:
 10.8 * 10.4 * 10.2 * 9.2 ✓ 10.4 *
 9.8 ↓ 10.3 * 9.4 ← 9.8 ↓ 10.4 *
 beste Teiler 45.2 (1.) 134.0 (5.) 139.1 (2.)
 Trefferlage 0.71 mm links, 1.06 mm tief
 Streuwert 1.60, horizontal: 1.75, vertikal: 1.44

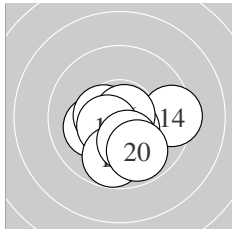

Serie 2:
 10.3 * 10.1 ← 10.5 * 9.4 → 10.5 *
 10.8 * 10.5 * 9.8 ↓ 10.2 * 9.8 ↓
 beste Teiler 37.6 (16.) 109.2 (17.) 113.4 (15.)
 Trefferlage 0.24 mm rechts, 1.06 mm tief
 Streuwert 1.36, horizontal: 1.58, vertikal: 1.09

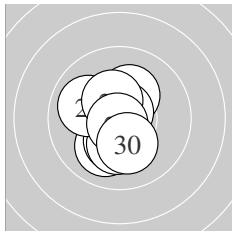

Serie 3:
 10.0 ✓ 10.2 * 10.8 * 10.7 * 10.3 *
 10.2 * 10.0 ← 10.4 * 10.8 * 10.2 *
 beste Teiler 44.3 (29.) 50.1 (23.) 58.0 (24.)
 Trefferlage 0.35 mm links, 0.39 mm tief
 Streuwert 1.17, horizontal: 0.86, vertikal: 1.42

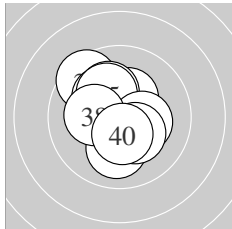

Serie 4:
 9.5 ✗ 10.4 * 10.1 ↗ 10.2 * 10.2 *
 10.0 ↓ 10.3 * 10.2 * 10.3 * 10.5 *
 beste Teiler 125.6 (40.) 150.8 (32.) 164.0 (39.)
 Trefferlage 0.39 mm links, 0.42 mm hoch
 Streuwert 1.48, horizontal: 1.30, vertikal: 1.63

Unterschrift des Schützen

Meyton Elektronik

Ergebnis: **409.6** (390)
 Serien: 101.7 103.7 101.5 102.7
 Zähler: 32 6 2 0 0 0 0 0 0 0
 Innenzehner: 32
 weiteste: 653 (6), 574 (29), 456 (34)
 beste Teiler 40.8 (40.) 49.5 (1.) 53.3 (13.)
 Trefferlage 0.19 mm rechts, 0.11 mm tief
 Streuwert 1.62, horizontal: 2.02, vertikal: 1.08

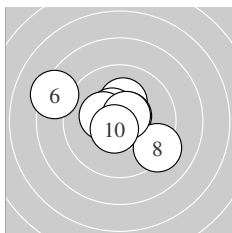
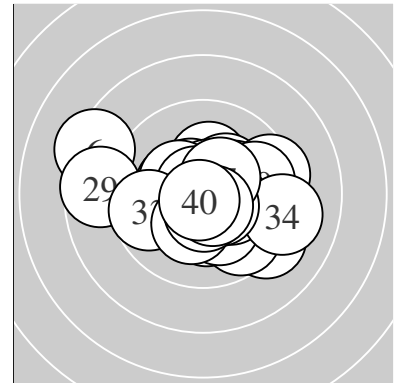

Serie 1:
 10.8 * 10.6 * 10.2 * 10.5 * 10.3 *
 8.3 ↖ 10.6 * 9.2 ↘ 10.6 * 10.6 *
 beste Teiler 49.5 (1.) 80.9 (9.) 87.0 (10.)
 Trefferlage 0.43 mm links, 0.38 mm hoch
 Streuwert 1.94, horizontal: 2.39, vertikal: 1.36

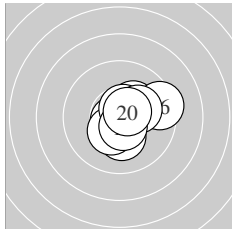

Serie 2:
 10.3 * 10.2 * 10.7 * 10.7 * 10.4 *
 9.4 → 10.6 * 10.2 * 10.6 * 10.6 *
 beste Teiler 53.3 (13.) 54.7 (14.) 86.1 (17.)
 Trefferlage 0.67 mm rechts, 0.04 mm tief
 Streuwert 1.18, horizontal: 1.31, vertikal: 1.04

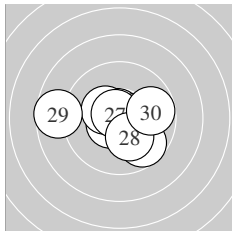

Serie 3:
 10.5 * 10.5 * 10.7 * 10.4 * 9.7 ↘
 10.3 * 10.7 * 10.2 * 8.7 ← 9.8 →
 beste Teiler 54.2 (23.) 57.2 (27.) 102.9 (22.)
 Trefferlage 0.02 mm links, 0.18 mm tief
 Streuwert 1.86, horizontal: 2.41, vertikal: 1.04

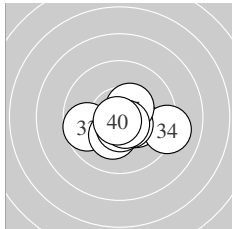

Serie 4:
 10.5 * 10.3 * 9.7 ← 9.1 → 10.5 *
 10.2 * 10.4 * 10.6 * 10.6 * 10.8 *
 beste Teiler 40.8 (40.) 85.2 (39.) 98.1 (38.)
 Trefferlage 0.55 mm rechts, 0.61 mm tief
 Streuwert 1.41, horizontal: 1.87, vertikal: 0.69

Unterschrift des Schützen

Meyton Elektronik

Ergebnis: **411.8** (396)
 Serien: 103.2 103.4 103.5 101.7
 Zähler: 36 4 0 0 0 0 0 0 0 0
 Innenzehner: 30
 weiteste: 337 (2), 332 (31), 316 (24)
 beste Teiler 36.6 (4.) 50.2 (28.) 54.0 (14.)
 Trefferlage 0.12 mm rechts, 0.01 mm hoch
 Streuwert 1.27, horizontal: 1.36, vertikal: 1.19

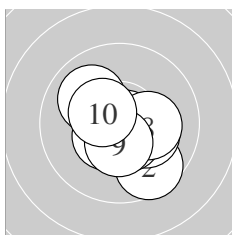
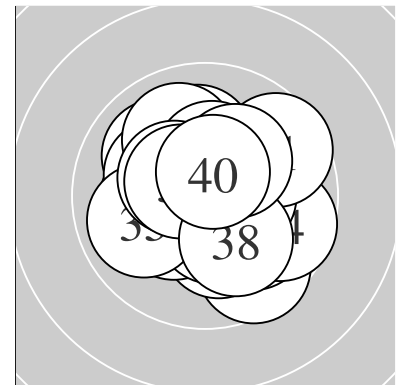

Serie 1:
 10.0 ↘ 9.6 ↘ 10.2 * 10.8 * 10.5 *
 10.6 * 10.5 * 10.2 * 10.4 * 10.4 *
 beste Teiler 36.6 (4.) 76.2 (6.) 107.9 (5.)
 Trefferlage 0.17 mm rechts, 0.44 mm tief
 Streuwert 1.26, horizontal: 1.34, vertikal: 1.18

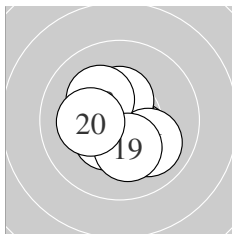

Serie 2:
 10.5 * 10.5 * 10.3 * 10.7 * 10.4 *
 10.0 ↘ 10.4 * 10.2 * 10.2 * 10.2 *
 beste Teiler 54.0 (14.) 103.2 (12.) 109.1 (11.)
 Trefferlage 0.21 mm links, 0.10 mm tief
 Streuwert 1.16, horizontal: 1.15, vertikal: 1.16

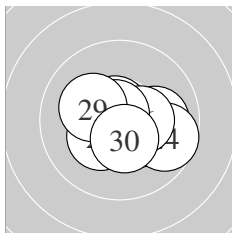

Serie 3:
 10.0 → 10.3 * 10.7 * 9.7 ↘ 10.7 *
 10.4 * 10.3 * 10.8 * 10.2 * 10.4 *
 beste Teiler 50.2 (28.) 72.9 (25.) 74.3 (23.)
 Trefferlage 0.54 mm rechts, 0.24 mm tief
 Streuwert 1.19, horizontal: 1.50, vertikal: 0.77

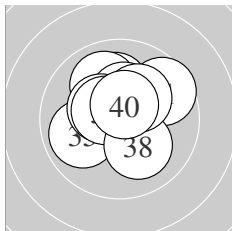

Serie 4:
 9.6 ↗ 10.1 ↑ 10.0 ↖ 10.3 * 9.9 ←
 10.4 * 10.5 * 10.1 ↘ 10.2 * 10.6 *
 beste Teiler 99.9 (40.) 109.9 (37.) 140.8 (36.)
 Trefferlage 0.01 mm links, 0.86 mm hoch
 Streuwert 1.40, horizontal: 1.50, vertikal: 1.30

Unterschrift des Schützen

Meyton Elektronik

Ergebnis: **413.7** (395)
 Serien: 105.1 102.6 102.9 103.1
 Zähler: 35 5 0 0 0 0 0 0 0 0
 Innenzehner: 27
 weiteste: 467 (23), 335 (28), 325 (12)
 beste Teiler 12.5 (10.) 14.0 (6.) 35.6 (11.)
 Trefferlage 0.48 mm links, 0.00 mm
 Streuwert 1.27, horizontal: 1.49, vertikal: 0.99

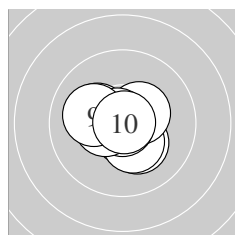
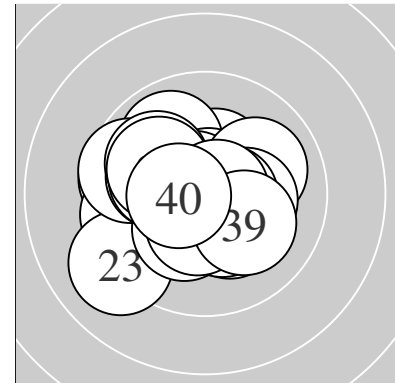

Serie 1:
 10.3 * 10.7 * 10.3 * 10.4 * 10.2 *
 10.9 * 10.8 * 10.5 * 10.1 ↖ 10.9 *
 beste Teiler 12.5 (10.) 14.0 (6.) 47.4 (7.)
 Trefferlage 0.22 mm links, 0.14 mm tief
 Streuwert 0.97, horizontal: 1.14, vertikal: 0.77

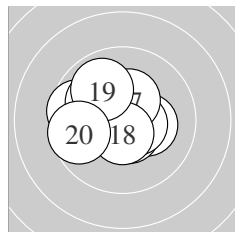

Serie 2:
 10.8 * 9.7 ↖ 10.3 * 10.6 * 10.6 *
 10.0 ↘ 10.4 * 10.6 * 9.9 ↘ 9.7 ↖
 beste Teiler 35.6 (11.) 94.0 (18.) 96.1 (14.)
 Trefferlage 0.64 mm links, 0.23 mm hoch
 Streuwert 1.43, horizontal: 1.69, vertikal: 1.10

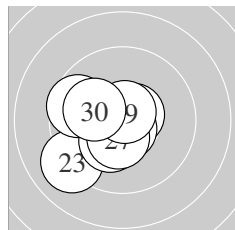

Serie 3:
 10.7 * 10.7 * 9.1 ↙ 10.3 * 10.6 *
 10.7 * 10.4 * 9.6 ↖ 10.7 * 10.1 ↖
 beste Teiler 59.9 (29.) 64.2 (21.) 66.0 (22.)
 Trefferlage 1.00 mm links, 0.41 mm tief
 Streuwert 1.36, horizontal: 1.47, vertikal: 1.23

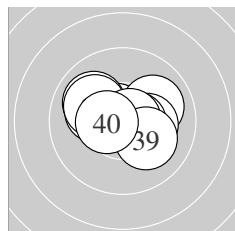

Serie 4:
 10.7 * 10.1 ↖ 10.0 ↘ 10.1 ↘ 10.0 ↗
 10.3 * 10.6 * 10.7 * 10.1 ↘ 10.5 *
 beste Teiler 51.6 (38.) 67.2 (31.) 91.0 (37.)
 Trefferlage 0.06 mm links, 0.29 mm hoch
 Streuwert 1.29, horizontal: 1.66, vertikal: 0.78

Unterschrift des Schützen

Meyton Elektronik

Ergebnis: **416.2** (396)
 Serien: 103.1 103.9 103.9 105.3
 Zähler: 36 4 0 0 0 0 0 0 0 0
 Innenzehner: 35
 weiteste: 310 (23), 295 (15), 259 (2)
 beste Teiler 8.5 (12.) 41.7 (26.) 44.9 (38.)
 Trefferlage 0.18 mm rechts, 0.46 mm tief
 Streuwert 1.06, horizontal: 1.09, vertikal: 1.03

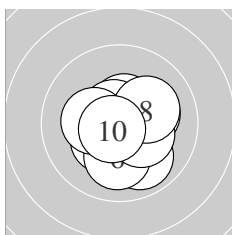
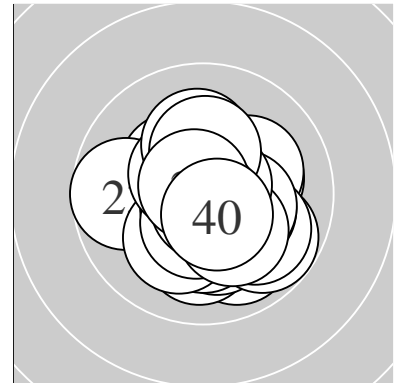

Serie 1:
 10.5 * 9.9 ↘ 10.6 * 10.3 * 10.2 *
 10.1 ↓ 10.3 * 10.2 * 10.3 * 10.7 *
 beste Teiler 64.8 (10.) 77.0 (3.) 110.1 (1.)
 Trefferlage 0.29 mm rechts, 0.32 mm tief
 Streuwert 1.24, horizontal: 1.25, vertikal: 1.22

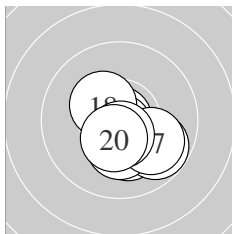

Serie 2:
 10.7 * 10.9 * 10.8 * 10.2 * 9.8 ↘
 10.3 * 9.9 ↘ 10.3 * 10.6 * 10.4 *
 beste Teiler 8.5 (12.) 48.2 (13.) 75.6 (11.)
 Trefferlage 0.38 mm rechts, 0.89 mm tief
 Streuwert 1.00, horizontal: 1.08, vertikal: 0.90

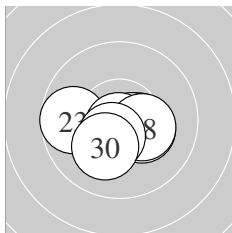

Serie 3:
 10.4 * 10.4 * 9.7 ← 10.7 * 10.6 *
 10.8 * 10.3 * 10.3 * 10.5 * 10.2 *
 beste Teiler 41.7 (26.) 62.2 (24.) 88.1 (25.)
 Trefferlage 0.00 mm , 0.69 mm tief
 Streuwert 1.06, horizontal: 1.41, vertikal: 0.51

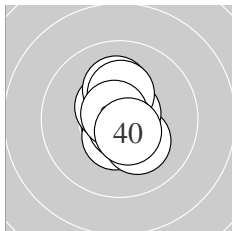

Serie 4:
 10.7 * 10.5 * 10.5 * 10.2 * 10.7 *
 10.2 * 10.3 * 10.8 * 10.8 * 10.6 *
 beste Teiler 44.9 (38.) 50.2 (39.) 62.6 (31.)
 Trefferlage 0.05 mm rechts, 0.07 mm hoch
 Streuwert 0.92, horizontal: 0.57, vertikal: 1.17

Unterschrift des Schützen

Meyton Elektronik

Ergebnis: **397.7** (381)

Serien: 101.4 98.9 96.8 100.6

Zähler: 22 17 1 0 0 0 0 0 0 0

Innenzehner: 14

weiteste: 574 (24), 485 (30), 446 (7)

beste Teiler 81.8 (5.) 83.0 (32.) 83.8 (10.)

Trefferlage 0.50 mm links, 1.43 mm hoch

Streuwert 1.68, horizontal: 2.05, vertikal: 1.21

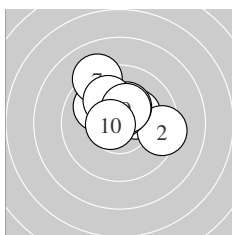
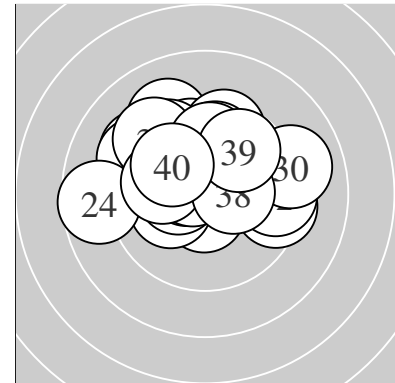

Serie 1:

10.3 *	9.4 →	10.3 *	10.0 ↘	10.6 *
10.6 *	9.2 ↘	10.0 ↘	10.4 *	10.6 *

beste Teiler 81.8 (5.) 83.8 (10.) 98.4 (6.)

Trefferlage 0.03 mm rechts, 1.20 mm hoch

Streuwert 1.52, horizontal: 1.74, vertikal: 1.27

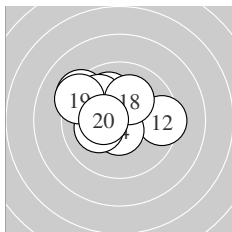

Serie 2:

9.7 ↘	9.4 →	10.0 ↘	10.6 *	9.3 ↘
9.9 ↘	10.2 *	10.1 ↑	9.3 ↘	10.4 *

beste Teiler 92.1 (14.) 145.0 (20.) 198.3 (17.)

Trefferlage 1.10 mm links, 1.02 mm hoch

Streuwert 1.81, horizontal: 2.22, vertikal: 1.27

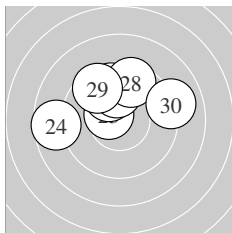

Serie 3:

9.9 ↘	9.9 ↘	10.5 *	8.7 ←	10.0 ↘
9.7 ↑	10.0 ↑	9.5 ↑	9.6 ↘	9.0 →

beste Teiler 109.5 (23.) 231.8 (25.) 246.4 (27.)

Trefferlage 0.76 mm links, 1.97 mm hoch

Streuwert 2.00, horizontal: 2.57, vertikal: 1.17

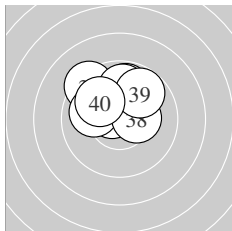

Serie 4:

10.6 *	10.6 *	9.3 ↘	9.8 ↑	9.9 ↑
10.3 *	10.0 ←	10.3 *	9.8 ↗	10.0 ↘

beste Teiler 83.0 (32.) 89.4 (31.) 153.2 (38.)

Trefferlage 0.17 mm links, 1.54 mm hoch

Streuwert 1.38, horizontal: 1.63, vertikal: 1.07

Unterschrift des Schützen

Meyton Elektronik

Ergebnis: **408.1** (391)
 Serien: 101.7 100.2 102.3 103.9
 Zähler: 31 9 0 0 0 0 0 0 0 0
 Innenzehner: 27
 weiteste: 493 (8), 398 (14), 396 (15)
 beste Teiler 44.7 (1.) 62.1 (29.) 76.9 (10.)
 Trefferlage 0.13 mm rechts, 0.38 mm tief
 Streuwert 1.51, horizontal: 1.80, vertikal: 1.15

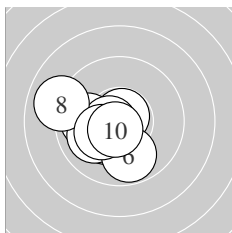
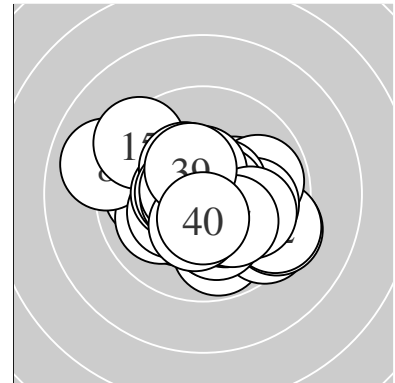

Serie 1:
 10.8 * 9.9 ← 10.4 * 10.3 * 10.0 ↙
 9.8 ↓ 10.6 * 9.0 ← 10.3 * 10.6 *
 beste Teiler 44.7 (1.) 76.9 (10.) 85.1 (7.)
 Trefferlage 1.25 mm links, 0.62 mm tief
 Streuwert 1.37, horizontal: 1.57, vertikal: 1.13

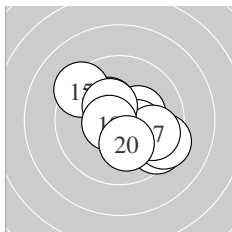

Serie 2:
 10.3 * 9.5 ↘ 10.3 * 9.4 ↘ 9.4 ↘
 10.3 * 9.8 ↘ 10.4 * 10.6 * 10.2 *
 beste Teiler 86.1 (19.) 138.4 (18.) 151.5 (16.)
 Trefferlage 0.71 mm rechts, 0.21 mm tief
 Streuwert 1.85, horizontal: 2.12, vertikal: 1.54

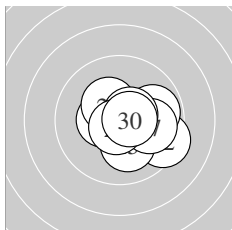

Serie 3:
 10.4 * 9.4 ↘ 10.3 * 9.9 → 10.1 ↓
 10.3 * 10.0 → 10.6 * 10.7 * 10.6 *
 beste Teiler 62.1 (29.) 81.3 (30.) 96.6 (28.)
 Trefferlage 1.00 mm rechts, 0.28 mm tief
 Streuwert 1.31, horizontal: 1.56, vertikal: 0.98

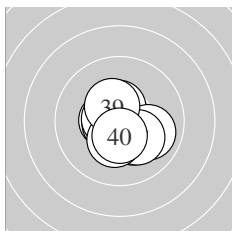

Serie 4:
 10.5 * 10.5 * 10.6 * 10.0 ↘ 10.3 *
 10.6 * 10.2 * 10.3 * 10.4 * 10.5 *
 beste Teiler 84.1 (33.) 87.8 (36.) 108.1 (31.)
 Trefferlage 0.09 mm rechts, 0.39 mm tief
 Streuwert 1.08, horizontal: 1.14, vertikal: 1.01

Unterschrift des Schützen

Meyton Elektronik

Ergebnis: **405.0** (384)
 Serien: 101.5 101.1 100.3 102.1
 Zähler: 24 16 0 0 0 0 0 0 0 0
 Innenzehner: 20
 weiteste: 412 (30), 371 (18), 367 (9)
 beste Teiler 64.1 (33.) 68.0 (15.) 73.3 (28.)
 Trefferlage 0.25 mm links, 0.35 mm hoch
 Streuwert 1.64, horizontal: 1.86, vertikal: 1.38

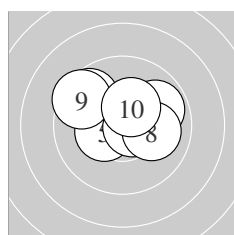
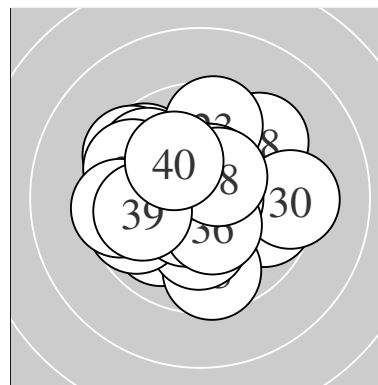

Serie 1:
 10.5 * 9.9 ↗ 10.5 * 9.7 ↘ 10.4 *
 9.9 ↗ 10.7 * 10.1 → 9.5 ↘ 10.3 *
 beste Teiler 75.7 (7.) 104.1 (1.) 111.8 (3.)
 Trefferlage 0.02 mm rechts, 0.80 mm hoch
 Streuwert 1.56, horizontal: 2.01, vertikal: 0.93

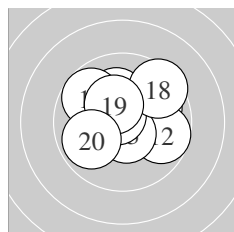

Serie 2:
 9.9 ↗ 9.7 → 10.6 * 10.5 * 10.7 *
 10.2 * 9.7 ↘ 9.5 ↗ 10.4 * 9.9 ↙
 beste Teiler 68.0 (15.) 92.0 (13.) 123.4 (14.)
 Trefferlage 0.11 mm rechts, 0.71 mm hoch
 Streuwert 1.66, horizontal: 1.93, vertikal: 1.33

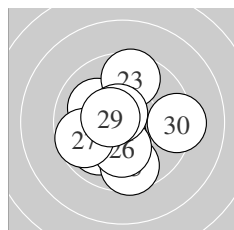

Serie 3:
 10.0 ↙ 10.1 ↘ 9.6 ↑ 10.5 * 9.6 ↓
 10.2 * 9.7 ↙ 10.7 * 10.6 * 9.3 →
 beste Teiler 73.3 (28.) 100.0 (29.) 106.9 (24.)
 Trefferlage 0.31 mm links, 0.38 mm tief
 Streuwert 1.89, horizontal: 1.92, vertikal: 1.87

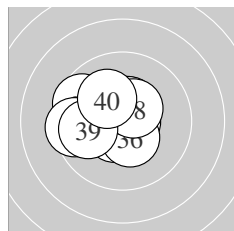

Serie 4:
 10.5 * 9.6 ↘ 10.7 * 9.5 ← 10.5 *
 10.4 * 10.5 * 10.4 * 9.9 ← 10.1 ↘
 beste Teiler 64.1 (33.) 107.8 (31.) 118.6 (35.)
 Trefferlage 0.83 mm links, 0.30 mm hoch
 Streuwert 1.42, horizontal: 1.70, vertikal: 1.06

Unterschrift des Schützen

Meyton Elektronik

Ergebnis: **402.2** (388)
 Serien: 99.2 101.0 102.3 99.7
 Zähler: 28 12 0 0 0 0 0 0 0 0
 Innenzehner: 20
 weiteste: 487 (5), 464 (8), 438 (12)
 beste Teiler 35.5 (16.) 50.2 (29.) 71.7 (30.)
 Trefferlage 0.36 mm links, 0.78 mm hoch
 Streuwert 1.65, horizontal: 1.96, vertikal: 1.27

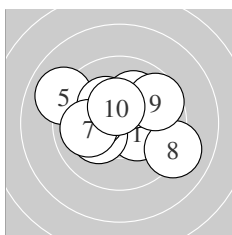
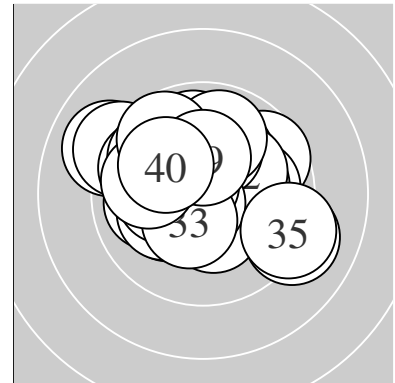

Serie 1:
 10.3 * 10.1 ↗ 10.2 * 10.2 * 9.0 ↘
 10.2 * 10.0 ← 9.1 ↘ 9.7 ↗ 10.4 *
 beste Teiler 131.7 (10.) 154.7 (1.) 178.2 (6.)
 Trefferlage 0.22 mm links, 0.46 mm hoch
 Streuwert 2.09, horizontal: 2.59, vertikal: 1.41

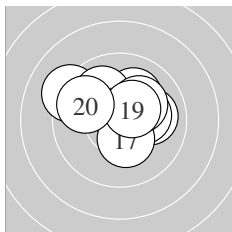

Serie 2:
 10.0 → 9.2 ↖ 10.1 ↗ 10.0 ↘ 10.2 *
 10.8 * 10.3 * 10.2 * 10.4 * 9.8 ↘
 beste Teiler 35.5 (16.) 130.2 (19.) 154.0 (17.)
 Trefferlage 0.06 mm rechts, 0.85 mm hoch
 Streuwert 1.63, horizontal: 2.04, vertikal: 1.09

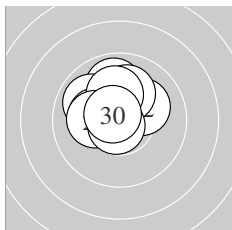

Serie 3:
 9.9 ↑ 10.2 * 9.9 ↖ 10.2 * 10.2 *
 10.1 ↗ 10.1 ↑ 10.2 * 10.8 * 10.7 *
 beste Teiler 50.2 (29.) 71.7 (30.) 181.6 (25.)
 Trefferlage 0.50 mm links, 1.14 mm hoch
 Streuwert 1.12, horizontal: 1.21, vertikal: 1.01

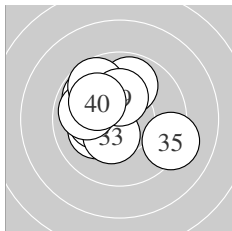

Serie 4:
 10.2 * 10.2 * 10.4 * 9.8 ↖ 9.2 ↘
 9.9 ← 9.9 ↑ 9.7 ↘ 10.3 * 10.1 ↘
 beste Teiler 140.4 (33.) 170.0 (39.) 181.2 (32.)
 Trefferlage 0.78 mm links, 0.66 mm hoch
 Streuwert 1.79, horizontal: 1.98, vertikal: 1.57

Unterschrift des Schützen

Meyton Elektronik

Ergebnis: **403.4** (384)
 Serien: 102.7 97.8 103.5 99.4
 Zähler: 26 12 2 0 0 0 0 0 0 0
 Innenzehner: 22
 weiteste: 631 (37), 620 (19), 450 (18)
 beste Teiler 39.2 (13.) 60.0 (39.) 60.2 (32.)
 Trefferlage 0.57 mm rechts, 0.41 mm tief
 Streuwert 1.83, horizontal: 2.23, vertikal: 1.31

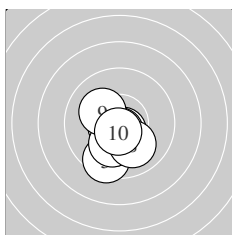
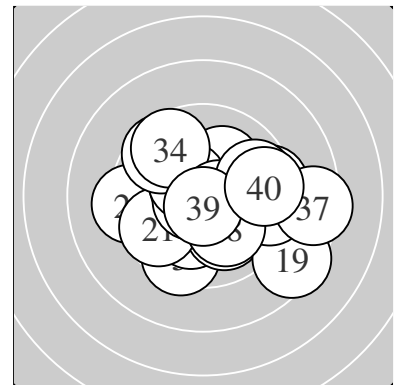

Serie 1:
 10.6 * 10.6 * 10.3 * 10.6 * 9.5 ↘
 10.2 * 10.1 ↘ 10.0 ↘ 10.2 * 10.6 *
 beste Teiler 77.0 (4.) 77.6 (2.) 81.2 (10.)
 Trefferlage 0.40 mm links, 1.21 mm tief
 Streuwert 1.03, horizontal: 0.81, vertikal: 1.21

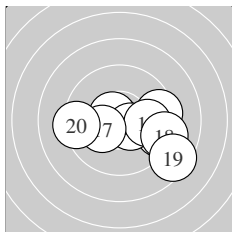

Serie 2:
 9.4 → 9.4 → 10.8 * 10.6 * 10.5 *
 9.9 → 10.2 * 9.2 → 8.5 ↘ 9.3 ←
 beste Teiler 39.2 (13.) 81.8 (14.) 120.2 (15.)
 Trefferlage 1.37 mm rechts, 0.72 mm tief
 Streuwert 2.30, horizontal: 3.02, vertikal: 1.21

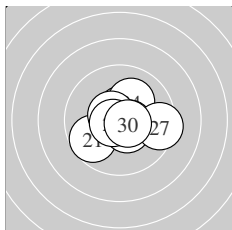

Serie 3:
 9.7 ↙ 10.6 * 10.7 * 10.1 ↗ 10.6 *
 10.5 * 9.4 → 10.6 * 10.7 * 10.6 *
 beste Teiler 60.4 (23.) 68.5 (29.) 84.6 (30.)
 Trefferlage 0.29 mm rechts, 0.11 mm tief
 Streuwert 1.36, horizontal: 1.65, vertikal: 0.98

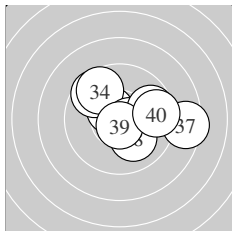

Serie 4:
 10.5 * 10.7 * 9.6 ↘ 9.6 ↘ 10.6 *
 9.7 → 8.4 → 10.1 ↘ 10.7 * 9.5 →
 beste Teiler 60.0 (39.) 60.2 (32.) 94.3 (35.)
 Trefferlage 1.02 mm rechts, 0.39 mm hoch
 Streuwert 2.11, horizontal: 2.64, vertikal: 1.40

Unterschrift des Schützen

Ergebnis: **404.7** (389)
 Serien: 100.6 102.0 101.8 100.3
 Zähler: 30 9 1 0 0 0 0 0 0 0
 Innenzehner: 19
 weiteste: 602 (37), 478 (23), 305 (1)
 beste Teiler 20.1 (25.) 38.9 (27.) 84.1 (35.)
 Trefferlage 0.00 mm , 0.00 mm
 Streuwert 1.66, horizontal: 1.94, vertikal: 1.33

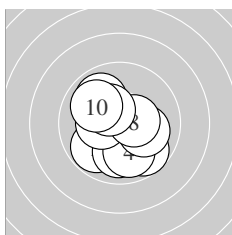
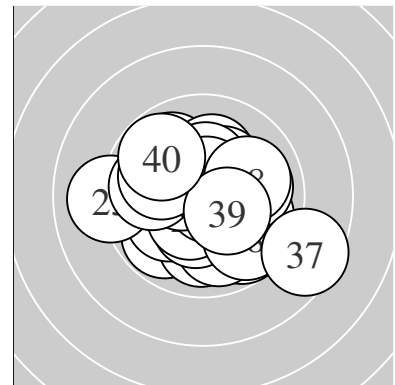

Serie 1:
 9.7 ↘ 9.8 ↙ 10.0 ↓ 9.9 ↘ 9.9 ↖
 10.1 → 10.3 * 10.5 * 10.4 * 10.0 ↖
 beste Teiler 125.6 (8.) 144.6 (9.) 155.0 (7.)
 Trefferlage 0.19 mm links, 0.49 mm tief
 Streuwert 1.68, horizontal: 1.63, vertikal: 1.73

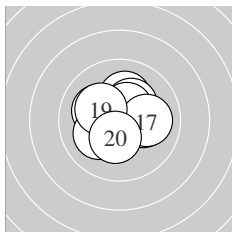

Serie 2:
 10.1 → 10.3 * 10.1 ↖ 10.1 ↑ 10.3 *
 10.5 * 10.0 → 10.1 ↙ 10.2 * 10.3 *
 beste Teiler 117.1 (16.) 152.8 (20.) 159.5 (12.)
 Trefferlage 0.08 mm links, 0.35 mm hoch
 Streuwert 1.36, horizontal: 1.59, vertikal: 1.08

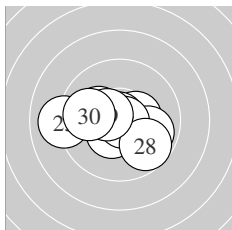

Serie 3:
 10.4 * 9.9 → 9.0 ← 10.2 * 10.9 *
 10.5 * 10.8 * 9.7 ↘ 10.5 * 9.9 ←
 beste Teiler 20.1 (25.) 38.9 (27.) 117.3 (29.)
 Trefferlage 0.46 mm links, 0.25 mm tief
 Streuwert 1.71, horizontal: 2.25, vertikal: 0.88

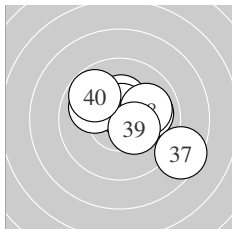

Serie 4:
 10.2 * 10.5 * 10.0 → 10.3 * 10.6 *
 10.0 ↖ 8.5 ↘ 10.0 → 10.4 * 9.8 ↖
 beste Teiler 84.1 (35.) 121.1 (32.) 147.3 (39.)
 Trefferlage 0.72 mm rechts, 0.43 mm hoch
 Streuwert 1.90, horizontal: 2.29, vertikal: 1.42

Unterschrift des Schützen