

Ergebnis: **406.2** (385)
 Serien: 98.9 104.7 102.6 100.0
 Zaehler: 25 15 0 0 0 0 0 0 0 0
 Innenzehner: 21
 weiteste: 401 (29), 397 (5), 391 (36)
 beste Teiler 22.4 (16.) 23.0 (12.) 32.5 (19.)
 Trefferlage 0.49 mm links, 0.19 mm hoch
 Streuwert 1.59, horizontal: 1.97, vertikal: 1.08

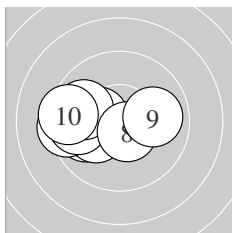

Serie 1:
 9.7 ← 9.9 ← 10.3 * 10.2 * 9.4 ←
 9.7 ← 9.8 ↖ 10.6 * 9.9 → 9.4 ←
 beste Teiler 97.4 (8.) 163.1 (3.) 197.6 (4.)
 Trefferlage 1.94 mm links, 0.15 mm tief
 Streuwert 1.50, horizontal: 2.03, vertikal: 0.61

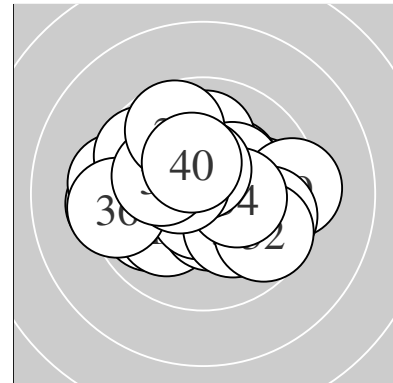
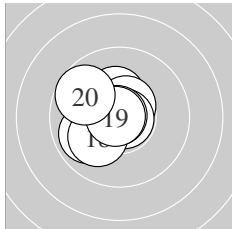

Serie 2:
 10.3 * 10.9 * 10.7 * 10.6 * 10.8 *
 10.9 * 9.9 ← 10.1 ↗ 10.8 * 9.7 ↘
 beste Teiler 22.4 (16.) 23.0 (12.) 32.5 (19.)
 Trefferlage 0.68 mm links, 0.12 mm hoch
 Streuwert 1.07, horizontal: 1.11, vertikal: 1.03

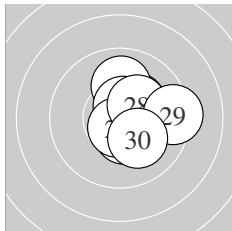

Serie 3:
 10.3 * 10.5 * 10.0 ↑ 10.5 * 10.3 *
 10.6 * 10.7 * 10.3 * 9.3 → 10.1 ↘
 beste Teiler 71.5 (27.) 92.7 (26.) 115.6 (22.)
 Trefferlage 1.05 mm rechts, 0.31 mm hoch
 Streuwert 1.20, horizontal: 1.20, vertikal: 1.21

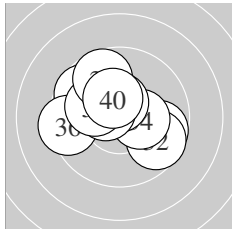

Serie 4:
 9.7 → 9.7 ↘ 9.7 ↘ 10.3 * 10.5 *
 9.4 ← 10.5 * 10.1 ↖ 9.7 ↗ 10.4 *
 beste Teiler 110.2 (35.) 114.1 (37.) 149.9 (40.)
 Trefferlage 0.41 mm links, 0.48 mm hoch
 Streuwert 1.86, horizontal: 2.24, vertikal: 1.38

Unterschrift des Schuetzen

Meyton Elektronik

Ergebnis: **416.8** (397)
 Serien: 104.9 104.1 104.3 103.5
 Zaehler: 37 3 0 0 0 0 0 0 0 0
 Innenzehner: 35
 weiteste: 286 (35), 283 (23), 272 (29)
 beste Teiler 25.0 (9.) 28.4 (30.) 29.5 (32.)
 Trefferlage 0.04 mm rechts, 0.11 mm tief
 Streuwert 1.07, horizontal: 1.08, vertikal: 1.05

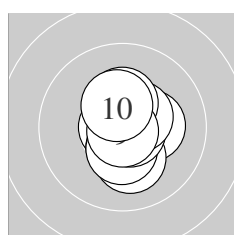
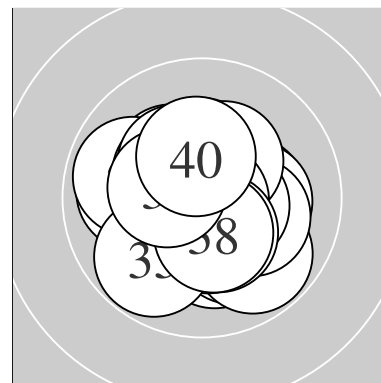

Serie 1:
 10.3 * 10.7 * 10.2 * 10.5 * 10.4 *
 10.7 * 10.5 * 10.3 * 10.9 * 10.4 *
 beste Teiler 25.0 (9.) 52.0 (2.) 52.3 (6.)
 Trefferlage 0.25 mm rechts, 0.13 mm tief
 Streuwert 0.92, horizontal: 0.66, vertikal: 1.13

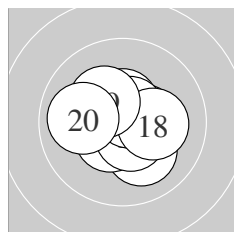

Serie 2:
 10.8 * 10.1 ↘ 10.5 * 10.5 * 10.6 *
 10.5 * 10.6 * 10.2 * 10.3 * 10.0 ←
 beste Teiler 37.2 (11.) 76.0 (17.) 97.4 (15.)
 Trefferlage 0.06 mm rechts, 0.05 mm tief
 Streuwert 1.13, horizontal: 1.29, vertikal: 0.94

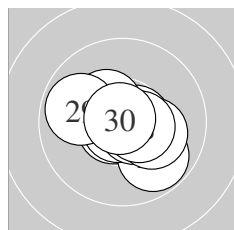

Serie 3:
 10.7 * 10.6 * 9.8 ↘ 10.8 * 10.6 *
 10.2 * 10.4 * 10.5 * 9.9 ← 10.8 *
 beste Teiler 28.4 (30.) 41.7 (24.) 68.7 (21.)
 Trefferlage 0.15 mm rechts, 0.20 mm tief
 Streuwert 1.15, horizontal: 1.38, vertikal: 0.87

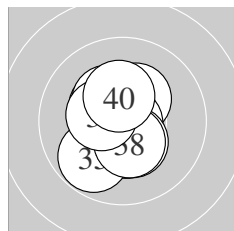

Serie 4:
 10.3 * 10.8 * 10.4 * 10.4 * 9.8 ↙
 10.4 * 10.3 * 10.4 * 10.4 * 10.3 *
 beste Teiler 29.5 (32.) 135.7 (34.) 136.6 (39.)
 Trefferlage 0.30 mm links, 0.07 mm tief
 Streuwert 1.17, horizontal: 0.92, vertikal: 1.37

Unterschrift des Schuetzen

Meyton Elektronik

Ergebnis: **387.3** (370)
 Serien: 94.0 97.6 98.5 97.2
 Zaehler: 16 18 6 0 0 0 0 0 0 0
 Innenzehner: 8
 weiteste: 749 (31), 688 (2), 674 (10)
 beste Teiler 14.1 (32.) 65.5 (23.) 85.7 (7.)
 Trefferlage 0.38 mm links, 0.21 mm tief
 Streuwert 2.57, horizontal: 2.84, vertikal: 2.27

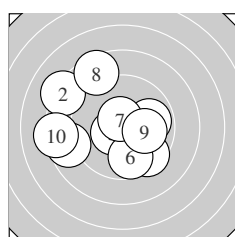
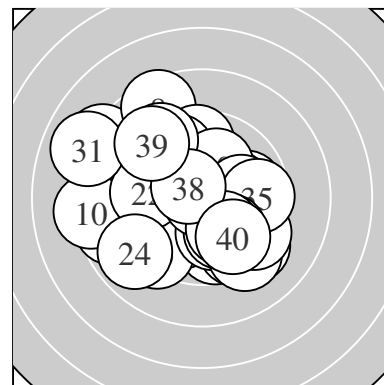

Serie 1:
 9.5 ↘ 8.2 ↖ 8.7 ← 9.9 → 10.5 *
 9.7 ↓ 10.6 * 8.5 ↗ 10.1 → 8.3 ←
 beste Teiler 85.7 (7.) 111.5 (5.) 224.2 (9.)
 Trefferlage 1.38 mm links, 0.10 mm hoch
 Streuwert 3.17, horizontal: 3.62, vertikal: 2.64

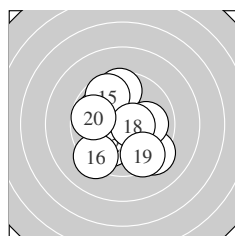

Serie 2:
 9.3 ↘ 10.0 ↙ 9.9 ↖ 9.6 ↑ 9.7 ↗
 9.3 ↙ 10.0 → 10.5 * 9.5 ↓ 9.8 ←
 beste Teiler 102.9 (18.) 236.0 (17.) 236.5 (12.)
 Trefferlage 0.25 mm links, 0.32 mm tief
 Streuwert 2.32, horizontal: 2.22, vertikal: 2.41

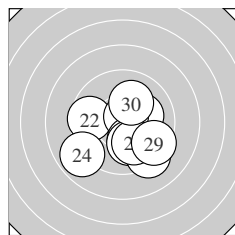

Serie 3:
 10.2 * 9.6 ← 10.7 * 8.9 ↙ 10.2 *
 10.1 ↓ 9.3 ↘ 10.0 ↓ 9.4 ↘ 10.1 ↗
 beste Teiler 65.5 (23.) 187.5 (25.) 199.5 (21.)
 Trefferlage 0.39 mm rechts, 1.11 mm tief
 Streuwert 2.09, horizontal: 2.33, vertikal: 1.83

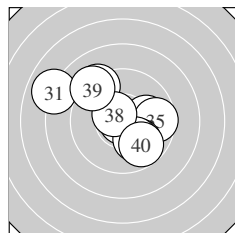

Serie 4:
 8.0 ↖ 10.9 * 10.0 → 9.2 ↗ 9.6 →
 9.9 ↘ 10.1 ↓ 10.5 * 9.2 ↖ 9.8 ↓
 beste Teiler 14.1 (32.) 107.9 (38.) 222.7 (37.)
 Trefferlage 0.28 mm links, 0.45 mm hoch
 Streuwert 2.69, horizontal: 3.11, vertikal: 2.18

Unterschrift des Schuetzen

Meyton Elektronik

Ergebnis: **410.4** (395)
 Serien: 102.7 103.5 102.5 101.7
 Zaehler: 35 5 0 0 0 0 0 0 0 0
 Innenzehner: 26
 weiteste: 351 (28), 329 (35), 325 (40)
 beste Teiler 21.0 (31.) 39.4 (16.) 72.3 (30.)
 Trefferlage 0.68 mm rechts, 0.00 mm
 Streuwert 1.26, horizontal: 1.38, vertikal: 1.13

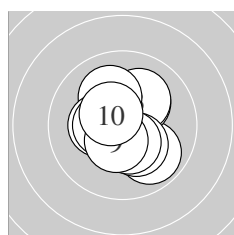
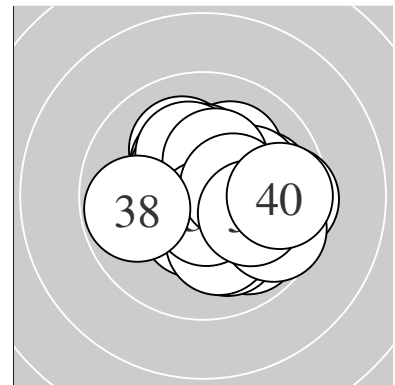

Serie 1:
 9.9 ↘ 10.2 * 10.1 ↗ 10.1 ↖ 10.3 *
 10.3 * 10.4 * 10.4 * 10.5 * 10.5 *
 beste Teiler 114.5 (10.) 117.9 (9.) 128.8 (8.)
 Trefferlage 0.05 mm rechts, 0.05 mm hoch
 Streuwert 1.32, horizontal: 1.22, vertikal: 1.42

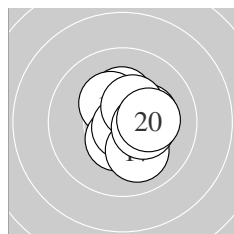

Serie 2:
 10.3 * 10.3 * 10.4 * 10.3 * 10.3 *
 10.8 * 10.1 ↘ 10.4 * 10.4 * 10.2 *
 beste Teiler 39.4 (16.) 126.4 (13.) 130.0 (18.)
 Trefferlage 0.64 mm rechts, 0.04 mm tief
 Streuwert 1.07, horizontal: 0.91, vertikal: 1.21

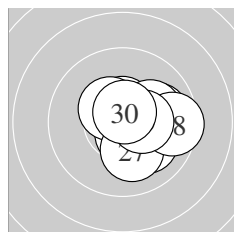

Serie 3:
 10.6 * 10.1 ↘ 10.0 → 10.6 * 10.4 *
 10.1 → 10.1 ↘ 9.5 → 10.4 * 10.7 *
 beste Teiler 72.3 (30.) 88.8 (21.) 98.0 (24.)
 Trefferlage 1.11 mm rechts, 0.03 mm tief
 Streuwert 1.18, horizontal: 1.32, vertikal: 1.03

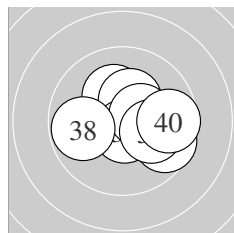

Serie 4:
 10.9 * 10.2 * 10.3 * 10.0 → 9.6 ↘
 10.7 * 10.4 * 9.8 ← 10.1 → 9.7 →
 beste Teiler 21.0 (31.) 73.3 (36.) 133.1 (37.)
 Trefferlage 0.93 mm rechts, 0.00 mm
 Streuwert 1.49, horizontal: 1.86, vertikal: 0.99

Unterschrift des Schuetzen

Ergebnis: **400.8** (383)

Serien: 97.8 101.9 101.0 100.1

Zaehler: 23 17 0 0 0 0 0 0 0 0

Innenzehner: 17

weiteste: 478 (2), 425 (6), 413 (7)

beste Teiler 1.0 (11.) 78.1 (16.) 82.2 (4.)

Trefferlage 0.41 mm rechts, 0.27 mm hoch

Streuwert 1.81, horizontal: 2.01, vertikal: 1.59

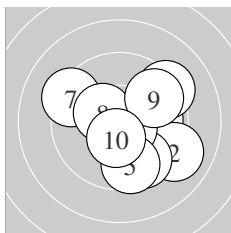
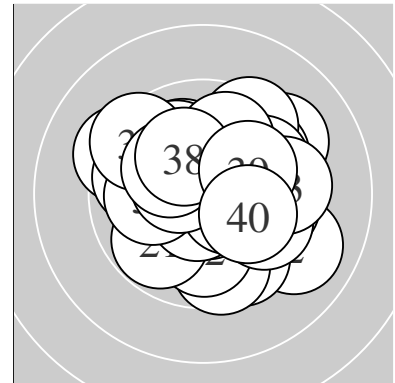

Serie 1:

9.9 →	9.0 ↘	9.6 ↘	10.6 *	9.6 ↓
9.3 ↗	9.3 ↖	10.4 *	9.7 ↗	10.4 *

beste Teiler 82.2 (4.) 131.7 (10.) 144.0 (8.)

Trefferlage 1.08 mm rechts, 0.36 mm tief

Streuwert 2.23, horizontal: 2.39, vertikal: 2.05

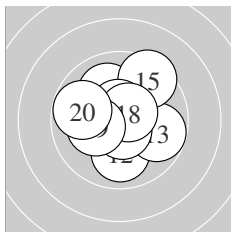

Serie 2:

10.9 *	10.0 ↓	9.8 →	10.0 ↖	9.4 ↗
10.6 *	10.6 *	10.6 *	10.2 *	9.8 ↖

beste Teiler 1.0 (11.) 78.1 (16.) 87.6 (17.)

Trefferlage 0.02 mm rechts, 0.28 mm hoch

Streuwert 1.63, horizontal: 1.67, vertikal: 1.59

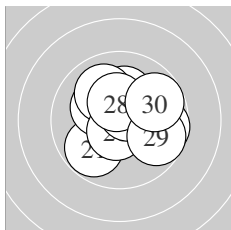

Serie 3:

9.8 ↖	9.7 →	10.2 *	10.2 *	10.0 ↖
10.6 *	10.6 *	10.4 *	9.7 →	9.8 ↗

beste Teiler 87.2 (26.) 91.2 (27.) 138.9 (28.)

Trefferlage 0.44 mm rechts, 0.36 mm hoch

Streuwert 1.66, horizontal: 1.86, vertikal: 1.43

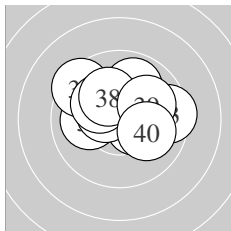

Serie 4:

10.0 ←	9.4 ↖	9.5 →	9.9 ↗	10.4 *
10.5 *	10.2 *	10.2 *	10.0 ↗	10.0 →

beste Teiler 117.3 (36.) 129.8 (35.) 191.0 (37.)

Trefferlage 0.13 mm rechts, 0.81 mm hoch

Streuwert 1.74, horizontal: 2.17, vertikal: 1.16

Unterschrift des Schuetzen

Meyton Elektronik

Ergebnis: **413.9** (397)
 Serien: 104.1 103.2 102.7 103.9
 Zaehler: 37 3 0 0 0 0 0 0 0 0
 Innenzehner: 31
 weiteste: 329 (6), 310 (12), 310 (25)
 beste Teiler 30.0 (35.) 39.0 (39.) 41.9 (16.)
 Trefferlage 0.25 mm links, 0.51 mm tief
 Streuwert 1.14, horizontal: 1.03, vertikal: 1.24

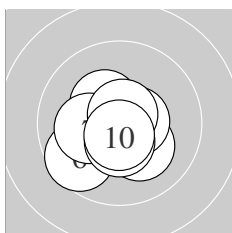
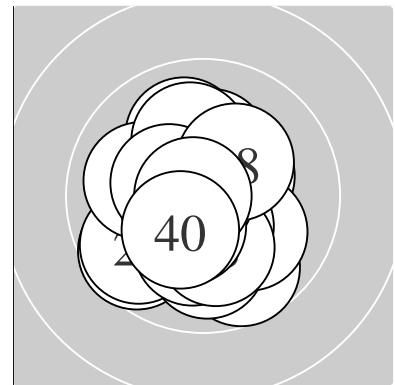

Serie 1:
 10.6 * 10.2 * 10.4 * 10.6 * 10.7 *
 9.6 ↙ 10.2 * 10.5 * 10.7 * 10.6 *
 beste Teiler 59.1 (9.) 72.0 (5.) 77.0 (10.)
 Trefferlage 0.35 mm links, 0.51 mm tief
 Streuwert 1.08, horizontal: 1.19, vertikal: 0.97

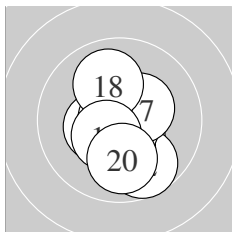

Serie 2:
 10.5 * 9.7 ↘ 10.3 * 10.4 * 10.7 *
 10.8 * 10.4 * 10.0 ↑ 10.4 * 10.0 ↓
 beste Teiler 41.9 (16.) 52.1 (15.) 120.1 (11.)
 Trefferlage 0.05 mm rechts, 0.65 mm tief
 Streuwert 1.24, horizontal: 0.91, vertikal: 1.50

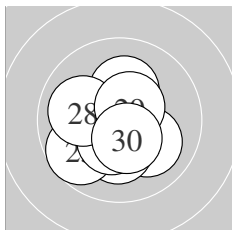

Serie 3:
 10.1 ↘ 10.5 * 10.2 * 10.6 * 9.7 ↙
 10.4 * 10.2 * 10.0 ← 10.5 * 10.5 *
 beste Teiler 100.7 (24.) 105.6 (29.) 123.3 (22.)
 Trefferlage 0.35 mm links, 0.60 mm tief
 Streuwert 1.28, horizontal: 1.30, vertikal: 1.26

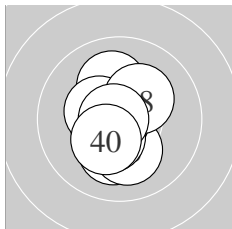

Serie 4:
 10.1 ↑ 10.2 * 10.1 ↓ 10.6 * 10.8 *
 10.4 * 10.4 * 10.2 * 10.8 * 10.3 *
 beste Teiler 30.0 (35.) 39.0 (39.) 97.4 (34.)
 Trefferlage 0.35 mm links, 0.28 mm tief
 Streuwert 1.08, horizontal: 0.73, vertikal: 1.35

Unterschrift des Schuetzen

Ergebnis: **409.7** (393)
 Serien: 102.4 103.0 102.4 101.9
 Zaehler: 33 7 0 0 0 0 0 0 0 0
 Innenzehner: 25
 weiteste: 362 (16), 315 (5), 298 (40)
 beste Teiler 60.3 (13.) 64.4 (20.) 70.1 (8.)
 Trefferlage 0.36 mm rechts, 0.03 mm hoch
 Streuwert 1.36, horizontal: 1.34, vertikal: 1.38

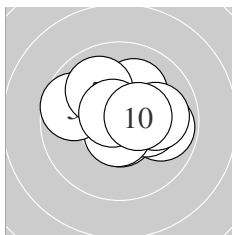
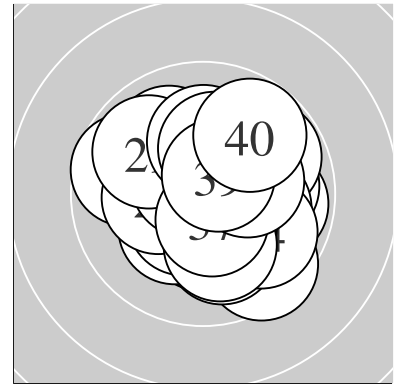

Serie 1:
 10.6 * 9.9 → 10.3 * 10.6 * 9.7 ←
 10.1 ↗ 10.0 ↘ 10.7 * 10.0 → 10.5 *
 beste Teiler 70.1 (8.) 76.9 (4.) 78.4 (1.)
 Trefferlage 0.41 mm rechts, 0.40 mm hoch
 Streuwert 1.43, horizontal: 1.76, vertikal: 1.00

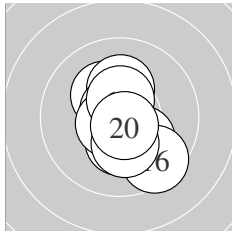

Serie 2:
 10.2 * 10.2 * 10.7 * 10.1 ↘ 10.3 *
 9.5 ↘ 10.6 * 10.5 * 10.2 * 10.7 *
 beste Teiler 60.3 (13.) 64.4 (20.) 79.9 (17.)
 Trefferlage 0.24 mm rechts, 0.36 mm tief
 Streuwert 1.31, horizontal: 0.98, vertikal: 1.56

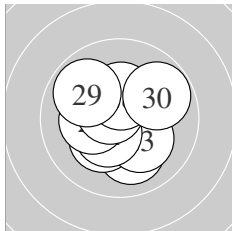

Serie 3:
 10.0 ↓ 10.3 * 10.2 * 10.5 * 10.5 *
 10.2 * 10.6 * 10.4 * 9.9 ↖ 9.8 ↗
 beste Teiler 81.6 (27.) 103.2 (25.) 125.4 (24.)
 Trefferlage 0.26 mm links, 0.02 mm tief
 Streuwert 1.40, horizontal: 1.43, vertikal: 1.37

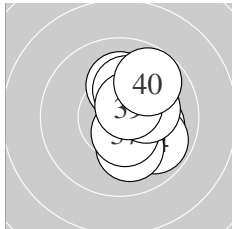

Serie 4:
 10.1 ↑ 10.2 * 10.1 → 9.9 ↘ 10.4 *
 10.1 ↓ 10.5 * 10.2 * 10.6 * 9.8 ↗
 beste Teiler 96.6 (39.) 109.1 (37.) 141.9 (35.)
 Trefferlage 1.08 mm rechts, 0.11 mm hoch
 Streuwert 1.27, horizontal: 0.82, vertikal: 1.60

Unterschrift des Schuetzen

Meyton Elektronik

Ergebnis: **407.4** (389)
 Serien: 103.0 100.9 100.4 103.1
 Zaehler: 29 11 0 0 0 0 0 0 0 0
 Innenzehner: 22
 weiteste: 424 (20), 409 (29), 393 (23)
 beste Teiler 12.0 (10.) 22.3 (21.) 59.0 (13.)
 Trefferlage 0.32 mm links, 0.09 mm hoch
 Streuwert 1.52, horizontal: 1.78, vertikal: 1.22

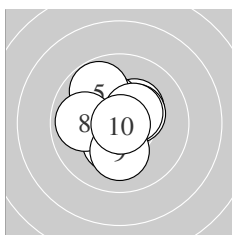
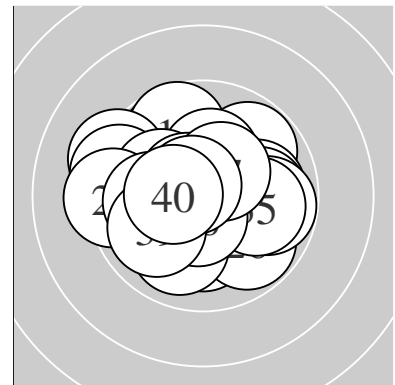

Serie 1:
 10.3 * 10.4 * 10.6 * 10.3 * 9.8 ↗
 10.4 * 10.3 * 9.9 ← 10.1 ↓ 10.9 *
 beste Teiler 12.0 (10.) 88.6 (3.) 129.2 (6.)
 Trefferlage 0.27 mm links, 0.33 mm hoch
 Streuwert 1.28, horizontal: 1.24, vertikal: 1.32

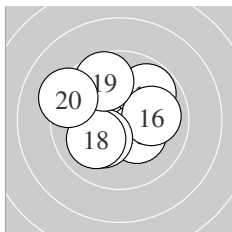

Serie 2:
 10.5 * 10.4 * 10.7 * 9.8 ↗ 10.3 *
 10.0 → 10.2 * 10.0 ↙ 9.7 ↗ 9.3 ↖
 beste Teiler 59.0 (13.) 116.7 (11.) 137.3 (12.)
 Trefferlage 0.04 mm links, 0.35 mm hoch
 Streuwert 1.76, horizontal: 2.01, vertikal: 1.48

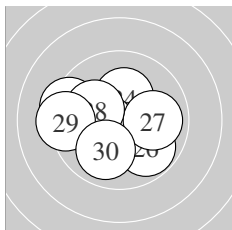

Serie 3:
 10.9 * 10.2 * 9.4 ↖ 10.3 * 10.5 *
 9.8 ↘ 9.9 → 10.1 ↖ 9.3 ← 10.0 ↙
 beste Teiler 22.3 (21.) 110.3 (25.) 175.1 (24.)
 Trefferlage 0.84 mm links, 0.23 mm tief
 Streuwert 1.77, horizontal: 2.18, vertikal: 1.25

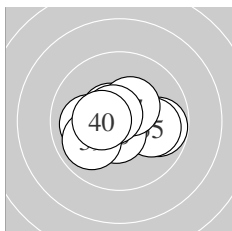

Serie 4:
 10.0 ← 10.7 * 10.6 * 9.8 → 10.0 →
 10.6 * 10.4 * 10.7 * 9.9 ↙ 10.4 *
 beste Teiler 69.3 (32.) 70.0 (38.) 95.0 (33.)
 Trefferlage 0.14 mm links, 0.06 mm tief
 Streuwert 1.35, horizontal: 1.74, vertikal: 0.79

Unterschrift des Schuetzen

Meyton Elektronik

Ergebnis: **412.5** (392)
 Serien: 103.7 105.1 101.4 102.3
 Zaehler: 32 8 0 0 0 0 0 0 0 0
 Innenzehner: 30
 weiteste: 424 (26), 370 (24), 304 (33)
 beste Teiler 24.4 (29.) 31.0 (2.) 37.3 (8.)
 Trefferlage 0.04 mm links, 0.19 mm hoch
 Streuwert 1.33, horizontal: 1.45, vertikal: 1.21

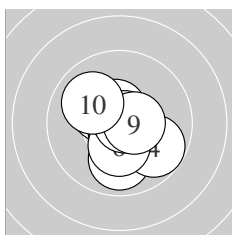
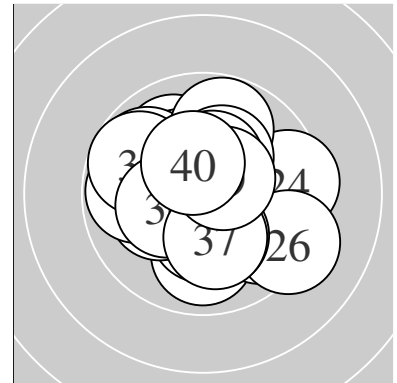

Serie 1:
 9.9 ↓ 10.8 * 10.3 * 9.8 ↘ 10.7 *
 10.3 * 10.6 * 10.8 * 10.5 * 10.0 ↖
 beste Teiler 31.0 (2.) 37.3 (8.) 62.0 (5.)
 Trefferlage 0.03 mm rechts, 0.27 mm tief
 Streuwert 1.25, horizontal: 1.19, vertikal: 1.31

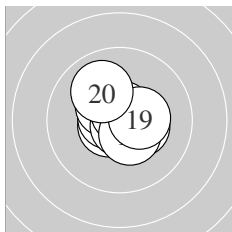

Serie 2:
 10.6 * 10.6 * 10.4 * 10.7 * 10.4 *
 10.8 * 10.7 * 10.5 * 10.4 * 10.0 ↖
 beste Teiler 43.6 (16.) 59.2 (17.) 60.0 (14.)
 Trefferlage 0.06 mm rechts, 0.17 mm hoch
 Streuwert 0.93, horizontal: 0.98, vertikal: 0.88

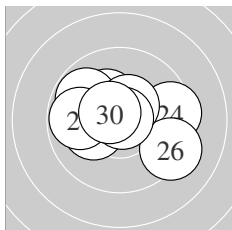

Serie 3:
 10.3 * 10.5 * 9.8 ↖ 9.5 → 10.2 *
 9.3 ↘ 9.8 ← 10.5 * 10.9 * 10.6 *
 beste Teiler 24.4 (29.) 89.8 (30.) 112.2 (22.)
 Trefferlage 0.15 mm links, 0.31 mm hoch
 Streuwert 1.78, horizontal: 2.29, vertikal: 1.06

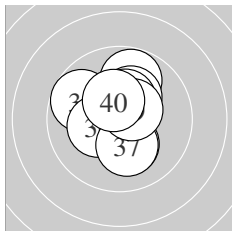

Serie 4:
 9.8 ↑ 10.6 * 9.7 ↖ 10.2 * 10.2 *
 10.3 * 10.2 * 10.4 * 10.5 * 10.4 *
 beste Teiler 98.8 (32.) 111.2 (39.) 141.0 (40.)
 Trefferlage 0.11 mm links, 0.57 mm hoch
 Streuwert 1.37, horizontal: 1.21, vertikal: 1.51

Unterschrift des Schuetzen

Ergebnis: **402.9** (386)
 Serien: 100.3 100.2 102.0 100.4
 Zaehler: 27 12 1 0 0 0 0 0 0 0
 Innenzehner: 18
 weiteste: 661 (40), 475 (3), 364 (15)
 beste Teiler 51.0 (24.) 53.1 (20.) 55.1 (33.)
 Trefferlage 0.24 mm links, 0.09 mm hoch
 Streuwert 1.78, horizontal: 2.12, vertikal: 1.37

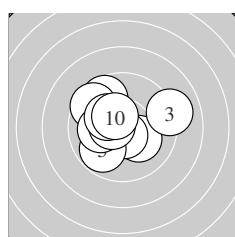
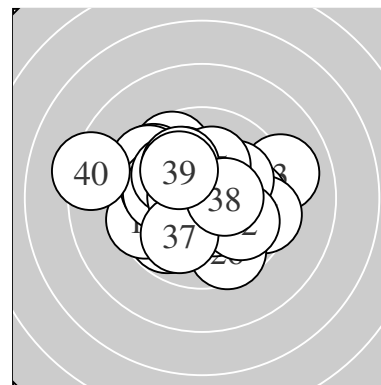

Serie 1:
 9.7 ↘ 10.2 * 9.1 → 10.6 * 9.8 ↙
 9.6 ↖ 10.1 ← 10.5 * 10.3 * 10.4 *
 beste Teiler 81.0 (4.) 103.4 (8.) 129.2 (10.)
 Trefferlage 0.55 mm links, 0.41 mm hoch
 Streuwert 1.87, horizontal: 2.18, vertikal: 1.50

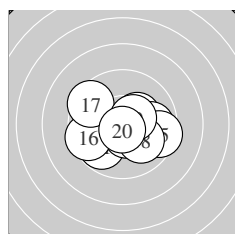

Serie 2:
 9.8 ↙ 10.5 * 10.3 * 9.9 → 9.5 →
 9.5 ← 9.5 ↘ 10.0 ↘ 10.5 * 10.7 *
 beste Teiler 53.1 (20.) 109.4 (12.) 117.8 (19.)
 Trefferlage 0.23 mm rechts, 0.41 mm tief
 Streuwert 1.88, horizontal: 2.35, vertikal: 1.23

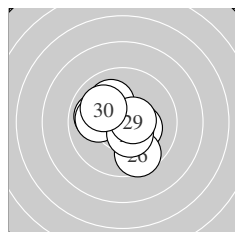

Serie 3:
 9.9 ← 10.3 * 10.0 ← 10.7 * 10.5 *
 9.6 ↓ 10.4 * 10.1 ↘ 10.5 * 10.0 ↖
 beste Teiler 51.0 (24.) 101.4 (29.) 106.7 (25.)
 Trefferlage 0.17 mm links, 0.12 mm tief
 Streuwert 1.48, horizontal: 1.59, vertikal: 1.37

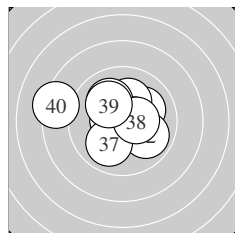

Serie 4:
 10.1 → 9.9 ↘ 10.7 * 10.6 * 10.2 *
 10.1 ↘ 10.0 ↙ 10.4 * 10.1 ↘ 8.3 ←
 beste Teiler 55.1 (33.) 92.1 (34.) 131.1 (38.)
 Trefferlage 0.48 mm links, 0.50 mm hoch
 Streuwert 2.01, horizontal: 2.49, vertikal: 1.37

Unterschrift des Schuetzen

Meyton Elektronik

Ergebnis: **404.0** (390)
 Serien: 101.8 100.7 101.9 99.6
 Zaehler: 30 10 0 0 0 0 0 0 0 0
 Innenzehner: 20
 weiteste: 475 (16), 452 (7), 440 (34)
 beste Teiler 67.8 (2.) 71.5 (17.) 73.5 (4.)
 Trefferlage 0.21 mm links, 0.04 mm hoch
 Streuwert 1.72, horizontal: 2.01, vertikal: 1.37

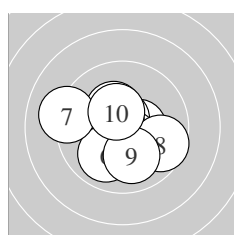
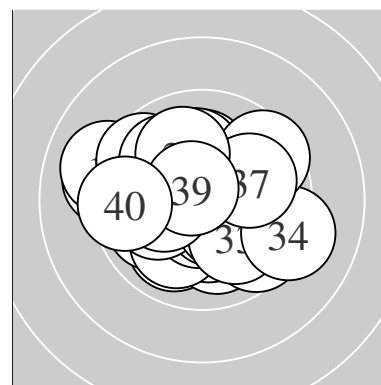

Serie 1:
 10.5 * 10.7 * 10.5 * 10.7 * 10.3 *
 10.0 ↙ 9.1 ← 9.6 → 10.0 ↓ 10.4 *
 beste Teiler 67.8 (2.) 73.5 (4.) 107.0 (3.)
 Trefferlage 0.20 mm links, 0.17 mm tief
 Streuwert 1.67, horizontal: 1.93, vertikal: 1.36

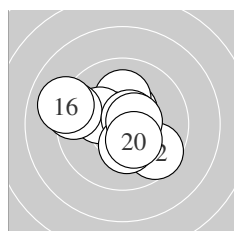

Serie 2:
 10.5 * 9.6 ↘ 10.1 ↑ 10.2 * 9.3 ←
 9.1 ← 10.7 * 10.3 * 10.6 * 10.3 *
 beste Teiler 71.5 (17.) 93.8 (19.) 118.9 (11.)
 Trefferlage 0.44 mm links, 0.20 mm hoch
 Streuwert 1.88, horizontal: 2.25, vertikal: 1.42

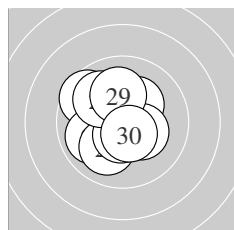

Serie 3:
 10.6 * 9.6 ↘ 9.9 ← 10.3 * 10.0 ↙
 10.6 * 10.0 ↘ 10.3 * 10.1 ↑ 10.5 *
 beste Teiler 76.6 (21.) 100.9 (26.) 105.1 (30.)
 Trefferlage 0.47 mm links, 0.13 mm hoch
 Streuwert 1.49, horizontal: 1.47, vertikal: 1.52

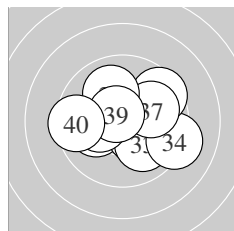

Serie 4:
 10.1 ← 10.4 * 10.0 ↘ 9.2 → 10.2 *
 9.5 ↗ 10.0 → 10.0 ↖ 10.7 * 9.5 ←
 beste Teiler 75.0 (39.) 147.1 (32.) 182.3 (35.)
 Trefferlage 0.28 mm rechts, 0.02 mm hoch
 Streuwert 2.01, horizontal: 2.48, vertikal: 1.38

Unterschrift des Schuetzen

Meyton Elektronik

Ergebnis: **409.6** (394)
 Serien: 100.4 103.2 103.5 102.5
 Zaehler: 35 4 1 0 0 0 0 0 0 0
 Innenzehner: 29
 weiteste: 511 (3), 473 (6), 412 (24)
 beste Teiler 30.4 (18.) 55.9 (26.) 58.6 (37.)
 Trefferlage 0.93 mm rechts, 0.33 mm tief
 Streuwert 1.29, horizontal: 1.30, vertikal: 1.28

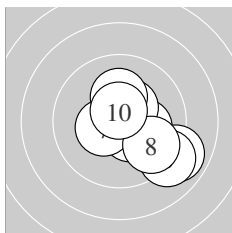
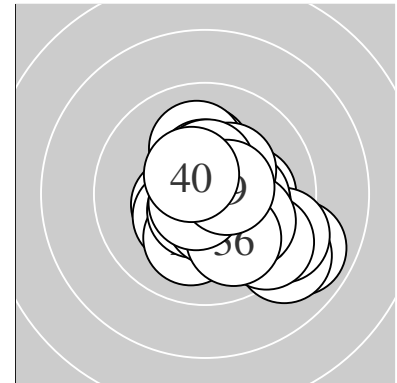

Serie 1:
 10.4 * 10.5 * 8.9 ↘ 10.2 * 10.4 *
 9.1 ↘ 10.4 * 9.7 ↘ 10.2 * 10.6 *
 beste Teiler 83.2 (10.) 125.4 (2.) 132.0 (1.)
 Trefferlage 1.41 mm rechts, 0.54 mm tief
 Streuwert 1.67, horizontal: 1.77, vertikal: 1.57

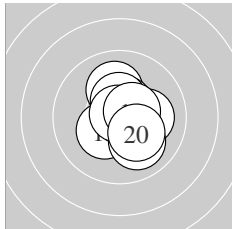

Serie 2:
 10.1 → 10.3 * 10.3 * 10.1 ↑ 10.5 *
 10.4 * 10.0 ↘ 10.8 * 10.5 * 10.2 *
 beste Teiler 30.4 (18.) 105.3 (15.) 108.2 (19.)
 Trefferlage 0.55 mm rechts, 0.00 mm
 Streuwert 1.14, horizontal: 0.99, vertikal: 1.28

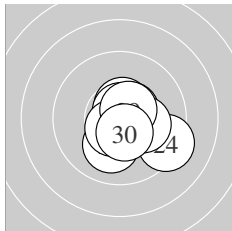

Serie 3:
 10.6 * 10.1 ↓ 10.4 * 9.3 ↘ 10.5 *
 10.7 * 10.2 * 10.6 * 10.6 * 10.5 *
 beste Teiler 55.9 (26.) 92.1 (28.) 94.7 (29.)
 Trefferlage 0.76 mm rechts, 0.44 mm tief
 Streuwert 1.18, horizontal: 1.25, vertikal: 1.10

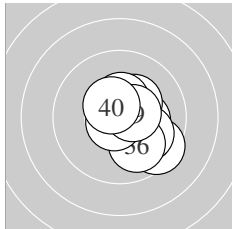

Serie 4:
 10.4 * 10.2 * 9.5 ↘ 10.3 * 10.0 ↘
 10.0 ↘ 10.7 * 10.4 * 10.5 * 10.5 *
 beste Teiler 58.6 (37.) 107.5 (39.) 112.0 (40.)
 Trefferlage 1.03 mm rechts, 0.34 mm tief
 Streuwert 1.19, horizontal: 1.10, vertikal: 1.27

Unterschrift des Schuetzen

Meyton Elektronik

Ergebnis: **394.8** (378)
 Serien: 100.3 98.1 100.4 96.0
 Zaehler: 20 18 2 0 0 0 0 0 0 0
 Innenzehner: 11
 weiteste: 651 (35), 586 (39), 487 (25)
 beste Teiler 46.5 (4.) 77.0 (28.) 115.0 (8.)
 Trefferlage 0.18 mm rechts, 0.56 mm tief
 Streuwert 2.08, horizontal: 2.07, vertikal: 2.10

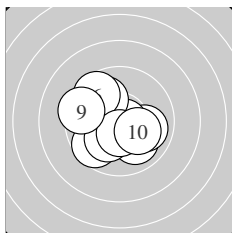
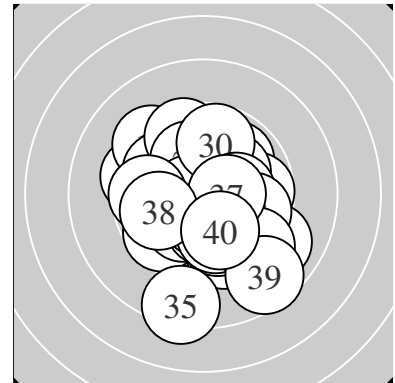

Serie 1:
 10.0 ↘ 10.0 → 9.7 ↙ 10.8 * 10.0 ↖
 9.6 ↖ 10.1 ↗ 10.5 * 9.4 ← 10.2 *
 beste Teiler 46.5 (4.) 115.0 (8.) 197.3 (10.)
 Trefferlage 0.47 mm links, 0.31 mm tief
 Streuwert 1.84, horizontal: 2.00, vertikal: 1.66

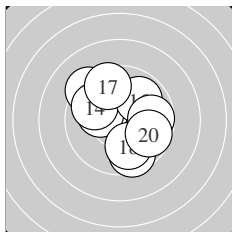

Serie 2:
 10.3 * 10.2 * 9.3 ↖ 9.9 ↖ 9.6 ↓
 9.9 ↗ 9.6 ↖ 9.9 ↓ 9.7 → 9.7 →
 beste Teiler 160.6 (11.) 194.7 (12.) 262.1 (18.)
 Trefferlage 0.00 mm , 0.39 mm hoch
 Streuwert 2.18, horizontal: 2.21, vertikal: 2.16

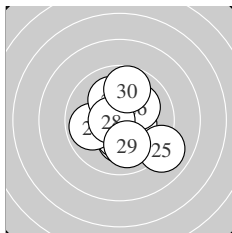

Serie 3:
 10.2 * 10.4 * 10.4 * 9.9 ← 9.0 ↘
 10.1 ↗ 10.1 ↖ 10.6 * 10.0 ↓ 9.7 ↑
 beste Teiler 77.0 (28.) 139.7 (23.) 142.2 (22.)
 Trefferlage 0.42 mm rechts, 0.32 mm tief
 Streuwert 1.83, horizontal: 1.76, vertikal: 1.89

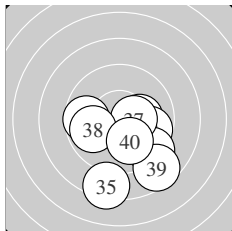

Serie 4:
 10.2 * 9.7 ← 9.7 → 10.0 ↘ 8.3 ↓
 9.2 ↘ 10.4 * 9.9 ← 8.6 ↘ 10.0 ↘
 beste Teiler 137.0 (37.) 192.4 (31.) 231.7 (40.)
 Trefferlage 0.80 mm rechts, 2.00 mm tief
 Streuwert 2.26, horizontal: 2.36, vertikal: 2.16

Unterschrift des Schuetzen

Meyton Elektronik

Ergebnis: **402.0** (383)
 Serien: 100.4 98.8 103.0 99.8
 Zaehler: 24 15 1 0 0 0 0 0 0 0
 Innenzehner: 18
 weiteste: 596 (33), 396 (9), 380 (13)
 beste Teiler 56.8 (11.) 65.4 (31.) 84.4 (25.)
 Trefferlage 0.08 mm links, 0.07 mm tief
 Streuwert 1.80, horizontal: 2.12, vertikal: 1.40

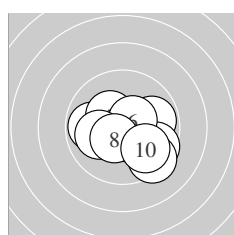
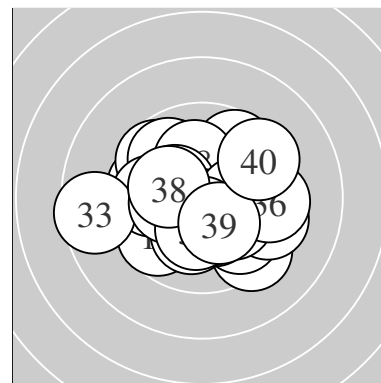

Serie 1:
 9.8 ← 10.6 * 9.9 → 9.6 ↘ 10.3 *
 10.5 * 10.1 ← 10.4 * 9.4 ↘ 9.8 ↘
 beste Teiler 99.9 (2.) 112.0 (6.) 126.6 (8.)
 Trefferlage 0.49 mm rechts, 0.68 mm tief
 Streuwert 1.75, horizontal: 2.12, vertikal: 1.29

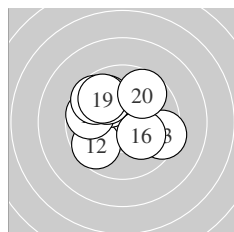

Serie 2:
 10.7 * 9.7 ↙ 9.4 ↘ 10.1 ↘ 9.7 ←
 10.1 ↘ 9.9 ↘ 9.7 ↘ 9.8 ↘ 9.7 ↗
 beste Teiler 56.8 (11.) 205.8 (16.) 215.2 (14.)
 Trefferlage 0.48 mm links, 0.72 mm hoch
 Streuwert 1.98, horizontal: 2.24, vertikal: 1.67

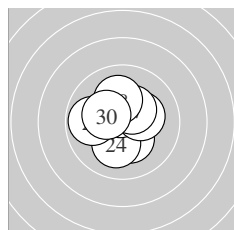

Serie 3:
 10.3 * 10.5 * 10.5 * 10.1 ↓ 10.6 *
 10.3 * 10.4 * 10.1 ↑ 9.9 ← 10.3 *
 beste Teiler 84.4 (25.) 109.0 (22.) 120.9 (23.)
 Trefferlage 0.35 mm links, 0.00 mm
 Streuwert 1.26, horizontal: 1.24, vertikal: 1.28

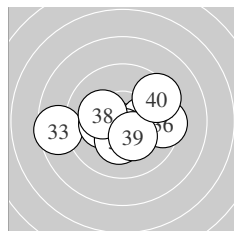

Serie 4:
 10.7 * 10.1 → 8.6 ← 10.2 * 10.5 *
 9.5 → 10.3 * 10.2 * 10.3 * 9.4 ↗
 beste Teiler 65.4 (31.) 107.0 (35.) 167.8 (39.)
 Trefferlage 0.01 mm links, 0.33 mm tief
 Streuwert 2.12, horizontal: 2.79, vertikal: 1.10

Unterschrift des Schuetzen

Meyton Elektronik

Ergebnis: **412.6** (395)
 Serien: 103.7 103.2 103.1 102.6
 Zaehler: 35 5 0 0 0 0 0 0 0 0
 Innenzehner: 29
 weiteste: 312 (25), 302 (12), 271 (32)
 beste Teiler 31.3 (37.) 36.7 (1.) 51.1 (26.)
 Trefferlage 0.27 mm rechts, 0.30 mm tief
 Streuwert 1.21, horizontal: 1.34, vertikal: 1.07

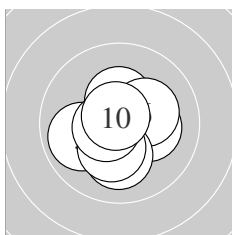
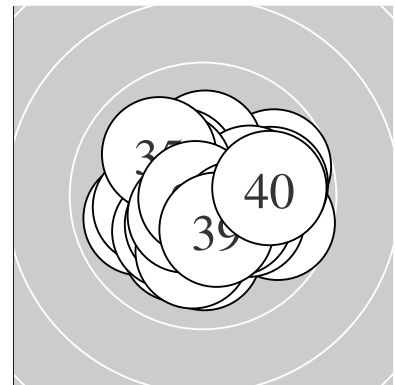

Serie 1:
 10.8 * 10.5 * 10.4 * 10.2 * 9.9 ←
 10.2 * 10.1 ↓ 10.3 * 10.6 * 10.7 *
 beste Teiler 36.7 (1.) 53.7 (10.) 91.0 (9.)
 Trefferlage 0.06 mm rechts, 0.30 mm tief
 Streuwert 1.17, horizontal: 1.27, vertikal: 1.05

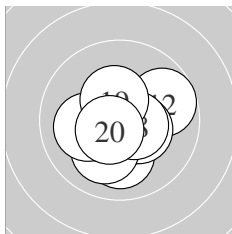

Serie 2:
 10.1 ↓ 9.7 → 10.6 * 10.4 * 10.7 *
 10.1 ↙ 10.1 ← 10.5 * 10.4 * 10.6 *
 beste Teiler 64.0 (15.) 91.9 (20.) 93.3 (13.)
 Trefferlage 0.16 mm rechts, 0.50 mm tief
 Streuwert 1.24, horizontal: 1.34, vertikal: 1.12

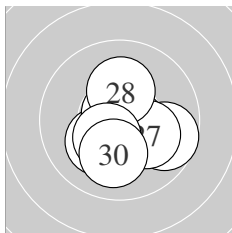

Serie 3:
 10.6 * 10.2 * 10.4 * 10.6 * 9.7 →
 10.7 * 10.2 * 10.2 * 10.4 * 10.1 ↓
 beste Teiler 51.1 (26.) 81.3 (24.) 92.3 (21.)
 Trefferlage 0.45 mm rechts, 0.60 mm tief
 Streuwert 1.20, horizontal: 1.28, vertikal: 1.12

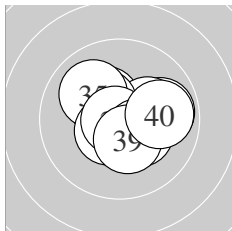

Serie 4:
 10.3 * 9.9 → 10.2 * 10.3 * 10.0 ↖
 10.5 * 10.8 * 10.3 * 10.4 * 9.9 →
 beste Teiler 31.3 (37.) 105.4 (36.) 143.1 (39.)
 Trefferlage 0.41 mm rechts, 0.21 mm hoch
 Streuwert 1.33, horizontal: 1.60, vertikal: 0.97

Unterschrift des Schuetzen

Meyton Elektronik

Ergebnis: **413.9** (395)
 Serien: 102.3 104.2 104.4 103.0
 Zaehler: 35 5 0 0 0 0 0 0 0 0
 Innenzehner: 28
 weiteste: 348 (11), 312 (6), 296 (28)
 beste Teiler 16.6 (24.) 34.5 (19.) 43.1 (27.)
 Trefferlage 0.02 mm links, 0.34 mm tief
 Streuwert 1.21, horizontal: 1.31, vertikal: 1.11

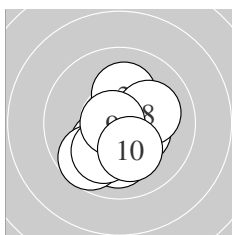
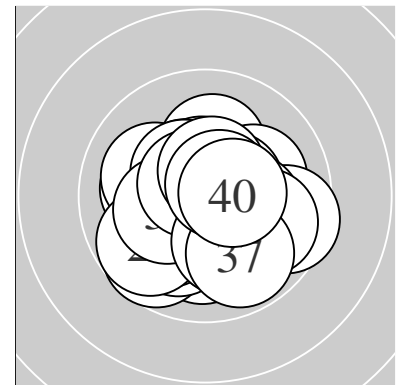

Serie 1:
 10.5 * 10.4 * 10.2 * 10.2 * 10.1 ↓
 9.7 ↙ 10.1 ↙ 10.1 → 10.8 * 10.2 *
 beste Teiler 49.0 (9.) 119.6 (1.) 142.8 (2.)
 Trefferlage 0.10 mm links, 0.87 mm tief
 Streuwert 1.32, horizontal: 1.22, vertikal: 1.41

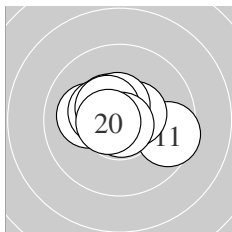

Serie 2:
 9.6 → 10.7 * 10.5 * 10.1 ← 10.5 *
 10.5 * 10.4 * 10.5 * 10.8 * 10.6 *
 beste Teiler 34.5 (19.) 57.7 (12.) 78.9 (20.)
 Trefferlage 0.09 mm links, 0.29 mm hoch
 Streuwert 1.16, horizontal: 1.52, vertikal: 0.63

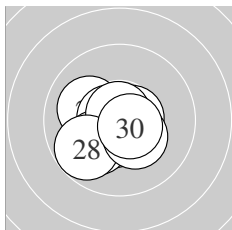

Serie 3:
 10.6 * 10.1 ↖ 10.5 * 10.9 * 10.7 *
 10.1 ↙ 10.8 * 9.8 ↙ 10.3 * 10.6 *
 beste Teiler 16.6 (24.) 43.1 (27.) 73.4 (25.)
 Trefferlage 0.46 mm links, 0.46 mm tief
 Streuwert 1.06, horizontal: 1.19, vertikal: 0.91

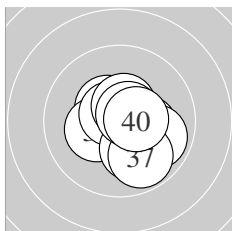

Serie 4:
 10.5 * 10.2 * 10.3 * 9.9 → 10.6 *
 10.1 ↓ 9.8 ↓ 10.5 * 10.6 * 10.5 *
 beste Teiler 76.4 (35.) 76.6 (39.) 108.6 (38.)
 Trefferlage 0.55 mm rechts, 0.32 mm tief
 Streuwert 1.21, horizontal: 1.25, vertikal: 1.17

Unterschrift des Schuetzen

Meyton Elektronik

Ergebnis: **389.8** (372)
 Serien: 97.0 98.5 95.4 98.9
 Zaehler: 18 16 6 0 0 0 0 0 0 0
 Innenzehner: 12
 weiteste: 623 (4), 619 (28), 618 (22)
 beste Teiler 51.6 (21.) 84.0 (35.) 89.2 (27.)
 Trefferlage 0.38 mm links, 0.26 mm hoch
 Streuwert 2.43, horizontal: 2.78, vertikal: 2.02

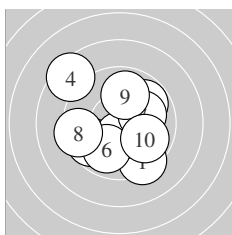
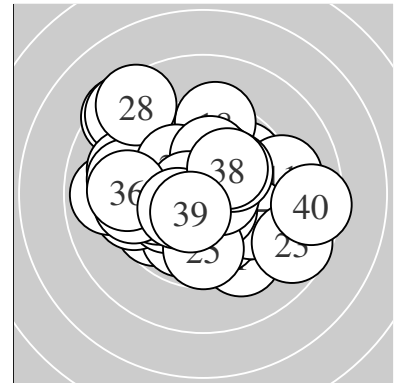

Serie 1:
 9.3 ↘ 9.8 ↗ 9.7 ↙ 8.5 ↖ 10.5 *
 9.9 ↙ 10.1 → 9.4 ← 9.9 ↑ 9.9 ↘
 beste Teiler 119.0 (5.) 223.6 (7.) 264.9 (9.)
 Trefferlage 0.29 mm links, 0.16 mm tief
 Streuwert 2.54, horizontal: 2.64, vertikal: 2.44

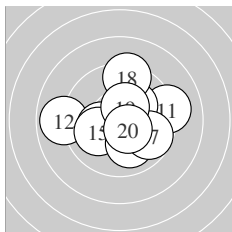

Serie 2:
 9.2 → 8.9 ← 10.2 * 10.2 * 10.1 ↙
 10.0 ↓ 9.7 ↘ 9.3 ↑ 10.4 * 10.5 *
 beste Teiler 113.2 (20.) 133.1 (19.) 181.8 (14.)
 Trefferlage 0.24 mm rechts, 0.15 mm hoch
 Streuwert 2.27, horizontal: 2.66, vertikal: 1.79

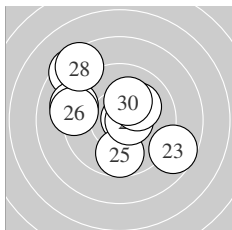

Serie 3:
 10.7 * 8.5 ↖ 8.7 ↘ 9.2 ↖ 9.7 ↓
 9.2 ← 10.6 * 8.5 ↖ 10.1 ↗ 10.2 *
 beste Teiler 51.6 (21.) 89.2 (27.) 192.5 (30.)
 Trefferlage 0.77 mm links, 0.88 mm hoch
 Streuwert 2.90, horizontal: 3.19, vertikal: 2.58

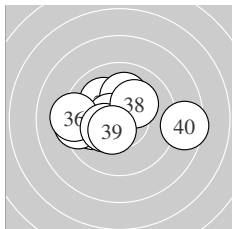

Serie 4:
 9.9 ← 10.1 ↖ 10.1 ↑ 9.4 ← 10.6 *
 9.3 ← 10.3 * 10.2 * 10.5 * 8.5 →
 beste Teiler 84.0 (35.) 122.8 (39.) 162.1 (37.)
 Trefferlage 0.72 mm links, 0.19 mm hoch
 Streuwert 2.22, horizontal: 2.93, vertikal: 1.12

Unterschrift des Schuetzen

Meyton Elektronik

Ergebnis: **405.5** (390)
 Serien: 99.8 103.8 100.4 101.5
 Zaehler: 30 10 0 0 0 0 0 0 0 0
 Innenzehner: 25
 weiteste: 446 (31), 425 (23), 416 (21)
 beste Teiler 42.7 (12.) 77.3 (20.) 101.7 (27.)
 Trefferlage 0.21 mm rechts, 0.04 mm hoch
 Streuwert 1.61, horizontal: 1.68, vertikal: 1.53

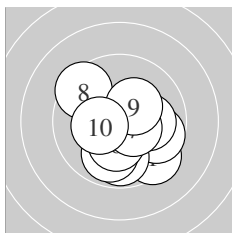
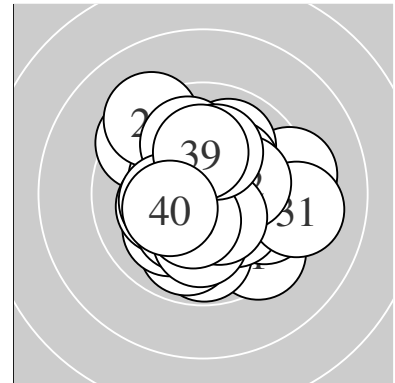

Serie 1:
 9.4 ↘ 9.7 → 9.8 ↓ 10.1 → 9.9 ↓
 10.3 * 10.5 * 9.5 ↖ 10.3 * 10.3 *
 beste Teiler 119.8 (7.) 160.8 (10.) 161.2 (9.)
 Trefferlage 0.45 mm rechts, 0.82 mm tief
 Streuwert 1.79, horizontal: 1.87, vertikal: 1.72

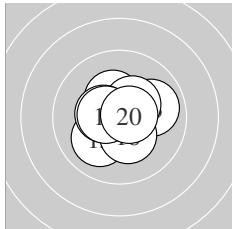

Serie 2:
 10.5 * 10.8 * 9.9 → 10.3 * 10.1 ↙
 10.4 * 10.4 * 10.3 * 10.5 * 10.6 *
 beste Teiler 42.7 (12.) 77.3 (20.) 110.6 (19.)
 Trefferlage 0.02 mm rechts, 0.24 mm hoch
 Streuwert 1.13, horizontal: 1.22, vertikal: 1.02

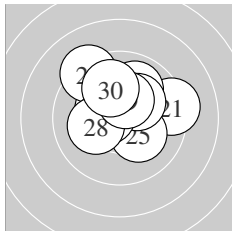

Serie 3:
 9.3 → 10.4 * 9.3 ↖ 9.9 ↗ 10.2 *
 10.2 * 10.5 * 10.2 * 10.4 * 10.0 ↖
 beste Teiler 101.7 (27.) 145.4 (22.) 149.5 (29.)
 Trefferlage 0.12 mm rechts, 1.07 mm hoch
 Streuwert 1.71, horizontal: 1.96, vertikal: 1.41

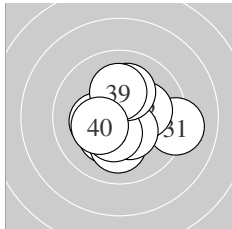

Serie 4:
 9.2 → 10.2 * 10.3 * 10.1 ↓ 10.4 *
 10.4 * 10.1 ↑ 10.3 * 10.2 * 10.3 *
 beste Teiler 133.4 (35.) 134.1 (36.) 170.1 (40.)
 Trefferlage 0.26 mm rechts, 0.31 mm tief
 Streuwert 1.62, horizontal: 1.82, vertikal: 1.39

Unterschrift des Schuetzen

Meyton Elektronik

Ergebnis: **404.3** (386)
 Serien: 101.5 102.4 101.0 99.4
 Zaehler: 27 12 1 0 0 0 0 0 0 0
 Innenzehner: 22
 weiteste: 600 (24), 496 (40), 457 (2)
 beste Teiler 29.1 (4.) 36.8 (11.) 61.3 (25.)
 Trefferlage 0.33 mm links, 0.48 mm hoch
 Streuwert 1.75, horizontal: 2.01, vertikal: 1.43

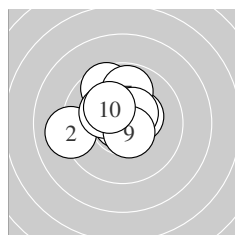
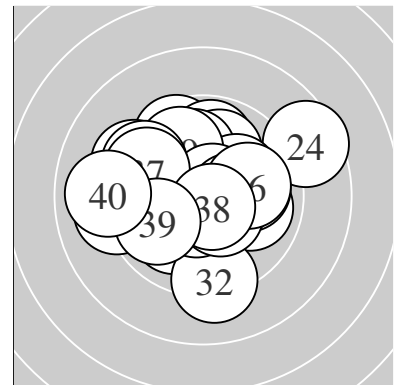

Serie 1:
 9.6 ↖ 9.1 ← 10.3 * 10.8 * 10.2 *
 10.4 * 9.8 ↑ 10.5 * 10.6 * 10.2 *
 beste Teiler 29.1 (4.) 95.2 (9.) 122.3 (8.)
 Trefferlage 0.65 mm links, 0.94 mm hoch
 Streuwert 1.50, horizontal: 1.68, vertikal: 1.29

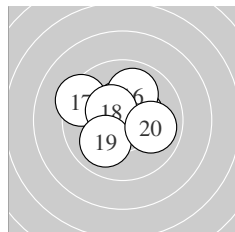

Serie 2:
 10.8 * 10.5 * 10.5 * 10.5 * 10.4 *
 10.0 ↗ 9.4 ↘ 10.4 * 10.0 ↙ 9.9 →
 beste Teiler 36.8 (11.) 110.4 (12.) 118.6 (14.)
 Trefferlage 0.38 mm links, 0.52 mm hoch
 Streuwert 1.44, horizontal: 1.67, vertikal: 1.17

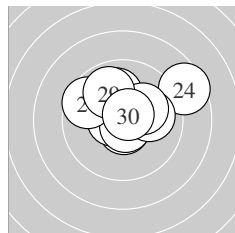

Serie 3:
 10.7 * 10.0 ↑ 10.6 * 8.6 ↗ 10.7 *
 10.0 → 9.6 ↘ 10.2 * 9.9 ↖ 10.7 *
 beste Teiler 61.3 (25.) 68.5 (30.) 75.8 (21.)
 Trefferlage 0.46 mm rechts, 0.94 mm hoch
 Streuwert 1.84, horizontal: 2.28, vertikal: 1.25

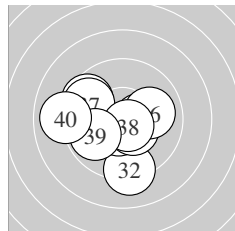

Serie 4:
 9.6 ↘ 9.2 ↓ 10.5 * 10.4 * 10.4 *
 10.0 → 9.7 ↘ 10.7 * 9.9 ↙ 9.0 ←
 beste Teiler 73.8 (38.) 101.8 (33.) 128.6 (35.)
 Trefferlage 0.78 mm links, 0.45 mm tief
 Streuwert 2.07, horizontal: 2.39, vertikal: 1.69

Unterschrift des Schuetzen

Meyton Elektronik

Ergebnis: **416.6** (397)
 Serien: 102.3 102.6 105.1 106.6
 Zaehler: 37 3 0 0 0 0 0 0 0 0
 Innenzehner: 31
 weiteste: 383 (1), 309 (16), 274 (6)
 beste Teiler 5.0 (22.) 20.2 (38.) 39.2 (2.)
 Trefferlage 0.01 mm links, 0.42 mm tief
 Streuwert 1.12, horizontal: 1.25, vertikal: 0.97

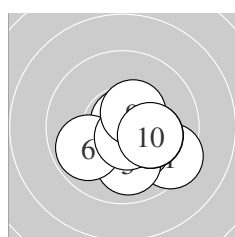
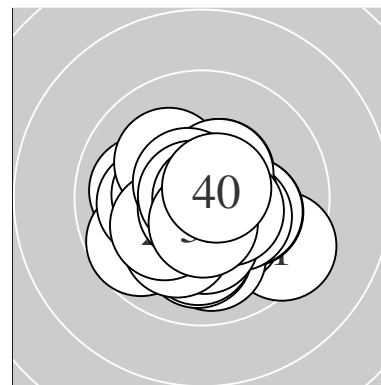

Serie 1:
 9.4 ↘ 10.8 * 10.3 * 10.3 * 10.0 ↓
 9.9 ↙ 10.2 * 10.7 * 10.5 * 10.2 *
 beste Teiler 39.2 (2.) 75.6 (8.) 123.2 (9.)
 Trefferlage 0.88 mm rechts, 0.81 mm tief
 Streuwert 1.28, horizontal: 1.50, vertikal: 1.02

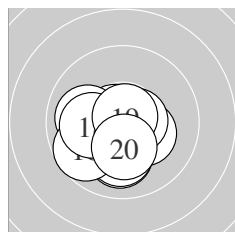

Serie 2:
 10.7 * 10.3 * 10.0 ↓ 10.1 ↓ 10.0 ←
 9.7 ↙ 10.6 * 10.1 ← 10.8 * 10.3 *
 beste Teiler 41.2 (19.) 63.8 (11.) 86.4 (17.)
 Trefferlage 0.53 mm links, 0.78 mm tief
 Streuwert 1.24, horizontal: 1.37, vertikal: 1.10

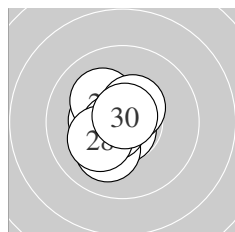

Serie 3:
 10.6 * 10.9 * 10.7 * 10.4 * 10.1 ↙
 10.2 * 10.7 * 10.2 * 10.5 * 10.8 *
 beste Teiler 5.0 (22.) 44.5 (30.) 55.3 (23.)
 Trefferlage 0.59 mm links, 0.04 mm tief
 Streuwert 0.89, horizontal: 0.79, vertikal: 0.98

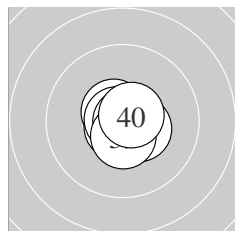

Serie 4:
 10.7 * 10.7 * 10.6 * 10.7 * 10.8 *
 10.5 * 10.5 * 10.9 * 10.5 * 10.7 *
 beste Teiler 20.2 (38.) 40.5 (35.) 56.2 (32.)
 Trefferlage 0.16 mm rechts, 0.07 mm tief
 Streuwert 0.58, horizontal: 0.62, vertikal: 0.54

Unterschrift des Schuetzen

Meyton Elektronik

Ergebnis: **411.2** (395)
 Serien: 103.8 103.6 102.0 101.8
 Zaehler: 35 5 0 0 0 0 0 0 0 0
 Innenzehner: 29
 weiteste: 489 (35), 294 (29), 291 (18)
 beste Teiler 18.4 (8.) 26.9 (16.) 29.0 (15.)
 Trefferlage 0.68 mm rechts, 0.48 mm tief
 Streuwert 1.23, horizontal: 1.36, vertikal: 1.08

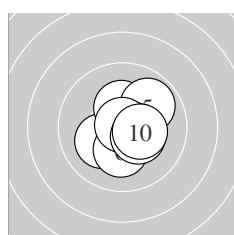
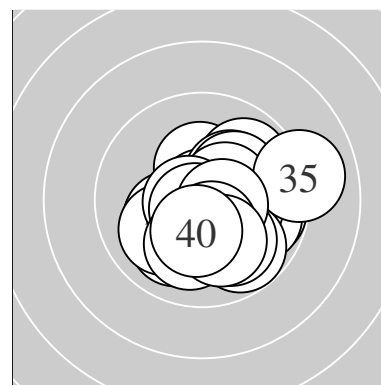

Serie 1:
 10.3 * 10.2 * 10.3 * 10.5 * 9.9 ↗
 10.2 * 10.7 * 10.9 * 10.4 * 10.4 *
 beste Teiler 18.4 (8.) 61.3 (7.) 116.0 (4.)
 Trefferlage 0.57 mm rechts, 0.02 mm tief
 Streuwert 1.12, horizontal: 1.08, vertikal: 1.15

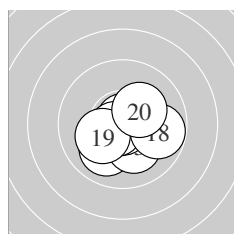

Serie 2:
 10.0 ↙ 10.6 * 10.2 * 10.3 * 10.8 *
 10.8 * 10.7 * 9.8 → 10.2 * 10.2 *
 beste Teiler 26.9 (16.) 29.0 (15.) 70.4 (17.)
 Trefferlage 0.37 mm rechts, 0.39 mm tief
 Streuwert 1.20, horizontal: 1.36, vertikal: 1.03

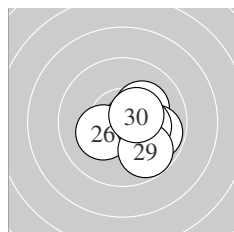

Serie 3:
 10.4 * 10.2 * 10.2 * 10.7 * 10.0 ↘
 10.2 * 9.8 → 10.2 * 9.8 ↘ 10.5 *
 beste Teiler 73.1 (24.) 125.6 (30.) 139.2 (21.)
 Trefferlage 1.28 mm rechts, 0.53 mm tief
 Streuwert 1.06, horizontal: 1.13, vertikal: 0.99

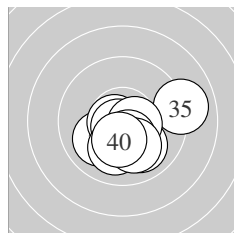

Serie 4:
 10.0 ↙ 10.7 * 10.7 * 10.1 ↓ 9.0 →
 10.0 ↘ 10.5 * 10.4 * 10.1 ↓ 10.3 *
 beste Teiler 57.0 (33.) 66.6 (32.) 101.1 (37.)
 Trefferlage 0.47 mm rechts, 1.00 mm tief
 Streuwert 1.47, horizontal: 1.78, vertikal: 1.06

Unterschrift des Schuetzen

Meyton Elektronik