

Ergebnis: **413.9** (395)  
 Serien: 103.2 103.9 103.2 103.6  
 Zähler: 35 5 0 0 0 0 0 0 0 0  
 Innenzehner: 29  
 weiteste: 315 (21), 290 (36), 287 (3)  
 beste Teiler 22.2 (10.) 29.4 (5.) 43.3 (33.)  
 Trefferlage 0.14 mm rechts, 0.30 mm tief  
 Streuwert 1.18, horizontal: 1.28, vertikal: 1.07

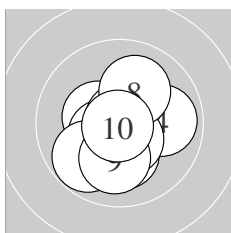

Serie 1:  
 10.4 \*                      10.5 \*                      9.8 ↙                      9.9 →                      10.8 \*  
 10.2 \*                      10.5 \*                      10.1 ↑                      10.1 ↓                      10.9 \*  
 beste Teiler 22.2 (10.) 29.4 (5.) 114.4 (7.)  
 Trefferlage 0.03 mm links, 0.52 mm tief  
 Streuwert 1.31, horizontal: 1.29, vertikal: 1.32

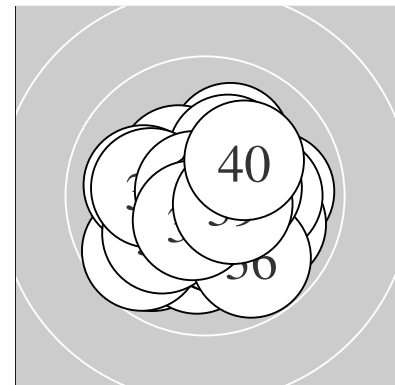
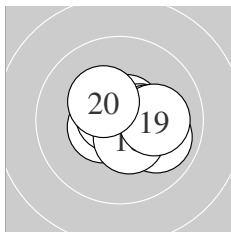

Serie 2:  
 9.9 ↘                      10.5 \*                      10.7 \*                      10.7 \*                      10.7 \*  
 10.4 \*                      10.2 \*                      10.4 \*                      10.1 →                      10.3 \*  
 beste Teiler 55.9 (13.) 58.8 (14.) 73.4 (15.)  
 Trefferlage 0.63 mm rechts, 0.01 mm tief  
 Streuwert 1.01, horizontal: 1.23, vertikal: 0.71

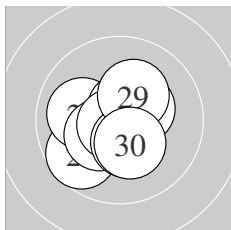

Serie 3:  
 9.7 ↙                      10.0 ←                      10.5 \*                      10.3 \*                      10.7 \*  
 10.7 \*                      10.4 \*                      10.4 \*                      10.2 \*                      10.3 \*  
 beste Teiler 52.1 (26.) 73.3 (25.) 124.2 (23.)  
 Trefferlage 0.26 mm links, 0.38 mm tief  
 Streuwert 1.24, horizontal: 1.30, vertikal: 1.19

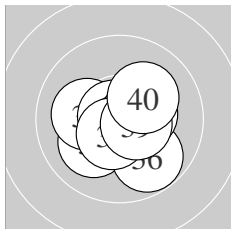

Serie 4:  
 10.1 ↙                      10.1 ←                      10.8 \*                      10.5 \*                      10.7 \*  
 9.8 ↘                      10.5 \*                      10.4 \*                      10.5 \*                      10.2 \*  
 beste Teiler 43.3 (33.) 62.4 (35.) 103.3 (37.)  
 Trefferlage 0.26 mm rechts, 0.30 mm tief  
 Streuwert 1.20, horizontal: 1.34, vertikal: 1.05

Unterschrift des Schützen

Ergebnis: **398.0** (380)  
 Serien: 98.4 98.2 99.0 102.4  
 Zähler: 24 13 2 1 0 0 0 0 0 0  
 Innenzehner: 16  
 weiteste: 787 (25), 537 (13), 511 (6)  
 beste Teiler 53.9 (27.) 80.0 (10.) 80.9 (36.)  
 Trefferlage 1.13 mm links, 0.01 mm tief  
 Streuwert 1.92, horizontal: 2.32, vertikal: 1.41

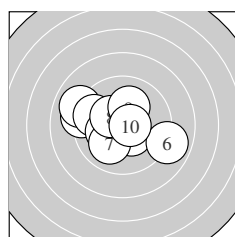
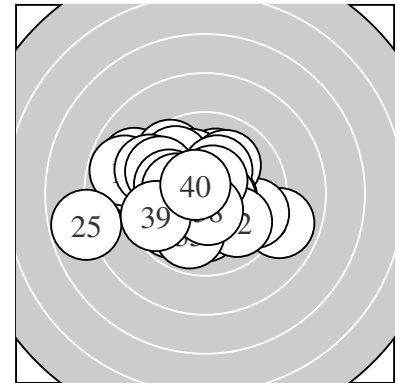

Serie 1:  
 9.2 ↙ 10.4 \* 9.0 ↘ 9.7 ↘ 10.2 \*  
 8.9 ↘ 10.0 ↙ 10.3 \* 10.1 ↗ 10.6 \*  
 beste Teiler 80.0 (10.) 140.9 (2.) 155.2 (8.)  
 Trefferlage 0.91 mm links, 0.12 mm hoch  
 Streuwert 2.24, horizontal: 2.82, vertikal: 1.45

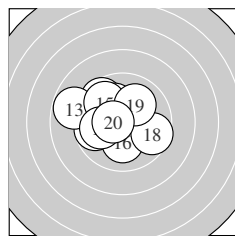

Serie 2:  
 9.6 ↘ 9.7 ← 8.8 ↘ 10.1 ↗ 9.8 ↘  
 10.1 ↓ 10.0 ← 9.6 ↘ 10.0 ↗ 10.5 \*  
 beste Teiler 102.0 (20.) 210.0 (16.) 210.7 (14.)  
 Trefferlage 1.19 mm links, 0.51 mm hoch  
 Streuwert 2.01, horizontal: 2.32, vertikal: 1.64

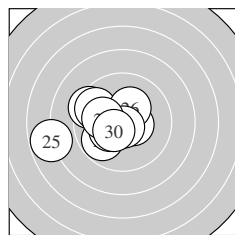

Serie 3:  
 9.8 ↙ 10.5 \* 9.4 ↘ 9.7 ↘ 7.8 ←  
 10.3 \* 10.7 \* 10.3 \* 10.1 ← 10.4 \*  
 beste Teiler 53.9 (27.) 114.4 (22.) 130.1 (30.)  
 Trefferlage 1.86 mm links, 0.15 mm tief  
 Streuwert 2.03, horizontal: 2.54, vertikal: 1.34

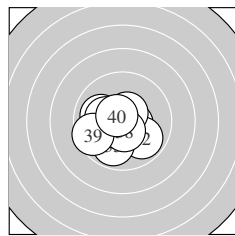

Serie 4:  
 10.5 \* 9.9 ↘ 10.0 ← 10.6 \* 9.9 ↙  
 10.6 \* 10.2 \* 10.5 \* 9.6 ← 10.6 \*  
 beste Teiler 80.9 (36.) 84.8 (40.) 98.0 (34.)  
 Trefferlage 0.55 mm links, 0.53 mm tief  
 Streuwert 1.38, horizontal: 1.58, vertikal: 1.15

Unterschrift des Schützen

Meyton Elektronik

Ergebnis: **401.9** (383)  
 Serien: 101.2 101.1 99.2 100.4  
 Zähler: 24 15 1 0 0 0 0 0 0 0  
 Innenzehner: 18  
 weiteste: 612 (28), 474 (31), 445 (15)  
 beste Teiler 35.2 (6.) 56.4 (36.) 66.7 (5.)  
 Trefferlage 1.14 mm rechts, 0.40 mm tief  
 Streuwert 1.63, horizontal: 2.01, vertikal: 1.14

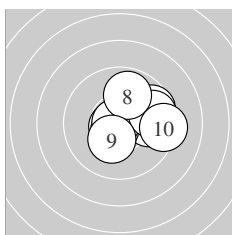
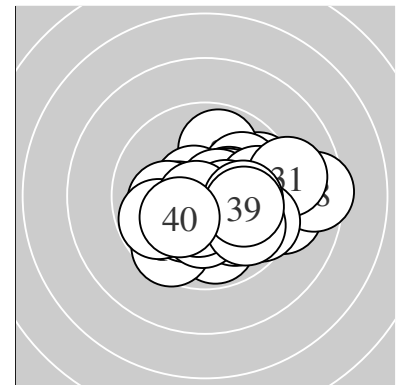

Serie 1:  
 9.9 → 10.7 \* 10.3 \* 9.6 → 10.7 \*  
 10.8 \* 9.7 → 9.9 ↑ 10.3 \* 9.3 →  
 beste Teiler 35.2 (6.) 66.7 (5.) 72.0 (2.)  
 Trefferlage 1.24 mm rechts, 0.33 mm hoch  
 Streuwert 1.53, horizontal: 1.82, vertikal: 1.18

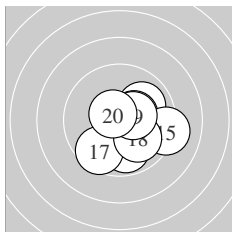

Serie 2:  
 10.5 \* 10.0 ↗ 10.4 \* 9.9 ↓ 9.2 →  
 10.5 \* 9.6 ↙ 10.0 ↘ 10.4 \* 10.6 \*  
 beste Teiler 85.6 (20.) 112.0 (16.) 113.7 (11.)  
 Trefferlage 1.07 mm rechts, 0.61 mm tief  
 Streuwert 1.54, horizontal: 1.64, vertikal: 1.43

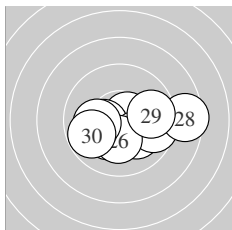

Serie 3:  
 10.2 \* 10.6 \* 10.3 \* 10.1 ↘ 9.6 →  
 10.2 \* 10.1 ← 8.5 → 9.8 → 9.8 ←  
 beste Teiler 81.0 (22.) 154.1 (23.) 180.4 (26.)  
 Trefferlage 0.71 mm rechts, 0.61 mm tief  
 Streuwert 2.05, horizontal: 2.77, vertikal: 0.85

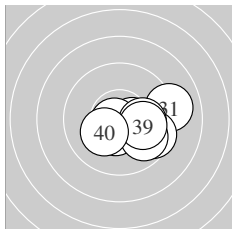

Serie 4:  
 9.1 → 10.5 \* 9.6 ↘ 10.5 \* 9.9 ↘  
 10.7 \* 9.8 ↘ 10.1 → 10.0 → 10.2 \*  
 beste Teiler 56.4 (36.) 119.2 (34.) 123.6 (32.)  
 Trefferlage 1.53 mm rechts, 0.71 mm tief  
 Streuwert 1.42, horizontal: 1.84, vertikal: 0.83

Unterschrift des Schützen

Ergebnis: **414.2** (395)  
 Serien: 103.3 105.3 104.3 101.3  
 Zähler: 35 5 0 0 0 0 0 0 0 0  
 Innenzehner: 29  
 weiteste: 332 (35), 289 (17), 258 (6)  
 beste Teiler 17.2 (11.) 19.7 (15.) 26.2 (19.)  
 Trefferlage 0.12 mm rechts, 0.19 mm tief  
 Streuwert 1.19, horizontal: 1.27, vertikal: 1.11

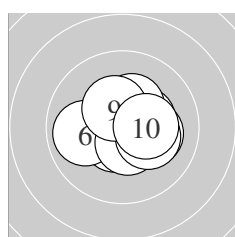
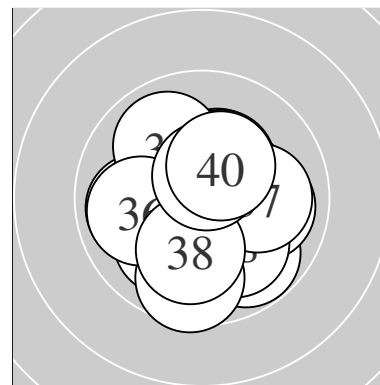

Serie 1:  
 10.2 \*                      10.4 \*                      10.3 \*                      10.5 \*                      10.6 \*  
 9.9 ←                      10.5 \*                      10.2 \*                      10.4 \*                      10.3 \*  
 beste Teiler 99.8 (5.) 110.6 (7.) 116.2 (4.)  
 Trefferlage 0.28 mm rechts, 0.00 mm  
 Streuwert 1.20, horizontal: 1.47, vertikal: 0.86

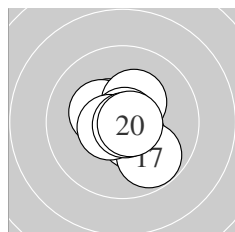

Serie 2:  
 10.9 \*                      10.5 \*                      10.3 \*                      10.3 \*                      10.9 \*  
 10.5 \*                      9.8 ↘                      10.6 \*                      10.8 \*                      10.7 \*  
 beste Teiler 17.2 (11.) 19.7 (15.) 26.2 (19.)  
 Trefferlage 0.07 mm rechts, 0.11 mm tief  
 Streuwert 0.99, horizontal: 0.97, vertikal: 1.00

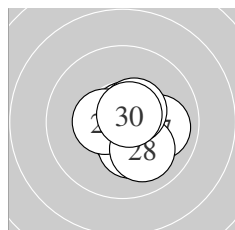

Serie 3:  
 10.6 \*                      10.7 \*                      10.7 \*                      10.3 \*                      10.5 \*  
 10.3 \*                      10.0 →                      10.0 ↘                      10.5 \*                      10.7 \*  
 beste Teiler 55.9 (22.) 60.8 (23.) 69.4 (30.)  
 Trefferlage 0.68 mm rechts, 0.34 mm tief  
 Streuwert 0.94, horizontal: 1.00, vertikal: 0.87

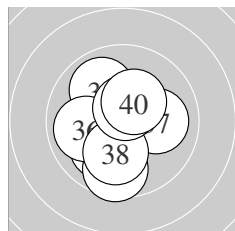

Serie 4:  
 10.7 \*                      10.1 ←                      9.9 ↘                      10.1 ✓                      9.6 ↓  
 9.9 ←                      10.0 →                      10.1 ↓                      10.6 \*                      10.3 \*  
 beste Teiler 58.9 (31.) 92.9 (39.) 152.8 (40.)  
 Trefferlage 0.56 mm links, 0.34 mm tief  
 Streuwert 1.54, horizontal: 1.41, vertikal: 1.66

Unterschrift des Schützen

Meyton Elektronik

Ergebnis: **410.3** (392)  
 Serien: 102.1 103.1 103.2 101.9  
 Zähler: 32 8 0 0 0 0 0 0 0 0  
 Innenzehner: 27  
 weiteste: 375 (29), 348 (2), 348 (34)  
 beste Teiler 10.2 (13.) 44.2 (15.) 46.3 (39.)  
 Trefferlage 0.01 mm links, 0.27 mm tief  
 Streuwert 1.38, horizontal: 1.70, vertikal: 0.96

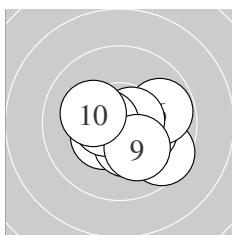
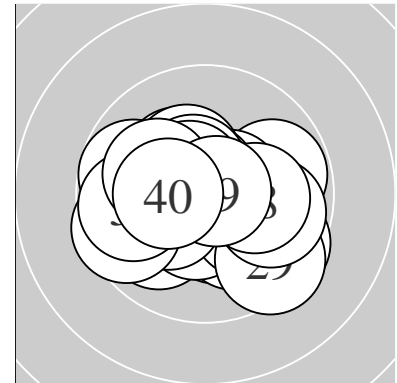

Serie 1:  
 10.2 \* 9.6 ↘ 10.4 \* 10.4 \* 10.2 \*  
 9.8 → 10.6 \* 10.6 \* 10.1 ↘ 10.2 \*  
 beste Teiler 83.4 (7.) 92.0 (8.) 140.7 (3.)  
 Trefferlage 0.79 mm rechts, 0.49 mm tief  
 Streuwert 1.33, horizontal: 1.62, vertikal: 0.97

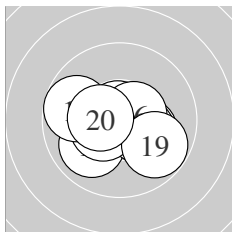

Serie 2:  
 10.2 \* 10.0 ↙ 10.9 \* 10.3 \* 10.8 \*  
 10.5 \* 10.5 \* 9.7 ← 9.8 ↘ 10.4 \*  
 beste Teiler 10.2 (13.) 44.2 (15.) 102.8 (16.)  
 Trefferlage 0.07 mm links, 0.36 mm tief  
 Streuwert 1.35, horizontal: 1.72, vertikal: 0.85

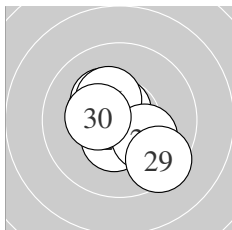

Serie 3:  
 10.4 \* 10.6 \* 10.5 \* 10.3 \* 10.7 \*  
 10.3 \* 10.4 \* 10.1 ↘ 9.5 ↘ 10.4 \*  
 beste Teiler 64.7 (25.) 89.5 (22.) 115.1 (23.)  
 Trefferlage 0.09 mm links, 0.16 mm tief  
 Streuwert 1.33, horizontal: 1.37, vertikal: 1.29

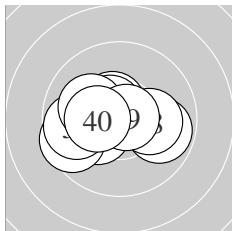

Serie 4:  
 10.3 \* 10.5 \* 10.6 \* 9.6 ← 9.8 ←  
 9.8 → 10.1 ← 10.1 → 10.8 \* 10.3 \*  
 beste Teiler 46.3 (39.) 97.0 (33.) 109.5 (32.)  
 Trefferlage 0.70 mm links, 0.09 mm tief  
 Streuwert 1.49, horizontal: 1.95, vertikal: 0.78

Unterschrift des Schützen

Meyton Elektronik

Ergebnis: **390.3** (373)  
 Serien: 95.2 99.3 99.6 96.2  
 Zähler: 21 13 5 0 1 0 0 0 0 0  
 Innenzehner: 14  
 weiteste: 1117 (31), 706 (35), 635 (15)  
 beste Teiler 44.9 (21.) 52.8 (34.) 79.6 (14.)  
 Trefferlage 0.76 mm rechts, 0.19 mm tief  
 Streuwert 2.53, horizontal: 2.30, vertikal: 2.74

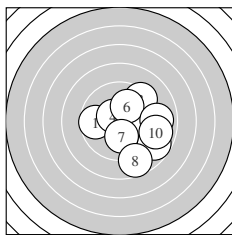
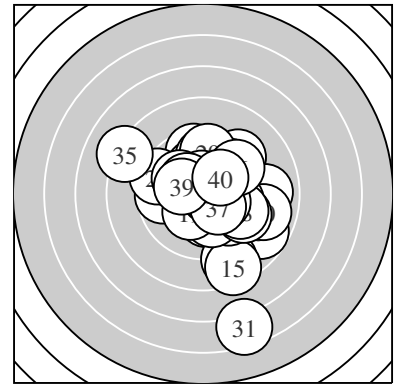

Serie 1:  
 9.7 ←                      10.1 ↘                      9.3 ↗                      10.5 \*                      8.8 ↘  
 10.1 ↗                      10.1 ↓                      8.7 ↓                      9.0 →                      8.9 →  
 beste Teiler 109.4 (4.) 203.6 (7.) 212.8 (2.)  
 Trefferlage 1.82 mm rechts, 0.73 mm tief  
 Streuwert 2.53, horizontal: 2.66, vertikal: 2.40

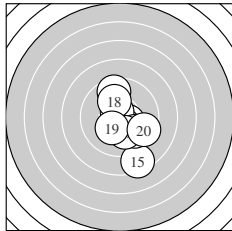

Serie 2:  
 10.5 \*                      9.6 ↑                      10.5 \*                      10.6 \*                      8.4 ↓  
 9.8 ↘                      10.1 ↓                      10.1 ↑                      10.2 \*                      9.5 ↘  
 beste Teiler 79.6 (14.) 118.9 (13.) 124.7 (11.)  
 Trefferlage 0.72 mm rechts, 0.83 mm tief  
 Streuwert 2.08, horizontal: 1.47, vertikal: 2.54

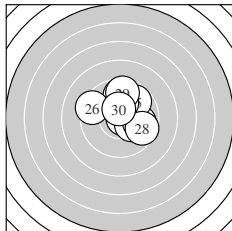

Serie 3:  
 10.8 \*                      10.2 \*                      9.7 ↑                      9.9 →                      9.8 ↗  
 9.4 ←                      10.1 ↑                      9.6 ↘                      9.6 ↑                      10.5 \*  
 beste Teiler 44.9 (21.) 123.4 (30.) 180.9 (22.)  
 Trefferlage 0.66 mm rechts, 1.03 mm hoch  
 Streuwert 1.78, horizontal: 1.89, vertikal: 1.67

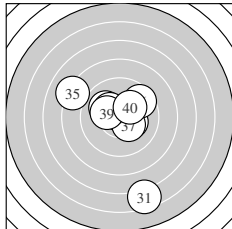

Serie 4:  
 6.5 ↓                      10.0 ↖                      10.3 \*                      10.7 \*                      8.1 ↖  
 9.6 ↗                      10.3 \*                      10.3 \*                      10.2 \*                      10.2 \*  
 beste Teiler 52.8 (34.) 157.4 (37.) 165.8 (38.)  
 Trefferlage 0.12 mm links, 0.23 mm tief  
 Streuwert 3.38, horizontal: 2.82, vertikal: 3.86

Unterschrift des Schützen

Meyton Elektronik

Ergebnis: **412.1** (395)  
 Serien: 102.2 103.3 102.9 103.7  
 Zähler: 35 5 0 0 0 0 0 0 0 0  
 Innenzehner: 28  
 weiteste: 381 (11), 346 (6), 300 (28)  
 beste Teiler 11.0 (34.) 11.7 (13.) 25.7 (32.)  
 Trefferlage 0.02 mm links, 0.03 mm tief  
 Streuwert 1.33, horizontal: 1.55, vertikal: 1.06

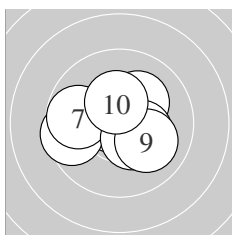
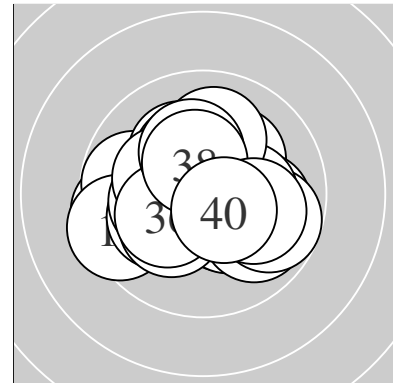

Serie 1:  
 10.2 \*                      10.3 \*                      10.5 \*                      10.3 \*                      10.7 \*  
 9.6 ←                      9.8 ←                      10.4 \*                      10.0 ↘                      10.4 \*  
 beste Teiler 58.8 (5.) 109.5 (3.) 138.4 (8.)  
 Trefferlage 0.10 mm links, 0.04 mm tief  
 Streuwert 1.50, horizontal: 1.87, vertikal: 1.01

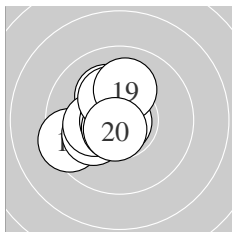

Serie 2:  
 9.4 ←                      10.1 ←                      10.9 \*                      10.2 \*                      10.2 \*  
 10.7 \*                      10.7 \*                      10.3 \*                      10.1 ↑                      10.7 \*  
 beste Teiler 11.7 (13.) 59.4 (16.) 70.1 (17.)  
 Trefferlage 0.97 mm links, 0.13 mm hoch  
 Streuwert 1.19, horizontal: 1.14, vertikal: 1.23

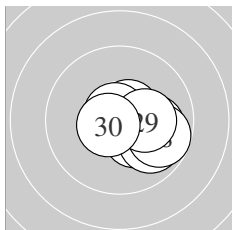

Serie 3:  
 10.3 \*                      10.7 \*                      10.6 \*                      10.0 ↘                      9.9 ↘  
 10.0 →                      10.8 \*                      9.8 ↘                      10.2 \*                      10.6 \*  
 beste Teiler 50.6 (27.) 60.0 (22.) 86.9 (23.)  
 Trefferlage 1.12 mm rechts, 0.48 mm tief  
 Streuwert 1.07, horizontal: 1.33, vertikal: 0.72

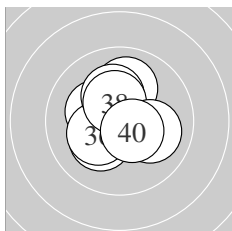

Serie 4:  
 10.0 ↑                      10.9 \*                      10.3 \*                      10.9 \*                      10.2 \*  
 10.3 \*                      10.2 \*                      10.4 \*                      10.0 →                      10.5 \*  
 beste Teiler 11.0 (34.) 25.7 (32.) 112.6 (40.)  
 Trefferlage 0.15 mm links, 0.25 mm hoch  
 Streuwert 1.20, horizontal: 1.18, vertikal: 1.22

Unterschrift des Schützen

Meyton Elektronik

Ergebnis:	<b>409.5</b>	(390)
Serien:	104.2	100.8 102.6 101.9
Zähler:	30	10 0 0 0 0 0 0 0 0
Innenzehner:	26	
weiteste:	414	(19), 345 (17), 299 (14)
beste Teiler	35.4	(1.) 42.7 (6.) 54.7 (27.)
Trefferlage	0.42 mm	rechts, 0.62 mm hoch
Streuwert	1.32,	horizontal: 1.48, vertikal: 1.13

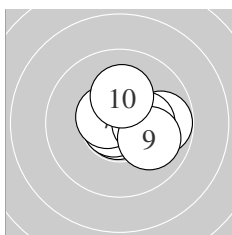
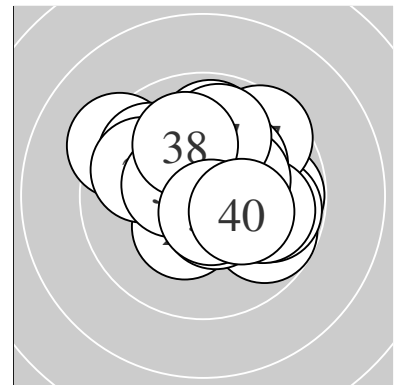

Serie 1:	10.8 *	10.5 *	9.8 →	10.5 *	10.7 *
	10.8 *	10.6 *	10.3 *	10.0 ↘	10.2 *
beste Teiler	35.4	(1.) 42.7 (6.)	64.4 (5.)		
Trefferlage	0.61 mm	rechts, 0.24 mm	hoch		
Streuwert	1.05,	horizontal: 1.25,	vertikal: 0.80		

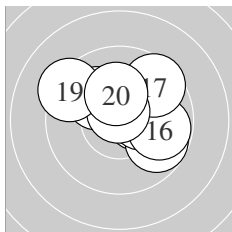

Serie 2:	10.1 ↖	10.4 *	10.6 *	9.8 ↘	10.3 *
	9.8 →	9.6 ↗	10.7 *	9.3 ↖	10.2 *
beste Teiler	62.8	(18.) 94.8 (13.)	129.1 (12.)		
Trefferlage	0.59 mm	rechts, 0.73 mm	hoch		
Streuwert	1.69,	horizontal: 2.03,	vertikal: 1.26		

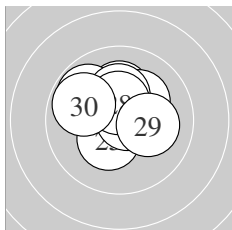

Serie 3:	10.2 *	9.8 ↖	10.7 *	10.2 *	10.3 *
	10.3 *	10.7 *	10.5 *	10.1 →	9.8 ↖
beste Teiler	54.7	(27.) 73.4 (23.)	122.3 (28.)		
Trefferlage	0.21 mm	links, 0.81 mm	hoch		
Streuwert	1.24,	horizontal: 1.41,	vertikal: 1.05		

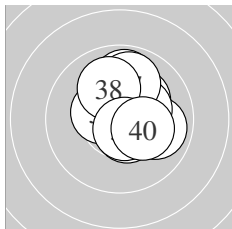

Serie 4:	10.2 *	10.5 *	9.9 →	10.3 *	10.4 *
	9.9 ↑	9.9 ↑	10.0 ↖	10.6 *	10.2 *
beste Teiler	78.2	(39.) 101.8 (32.)	132.0 (35.)		
Trefferlage	0.69 mm	rechts, 0.70 mm	hoch		
Streuwert	1.28,	horizontal: 1.13,	vertikal: 1.41		

Unterschrift des Schützen

Meyton Elektronik



Ergebnis: **414.1** (396)  
 Serien: 103.7 103.7 103.8 102.9  
 Zähler: 36 4 0 0 0 0 0 0 0 0  
 Innenzehner: 26  
 weiteste: 383 (15), 293 (23), 259 (34)  
 beste Teiler 7.6 (29.) 15.6 (33.) 27.2 (19.)  
 Trefferlage 0.09 mm links, 0.00 mm  
 Streuwert 1.25, horizontal: 1.57, vertikal: 0.80

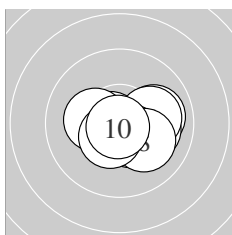
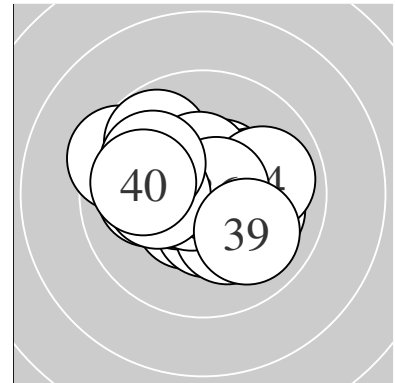

Serie 1:  
 10.6 \* 10.0 → 10.1 → 10.7 \* 10.3 \*  
 10.1 → 10.5 \* 10.1 ↘ 10.5 \* 10.8 \*  
 beste Teiler 29.9 (10.) 63.0 (4.) 93.7 (1.)  
 Trefferlage 0.53 mm rechts, 0.34 mm tief  
 Streuwert 1.12, horizontal: 1.48, vertikal: 0.59

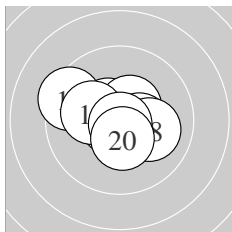

Serie 2:  
 10.7 \* 10.5 \* 10.5 \* 10.7 \* 9.4 ↖  
 10.4 \* 10.2 \* 10.1 → 10.8 \* 10.4 \*  
 beste Teiler 27.2 (19.) 62.6 (11.) 75.6 (14.)  
 Trefferlage 0.19 mm links, 0.04 mm hoch  
 Streuwert 1.30, horizontal: 1.63, vertikal: 0.86

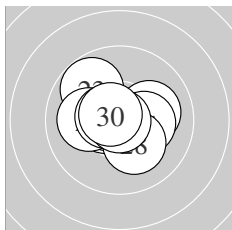

Serie 3:  
 10.1 → 10.5 \* 9.8 ↖ 10.3 \* 10.7 \*  
 10.1 ← 10.6 \* 10.2 \* 10.9 \* 10.6 \*  
 beste Teiler 7.6 (29.) 70.1 (25.) 76.3 (30.)  
 Trefferlage 0.26 mm links, 0.14 mm hoch  
 Streuwert 1.22, horizontal: 1.46, vertikal: 0.92

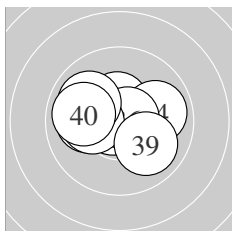

Serie 4:  
 10.0 ← 10.5 \* 10.9 \* 9.9 → 10.8 \*  
 10.7 \* 10.2 \* 10.0 ↖ 10.0 ↘ 9.9 ←  
 beste Teiler 15.6 (33.) 50.5 (35.) 58.5 (36.)  
 Trefferlage 0.46 mm links, 0.18 mm hoch  
 Streuwert 1.38, horizontal: 1.77, vertikal: 0.83

Unterschrift des Schützen

Meyton Elektronik

Ergebnis: **404.5** (387)  
 Serien: 101.8 99.2 100.6 102.9  
 Zähler: 28 11 1 0 0 0 0 0 0 0  
 Innenzehner: 21  
 weiteste: 554 (27), 462 (11), 344 (12)  
 beste Teiler 11.6 (33.) 33.0 (5.) 76.7 (36.)  
 Trefferlage 0.03 mm links, 0.23 mm hoch  
 Streuwert 1.67, horizontal: 2.00, vertikal: 1.26

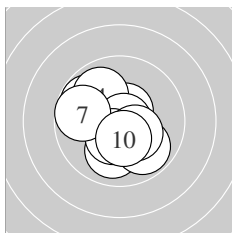
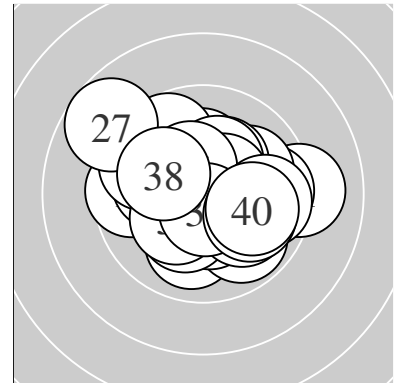

Serie 1:  
 9.8 ↘ 10.0 ↓ 10.6 \* 9.9 ↘ 10.8 \*  
 10.4 \* 9.7 ← 9.9 ↘ 10.3 \* 10.4 \*  
 beste Teiler 33.0 (5.) 94.0 (3.) 135.2 (6.)  
 Trefferlage 0.39 mm links, 0.29 mm tief  
 Streuwert 1.54, horizontal: 1.56, vertikal: 1.52

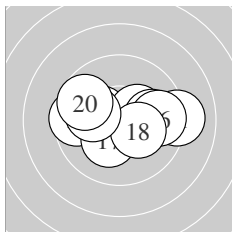

Serie 2:  
 9.1 → 9.6 ← 10.3 \* 10.3 \* 9.9 →  
 9.7 → 10.2 \* 10.3 \* 10.1 ← 9.7 ↘  
 beste Teiler 154.4 (14.) 160.3 (13.) 169.5 (18.)  
 Trefferlage 0.24 mm rechts, 0.14 mm hoch  
 Streuwert 2.03, horizontal: 2.76, vertikal: 0.81

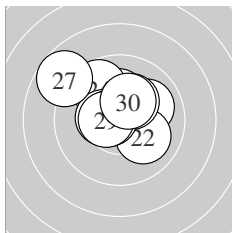

Serie 3:  
 10.0 → 10.0 ↘ 10.2 \* 9.7 ↘ 10.2 \*  
 10.4 \* 8.7 ↘ 10.6 \* 10.5 \* 10.3 \*  
 beste Teiler 82.3 (28.) 108.1 (29.) 133.5 (26.)  
 Trefferlage 0.37 mm links, 1.10 mm hoch  
 Streuwert 1.68, horizontal: 1.95, vertikal: 1.36

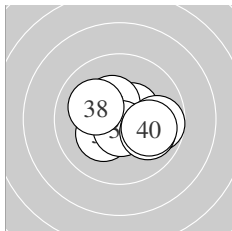

Serie 4:  
 10.4 \* 10.3 \* 10.9 \* 10.5 \* 10.4 \*  
 10.6 \* 9.7 → 10.1 ↘ 10.0 ↘ 10.0 →  
 beste Teiler 11.6 (33.) 76.7 (36.) 117.0 (34.)  
 Trefferlage 0.36 mm rechts, 0.02 mm tief  
 Streuwert 1.37, horizontal: 1.71, vertikal: 0.90

Unterschrift des Schützen

Meyton Elektronik

Ergebnis: **395.6** (378)  
 Serien: 99.9 100.9 97.9 96.9  
 Zähler: 20 18 2 0 0 0 0 0 0 0  
 Innenzehner: 15  
 weiteste: 692 (36), 667 (32), 475 (28)  
 beste Teiler 50.4 (12.) 50.9 (18.) 83.5 (25.)  
 Trefferlage 1.20 mm rechts, 0.03 mm tief  
 Streuwert 2.03, horizontal: 2.45, vertikal: 1.49

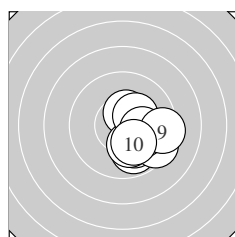
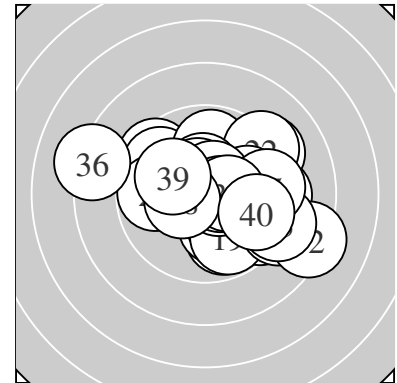

Serie 1:  
 9.9 ↘ 10.0 ↘ 10.4 \* 10.1 ↘ 10.3 \*  
 9.4 ↘ 10.1 ↘ 10.2 \* 9.4 → 10.1 ↘  
 beste Teiler 126.3 (3.) 156.6 (5.) 198.7 (8.)  
 Trefferlage 1.65 mm rechts, 0.98 mm tief  
 Streuwert 1.21, horizontal: 1.14, vertikal: 1.28

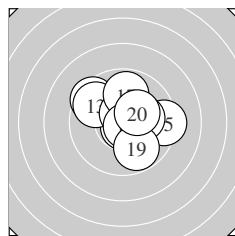

Serie 2:  
 9.5 ↘ 10.8 \* 9.7 ↘ 10.6 \* 9.3 →  
 10.2 \* 9.9 ↑ 10.8 \* 9.8 ↘ 10.3 \*  
 beste Teiler 50.4 (12.) 50.9 (18.) 87.1 (14.)  
 Trefferlage 0.39 mm rechts, 0.53 mm hoch  
 Streuwert 1.81, horizontal: 2.06, vertikal: 1.52

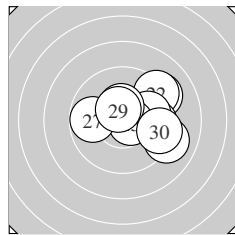

Serie 3:  
 9.2 ↗ 9.3 ↗ 9.7 → 9.9 → 10.6 \*  
 10.4 \* 9.8 ← 9.1 ↘ 10.5 \* 9.4 →  
 beste Teiler 83.5 (25.) 113.4 (29.) 135.7 (26.)  
 Trefferlage 1.78 mm rechts, 0.46 mm hoch  
 Streuwert 1.96, horizontal: 2.35, vertikal: 1.46

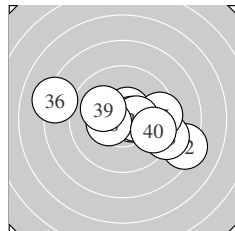

Serie 4:  
 10.6 \* 8.3 ↘ 9.1 ↘ 10.6 \* 9.5 →  
 8.2 ← 10.4 \* 10.4 \* 10.1 ↘ 9.7 →  
 beste Teiler 91.0 (34.) 100.1 (31.) 135.0 (37.)  
 Trefferlage 0.99 mm rechts, 0.16 mm tief  
 Streuwert 2.77, horizontal: 3.68, vertikal: 1.37

Unterschrift des Schützen

Meyton Elektronik

Ergebnis: **420.8** (399)  
 Serien: 104.9 104.3 106.2 105.4  
 Zähler: 39 1 0 0 0 0 0 0 0 0  
 Innenzehner: 38  
 weiteste: 264 (33), 216 (4), 189 (15)  
 beste Teiler 3.6 (22.) 40.0 (26.) 44.5 (1.)  
 Trefferlage 0.13 mm rechts, 0.03 mm hoch  
 Streuwert 0.86, horizontal: 0.89, vertikal: 0.82

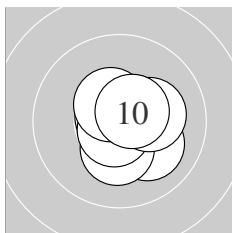
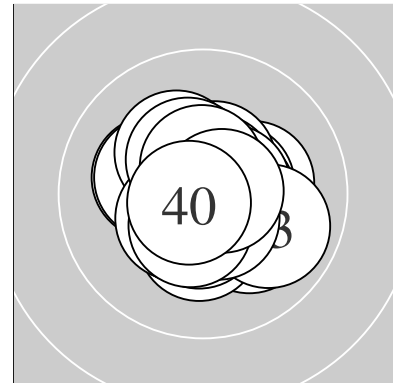

Serie 1:  
 10.8 \*                      10.6 \*                      10.4 \*                      10.1 ↘                      10.3 \*  
 10.7 \*                      10.7 \*                      10.5 \*                      10.2 \*                      10.6 \*  
 beste Teiler 44.5 (1.) 53.3 (6.) 61.0 (7.)  
 Trefferlage 0.40 mm rechts, 0.15 mm tief  
 Streuwert 0.90, horizontal: 0.84, vertikal: 0.95

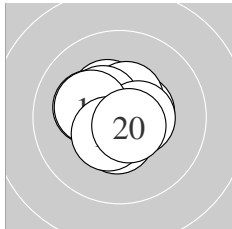

Serie 2:  
 10.5 \*                      10.4 \*                      10.5 \*                      10.5 \*                      10.2 \*  
 10.4 \*                      10.5 \*                      10.2 \*                      10.5 \*                      10.6 \*  
 beste Teiler 76.4 (20.) 112.1 (17.) 112.6 (13.)  
 Trefferlage 0.29 mm links, 0.19 mm hoch  
 Streuwert 0.97, horizontal: 1.07, vertikal: 0.86

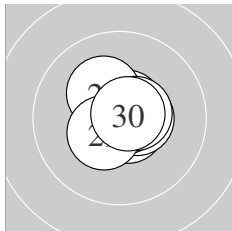

Serie 3:  
 10.7 \*                      10.9 \*                      10.6 \*                      10.8 \*                      10.5 \*  
 10.8 \*                      10.2 \*                      10.6 \*                      10.4 \*                      10.7 \*  
 beste Teiler 3.6 (22.) 40.0 (26.) 50.0 (24.)  
 Trefferlage 0.14 mm rechts, 0.14 mm hoch  
 Streuwert 0.68, horizontal: 0.72, vertikal: 0.64

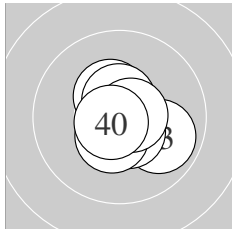

Serie 4:  
 10.7 \*                      10.6 \*                      9.9 ↘                      10.8 \*                      10.5 \*  
 10.5 \*                      10.4 \*                      10.6 \*                      10.7 \*                      10.7 \*  
 beste Teiler 45.2 (34.) 60.2 (40.) 68.8 (39.)  
 Trefferlage 0.29 mm rechts, 0.06 mm tief  
 Streuwert 0.87, horizontal: 0.87, vertikal: 0.87

Unterschrift des Schützen

Meyton Elektronik

Ergebnis: **395.4** (379)  
 Serien: 97.1 98.3 101.5 98.5  
 Zähler: 21 17 2 0 0 0 0 0 0 0  
 Innenzehner: 16  
 weiteste: 726 (20), 634 (7), 490 (6)  
 beste Teiler 36.1 (25.) 53.2 (17.) 68.6 (27.)  
 Trefferlage 0.28 mm links, 0.06 mm tief  
 Streuwert 2.20, horizontal: 2.30, vertikal: 2.09

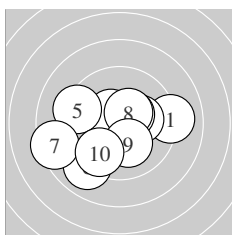
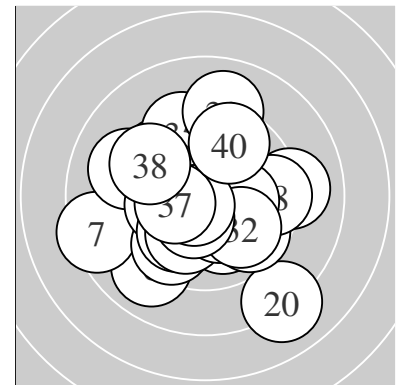

Serie 1:  
 9.1 → 10.2 \* 10.5 \* 10.4 \* 9.3 ↖  
 9.0 ↙ 8.4 ← 10.4 \* 10.2 \* 9.6 ↘  
 beste Teiler 121.0 (3.) 127.7 (8.) 127.9 (4.)  
 Trefferlage 0.64 mm links, 0.57 mm tief  
 Streuwert 2.57, horizontal: 3.13, vertikal: 1.86

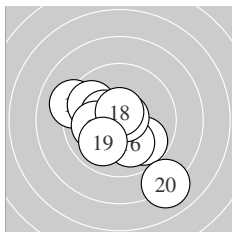

Serie 2:  
 9.1 ↖ 9.8 ↖ 9.8 ↘ 10.4 \* 10.0 ←  
 10.0 ↓ 10.7 \* 10.6 \* 9.9 ↙ 8.0 ↓  
 beste Teiler 53.2 (17.) 77.0 (18.) 150.0 (14.)  
 Trefferlage 0.41 mm links, 0.79 mm tief  
 Streuwert 2.39, horizontal: 2.51, vertikal: 2.25

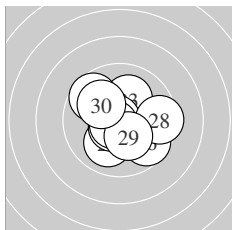

Serie 3:  
 10.0 ↙ 10.6 \* 10.1 ↑ 9.7 ↖ 10.8 \*  
 9.7 ↘ 10.7 \* 9.5 → 10.3 \* 10.1 ↖  
 beste Teiler 36.1 (25.) 68.6 (27.) 92.6 (22.)  
 Trefferlage 0.10 mm rechts, 0.09 mm tief  
 Streuwert 1.72, horizontal: 1.88, vertikal: 1.54

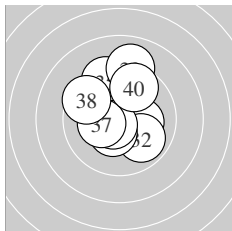

Serie 4:  
 10.2 \* 9.9 ↘ 10.4 \* 9.5 ↑ 9.4 ↑  
 10.6 \* 10.3 \* 9.5 ↖ 9.0 ↑ 9.7 ↑  
 beste Teiler 80.0 (36.) 136.8 (33.) 171.7 (37.)  
 Trefferlage 0.20 mm links, 1.21 mm hoch  
 Streuwert 2.02, horizontal: 1.68, vertikal: 2.31

Unterschrift des Schützen

Meyton Elektronik

Ergebnis: **406.1** (388)  
 Serien: 99.3 101.7 102.4 102.7  
 Zähler: 28 12 0 0 0 0 0 0 0 0  
 Innenzehner: 19  
 weiteste: 454 (9), 389 (33), 368 (1)  
 beste Teiler 30.2 (11.) 44.6 (25.) 53.6 (16.)  
 Trefferlage 0.23 mm rechts, 0.23 mm hoch  
 Streuwert 1.59, horizontal: 1.62, vertikal: 1.55

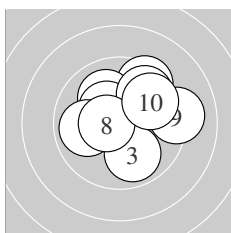
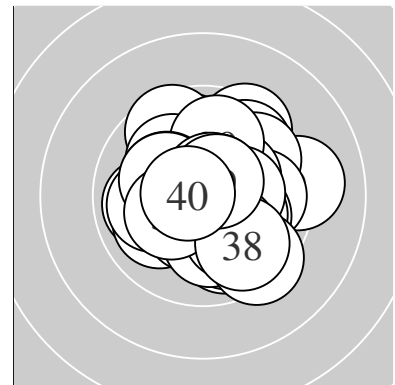

Serie 1:  
 9.5 ↗ 10.0 ↖ 9.9 ↘ 10.5 \* 10.4 \*  
 9.9 ← 9.7 ↗ 10.5 \* 9.1 → 9.8 ↗  
 beste Teiler 103.0 (8.) 118.9 (4.) 149.2 (5.)  
 Trefferlage 0.50 mm rechts, 0.82 mm hoch  
 Streuwert 1.92, horizontal: 2.21, vertikal: 1.59

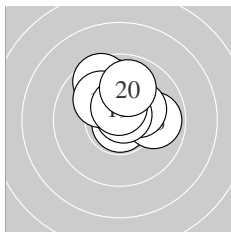

Serie 2:  
 10.8 \* 10.0 ↖ 9.9 → 10.3 \* 9.9 ↑  
 10.7 \* 9.6 ↖ 10.1 ↖ 10.5 \* 9.9 ↑  
 beste Teiler 30.2 (11.) 53.6 (16.) 104.1 (19.)  
 Trefferlage 0.08 mm rechts, 1.40 mm hoch  
 Streuwert 1.23, horizontal: 1.30, vertikal: 1.17

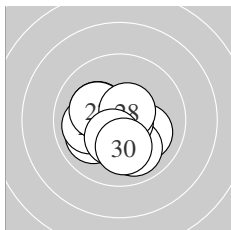

Serie 3:  
 10.0 ← 10.1 ↘ 10.0 ↘ 10.2 \* 10.8 \*  
 10.0 ← 10.2 \* 10.6 \* 10.4 \* 10.1 ↓  
 beste Teiler 44.6 (25.) 92.9 (28.) 147.6 (29.)  
 Trefferlage 0.40 mm links, 0.60 mm tief  
 Streuwert 1.33, horizontal: 1.50, vertikal: 1.14

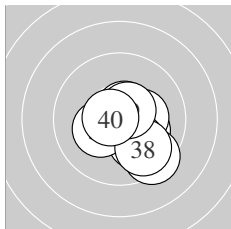

Serie 4:  
 10.7 \* 10.2 \* 9.4 ↘ 10.3 \* 10.6 \*  
 10.1 ↘ 10.3 \* 9.8 ↘ 10.6 \* 10.7 \*  
 beste Teiler 56.0 (31.) 73.9 (40.) 84.5 (35.)  
 Trefferlage 0.73 mm rechts, 0.69 mm tief  
 Streuwert 1.30, horizontal: 1.33, vertikal: 1.27

Unterschrift des Schützen