

Ergebnis: **411.4** (395)
 Serien: 103.4 102.0 105.1 100.9
 Zähler: 35 5 0 0 0 0 0 0 0 0
 Innenzehner: 28
 Weitesten: 411 (33.), 363 (18.), 330 (38.)
 beste Teiler: 23.0 (26.), 29.5 (1.), 40.2 (27.)
 Trefferlage: 0.41 mm links, 0.09 mm hoch
 Streuwert: 1.32, horizontal: 1.46, vertikal: 1.17

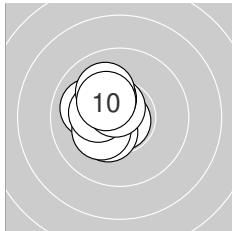
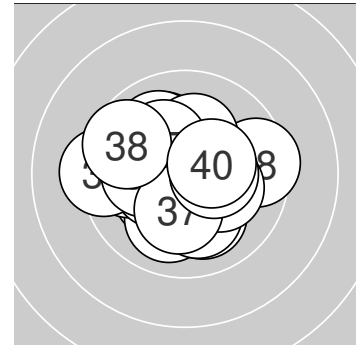

Serie 1:

10.8 * 10.4 * 10.0 ←
 10.3 * 10.6 * 10.3 *

10.3 * 10.3 *
 10.1 ↘ 10.3 *

beste Teiler: 29.5 (1.), 79.8 (7.), 143.4 (2.)
 Trefferlage: 1.07 mm links, 0.49 mm hoch
 Streuwert: 0.86, horizontal: 0.66, vertikal: 1.01

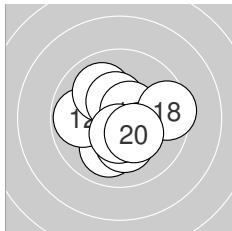

Serie 2:

10.0 ↓ 9.8 ← 10.7 *
 10.6 * 10.2 * 9.5 →

10.0 ↘ 10.4 *
 10.5 * 10.3 *

beste Teiler: 72.9 (13.), 93.6 (16.), 117.2 (19.)
 Trefferlage: 0.09 mm rechts, 0.14 mm tief
 Streuwert: 1.54, horizontal: 1.68, vertikal: 1.39

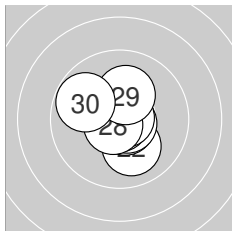

Serie 3:

10.7 * 10.1 ↓ 10.7 *
 10.9 * 10.8 * 10.7 *

10.5 * 10.7 *
 10.2 * 9.8 ↘

beste Teiler: 23.0 (26.), 40.2 (27.), 54.5 (21.)
 Trefferlage: 0.02 mm links, 0.14 mm hoch
 Streuwert: 1.06, horizontal: 0.98, vertikal: 1.13

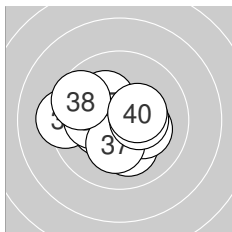

Serie 4:

10.1 ↓ 10.4 * 9.3 ←
 10.2 * 10.2 * 9.6 ↘

10.1 ← 10.2 *
 10.4 * 10.4 *

beste Teiler: 145.3 (40.), 147.0 (39.), 149.8 (32.)
 Trefferlage: 0.66 mm links, 0.12 mm tief
 Streuwert: 1.64, horizontal: 2.00, vertikal: 1.19



Ergebnis: **415.0** (396)
 Serien: 104.0 103.7 103.0 104.3
 Zähler: 36 4 0 0 0 0 0 0 0
 Innenzehner: 32
 Weitester: 306 (30.), 301 (24.), 273 (10.)
 beste Teiler: 35.3 (38.), 44.2 (20.), 46.0 (7.)
 Trefferlage: 0.09 mm rechts, 0.38 mm tief
 Streuwert: 1.12, horizontal: 1.13, vertikal: 1.12

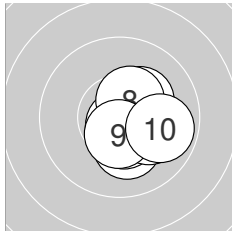
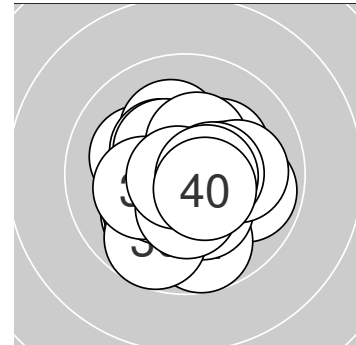

Serie 1:

10.2 *	10.5 *	10.3 *	10.7 *	10.6 *
10.1 ↘	10.8 *	10.4 *	10.5 *	9.9 →

beste Teiler: 46.0 (7.), 74.0 (4.), 93.3 (5.)
 Trefferlage: 0.79 mm rechts, 0.53 mm tief
 Streuwert: 0.91, horizontal: 0.90, vertikal: 0.93

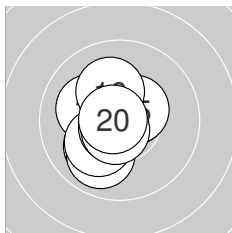

Serie 2:

10.5 *	10.1 ↙	10.1 ↘	9.9 ↙	10.5 *
10.2 *	10.2 *	10.7 *	10.7 *	10.8 *

beste Teiler: 44.2 (20.), 67.3 (18.), 70.7 (19.)
 Trefferlage: 0.59 mm links, 0.25 mm tief
 Streuwert: 1.13, horizontal: 0.95, vertikal: 1.29

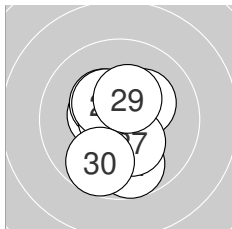

Serie 3:

10.6 *	10.2 *	10.5 *	9.7 ↓	10.4 *
10.8 *	10.3 *	10.4 *	10.4 *	9.7 ↙

beste Teiler: 48.0 (26.), 91.1 (21.), 122.2 (23.)
 Trefferlage: 0.14 mm links, 0.33 mm tief
 Streuwert: 1.33, horizontal: 0.97, vertikal: 1.61

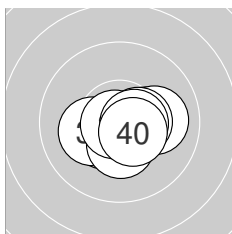

Serie 4:

10.4 *	10.6 *	10.2 *	10.3 *	10.0 →
10.5 *	10.4 *	10.8 *	10.6 *	10.5 *

beste Teiler: 35.3 (38.), 92.2 (32.), 95.5 (39.)
 Trefferlage: 0.32 mm rechts, 0.41 mm tief
 Streuwert: 0.97, horizontal: 1.29, vertikal: 0.49



Ergebnis: **412.1** (397)
 Serien: 102.8 104.1 101.9 103.3
 Zähler: 37 3 0 0 0 0 0 0 0 0
 Innenzehner: 28
 Weitester: 495 (24.), 277 (12.), 253 (7.)
 beste Teiler: 36.0 (16.), 52.8 (31.), 54.7 (20.)
 Trefferlage: 0.30 mm links, 0.15 mm hoch
 Streuwert: 1.29, horizontal: 1.35, vertikal: 1.22

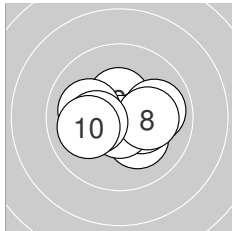
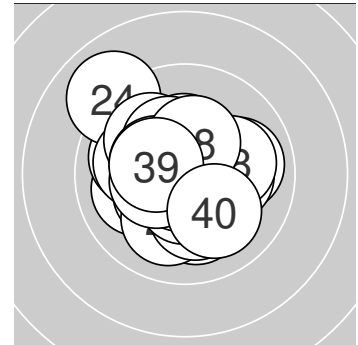

Serie 1:

10.7 *	10.2 *	10.4 *	10.3 *	10.7 *
10.1 ←	9.9 →	10.2 *	10.3 *	10.0 ←

beste Teiler: 61.0 (1.), 69.0 (5.), 130.1 (3.)
 Trefferlage: 0.18 mm rechts, 0.13 mm tief
 Streuwert: 1.33, horizontal: 1.72, vertikal: 0.76

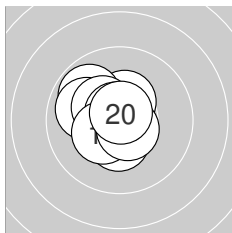

Serie 2:

10.4 *	9.8 ↘	10.0 ←	10.3 *	10.4 *
10.8 *	10.7 *	10.4 *	10.6 *	10.7 *

beste Teiler: 36.0 (16.), 54.7 (20.), 55.0 (17.)
 Trefferlage: 0.62 mm links, 0.32 mm hoch
 Streuwert: 1.02, horizontal: 1.04, vertikal: 1.00

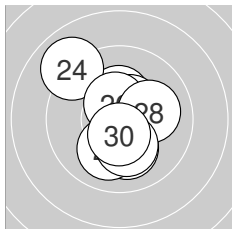

Serie 3:

10.3 *	10.5 *	10.1 ↓	9.0 ↘	10.6 *
10.5 *	10.1 ↓	10.1 →	10.2 *	10.5 *

beste Teiler: 96.3 (25.), 109.0 (30.), 116.4 (26.)
 Trefferlage: 0.00 mm , 0.00 mm
 Streuwert: 1.67, horizontal: 1.43, vertikal: 1.88

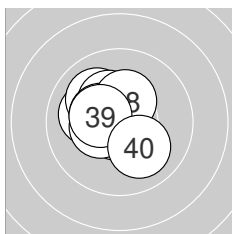

Serie 4:

10.7 *	10.1 ←	10.0 ↘	10.3 *	10.6 *
10.4 *	10.4 *	10.3 *	10.4 *	10.1 ↘

beste Teiler: 52.8 (31.), 87.7 (35.), 139.9 (36.)
 Trefferlage: 0.76 mm links, 0.41 mm hoch
 Streuwert: 1.05, horizontal: 1.06, vertikal: 1.05



Ergebnis: 411.5 (392)
Serien: 103.4 100.3 103.8 104.0
Zähler: 32 8 0 0 0 0 0 0 0
Innenzehner: 22
Weiteste: 348 (12.), 325 (33.), 289 (14.)
beste Teiler: 19.1 (1.), 20.6 (29.), 33.8 (26.)
Trefferlage: 0.44 mm rechts, 0.15 mm tief
Streuwert: 1.33, horizontal: 1.16, vertikal: 1.47

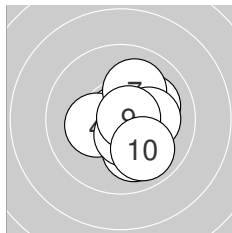
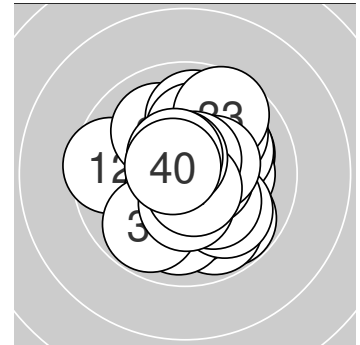

Serie 1:

10.9 *	10.7 *	10.1 ↗	10.3 *	10.0 ↘
10.5 *	10.1 ↗	10.2 *	10.7 *	9.9 ↘

beste Teiler: 19.1 (1.), 56.0 (2.), 56.8 (9.)
Trefferlage: 0.66 mm rechts, 0.30 mm tief
Streuwert: 1.18, horizontal: 1.10, vertikal: 1.26

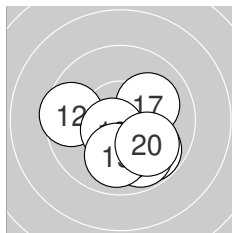

Serie 2:

10.4 *	9.6 ←	9.9 ↘	9.8 ↘	9.8 ↘
10.1 ↓	10.1 ↗	10.6 *	10.0 ↓	10.0 ↘

beste Teiler: 90.2 (18.), 145.7 (11.), 203.0 (16.)
Trefferlage: 0.54 mm rechts, 1.33 mm tief
Streuwert: 1.48, horizontal: 1.71, vertikal: 1.22

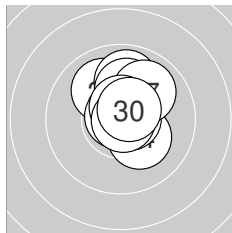

Serie 3:

10.0 ↘	9.9 ↑	10.1 ↑	10.2 *	10.7 *
10.8 *	10.0 ↗	10.6 *	10.9 *	10.6 *

beste Teiler: 20.6 (29.), 33.8 (26.), 61.2 (25.)
Trefferlage: 0.37 mm rechts, 0.89 mm hoch
Streuwert: 1.03, horizontal: 0.80, vertikal: 1.22

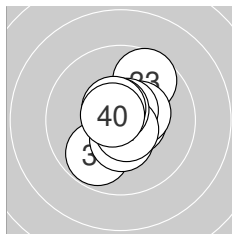

Serie 4:

9.8 ↘	10.6 *	9.7 ↗	10.4 *	10.4 *
10.6 *	10.6 *	10.6 *	10.6 *	10.7 *

beste Teiler: 67.4 (40.), 78.2 (37.), 78.4 (38.)
Trefferlage: 0.19 mm rechts, 0.13 mm hoch
Streuwert: 1.20, horizontal: 0.98, vertikal: 1.39



Ergebnis: **372.3** (354)
 Serien: 94.6 91.3 93.5 92.9
 Zähler: 9 18 11 2 0 0 0 0 0 0
 Innenzehner: 5
 Weitester: 862 (17.), 793 (30.), 745 (33.)
 beste Teiler: 90.8 (29.), 102.2 (22.), 113.5 (2.)
 Trefferlage: 0.41 mm links, 0.28 mm tief
 Streuwert: 3.23, horizontal: 3.62, vertikal: 2.78

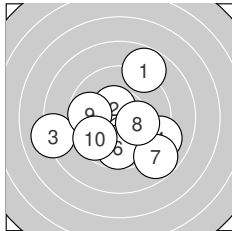
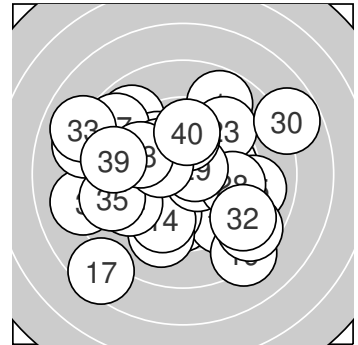

Serie 1:

8.8 ↗	10.5 *	8.1 ←	9.1 →	10.1 ↓
9.7 ↓	8.8 ↘	10.2 *	9.7 ←	9.6 ↙

beste Teiler: 113.5 (2.), 192.5 (8.), 219.9 (5.)
 Trefferlage: 0.04 mm links, 0.98 mm tief
 Streuwert: 2.98, horizontal: 3.37, vertikal: 2.52

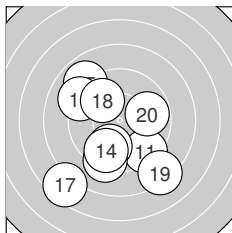

Serie 2:

9.3 ↘	9.8 ↓	9.2 ↓	9.6 ↓	8.9 ↘
9.1 ↖	7.5 ↙	9.9 ↘	8.2 ↘	9.8 →

beste Teiler: 266.5 (18.), 283.4 (12.), 288.4 (20.)
 Trefferlage: 0.91 mm links, 1.63 mm tief
 Streuwert: 3.36, horizontal: 3.18, vertikal: 3.54

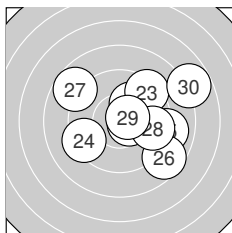

Serie 3:

10.1 ↗	10.5 *	9.3 ↗	9.3 ←	9.0 →
8.6 ↘	8.7 ↖	9.6 →	10.6 *	7.8 ↗

beste Teiler: 90.8 (29.), 102.2 (22.), 211.8 (21.)
 Trefferlage: 1.73 mm rechts, 0.44 mm hoch
 Streuwert: 3.09, horizontal: 3.64, vertikal: 2.42

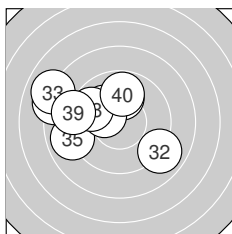

Serie 4:

8.2 ↖	8.9 ↘	8.0 ↖	10.1 ↘	8.9 ←
10.0 ↑	10.3 *	9.7 ↖	9.0 ←	9.8 ↑

beste Teiler: 167.9 (37.), 218.5 (34.), 247.2 (36.)
 Trefferlage: 2.43 mm links, 1.03 mm hoch
 Streuwert: 2.79, horizontal: 3.44, vertikal: 1.94



Ergebnis: **418.0** (399)
 Serien: 104.9 103.8 104.9 104.4
 Zähler: 39 1 0 0 0 0 0 0 0
 Innenzehner: 36
 Weitestе: 288 (32.), 241 (38.), 230 (11.)
 beste Teiler: 30.0 (9.), 30.3 (33.), 39.6 (40.)
 Trefferlage: 0.03 mm rechts, 0.05 mm tief
 Streuwert: 0.99, horizontal: 1.06, vertikal: 0.91

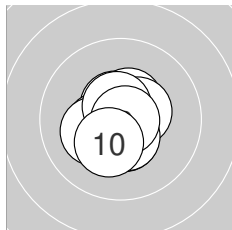
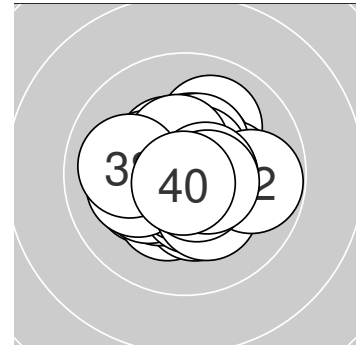

Serie 1:

10.5 *	10.6 *	10.5 *	10.5 *	10.4 *
10.5 *	10.2 *	10.6 *	10.8 *	10.3 *

beste Teiler: 30.0 (9.), 88.6 (8.), 95.8 (2.)
 Trefferlage: 0.19 mm links, 0.17 mm tief
 Streuwert: 0.91, horizontal: 0.86, vertikal: 0.96

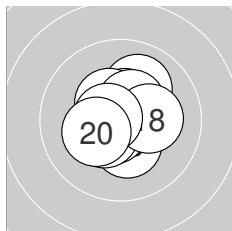

Serie 2:

10.0 ↗	10.5 *	10.4 *	10.5 *	10.3 *
10.6 *	10.4 *	10.2 *	10.6 *	10.3 *

beste Teiler: 77.4 (16.), 84.3 (19.), 114.2 (12.)
 Trefferlage: 0.03 mm links, 0.18 mm hoch
 Streuwert: 1.10, horizontal: 1.07, vertikal: 1.12

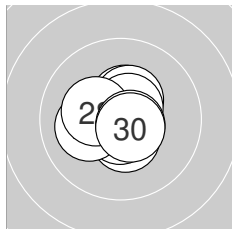

Serie 3:

10.4 *	10.4 *	10.6 *	10.6 *	10.5 *
10.7 *	10.1 ←	10.3 *	10.7 *	10.6 *

beste Teiler: 69.1 (26.), 73.0 (29.), 82.9 (30.)
 Trefferlage: 0.04 mm links, 0.04 mm tief
 Streuwert: 0.93, horizontal: 0.96, vertikal: 0.90

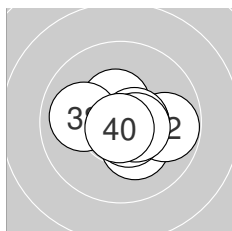

Serie 4:

10.2 *	9.8 →	10.8 *	10.6 *	10.5 *
10.6 *	10.6 *	10.0 ←	10.5 *	10.8 *

beste Teiler: 30.3 (33.), 39.6 (40.), 85.6 (34.)
 Trefferlage: 0.40 mm rechts, 0.18 mm tief
 Streuwert: 1.07, horizontal: 1.34, vertikal: 0.69



Ergebnis: **396.2** (378)
 Serien: 98.6 99.1 100.4 98.1
 Zähler: 20 18 2 0 0 0 0 0 0 0
 Innenzehner: 19
 Weitester: 625 (31.), 538 (11.), 484 (17.)
 beste Teiler: 19.3 (10.), 45.5 (27.), 60.2 (13.)
 Trefferlage: 0.33 mm links, 0.39 mm hoch
 Streuwert: 2.13, horizontal: 2.42, vertikal: 1.78

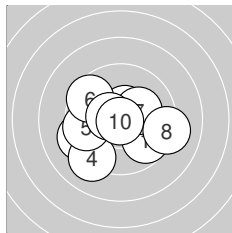
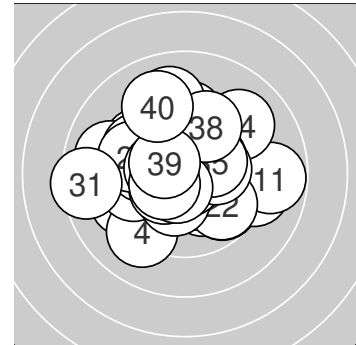

Serie 1:
 9.7 ↘ 10.5 * 9.3 ← 9.1 ↗ 9.6 ←
 9.6 ↘ 10.2 * 9.2 → 10.5 * 10.9 *
 beste Teiler: 19.3 (10.), 103.0 (2.), 108.4 (9.)
 Trefferlage: 0.48 mm links, 0.52 mm tief
 Streuwert: 2.24, horizontal: 2.72, vertikal: 1.63

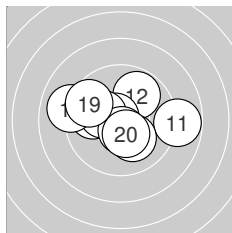

Serie 2:
 8.8 → 9.8 ↗ 10.7 * 9.9 ← 10.1 ↘
 10.2 * 9.0 ← 10.6 * 9.6 ↘ 10.4 *
 beste Teiler: 60.2 (13.), 96.6 (18.), 137.7 (20.)
 Trefferlage: 0.38 mm links, 0.22 mm hoch
 Streuwert: 2.20, horizontal: 2.84, vertikal: 1.29

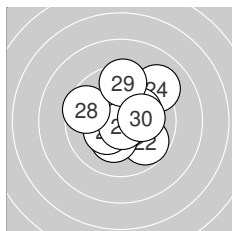

Serie 3:
 10.7 * 9.8 ↘ 10.2 * 9.1 ↗ 10.3 *
 10.2 * 10.8 * 9.6 ← 9.5 ↑ 10.2 *
 beste Teiler: 45.5 (27.), 65.9 (21.), 157.2 (25.)
 Trefferlage: 0.50 mm rechts, 0.46 mm hoch
 Streuwert: 1.89, horizontal: 1.94, vertikal: 1.83

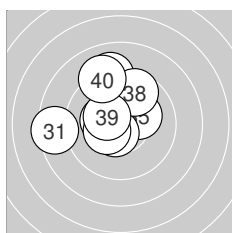

Serie 4:
 8.5 ← 9.9 ↗ 10.3 * 9.1 ↑ 10.2 *
 10.6 * 10.4 * 9.6 ↗ 10.4 * 9.1 ↑
 beste Teiler: 97.7 (36.), 143.1 (37.), 147.7 (39.)
 Trefferlage: 0.95 mm links, 1.39 mm hoch
 Streuwert: 2.13, horizontal: 2.24, vertikal: 2.01

