

Ergebnis: **417.0** (399)  
 Serien: 105.0 105.1 103.6 103.3  
 Zähler: 39 1 0 0 0 0 0 0 0 0  
 Innenzehner: 34  
 weiteste: 469 (28), 234 (18), 231 (38)  
 beste Teiler 28.2 (16.) 29.0 (17.) 29.5 (7.)  
 Trefferlage 0.06 mm links, 0.35 mm hoch  
 Streuwert 1.07, horizontal: 1.13, vertikal: 1.01

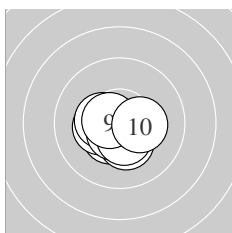

Serie 1:  
 10.4 \*                      10.3 \*                      10.3 \*                      10.4 \*                      10.6 \*  
 10.8 \*                      10.8 \*                      10.5 \*                      10.6 \*                      10.3 \*  
 beste Teiler 29.5 (7.) 36.8 (6.) 82.7 (9.)  
 Trefferlage 0.21 mm links, 0.50 mm tief  
 Streuwert 0.79, horizontal: 0.96, vertikal: 0.58

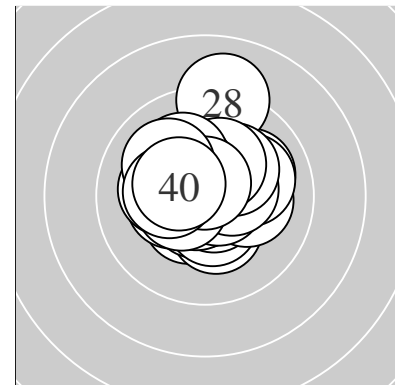
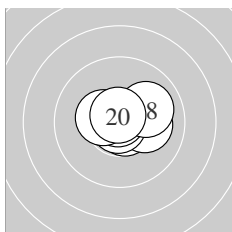

Serie 2:  
 10.6 \*                      10.6 \*                      10.7 \*                      10.4 \*                      10.1 →  
 10.8 \*                      10.8 \*                      10.0 ↗                      10.4 \*                      10.7 \*  
 beste Teiler 28.2 (16.) 29.0 (17.) 57.7 (20.)  
 Trefferlage 0.42 mm rechts, 0.20 mm hoch  
 Streuwert 0.88, horizontal: 1.16, vertikal: 0.43

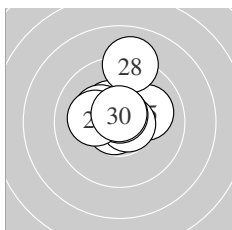

Serie 3:  
 10.7 \*                      10.4 \*                      10.7 \*                      10.3 \*                      10.1 →  
 10.7 \*                      10.7 \*                      9.1 ↑                      10.2 \*                      10.7 \*  
 beste Teiler 55.9 (21.) 56.0 (27.) 66.7 (26.)  
 Trefferlage 0.03 mm links, 0.83 mm hoch  
 Streuwert 1.31, horizontal: 1.20, vertikal: 1.41

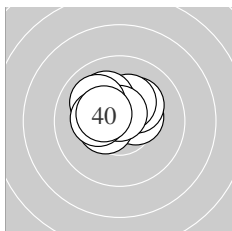

Serie 4:  
 10.4 \*                      10.2 \*                      10.3 \*                      10.5 \*                      10.4 \*  
 10.1 ↘                      10.7 \*                      10.0 ↘                      10.3 \*                      10.4 \*  
 beste Teiler 62.0 (37.) 119.5 (34.) 134.1 (31.)  
 Trefferlage 0.44 mm links, 0.86 mm hoch  
 Streuwert 0.97, horizontal: 1.19, vertikal: 0.70

Unterschrift des Schützen

Meyton Elektronik

Ergebnis: **419.3** (397)  
 Serien: 106.1 103.8 104.3 105.1  
 Zähler: 37 3 0 0 0 0 0 0 0 0  
 Innenzehner: 35  
 weiteste: 266 (16), 255 (36), 253 (5)  
 beste Teiler 13.0 (7.) 13.4 (1.) 31.0 (40.)  
 Trefferlage 0.29 mm links, 0.23 mm hoch  
 Streuwert 0.91, horizontal: 0.95, vertikal: 0.88

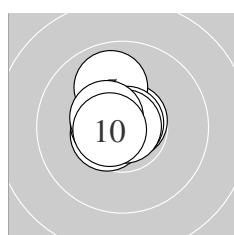
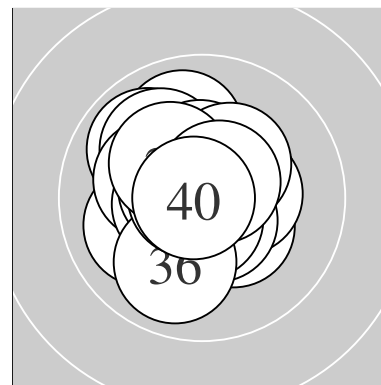

Serie 1:  
 10.9 \*                      10.7 \*                      10.5 \*                      10.7 \*                      9.9 ↗  
 10.8 \*                      10.9 \*                      10.6 \*                      10.5 \*                      10.6 \*  
 beste Teiler 13.0 (7.) 13.4 (1.) 36.0 (6.)  
 Trefferlage 0.35 mm links, 0.40 mm hoch  
 Streuwert 0.68, horizontal: 0.57, vertikal: 0.78

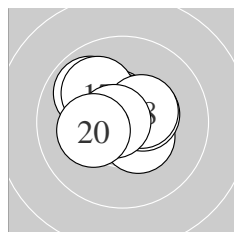

Serie 2:  
 10.6 \*                      10.5 \*                      10.4 \*                      10.7 \*                      10.4 \*  
 9.9 ↘                      10.0 ↘                      10.4 \*                      10.7 \*                      10.2 \*  
 beste Teiler 52.2 (19.) 69.0 (14.) 84.6 (11.)  
 Trefferlage 0.35 mm links, 0.55 mm hoch  
 Streuwert 1.04, horizontal: 1.19, vertikal: 0.86

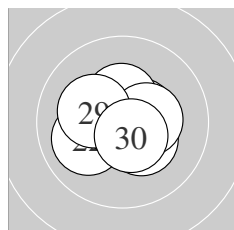

Serie 3:  
 10.5 \*                      10.0 ↙                      10.3 \*                      10.7 \*                      10.5 \*  
 10.7 \*                      10.4 \*                      10.4 \*                      10.2 \*                      10.6 \*  
 beste Teiler 53.5 (24.) 60.6 (26.) 97.9 (30.)  
 Trefferlage 0.06 mm links, 0.04 mm tief  
 Streuwert 1.03, horizontal: 1.23, vertikal: 0.78

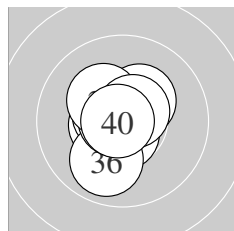

Serie 4:  
 10.6 \*                      10.5 \*                      10.3 \*                      10.7 \*                      10.6 \*  
 9.9 ↓                      10.8 \*                      10.3 \*                      10.6 \*                      10.8 \*  
 beste Teiler 31.0 (40.) 48.8 (37.) 75.0 (34.)  
 Trefferlage 0.41 mm links, 0.00 mm  
 Streuwert 0.91, horizontal: 0.75, vertikal: 1.04

Unterschrift des Schützen

Meyton Elektronik

Ergebnis: **403.6** (382)  
 Serien: 100.6 99.0 101.9 102.1  
 Zähler: 25 12 3 0 0 0 0 0 0 0  
 Innenzehner: 22  
 weiteste: 544 (18), 533 (2), 503 (13)  
 beste Teiler 16.1 (34.) 35.4 (37.) 38.4 (36.)  
 Trefferlage 0.59 mm rechts, 0.22 mm hoch  
 Streuwert 1.81, horizontal: 2.02, vertikal: 1.57

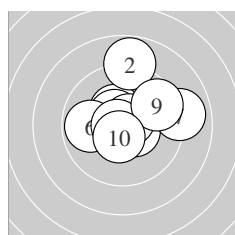
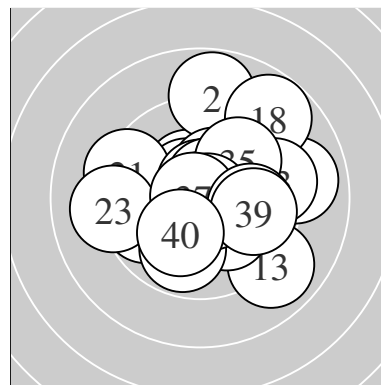

Serie 1:  
 10.4 \*                      8.8 ↑                      10.5 \*                      10.5 \*                      10.7 \*  
 9.8 ←                      9.0 →                      10.8 \*                      9.6 ↗                      10.5 \*  
 beste Teiler 48.0 (8.) 70.9 (5.) 105.6 (10.)  
 Trefferlage 0.52 mm rechts, 0.89 mm hoch  
 Streuwert 1.95, horizontal: 2.13, vertikal: 1.76

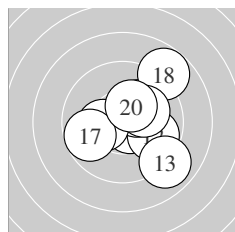

Serie 2:  
 10.6 \*                      9.8 ↘                      8.9 ↘                      10.2 \*                      10.3 \*  
 10.3 \*                      9.7 ←                      8.8 ↗                      10.1 ↗                      10.3 \*  
 beste Teiler 79.4 (11.) 155.4 (15.) 158.3 (20.)  
 Trefferlage 1.12 mm rechts, 0.24 mm hoch  
 Streuwert 2.06, horizontal: 2.08, vertikal: 2.03

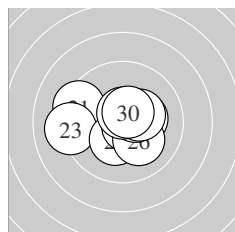

Serie 3:  
 9.4 ↖                      10.3 \*                      9.1 ←                      10.3 \*                      10.7 \*  
 10.1 ↘                      10.5 \*                      10.3 \*                      10.6 \*                      10.6 \*  
 beste Teiler 55.4 (25.) 78.0 (29.) 98.0 (30.)  
 Trefferlage 0.23 mm links, 0.04 mm hoch  
 Streuwert 1.69, horizontal: 2.18, vertikal: 0.98

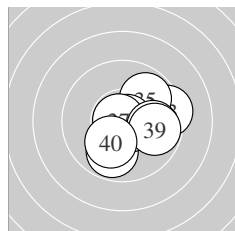

Serie 4:  
 9.8 ↓                      10.7 \*                      9.4 →                      10.9 \*                      9.9 ↗  
 10.8 \*                      10.8 \*                      9.9 →                      9.8 →                      10.1 ↓  
 beste Teiler 16.1 (34.) 35.4 (37.) 38.4 (36.)  
 Trefferlage 0.99 mm rechts, 0.29 mm tief  
 Streuwert 1.50, horizontal: 1.68, vertikal: 1.28

Unterschrift des Schützen

Meyton Elektronik

Ergebnis: **398.3** (379)  
 Serien: 99.1 99.1 100.3 99.8  
 Zähler: 21 17 2 0 0 0 0 0 0 0  
 Innenzehner: 15  
 weiteste: 555 (37), 506 (35), 477 (10)  
 beste Teiler 27.1 (27.) 54.0 (9.) 93.4 (3.)  
 Trefferlage 0.24 mm rechts, 0.27 mm tief  
 Streuwert 1.96, horizontal: 1.49, vertikal: 2.34

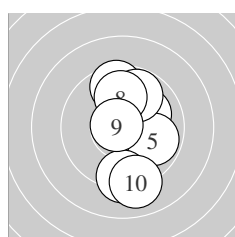
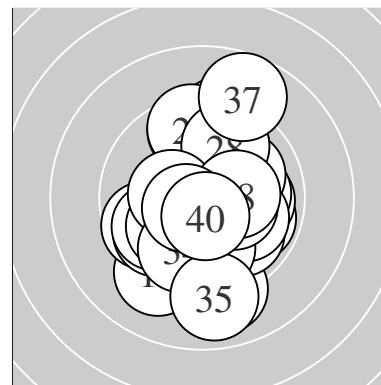

Serie 1:  
 9.6 ↑                      10.2 \*                      10.6 \*                      10.1 ↗                      9.9 ↘  
 9.8 ↗                      9.3 ↓                      9.9 ↑                      10.7 \*                      9.0 ↓  
 beste Teiler 54.0 (9.) 93.4 (3.) 189.1 (2.)  
 Trefferlage 0.71 mm rechts, 0.24 mm hoch  
 Streuwert 2.10, horizontal: 1.05, vertikal: 2.77

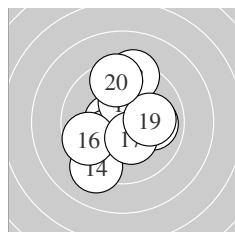

Serie 2:  
 10.5 \*                      10.0 →                      10.3 \*                      9.2 ↙                      10.3 \*  
 9.7 ↙                      10.3 \*                      9.3 ↑                      10.0 →                      9.5 ↑  
 beste Teiler 102.8 (11.) 152.1 (17.) 164.1 (13.)  
 Trefferlage 0.13 mm links, 0.17 mm hoch  
 Streuwert 2.09, horizontal: 1.79, vertikal: 2.35

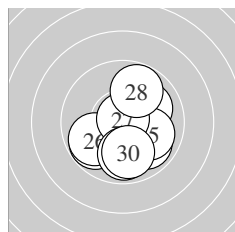

Serie 3:  
 10.0 ↗                      10.4 \*                      9.8 ↙                      9.9 ↘                      10.0 ↘  
 9.8 ↙                      10.8 \*                      9.8 ↑                      9.9 ↓                      9.9 ↓  
 beste Teiler 27.1 (27.) 135.0 (22.) 232.0 (21.)  
 Trefferlage 0.40 mm rechts, 0.82 mm tief  
 Streuwert 1.67, horizontal: 1.64, vertikal: 1.70

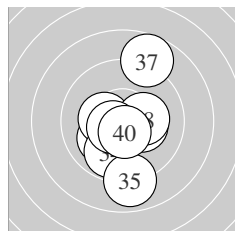

Serie 4:  
 10.2 \*                      10.1 ↙                      10.3 \*                      9.8 ↙                      8.9 ↓  
 10.3 \*                      8.7 ↑                      10.3 \*                      10.6 \*                      10.6 \*  
 beste Teiler 94.5 (40.) 97.0 (39.) 155.2 (33.)  
 Trefferlage 0.00 mm , 0.69 mm tief  
 Streuwert 2.08, horizontal: 1.44, vertikal: 2.57

Unterschrift des Schützen

Meyton Elektronik

Ergebnis: **421.6** (397)  
 Serien: 104.9 104.9 106.4 105.4  
 Zähler: 37 3 0 0 0 0 0 0 0 0  
 Innenzehner: 37  
 weiteste: 319 (31), 291 (4), 281 (12)  
 beste Teiler 9.4 (33.) 10.8 (20.) 38.2 (30.)  
 Trefferlage 0.22 mm rechts, 0.11 mm tief  
 Streuwert 0.87, horizontal: 0.91, vertikal: 0.84

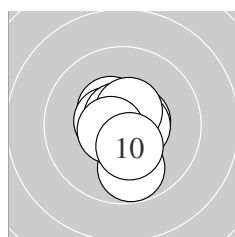
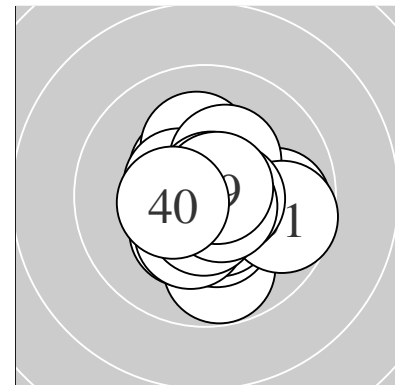

Serie 1:  
 10.4 \*                    10.5 \*                    10.7 \*                    9.8 ↓                    10.6 \*  
 10.8 \*                    10.6 \*                    10.5 \*                    10.6 \*                    10.4 \*  
 beste Teiler 39.8 (6.) 68.0 (3.) 85.6 (9.)  
 Trefferlage 0.07 mm rechts, 0.17 mm tief  
 Streuwert 0.98, horizontal: 0.75, vertikal: 1.17

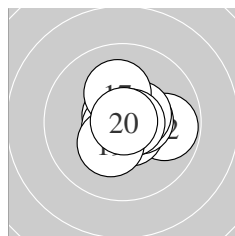

Serie 2:  
 10.7 \*                    9.8 →                    10.6 \*                    10.7 \*                    10.5 \*  
 10.5 \*                    10.2 \*                    10.7 \*                    10.3 \*                    10.9 \*  
 beste Teiler 10.8 (20.) 58.1 (18.) 58.5 (14.)  
 Trefferlage 0.40 mm rechts, 0.02 mm hoch  
 Streuwert 0.98, horizontal: 1.07, vertikal: 0.87

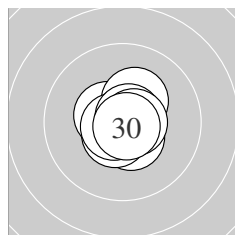

Serie 3:  
 10.5 \*                    10.6 \*                    10.7 \*                    10.5 \*                    10.3 \*  
 10.8 \*                    10.7 \*                    10.8 \*                    10.7 \*                    10.8 \*  
 beste Teiler 38.2 (30.) 39.6 (26.) 50.6 (28.)  
 Trefferlage 0.03 mm rechts, 0.00 mm  
 Streuwert 0.67, horizontal: 0.66, vertikal: 0.67

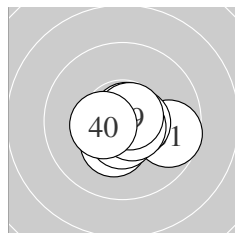

Serie 4:  
 9.7 →                    10.6 \*                    10.9 \*                    10.8 \*                    10.3 \*  
 10.6 \*                    10.8 \*                    10.6 \*                    10.7 \*                    10.4 \*  
 beste Teiler 9.4 (33.) 40.8 (34.) 47.8 (37.)  
 Trefferlage 0.40 mm rechts, 0.32 mm tief  
 Streuwert 0.91, horizontal: 1.14, vertikal: 0.60

Unterschrift des Schützen

Meyton Elektronik

Ergebnis: **418.1** (397)  
 Serien: 102.8 105.5 105.0 104.8  
 Zähler: 37 3 0 0 0 0 0 0 0 0  
 Innenzehner: 32  
 weiteste: 373 (8), 271 (13), 261 (3)  
 beste Teiler 2.8 (26.) 5.3 (9.) 22.2 (18.)  
 Trefferlage 0.15 mm links, 0.29 mm hoch  
 Streuwert 1.04, horizontal: 1.25, vertikal: 0.77

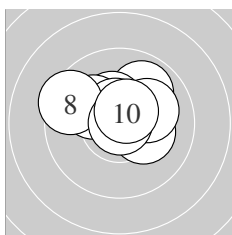
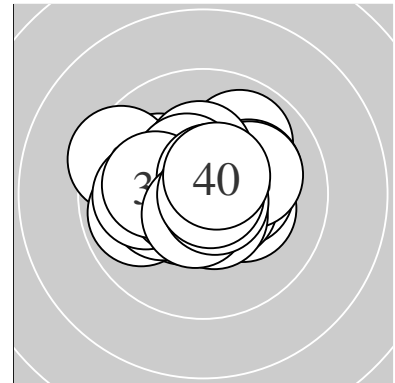

Serie 1:  
 10.5 \*                      10.2 \*                      9.9 ↗                      10.1 ↘                      10.4 \*  
 10.1 ↖                      10.6 \*                      9.5 ↖                      10.9 \*                      10.6 \*  
 beste Teiler 5.3 (9.) 94.5 (7.) 96.2 (10.)  
 Trefferlage 0.07 mm rechts, 0.83 mm hoch  
 Streuwert 1.32, horizontal: 1.70, vertikal: 0.78

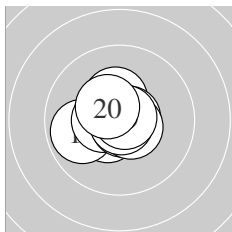

Serie 2:  
 10.4 \*                      10.5 \*                      9.9 ←                      10.5 \*                      10.7 \*  
 10.8 \*                      10.6 \*                      10.9 \*                      10.8 \*                      10.4 \*  
 beste Teiler 22.2 (18.) 41.1 (19.) 42.4 (16.)  
 Trefferlage 0.35 mm links, 0.02 mm hoch  
 Streuwert 0.89, horizontal: 1.03, vertikal: 0.72

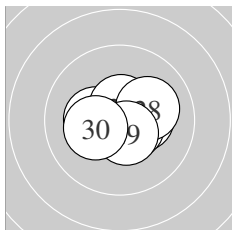

Serie 3:  
 10.3 \*                      10.7 \*                      10.6 \*                      10.3 \*                      10.8 \*  
 10.9 \*                      10.6 \*                      10.1 →                      10.5 \*                      10.2 \*  
 beste Teiler 2.8 (26.) 29.6 (25.) 51.3 (22.)  
 Trefferlage 0.14 mm rechts, 0.00 mm  
 Streuwert 0.94, horizontal: 1.20, vertikal: 0.58

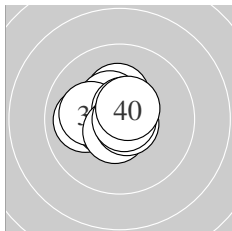

Serie 4:  
 10.0 ←                      10.6 \*                      10.3 \*                      10.4 \*                      10.1 ←  
 10.7 \*                      10.6 \*                      10.7 \*                      10.8 \*                      10.6 \*  
 beste Teiler 32.1 (39.) 58.8 (38.) 75.2 (36.)  
 Trefferlage 0.47 mm links, 0.30 mm hoch  
 Streuwert 0.91, horizontal: 1.03, vertikal: 0.76

Unterschrift des Schützen

Meyton Elektronik

Ergebnis: **419.2** (398)  
 Serien: 104.4 105.5 103.8 105.5  
 Zähler: 38 2 0 0 0 0 0 0 0 0  
 Innenzehner: 36  
 weiteste: 285 (1), 277 (29), 231 (4)  
 beste Teiler 14.5 (8.) 26.0 (13.) 35.9 (16.)  
 Trefferlage 0.10 mm links, 0.18 mm tief  
 Streuwert 0.95, horizontal: 0.96, vertikal: 0.93

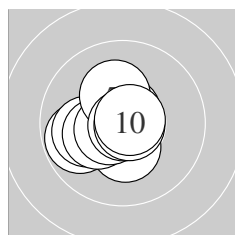
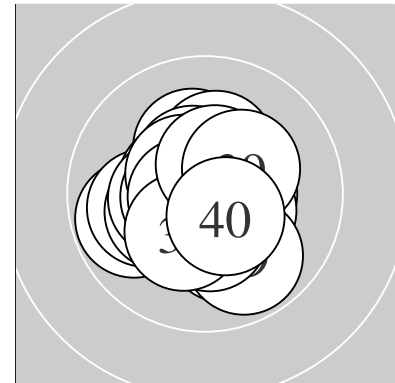

Serie 1:  
 9.8 ← 10.7 \* 10.3 \* 10.0 ← 10.3 \*  
 10.6 \* 10.2 \* 10.9 \* 10.8 \* 10.8 \*  
 beste Teiler 14.5 (8.) 44.9 (9.) 50.1 (10.)  
 Trefferlage 0.65 mm links, 0.16 mm tief  
 Streuwert 1.04, horizontal: 1.15, vertikal: 0.91

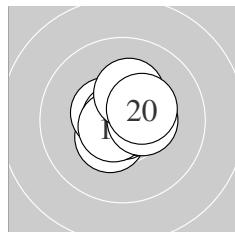

Serie 2:  
 10.4 \* 10.5 \* 10.8 \* 10.7 \* 10.5 \*  
 10.8 \* 10.7 \* 10.4 \* 10.3 \* 10.4 \*  
 beste Teiler 26.0 (13.) 35.9 (16.) 64.0 (14.)  
 Trefferlage 0.16 mm rechts, 0.18 mm hoch  
 Streuwert 0.79, horizontal: 0.84, vertikal: 0.75

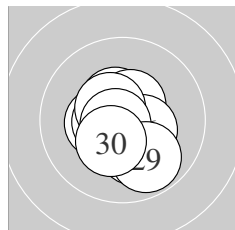

Serie 3:  
 10.4 \* 10.5 \* 10.6 \* 10.5 \* 10.1 ↓  
 10.4 \* 10.5 \* 10.7 \* 9.8 ↓ 10.3 \*  
 beste Teiler 51.4 (28.) 98.6 (23.) 108.2 (24.)  
 Trefferlage 0.09 mm links, 0.39 mm tief  
 Streuwert 1.10, horizontal: 1.00, vertikal: 1.18

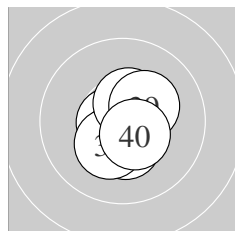

Serie 4:  
 10.8 \* 10.7 \* 10.6 \* 10.7 \* 10.4 \*  
 10.7 \* 10.3 \* 10.5 \* 10.3 \* 10.5 \*  
 beste Teiler 48.8 (31.) 70.7 (34.) 72.0 (36.)  
 Trefferlage 0.16 mm rechts, 0.36 mm tief  
 Streuwert 0.79, horizontal: 0.70, vertikal: 0.87

Unterschrift des Schützen

Meyton Elektronik

Ergebnis: **418.8** (398)  
 Serien: 103.4 106.9 104.5 104.0  
 Zähler: 38 2 0 0 0 0 0 0 0 0  
 Innenzehner: 33  
 weiteste: 305 (30), 252 (8), 244 (37)  
 beste Teiler 10.4 (25.) 31.8 (16.) 38.0 (10.)  
 Trefferlage 0.13 mm links, 0.00 mm  
 Streuwert 0.99, horizontal: 1.06, vertikal: 0.92

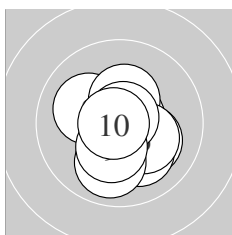
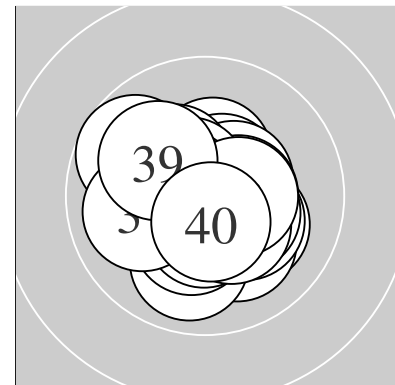

Serie 1:  
 10.1 ↘                      10.7 \*                      10.1 ↖                      10.4 \*                      10.1 ↘  
 10.2 \*                      10.8 \*                      9.9 ↓                      10.3 \*                      10.8 \*  
 beste Teiler 38.0 (10.) 43.0 (7.) 68.4 (2.)  
 Trefferlage 0.21 mm rechts, 0.46 mm tief  
 Streuwert 1.19, horizontal: 1.12, vertikal: 1.26

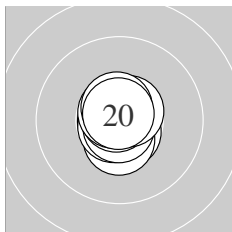

Serie 2:  
 10.8 \*                      10.6 \*                      10.5 \*                      10.7 \*                      10.8 \*  
 10.8 \*                      10.6 \*                      10.7 \*                      10.6 \*                      10.8 \*  
 beste Teiler 31.8 (16.) 41.0 (11.) 41.7 (20.)  
 Trefferlage 0.08 mm links, 0.04 mm tief  
 Streuwert 0.51, horizontal: 0.31, vertikal: 0.64

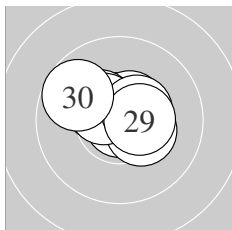

Serie 3:  
 10.6 \*                      10.5 \*                      10.7 \*                      10.3 \*                      10.9 \*  
 10.4 \*                      10.5 \*                      10.5 \*                      10.4 \*                      9.7 ↖  
 beste Teiler 10.4 (25.) 54.0 (23.) 77.1 (21.)  
 Trefferlage 0.10 mm links, 0.50 mm hoch  
 Streuwert 1.00, horizontal: 1.27, vertikal: 0.61

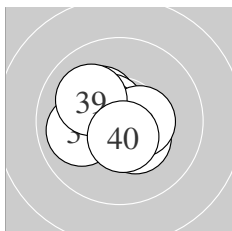

Serie 4:  
 10.3 \*                      10.3 \*                      10.7 \*                      10.6 \*                      10.6 \*  
 10.4 \*                      10.0 ←                      10.4 \*                      10.1 ↖                      10.6 \*  
 beste Teiler 55.8 (33.) 94.2 (35.) 95.0 (34.)  
 Trefferlage 0.56 mm links, 0.02 mm hoch  
 Streuwert 1.06, horizontal: 1.24, vertikal: 0.85

Unterschrift des Schützen

Meyton Elektronik



Ergebnis: **415.1** (394)  
 Serien: 103.4 104.7 103.6 103.4  
 Zähler: 34 6 0 0 0 0 0 0 0 0  
 Innenzehner: 32  
 weiteste: 370 (31), 369 (6), 367 (13)  
 beste Teiler 21.0 (18.) 26.6 (14.) 30.4 (20.)  
 Trefferlage 0.22 mm rechts, 0.20 mm hoch  
 Streuwert 1.21, horizontal: 1.04, vertikal: 1.36

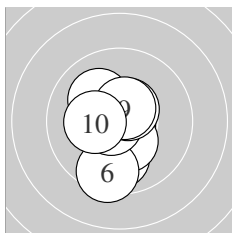
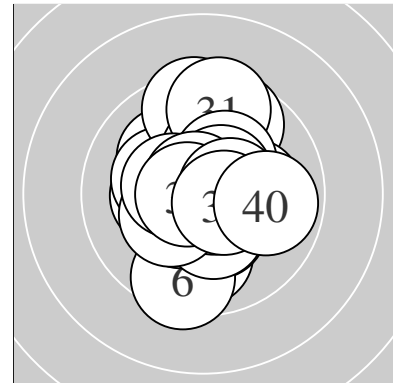

Serie 1:  
 10.8 \*                      10.1 ↖                      9.9 ↓                      10.8 \*                      10.3 \*  
 9.5 ↓                      10.7 \*                      10.5 \*                      10.6 \*                      10.2 \*  
 beste Teiler 32.5 (4.) 35.8 (1.) 63.5 (7.)  
 Trefferlage 0.32 mm links, 0.49 mm tief  
 Streuwert 1.28, horizontal: 0.84, vertikal: 1.61

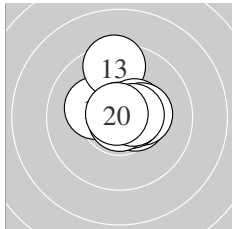

Serie 2:  
 10.2 \*                      10.5 \*                      9.5 ↑                      10.8 \*                      10.5 \*  
 10.3 \*                      10.6 \*                      10.9 \*                      10.6 \*                      10.8 \*  
 beste Teiler 21.0 (18.) 26.6 (14.) 30.4 (20.)  
 Trefferlage 0.31 mm rechts, 0.52 mm hoch  
 Streuwert 1.06, horizontal: 0.97, vertikal: 1.13

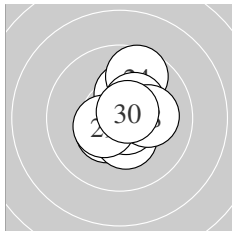

Serie 3:  
 10.4 \*                      10.4 \*                      10.3 \*                      9.7 ↑                      10.4 \*  
 10.4 \*                      10.7 \*                      10.1 →                      10.5 \*                      10.7 \*  
 beste Teiler 59.0 (27.) 72.6 (30.) 124.8 (29.)  
 Trefferlage 0.55 mm rechts, 0.28 mm hoch  
 Streuwert 1.16, horizontal: 0.97, vertikal: 1.32

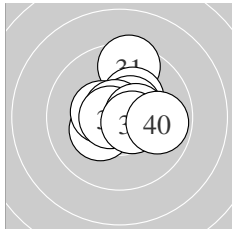

Serie 4:  
 9.5 ↑                      10.3 \*                      10.3 \*                      10.5 \*                      10.4 \*  
 10.7 \*                      10.7 \*                      10.5 \*                      10.6 \*                      9.9 →  
 beste Teiler 55.6 (36.) 68.0 (37.) 97.6 (39.)  
 Trefferlage 0.34 mm rechts, 0.49 mm hoch  
 Streuwert 1.27, horizontal: 1.26, vertikal: 1.27

Unterschrift des Schützen

Meyton Elektronik

Ergebnis: **417.8** (397)  
 Serien: 104.0 104.0 105.3 104.5  
 Zähler: 37 3 0 0 0 0 0 0 0 0  
 Innenzehner: 34  
 weiteste: 333 (35), 286 (25), 278 (15)  
 beste Teiler 18.3 (27.) 22.6 (28.) 29.0 (22.)  
 Trefferlage 0.26 mm links, 0.10 mm hoch  
 Streuwert 1.03, horizontal: 1.05, vertikal: 1.01

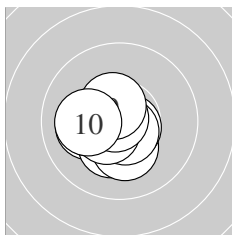
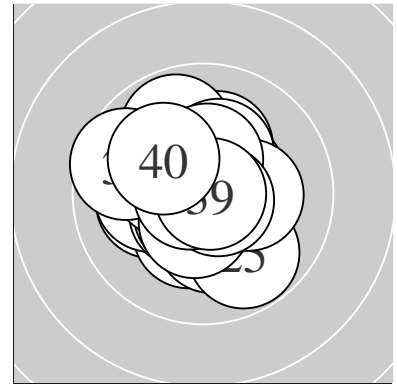

Serie 1:  
 10.1 ←                      10.3 \*                      10.2 \*                      10.2 \*                      10.7 \*  
 10.6 \*                      10.5 \*                      10.8 \*                      10.5 \*                      10.1 ←  
 beste Teiler 34.9 (8.) 69.2 (5.) 79.2 (6.)  
 Trefferlage 0.70 mm links, 0.43 mm tief  
 Streuwert 0.92, horizontal: 1.03, vertikal: 0.80

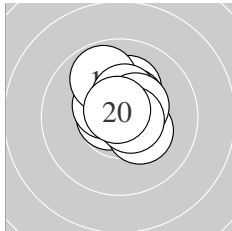

Serie 2:  
 10.7 \*                      10.5 \*                      10.2 \*                      10.4 \*                      9.8 ↗  
 10.3 \*                      10.4 \*                      10.4 \*                      10.6 \*                      10.7 \*  
 beste Teiler 51.8 (20.) 67.1 (11.) 76.9 (19.)  
 Trefferlage 0.20 mm rechts, 0.77 mm hoch  
 Streuwert 0.94, horizontal: 0.87, vertikal: 1.01

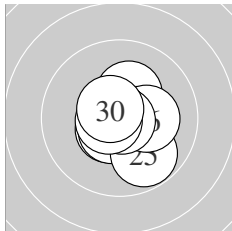

Serie 3:  
 10.5 \*                      10.8 \*                      10.3 \*                      10.6 \*                      9.8 ↘  
 10.2 \*                      10.9 \*                      10.9 \*                      10.7 \*                      10.6 \*  
 beste Teiler 18.3 (27.) 22.6 (28.) 29.0 (22.)  
 Trefferlage 0.11 mm rechts, 0.20 mm tief  
 Streuwert 0.98, horizontal: 0.95, vertikal: 1.02

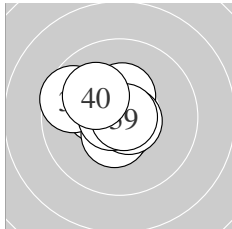

Serie 4:  
 10.6 \*                      10.7 \*                      10.4 \*                      10.5 \*                      9.6 ↖  
 10.4 \*                      10.7 \*                      10.7 \*                      10.8 \*                      10.1 ↖  
 beste Teiler 29.0 (39.) 54.0 (38.) 66.3 (37.)  
 Trefferlage 0.68 mm links, 0.28 mm hoch  
 Streuwert 1.01, horizontal: 1.12, vertikal: 0.88

Unterschrift des Schützen

Meyton Elektronik

Ergebnis: **415.1** (395)  
 Serien: 103.6 103.1 103.6 104.8  
 Zähler: 35 5 0 0 0 0 0 0 0 0  
 Innenzehner: 30  
 weiteste: 384 (15), 313 (19), 303 (40)  
 beste Teiler 32.0 (9.) 38.2 (13.) 45.4 (31.)  
 Trefferlage 0.25 mm links, 0.48 mm tief  
 Streuwert 1.13, horizontal: 1.23, vertikal: 1.02

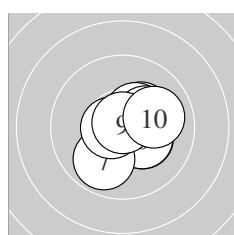
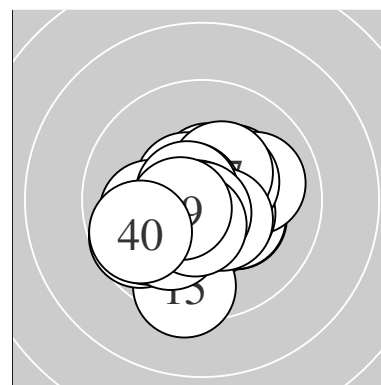

Serie 1:  
 10.3 \*                      10.4 \*                      10.2 \*                      10.8 \*                      10.3 \*  
 10.3 \*                      9.9 ↙                      10.6 \*                      10.8 \*                      10.0 →  
 beste Teiler 32.0 (9.) 50.0 (4.) 82.1 (8.)  
 Trefferlage 0.69 mm rechts, 0.05 mm tief  
 Streuwert 1.12, horizontal: 1.18, vertikal: 1.06

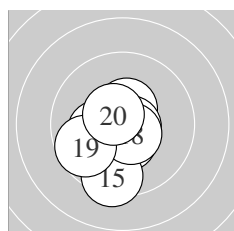

Serie 2:  
 10.5 \*                      10.5 \*                      10.8 \*                      10.1 ↘                      9.4 ↓  
 10.7 \*                      10.2 \*                      10.6 \*                      9.7 ↙                      10.6 \*  
 beste Teiler 38.2 (13.) 59.7 (16.) 92.0 (18.)  
 Trefferlage 0.51 mm links, 0.77 mm tief  
 Streuwert 1.26, horizontal: 1.13, vertikal: 1.37

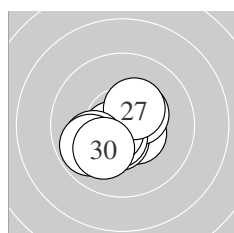

Serie 3:  
 10.5 \*                      10.7 \*                      10.5 \*                      10.4 \*                      10.6 \*  
 10.6 \*                      10.4 \*                      10.0 ↙                      9.8 ↙                      10.1 ↘  
 beste Teiler 72.1 (22.) 85.4 (26.) 98.8 (25.)  
 Trefferlage 0.48 mm links, 0.59 mm tief  
 Streuwert 1.09, horizontal: 1.22, vertikal: 0.93

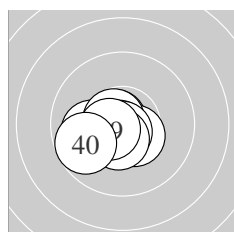

Serie 4:  
 10.8 \*                      10.7 \*                      10.0 ↙                      10.5 \*                      10.7 \*  
 10.7 \*                      10.7 \*                      10.5 \*                      10.5 \*                      9.7 ↙  
 beste Teiler 45.4 (31.) 57.7 (37.) 58.1 (36.)  
 Trefferlage 0.71 mm links, 0.51 mm tief  
 Streuwert 0.83, horizontal: 1.04, vertikal: 0.54

Unterschrift des Schützen

Meyton Elektronik

Ergebnis: **415.1** (395)  
 Serien: 102.2 102.7 105.9 104.3  
 Zähler: 35 5 0 0 0 0 0 0 0 0  
 Innenzehner: 30  
 weiteste: 455 (6), 405 (1), 298 (18)  
 beste Teiler 7.0 (30.) 8.6 (37.) 26.2 (4.)  
 Trefferlage 0.26 mm links, 0.74 mm hoch  
 Streuwert 1.11, horizontal: 1.18, vertikal: 1.04

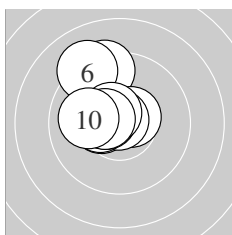
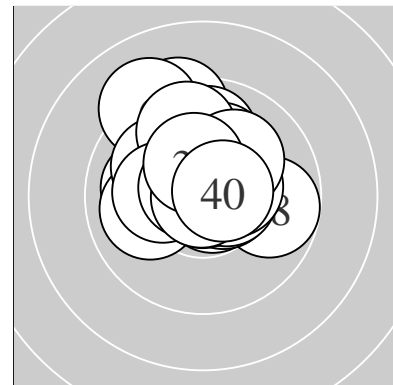

Serie 1:  
 9.3 ↑                      10.4 \*                      10.6 \*                      10.8 \*                      10.4 \*  
 9.1 ↘                      10.5 \*                      10.6 \*                      10.5 \*                      10.0 ←  
 beste Teiler 26.2 (4.) 94.8 (3.) 98.2 (8.)  
 Trefferlage 1.05 mm links, 1.03 mm hoch  
 Streuwert 1.27, horizontal: 0.96, vertikal: 1.52

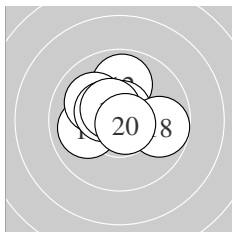

Serie 2:  
 10.2 \*                      9.9 ↑                      10.4 \*                      10.0 ←                      10.0 ↘  
 10.4 \*                      10.7 \*                      9.8 →                      10.5 \*                      10.8 \*  
 beste Teiler 50.4 (20.) 69.7 (17.) 108.0 (19.)  
 Trefferlage 0.51 mm links, 0.64 mm hoch  
 Streuwert 1.28, horizontal: 1.52, vertikal: 0.98

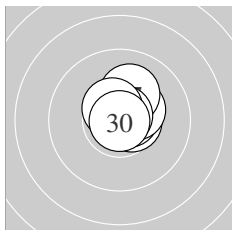

Serie 3:  
 10.6 \*                      10.6 \*                      10.5 \*                      10.7 \*                      10.8 \*  
 10.4 \*                      10.1 ↑                      10.8 \*                      10.5 \*                      10.9 \*  
 beste Teiler 7.0 (30.) 39.4 (28.) 43.1 (25.)  
 Trefferlage 0.41 mm rechts, 0.55 mm hoch  
 Streuwert 0.59, horizontal: 0.52, vertikal: 0.64

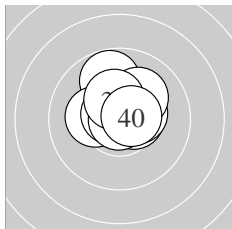

Serie 4:  
 10.5 \*                      10.7 \*                      10.4 \*                      9.8 ↑                      10.2 \*  
 10.7 \*                      10.9 \*                      10.1 ↗                      10.4 \*                      10.6 \*  
 beste Teiler 8.6 (37.) 64.1 (32.) 73.0 (36.)  
 Trefferlage 0.10 mm rechts, 0.76 mm hoch  
 Streuwert 0.98, horizontal: 1.03, vertikal: 0.92

Unterschrift des Schützen

Meyton Elektronik