

Ergebnis: **408.1** (392)  
 Serien: 101.2 101.6 103.7 101.6  
 Zaehler: 33 6 1 0 0 0 0 0 0  
 Innenzehner: 28  
 weiteste: 564 (5), 491 (1), 485 (18)  
 beste Teiler 16.1 (27.) 56.6 (3.) 58.1 (40.)  
 Trefferlage 0.19 mm rechts, 0.21 mm tief  
 Streuwert 1.61, horizontal: 1.69, vertikal: 1.53

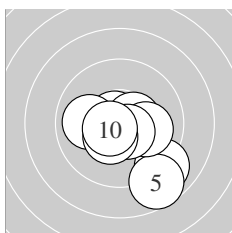

Serie 1:  
 9.0 ↘                      10.6 \*                      10.7 \*                      10.5 \*                      8.7 ↘  
 10.1 →                      10.0 ←                      10.6 \*                      10.4 \*                      10.6 \*  
 beste Teiler 56.6 (3.) 86.0 (2.) 91.3 (10.)  
 Trefferlage 0.64 mm rechts, 1.09 mm tief  
 Streuwert 1.77, horizontal: 1.85, vertikal: 1.70

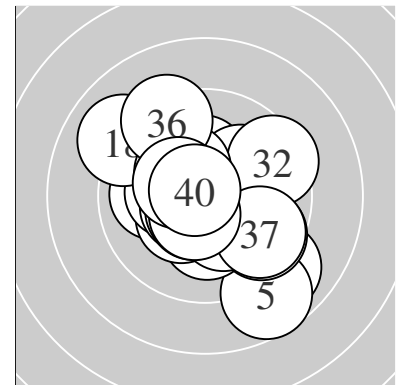
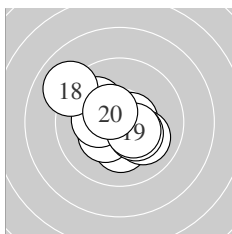

Serie 2:  
 10.2 \*                      10.6 \*                      10.0 ↘                      10.3 \*                      10.3 \*  
 10.0 ↖                      10.3 \*                      9.0 ↖                      10.4 \*                      10.5 \*  
 beste Teiler 89.8 (12.) 113.9 (20.) 131.8 (19.)  
 Trefferlage 0.41 mm links, 0.03 mm tief  
 Streuwert 1.64, horizontal: 1.84, vertikal: 1.41

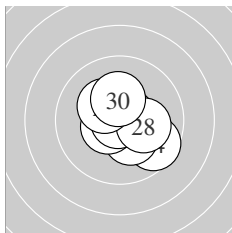

Serie 3:  
 10.3 \*                      10.6 \*                      10.7 \*                      9.6 ↘                      10.3 \*  
 10.5 \*                      10.9 \*                      10.2 \*                      10.3 \*                      10.3 \*  
 beste Teiler 16.1 (27.) 69.0 (23.) 85.3 (22.)  
 Trefferlage 0.41 mm rechts, 0.20 mm tief  
 Streuwert 1.22, horizontal: 1.32, vertikal: 1.10

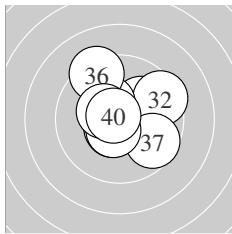

Serie 4:  
 10.1 ↗                      9.5 ↗                      10.3 \*                      10.5 \*                      10.6 \*  
 9.3 ↘                      9.7 ↘                      10.5 \*                      10.4 \*                      10.7 \*  
 beste Teiler 58.1 (40.) 99.0 (35.) 103.4 (38.)  
 Trefferlage 0.13 mm rechts, 0.46 mm hoch  
 Streuwert 1.70, horizontal: 1.79, vertikal: 1.62

Unterschrift des Schuetzen

Meyton Elektronik

Ergebnis: **395.9** (377)  
 Serien: 98.0 94.5 101.6 101.8  
 Zaehler: 22 14 3 1 0 0 0 0 0 0  
 Innenzehner: 21  
 weiteste: 963 (16), 749 (12), 652 (19)  
 beste Teiler 38.4 (28.) 45.8 (24.) 71.1 (36.)  
 Trefferlage 0.37 mm links, 0.86 mm tief  
 Streuwert 2.27, horizontal: 2.46, vertikal: 2.05

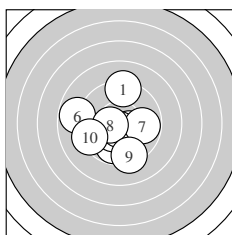
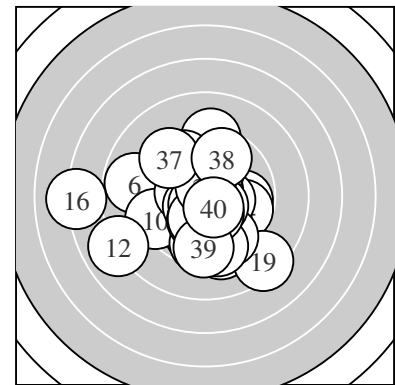

Serie 1:  
 9.2 ↑                      10.4 \*                      9.8 ↓                      10.3 \*                      10.6 \*  
 8.8 ←                      9.8 →                      10.5 \*                      9.3 ↓                      9.3 ←  
 beste Teiler 78.4 (5.) 119.2 (8.) 136.8 (2.)  
 Trefferlage 0.62 mm links, 0.66 mm tief  
 Streuwert 2.31, horizontal: 2.39, vertikal: 2.23

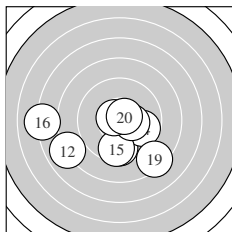

Serie 2:  
 9.6 ↓                      8.0 ↖                      10.5 \*                      9.8 →                      9.5 ↓  
 7.1 ←                      10.3 \*                      10.7 \*                      8.3 ↘                      10.7 \*  
 beste Teiler 75.2 (18.) 75.4 (20.) 115.6 (13.)  
 Trefferlage 0.73 mm links, 1.73 mm tief  
 Streuwert 3.29, horizontal: 4.22, vertikal: 1.95

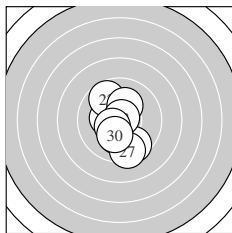

Serie 3:  
 10.3 \*                      9.7 ↘                      10.2 \*                      10.8 \*                      10.1 ↓  
 9.6 ↘                      9.4 ↓                      10.8 \*                      10.5 \*                      10.2 \*  
 beste Teiler 38.4 (28.) 45.8 (24.) 119.2 (29.)  
 Trefferlage 0.15 mm links, 0.67 mm tief  
 Streuwert 1.63, horizontal: 1.08, vertikal: 2.03

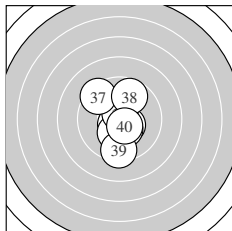

Serie 4:  
 10.6 \*                      10.5 \*                      10.4 \*                      10.4 \*                      10.2 \*  
 10.7 \*                      9.4 ↘                      9.7 ↑                      9.4 ↓                      10.5 \*  
 beste Teiler 71.1 (36.) 80.4 (31.) 106.6 (40.)  
 Trefferlage 0.00 mm , 0.40 mm tief  
 Streuwert 1.65, horizontal: 1.11, vertikal: 2.05

Unterschrift des Schuetzen

Meyton Elektronik

Ergebnis: **416.8** (397)  
 Serien: 104.7 103.5 103.8 104.8  
 Zaehler: 37 3 0 0 0 0 0 0 0 0  
 Innenzehner: 33  
 weiteste: 322 (25), 272 (20), 262 (14)  
 beste Teiler 22.1 (28.) 22.6 (39.) 35.4 (21.)  
 Trefferlage 0.36 mm links, 0.11 mm hoch  
 Streuwert 1.05, horizontal: 1.20, vertikal: 0.88

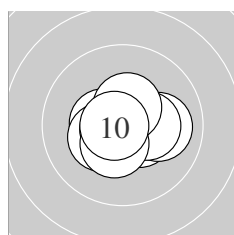
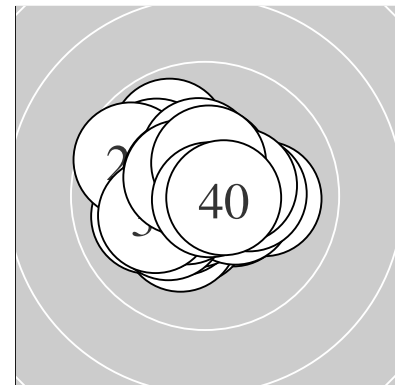

Serie 1:  
 10.5 \* 10.0 → 10.5 \* 10.3 \* 10.7 \*  
 10.8 \* 10.3 \* 10.5 \* 10.4 \* 10.7 \*  
 beste Teiler 46.5 (6.) 54.1 (10.) 61.7 (5.)  
 Trefferlage 0.15 mm rechts, 0.17 mm tief  
 Streuwert 0.96, horizontal: 1.21, vertikal: 0.62

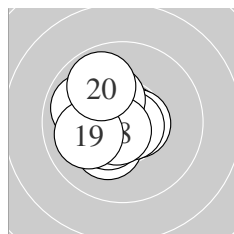

Serie 2:  
 10.2 \* 10.8 \* 10.4 \* 9.9 ↖ 10.6 \*  
 10.7 \* 10.3 \* 10.7 \* 10.0 ← 9.9 ↗  
 beste Teiler 41.2 (12.) 52.7 (16.) 66.2 (18.)  
 Trefferlage 0.73 mm links, 0.08 mm hoch  
 Streuwert 1.14, horizontal: 1.11, vertikal: 1.18

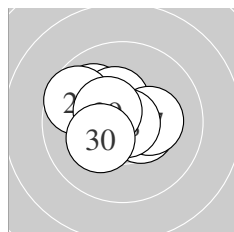

Serie 3:  
 10.8 \* 10.0 ↘ 10.4 \* 10.6 \* 9.7 ↖  
 10.4 \* 10.3 \* 10.9 \* 10.5 \* 10.2 \*  
 beste Teiler 22.1 (28.) 35.4 (21.) 86.9 (24.)  
 Trefferlage 0.51 mm links, 0.32 mm hoch  
 Streuwert 1.18, horizontal: 1.41, vertikal: 0.89

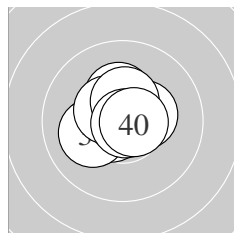

Serie 4:  
 10.2 \* 10.4 \* 10.3 \* 10.6 \* 10.7 \*  
 10.1 ← 10.5 \* 10.4 \* 10.9 \* 10.7 \*  
 beste Teiler 22.6 (39.) 51.0 (35.) 73.3 (40.)  
 Trefferlage 0.35 mm links, 0.23 mm hoch  
 Streuwert 0.93, horizontal: 1.05, vertikal: 0.80

Unterschrift des Schuetzen

Meyton Elektronik

Ergebnis: **422.1** (400)  
 Serien: 105.7 105.5 105.5 105.4  
 Zaehler: 40 0 0 0 0 0 0 0 0 0  
 Innenzehner: 39  
 weiteste: 245 (32), 191 (12), 162 (1)  
 beste Teiler 13.0 (38.) 21.3 (10.) 23.1 (37.)  
 Trefferlage 0.04 mm rechts, 0.02 mm hoch  
 Streuwert 0.79, horizontal: 0.87, vertikal: 0.70

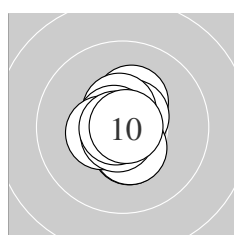
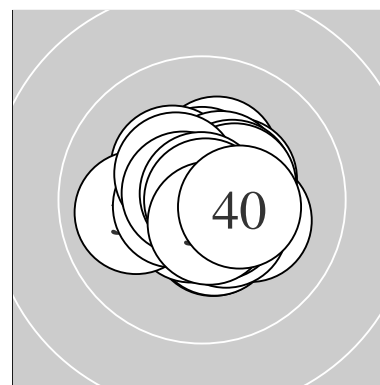

Serie 1:  
 10.3 \*                      10.6 \*                      10.4 \*                      10.4 \*                      10.5 \*  
 10.7 \*                      10.4 \*                      10.7 \*                      10.8 \*                      10.9 \*  
 beste Teiler 21.3 (10.) 41.3 (9.) 57.1 (8.)  
 Trefferlage 0.05 mm links, 0.01 mm hoch  
 Streuwert 0.77, horizontal: 0.59, vertikal: 0.91

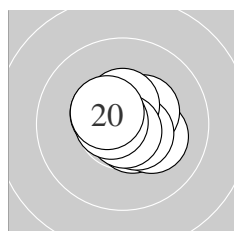

Serie 2:  
 10.6 \*                      10.2 \*                      10.4 \*                      10.5 \*                      10.8 \*  
 10.5 \*                      10.5 \*                      10.8 \*                      10.7 \*                      10.5 \*  
 beste Teiler 34.0 (15.) 45.2 (18.) 69.8 (19.)  
 Trefferlage 0.21 mm rechts, 0.05 mm hoch  
 Streuwert 0.82, horizontal: 0.92, vertikal: 0.71

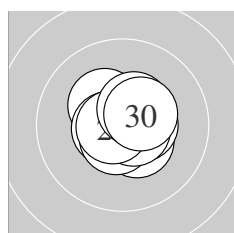

Serie 3:  
 10.3 \*                      10.6 \*                      10.8 \*                      10.4 \*                      10.5 \*  
 10.6 \*                      10.7 \*                      10.7 \*                      10.5 \*                      10.4 \*  
 beste Teiler 30.4 (23.) 60.0 (28.) 71.5 (27.)  
 Trefferlage 0.17 mm rechts, 0.08 mm hoch  
 Streuwert 0.78, horizontal: 0.84, vertikal: 0.71

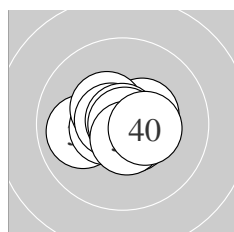

Serie 4:  
 10.4 \*                      10.0 ←                      10.5 \*                      10.4 \*                      10.7 \*  
 10.6 \*                      10.9 \*                      10.9 \*                      10.6 \*                      10.4 \*  
 beste Teiler 13.0 (38.) 23.1 (37.) 73.3 (35.)  
 Trefferlage 0.15 mm links, 0.04 mm tief  
 Streuwert 0.90, horizontal: 1.15, vertikal: 0.56

Unterschrift des Schuetzen

Meyton Elektronik

Ergebnis: **411.7** (394)  
 Serien: 103.4 102.9 102.9 102.5  
 Zaehler: 34 6 0 0 0 0 0 0 0 0  
 Innenzehner: 30  
 weiteste: 404 (33), 378 (39), 365 (2)  
 beste Teiler 15.6 (38.) 40.7 (9.) 41.7 (8.)  
 Trefferlage 0.00 mm , 0.14 mm hoch  
 Streuwert 1.35, horizontal: 1.20, vertikal: 1.49

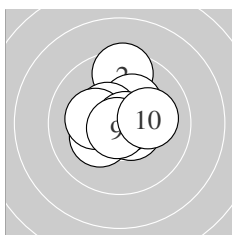
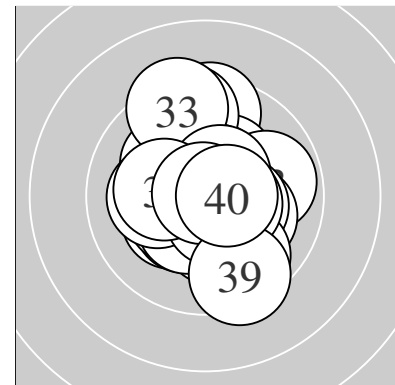

Serie 1:  
 10.3 \* 9.5 ↑ 10.3 \* 10.3 \* 10.5 \*  
 10.2 \* 10.6 \* 10.8 \* 10.8 \* 10.1 →  
 beste Teiler 40.7 (9.) 41.7 (8.) 97.2 (7.)  
 Trefferlage 0.12 mm rechts, 0.57 mm hoch  
 Streuwert 1.26, horizontal: 1.22, vertikal: 1.30

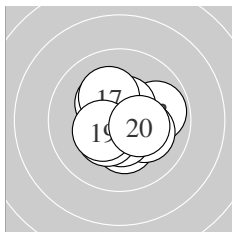

Serie 2:  
 10.3 \* 10.3 \* 9.9 → 10.5 \* 10.1 →  
 10.5 \* 10.2 \* 10.4 \* 10.4 \* 10.3 \*  
 beste Teiler 108.4 (14.) 118.7 (16.) 145.6 (19.)  
 Trefferlage 0.29 mm rechts, 0.15 mm tief  
 Streuwert 1.27, horizontal: 1.34, vertikal: 1.19

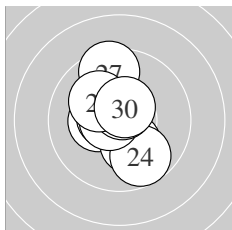

Serie 3:  
 10.7 \* 10.3 \* 10.2 \* 9.7 ↘ 10.6 \*  
 10.7 \* 9.5 ↑ 10.6 \* 10.1 ↖ 10.5 \*  
 beste Teiler 64.1 (21.) 74.0 (26.) 82.7 (28.)  
 Trefferlage 0.32 mm links, 0.24 mm hoch  
 Streuwert 1.39, horizontal: 1.01, vertikal: 1.68

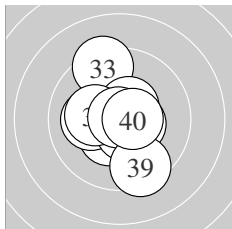

Serie 4:  
 10.4 \* 10.1 ← 9.3 ↑ 10.5 \* 10.5 \*  
 10.6 \* 10.2 \* 10.9 \* 9.4 ↘ 10.6 \*  
 beste Teiler 15.6 (38.) 96.0 (40.) 98.8 (36.)  
 Trefferlage 0.12 mm links, 0.07 mm tief  
 Streuwert 1.58, horizontal: 1.29, vertikal: 1.82

Unterschrift des Schuetzen

Ergebnis: **418.4** (398)  
 Serien: 104.0 105.5 103.9 105.0  
 Zaehler: 38 2 0 0 0 0 0 0 0 0  
 Innenzehner: 35  
 weiteste: 271 (30), 263 (8), 242 (2)  
 beste Teiler 16.0 (17.) 21.3 (35.) 37.6 (7.)  
 Trefferlage 0.37 mm rechts, 0.01 mm tief  
 Streuwert 0.98, horizontal: 0.95, vertikal: 1.01

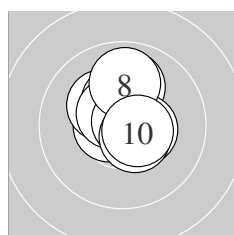
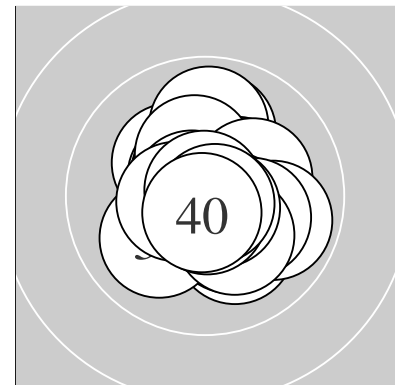

Serie 1:  
 10.6 \* 10.0 ↑ 10.2 \* 10.3 \* 10.6 \*  
 10.5 \* 10.8 \* 9.9 ↑ 10.5 \* 10.6 \*  
 beste Teiler 37.6 (7.) 86.2 (1.) 100.5 (5.)  
 Trefferlage 0.06 mm rechts, 0.73 mm hoch  
 Streuwert 1.01, horizontal: 0.83, vertikal: 1.17

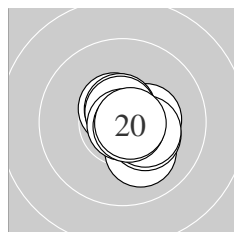

Serie 2:  
 10.6 \* 10.4 \* 10.1 ↘ 10.3 \* 10.6 \*  
 10.7 \* 10.9 \* 10.3 \* 10.8 \* 10.8 \*  
 beste Teiler 16.0 (17.) 47.4 (19.) 49.6 (20.)  
 Trefferlage 0.55 mm rechts, 0.12 mm tief  
 Streuwert 0.79, horizontal: 0.76, vertikal: 0.82

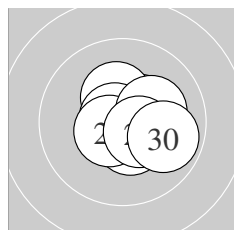

Serie 3:  
 10.4 \* 10.6 \* 10.3 \* 10.2 \* 10.7 \*  
 10.5 \* 10.6 \* 10.2 \* 10.5 \* 9.9 ↘  
 beste Teiler 53.7 (25.) 99.2 (27.) 100.0 (22.)  
 Trefferlage 0.70 mm rechts, 0.07 mm hoch  
 Streuwert 1.02, horizontal: 1.13, vertikal: 0.89

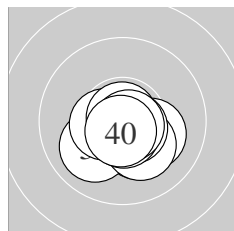

Serie 4:  
 10.3 \* 10.2 \* 10.0 ↙ 10.5 \* 10.9 \*  
 10.2 \* 10.7 \* 10.7 \* 10.8 \* 10.7 \*  
 beste Teiler 21.3 (35.) 47.0 (39.) 64.1 (40.)  
 Trefferlage 0.18 mm rechts, 0.73 mm tief  
 Streuwert 0.84, horizontal: 1.03, vertikal: 0.60

Unterschrift des Schuetzen

Ergebnis: **409.7** (390)  
 Serien: 103.0 103.3 102.6 100.8  
 Zaehler: 30 10 0 0 0 0 0 0 0 0  
 Innenzehner: 26  
 weiteste: 453 (23), 408 (33), 393 (37)  
 beste Teiler 19.6 (20.) 20.0 (25.) 33.0 (30.)  
 Trefferlage 0.59 mm links, 0.68 mm hoch  
 Streuwert 1.40, horizontal: 1.50, vertikal: 1.29

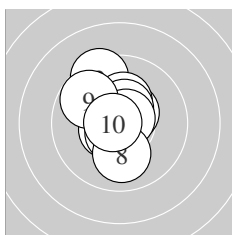
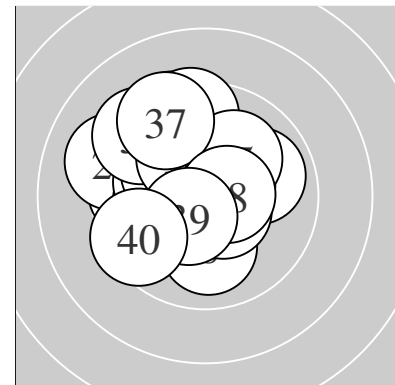

Serie 1:  
 10.5 \* 9.4 ↖ 10.3 \* 10.5 \* 10.6 \*  
 10.5 \* 10.7 \* 10.0 ↓ 9.8 ↗ 10.7 \*  
 beste Teiler 53.2 (10.) 62.0 (7.) 88.1 (5.)  
 Trefferlage 0.36 mm links, 0.58 mm hoch  
 Streuwert 1.34, horizontal: 1.00, vertikal: 1.62

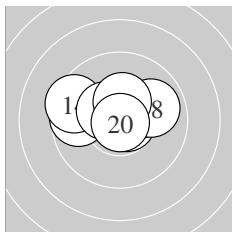

Serie 2:  
 10.7 \* 9.7 ← 10.7 \* 9.5 ↖ 10.3 \*  
 10.8 \* 10.4 \* 9.9 → 10.4 \* 10.9 \*  
 beste Teiler 19.6 (20.) 33.7 (16.) 55.9 (13.)  
 Trefferlage 0.34 mm links, 0.60 mm hoch  
 Streuwert 1.36, horizontal: 1.84, vertikal: 0.55

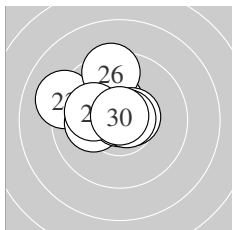

Serie 3:  
 10.4 \* 10.4 \* 9.1 ↖ 10.1 ← 10.9 \*  
 9.5 ↑ 10.1 ↖ 10.6 \* 10.7 \* 10.8 \*  
 beste Teiler 20.0 (25.) 33.0 (30.) 56.2 (29.)  
 Trefferlage 0.92 mm links, 0.82 mm hoch  
 Streuwert 1.36, horizontal: 1.53, vertikal: 1.16

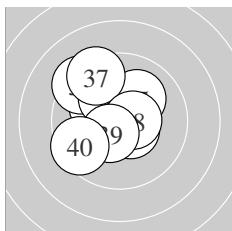

Serie 4:  
 10.2 \* 10.6 \* 9.3 ↖ 10.2 \* 10.1 ↗  
 10.5 \* 9.4 ↖ 10.5 \* 10.5 \* 9.5 ↖  
 beste Teiler 79.0 (32.) 101.2 (38.) 106.8 (36.)  
 Trefferlage 0.72 mm links, 0.74 mm hoch  
 Streuwert 1.69, horizontal: 1.66, vertikal: 1.72

Unterschrift des Schuetzen

Ergebnis: **411.1** (394)  
 Serien: 102.7 103.7 102.7 102.0  
 Zaehler: 35 4 1 0 0 0 0 0 0 0  
 Innenzehner: 30  
 weiteste: 570 (15), 407 (34), 376 (33)  
 beste Teiler 18.3 (18.) 38.0 (16.) 39.6 (39.)  
 Trefferlage 0.00 mm , 0.35 mm hoch  
 Streuwert 1.44, horizontal: 1.73, vertikal: 1.07

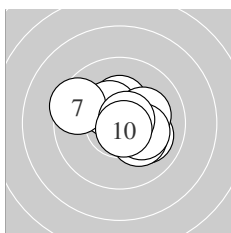
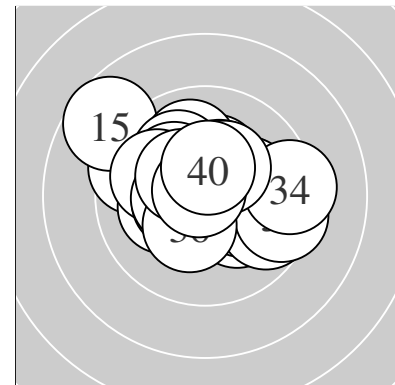

Serie 1:  
 10.3 \* 10.5 \* 10.4 \* 10.0 ↘ 10.2 \*  
 10.2 \* 9.5 ↙ 10.2 \* 10.7 \* 10.7 \*  
 beste Teiler 55.8 (10.) 62.1 (9.) 120.0 (2.)  
 Trefferlage 0.51 mm rechts, 0.17 mm hoch  
 Streuwert 1.35, horizontal: 1.64, vertikal: 0.99

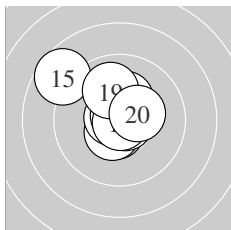

Serie 2:  
 10.6 \* 10.5 \* 10.7 \* 10.3 \* 8.7 ↘  
 10.8 \* 10.8 \* 10.9 \* 10.0 ↑ 10.4 \*  
 beste Teiler 18.3 (18.) 38.0 (16.) 47.9 (17.)  
 Trefferlage 0.44 mm links, 0.63 mm hoch  
 Streuwert 1.50, horizontal: 1.58, vertikal: 1.43

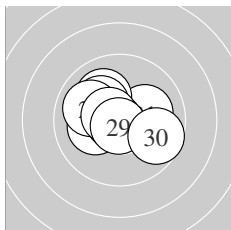

Serie 3:  
 10.1 → 10.2 \* 10.2 \* 10.1 ↘ 10.8 \*  
 10.2 \* 10.0 ↙ 10.6 \* 10.8 \* 9.7 ↘  
 beste Teiler 45.7 (25.) 47.8 (29.) 90.4 (28.)  
 Trefferlage 0.52 mm links, 0.29 mm hoch  
 Streuwert 1.38, horizontal: 1.72, vertikal: 0.93

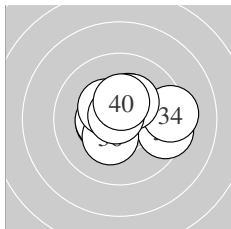

Serie 4:  
 10.3 \* 10.4 \* 9.4 → 9.3 → 10.4 \*  
 10.3 \* 10.3 \* 10.4 \* 10.8 \* 10.4 \*  
 beste Teiler 39.6 (39.) 129.2 (32.) 130.4 (35.)  
 Trefferlage 0.47 mm rechts, 0.30 mm hoch  
 Streuwert 1.54, horizontal: 1.94, vertikal: 0.98

Unterschrift des Schuetzen



Ergebnis: **408.4** (390)  
 Serien: 102.5 102.2 101.6 102.1  
 Zaehler: 30 10 0 0 0 0 0 0 0 0  
 Innenzehner: 25  
 weiteste: 468 (27), 409 (35), 365 (12)  
 beste Teiler 2.0 (26.) 43.3 (1.) 72.5 (22.)  
 Trefferlage 0.06 mm rechts, 0.08 mm tief  
 Streuwert 1.50, horizontal: 1.79, vertikal: 1.14

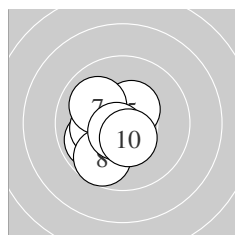
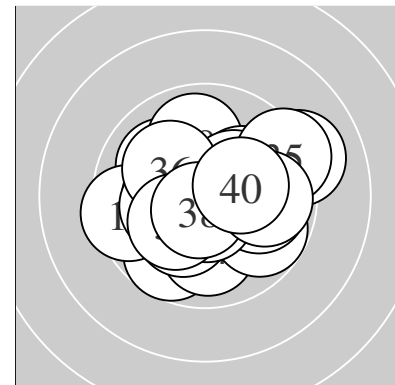

Serie 1:  
 10.8 \*                      10.2 \*                      9.9 ↙                      10.2 \*                      10.4 \*  
 10.2 \*                      10.0 ↘                      9.7 ↘                      10.6 \*                      10.5 \*  
 beste Teiler 43.3 (1.) 78.6 (9.) 122.1 (10.)  
 Trefferlage 1.03 mm links, 0.50 mm tief  
 Streuwert 1.13, horizontal: 1.12, vertikal: 1.14

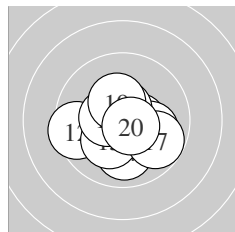

Serie 2:  
 10.5 \*                      9.5 ←                      10.1 →                      10.0 ↓                      10.2 \*  
 10.6 \*                      9.8 ↘                      10.5 \*                      10.4 \*                      10.6 \*  
 beste Teiler 78.8 (20.) 87.0 (16.) 118.6 (18.)  
 Trefferlage 0.04 mm rechts, 0.51 mm tief  
 Streuwert 1.50, horizontal: 1.77, vertikal: 1.16

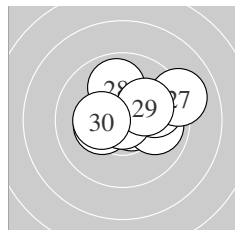

Serie 3:  
 10.3 \*                      10.7 \*                      9.9 →                      10.5 \*                      9.9 →  
 10.9 \*                      9.1 →                      9.9 ↑                      10.1 →                      10.3 \*  
 beste Teiler 2.0 (26.) 72.5 (22.) 119.3 (24.)  
 Trefferlage 0.87 mm rechts, 0.61 mm hoch  
 Streuwert 1.53, horizontal: 1.92, vertikal: 1.00

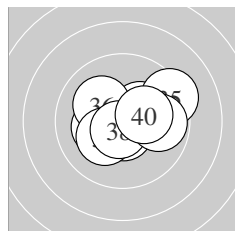

Serie 4:  
 10.6 \*                      10.6 \*                      10.3 \*                      10.2 \*                      9.3 →  
 10.1 ↘                      10.2 \*                      10.7 \*                      9.8 →                      10.3 \*  
 beste Teiler 72.6 (38.) 85.4 (31.) 90.4 (32.)  
 Trefferlage 0.37 mm rechts, 0.06 mm hoch  
 Streuwert 1.52, horizontal: 1.91, vertikal: 1.00

Unterschrift des Schuetzen

Meyton Elektronik

Ergebnis: **405.5** (388)  
 Serien: 103.4 99.5 101.2 101.4  
 Zaehler: 28 12 0 0 0 0 0 0 0 0  
 Innenzehner: 24  
 weiteste: 431 (36), 415 (29), 412 (17)  
 beste Teiler 65.2 (25.) 68.9 (10.) 76.8 (9.)  
 Trefferlage 0.25 mm rechts, 0.40 mm hoch  
 Streuwert 1.62, horizontal: 1.79, vertikal: 1.42

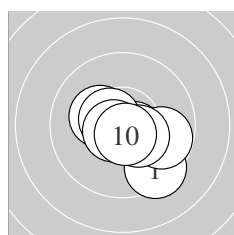
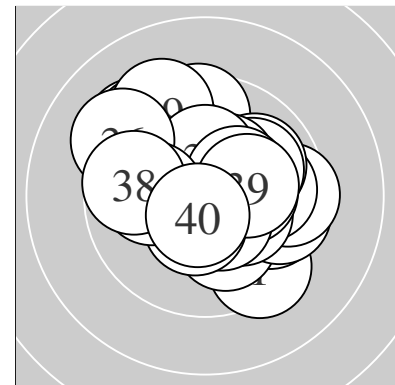

Serie 1:  
 9.4 ↘ 10.6 \* 9.8 → 10.5 \* 10.6 \*  
 10.3 \* 10.5 \* 10.4 \* 10.6 \* 10.7 \*  
 beste Teiler 68.9 (10.) 76.8 (9.) 94.2 (5.)  
 Trefferlage 0.20 mm rechts, 0.48 mm tief  
 Streuwert 1.31, horizontal: 1.53, vertikal: 1.06

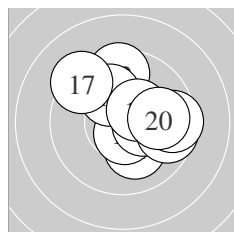

Serie 2:  
 10.1 ↘ 9.6 ↑ 10.6 \* 10.4 \* 9.6 →  
 10.1 ↘ 9.3 ↘ 9.5 → 10.4 \* 9.9 →  
 beste Teiler 83.3 (13.) 137.9 (19.) 149.4 (14.)  
 Trefferlage 0.88 mm rechts, 0.58 mm hoch  
 Streuwert 1.86, horizontal: 2.00, vertikal: 1.71

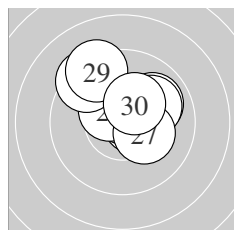

Serie 3:  
 10.6 \* 10.3 \* 9.9 ↗ 10.0 ↗ 10.7 \*  
 10.4 \* 10.3 \* 9.4 ↘ 9.3 ↘ 10.3 \*  
 beste Teiler 65.2 (25.) 83.0 (21.) 128.8 (26.)  
 Trefferlage 0.34 mm rechts, 1.19 mm hoch  
 Streuwert 1.49, horizontal: 1.65, vertikal: 1.31

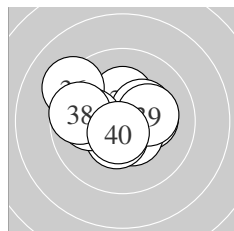

Serie 4:  
 10.3 \* 10.2 \* 10.5 \* 10.3 \* 10.4 \*  
 9.2 ↘ 10.0 ← 9.7 ← 10.2 \* 10.6 \*  
 beste Teiler 89.8 (40.) 120.6 (33.) 127.4 (35.)  
 Trefferlage 0.40 mm links, 0.31 mm hoch  
 Streuwert 1.62, horizontal: 1.98, vertikal: 1.15

Unterschrift des Schuetzen

Meyton Elektronik

Ergebnis: **411.1** (392)  
 Serien: 103.2 102.3 102.9 102.7  
 Zaehler: 32 8 0 0 0 0 0 0 0 0  
 Innenzehner: 25  
 weiteste: 465 (30), 366 (11), 288 (34)  
 beste Teiler 13.0 (25.) 20.5 (22.) 60.3 (12.)  
 Trefferlage 0.38 mm links, 0.26 mm hoch  
 Streuwert 1.34, horizontal: 1.56, vertikal: 1.07

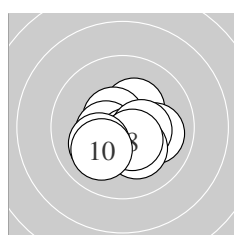
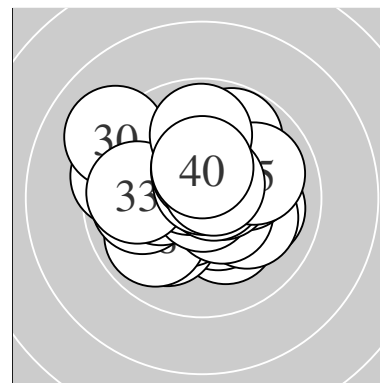

Serie 1:  
 10.3 \* 10.0 → 10.6 \* 10.4 \* 10.6 \*  
 10.4 \* 10.2 \* 10.5 \* 10.1 ↙ 10.1 ↙  
 beste Teiler 92.3 (5.) 96.1 (3.) 117.0 (8.)  
 Trefferlage 0.14 mm rechts, 0.51 mm tief  
 Streuwert 1.17, horizontal: 1.36, vertikal: 0.95

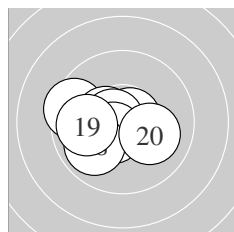

Serie 2:  
 9.5 ← 10.7 \* 10.3 \* 10.3 \* 10.4 \*  
 10.7 \* 10.5 \* 9.9 ↙ 9.9 ← 10.1 →  
 beste Teiler 60.3 (12.) 72.2 (16.) 104.8 (17.)  
 Trefferlage 1.15 mm links, 0.18 mm tief  
 Streuwert 1.23, horizontal: 1.57, vertikal: 0.74

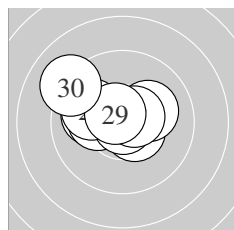

Serie 3:  
 10.5 \* 10.9 \* 10.0 ← 10.2 \* 10.9 \*  
 10.1 → 10.6 \* 10.0 ← 10.6 \* 9.1 ↖  
 beste Teiler 13.0 (25.) 20.5 (22.) 82.2 (29.)  
 Trefferlage 0.69 mm links, 0.55 mm hoch  
 Streuwert 1.40, horizontal: 1.78, vertikal: 0.88

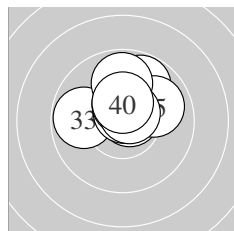

Serie 4:  
 10.7 \* 10.5 \* 9.8 ← 9.8 ↗ 9.9 →  
 9.8 ↑ 10.7 \* 10.5 \* 10.6 \* 10.4 \*  
 beste Teiler 62.8 (37.) 63.8 (31.) 77.9 (39.)  
 Trefferlage 0.16 mm rechts, 1.20 mm hoch  
 Streuwert 1.10, horizontal: 1.30, vertikal: 0.86

Unterschrift des Schuetzen

Meyton Elektronik

Ergebnis: **399.8** (382)  
 Serien: 98.2 99.6 102.4 99.6  
 Zaehler: 25 14 0 0 1 0 0 0 0 0  
 Innenzehner: 20  
 weiteste: 1035 (6), 460 (37), 451 (12)  
 beste Teiler 50.3 (8.) 59.3 (32.) 77.8 (5.)  
 Trefferlage 0.17 mm rechts, 0.38 mm tief  
 Streuwert 2.08, horizontal: 1.97, vertikal: 2.19

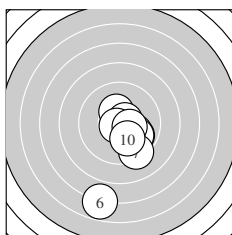
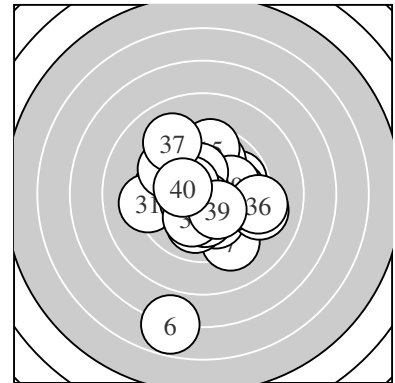

Serie 1:  
 10.3 \*                      9.9 ↘                      10.1 ↘                      9.9 ↘                      10.6 \*  
 6.8 ↓                      9.3 ↘                      10.8 \*                      10.4 \*                      10.1 ↓  
 beste Teiler 50.3 (8.) 77.8 (5.) 136.3 (9.)  
 Trefferlage 0.80 mm rechts, 1.88 mm tief  
 Streuwert 2.50, horizontal: 1.53, vertikal: 3.19

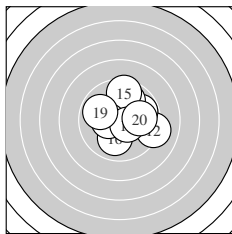

Serie 2:  
 10.6 \*                      9.1 →                      9.8 →                      9.9 ↑                      9.5 ↑  
 10.0 ↓                      10.4 \*                      10.5 \*                      9.9 ↖                      9.9 →  
 beste Teiler 94.3 (11.) 113.8 (18.) 142.4 (17.)  
 Trefferlage 0.84 mm rechts, 0.36 mm hoch  
 Streuwert 1.88, horizontal: 2.02, vertikal: 1.74

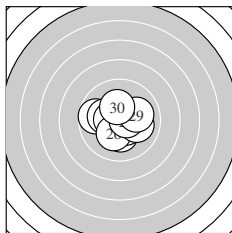

Serie 3:  
 9.7 ←                      10.2 \*                      10.2 \*                      10.5 \*                      10.5 \*  
 10.2 \*                      10.1 →                      10.6 \*                      10.1 →                      10.3 \*  
 beste Teiler 88.0 (28.) 110.4 (25.) 125.8 (24.)  
 Trefferlage 0.10 mm links, 0.17 mm tief  
 Streuwert 1.42, horizontal: 1.68, vertikal: 1.11

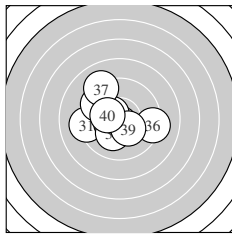

Serie 4:  
 9.2 ←                      10.7 \*                      10.5 \*                      10.5 \*                      9.6 ↖  
 9.2 →                      9.1 ↘                      10.2 \*                      10.3 \*                      10.3 \*  
 beste Teiler 59.3 (32.) 121.6 (33.) 122.8 (34.)  
 Trefferlage 0.85 mm links, 0.13 mm hoch  
 Streuwert 2.04, horizontal: 2.33, vertikal: 1.71

Unterschrift des Schuetzen

Meyton Elektronik

Ergebnis: **403.2** (385)  
 Serien: 100.7 101.3 100.0 101.2  
 Zaehler: 26 13 1 0 0 0 0 0 0  
 Innenzehner: 20  
 weiteste: 547 (22), 500 (25), 405 (8)  
 beste Teiler 39.0 (9.) 43.0 (23.) 58.6 (16.)  
 Trefferlage 0.10 mm links, 0.44 mm hoch  
 Streuwert 1.76, horizontal: 2.06, vertikal: 1.39

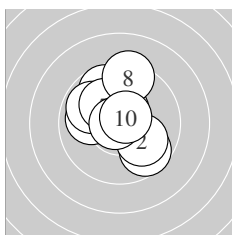
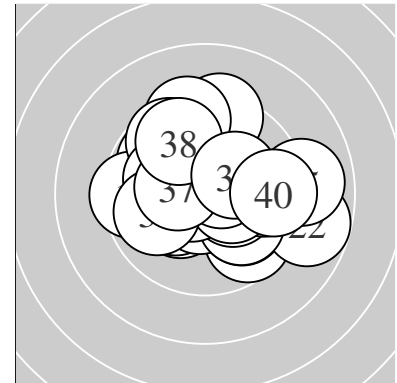

Serie 1:  
 9.7 ↘ 10.0 ↘ 10.5 \* 9.7 ↗ 10.0 ←  
 9.9 ↙ 10.1 ↙ 9.3 ↑ 10.8 \* 10.7 \*  
 beste Teiler 39.0 (9.) 73.5 (10.) 118.3 (3.)  
 Trefferlage 0.20 mm links, 0.80 mm hoch  
 Streuwert 1.74, horizontal: 1.63, vertikal: 1.85

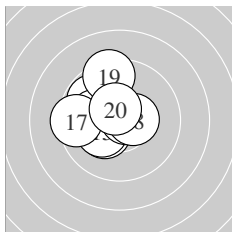

Serie 2:  
 9.8 ↙ 10.3 \* 10.3 \* 10.1 ← 10.2 \*  
 10.7 \* 9.5 ← 10.5 \* 9.4 ↑ 10.5 \*  
 beste Teiler 58.6 (16.) 102.8 (20.) 117.1 (18.)  
 Trefferlage 1.13 mm links, 0.62 mm hoch  
 Streuwert 1.42, horizontal: 1.42, vertikal: 1.42

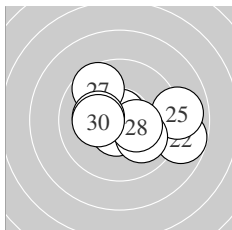

Serie 3:  
 10.5 \* 8.8 → 10.8 \* 10.6 \* 9.0 →  
 10.0 ↘ 9.6 ↙ 10.3 \* 10.2 \* 10.2 \*  
 beste Teiler 43.0 (23.) 90.1 (24.) 117.3 (21.)  
 Trefferlage 0.66 mm rechts, 0.05 mm tief  
 Streuwert 2.09, horizontal: 2.69, vertikal: 1.21

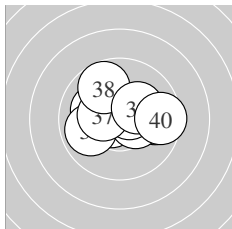

Serie 4:  
 10.7 \* 9.7 → 10.4 \* 10.1 ↙ 10.6 \*  
 9.9 ← 10.4 \* 9.7 ↘ 10.2 \* 9.5 →  
 beste Teiler 71.4 (31.) 97.1 (35.) 141.2 (33.)  
 Trefferlage 0.24 mm rechts, 0.39 mm hoch  
 Streuwert 1.65, horizontal: 2.12, vertikal: 0.98

Unterschrift des Schuetzen

Meyton Elektronik

Ergebnis: **407.3** (387)  
 Serien: 100.9 101.6 103.5 101.3  
 Zaehler: 27 13 0 0 0 0 0 0 0 0  
 Innenzehner: 24  
 weiteste: 433 (11), 392 (12), 390 (37)  
 beste Teiler 49.2 (20.) 49.6 (32.) 78.4 (13.)  
 Trefferlage 0.43 mm links, 0.06 mm tief  
 Streuwert 1.54, horizontal: 1.69, vertikal: 1.38

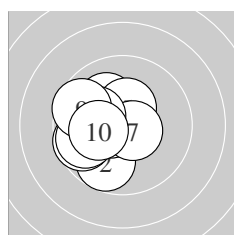
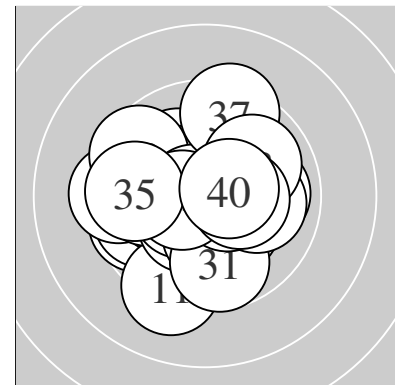

Serie 1:  
 10.1 ↘ 9.8 ↙ 10.6 \* 9.7 ← 10.4 \*  
 9.8 ← 10.6 \* 10.1 ← 9.6 ↖ 10.2 \*  
 beste Teiler 87.2 (7.) 90.9 (3.) 134.3 (5.)  
 Trefferlage 1.50 mm links, 0.09 mm tief  
 Streuwert 1.34, horizontal: 1.32, vertikal: 1.37

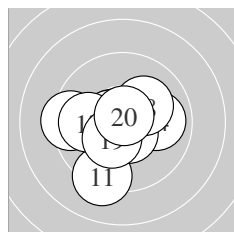

Serie 2:  
 9.2 ↙ 9.4 ← 10.6 \* 9.9 → 10.6 \*  
 10.6 \* 9.9 ← 10.2 \* 10.4 \* 10.8 \*  
 beste Teiler 49.2 (20.) 78.4 (13.) 90.8 (15.)  
 Trefferlage 0.58 mm links, 0.38 mm tief  
 Streuwert 1.68, horizontal: 1.89, vertikal: 1.45

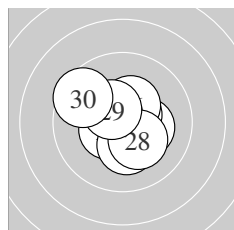

Serie 3:  
 10.6 \* 10.5 \* 10.3 \* 10.6 \* 10.5 \*  
 10.4 \* 10.3 \* 10.3 \* 10.5 \* 9.5 ↗  
 beste Teiler 79.6 (21.) 90.6 (24.) 105.5 (22.)  
 Trefferlage 0.18 mm links, 0.01 mm hoch  
 Streuwert 1.26, horizontal: 1.36, vertikal: 1.15

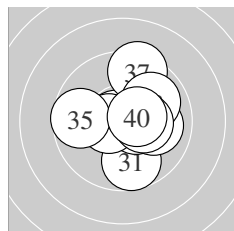

Serie 4:  
 9.7 ↘ 10.8 \* 10.5 \* 10.5 \* 9.7 ←  
 10.0 → 9.4 ↑ 9.9 ↗ 10.3 \* 10.5 \*  
 beste Teiler 49.6 (32.) 104.2 (33.) 104.7 (34.)  
 Trefferlage 0.52 mm rechts, 0.18 mm hoch  
 Streuwert 1.67, horizontal: 1.67, vertikal: 1.67

Unterschrift des Schuetzen