

Ergebnis: **417.1** (395)
 Serien: 104.9 103.1 106.2 102.9
 Zähler: 35 5 0 0 0 0 0 0 0 0
 Innenzehner: 33
 weiteste: 375 (31), 331 (11), 328 (12)
 beste Teiler 6.7 (34.) 13.0 (26.) 28.0 (13.)
 Trefferlage 0.21 mm rechts, 0.37 mm tief
 Streuwert 1.11, horizontal: 1.36, vertikal: 0.80

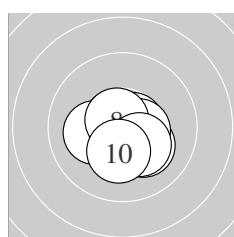

Serie 1:
 10.6 * 10.7 * 10.7 * 10.2 * 10.7 *
 10.2 * 10.5 * 10.7 * 10.3 * 10.3 *
 beste Teiler 65.4 (8.) 67.4 (5.) 70.8 (3.)
 Trefferlage 0.11 mm rechts, 0.43 mm tief
 Streuwert 0.93, horizontal: 1.09, vertikal: 0.75

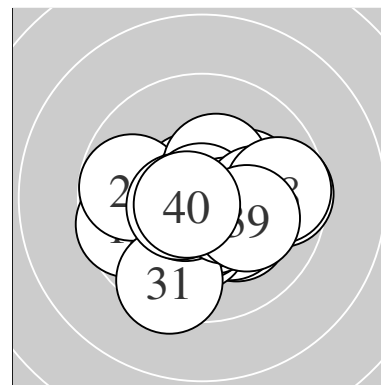
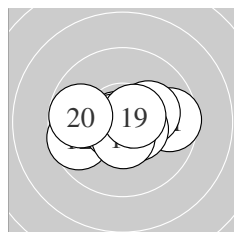

Serie 2:
 9.6 → 9.6 ← 10.8 * 10.8 * 10.2 *
 10.5 * 10.7 * 10.5 * 10.6 * 9.8 ←
 beste Teiler 28.0 (13.) 42.9 (14.) 66.7 (17.)
 Trefferlage 0.01 mm links, 0.15 mm tief
 Streuwert 1.45, horizontal: 1.96, vertikal: 0.60

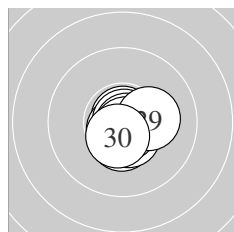

Serie 3:
 10.6 * 10.8 * 10.7 * 10.5 * 10.5 *
 10.9 * 10.8 * 10.7 * 10.2 * 10.5 *
 beste Teiler 13.0 (26.) 28.0 (22.) 35.8 (27.)
 Trefferlage 0.23 mm rechts, 0.45 mm tief
 Streuwert 0.57, horizontal: 0.61, vertikal: 0.54

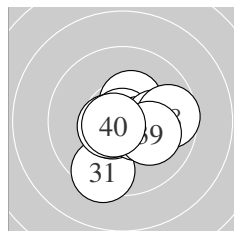

Serie 4:
 9.5 ↓ 10.6 * 10.4 * 10.9 * 10.5 *
 10.0 → 10.5 * 9.7 → 10.1 ↘ 10.7 *
 beste Teiler 6.7 (34.) 69.8 (40.) 82.4 (32.)
 Trefferlage 0.53 mm rechts, 0.43 mm tief
 Streuwert 1.40, horizontal: 1.55, vertikal: 1.23

Unterschrift des Schützen

Meyton Elektronik

Ergebnis: **418.6** (400)
 Serien: 105.0 104.3 104.0 105.3
 Zähler: 40 0 0 0 0 0 0 0 0 0
 Innenzehner: 38
 weiteste: 246 (35), 215 (25), 198 (1)
 beste Teiler 26.0 (28.) 45.6 (7.) 45.9 (10.)
 Trefferlage 0.19 mm rechts, 0.02 mm hoch
 Streuwert 0.94, horizontal: 1.04, vertikal: 0.84

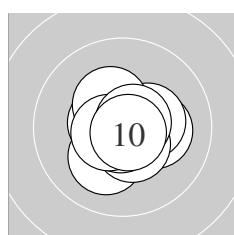
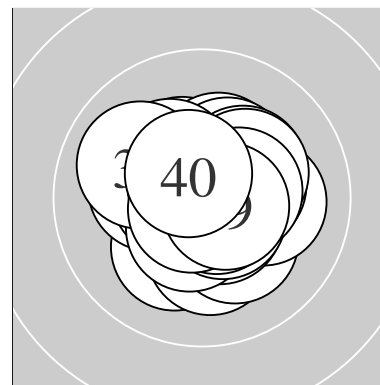

Serie 1:
 10.2 * 10.2 * 10.3 * 10.5 * 10.4 *
 10.5 * 10.8 * 10.6 * 10.7 * 10.8 *
 beste Teiler 45.6 (7.) 45.9 (10.) 68.0 (9.)
 Trefferlage 0.12 mm rechts, 0.17 mm tief
 Streuwert 0.93, horizontal: 1.02, vertikal: 0.82

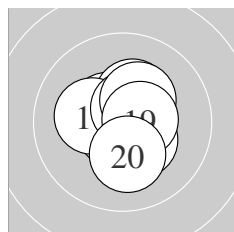

Serie 2:
 10.4 * 10.6 * 10.7 * 10.5 * 10.3 *
 10.2 * 10.6 * 10.3 * 10.5 * 10.2 *
 beste Teiler 62.2 (13.) 88.6 (17.) 92.4 (12.)
 Trefferlage 0.01 mm rechts, 0.16 mm hoch
 Streuwert 1.00, horizontal: 0.97, vertikal: 1.04

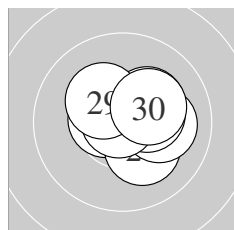

Serie 3:
 10.4 * 10.8 * 10.6 * 10.2 * 10.1 →
 10.3 * 10.3 * 10.8 * 10.3 * 10.2 *
 beste Teiler 26.0 (28.) 47.3 (22.) 98.3 (23.)
 Trefferlage 0.63 mm rechts, 0.21 mm hoch
 Streuwert 1.01, horizontal: 1.17, vertikal: 0.81

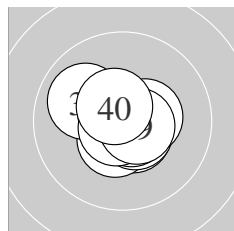

Serie 4:
 10.5 * 10.5 * 10.6 * 10.7 * 10.0 ↖
 10.7 * 10.4 * 10.7 * 10.6 * 10.6 *
 beste Teiler 53.7 (38.) 59.5 (36.) 68.1 (34.)
 Trefferlage 0.01 mm rechts, 0.08 mm tief
 Streuwert 0.88, horizontal: 1.00, vertikal: 0.73

Unterschrift des Schützen

Meyton Elektronik

Ergebnis: **411.0** (391)
 Serien: 100.6 104.3 103.8 102.3
 Zähler: 31 9 0 0 0 0 0 0 0 0
 Innenzehner: 26
 weiteste: 375 (8), 360 (2), 308 (40)
 beste Teiler 26.9 (1.) 30.4 (11.) 54.7 (38.)
 Trefferlage 0.05 mm rechts, 0.12 mm tief
 Streuwert 1.39, horizontal: 1.58, vertikal: 1.16

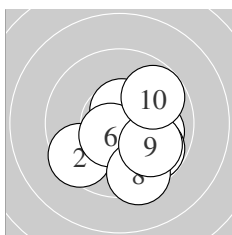
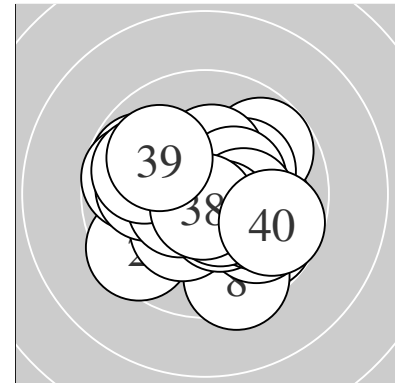

Serie 1:
 10.8 * 9.5 ↙ 10.2 * 10.6 * 10.0 →
 10.5 * 9.8 ↘ 9.5 ↓ 9.9 ↘ 9.8 ↗
 beste Teiler 26.9 (1.) 90.0 (4.) 105.0 (6.)
 Trefferlage 0.88 mm rechts, 0.91 mm tief
 Streuwert 1.61, horizontal: 1.68, vertikal: 1.54

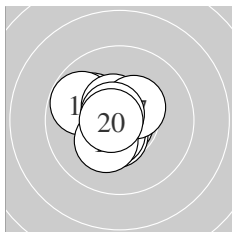

Serie 2:
 10.8 * 10.5 * 10.1 ↖ 10.5 * 9.8 ↖
 10.5 * 10.4 * 10.7 * 10.3 * 10.7 *
 beste Teiler 30.4 (11.) 60.0 (20.) 66.6 (18.)
 Trefferlage 0.66 mm links, 0.08 mm hoch
 Streuwert 1.01, horizontal: 1.02, vertikal: 0.99

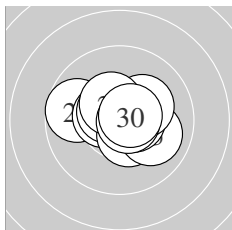

Serie 3:
 9.7 ↖ 10.5 * 10.6 * 10.5 * 10.0 →
 10.6 * 10.2 * 10.4 * 10.7 * 10.6 *
 beste Teiler 60.8 (29.) 82.4 (30.) 99.0 (26.)
 Trefferlage 0.12 mm rechts, 0.18 mm hoch
 Streuwert 1.19, horizontal: 1.52, vertikal: 0.74

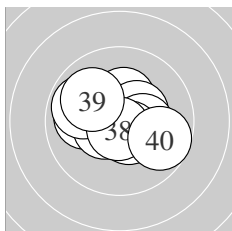

Serie 4:
 10.0 ← 10.5 * 10.3 * 9.9 ↖ 10.4 *
 10.3 * 10.5 * 10.7 * 10.0 ↖ 9.7 ↘
 beste Teiler 54.7 (38.) 104.6 (37.) 114.7 (32.)
 Trefferlage 0.14 mm links, 0.15 mm hoch
 Streuwert 1.46, horizontal: 1.81, vertikal: 0.98

Unterschrift des Schützen

Meyton Elektronik

Ergebnis: **416.4** (399)
 Serien: 103.5 104.5 104.3 104.1
 Zähler: 39 1 0 0 0 0 0 0 0 0
 Innenzehner: 32
 weiteste: 361 (34), 244 (14), 240 (21)
 beste Teiler 13.3 (30.) 50.1 (26.) 57.4 (18.)
 Trefferlage 0.07 mm links, 0.07 mm hoch
 Streuwert 1.10, horizontal: 1.27, vertikal: 0.89

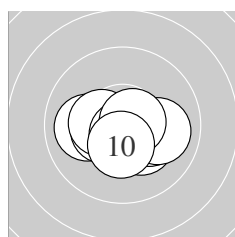
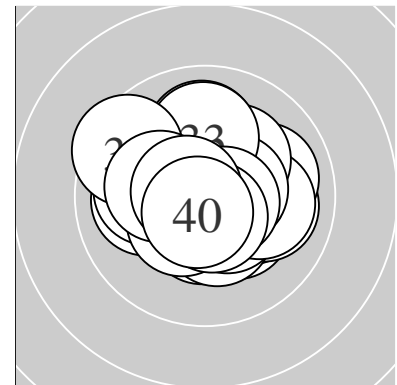

Serie 1:
 10.0 ← 10.4 * 10.3 * 10.4 * 10.4 *
 10.2 * 10.0 → 10.7 * 10.7 * 10.4 *
 beste Teiler 60.0 (8.) 70.2 (9.) 130.0 (2.)
 Trefferlage 0.22 mm rechts, 0.42 mm tief
 Streuwert 1.13, horizontal: 1.53, vertikal: 0.49

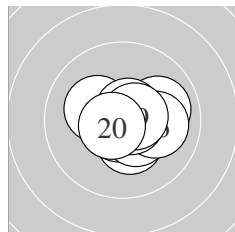

Serie 2:
 10.4 * 10.2 * 10.7 * 10.0 → 10.5 *
 10.1 → 10.7 * 10.7 * 10.6 * 10.6 *
 beste Teiler 57.4 (18.) 61.3 (13.) 67.9 (17.)
 Trefferlage 0.50 mm rechts, 0.12 mm tief
 Streuwert 1.00, horizontal: 1.22, vertikal: 0.71

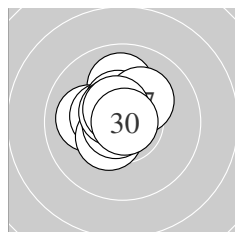

Serie 3:
 10.0 ↑ 10.0 ← 10.4 * 10.4 * 10.4 *
 10.8 * 10.2 * 10.6 * 10.6 * 10.9 *
 beste Teiler 13.3 (30.) 50.1 (26.) 96.1 (29.)
 Trefferlage 0.51 mm links, 0.61 mm hoch
 Streuwert 0.93, horizontal: 0.91, vertikal: 0.95

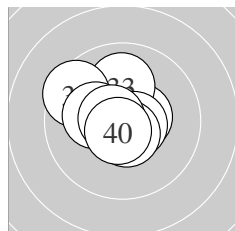

Serie 4:
 10.7 * 10.5 * 10.0 ↑ 9.5 ↘ 10.7 *
 10.2 * 10.6 * 10.6 * 10.6 * 10.7 *
 beste Teiler 58.6 (35.) 62.6 (31.) 72.9 (40.)
 Trefferlage 0.48 mm links, 0.25 mm hoch
 Streuwert 1.14, horizontal: 1.23, vertikal: 1.05

Unterschrift des Schützen

Meyton Elektronik

Ergebnis: **412.9** (394)
 Serien: 103.8 102.9 102.7 103.5
 Zähler: 34 6 0 0 0 0 0 0 0 0
 Innenzehner: 31
 weiteste: 403 (36), 354 (5), 340 (26)
 beste Teiler 17.4 (3.) 45.6 (4.) 54.7 (21.)
 Trefferlage 0.05 mm rechts, 0.08 mm hoch
 Streuwert 1.29, horizontal: 1.35, vertikal: 1.23

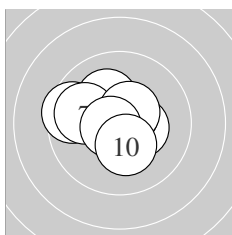
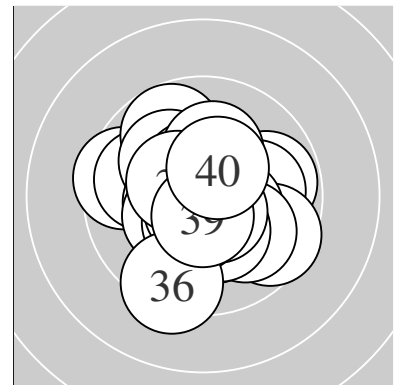

Serie 1:
 10.4 * 10.6 * 10.9 * 10.8 * 9.5 ←
 10.2 * 9.9 ← 10.5 * 10.7 * 10.3 *
 beste Teiler 17.4 (3.) 45.6 (4.) 70.7 (9.)
 Trefferlage 0.44 mm links, 0.21 mm hoch
 Streuwert 1.25, horizontal: 1.52, vertikal: 0.92

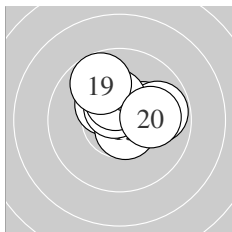

Serie 2:
 10.6 * 10.2 * 10.3 * 10.6 * 10.7 *
 9.8 → 10.6 * 10.3 * 9.8 ↗ 10.0 →
 beste Teiler 75.7 (15.) 79.7 (14.) 89.2 (11.)
 Trefferlage 0.56 mm rechts, 0.74 mm hoch
 Streuwert 1.16, horizontal: 1.38, vertikal: 0.90

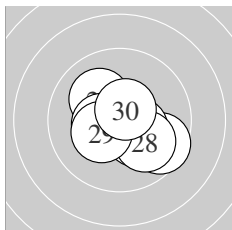

Serie 3:
 10.7 * 10.3 * 10.3 * 10.1 ↘ 10.4 *
 9.6 ↘ 10.4 * 10.0 ↘ 10.3 * 10.6 *
 beste Teiler 54.7 (21.) 89.0 (30.) 131.2 (25.)
 Trefferlage 0.22 mm rechts, 0.22 mm tief
 Streuwert 1.38, horizontal: 1.57, vertikal: 1.16

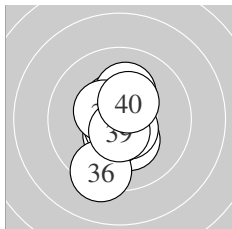

Serie 4:
 10.3 * 10.5 * 10.6 * 10.7 * 10.5 *
 9.3 ↓ 10.2 * 10.4 * 10.6 * 10.4 *
 beste Teiler 67.7 (34.) 88.0 (39.) 90.9 (33.)
 Trefferlage 0.13 mm links, 0.38 mm tief
 Streuwert 1.29, horizontal: 0.74, vertikal: 1.66

Unterschrift des Schützen

Meyton Elektronik

Ergebnis: **411.3** (392)
 Serien: 102.7 104.3 101.6 102.7
 Zähler: 32 8 0 0 0 0 0 0 0 0
 Innenzehner: 31
 weiteste: 441 (1), 396 (11), 370 (34)
 beste Teiler 33.7 (39.) 63.5 (19.) 68.4 (7.)
 Trefferlage 0.39 mm rechts, 0.88 mm hoch
 Streuwert 1.21, horizontal: 1.39, vertikal: 1.00

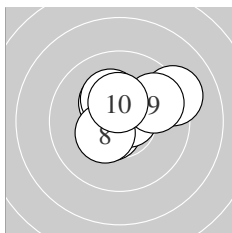
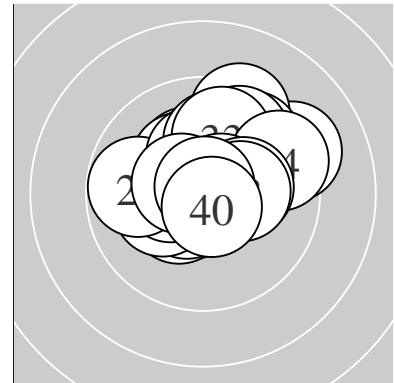

Serie 1:
 9.2 ↗ 10.3 * 10.6 * 10.2 * 10.6 *
 10.5 * 10.7 * 10.4 * 9.8 ↗ 10.4 *
 beste Teiler 68.4 (7.) 76.4 (3.) 92.8 (5.)
 Trefferlage 0.44 mm rechts, 0.79 mm hoch
 Streuwert 1.34, horizontal: 1.63, vertikal: 0.96

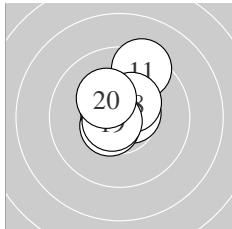

Serie 2:
 9.4 ↑ 10.6 * 10.6 * 10.4 * 10.6 *
 10.6 * 10.7 * 10.4 * 10.7 * 10.3 *
 beste Teiler 63.5 (19.) 70.8 (17.) 83.8 (16.)
 Trefferlage 0.02 mm rechts, 0.84 mm hoch
 Streuwert 1.04, horizontal: 0.91, vertikal: 1.17

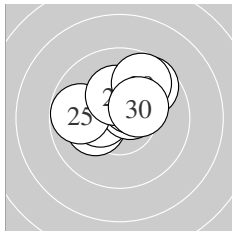

Serie 3:
 9.7 ↗ 10.2 * 10.4 * 10.5 * 9.8 ←
 10.3 * 10.4 * 10.3 * 9.7 ↗ 10.3 *
 beste Teiler 101.5 (24.) 138.8 (27.) 144.2 (23.)
 Trefferlage 0.08 mm rechts, 1.06 mm hoch
 Streuwert 1.37, horizontal: 1.66, vertikal: 1.00

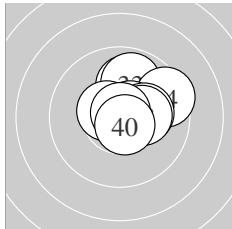

Serie 4:
 10.2 * 10.0 ↑ 9.9 ↑ 9.5 ↗ 10.5 *
 10.6 * 10.2 * 10.3 * 10.8 * 10.7 *
 beste Teiler 33.7 (39.) 69.8 (40.) 92.2 (36.)
 Trefferlage 1.02 mm rechts, 0.85 mm hoch
 Streuwert 1.10, horizontal: 1.19, vertikal: 1.01

Unterschrift des Schützen

Meyton Elektronik

Ergebnis: **416.0** (398)
 Serien: 103.7 105.0 103.8 103.5
 Zähler: 38 2 0 0 0 0 0 0 0 0
 Innenzehner: 35
 weiteste: 361 (26), 347 (40), 228 (9)
 beste Teiler 28.4 (30.) 39.3 (31.) 46.1 (28.)
 Trefferlage 0.56 mm links, 0.18 mm tief
 Streuwert 1.02, horizontal: 1.13, vertikal: 0.89

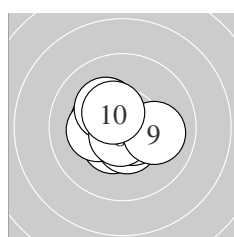
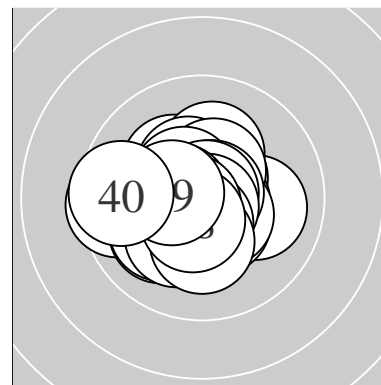

Serie 1:
 10.4 * 10.3 * 10.2 * 10.5 * 10.6 *
 10.3 * 10.2 * 10.7 * 10.0 → 10.5 *
 beste Teiler 57.5 (8.) 86.5 (5.) 112.6 (4.)
 Trefferlage 0.38 mm links, 0.02 mm hoch
 Streuwert 1.08, horizontal: 1.22, vertikal: 0.92

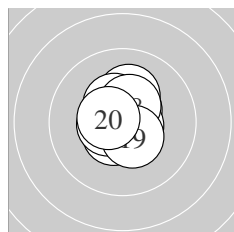

Serie 2:
 10.5 * 10.2 * 10.5 * 10.5 * 10.4 *
 10.7 * 10.7 * 10.5 * 10.5 * 10.5 *
 beste Teiler 60.8 (16.) 73.3 (17.) 102.3 (11.)
 Trefferlage 0.00 mm , 0.27 mm hoch
 Streuwert 0.86, horizontal: 0.73, vertikal: 0.97

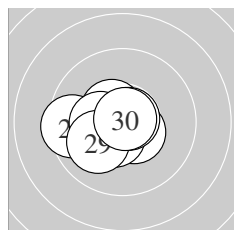

Serie 3:
 10.5 * 10.6 * 10.5 * 10.2 * 10.5 *
 9.5 ← 10.3 * 10.8 * 10.1 ↙ 10.8 *
 beste Teiler 28.4 (30.) 46.1 (28.) 96.1 (22.)
 Trefferlage 0.94 mm links, 0.33 mm tief
 Streuwert 1.03, horizontal: 1.29, vertikal: 0.67

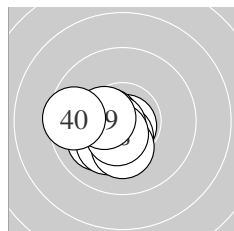

Serie 4:
 10.8 * 10.1 ↙ 10.5 * 10.2 * 10.5 *
 10.2 * 10.7 * 10.5 * 10.4 * 9.6 ←
 beste Teiler 39.3 (31.) 66.3 (37.) 102.1 (38.)
 Trefferlage 0.94 mm links, 0.69 mm tief
 Streuwert 0.94, horizontal: 1.08, vertikal: 0.76

Unterschrift des Schützen

Meyton Elektronik

Ergebnis: **412.2** (395)
 Serien: 100.7 104.9 102.5 104.1
 Zähler: 36 3 1 0 0 0 0 0 0
 Innenzehner: 27
 weiteste: 552 (5), 361 (30), 335 (7)
 beste Teiler 6.4 (21.) 18.3 (20.) 19.7 (37.)
 Trefferlage 0.20 mm links, 0.29 mm tief
 Streuwert 1.37, horizontal: 1.48, vertikal: 1.25

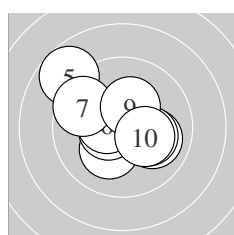
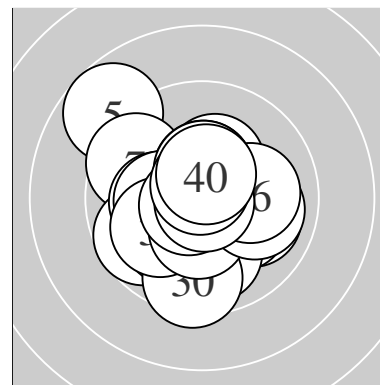

Serie 1:
 10.6 * 10.0 → 10.2 * 10.5 * 8.7 ↖
 10.5 * 9.6 ↖ 10.1 → 10.3 * 10.2 *
 beste Teiler 90.4 (1.) 108.2 (4.) 120.0 (6.)
 Trefferlage 0.30 mm links, 0.26 mm hoch
 Streuwert 1.87, horizontal: 2.10, vertikal: 1.61

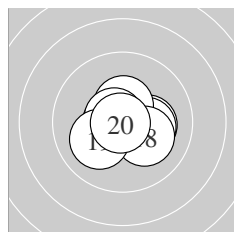

Serie 2:
 10.7 * 10.6 * 10.2 * 10.2 * 10.8 *
 10.5 * 10.7 * 10.2 * 10.1 ↙ 10.9 *
 beste Teiler 18.3 (20.) 48.8 (15.) 56.0 (11.)
 Trefferlage 0.10 mm rechts, 0.11 mm tief
 Streuwert 1.00, horizontal: 1.23, vertikal: 0.71

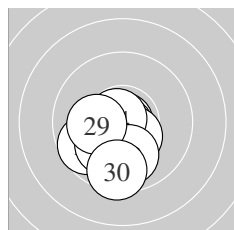

Serie 3:
 10.9 * 10.8 * 10.4 * 10.8 * 9.7 ↙
 10.1 ↙ 10.1 ↙ 10.0 ↓ 10.2 * 9.5 ↓
 beste Teiler 6.4 (21.) 39.0 (22.) 50.2 (24.)
 Trefferlage 0.67 mm links, 1.24 mm tief
 Streuwert 1.15, horizontal: 1.10, vertikal: 1.21

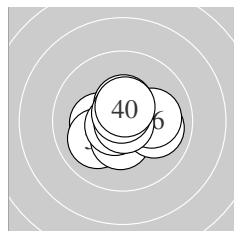

Serie 4:
 10.3 * 10.0 ↙ 10.4 * 10.7 * 10.0 →
 10.1 → 10.9 * 10.5 * 10.7 * 10.5 *
 beste Teiler 19.7 (37.) 59.5 (39.) 67.6 (34.)
 Trefferlage 0.04 mm rechts, 0.07 mm tief
 Streuwert 1.16, horizontal: 1.38, vertikal: 0.88

Unterschrift des Schützen

Meyton Elektronik

Ergebnis: **414.6** (394)
 Serien: 103.6 103.6 103.7 103.7
 Zähler: 34 6 0 0 0 0 0 0 0 0
 Innenzehner: 31
 weiteste: 403 (40), 341 (28), 337 (38)
 beste Teiler 15.0 (39.) 28.0 (36.) 36.4 (24.)
 Trefferlage 0.24 mm rechts, 0.50 mm hoch
 Streuwert 1.18, horizontal: 1.43, vertikal: 0.86

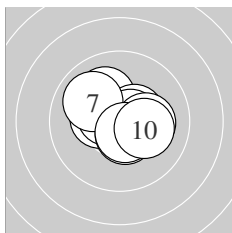
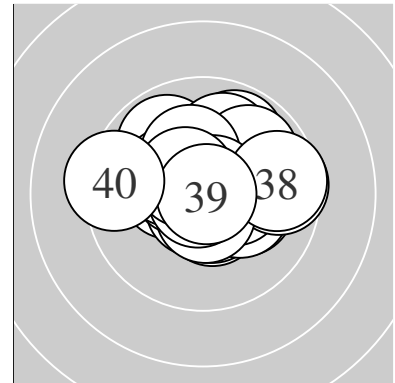

Serie 1:
 10.1 ↘ 10.4 * 10.5 * 10.5 * 10.6 *
 10.5 * 10.0 ↘ 10.2 * 10.6 * 10.2 *
 beste Teiler 83.1 (5.) 94.3 (9.) 102.0 (3.)
 Trefferlage 0.10 mm rechts, 0.20 mm hoch
 Streuwert 1.18, horizontal: 1.39, vertikal: 0.92

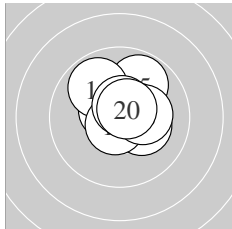

Serie 2:
 10.6 * 10.6 * 10.3 * 10.2 * 9.8 ↗
 9.9 ↘ 10.7 * 10.3 * 10.6 * 10.6 *
 beste Teiler 65.8 (17.) 82.2 (20.) 82.8 (11.)
 Trefferlage 0.34 mm rechts, 0.72 mm hoch
 Streuwert 1.08, horizontal: 1.16, vertikal: 1.00

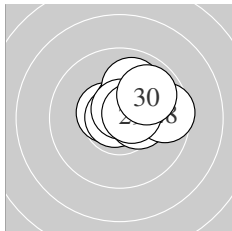

Serie 3:
 10.5 * 10.4 * 10.8 * 10.8 * 10.4 *
 10.0 ↗ 10.7 * 9.6 → 10.6 * 9.9 ↗
 beste Teiler 36.4 (24.) 46.2 (23.) 67.8 (27.)
 Trefferlage 0.80 mm rechts, 0.75 mm hoch
 Streuwert 1.04, horizontal: 1.25, vertikal: 0.76

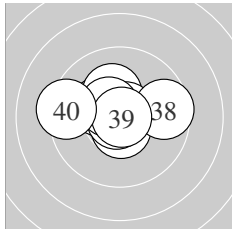

Serie 4:
 10.3 * 10.8 * 10.6 * 10.2 * 10.7 *
 10.8 * 10.5 * 9.6 → 10.9 * 9.3 ←
 beste Teiler 15.0 (39.) 28.0 (36.) 49.6 (32.)
 Trefferlage 0.28 mm links, 0.33 mm hoch
 Streuwert 1.38, horizontal: 1.81, vertikal: 0.74

Unterschrift des Schützen

Meyton Elektronik

Ergebnis: **424.0** (400)
 Serien: 105.8 105.5 106.9 105.8
 Zähler: 40 0 0 0 0 0 0 0 0 0
 Innenzehner: 40
 weiteste: 195 (3), 193 (35), 150 (12)
 beste Teiler 1.4 (32.) 4.4 (27.) 22.0 (30.)
 Trefferlage 0.28 mm rechts, 0.07 mm hoch
 Streuwert 0.69, horizontal: 0.70, vertikal: 0.67

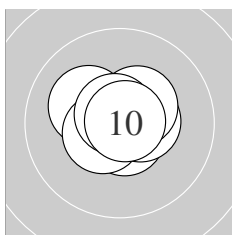
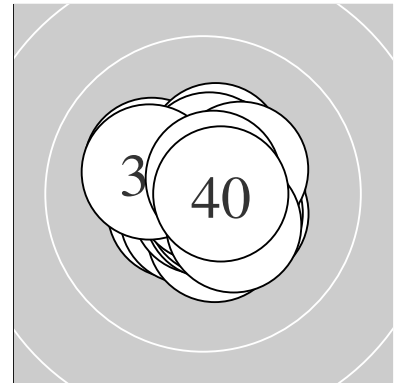

Serie 1:
 10.8 * 10.5 * 10.2 * 10.7 * 10.7 *
 10.5 * 10.5 * 10.4 * 10.7 * 10.8 *
 beste Teiler 28.1 (1.) 31.9 (10.) 54.0 (5.)
 Trefferlage 0.09 mm rechts, 0.25 mm hoch
 Streuwert 0.75, horizontal: 0.89, vertikal: 0.58

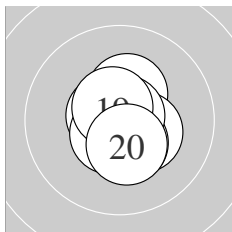

Serie 2:
 10.7 * 10.4 * 10.6 * 10.6 * 10.6 *
 10.4 * 10.4 * 10.8 * 10.6 * 10.4 *
 beste Teiler 35.3 (18.) 64.1 (11.) 77.4 (13.)
 Trefferlage 0.20 mm rechts, 0.13 mm tief
 Streuwert 0.78, horizontal: 0.60, vertikal: 0.92

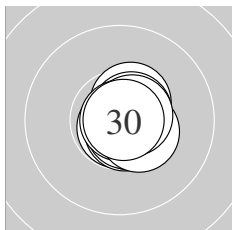

Serie 3:
 10.8 * 10.5 * 10.7 * 10.6 * 10.6 *
 10.7 * 10.9 * 10.5 * 10.7 * 10.9 *
 beste Teiler 4.4 (27.) 22.0 (30.) 42.7 (21.)
 Trefferlage 0.45 mm rechts, 0.09 mm tief
 Streuwert 0.45, horizontal: 0.36, vertikal: 0.53

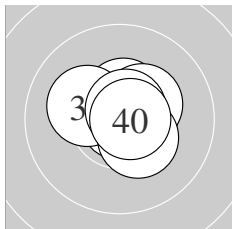

Serie 4:
 10.5 * 10.9 * 10.6 * 10.7 * 10.2 *
 10.7 * 10.4 * 10.7 * 10.4 * 10.7 *
 beste Teiler 1.4 (32.) 57.6 (36.) 59.0 (40.)
 Trefferlage 0.38 mm rechts, 0.25 mm hoch
 Streuwert 0.74, horizontal: 0.85, vertikal: 0.60

Unterschrift des Schützen

Meyton Elektronik

Ergebnis: **407.8** (393)
 Serien: 102.5 100.8 101.3 103.2
 Zähler: 33 7 0 0 0 0 0 0 0 0
 Innenzehner: 22
 weiteste: 434 (17), 399 (11), 329 (30)
 beste Teiler 29.0 (9.) 42.1 (15.) 59.5 (14.)
 Trefferlage 0.93 mm links, 0.07 mm tief
 Streuwert 1.34, horizontal: 1.61, vertikal: 1.01

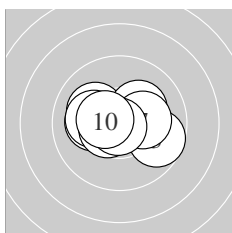
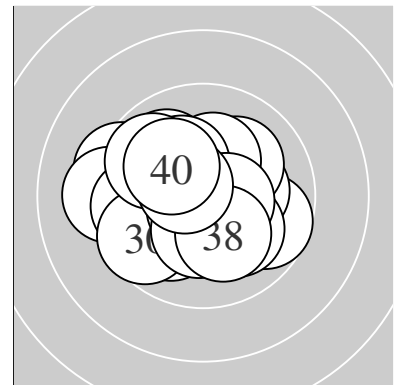

Serie 1:
 10.3 * 10.1 ← 9.7 → 10.1 ↖ 10.1 ←
 10.2 * 10.2 * 10.5 * 10.8 * 10.5 *
 beste Teiler 29.0 (9.) 104.2 (8.) 117.3 (10.)
 Trefferlage 0.36 mm links, 0.13 mm hoch
 Streuwert 1.35, horizontal: 1.80, vertikal: 0.66

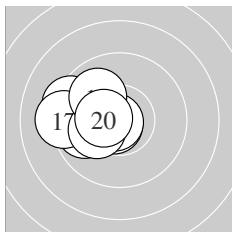

Serie 2:
 9.4 ↖ 10.2 * 10.0 ← 10.7 * 10.8 *
 9.8 ← 9.2 ← 10.2 * 10.0 ↖ 10.5 *
 beste Teiler 42.1 (15.) 59.5 (14.) 124.9 (20.)
 Trefferlage 2.05 mm links, 0.05 mm hoch
 Streuwert 1.09, horizontal: 1.30, vertikal: 0.84

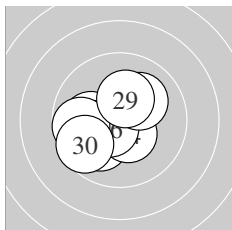

Serie 3:
 10.4 * 10.1 ← 10.0 ↙ 10.4 * 10.1 ←
 10.6 * 10.1 ↗ 9.7 ← 10.3 * 9.6 ↙
 beste Teiler 97.9 (26.) 126.2 (24.) 148.9 (21.)
 Trefferlage 1.10 mm links, 0.38 mm tief
 Streuwert 1.37, horizontal: 1.54, vertikal: 1.17

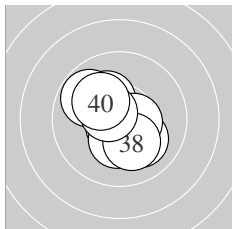

Serie 4:
 10.7 * 10.3 * 10.1 ↖ 10.2 * 9.8 ↖
 10.7 * 10.5 * 10.2 * 10.6 * 10.1 ↖
 beste Teiler 61.3 (36.) 68.8 (31.) 98.1 (39.)
 Trefferlage 0.21 mm links, 0.09 mm tief
 Streuwert 1.28, horizontal: 1.25, vertikal: 1.31

Unterschrift des Schützen

Meyton Elektronik

Ergebnis: **412.2** (395)
 Serien: 102.0 103.1 103.8 103.3
 Zähler: 35 5 0 0 0 0 0 0 0 0
 Innenzehner: 29
 weiteste: 359 (11), 298 (30), 285 (10)
 beste Teiler 6.3 (29.) 22.8 (24.) 59.4 (8.)
 Trefferlage 0.19 mm rechts, 0.10 mm hoch
 Streuwert 1.28, horizontal: 1.50, vertikal: 1.00

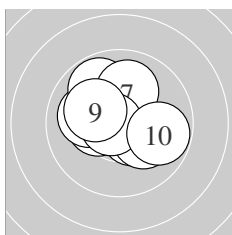
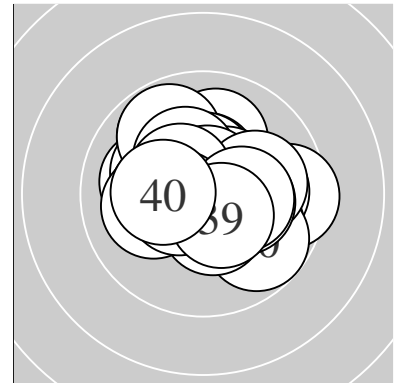

Serie 1:
 10.5 * 10.3 * 10.2 * 10.1 ← 10.4 *
 9.8 ↘ 10.0 ↑ 10.7 * 10.2 * 9.8 →
 beste Teiler 59.4 (8.) 120.5 (1.) 136.8 (5.)
 Trefferlage 0.21 mm links, 0.46 mm hoch
 Streuwert 1.45, horizontal: 1.63, vertikal: 1.23

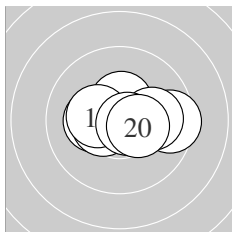

Serie 2:
 9.5 → 10.6 * 10.2 * 10.5 * 10.4 *
 10.5 * 10.0 → 10.3 * 10.7 * 10.4 *
 beste Teiler 60.8 (19.) 80.3 (12.) 121.5 (14.)
 Trefferlage 0.39 mm rechts, 0.05 mm hoch
 Streuwert 1.29, horizontal: 1.76, vertikal: 0.48

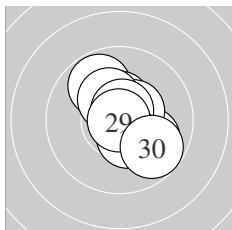

Serie 3:
 10.0 ↘ 9.8 ↘ 10.5 * 10.9 * 10.5 *
 10.3 * 10.7 * 10.4 * 10.9 * 9.8 ↘
 beste Teiler 6.3 (29.) 22.8 (24.) 70.3 (27.)
 Trefferlage 0.40 mm rechts, 0.19 mm hoch
 Streuwert 1.27, horizontal: 1.15, vertikal: 1.38

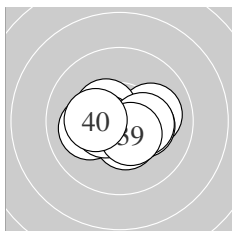

Serie 4:
 10.4 * 10.0 → 10.5 * 10.1 ← 10.4 *
 10.5 * 10.3 * 10.3 * 10.5 * 10.3 *
 beste Teiler 108.8 (36.) 120.6 (39.) 123.2 (33.)
 Trefferlage 0.21 mm rechts, 0.29 mm tief
 Streuwert 1.17, horizontal: 1.55, vertikal: 0.60

Unterschrift des Schützen

Meyton Elektronik

Ergebnis: **392.7** (374)
 Serien: 100.8 101.6 94.6 95.7
 Zähler: 19 16 5 0 0 0 0 0 0 0
 Innenzehner: 15
 weiteste: 625 (25), 619 (32), 596 (33)
 beste Teiler 21.0 (20.) 69.8 (5.) 73.1 (37.)
 Trefferlage 0.93 mm links, 1.06 mm hoch
 Streuwert 2.13, horizontal: 2.59, vertikal: 1.55

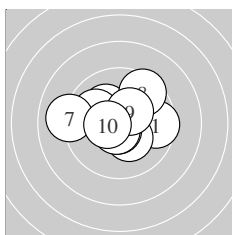
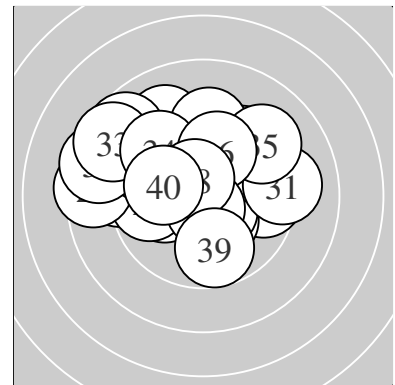

Serie 1:
 9.6 → 10.2 * 10.0 ↖ 10.3 * 10.7 *
 10.6 * 9.0 ← 9.5 ↗ 10.4 * 10.5 *
 beste Teiler 69.8 (5.) 76.1 (6.) 115.8 (10.)
 Trefferlage 0.24 mm links, 0.38 mm hoch
 Streuwert 1.86, horizontal: 2.32, vertikal: 1.26

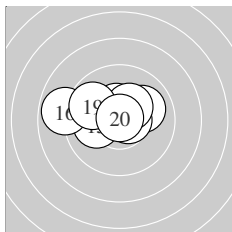

Serie 2:
 9.9 ↖ 10.4 * 10.0 ↗ 10.7 * 10.1 ←
 8.9 ← 10.6 * 10.3 * 9.8 ↖ 10.9 *
 beste Teiler 21.0 (20.) 73.5 (14.) 82.0 (17.)
 Trefferlage 0.92 mm links, 0.71 mm hoch
 Streuwert 1.57, horizontal: 2.14, vertikal: 0.60

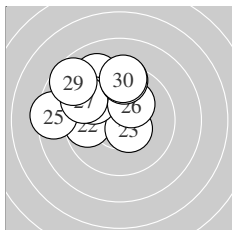

Serie 3:
 9.1 ↖ 9.7 ← 10.5 * 9.7 ↖ 8.5 ←
 10.2 * 9.4 ↖ 9.4 ↑ 8.7 ↖ 9.4 ↑
 beste Teiler 118.1 (23.) 187.6 (26.) 305.6 (22.)
 Trefferlage 1.89 mm links, 2.00 mm hoch
 Streuwert 2.18, horizontal: 2.49, vertikal: 1.81

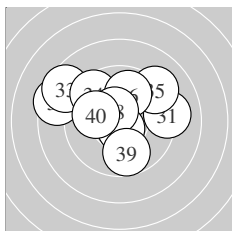

Serie 4:
 9.1 → 8.5 ↖ 8.6 ↖ 9.5 ↖ 9.2 ↗
 9.9 ↑ 10.7 * 10.5 * 9.7 ↓ 10.0 ←
 beste Teiler 73.1 (37.) 108.6 (38.) 233.1 (40.)
 Trefferlage 0.68 mm links, 1.15 mm hoch
 Streuwert 2.72, horizontal: 3.34, vertikal: 1.90

Unterschrift des Schützen

Meyton Elektronik

Ergebnis: **412.7** (395)
 Serien: 103.4 102.6 103.0 103.7
 Zähler: 35 5 0 0 0 0 0 0 0 0
 Innenzehner: 31
 weiteste: 401 (12), 316 (21), 308 (19)
 beste Teiler 12.1 (37.) 34.0 (11.) 42.7 (4.)
 Trefferlage 0.45 mm links, 0.51 mm hoch
 Streuwert 1.19, horizontal: 1.39, vertikal: 0.94

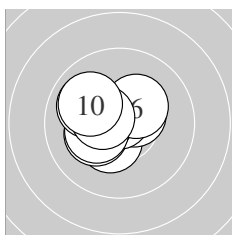
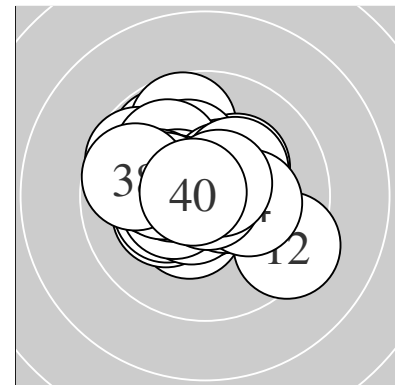

Serie 1:
 10.4 * 10.5 * 10.2 * 10.8 * 10.4 *
 10.3 * 10.3 * 10.0 ↘ 10.5 * 10.0 ↘
 beste Teiler 42.7 (4.) 116.4 (2.) 125.8 (9.)
 Trefferlage 0.85 mm links, 0.26 mm hoch
 Streuwert 1.05, horizontal: 1.19, vertikal: 0.88

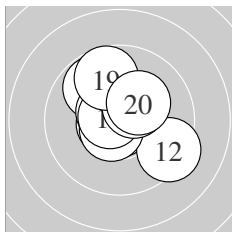

Serie 2:
 10.8 * 9.3 ↘ 10.6 * 9.8 ↘ 10.5 *
 10.6 * 10.7 * 10.4 * 9.7 ↗ 10.2 *
 beste Teiler 34.0 (11.) 71.5 (17.) 83.1 (13.)
 Trefferlage 0.02 mm rechts, 0.49 mm hoch
 Streuwert 1.48, horizontal: 1.51, vertikal: 1.45

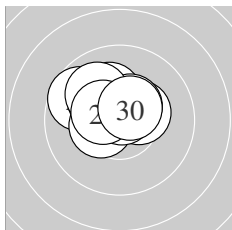

Serie 3:
 9.7 ↘ 10.2 * 10.4 * 10.2 * 10.4 *
 10.5 * 10.0 ↘ 10.7 * 10.4 * 10.5 *
 beste Teiler 53.4 (28.) 111.2 (30.) 122.8 (26.)
 Trefferlage 0.59 mm links, 0.95 mm hoch
 Streuwert 1.04, horizontal: 1.30, vertikal: 0.69

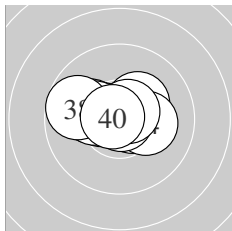

Serie 4:
 10.3 * 10.6 * 10.4 * 10.2 * 10.1 ↘
 10.2 * 10.9 * 9.7 ← 10.6 * 10.7 *
 beste Teiler 12.1 (37.) 52.4 (40.) 77.8 (39.)
 Trefferlage 0.38 mm links, 0.34 mm hoch
 Streuwert 1.15, horizontal: 1.57, vertikal: 0.43

Unterschrift des Schützen

Meyton Elektronik