

Ergebnis: **415.6** (399)

Serien: 104.4 102.5 104.6 104.1

Zähler: 39 1 0 0 0 0 0 0 0 0

Innenzehner: 32

weiteste: 285 (11), 246 (17), 225 (12)

beste Teiler 46.5 (2.) 55.9 (24.) 59.2 (18.)

Trefferlage 0.04 mm rechts, 0.01 mm hoch

Streuwert 1.08, horizontal: 1.18, vertikal: 0.98

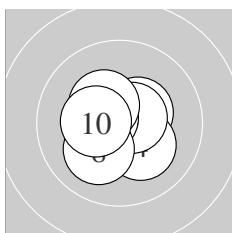
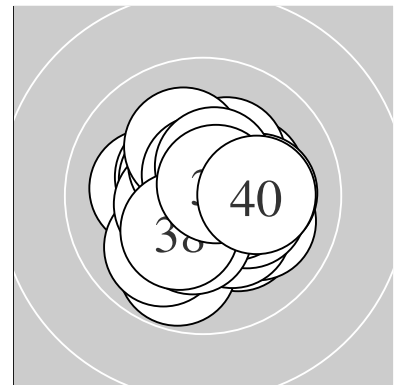

Serie 1:

10.4 *	10.8 *	10.5 *	10.2 *	10.5 *
10.6 *	10.5 *	10.1 ↙	10.4 *	10.4 *

beste Teiler 46.5 (2.) 84.1 (6.) 109.0 (3.)

Trefferlage 0.41 mm links, 0.03 mm hoch

Streuwert 0.98, horizontal: 1.08, vertikal: 0.87

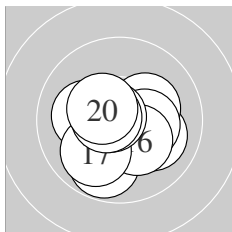

Serie 2:

9.8 ↘	10.1 ↘	10.2 *	10.3 *	10.1 ←
10.3 *	10.0 ↙	10.7 *	10.6 *	10.4 *

beste Teiler 59.2 (18.) 85.9 (19.) 131.4 (20.)

Trefferlage 0.07 mm links, 0.49 mm tief

Streuwert 1.34, horizontal: 1.50, vertikal: 1.17

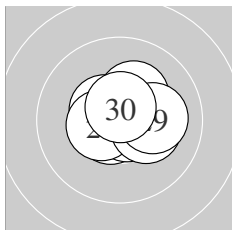

Serie 3:

10.3 *	10.6 *	10.5 *	10.7 *	10.7 *
10.5 *	10.3 *	10.3 *	10.1 →	10.6 *

beste Teiler 55.9 (24.) 61.8 (25.) 79.2 (22.)

Trefferlage 0.45 mm rechts, 0.18 mm hoch

Streuwert 0.93, horizontal: 1.13, vertikal: 0.66

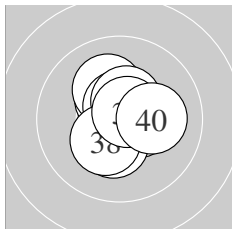

Serie 4:

10.5 *	10.6 *	10.4 *	10.1 ↗	10.6 *
10.3 *	10.5 *	10.3 *	10.7 *	10.1 →

beste Teiler 66.5 (39.) 81.3 (35.) 99.3 (32.)

Trefferlage 0.19 mm rechts, 0.33 mm hoch

Streuwert 1.01, horizontal: 0.93, vertikal: 1.09

Unterschrift des Schützen

Meyton Elektronik

Ergebnis: **414.5** (394)
 Serien: 102.6 103.8 104.9 103.2
 Zähler: 34 6 0 0 0 0 0 0 0 0
 Innenzehner: 30
 weiteste: 348 (27), 293 (4), 275 (1)
 beste Teiler 10.0 (22.) 13.0 (29.) 41.3 (23.)
 Trefferlage 0.20 mm rechts, 0.15 mm tief
 Streuwert 1.19, horizontal: 1.56, vertikal: 0.63

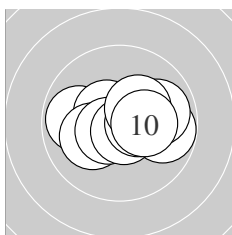
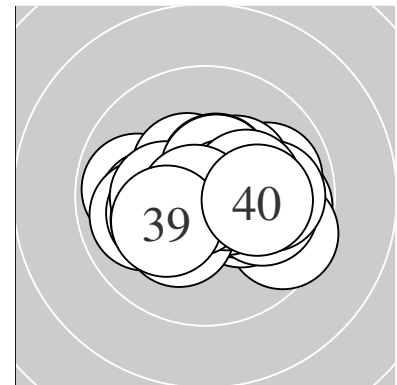

Serie 1:
 9.9 ← 10.5 * 10.1 ← 9.8 → 10.6 *
 9.9 → 10.7 * 10.5 * 10.3 * 10.3 *
 beste Teiler 61.2 (7.) 91.5 (5.) 109.2 (2.)
 Trefferlage 0.36 mm rechts, 0.02 mm hoch
 Streuwert 1.39, horizontal: 1.87, vertikal: 0.63

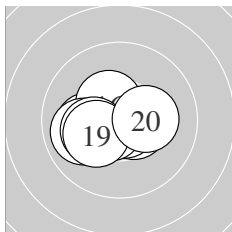

Serie 2:
 10.5 * 10.8 * 10.8 * 10.1 ← 10.6 *
 10.4 * 9.9 ← 10.2 * 10.2 * 10.3 *
 beste Teiler 46.0 (12.) 49.2 (13.) 82.0 (15.)
 Trefferlage 0.65 mm links, 0.25 mm tief
 Streuwert 1.05, horizontal: 1.36, vertikal: 0.60

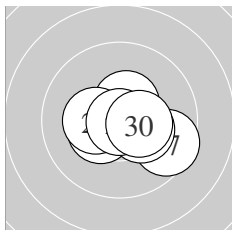

Serie 3:
 10.8 * 10.9 * 10.8 * 10.4 * 10.5 *
 10.3 * 9.6 → 10.3 * 10.9 * 10.4 *
 beste Teiler 10.0 (22.) 13.0 (29.) 41.3 (23.)
 Trefferlage 0.33 mm rechts, 0.21 mm tief
 Streuwert 1.09, horizontal: 1.39, vertikal: 0.67

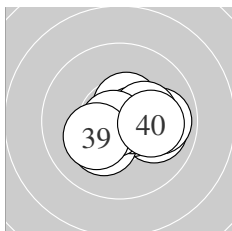

Serie 4:
 10.0 → 10.5 * 9.9 → 10.6 * 10.2 *
 10.6 * 10.3 * 10.8 * 10.2 * 10.1 →
 beste Teiler 45.6 (38.) 85.1 (34.) 87.1 (36.)
 Trefferlage 0.78 mm rechts, 0.19 mm tief
 Streuwert 1.13, horizontal: 1.44, vertikal: 0.70

Unterschrift des Schützen

Meyton Elektronik

Ergebnis: **412.1** (396)
 Serien: 101.2 104.5 102.4 104.0
 Zähler: 37 2 1 0 0 0 0 0 0
 Innenzehner: 32
 weiteste: 617 (1), 423 (24), 252 (37)
 beste Teiler 39.0 (15.) 41.4 (14.) 58.8 (36.)
 Trefferlage 0.32 mm links, 0.22 mm hoch
 Streuwert 1.34, horizontal: 1.63, vertikal: 0.97

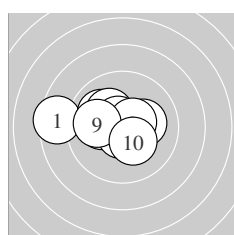
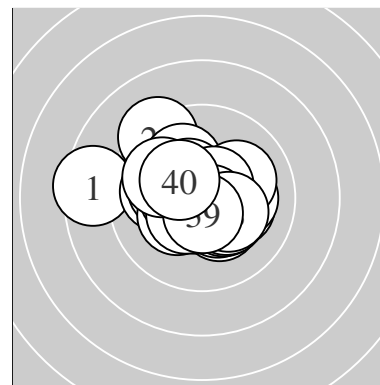

Serie 1:
 8.5 ← 10.0 ↖ 10.2 * 10.2 * 10.6 *
 10.7 * 10.2 * 10.5 * 10.0 ← 10.3 *
 beste Teiler 70.8 (6.) 78.7 (5.) 105.5 (8.)
 Trefferlage 1.05 mm links, 0.34 mm hoch
 Streuwert 1.72, horizontal: 2.30, vertikal: 0.82

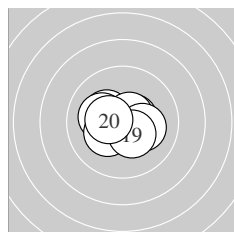

Serie 2:
 10.5 * 10.3 * 10.2 * 10.8 * 10.8 *
 10.6 * 10.2 * 10.3 * 10.4 * 10.4 *
 beste Teiler 39.0 (15.) 41.4 (14.) 84.2 (16.)
 Trefferlage 0.20 mm links, 0.06 mm tief
 Streuwert 1.02, horizontal: 1.29, vertikal: 0.66

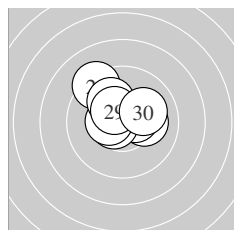

Serie 3:
 10.5 * 10.1 → 10.5 * 9.3 ↘ 10.6 *
 10.4 * 10.4 * 10.1 ↘ 10.4 * 10.1 →
 beste Teiler 84.4 (25.) 107.3 (21.) 120.6 (23.)
 Trefferlage 0.09 mm links, 0.90 mm hoch
 Streuwert 1.33, horizontal: 1.52, vertikal: 1.11

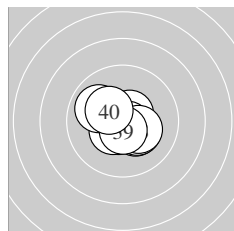

Serie 4:
 10.3 * 10.6 * 10.3 * 10.4 * 10.6 *
 10.7 * 9.9 ↖ 10.3 * 10.6 * 10.3 *
 beste Teiler 58.8 (36.) 86.1 (39.) 92.6 (35.)
 Trefferlage 0.04 mm rechts, 0.29 mm tief
 Streuwert 1.07, horizontal: 1.23, vertikal: 0.88

Unterschrift des Schützen

Meyton Elektronik

Ergebnis: **407.9** (393)
 Serien: 101.8 101.0 103.1 102.0
 Zähler: 33 7 0 0 0 0 0 0 0 0
 Innenzehner: 23
 weiteste: 387 (13), 360 (10), 314 (22)
 beste Teiler 58.6 (28.) 63.6 (2.) 72.1 (29.)
 Trefferlage 0.00 mm , 0.02 mm hoch
 Streuwert 1.47, horizontal: 1.69, vertikal: 1.20

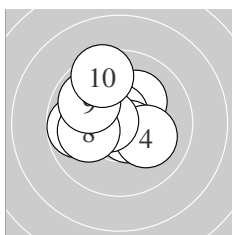
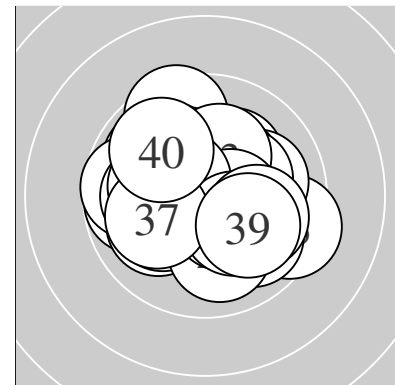

Serie 1:
 10.2 * 10.7 * 10.6 * 10.1 ↘ 9.8 ←
 10.4 * 10.6 * 10.0 ← 9.9 ↖ 9.5 ↑
 beste Teiler 63.6 (2.) 87.0 (3.) 89.2 (7.)
 Trefferlage 0.71 mm links, 0.52 mm hoch
 Streuwert 1.45, horizontal: 1.58, vertikal: 1.32

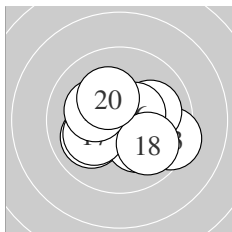

Serie 2:
 10.0 ↙ 10.5 * 9.4 ↗ 10.2 * 10.0 →
 10.5 * 10.1 ↙ 9.9 ↘ 10.2 * 10.2 *
 beste Teiler 115.9 (16.) 119.2 (12.) 178.4 (20.)
 Trefferlage 0.49 mm rechts, 0.34 mm tief
 Streuwert 1.61, horizontal: 1.97, vertikal: 1.14

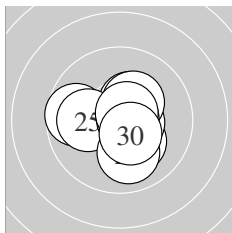

Serie 3:
 10.4 * 9.7 ← 10.2 * 10.6 * 10.0 ←
 10.0 ↓ 10.3 * 10.7 * 10.7 * 10.5 *
 beste Teiler 58.6 (28.) 72.1 (29.) 100.8 (24.)
 Trefferlage 0.09 mm rechts, 0.15 mm tief
 Streuwert 1.34, horizontal: 1.50, vertikal: 1.15

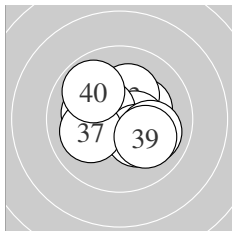

Serie 4:
 10.2 * 10.3 * 10.2 * 10.5 * 10.4 *
 10.3 * 10.1 ← 10.0 ↗ 10.1 ↘ 9.9 ↖
 beste Teiler 111.4 (34.) 128.5 (35.) 170.0 (32.)
 Trefferlage 0.15 mm rechts, 0.09 mm hoch
 Streuwert 1.47, horizontal: 1.71, vertikal: 1.18

Unterschrift des Schützen

Meyton Elektronik

Ergebnis: **417.1** (395)
 Serien: 105.1 102.1 105.6 104.3
 Zähler: 35 5 0 0 0 0 0 0 0 0
 Innenzehner: 34
 weiteste: 308 (15), 289 (12), 289 (20)
 beste Teiler 41.7 (6.) 48.0 (29.) 57.3 (31.)
 Trefferlage 0.15 mm links, 0.01 mm tief
 Streuwert 1.05, horizontal: 1.04, vertikal: 1.06

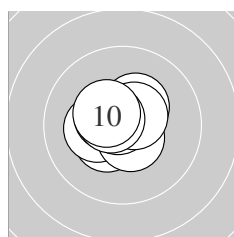
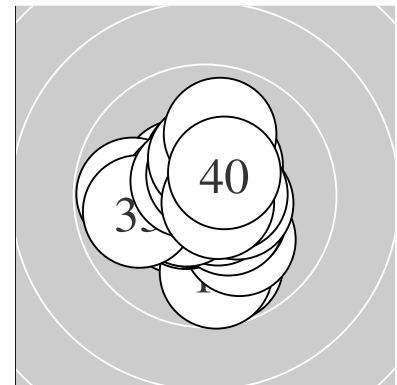

Serie 1:
 10.5 * 10.4 * 10.4 * 10.3 * 10.6 *
 10.8 * 10.5 * 10.6 * 10.6 * 10.4 *
 beste Teiler 41.7 (6.) 86.7 (9.) 98.0 (8.)
 Trefferlage 0.32 mm links, 0.28 mm hoch
 Streuwert 0.82, horizontal: 0.91, vertikal: 0.72

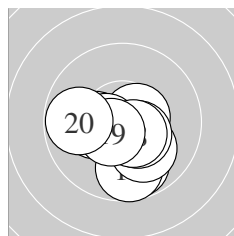

Serie 2:
 10.6 * 9.8 ↓ 10.2 * 10.5 * 9.7 ↓
 10.1 ↘ 10.4 * 10.5 * 10.5 * 9.8 ←
 beste Teiler 97.7 (11.) 101.3 (19.) 104.0 (18.)
 Trefferlage 0.12 mm links, 0.99 mm tief
 Streuwert 1.30, horizontal: 1.43, vertikal: 1.16

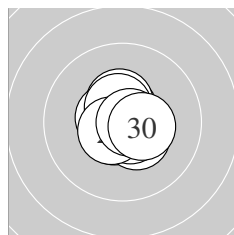

Serie 3:
 10.6 * 10.6 * 10.4 * 10.6 * 10.5 *
 10.4 * 10.7 * 10.6 * 10.8 * 10.4 *
 beste Teiler 48.0 (29.) 74.2 (27.) 81.3 (22.)
 Trefferlage 0.05 mm rechts, 0.05 mm hoch
 Streuwert 0.75, horizontal: 0.73, vertikal: 0.77

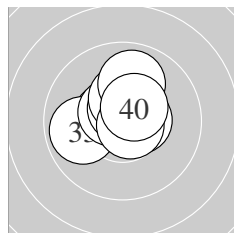

Serie 4:
 10.7 * 10.5 * 9.9 ← 10.5 * 10.6 *
 10.6 * 10.4 * 10.7 * 9.9 ↑ 10.5 *
 beste Teiler 57.3 (31.) 57.7 (38.) 84.5 (36.)
 Trefferlage 0.21 mm links, 0.60 mm hoch
 Streuwert 1.00, horizontal: 1.09, vertikal: 0.90

Unterschrift des Schützen

Meyton Elektronik

Ergebnis: **413.1** (394)
 Serien: 100.9 103.2 103.5 105.5
 Zähler: 34 6 0 0 0 0 0 0 0 0
 Innenzehner: 32
 weiteste: 483 (5), 358 (16), 334 (4)
 beste Teiler 31.9 (35.) 39.2 (11.) 40.0 (17.)
 Trefferlage 0.22 mm links, 0.07 mm hoch
 Streuwert 1.29, horizontal: 1.49, vertikal: 1.06

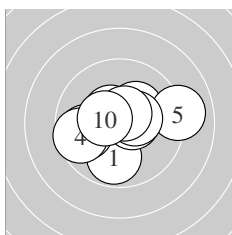
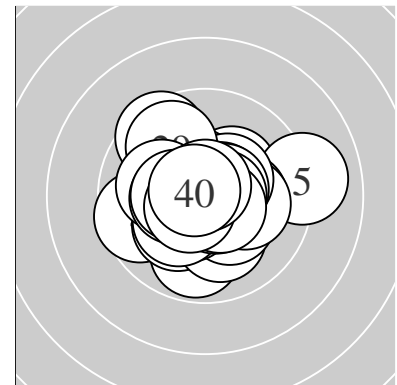

Serie 1:
 9.8 ↓ 10.3 * 9.8 ← 9.6 ← 9.0 →
 10.5 * 10.5 * 10.4 * 10.6 * 10.4 *
 beste Teiler 88.1 (9.) 103.3 (7.) 112.8 (6.)
 Trefferlage 0.03 mm rechts, 0.00 mm
 Streuwert 1.82, horizontal: 2.29, vertikal: 1.19

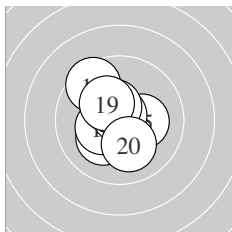

Serie 2:
 10.8 * 10.2 * 10.4 * 10.4 * 10.2 *
 9.5 ↘ 10.8 * 10.5 * 10.3 * 10.1 ↓
 beste Teiler 39.2 (11.) 40.0 (17.) 117.5 (18.)
 Trefferlage 0.47 mm links, 0.32 mm hoch
 Streuwert 1.29, horizontal: 1.15, vertikal: 1.43

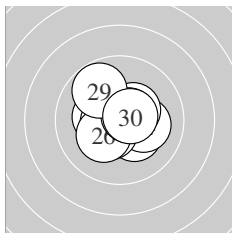

Serie 3:
 10.3 * 10.6 * 10.3 * 10.2 * 10.5 *
 10.2 * 10.4 * 10.6 * 9.8 ↘ 10.6 *
 beste Teiler 81.8 (28.) 92.6 (30.) 98.8 (22.)
 Trefferlage 0.04 mm links, 0.03 mm hoch
 Streuwert 1.22, horizontal: 1.35, vertikal: 1.09

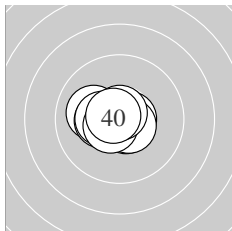

Serie 4:
 10.1 ← 10.6 * 10.4 * 10.4 * 10.8 *
 10.6 * 10.6 * 10.6 * 10.7 * 10.7 *
 beste Teiler 31.9 (35.) 51.0 (39.) 58.5 (40.)
 Trefferlage 0.41 mm links, 0.07 mm tief
 Streuwert 0.77, horizontal: 1.01, vertikal: 0.42

Unterschrift des Schützen

Meyton Elektronik

Ergebnis: **409.1** (392)
 Serien: 100.7 101.7 105.0 101.7
 Zähler: 32 8 0 0 0 0 0 0 0 0
 Innenzehner: 26
 weiteste: 408 (9), 396 (12), 379 (19)
 beste Teiler 22.0 (18.) 26.2 (22.) 53.4 (35.)
 Trefferlage 0.47 mm links, 0.50 mm hoch
 Streuwert 1.43, horizontal: 1.31, vertikal: 1.53

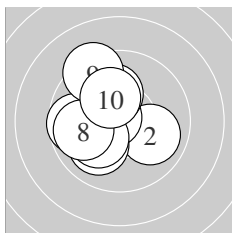
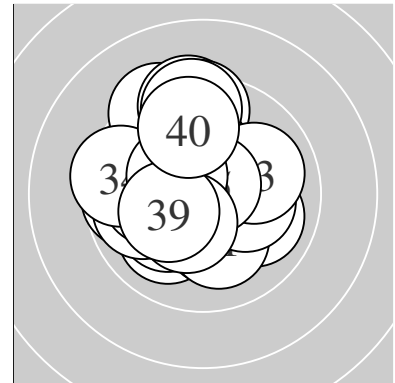

Serie 1:
 10.6 * 10.0 → 10.7 * 9.7 ← 10.0 ↙
 10.2 * 10.1 ↑ 9.9 ← 9.3 ↗ 10.2 *
 beste Teiler 66.2 (3.) 81.8 (1.) 186.2 (10.)
 Trefferlage 1.11 mm links, 0.24 mm hoch
 Streuwert 1.59, horizontal: 1.49, vertikal: 1.68

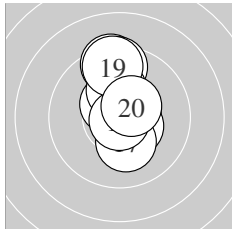

Serie 2:
 10.6 * 9.4 ↑ 9.5 ↑ 10.5 * 10.5 *
 10.2 * 10.2 * 10.9 * 9.4 ↑ 10.5 *
 beste Teiler 22.0 (18.) 96.3 (11.) 119.5 (20.)
 Trefferlage 0.08 mm rechts, 1.29 mm hoch
 Streuwert 1.49, horizontal: 0.66, vertikal: 2.00

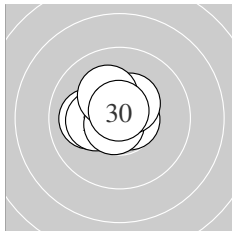

Serie 3:
 10.6 * 10.8 * 10.0 ← 10.2 * 10.7 *
 10.7 * 10.7 * 10.4 * 10.2 * 10.7 *
 beste Teiler 26.2 (22.) 55.4 (30.) 61.6 (27.)
 Trefferlage 0.49 mm links, 0.38 mm hoch
 Streuwert 0.83, horizontal: 0.97, vertikal: 0.65

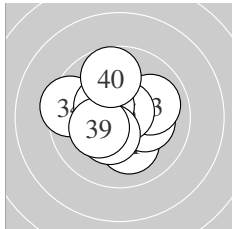

Serie 4:
 10.1 ↓ 10.2 * 10.0 → 9.5 ← 10.7 *
 10.4 * 10.4 * 10.4 * 10.3 * 9.7 ↑
 beste Teiler 53.4 (35.) 130.1 (36.) 141.4 (37.)
 Trefferlage 0.36 mm links, 0.08 mm hoch
 Streuwert 1.58, horizontal: 1.74, vertikal: 1.40

Unterschrift des Schützen

Meyton Elektronik

Ergebnis: **414.2** (396)
 Serien: 104.9 103.8 102.0 103.5
 Zähler: 36 4 0 0 0 0 0 0 0 0
 Innenzehner: 30
 weiteste: 394 (33), 351 (28), 330 (25)
 beste Teiler 4.0 (36.) 32.2 (7.) 38.4 (1.)
 Trefferlage 0.33 mm rechts, 0.07 mm tief
 Streuwert 1.22, horizontal: 1.56, vertikal: 0.74

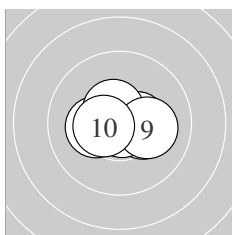
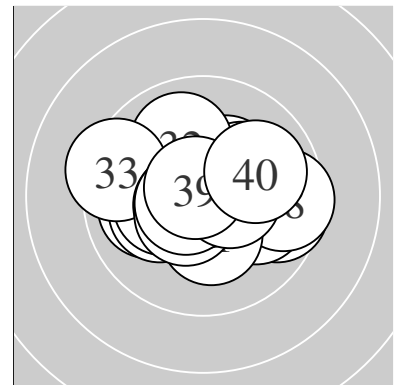

Serie 1:
 10.8 * 10.5 * 10.3 * 10.6 * 10.5 *
 10.3 * 10.8 * 10.5 * 10.1 → 10.5 *
 beste Teiler 32.2 (7.) 38.4 (1.) 89.4 (4.)
 Trefferlage 0.17 mm rechts, 0.02 mm tief
 Streuwert 0.95, horizontal: 1.29, vertikal: 0.40

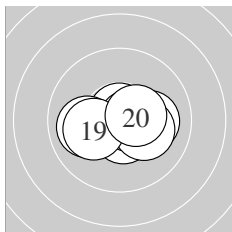

Serie 2:
 10.6 * 10.8 * 10.6 * 10.0 ← 10.1 →
 10.7 * 10.1 → 10.2 * 10.2 * 10.5 *
 beste Teiler 46.0 (12.) 70.1 (16.) 78.4 (11.)
 Trefferlage 0.44 mm rechts, 0.27 mm tief
 Streuwert 1.13, horizontal: 1.54, vertikal: 0.46

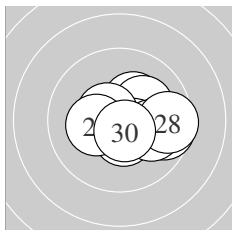

Serie 3:
 10.3 * 10.2 * 10.5 * 10.5 * 9.6 →
 10.0 → 10.5 * 9.5 → 10.3 * 10.6 *
 beste Teiler 87.2 (30.) 101.5 (27.) 115.9 (24.)
 Trefferlage 1.08 mm rechts, 0.17 mm tief
 Streuwert 1.32, horizontal: 1.67, vertikal: 0.82

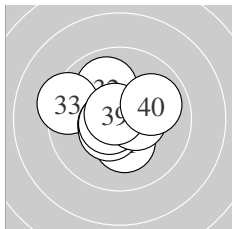

Serie 4:
 10.3 * 10.0 ↖ 9.4 ← 10.6 * 10.5 *
 10.9 * 10.6 * 10.5 * 10.8 * 9.9 →
 beste Teiler 4.0 (36.) 49.5 (39.) 81.9 (37.)
 Trefferlage 0.35 mm links, 0.15 mm hoch
 Streuwert 1.37, horizontal: 1.59, vertikal: 1.12

Unterschrift des Schützen

Meyton Elektronik

Ergebnis: **420.7** (400)
 Serien: 106.0 105.4 104.4 104.9
 Zähler: 40 0 0 0 0 0 0 0 0 0
 Innenzehner: 37
 weiteste: 239 (34), 207 (20), 202 (28)
 beste Teiler 11.0 (9.) 28.0 (25.) 42.0 (27.)
 Trefferlage 0.12 mm rechts, 0.13 mm hoch
 Streuwert 0.87, horizontal: 0.96, vertikal: 0.76

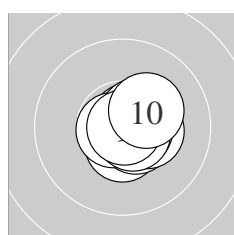
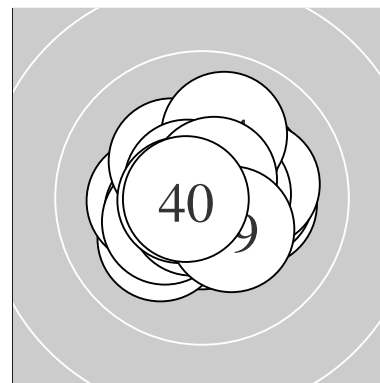

Serie 1:
 10.5 * 10.6 * 10.7 * 10.4 * 10.7 *
 10.7 * 10.5 * 10.7 * 10.9 * 10.3 *
 beste Teiler 11.0 (9.) 53.0 (3.) 55.6 (5.)
 Trefferlage 0.57 mm rechts, 0.04 mm tief
 Streuwert 0.60, horizontal: 0.61, vertikal: 0.59

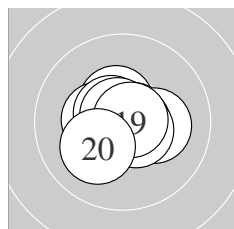

Serie 2:
 10.5 * 10.7 * 10.4 * 10.6 * 10.2 *
 10.7 * 10.8 * 10.6 * 10.8 * 10.1 ↙
 beste Teiler 47.8 (19.) 50.6 (17.) 60.2 (12.)
 Trefferlage 0.00 mm , 0.02 mm hoch
 Streuwert 0.89, horizontal: 1.05, vertikal: 0.68

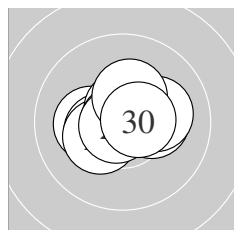

Serie 3:
 10.2 * 10.4 * 10.3 * 10.6 * 10.8 *
 10.3 * 10.8 * 10.1 → 10.3 * 10.6 *
 beste Teiler 28.0 (25.) 42.0 (27.) 79.1 (24.)
 Trefferlage 0.01 mm links, 0.13 mm hoch
 Streuwert 1.03, horizontal: 1.29, vertikal: 0.67

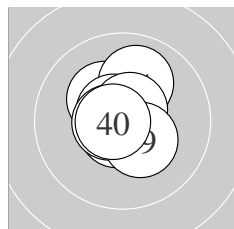

Serie 4:
 10.8 * 10.3 * 10.3 * 10.0 ↗ 10.6 *
 10.7 * 10.6 * 10.6 * 10.3 * 10.7 *
 beste Teiler 43.5 (31.) 58.1 (40.) 63.5 (36.)
 Trefferlage 0.06 mm links, 0.42 mm hoch
 Streuwert 0.91, horizontal: 0.72, vertikal: 1.06

Unterschrift des Schützen

Meyton Elektronik

Ergebnis: **400.3** (382)
 Serien: 98.0 101.7 101.6 99.0
 Zähler: 27 11 0 1 1 0 0 0 0 0
 Innenzehner: 22
 weiteste: 1156 (38), 862 (7), 492 (19)
 beste Teiler 8.6 (18.) 38.0 (5.) 64.7 (15.)
 Trefferlage 0.17 mm rechts, 0.55 mm tief
 Streuwert 2.25, horizontal: 1.91, vertikal: 2.54

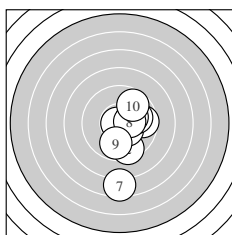
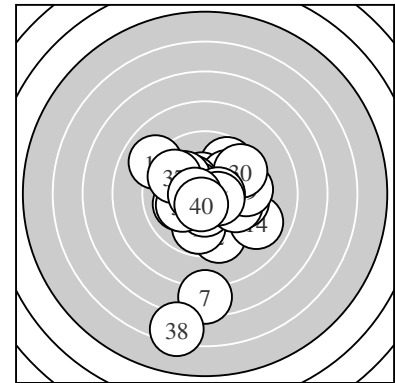

Serie 1:
 9.7 → 9.5 ↓ 10.4 * 10.0 → 10.8 *
 10.2 * 7.5 ↓ 10.4 * 9.8 ↓ 9.7 ↗
 beste Teiler 38.0 (5.) 141.8 (8.) 144.5 (3.)
 Trefferlage 1.19 mm rechts, 1.12 mm tief
 Streuwert 2.40, horizontal: 1.22, vertikal: 3.17

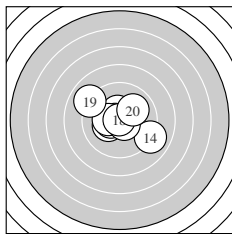

Serie 2:
 10.3 * 10.4 * 10.5 * 9.0 ↘ 10.7 *
 10.3 * 10.6 * 10.9 * 9.0 ↙ 10.0 ↗
 beste Teiler 8.6 (18.) 64.7 (15.) 85.6 (17.)
 Trefferlage 0.27 mm links, 0.16 mm hoch
 Streuwert 1.86, horizontal: 2.25, vertikal: 1.37

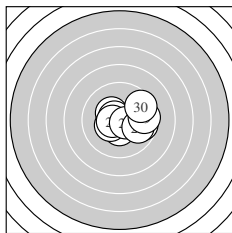

Serie 3:
 10.4 * 10.4 * 10.6 * 9.7 → 10.4 *
 10.5 * 10.6 * 9.9 ↘ 9.6 → 9.5 ↗
 beste Teiler 84.2 (23.) 90.8 (27.) 101.4 (26.)
 Trefferlage 0.87 mm rechts, 0.04 mm tief
 Streuwert 1.55, horizontal: 1.95, vertikal: 0.99

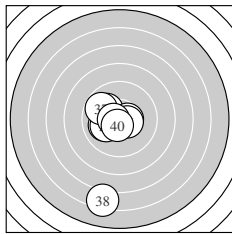

Serie 4:
 10.1 ↖ 10.5 * 10.0 ← 10.5 * 10.1 ←
 10.5 * 9.8 ↖ 6.3 ↓ 10.6 * 10.6 *
 beste Teiler 86.1 (39.) 93.6 (40.) 109.0 (32.)
 Trefferlage 1.08 mm links, 1.19 mm tief
 Streuwert 2.75, horizontal: 1.33, vertikal: 3.66

Unterschrift des Schützen

Meyton Elektronik